



LCD TV | PLASMA TV OWNER'S MANUAL

LCD TV MODELS

32LG55**
37LG55**
42LG55**
47LG55**
52LG55**
42LG75**

PLASMA TV MODELS

42PG35**
50PG35**
42PG65**
50PG65**
50PG45**
50PG75**

Please read this manual carefully before operating your TV.

Retain it for future reference.

Record model number and serial number of the TV. Refer to the label on the back cover and quote this information.

To your dealer when requiring service.



Digital Video
Broadcasting

Trade Mark of the DVB Digital Video
Broadcasting Project (1991 to 1996)

ID Number(s): 5095: 32LG5500 5093: 42PG6500
5096: 37LG5500 5094: 50PG6500
5097: 42LG5500 5526: 50PG4500
5442: 47LG5500 5527: 50PG7500
5443: 52LG5500 5093: 42PG3500
5097: 42LG7500 5093: 50PG3500



“ This product incorporates copy protection technology that is protected by U.S. and foreign patents, including patent numbers 5,315,448 and 6,836,549, and other intellectual property rights. The use of Macrovision’s copy protection technology in the product must be authorized by Macrovision. Reverse engineering or disassembly is prohibited. ”

ACCESSORIES

Ensure that the following accessories are included with your TV. If an accessory is missing, please contact the dealer where you purchased the TV.

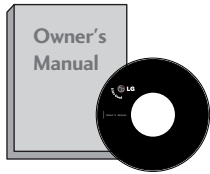

Owner's Manual

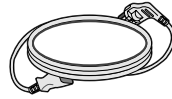

Power Cord

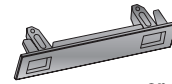

or



Protection Cover

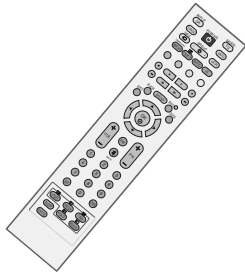

Remote Control



Batteries



Polishing Cloth

Polishing cloth for use on the screen.

Lightly wipe any stains or fingerprints on the surface of the TV with the polishing cloth.

Do not use excessive force. This may cause scratching or discolouration.

PLASMA TV models

(50PG65**,
50PG75**only)

(42/50PG35**,
50PG45** only)



Cable management clip

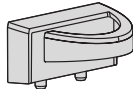

Cable Holder
(42PG35**/42PG65**: 1 EA,
50PG35**/50PG45**: 2EA)



Ferrite Core
(50PG45**, 50PG75**
only)

LCD TV models

(32LG55** only)



1-screw for stand fixing
(Refer to p.5)



x 4



x 4

Bolts for stand assembly
(Refer to p.8)

Use of ferrite core (50PG45**, 50PG75** only)

Ferrite core can be used to reduce the electromagnetic wave when connecting the power cord.
The closer the location of the ferrite core to the power plug, the better it is.

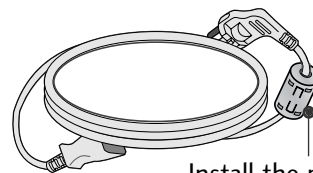

Install the power plug closely.

CONTENTS

ACCESSORIES 1

PREPARATION

Front Panel Controls	4
Back Panel Information	6
Stand Installation	8
Please set it up carefully so the product does not fall over	9
Back Cover for Wire Arrangement	10
Desktop Pedestal Installation	12
Wall Mount: Horizontal installation	12
Antenna Connection	13

EXTERNAL EQUIPMENT SETUP

HD Receiver Setup	14
DVD Setup	16
VCR Setup	19
Digital Audio Out Setup	22
Insertion of CI module	22
Other A/V Source Setup	23
PC Setup	24
- Screen Setup for PC Mode	27

WATCHING TV / PROGRAMME CONTROL

Remote Control Key Functions	31
Turning on the TV	33
Programme Selection	34
Volume Adjustment	34
On-Screen Menus Selection and Adjustment	35
Auto Programme Tuning (In Digital Mode)	36
Manual Programme Tuning (In Digital Mode)	37
Programme Edit (In Digital Mode)	38
Booster (In Digital Mode only)	40
Software Update (In Digital Mode only)	41
Diagnostics (In Digital Mode only)	42
CI Information (In Digital Mode only)	43
Auto Programme Tuning (In Analogue Mode)	44
Manual Programme Tuning (In Analogue Mode)	45

Fine Tuning (In Analogue Mode)	46
Assigning a Station Name (In Analogue Mode)	46
Programme Edit (In Analogue Mode)	47
Selecting the Programme Table	49
Input Source Selection	50
SIMPLINK Function	51

EPG (ELECTRONIC PROGRAMME GUIDE) (IN DIGITAL MODE)

Switch on/off EPG	53
Select programme	53
Button function in NOW/NEXT guide mode	54
Button Function in 8 Day Guide Mode	54
Button function in date change mode	54
Button function in extended description box	55
Button function in record/remind setting mode	55
Button function in timer list mode	55

PICTURE CONTROL

Picture Size (Aspect Ratio) Control	56
Preset Picture Settings	
- Picture Mode-Preset	58
- Auto Colour Tone Control (Warm/Medium/Cool)	59
Manual Picture Adjustment	
- Picture Mode-User option	60
- Colour Tone - User option	61
XD - Picture Improvement Technology	62
XD Demo	63
Advanced - Cinema	64
Advanced - Black(Darkness) Level	64
Advanced - Trumotion	65
Picture Reset	66
TruMotion Demo	66
Image Sticking Minimization(ISM) Method	67
Low-Power Picture Mode	68

SOUND & LANGUAGE CONTROL

Auto Volume Leveler	69
Preset Sound Settings - Sound Mode	70
Sound Setting Adjustment - User Mode	71
Balance	72
TV Speakers On/Off Setup	73
Selecting Digital Audio	74
I/II	
- Stereo/Dual Reception (In Analogue Mode Only)	75
- NICAM Reception (In Analogue Mode Only)	76
- Speaker Sound Output Selection	76
On-Screen Menu Language	77
Language selection (In Digital Mode only)	78

TIME SETTING

Clock Setup	79
Auto On/Off Timer Setting	80
Auto Shut-off Setting	81
Time Zone Setup	82
Sleep Timer Setting	82

PARENTAL CONTROL / RATINGS

Set Password & Lock System	83
Parental Control	84

TELETEXT

Switch on/off	85
SIMPLE Text	85
TOP Text	85
FASTEXT	86
Special Teletext Functions	86

APPENDIX

Troubleshooting	87
Maintenance	89
Product Specifications	90
Programming the Remote Control	92
IR Codes	94
External Control Device Setup	96

PREPARATION

FRONT PANEL CONTROLS

- Image shown may differ from your TV.
- If your TV has a protection film attached, remove the film and then wipe the TV with a polishing cloth.

PLASMA TV Models

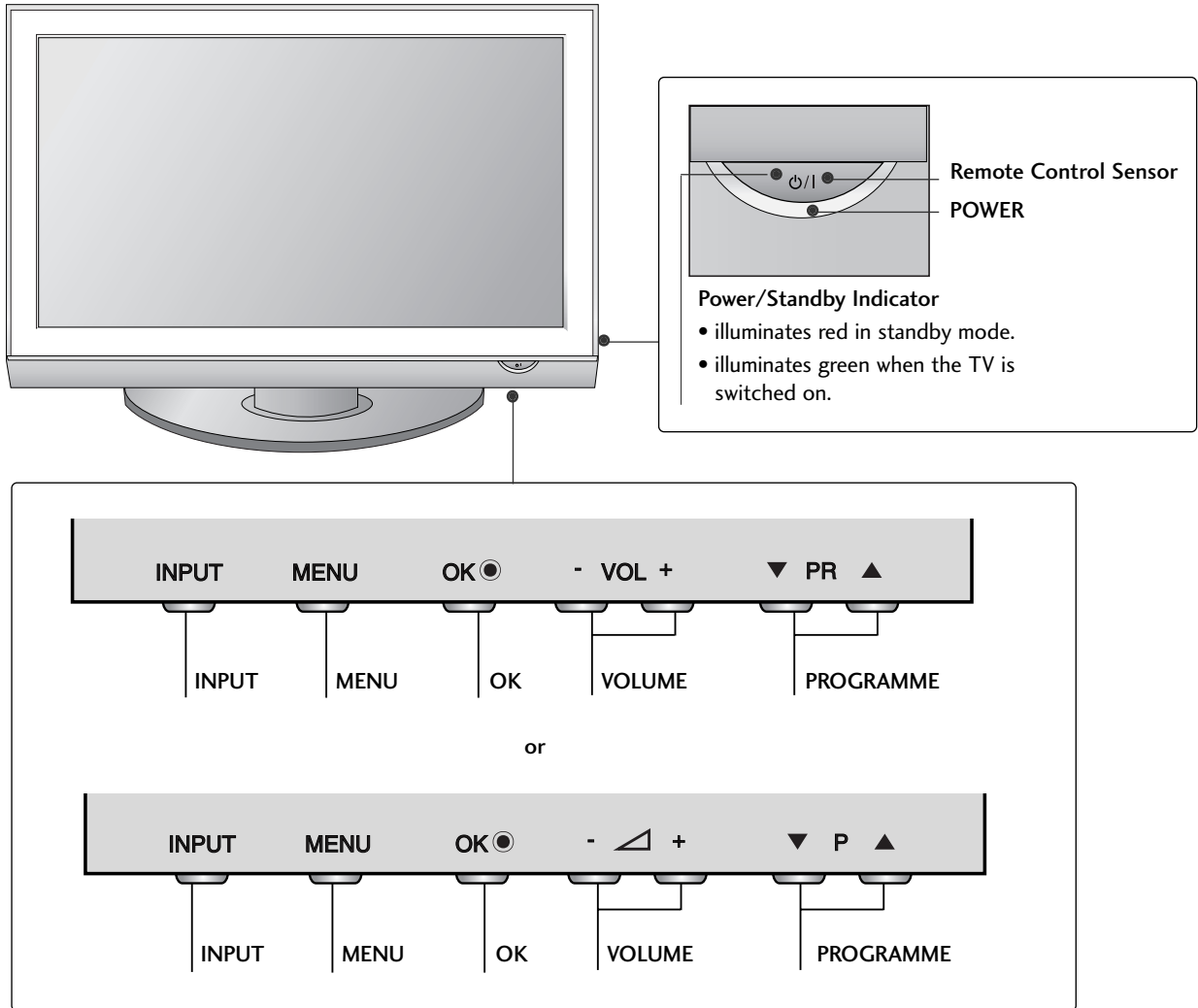

LCD TV Models

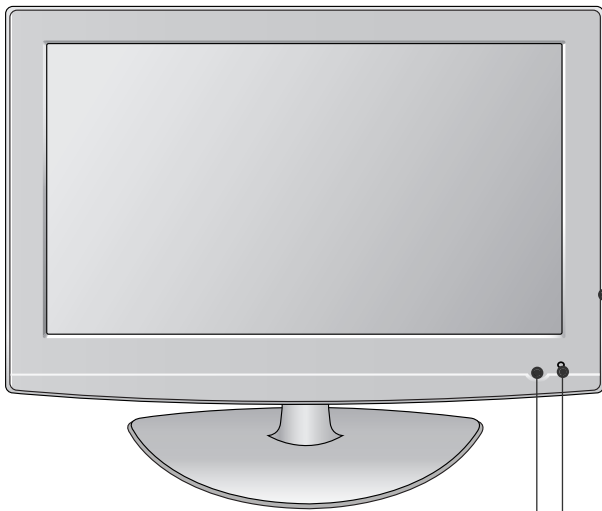

POWER

Remote Control Sensor

Power/Standby Indicator

- illuminates red in standby mode.
 - illuminates blue when the TV is switched on.
- Note: You can adjust **Power Indicator** in the **OPTION** menu.

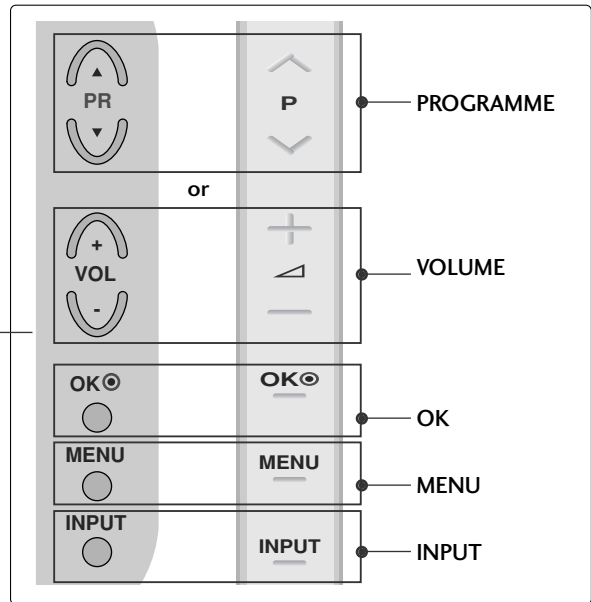

Intelligent Sensor

Adjusts picture according to the surrounding conditions.

Attaching the TV to a desk (Only 32LG55**)

The TV must be attached to desk so it cannot be pulled in a forward/backward direction, potentially causing injury or damaging the product. Use only an attached screw.

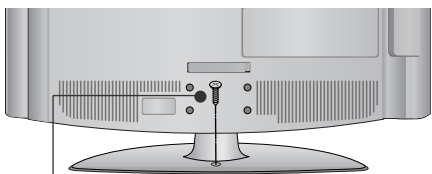

1-Screw
(provided as parts of the product)

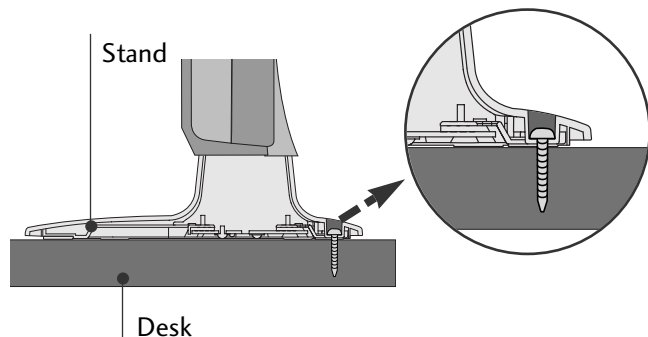

! WARNING

- ▶ To prevent TV from falling over, the TV should be securely attached to the floor/wall per installation instructions. Tipping, shaking, or rocking the machine may cause injury.

PREPARATION

BACK PANEL INFORMATION

- Image shown may differ from your TV.

PLASMA TV Models

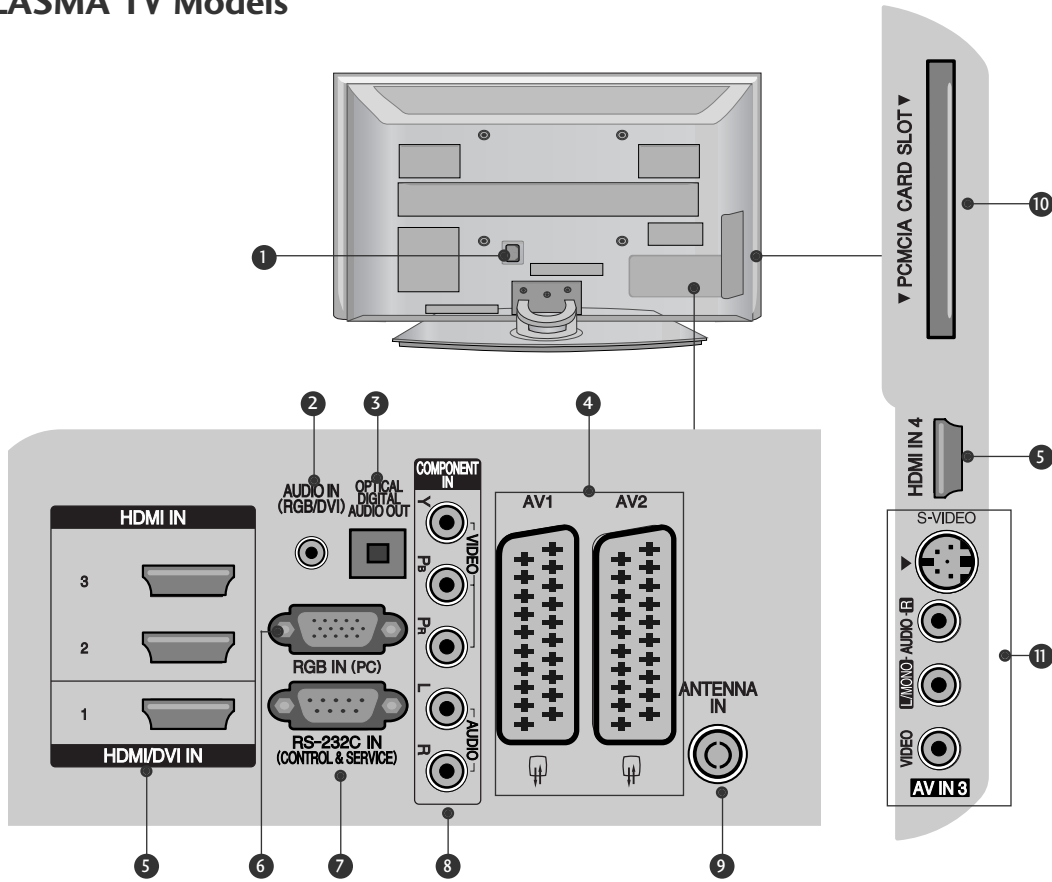

- 1 Power Cord Socket**
This TV operates on an AC power. The voltage is indicated on the Specifications page. Never attempt to operate the TV on DC power.
- 2 AUDIO IN (RGB/DVI)**
Connect the audio from a PC.
- 3 OPTICAL DIGITAL AUDIO OUT**
Connect digital audio from various types of equipment.
Note: In standby mode, these ports do not work.
- 4 Euro Scart Socket (AV1/AV2)**
Connect scart socket input or output from an external device to these jacks.
- 5 HDMI IN 1/2/3/4**
Connect a HDMI signal to HDMI IN. Or DVI (VIDEO) signal to HDMI/DVI port with DVI to HDMI cable.
- 6 RGB IN (PC)**
Connect the output from a PC.
- 7 RS-232C IN (CONTROL & SERVICE) PORT**
Connect to the RS-232C port on a PC.
- 8 Component Input**
Connect a component video/audio device to these jacks.
- 9 Antenna Input**
Connect RF antenna to this jack.
- 10 PCMCIA (Personal Computer Memory Card International Association) Card Slot**
- 11 AV (Audio/Video) IN 3**
Connect audio/video output from an external device to these jacks.
S-VIDEO
Connect S-Video out from an S-VIDEO device.

LCD TV Models

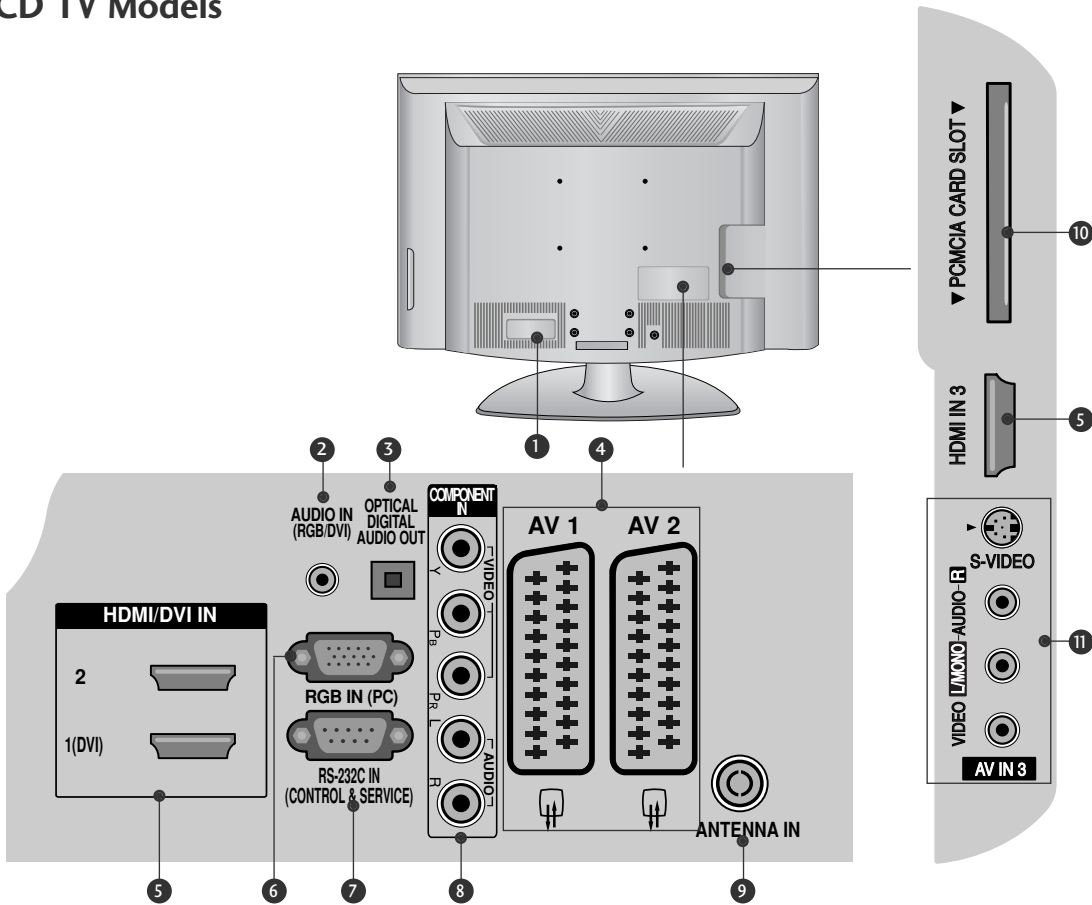

- 1 Power Cord Socket**
This TV operates on an AC power. The voltage is indicated on the Specifications page. Never attempt to operate the TV on DC power.
- 2 AUDIO IN (RGB/DVI)**
Connect the audio from a PC.
- 3 OPTICAL DIGITAL AUDIO OUT**
Connect digital audio from various types of equipment.
Note: In standby mode, these ports do not work.
- 4 Euro Scart Socket (AV1/AV2)**
Connect scart socket input or output from an external device to these jacks.
- 5 HDMI IN 1/2/3**
Connect a HDMI signal to HDMI IN. Or DVI (VIDEO) signal to HDMI/DVI port with DVI to HDMI cable.
- 6 RGB IN (PC)**
Connect the output from a PC.
- 7 RS-232C IN (CONTROL & SERVICE) PORT**
Connect to the RS-232C port on a PC.
- 8 Component Input**
Connect a component video/audio device to these jacks.
- 9 Antenna Input**
Connect RF antenna to this jack.
- 10 PCMCIA (Personal Computer Memory Card International Association) Card Slot**
- 11 AV (Audio/Video) IN 3**
S-VIDEO
Connect S-Video out from an S-VIDEO device.

PREPARATION

STAND INSTALLATION (Only 32/37/42LG55**, 42LG75**)

- When assembling the desk type stand, check whether the bolt is fully tightened. (If not tightened fully, the product can tilt forward after the product installation.) If you tighten the bolt with excessive force, the bolt can deviate from abrasion of the tightening part of the bolt.

- 1** Carefully place the TV screen side down on a cushioned surface to protect the screen from damage.

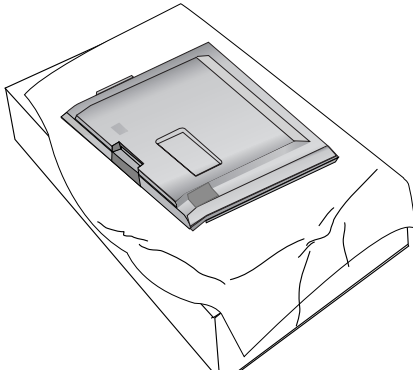

- 3** Assemble the TV as shown.

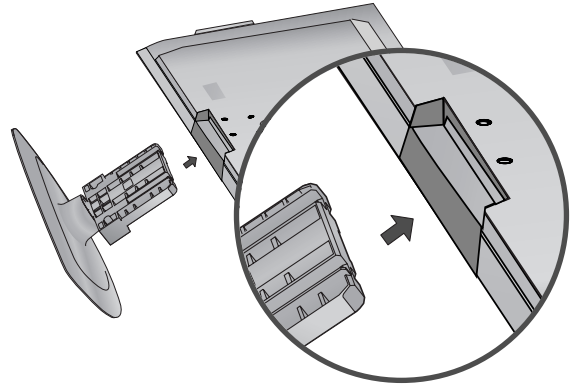

- 2** Assemble the parts of the **stand body** with **cover base** of the TV.

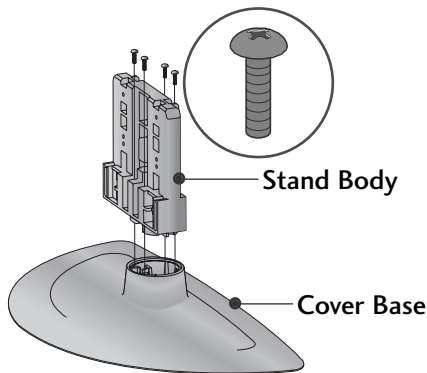

- 4** Fix the 4 bolts securely using the holes in the back of the TV.

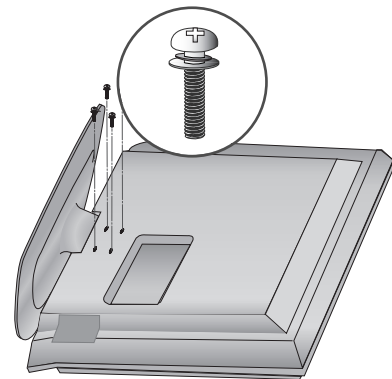

Swivel Stand

After installing the TV, you can adjust the TV set manually to the left or right direction by 20 degrees to suit your viewing position.

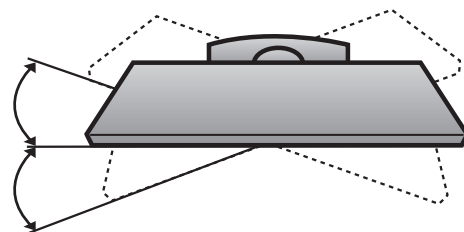

PLEASE SET IT UP CAREFULLY SO THE PRODUCT DOES NOT FALL OVER.

- You should purchase necessary components to fix the TV to the wall on the market.
- Position the TV close to the wall to avoid the possibility of it falling when pushed.
- The instructions shown below are a safer way to set up the TV, which is to fix it to the wall, avoiding the possibility of it falling forwards if pulled. This will prevent the TV from falling forward and causing injury. This will also prevent the TV from damage. Ensure that children do not climb or hang from the TV.

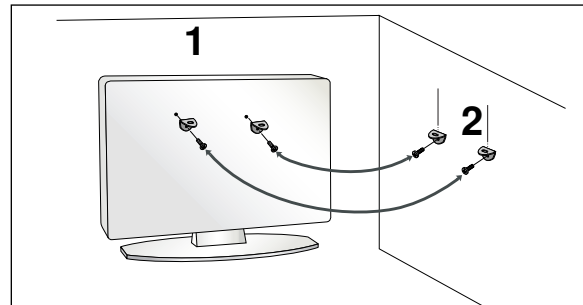
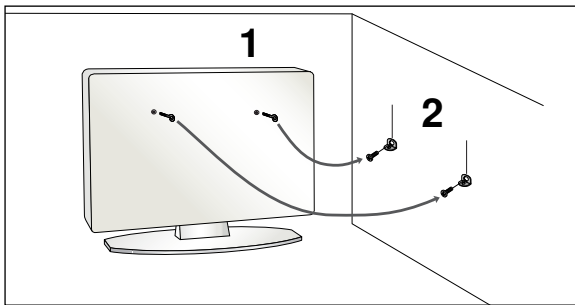

- 1 Use the eye-bolts or TV brackets/bolts to fix the TV to the wall as shown in the picture.
(If your TV has bolts in the eyebolts, loosen these bolts.)
* Insert the eye-bolts or TV brackets/bolts and tighten them securely in the upper holes.
- 2 Secure the wall brackets with the bolts on the wall. Match the height of the bracket that is mounted on the wall.

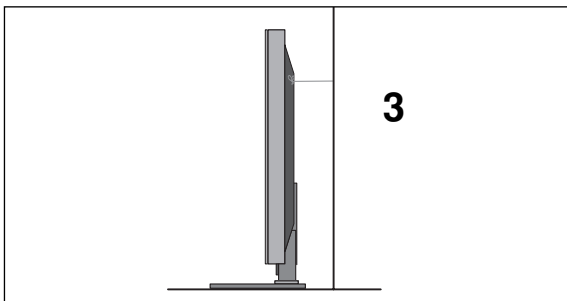

- 3 Use a sturdy rope to tie the TV. It is safer to tie the rope so it becomes horizontal between the wall and the TV.

! NOTE

- ▶ When moving the TV undo the cords first.
- ▶ Use a platform or cabinet strong and large enough to support the size and weight of the TV.
- ▶ To use the TV safely make sure that the height of the bracket on the wall and on the TV is the same.

PREPARATION

BACK COVER FOR WIRE ARRANGEMENT

▪ Image shown may differ from your TV.

Plasma TV models

42/50PG35**, 42PG65**, 50PG45**

1 Connect the cables as necessary.

To connect additional equipment, see the **External equipment Setup** section.

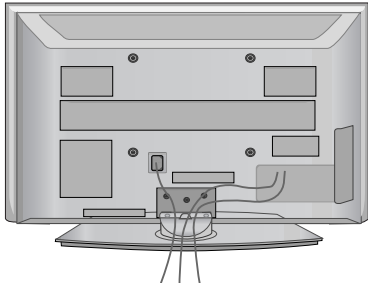

2 Install the **CABLE MANAGEMENT CLIP** as shown.

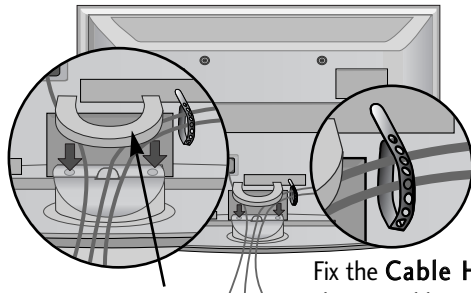

CABLE MANAGEMENT CLIP

Fix the **Cable Holder** as shown and bundle the cables.

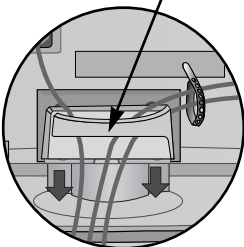

42/50PG35**, 50PG45**

50PG65**, 50PG75**

1 Connect the cables as necessary.

To connect additional equipment, see the **External equipment Setup** section.

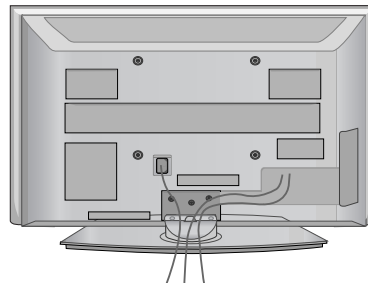

2 Install the **CABLE MANAGEMENT CLIP** as shown.

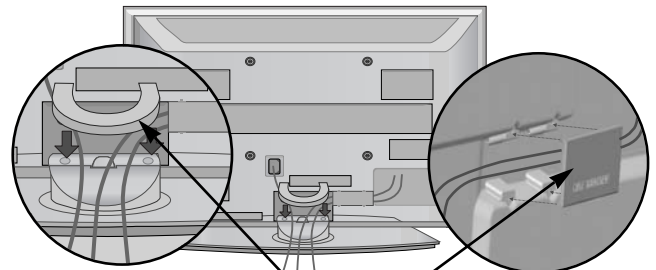

CABLE MANAGEMENT CLIP

How to remove the cable management clip

Hold the **CABLE MANAGEMENT CLIP** with both hands and pull it upward.

For the 42PG65** model, press the center of the **CABLE MANAGEMENT CLIP** and then lift up it.

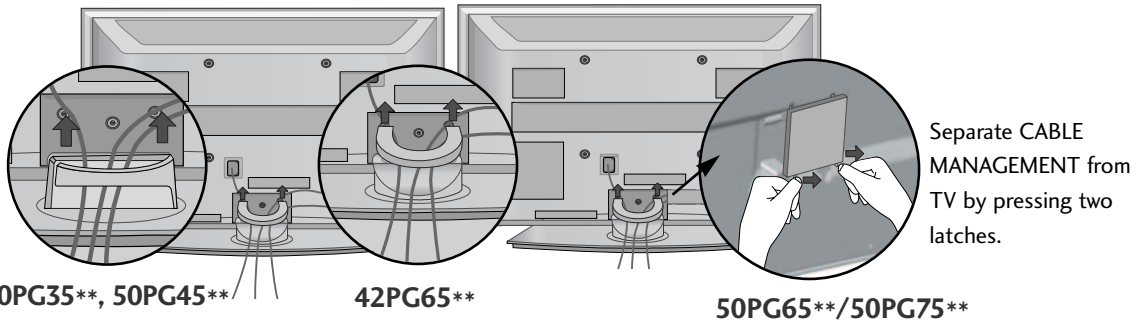

LCD TV models

- 1 Connect the cables as necessary.

To connect additional equipment, see the **External Equipment Setup** section of the manual.

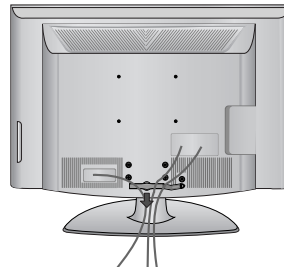

- 2 Open the **CABLE MANAGEMENT CLIP** as shown and manage the cables.

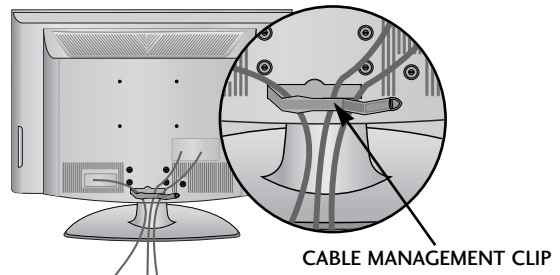

- 3 Fit the **CABLE MANAGEMENT CLIP** as shown.

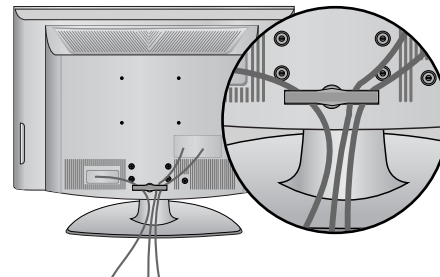

! NOTE

- ▶ Do not use the **CABLE MANAGEMENT CLIP** to lift the TV.
- If the TV is dropped, you may be injured or the TV may be damaged.

PREPARATION

- The TV can be installed in various ways such as on a wall or on a desktop etc.
- The TV is designed to be mounted horizontally.

EARTHING

Ensure that you connect the earth wire to prevent possible electric shock. Do not try to earth the TV by connecting it to telephone wires, lightning rods or gas pipes.

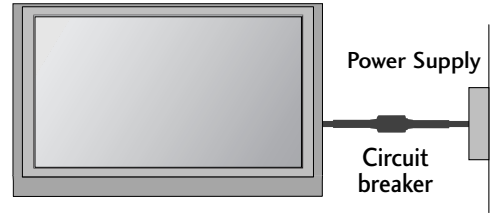

DESKTOP PEDESTAL INSTALLATION

For adequate ventilation allow a clearance of 4" (10cm) all around the TV.

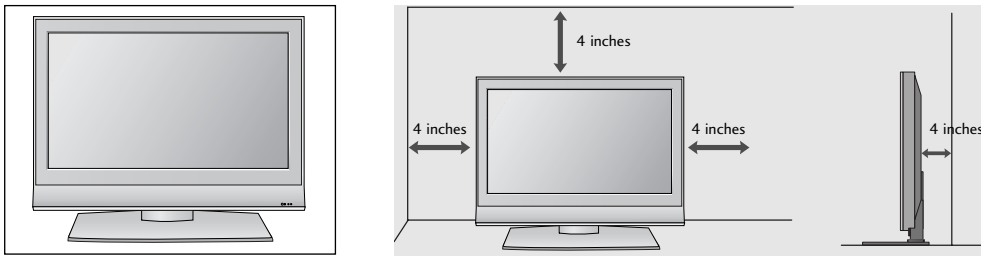

WALL MOUNT: HORIZONTAL INSTALLATION

For adequate ventilation allow a clearance of 4" (10cm) all around the TV. We recommend that you use a wall mounting bracket of LG brand when mounting the TV to a wall.

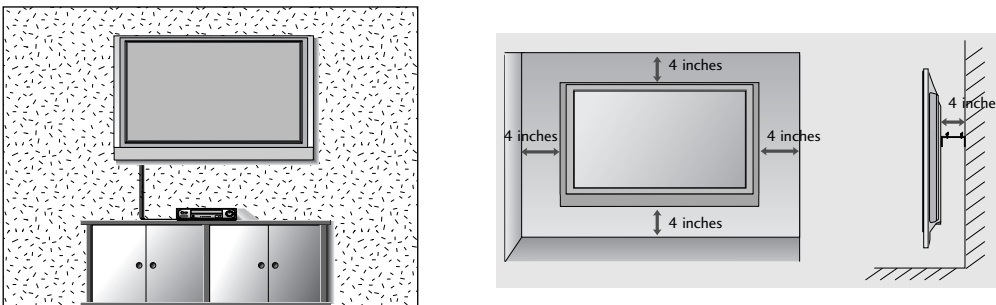

Not using the desk-type stand

- Image shown may differ from your TV.

When installing the wall-mounted unit, use the protection cover for desk-type stand installation. Insert the **PROTECTION COVER** into the TV until clicking sound.

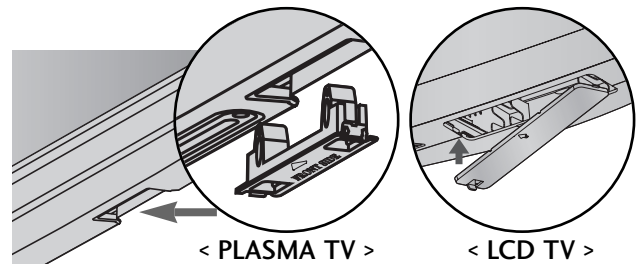

- To prevent damage do not connect to the mains outlet until all connections are made between the devices.

ANTENNA CONNECTION

- For optimum picture quality, adjust antenna direction.
- An antenna cable and converter are not supplied.

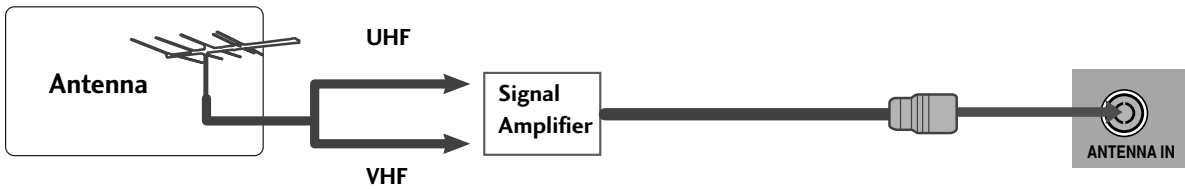
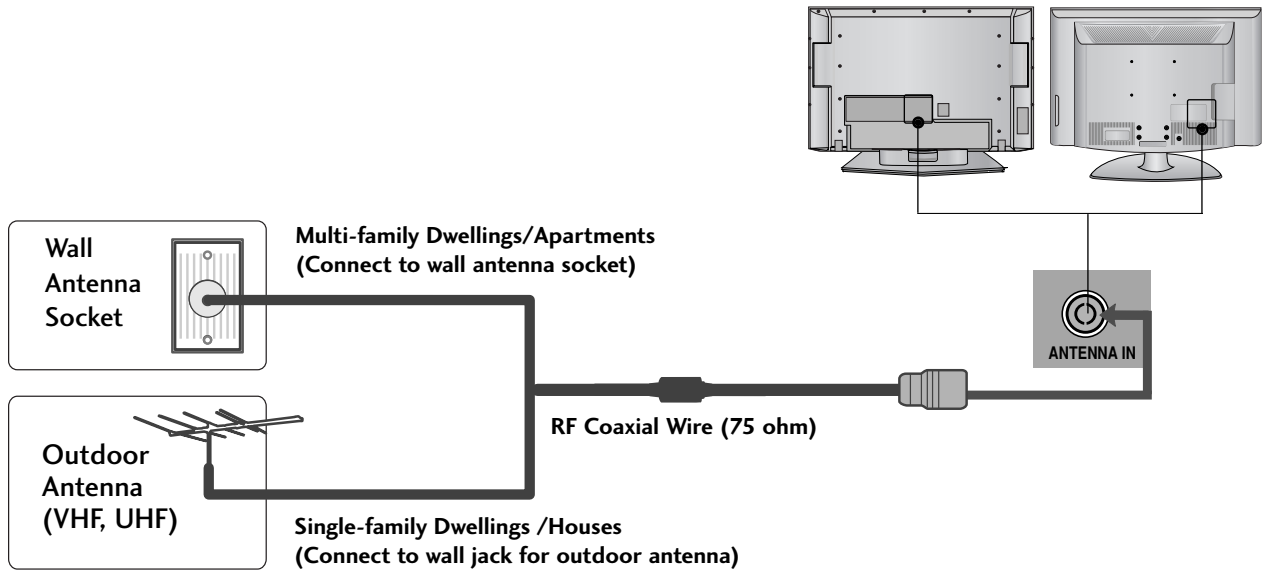

- In poor signal areas, to achieve better picture quality it may be necessary to install a signal amplifier to the antenna as shown above.
- If signal needs to be split for two TVs, use an antenna signal splitter for connection.

EXTERNAL EQUIPMENT SETUP

- To avoid damaging any equipment, never plug in any power cords until you have finished connecting all equipment.
- This section on EXTERNAL EQUIPMENT SETUP mainly uses diagrams for the LCD TV models.

HD RECEIVER SETUP

- This TV can receive Digital RF/Cable signals without an external digital set-top box. However, if you do receive Digital signals from a digital set-top box or other digital external device, refer to the diagram as shown below.

Connecting with a component cable

- 1 Connect the video outputs (Y, PB, PR) of the digital set top box to the **COMPONENT IN VIDEO** jacks on the TV.
- 2 Connect the audio output of the digital set-top box to the **COMPONENT IN AUDIO** jacks on the TV.
- 3 Turn on the digital set-top box.
(Refer to the owner's manual for the digital set-top box.)
- 4 Select **COMPONENT** input source using the **INPUT** button on the remote control.

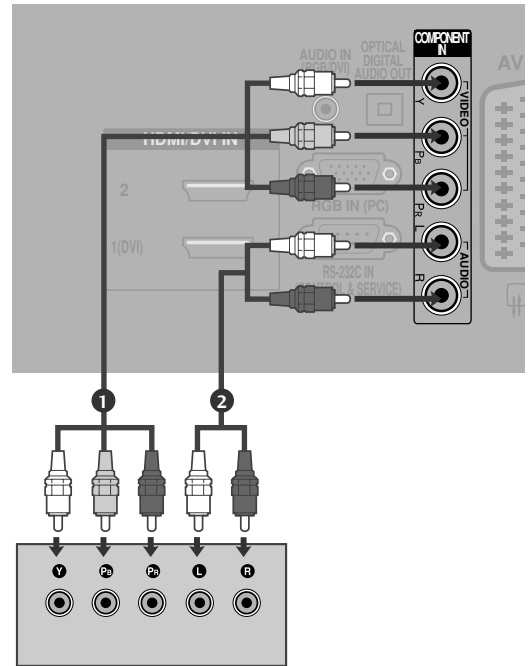

Signal	Component	HDMI1/2/3/4 (HDMI4 : only PLASMA TV Models)
480i/576i	Yes	No
480p/576p	Yes	Yes
720p/1080i	Yes	Yes
1080p	Yes (Only 37/42/47/52LG55**, 50PG45**, 50PG75**)	Yes

Connecting a set-top box with an HDMI cable

- 1 Connect the digital set-top box to **HDMI IN 2** jack on the TV.
- 2 Turn on the digital set-top box.
(Refer to the owner's manual for the digital set-top box.)
- 3 Select **HDMI2** input source using the **INPUT** button on the remote control.
If connected to **HDMI IN 3** (or **HDMI IN 4**) jack, select **HDMI3** (or **HDMI4**) input source.

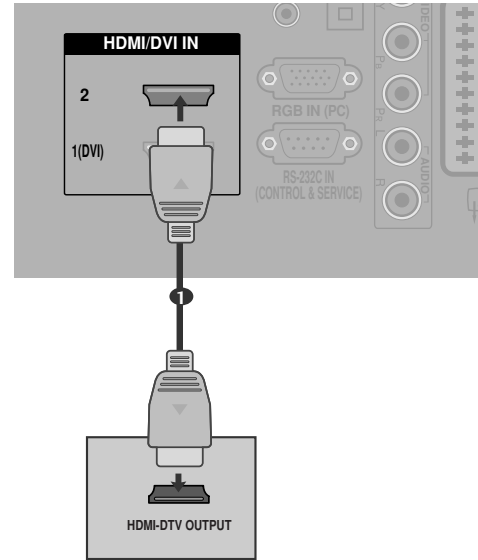

Connecting with a HDMI to DVI cable

- 1 Connect the digital set-top box to **HDMI/DVI IN 1 (DVI)** jack on the TV.
- 2 Connect the audio output of the digital set-top box to the **AUDIO IN (RGB/DVI)** jack on the TV.
- 3 Turn on the digital set-top box. (Refer to the owner's manual for the digital set-top box.)
- 4 Select **HDMI1** input source using the **INPUT** button on the remote control.

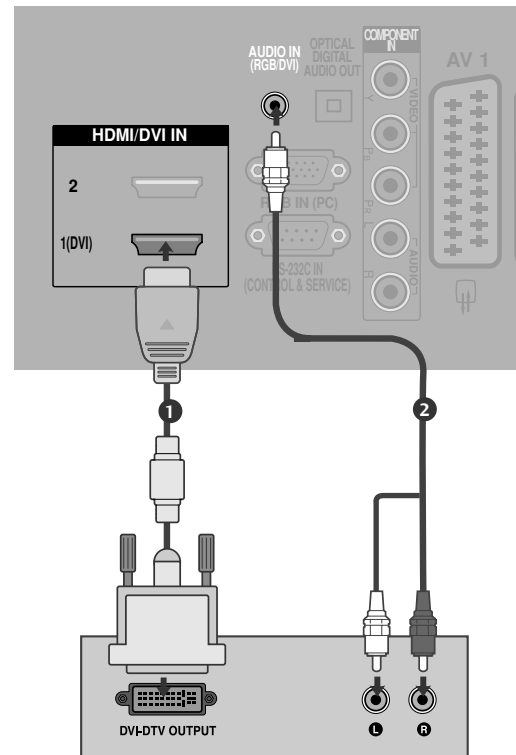

EXTERNAL EQUIPMENT SETUP

DVD SETUP

Connecting with a component cable

- 1 Connect the video outputs (Y, PB, PR) of the DVD to the **COMPONENT IN VIDEO** jacks on the TV.
- 2 Connect the audio outputs of the DVD to the **COMPONENT IN AUDIO** jacks on the TV.
- 3 Turn on the DVD player, insert a DVD.
- 4 Select **COMPONENT** input source using the **INPUT** button on the remote control.
- 5 Refer to the DVD player's manual for operating instructions.

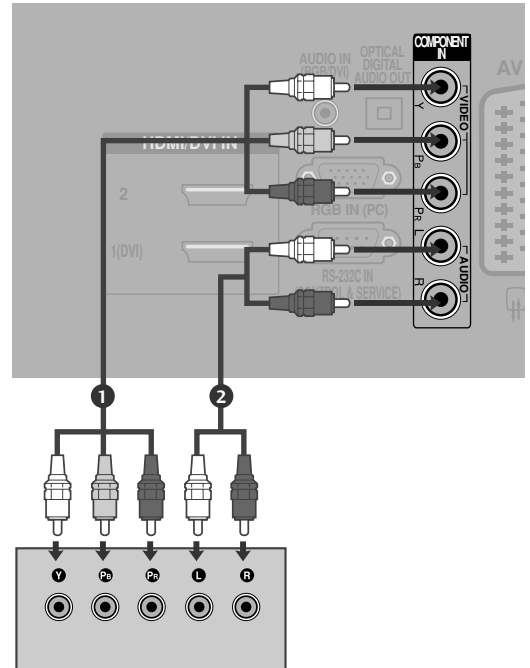

Component Input ports

To achieve better picture quality, connect a DVD player to the component input ports as shown below.

Component ports on the TV	Y	P _B	P _R
Video output ports on DVD player	Y	P _B	P _R
	Y	B-Y	R-Y
	Y	C _b	C _r
	Y	P _b	P _r

Connecting with a Euro scart

- 1 Connect the Euro scart socket of the DVD to the **AV1** Euro scart socket on the TV.
- 2 Turn on the DVD player, insert a DVD.
- 3 Select **AV1** input source using the **INPUT** button on the remote control.
If connected to **AV2** Euro scart socket, select **AV2** input source.
- 4 Refer to the DVD player's manual for operating instructions.

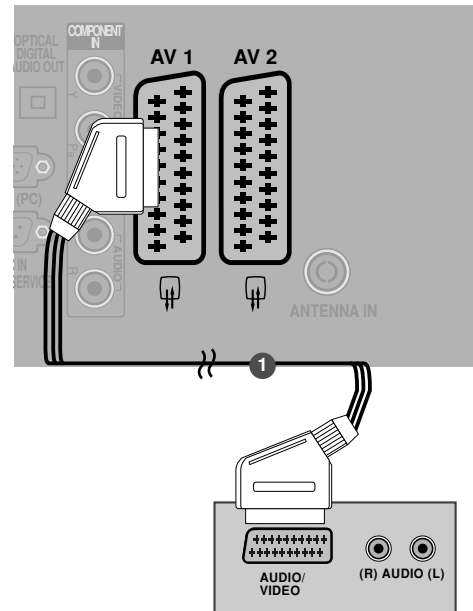

! NOTE

- ▶ If you want to use the EURO scart cable, you have to use the signal shielded Euro scart cable.

Connecting with a S-Video cable

- 1 Connect the S-VIDEO output of the DVD to the **S-VIDEO** input on the TV.
- 2 Connect the audio outputs of the DVD to the **AUDIO** input jacks on the TV.
- 3 Turn on the DVD player, insert a DVD.
- 4 Select **AV3** input source using the **INPUT** button on the remote control.
- 5 Refer to the DVD player's manual for operating instructions.

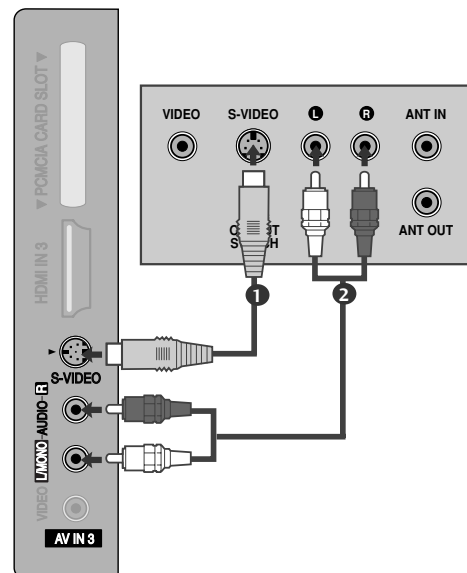

EXTERNAL EQUIPMENT SETUP

Connecting HDMI cable

- 1 Connect the HDMI output of the DVD to the **HDMI IN 2** jack on the set.
- 2 Select **HDMI2** input source using the **INPUT** button on the remote control.
If connected to **HDMI IN 3** (or **HDMI IN 4**) jack, select **HDMI3** (or **HDMI4**) input source.
- 3 Refer to the DVD player's manual for operating instructions.

NOTE

- ▶ The TV can receive video and audio signals simultaneously when using a HDMI cable.
- ▶ If the DVD does not support Auto HDMI, you must set the output resolution appropriately.

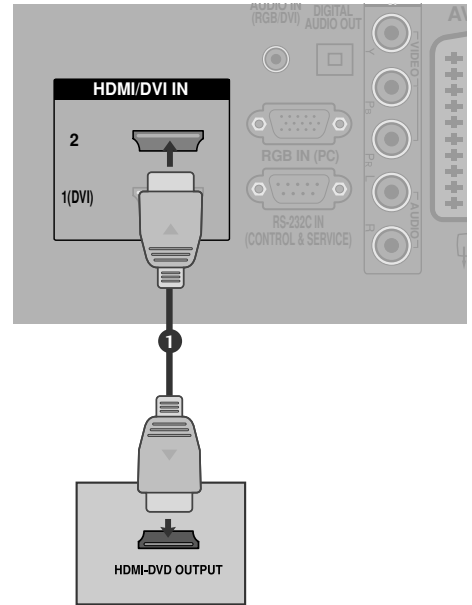

VCR SETUP

- To avoid picture noise (interference), allow adequate distance between the VCR and TV.
- If 4:3 picture format is used for an extended period the fixed images on the sides of the screen may remain visible.

When connecting with a RF Cable

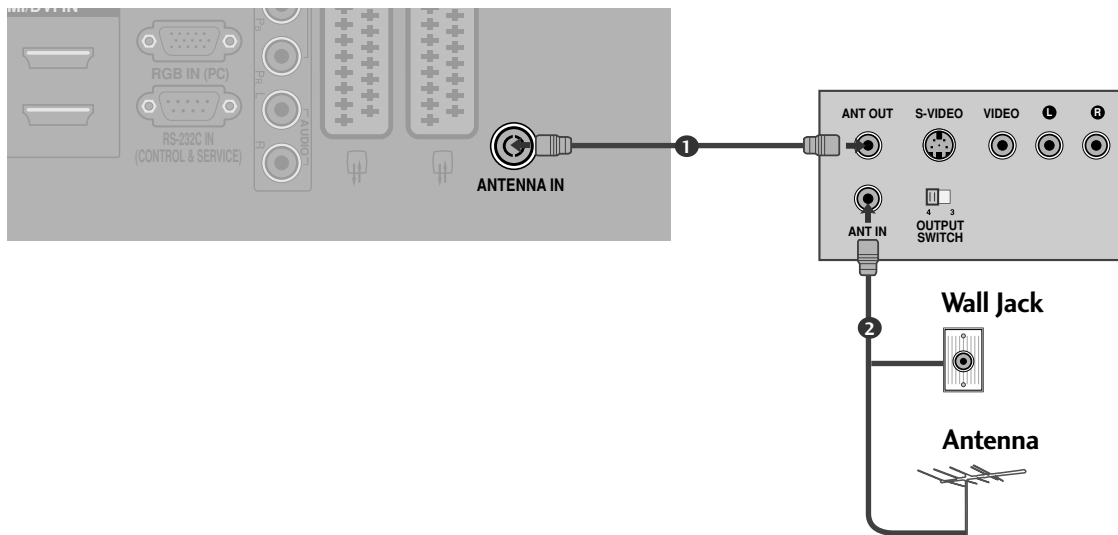

- 1 Connect the **ANT OUT** socket of the VCR to the **ANTENNA IN** socket on the TV.
- 2 Connect the antenna cable to the **ANT IN** socket of the VCR.
- 3 Press the **PLAY** button on the VCR and match the appropriate channel between the TV and VCR for viewing.

EXTERNAL EQUIPMENT SETUP

Connecting with a Euro scart

- 1 Connect the Euro scart socket of the VCR to the **AV1** Euro scart socket on the TV.
- 2 Insert a video tape into the VCR and press **PLAY** on the VCR. (Refer to the VCR owner's manual.)
- 3 Select **AV1** input source using the **INPUT** button on the remote control.
If connected to **AV2** Euro scart socket, select **AV2** input source.

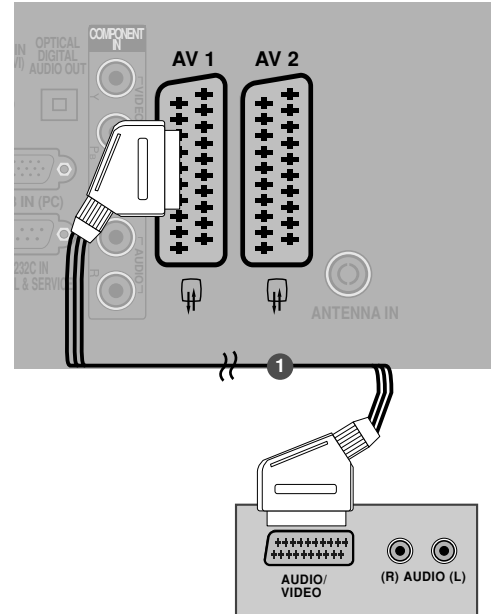

! NOTE

- ▶ If you want to use the EURO scart cable, you have to use the signal shielded Euro scart cable.

Connecting with a RCA cable

- 1 Connect the **AUDIO/VIDEO** jacks between TV and VCR. Match the jack colours (Video = yellow, Audio Left = white, and Audio Right = red)
- 2 Insert a video tape into the VCR and press **PLAY** on the VCR. (Refer to the VCR owner's manual.)
- 3 Select **AV3** input source using the **INPUT** button on the remote control.

! NOTE

- ▶ If you have a mono VCR, connect the audio cable from the VCR to the **AUDIO L/MONO** jack of the TV.

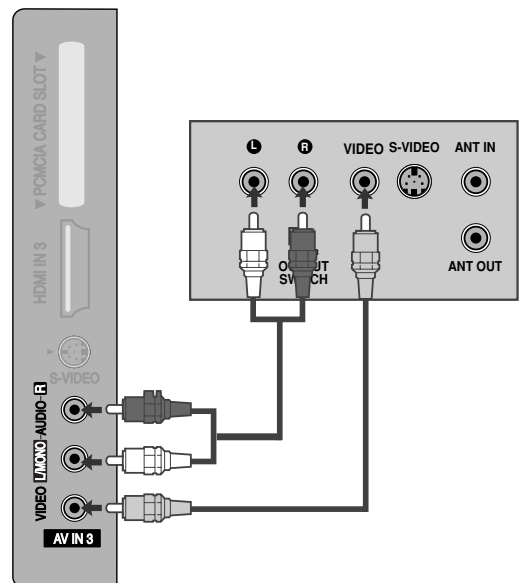

Connecting with a S-Video cable

- 1 Connect the S-VIDEO output of the VCR to the S - VIDEO input on the TV. The picture quality is improved; compared to normal composite (RCA cable) input.
- 2 Connect the audio outputs of the VCR to the AUDIO input jacks on the TV.
- 3 Insert a video tape into the VCR and press PLAY on the VCR. (Refer to the VCR owner's manual.)
- 4 Select **AV3** input source using the **INPUT** button on the remote control.

! NOTE

- ▶ If both S-VIDEO and VIDEO sockets have been connected to the S-VHS VCR simultaneously, only the S-VIDEO can be received.

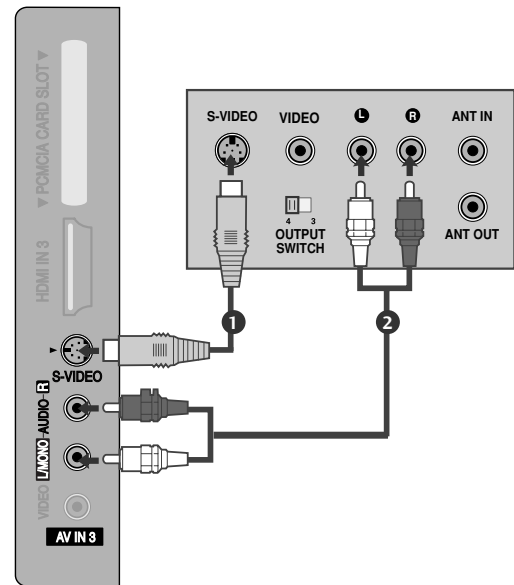

EXTERNAL EQUIPMENT SETUP

DIGITAL AUDIO OUT SETUP

- Sending the TV's audio signal to external audio equipment via the Digital Audio Output (Optical) port.

- 1 Connect one end of an optical cable to the TV Digital Audio (Optical) Output port.
- 2 Connect the other end of the optical cable to the digital audio (optical) input on the audio equipment.
- 3 Set the "TV Speaker option - Off" in the AUDIO menu. (▶ p.73). Refer to the external audio equipment instruction manual for operation.

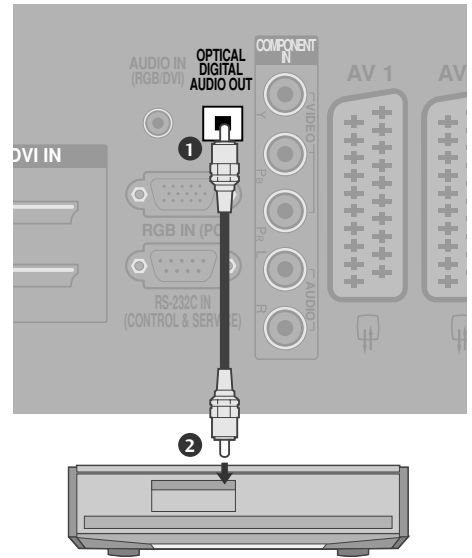

⚠ CAUTION

- ▶ Do not look into the optical output port. Looking at the laser beam may damage your vision.

INSERTION OF CI MODULE

- To view the encrypted (pay) services in digital TV mode.

- 1 Insert the CI Module to **PCMCIA** (Personal Computer Memory Card International Association) **CARD SLOT** of TV as shown.

For further information, see p.43.

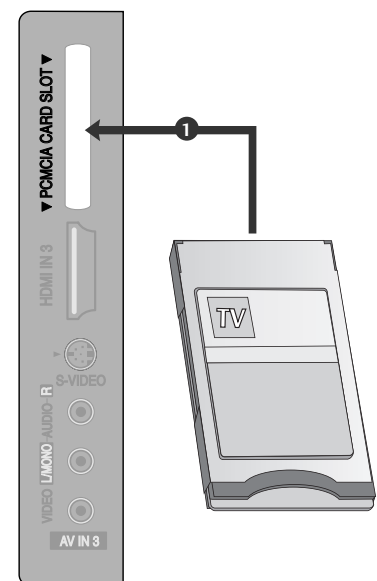

OTHER A/V SOURCE SETUP

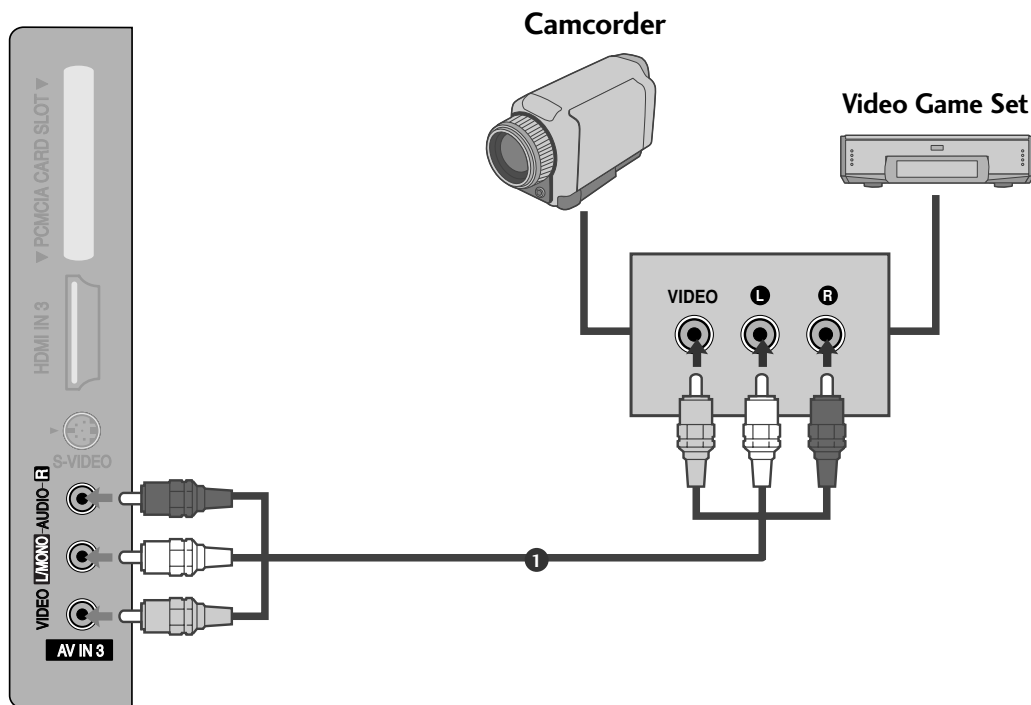

- 1 Connect the **AUDIO/VIDEO** jacks between TV and external equipment. Match the jack colors. (Video = yellow, Audio Left = white, and Audio Right = red)
- 2 Select **AV3** input source using the **INPUT** button on the remote control.
- 3 Operate the corresponding external equipment. Refer to external equipment operating guide.

EXTERNAL EQUIPMENT SETUP

PC SETUP

This TV provides Plug and Play capability, meaning that the PC adjusts automatically to the TV's settings.

Connecting with a D-sub 15 pin cable

- 1 Connect the RGB output of the PC to the **RGB IN (PC)** jack on the TV.
- 2 Connect the PC audio output to the **AUDIO IN (RGB/DVI)** jack on the TV.
- 3 Turn on the PC and the TV.
- 4 Select **RGB** input source using the **INPUT** button on the remote control.

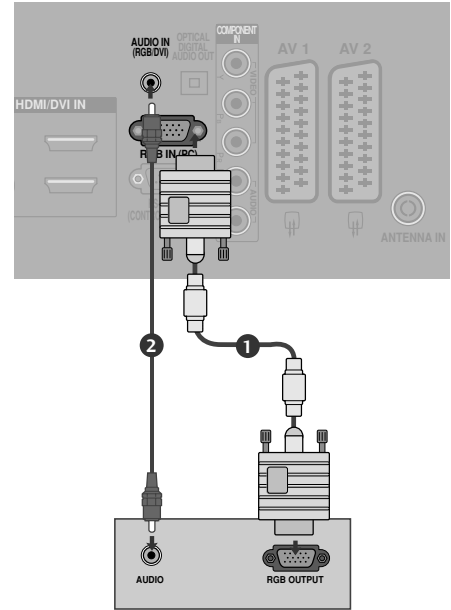

Connecting with a HDMI to DVI cable

- 1 Connect the DVI output of the PC to the **HDMI/DVI IN 1 (DVI)** jack on the TV.
- 2 Connect the PC audio output to the **AUDIO IN (RGB/DVI)** jack on the TV.
- 3 Turn on the PC and the TV.
- 4 Select **HDMI1** input source using the **INPUT** button on the remote control.

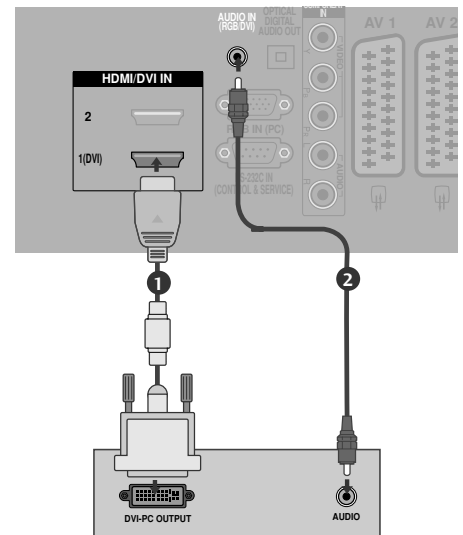

! NOTE

- ▶ If the PC has a DVI output and no HDMI output, a separated audio connection is necessary.
- ▶ If the PC does not support Auto DVI, you need to set the output resolution appropriately.

! NOTE

- ▶ To enjoy vivid picture and sound, connect a PC to the TV.
- ▶ Avoid keeping a fixed image on the TV's screen for prolonged periods of time. The fixed image may become permanently imprinted on the screen; use a screen saver when possible.
- ▶ Connect the PC to the RGB (PC) or HDMI IN (or HDMI/DVI IN) port of the TV; change the resolution.
- ▶ There may be interference relating to resolution, vertical pattern, contrast or brightness in PC mode. Change the PC mode to another resolution or change the refresh rate to another rate or adjust the brightness and contrast on the menu until the picture is clear. If the refresh rate of the PC graphic card can not be changed, change the PC graphic card or consult the manufacturer of the PC graphic card.
- ▶ The synchronization input waveform for Horizontal and Vertical frequencies are separate.
- ▶ In PLASMA TV models, we recommend using 1024x768, 60Hz for the PC mode, these should provide the best picture quality.
- ▶ Connect the signal cable from the monitor output port of the PC to the RGB (PC) port of the TV or the signal cable from the HDMI output port of the PC to the HDMI IN (or HDMI/DVI IN) port on the TV.
- ▶ Connect the audio cable from the PC to the Audio input on the TV. (Audio cables are not included with the TV).
- ▶ If using a sound card, adjust PC sound as required.
- ▶ This TV uses a VESA Plug and Play Solution. The TV provides EDID data to the PC system with a DDC protocol. The PC adjusts automatically when using this TV.
- ▶ DDC protocol is preset for RGB (Analog RGB), HDMI (Digital RGB) mode.
- ▶ If required, adjust the settings for Plug and Play functionality.
- ▶ If the graphic card on the PC does not output analogue and digital RGB simultaneously, connect only one of either RGB or HDMI IN (or HDMI/DVI IN) to display the PC output on the TV.
- ▶ If the graphic card on the PC does output analogue and digital RGB simultaneously, switch the TV to either RGB or HDMI; (the other mode is set to Plug and Play automatically by the TV.)
- ▶ DOS mode may not work depending on the video card if you use a HDMI to DVI cable.
- ▶ If you use too long an RGB[PC] cable, there may be interference on the screen. We recommend using under 5m of cable. This provides the best picture quality.

EXTERNAL EQUIPMENT SETUP

Supported Display Resolution

RGB[PC] / HDMI[PC] mode			HDMI[DTV] mode		
Resolution	Horizontal Frequency(kHz)	Vertical Frequency(Hz)	Resolution	Horizontal Frequency(kHz)	Vertical Frequency(Hz)
720x400	31.468	70.08	640x480	31.469	59.94
640x480	31.469	59.94		31.469	60.00
	800x600	37.500	75.00	720x480	31.47
37.879		60.31	31.50		60.00
832x624	46.875	75.00	720x576	31.25	50.00
	49.725	74.55		37.50	50.00
1024x768	48.363	60.00	1280x720	44.96	59.94
	56.476	70.00		45.00	60.00
1280x768	60.023	75.03	1920x1080	33.72	59.94
	47.693	59.99		33.75	60.00
1360x768	47.649	59.94	1920x1080	28.125	50.00
1366x768	47.649	59.94		27.00	24.00
1920x1080	66.647	59.988		33.75	30.00
1280x1024	63.595	60.00		56.25	50.00
1400x1050	65.150	60.00		67.433	59.94
1600x1200	74.077	60.00		67.500	60.00

! NOTE

- ▶ It is not supported to 1600x1200, 60Hz in RGB[PC] mode.
- ▶ 42/50PG65** is not supported to 1920x1080 in RGB[PC]/HDMI[PC] mode.
- ▶ PLASMA TV is not supported to 1366x768 in RGB[PC]/HDMI[PC] mode.
- ▶ 37/42/47/52LG55**, 50PG45**, 50PG75** are supported to 1280x1024, 1400x1050 and 1920x1080 in RGB[PC]/HDMI[PC] mode.
- ▶ 37/42/47/52LG55** is supported to 1600x1200, 60Hz in HDMI[PC] mode only.
- ▶ 37/42/47/52LG55** is supported to 1920x1080, 30Hz in HDMI[DTV] mode only.

Screen Setup for PC mode

Auto Configure (RGB [PC] mode only)

Automatically adjusts picture position and minimizes image instability. After adjustment, if the image is still not correct, your TV is functioning properly but needs further adjustment.

Auto configure

This function is for automatic adjustment of the screen position, clock, and phase. The displayed image will be unstable for a few seconds while the auto configuration is in progress.



1 Press the **MENU** button and then **▲** or **▼** button to select the **SCREEN** menu.

2 Press the **▶** button and then **▲** or **▼** button to select **Auto Config.**.

3 Press the **▶** button to start **Auto Config.**.

- When **Auto Config.** has finished, **OK** will be shown on screen.
- If the position of the image is still not correct, try Auto adjustment again.

- If picture needs to be adjusted again after Auto adjustment in RGB (PC), you can adjust the **Manual Config.**.

4 Press the **EXIT** button to return to normal TV viewing.

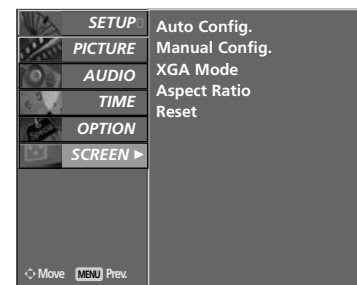

1



2 3

EXTERNAL EQUIPMENT SETUP

Adjustment for screen Phase, Clock, Position

If the picture is not clear after auto adjustment and especially if characters are still trembling, adjust the picture phase manually.

To correct the screen size, adjust Clock.

This function works in the following mode : RGB[PC].

Clock This function is to minimize any vertical bars or stripes visible on the screen background the horizontal screen size will also change.

Phase This function allows you to remove any horizontal noise and clear or sharpen the image of characters.



- 1 Press the **MENU** button and then **▲** or **▼** button to select the **SCREEN** menu.
- 2 Press the **▶** button and then **▲** or **▼** button to select **Manual Config.**
- 3 Press the **▶** button and then **▲** or **▼** button to select **Phase, Clock, H-Position** or **V-Position**.
- 4 Press the **◀** or **▶** button to make appropriate adjustments.
- 5 Press the **EXIT** button to return to normal TV viewing.

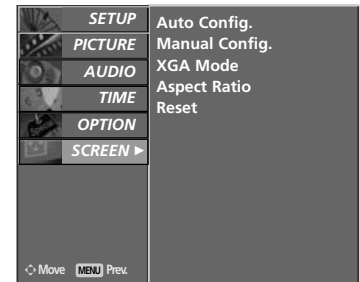

1

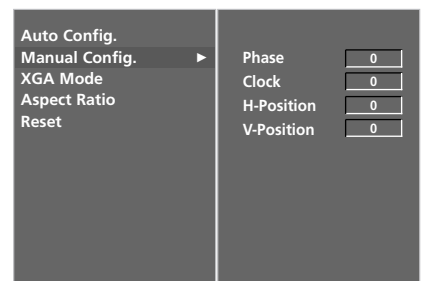

2 3 4

Selecting Wide XGA mode

To view a normal picture, match the resolution of RGB mode and selection of XGA mode.

This function works in the following mode: RGB[PC] mode



- 1 Press the **MENU** button and then ▲ or ▼ button to select the **SCREEN** menu.
- 2 Press the ► button and then ▲ or ▼ button to select **XGA Mode**.
- 3 Press the ► button and then ▲ or ▼ button to select the desired XGA resolution.
- 4 Press the **EXIT** button to return to normal TV viewing.

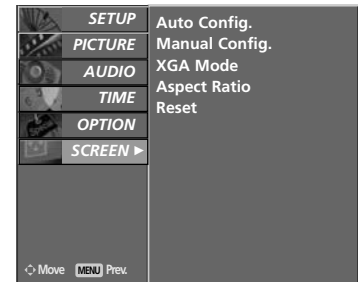

1

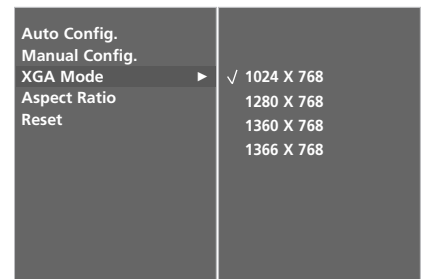

2 3

EXTERNAL EQUIPMENT SETUP

Initializing (Reset to original factory settings)

This function operates in current mode.
To initialize the adjusted value

It is not possible to use **ISM Method** and **Low power** in LCD TV models.

It is possible to use **Power Indicator** in LCD TV models only.



1 Press the **MENU** button and then **▲** or **▼** button to select the **OPTION** menu.

2 Press the **▶** button and then **▲** or **▼** button to select **Factory Mode**.

3 Press the **▶** button and then **▲** or **▼** button to select **Factory Reset**.

4 Press the **OK** button.

The message **“If you enter a password, all user setting will be reset”** will appear.

5 Use **NUMBER** buttons to input a 4-digit password.

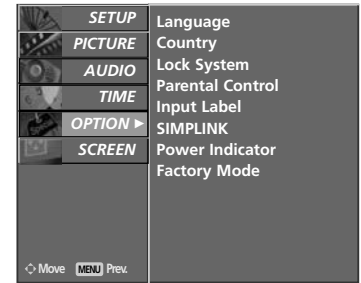

1

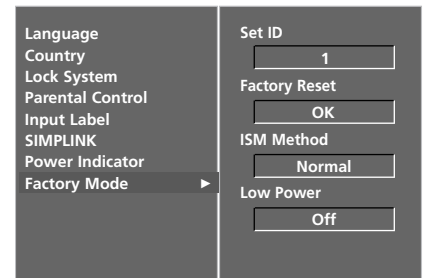

2

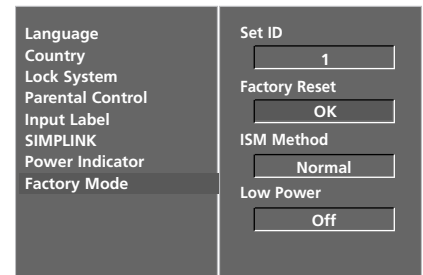

3 4

WATCHING TV / PROGRAMME CONTROL

REMOTE CONTROL KEY FUNCTIONS

When using the remote control, aim it at the remote control sensor on the TV.

POWER Switches the TV on from standby or off to standby.

D/A INPUT Selects digital or analogue mode. Switches the TV on from standby.

TV/RADIO Selects Radio or TV channel in digital mode.

INPUT External input mode rotate in regular sequence. Switches the TV on from standby.

Brightness adjustment Adjusts screen brightness. This returns to the default settings brightness by changing mode source.

Coloured buttons These buttons are used for teletext (on TELETEXT models only) or **Programme edit**.

EXIT Clears all on-screen displays and returns to TV viewing from any menu.

BACK Allows the user to move back one step in an interactive application, EPG or other user interaction function.

MENU Selects a menu.

INFO ⓘ Shows the present screen information.

GUIDE Shows programme schedule.

VOLUME UP /DOWN Adjusts the volume.

FAV Displays the selected favourite programme.

MUTE Switches the sound on or off.

Programme UP/DOWN Selects a programme.

0~9 number button Selects a programme. Selects numbered items in a menu.

LIST Displays the programme table.

Q.VIEW Returns to the previously viewed programme.

WATCHING TV / PROGRAMME CONTROL

1 **MODE** Selects the remote operating modes.

SIMPLINK See a list of AV devices connected to TV. When you toggle this button, the Simplink menu appears at the screen. (► p.51)

1 **TELETEXT BUTTONS** These buttons are used for teletext. For further details, see the 'Teletext' section.

RATIO Selects your desired picture format.

I/II Selects the sound output.

VCR/DVD control buttons Controls some video cassette recorders or DVD players when you have already selected DVD or VCR mode button. Control connected AV devices by pressing the ▲ or ▼ or ◀ or ▶, OK buttons and buttons for play, stop, pause, fast reverse, fast forward, chapter skip. (The ● button does not provide such functions.)

THUMBSTICK (Up/Down/Left Right) Allows you to navigate the on-screen menus and adjust the system settings to your preference.

OK Accepts your selection or displays the current mode.

SLEEP Sets the sleep timer.

SUBTITLE Recalls your preferred subtitle in digital mode.

1 **Installing Batteries**

- Open the battery compartment cover on the back and install the batteries matching correct polarity (+with +,-with -).
- Install two 1.5V AA batteries. Do not mix old or used batteries with new ones.
- Close cover.

TURNING ON THE TV

- When your TV is turned on, you will be able to use its features.

- 1 Firstly, connect the power cord correctly.
At this stage, the TV switches to standby mode.
- 2 In standby mode to turn TV on, press the ϕ / I, INPUT or PR \blacktriangle or \blacktriangledown button on the TV or press the POWER, INPUT, D/A, PR + or - or NUMBER button on the remote control and the TV will switch on.

Initializing setup

If the OSD (On Screen Display) is displayed on the screen after turning on the TV, you can adjust the Language, Auto programme tuning.

Note:

- It will automatically disappear after approx. 40 seconds unless a button is pressed.
- Press the **BACK** button to change the current OSD to the previous OSD.

< Only PLASMA TV Models >

- "Home" mode is the optimal setting for home environments, and is the TV's default mode.
- "In Store" mode is the optimal setting for store environments. "If a user modifies image quality data, "In Store" mode initializes the product to the image quality set by us after a certain period of time.
- The mode (Home, In Store) can be changed by executing Factory Reset in the OPTION menu.



WATCHING TV / PROGRAMME CONTROL

PROGRAMME SELECTION

- 1 Press the **PR +** or **-** or **NUMBER** buttons to select a programme number.

VOLUME ADJUSTMENT

- 1 Press the **VOL +** or **-** button to adjust the volume.
If you wish to switch the sound off, press the **MUTE** button.
You can cancel this function by pressing the **MUTE**, **VOL +** or **-**, or **I/II** button.



ON SCREEN MENUS SELECTION AND ADJUSTMENT

Your TV's OSD (On Screen Display) may differ slightly from that shown in this manual.

- 1 Press the **MENU** button and then ▲ or ▼ button to display each menu.
- 2 Press the ► button and then ▲ or ▼ button to select a menu item.
- 3 Change the setting of an item in the sub or pull-down menu with ◀ or ▶ button.
You can move to a higher level menu by pressing the **OK** or **MENU** button.

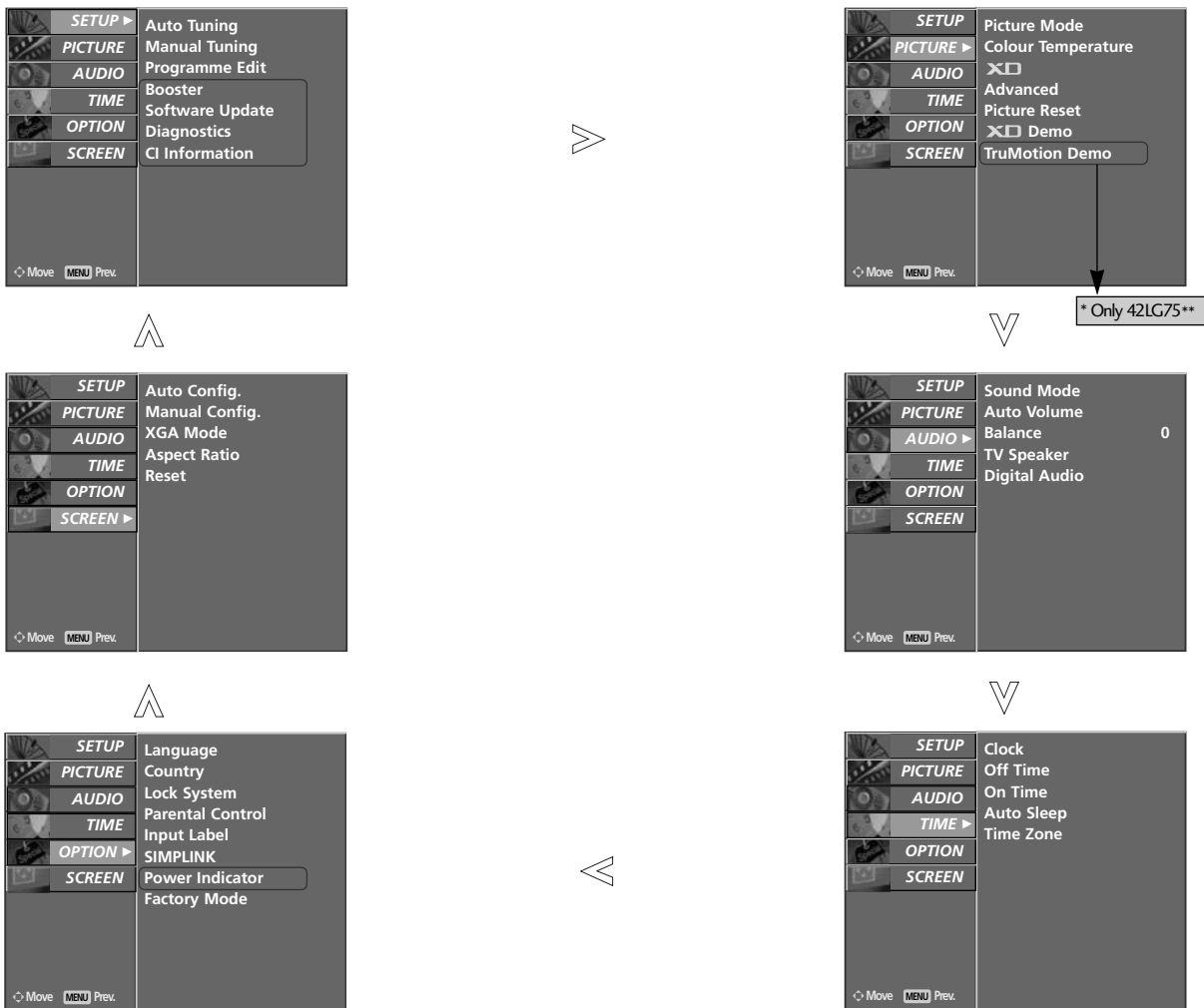

! NOTE

- ▶ It is not possible to use **ISM Method** and **Low power** in LCD TV models.
- ▶ In Analogue mode, **Booster**, **Software Update**, **Diagnostics** and **CI Information** will not be displayed.
- ▶ It is possible to use **Power Indicator** in LCD TV models only.

WATCHING TV / PROGRAMME CONTROL

AUTO PROGRAMME TUNING (IN DIGITAL MODE)

Use this to automatically find and store all available programmes.

When you start auto programming in digital mode, all previously stored service information will be deleted.



1 Press the **MENU** button and then **▲** or **▼** button to select the **SETUP** menu.

2 Press the **▶** button and then **▲** or **▼** button to select **Auto Tuning**.

3 Press the **▶** button to begin auto tuning. Use **NUMBER** buttons to input a 4-digit password in **Lock System 'On'**.

The message "**All service-information will be updated. Continue?**" will appear.

If you want to keep on auto tuning select **YES** using the **◀** or **▶** button. Then, press the **OK** button. Otherwise select **NO**.

To stop auto tuning, press the **MENU** button.

4 Press the **EXIT** button to return to normal TV viewing.

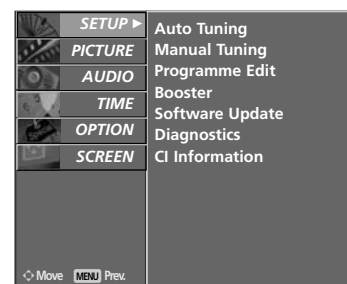

1

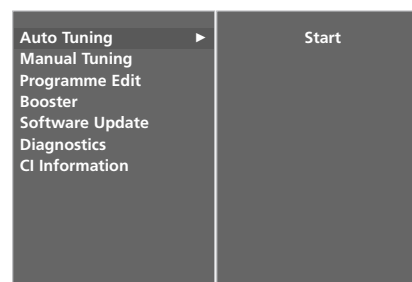

2

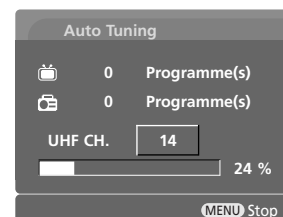

3

MANUAL PROGRAMME TUNING (IN DIGITAL MODE)

Manual Tuning lets you manually add a programme to your programme list.

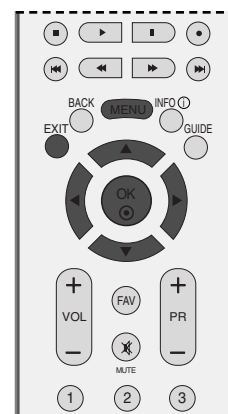

- 1 Press the **MENU** button and then **▲** or **▼** button to select the **SETUP** menu.
- 2 Press the **▶** button and then **▲** or **▼** button to select **Manual Tuning**.
- 3 Press the **▶** button and then **▲** or **▼** button or **NUMBER** buttons to select the desired channel number. Use **NUMBER** buttons to input a 4-digit password in **Lock System 'On'**.
- 4 Press the **OK** button to save.

When the channel number you want to add is already in the programme list, the message **“Setup information for the channel will be updated. Continue?”** will appear.

If you wish to continue manual tuning, select **YES** using the **◀** or **▶** button.

Then, press **OK**. Otherwise select **NO**.

- 5 Press the **EXIT** button to return to normal TV viewing.

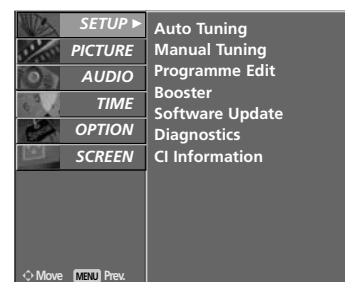

1

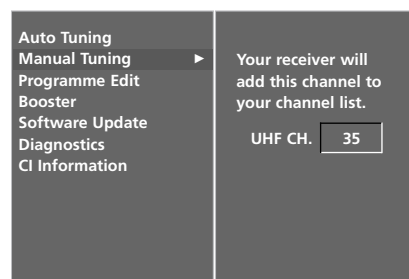

2

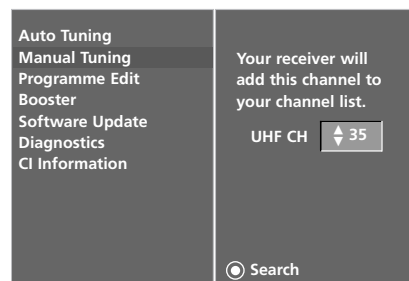

3 4

WATCHING TV / PROGRAMME CONTROL

PROGRAMME EDIT (IN DIGITAL MODE)

When a programme number is skipped, it means that you will be unable to select it using **PR +** or **-** button during TV viewing.

If you wish to select the skipped programme, directly enter the programme number with the **NUMBER** buttons or select it in the Programme edit menu

This function enables you to skip the stored programmes.





- 1 Press the **MENU** button and then **▲** or **▼** button to select the **SETUP** menu.
- 2 Press the **▶** button and then **▲** or **▼** button to select **Programme Edit** menu.
- 3 Press the **▶** button to enter the **Programme Edit** menu.
Use **NUMBER** buttons to input a 4-digit password in **Lock System 'On'**.
- 4 Select a programme to be stored or skipped with the **▲** or **▼** or **◀** or **▶** button.
- 5 Press the **BLUE** button repeatedly to have the programme skipped or stored.

When programmes are to be skipped, skipped programme shows in blue and these programmes will not be selected by the **PR +** or **-** buttons during TV viewing.

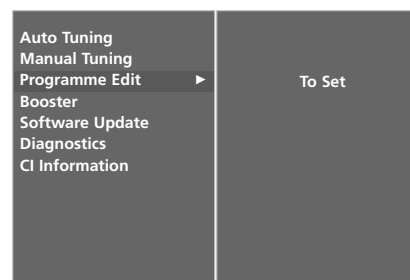
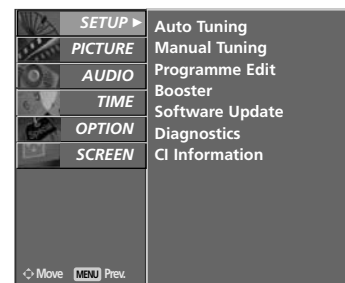
- 6 Press the **EXIT** button to return to normal TV viewing.



Mini Glossary

-  Displayed when a DTV Programme.
-  Displayed when a Locked Programme.
-  Displayed when a Radio Programme.

■ Skipping a programme number

1 Select a programme number to be skipped with the ▲ or ▼ or ◀ or ▶ button.

2 Press the **BLUE** button. The skipped programme number turns to blue.

3 Press the **BLUE** button again to release the skipped programme.

When a programme number is skipped it means that you will be unable to select it using the PR + or - button during normal TV viewing.

If you wish to select a skipped programme, directly enter the programme number with the NUMBER buttons or select it in the programme edit or EPG.

4 Press the **EXIT** button to return to normal TV viewing.

■ Locking a programme (In Lock System On mode only)

1 Select a programme to be locked with the ▲ or ▼ or ◀ or ▶ button.

2 Press the **GREEN** button. The lock symbol will appear in front of that programme number.

3 Press the **GREEN** button again to release this function.

Note :

- ▶ To watch a locked programme, input a 4-digit password in Lock system. Be sure to remember this number!
- ▶ If you forget your password, press '7', '7', '7', '7' on the remote control handset.
- ▶ If you select another programme after releasing a locked programme and then return to the locked programme within 1 minute, there is no need to input a password to select the locked programme.

■ Selecting favourite programme

1 Select your favourite programme number by pressing ▲ or ▼ or ◀ or ▶ button and then press the **FAV** button on your remote control handset.

This will automatically include the selected programme into your favourite programme list.

WATCHING TV / PROGRAMME CONTROL

BOOSTER (IN DIGITAL MODE ONLY)

When the interference between programmes appear, select **Booster** to **Off**.



- 1 Press the **MENU** button and then ▲ or ▼ button to select the **SETUP** menu.
- 2 Press the ► button and then ▲ or ▼ button to select **Booster**.
- 3 Press the ► button and then ▲ or ▼ button to select **On** or **Off**.
- 4 Press the **EXIT** button to return to normal TV viewing.

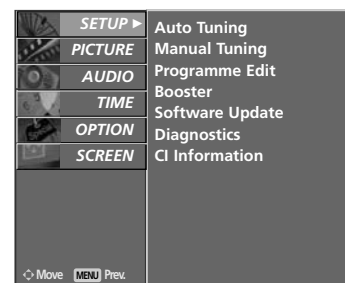

1

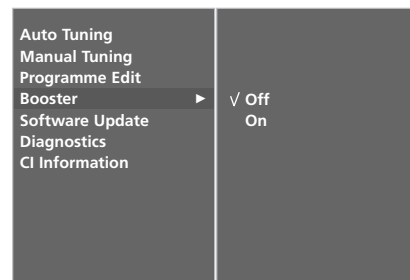

2 3

SOFTWARE UPDATE (IN DIGITAL MODE ONLY)

Software Update means software can be downloaded through the digital terrestrial broadcasting system.



1 Press the **MENU** button and then **▲** or **▼** button to select the **SETUP** menu.

2 Press the **▶** button and then **▲** or **▼** button to select **Software update**.

3 Press the **▶** button and then **▲** or **▼** button to select **On** or **Off**.

- If you select **On**, a user confirm message box will be displayed to notify that new software is found.

4 Press the **EXIT** button to return to normal TV viewing.

* When setting “Software Update”

5 Occasionally, a transmission of updated digital software information will result in the OSD (On Screen Display) on the TV screen.

6 Select **YES** using the **◀** or **▶** button. The OSD will be disappeared on the TV screen, and you can watch the current TV viewing.



1

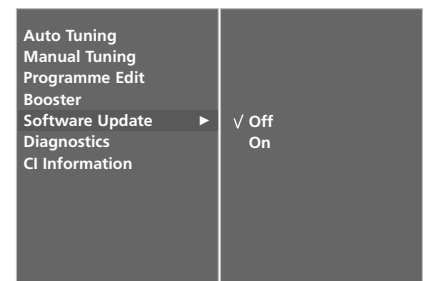

2 3

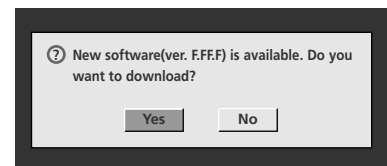

5 6

- ▶ When you change the TV to standby mode using the **POWER** button while watching the TV, it will be started **Software update**.
- ▶ Turn on the TV in standby mode. The OSD is displayed on the screen based on **Software update** circumstances.
- ▶ After the **Software update** is complete, the System takes about one minute to restart.

- During Progress of a Software Update, please note the following:

- Power to the TV must not be interrupted.
- The TV must not be switched off.
- The antenna must not be disconnected.
- After Software Update, you can confirm the updated software version in Diagnostics menu.

WATCHING TV / PROGRAMME CONTROL

DIAGNOSTICS (IN DIGITAL MODE ONLY)

This function enables you to view information on the Manufacturer, Model/Type, Serial Number and Software Version.

This displays the information and signal strength of the tuned MUX.

This displays the signal information and service name of the selected MUX.

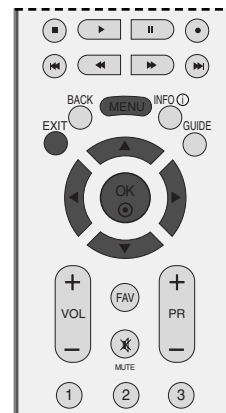

- 1 Press the **MENU** button and then **▲** or **▼** button to select the **SETUP** menu.
- 2 Press the **▶** button and then **▲** or **▼** button to select **Diagnostics**.
- 3 Press the **▶** button to display Manufacturer, Model/Type, Serial Number and Software Version.
- 4 Press the **EXIT** button to return to normal TV viewing.

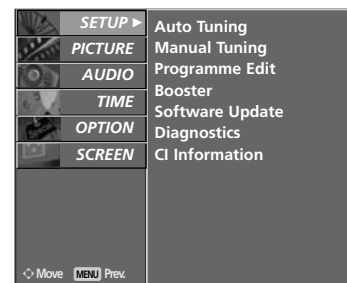

1

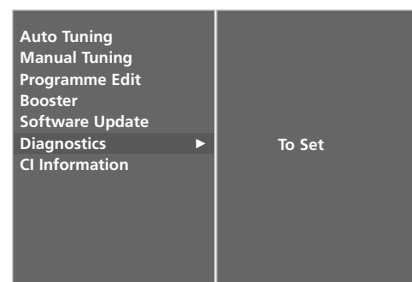

2



3

CI [COMMON INTERFACE] INFORMATION (IN DIGITAL MODE ONLY)

This function enables you to watch some encrypted services (pay services). If you remove the CI Module, you cannot watch pay services. When the module is inserted into the CI slot, you can access the module menu.

To purchase a module and smart card, contact your dealer. Do not repeatedly insert or remove a CAM module from the TV. This may cause a malfunction. When the TV is turned on after inserting a CI Module, you may not have any sound output.

This may be incompatible with the CI module and smart card.



- 1 Press the **MENU** button and then ▲ or ▼ button to select the **SETUP** menu.
- 2 Press the ► button and then ▲ or ▼ button to select **CI Information**.
- 3 Press the ► button and then **OK** button.
- 4 Press the ▲ or ▼ button to select the desired item: Module information, smart card information, language or software download etc.
- 5 Press the **OK** button.
- 6 Press the **EXIT** button to return to normal TV viewing.

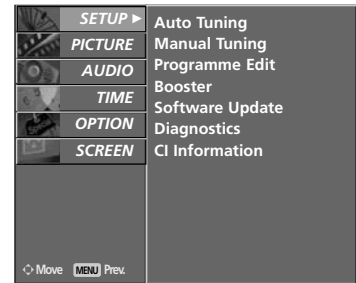

1

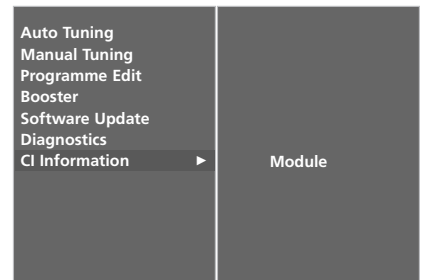

2 3

- This OSD is only for illustration and the menu options and screen format will vary according to the Digital pay services provider.
- It is possible for you to change CI (Common Interface) menu screen and service by consulting your dealer.

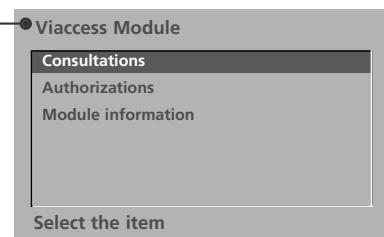

4 5

AUTO PROGRAMME TUNING (IN ANALOGUE MODE)

All stations which can be received are stored by this method. It is recommended that you use Auto tuning during installation of this TV.



- 1 Press the **MENU** button and then **▲** or **▼** button to select the **SETUP** menu.
- 2 Press the **▶** button and then **▲** or **▼** button to select **Auto Tuning**.
- 3 Press the **▶** button to select **System**. Select a TV system with the **◀** or **▶** button;

- L** : SECAM L/L' (France)
- BG** : PAL B/G, SECAM B/G (Europe / East Europe / Asia / New Zealand / M.East / Africa / Australia)
- I** : PAL I/II (U.K. / Ireland / Hong Kong / South Africa)
- DK** : PAL D/K, SECAM D/K (East Europe / China / Africa / CIS)

- 4 Press the **▼** button to select **Storage From**.
Select the initial programme number with the **◀** or **▶** button or **NUMBER** buttons on the **Storage From** menu.

- 5 Press the **▼** button to select **Start**.

The station name is stored for stations which broadcast VPS (Video Programme Service), PDC (Programme Delivery Control) or TELETEXT data.

If no station name can be assigned to a station, the channel number is assigned and stored as **C** (V/UHF 01-69) or **S** (Cable 01-47), followed by a number.

To stop auto tuning, press the **MENU** button.

When auto tuning is complete, the **Programme Edit** menu appears on the screen.

See the '**Programme Edit**' section to edit the stored programme.

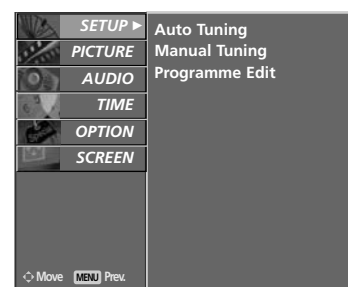

1

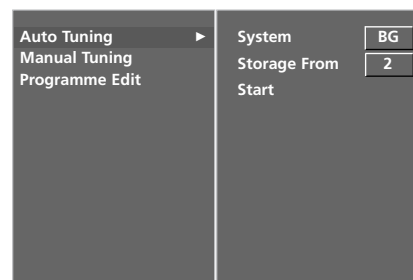

2 3 4 5

MANUAL PROGRAMME TUNING (IN ANALOGUE MODE)

Manual Tuning lets you manually tune and arrange the stations in whatever order you desire.



- 1 Press the **MENU** button and then **▲** or **▼** button to select the **SETUP** menu.
- 2 Press the **▶** button and then **▲** or **▼** button to select **Manual Tuning**.
- 3 Press the **▶** button to select **Storage**.
Select the desired programme number with the **◀** or **▶** button or **NUMBER** buttons on the **Storage** menu.
- 4 Press the **▼** button to select **System**. Select a TV system with the **◀** or **▶** button;
 - L** : SECAM L/L' (France)
 - BG** : PAL B/G, SECAM B/G (Europe / East Europe / Asia / New Zealand / M.East / Africa / Australia)
 - I** : PAL I/II (U.K. / Ireland / Hong Kong / South Africa)
 - DK** : PAL D/K, SECAM D/K (East Europe / China / Africa / CIS)
- 5 Press the **▼** button to select **Band**. Press the **◀** or **▶** button to select **V/UHF** or **Cable** as required.
- 6 Press the **▼** button to select **Channel**. You can select the desired channel number with the **◀** or **▶** button or **NUMBER** buttons.
If possible, select the channel number directly with the **NUMBER** buttons.
- 7 Press the **▼** button to select **Search**. Press the **◀** or **▶** button to commence searching. If a station is found the search will stop.
- 8 Press the **OK** button to store the channel.
- 9 To store another channel, repeat steps 3 to 8.
- 10 Press the **EXIT** button to return to normal TV viewing.

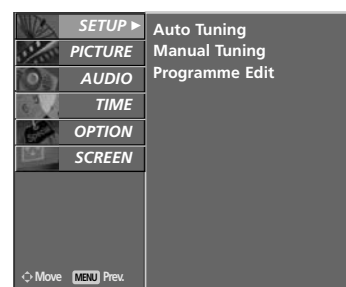

1

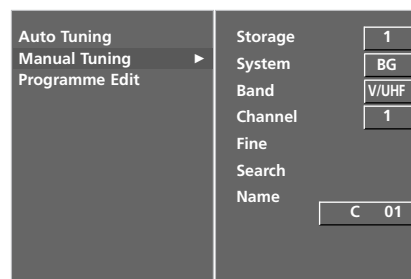

WATCHING TV / PROGRAMME CONTROL

FINE TUNING (IN ANALOGUE MODE)

Normally fine tuning is only necessary if reception is poor.

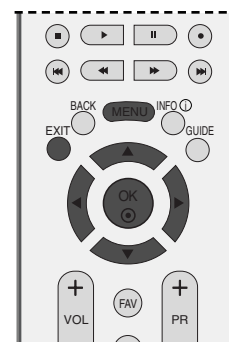

- 1 Press the **MENU** button and then **▲** or **▼** button to select the **SETUP** menu.
- 2 Press the **▶** button and then **▲** or **▼** button to select **Manual Tuning**.
- 3 Press the **▶** button and then **▲** or **▼** button to select **Fine**.
- 4 Press the **▶** button and then **◀** or **▶** button to fine tune for the best picture and sound.
- 5 Press the **OK** button to store settings.
- 6 Press the **EXIT** button to return to normal TV viewing.

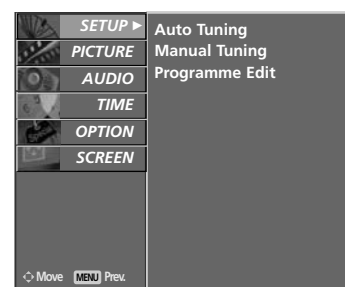

1

ASSIGNING A STATION NAME (IN ANALOGUE MODE)

You can assign a station name with five characters to each programme number.

- 1 Press the **MENU** button and then **▲** or **▼** button to select the **SETUP** menu.
- 2 Press the **▶** button and then **▲** or **▼** button to select **Manual Tuning**.
- 3 Press the **▶** button and then **▲** or **▼** button to select **Name**.
- 4 Press the **▶** button and then **▲** or **▼** button. You can use the alphabet A to Z, numbers 0 to 9, +/ -, and blank.
- 5 Press the **◀** or **▶** button to select the position and make your choice of the second character, and so on.
- 6 Press the **OK** button to store it.
- 7 Press the **EXIT** button to return to normal TV viewing.

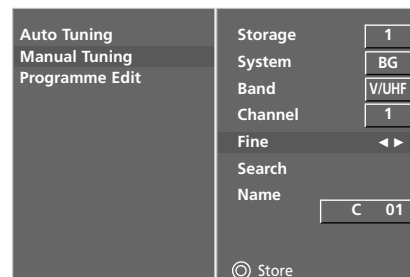

2 3 4 5

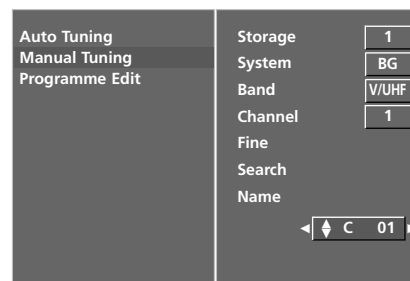

2 3 4 5 6

PROGRAMME EDIT (IN ANALOGUE MODE)

This function enables you to delete or skip the stored programmes. You can also move some channels to other programme numbers or copy blank channel data into a selected programme number.

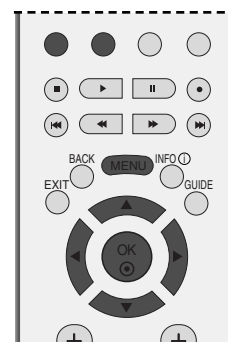

- 1 Press the **MENU** button and then **▲** or **▼** button to select the **SETUP** menu.
- 2 Press the **▶** button and then **▲** or **▼** button to select **Programme Edit**.
- 3 Press the **▶** button to display the Programme Edit menu.

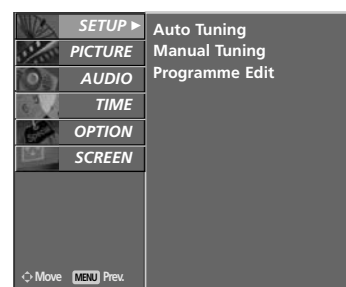

1

■ Deleting a programme

- a Select a programme to be deleted with the **▲** or **▼** or **◀** or **▶** button.
- b Press the **RED** button twice. The selected programme is deleted, all the following programmes are shifted up one position.

■ Copying a programme

- a Select a programme to be copied with the **▲** or **▼** or **◀** or **▶** button.
- b Press the **GREEN** button. All the following programmes are shifted down one position.



2

WATCHING TV / PROGRAMME CONTROL

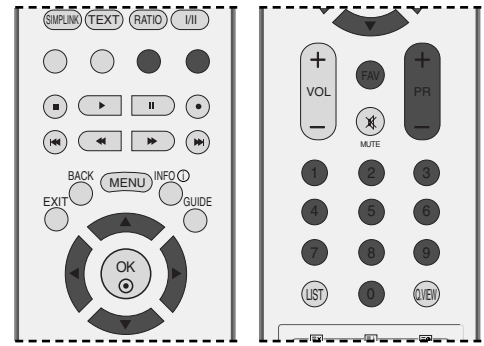

■ Moving a programme

- a Select a programme to be moved with ▲ or ▼ or ◀ or ▶ button.
- b Press the **YELLOW** button.
- c Move the programme to the desired programme number with the ▲ or ▼ or ◀ or ▶ button.
- d Press the **YELLOW** button again to release this function.

■ Skipping a programme number

- a Select a programme number to be skipped with ▲ or ▼ or ◀ or ▶ button.
- b Press the **BLUE** button. The skipped programme number turns to blue.
- c Press the **BLUE** button to release the skipped programme.
- d When a programme number is skipped it means that you will be unable to select it using the **PR +** or **-** button during normal TV viewing.

If you wish to select the skipped programme, directly enter the programme number with the **NUMBER** buttons or select it in the programme edit or table menu.

■ Selecting a Favourite Programme

- a Select your favourite programme number with ▲ or ▼ or ◀ or ▶ button.
- b Press the **FAV** button.

The selected programme will be added to the favourite programme list.

SELECTING THE PROGRAMME TABLE

You can check which programmes are stored in the memory by displaying the programme table.

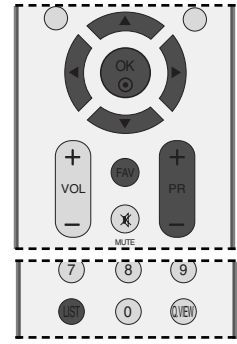

■ Displaying programme LIST

- 1 Press the **LIST** button to display the **PROGRAMME LIST** menu.

The programme list appears on the screen.

- You may find some blue programmes. These have been set up to be skipped by auto programming or in the programme edit mode.
- Some programmes with the channel number shown in the programme LIST indicate there is no station name assigned.

■ Selecting a programme in the programme list

- 1 Select a programme with the **▲** or **▼** button
- 2 Press the **OK** button. The TV switches to the chosen programme number.

■ Paging through a programme list (Digital Mode Only)

- 1 Press the **PR +** or **-** button repeatedly to turns the pages.
- 2 Press the **LIST** button to return to normal TV viewing.

■ Displaying the favourite programme table

Press the **FAV** button to display the Favourite Programme table menu.



< In Digital Mode >

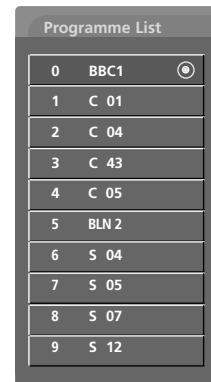

< In Analogue Mode >

Mini Glossary

- Displayed when the Locked Programme.

WATCHING TV / PROGRAMME CONTROL

INPUT SOURCE SELECTION

Selects a label for each input source which is not in use.

It is not possible to use **HDMI4** in LCD TV models.



- 1 Press the **MENU** button and then **▲** or **▼** button to select the **OPTION** menu.
- 2 Press the **▶** button and then **▲** or **▼** button to select **Input Label**.
- 3 Press the **▶** button and then **▲** or **▼** button to select the source.
- 4 Press the **◀** or **▶** button to select the label.
- 5 Press the **EXIT** button to return to normal TV viewing.

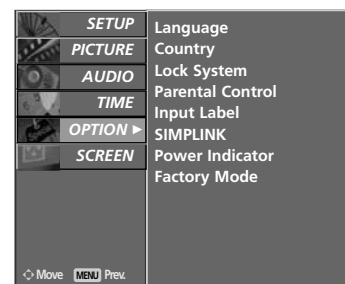

1

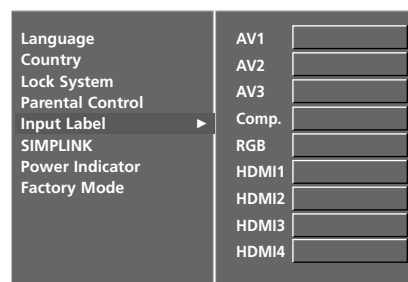

2 3 4

SIMPLINK FUNCTION

This function operates only with devices with the SIMPLINK logo. Please check the SIMPLINK logo.

This TV might not function properly when using it with other products with HDMI-CEC function.

This allows you to control and play other AV devices connected to the display through HDMI cable without additional cables and settings.

If you do not require the SIMPLINK menu, select “**Off**”.

SIMPLINK function is not supported by HDMI IN 3/4 input.



1 Press the **MENU** button and then **▲** or **▼** button to select the **OPTION** menu.

2 Press the **▶** button and then **▲** or **▼** button to select **SIMPLINK**.

3 Press the **▶** button and then **▲** or **▼** button to select **On** or **Off**.

4 Press the **EXIT** button to return to normal TV viewing.

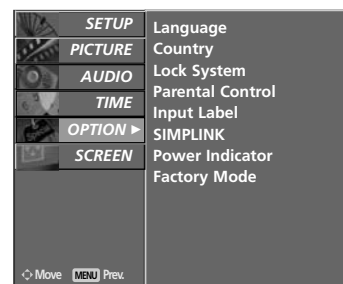

1

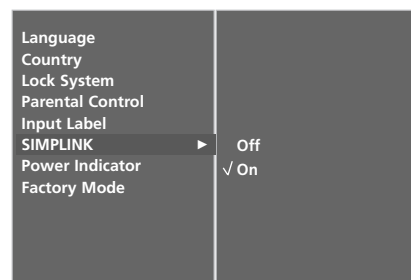







2 3

WATCHING TV / PROGRAMME CONTROL

SIMPLINK Functions

Disc playback

Control connected AV devices by pressing the ▲ or ▼ or ◀ or ▶, OK, , , , , ,  and  buttons.

Direct Play

After connecting AV devices to the TV, you can directly control the devices and play media without additional settings.

Select AV device

Enables you to select one of the AV devices connected to the TV and operate it.

Power off all devices

When you switch off the TV, all connected devices are turned off.

Switch audio-out

Offers an easy way to switch audio-out.

* A device, which is connected to the TV through a HDMI cable but does not support SIMPLINK, does not provide this function.

SIMPLINK Menu

Press the ▲ or ▼ or ◀ or ▶ button and then OK button to select the desired SIMPLINK source.

- 1 **TV viewing** : Switch to the previous TV programme regardless of the current mode.
- 2 **DISC playback** : Select and play connected discs. When multiple discs are available, the titles of discs are conveniently displayed at the bottom of the screen.
- 3 **VCR playback** : control the connected VCR.
- 4 **HDD Recordings playback** : control recordings stored in HDD.
- 5 **Audio Out to Home theatre/Audio Out to TV:** Select Home theatre or TV speaker for Audio Out.

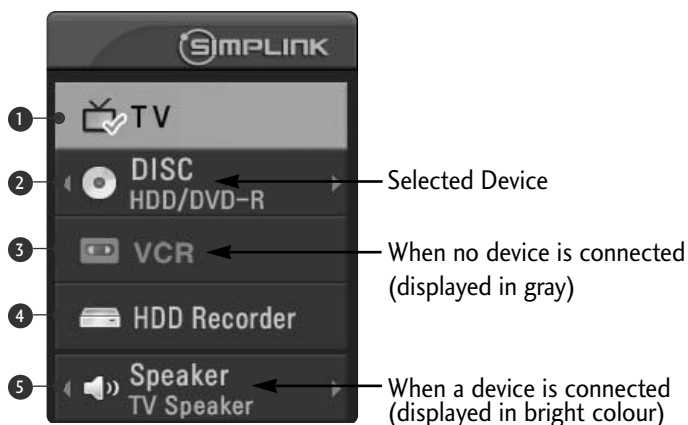

NOTE

- ▶ Connect the HDMI/DVI IN or HDMI IN terminal of the TV to the rear terminal (HDMI terminal) of the SIMPLINK device with the HDMI cable.
- ▶ After connecting the HDMI terminal for the home theatre with the SIMPLINK function using the above method, connect the DIGITAL AUDIO OUT terminal on the back of the TV to the DIGITAL AUDIO IN terminal on the back of the SIMPLINK device with the OPTICAL cable.
- ▶ When operating an external device with SIMPLINK, press the TV button from the MODE buttons on the remote control.
- ▶ When you switch the Input source using the INPUT button on the remote control, you can stop the operation of a device controlled by SIMPLINK.
- ▶ When you select or operate a media device with home theatre function, the speaker automatically switches to home theatre speaker (HT speaker).

PICTURE CONTROL

EPG (ELECTRONIC PROGRAMME GUIDE) (IN DIGITAL MODE)

This system has an Electronic Programme Guide (EPG) to help your navigation through all the possible viewing options.

The EPG supplies information such as programme listings, start and end times for all available services. In addition, detailed information about the programme is often available in the EPG (the availability and amount of these programme details will vary, depending on the particular broadcaster).

This function can be used only when the EPG information is broadcast by broadcasting companies.

The EPG displays the programme details for next 8 days.

Switch on/off EPG

- 1 Press the **GUIDE** button to switch on EPG.
- 2 Press the **GUIDE** or **EXIT** button again to switch off EPG and return to normal TV viewing.

Select a programme

- 1 Press the **▲** or **▼**, **◀** or **▶**, **PR +** or **-** button to select the desired programme, then the **OK** button, the popup window to select the function is displayed.



PICTURE CONTROL

Button Function in NOW/NEXT Guide Mode

Remote Control Buttons	Function
RED	Change EPG mode
YELLOW	Enter Timer Record/Remind setting mode
BLUE	Enter Timer Record/Remind list mode
●	Change to the selected channel
◀ or ▶	Select NOW or NEXT Programme
▲ or ▼	Select the Broadcast Programme
PR + or -	Page Up/Down
GUIDE/EXIT	Switch off EPG
TV/RADIO	Select TV or RADIO Programme
INFO ⓘ	Detail information on or off



Button Function in 8 Day Guide Mode

Remote Control Buttons	Function
RED	Change EPG mode
GREEN	Enter Date setting mode
YELLOW	Enter Timer Record/Remind setting mode
BLUE	Enter Timer Record/Remind list mode
●	Change to the selected channel
◀ or ▶	Select NOW or NEXT Programme
▲ or ▼	Select the Broadcast Programme
PR + or -	Page Up/Down
GUIDE/EXIT	Switch off EPG
TV/RADIO	Select TV or RADIO Programme
INFO ⓘ	Detail information on or off



Button Function in Date Change Mode

Remote Control Buttons	Function
GREEN	Switch off Date setting mode
●	Change to the selected date
◀ or ▶	Select a date
▼	Switch off Date setting mode
GUIDE/EXIT	Switch off EPG



Button Function in Extended Description Box

Remote Control Buttons	Function
▲ or ▼	Text Up/Down
INFO ⓘ	The detail information on or off
PR + or -	Page Up/Down
GUIDE/EXIT	Switch off EPG



Button Function in Record/Remind Setting Mode

- This function is available only when recording equipment that use pin8 recording signalling has been connected to the DTV-OUT terminal, using a SCART cable.

Remote Control Buttons	Function
YELLOW	Change to Guide mode
●	Save Timer Record/Remind
◀ or ▶	Select Type, Service, Date or Start/End time
▲ or ▼	Function setting



Button Function in Timer List Mode

Remote Control Buttons	Function
YELLOW	Add new Manual Timer setting mode
GREEN	Enter Timer list editing mode
RED	Delete the selected item
BLUE	Change to Guide mode
▲ or ▼	Select Timer list



PICTURE CONTROL

PICTURE SIZE (ASPECT RATIO) CONTROL

You can watch the screen in various picture formats; **16:9**, **Original**, **4:3**, **14:9**, **Zoom1/2** and **Just Scan** (Only 37/42/47/52LG55**, 42LG75**, 50PG45**, 50PG75**).

It is possible to use **Just Scan** in DTV mode only.

If a fixed image is displayed on the screen for a long time, that fixed image may become imprinted on the screen and remain visible.

You can adjust the enlarge proportion using **▲** or **▼** button.

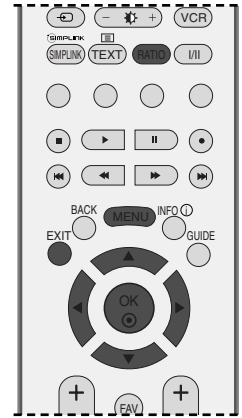

- 1 Press the **RATIO** button repeatedly to select the desired picture format. You can also adjust **Aspect Ratio** in the **SCREEN** menu.

- **16:9**

The following selection will allow you to adjust the picture horizontally, in linear proportion, to fill the entire screen (useful for viewing 4:3 formatted DVDs).

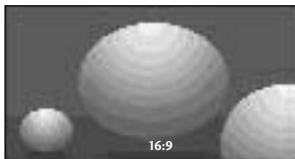

- **Original**

When your TV receives a wide screen signal it will automatically change to the picture format broadcast.

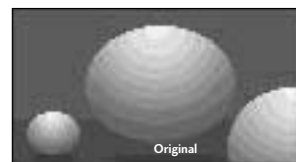

• **4:3**

The following selection will allow you to view a picture with an original 4:3 aspect ration, grey bars will appear on both the left and right of the screen.

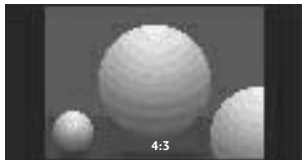

• **14:9**

You can view a picture format of 14:9 or a general TV programme in the 14:9 mode. The 14:9 screen is viewed in the same way as in 4:3, but is magnified to the left and right.

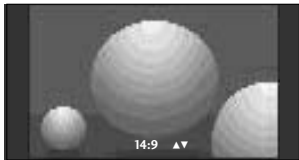

• **Zoom1**

The following selection will allow you to view the picture without any alteration, while filling the entire screen. However, the top and bottom of the picture will be cropped.



• **Zoom2**

Choose Zoom 2 when you wish the picture to be altered, both horizontally extended and vertically cropped. The picture adopting a compromise between alteration and screen coverage.

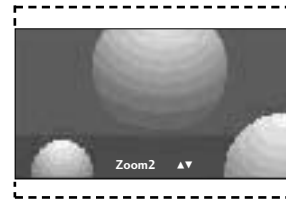

• **Just Scan**

(Only 37/42/47/52LG55**, 42LG75**, 50PG45**, 50PG75**)

Following Selection will lead to you view the picture of best quality without loss of original picture in high resolution image.

Note:

1. If there are interference in original picture, you can view interference at the edge.
2. Specification is subject to change without prior notice.

! NOTE

- ▶ You can only select **Original, 14:9** in **DTV, TV** or **AV** mode.
- ▶ You can not select **Zoom1/2** in **RGB/HDMI[PC]** mode only.
- ▶ In **HDMI** (1080i 50Hz/60Hz, 1080p 24Hz/50Hz/60Hz) mode, **Just Scan** (Only 37/42/47/52LG55**, 42LG75**, 50PG45**, 50PG75**) is available.

PICTURE CONTROL

PRESET PICTURE SETTINGS

Picture Mode-Preset

Intelligent Sensor	Adjusts picture according to the surrounding conditions. (LCD TV models only)
Vivid	Select this option to display a sharp image.
Standard	The most general and natural screen display status.
Cinema	Select this option to display a cinema image.
User 1/2	Select this option to use a user defined setting.



- 1 Press the **MENU** button and then ▲ or ▼ button to select the **PICTURE** menu.
- 2 Press the ► button and then ▲ or ▼ button to select **Picture Mode**.
- 3 Press the ► button and then ▲ or ▼ button to select **Intelligent Sensor**, **Vivid**, **Standard**, **Cinema**, **User 1** or **User 2**.
- 4 Press the **EXIT** button to return to normal TV viewing.

Picture Mode adjusts the TV for the best picture appearance. Select the preset value in the **Picture Mode** menu based on the programme category.

Intelligent Sensor, **Vivid**, **Standard** and **Cinema** are programmed for optimum picture reproduction at the factory and cannot be changed.

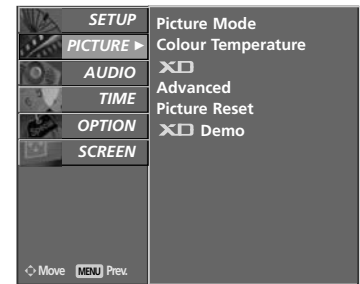

1

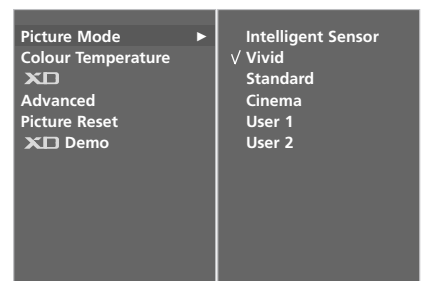

2 3

Auto Colour Tone Control (Warm/Medium/Cool)

To initialize values (reset to default settings), select the Cool option.

Choose one of three automatic colour adjustments. Set to warm to enhance hotter colours such as red or set to cool to see less intense colours with more blue.

It's available to use this function in **User** mode.



- 1 Press the **MENU** button and then ▲ or ▼ button to select the **PICTURE** menu.
- 2 Press the ► button and then ▲ or ▼ button to select **Colour Temperature**.
- 3 Press the ► button and then ▲ or ▼ button to select either **Cool**, **Medium**, **Warm** or **User**.
- 4 Press the **EXIT** button to return to normal TV viewing.

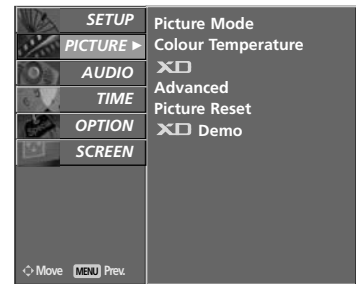

1

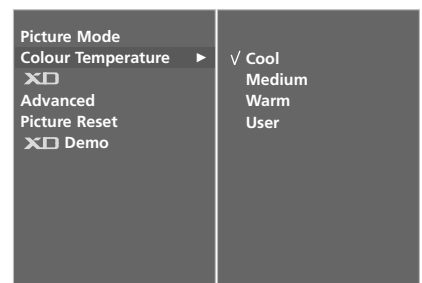

2 3

PICTURE CONTROL

MANUAL PICTURE ADJUSTMENT

Picture Mode-User option

It is possible to use **Back Light** function in LCD TV models only.



- 1 Press the **MENU** button and then ▲ or ▼ button to select the **PICTURE** menu.
- 2 Press the ► button and then ▲ or ▼ button to select **Picture Mode**.
- 3 Press the ► button and then ▲ or ▼ button to select **User 1** or **User 2**.
- 4 Press the ► button and then ▲ or ▼ button to select the desired picture option (**Back Light**, **Contrast**, **Brightness**, **Colour**, **Sharpness** and **Tint**).
- 5 Press the ► button and then ◀ or ▶ button to make appropriate adjustments.
- 6 Press the **EXIT** button to return to normal TV viewing.

! NOTE

- ▶ You can not adjust colour, sharpness and tint in the RGB/HDMI[PC] mode.

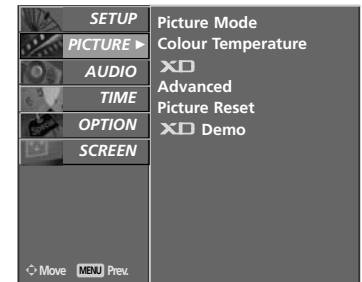

1

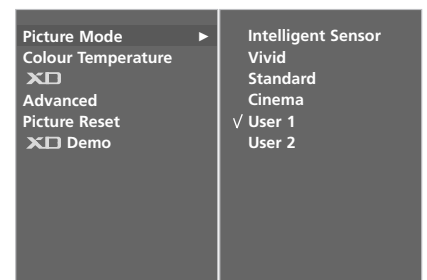

2 3



4 5

Colour Tone - User option

To adjust red, green, blue to any colour temperature you prefer.



- 1 Press the **MENU** button and then **▲** or **▼** button to select the **PICTURE** menu.

- 2 Press the **▶** button and then **▲** or **▼** button to select **Colour Temperature**.

- 3 Press the **▶** button and then **▲** or **▼** button to select **User**.

- 4 Press the **▶** button and then **▲** or **▼** button to select **Red**, **Green** or **Blue**.

- 5 Press the **▶** button and then **◀** or **▶** button to make appropriate adjustments.

- 6 Press the **EXIT** button to return to normal TV viewing.

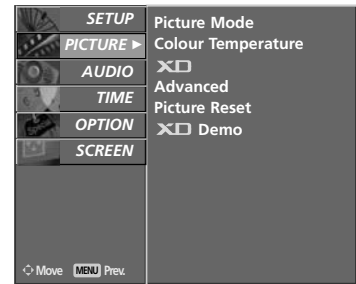

1

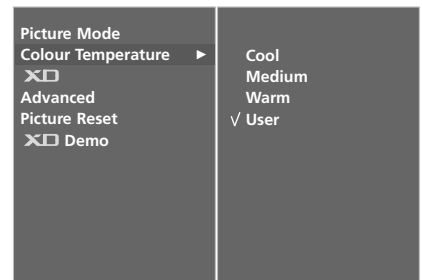

2 3

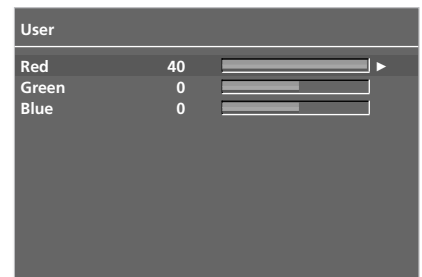

4 5

PICTURE CONTROL

XD - PICTURE IMPROVEMENT TECHNOLOGY

XD is LG electronics unique picture improving technology to display a real HD source through an advanced digital signal processing algorithm.

It is not possible to use this function in RGB[PC] mode.



- 1 Press the **MENU** button and then ▲ or ▼ button to select the **PICTURE** menu.
- 2 Press the ► button and then ▲ or ▼ button to select **XD**.
- 3 Press the ► button and then ▲ or ▼ button to select **Auto** or **Manual**.
- 4 Press the **EXIT** button to return to normal TV viewing.

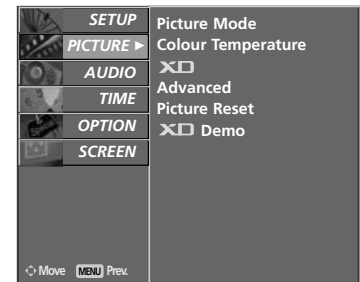

1

* Manual Selection

This menu is activated after selecting **User1** or **User2** in the **Picture Mode**.

- 1 Press the ► button and then ▲ or ▼ button to select **XD Contrast**, **XD Colour**, **XD NR** or **MPEG NR**.
- 2 Press the ◀ or ▶ button to select **On** or **Off**.
- 3 Press the **EXIT** button to return to normal TV viewing.

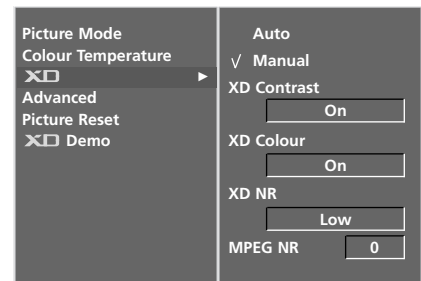

2

- **XD Contrast** : Optimizes the contrast automatically according to the brightness of the reflection.
- **XD Colour** : Adjusts the colour of the reflection automatically to reproduce as close as possible natural colours.
- **XD NR** : Removes interference up to the point where it does not damage the original picture.
- **MPEG NR** : Reduces interference which may appear on the screen while watching the TV.

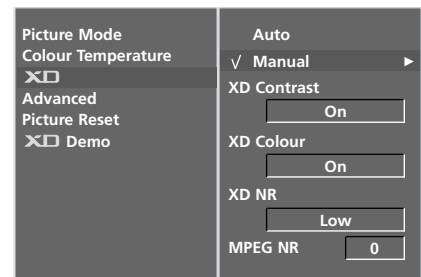

3

XD DEMO

Use it to see the difference between XD Demo on and XD Demo off.

It is not possible to use this function in RGB[PC], HDMI[PC] mode.



- 1 Press the **MENU** button and then **▲** or **▼** button to select the **PICTURE** menu.
- 2 Press the **MENU** button and then **▲** or **▼** button to select **XD Demo**.
- 3 Press the **▶** button to begin **XD Demo**.
- 4 To stop **XD Demo**, press the **MENU** or **EXIT** button.

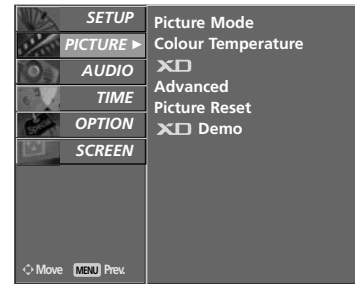

1

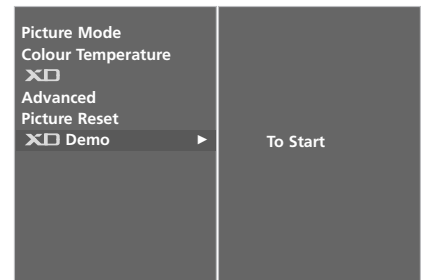

2 3

• XD Demo



PICTURE CONTROL

ADVANCED - CINEMA

To set the TV up for the best picture quality for viewing films.

This feature operates only in DTV, TV, AV, S-Video and Component 480i/576i mode.



- 1 Press the **MENU** button and then **▲** or **▼** button to select the **PICTURE** menu.
- 2 Press the **▶** button and then **▲** or **▼** button to select **Advanced**.
- 3 Press the **▶** button and then **▲** or **▼** button to select **Cinema**.
- 4 Press the **◀** or **▶** button to select **On** or **Off**.
- 5 Press the **EXIT** button to return to normal TV viewing.

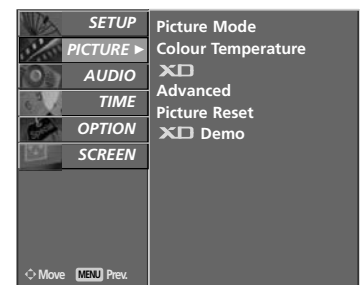

1

ADVANCED - BLACK(DARKNESS) LEVEL

When you view a film this function adjusts the TV to best picture quality.

This function works in the following mode: AV (NTSC-M), S-Video (NTSC-M) or HDMI.

- 1 Press the **MENU** button and then **▲** or **▼** button to select the **PICTURE** menu.
- 2 Press the **▶** button and then **▲** or **▼** button to select **Advanced**.
- 3 Press the **▶** button and then **▲** or **▼** button to select **Black Level**.
- 4 Press the **◀** or **▶** button to select **Auto**, **Low** or **High**.
 - **Low** : The reflection of the screen gets darker.
 - **High** : The reflection of the screen gets brighter.
- 5 Press the **EXIT** button to return to normal TV viewing.

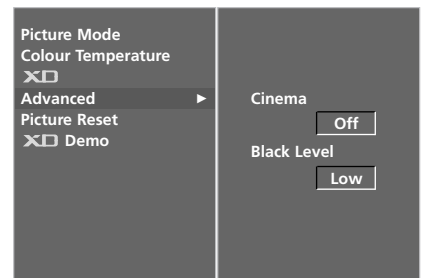

2

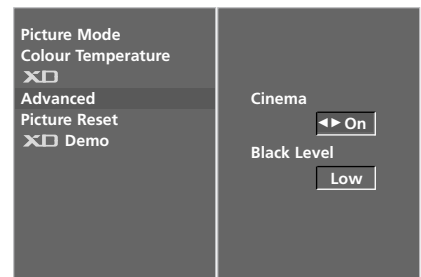

3

! NOTE

- Auto

Realizing the **Black Level** of the screen and set it to **High** or **Low** automatically.

ADVANCED - TRUMOTION (42LG75** only)

It is used for the best picture quality without any motion blur or judder when you enter a quick image or Film Source.
This feature is disable in RGB-PC, HDMI-PC mode.

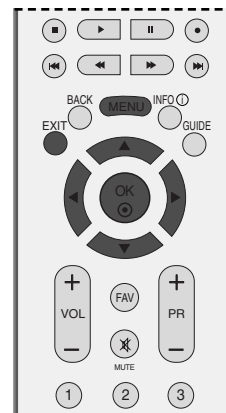

1 Press the **MENU** button and then **▲** or **▼** button to select the **PICTURE** menu.

2 Press the **▶** button and then **▲** or **▼** button to select **Advanced**.

3 Press the **▶** button and then **▲** or **▼** button to select **TruMotion**.

4 Press the **◀** or **▶** button to select **Off, Low** or **High**.

■ **Low** : Provides smooth picture movement. Use this setting for standard use.

■ **High** : Provides smoother picture movement.

■ **Off** : Use this setting when “High” and “Low” setting result in noise.

5 Press the **EXIT** button to return to normal TV viewing.

- If you enable “TruMotion”, noise may appear on the screen.
- If this occurs, set “TruMotion” to “Off”.

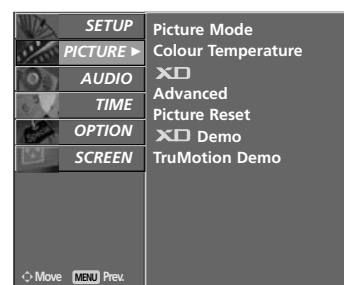

1

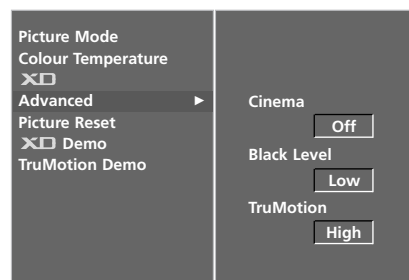

2

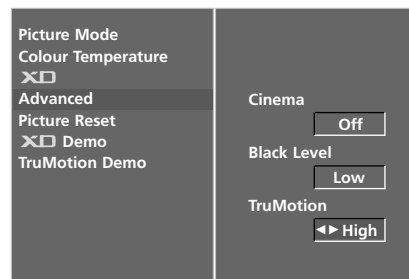

3 4

PICTURE CONTROL

PICTURE RESET

Returns to the default factory setting for Picture Mode, Colour, Temperature, XD and Advanced.

- 1 Press the **MENU** button and then **▲** or **▼** button to select the **PICTURE** menu.
- 2 Press the **▶** button and then **▲** or **▼** button to select **Picture Reset**.
- 3 Press the **▶** button to initialize the adjusted value.

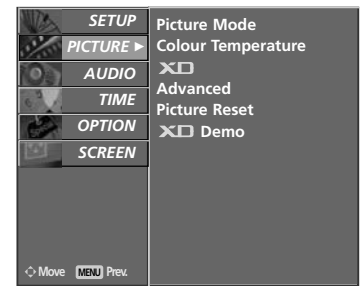

1

TRUMOTION DEMO (42LG75** only)

Use it to see the difference between TruMotion Demo on and TruMotion Demo off.

It's not available to use this function in RGB/HDMI-PC mode.

- 1 Press the **MENU** button and then **▲** or **▼** button to select the **PICTURE** menu.
- 2 Press the **▶** button and then **▲** or **▼** button to select **TruMotion Demo**.
- 3 Press the **▶** button to begin **TruMotion Demo**.
- 4 To stop **TruMotion Demo**, press the **EXIT** button.



2 3

(42LG75** only)

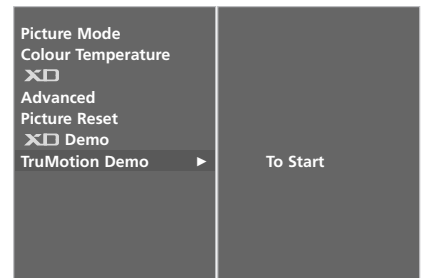

2 3

• TruMotion Demo

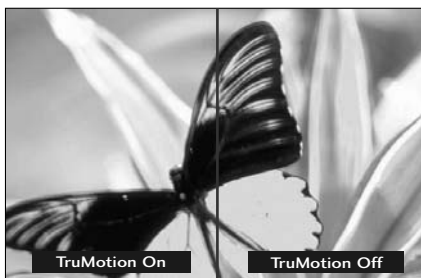

IMAGE STICKING MINIMIZATION (ISM) METHOD

A frozen or still picture from a PC/Video game displayed on the screen for prolonged periods will result in a ghost image remaining even when you change the image. Avoid allowing a fixed image to remain on the screen for prolonged periods.

It is not possible to use this function with LCD TV models.

It is possible to use **Power Indicator** in LCD TV models only.

White wash

White wash removes permanent images from the screen.

Note: An excessive permanent image may be impossible to clear entirely with White Wash.

Orbiter

Orbiter may help prevent ghost images. However, it is best not to allow any fixed image to remain on the screen. To avoid a permanent image on the screen, the screen will move every 2 minutes.

Inversion

This function inverts the panel colour of the screen. The panel colour is automatically inverted every 30 minutes.

- 1 Press the **MENU** button and then **▲** or **▼** button to select the **OPTION** menu.
- 2 Press the **▶** button and then **▲** or **▼** button to select **Factory Mode**.
- 3 Press the **▶** button and then **▲** or **▼** button to select **ISM Method**.
- 4 Press the **◀** or **▶** button to select either **Normal**, **White wash**, **Orbiter** or **Inversion**.
If you do not need this function, set **Normal**.
- 5 Press the **EXIT** button to return to normal TV viewing.

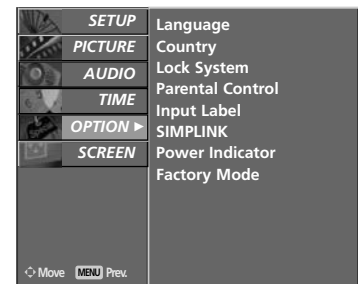

1

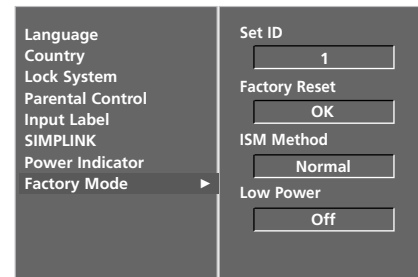

2

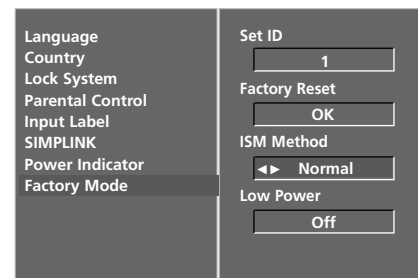

3 4

PICTURE CONTROL

LOW-POWER PICTURE MODE

This function allows you to reduce the power consumption of the TV.

It is not possible to use this function with LCD TV models.

It is possible to use **Power Indicator** in LCD TV models only.



- 1 Press the **MENU** button and then ▲ or ▼ button to select the **OPTION** menu.
- 2 Press the ► button and then ▲ or ▼ button to select **Factory Mode**.
- 3 Press the ► button and then ▲ or ▼ button to select **Low power**.
- 4 Press the ◀ or ▶ button to select **On** or **Off**.
- 5 Press the **EXIT** button to return to normal TV viewing.

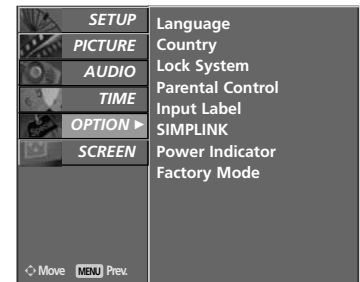

1

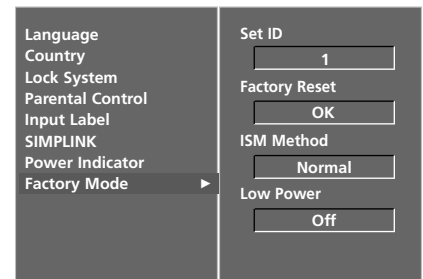

2

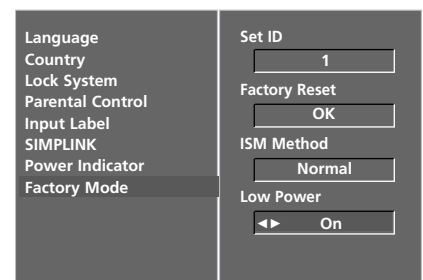

3 4

SOUND & LANGUAGE CONTROL

AUTO VOLUME LEVELER

AVL automatically remains on the same level of volume if you change programmes.



- 1 Press the **MENU** button and then **▲** or **▼** button to select the **AUDIO** menu.
- 2 Press the **▶** button and then **▲** or **▼** button to select **Auto Volume**.
- 3 Press the **▶** button and then **▲** or **▼** button to select **On** or **Off**.
- 4 Press the **EXIT** button to return to normal TV viewing.

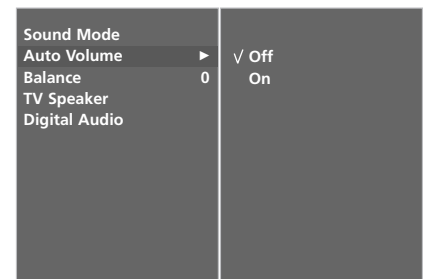
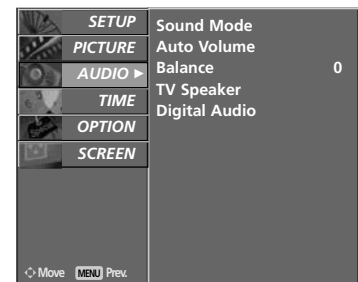

2 3

SOUND & LANGUAGE CONTROL

PRESET SOUND SETTINGS- SOUND MODE

You can select your preferred sound setting; **Surround MAX**, **Standard**, **Music**, **Cinema** or **Sport** and you can also adjust the frequency of the equalizer.

Sound Mode lets you enjoy the best sound without any Special adjustment as the TV sets the appropriate sound options based on the programme content.

Surround MAX, **Standard**, **Music**, **Cinema** and **Sport** are preset for optimum sound quality at the factory and are not adjustable.

Surround MAX Select this option for the most realistic sound.

Standard Commanding and natural audio.

Music Select this option to enjoy the original sound when listening to music.

Cinema Select this option to enjoy sublime sound.

Sport Select this option to watch sport broadcasting.

User Select this option for user-defined audio settings.

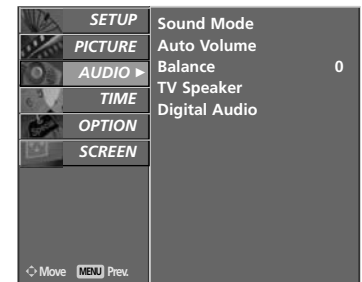

1

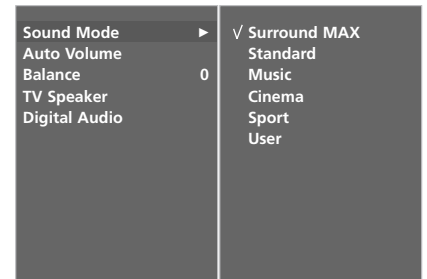

2 3

1 Press the **MENU** button and then **▲** or **▼** button to select the **AUDIO** menu.

2 Press the **▶** button and then **▲** or **▼** button to select **Sound Mode**.

3 Press the **▶** button and then **▲** or **▼** button to select **Surround MAX**, **Standard**, **Music**, **Cinema**, **Sport** or **User**.

4 Press the **EXIT** button to return to normal TV viewing.

SOUND SETTING ADJUSTMENT -USER MODE

Adjusting the audio equalizer.



- 1 Press the **MENU** button and then ▲ or ▼ button to select the **AUDIO** menu.
- 2 Press the ► button and then ▲ or ▼ button to select **Sound Mode**.
- 3 Press the ► button and then ▲ or ▼ button to select **User**.
- 4 Press the ► button.
- 5 Select a frequency band by pressing the ◀ or ▶ button. Set the desired sound level with the ▲ or ▼ button.
- 6 Press the **EXIT** button to return to normal TV viewing.

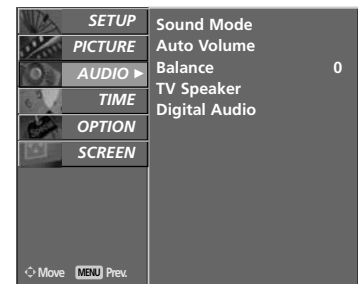

1

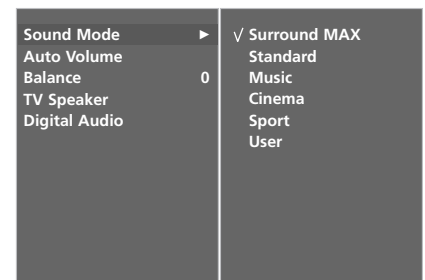

2 3

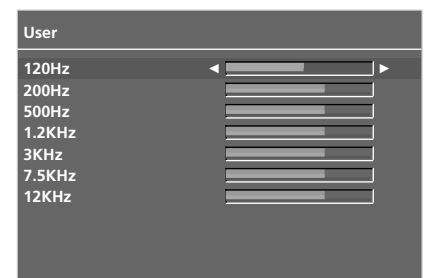

4 5

SOUND & LANGUAGE CONTROL

BALANCE

You can adjust the sound balance of the speakers to preferred levels.



- 1 Press the **MENU** button and then **▲** or **▼** button to select the **AUDIO** menu.
- 2 Press the **▶** button and then **▲** or **▼** button to select **Balance**.
- 3 Press the **▶** button and then **◀** or **▶** button to make desired adjustment.
- 4 Press the **EXIT** button to return to normal TV viewing.

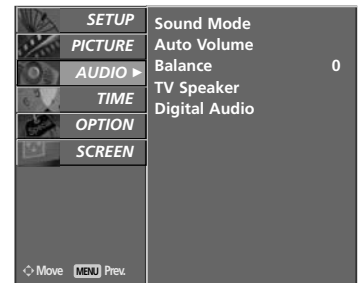

1

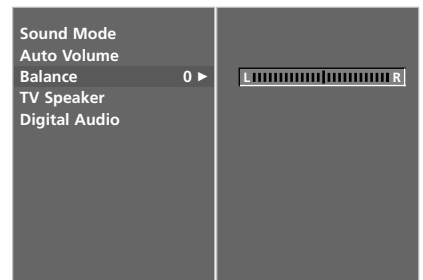

2 3

TV SPEAKERS ON/ OFF SETUP

You can adjust the internal speaker status.

In **AV1**, **AV2**, **AV3**, **COMPONENT**, **RGB** and **HDMI1** with HDMI to DVI cable, the TV speaker can be operational even when there is no video signal.

If you wish to use an external hi-fi system, turn off the TV internal speakers.



- 1 Press the **MENU** button and then ▲ or ▼ button to select the **AUDIO** menu.
- 2 Press the ► button and then ▲ or ▼ button to select **TV Speaker**.
- 3 Press the ► button and then ▲ or ▼ button to select **On** or **Off**.
- 4 Press the **EXIT** button to return to normal TV viewing.

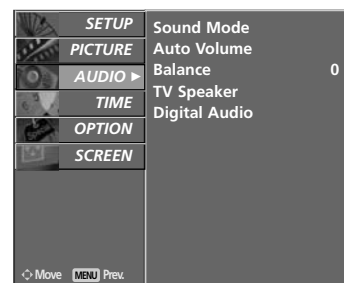

1

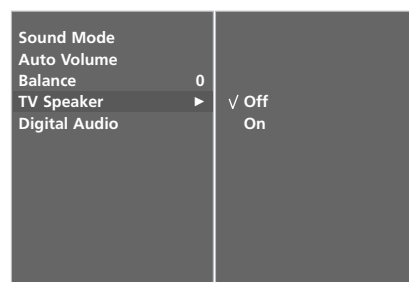

2 3

SOUND & LANGUAGE CONTROL

SELECTING DIGITAL AUDIO

It is a feature to set input and output of TV sound.

In order to deliver sound data intact, you should transform TV sound into digital signals and transfer them to audio decoder or digital speaker.

This feature is not available in ordinary analogue speakers and is available only for audio decoders or digital speakers embedded with audio decoder.



Manufactured under license from Dolby Laboratories. 'Dolby' and the 'double-D' symbol are trademarks of Dolby Laboratories.

- 1 Press the **MENU** button and then **▲** or **▼** button to select the **AUDIO** menu.
- 2 Press the **▶** button and then **▲** or **▼** button to select **Digital Audio**.
- 3 Press the **▶** button and then **▲** or **▼** button to select **Input**.
- 4 Press the **◀** or **▶** button to select **MPEG, Dolby Digital, HE-AAC** or **Dolby Digital Plus**.
- 5 Press the **▲** or **▼** button to select **Output**.
- 6 Press the **◀** or **▶** button to select **PCM** or **Bitstream**.
- 7 Press the **EXIT** button to return to normal TV viewing.

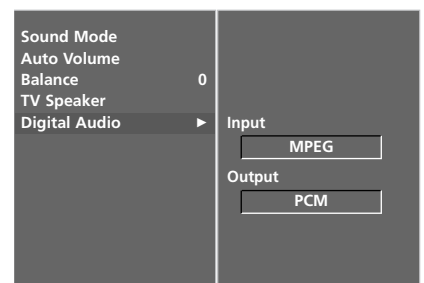
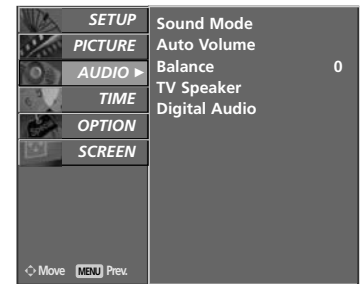

- 2
- 3
- 4
- 5
- 6

I/II

Stereo/Dual Reception (In Analogue Mode Only)

When a programme is selected, the sound information for the station appears after the programme number and station name disappear.

Broadcast	On Screen Display
Mono	MONO
Stereo	STEREO
Dual	DUAL I

■ Mono sound selection

If the stereo signal is weak in stereo reception, you can switch to mono by pressing the I/II button twice. In mono reception, the clarity of sound is improved. To switch back to stereo, press the I/II button twice.

■ Language selection for dual language broadcast

If a programme can be received in two languages (dual language), you can switch to **DUAL I**, **DUAL II** or **DUAL I+II** by pressing the I/II button repeatedly.

DUAL I Sends the primary broadcast language to the loudspeakers.

DUAL II Sends the secondary broadcast language to the loudspeakers.

DUAL I+II Sends a separate language to each loudspeaker.

SOUND & LANGUAGE CONTROL

NICAM Reception (In Analogue Mode Only)

If the TV is equipped with a receiver for NICAM reception, high quality NICAM (Near Instantaneous Companding Audio Multiplex) digital sound can be received.

Sound output can be selected according to the type of broadcast received by pressing the **I/II** button repeatedly.

-
- 1** When **NICAM MONO** is received, you can select **NICAM MONO** or **FM MONO**.
 - 2** When **NICAM STEREO** is received, you can select **NICAM STEREO** or **FM MONO**.
If the stereo signal is weak, switch to **FM MONO**.
 - 3** When **NICAM DUAL** is received, you can select **NICAM DUAL I**, **NICAM DUAL II** or **NICAM DUAL I+II** or **MONO**.
-

Speaker Sound Output Selection

In AV, S-Video, Component, RGB and HDMI mode, you can select output sound for the left and right loudspeakers.

Repeatedly press the **I/II** button to select the sound output.

L+R: Audio signal from audio L input is sent to the left loud speaker and audio signal from audio R input is sent to the right loud speaker.

L+L: Audio signal from audio L input is sent to left and right loud speakers.

R+R: Audio signal from audio R input is sent to left and right loud speakers.

ON-SCREEN MENU LANGUAGE

The installation guide menu appears on the TV screen when it is switched on for the first time.



-
- 1 Press the ▲ or ▼ button and then, OK button to select your desired language.
-

* If you want to change Language selection

- 1 Press the **MENU** button and then ▲ or ▼ button to select the **OPTION** menu.
 - 2 Press the ► button and then ▲ or ▼ button to select **Language**.
 - 3 Press the ► button and then ▲ or ▼ button to select **Menu**.
 - 4 Press the ◀ or ▶ button to select your desired language. The menus can be shown on the screen in the selected language.
 - 5 Press the OK button.
 - 6 Press the **EXIT** button to return to normal TV viewing.
-

! NOTE

- ▶ If you do not finish the set-up **Installation Guide** by pressing **EXIT** or if you time out on the OSD (On Screen Display) the installation menu will continuously appear until the set up is completed whenever the TV is switched on.

SOUND & LANGUAGE CONTROL

LANGUAGE SELECTION (IN DIGITAL MODE ONLY)

The Audio function allows selection of a preferred language. If audio data in a selected language is not broadcast, the default language audio will be played.

Use the Subtitle function when two or more subtitle languages are broadcast. If subtitle data in a selected language is not broadcast, the default language subtitle will be displayed.

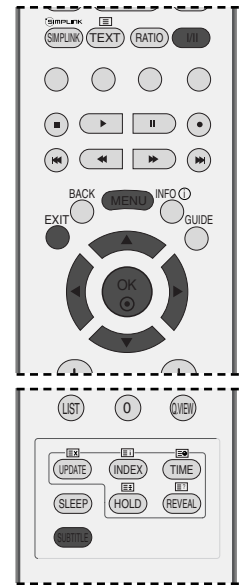

- 1 Press the **MENU** button and then **▲** or **▼** button to select the **OPTION** menu.
- 2 Press the **▶** button and then **▲** or **▼** button to select **Language**.
- 3 Press the **▶** button and then **▲** or **▼** button to select **Audio, Subtitle** or **Subtitle Hard of hearing**.
- 4 Press the **▶** button and then **◀** or **▶** button to select your desired language.
- 5 Press the **EXIT** button to return to normal TV viewing.

! NOTE

< Audio Language Selection >

- ▶ When two or more audio languages are broadcast, you can select the audio language with the **I/II** button on the remote control.
- ▶ Press the **▲** or **▼** button to select an audio language.
- ▶ Press the **◀** or **▶** button to select L+R, L+L or R+R.

< Subtitle Language Selection >

- ▶ When two or more subtitle languages are broadcast, you can select the subtitle language with the **SUBTITLE** button on the remote control.
- ▶ Press the **▲** or **▼** button to select a subtitle language.

- The audio/subtitles can be displayed in a simpler form with 1 to 3 characters broadcast by the service provider.
- When you select supplementary Audio (Audio for "Visual/Hearing Impaired") the TV may output a part of the Main audio.

Audio Language OSD Information

Display	Status
N.A	Not Available
	Audio for "Visual Impaired"
	Dolby Digital Audio
	HE-AAC Audio
	Dolby Digital Plus Audio

Subtitle Language OSD Information

Display	Status
N.A	Not Available
	Teletext Subtitle
	Subtitle for "Hard of Hearing"

TIME SETTING

CLOCK SETUP

The clock is set automatically when receiving a digital signal. (You can set the clock manually only if the TV has no DTV signal.)

You must set the time correctly before using on/off timer function.



1 Press the **MENU** button and then ▲ or ▼ button to select the **TIME** menu.

2 Press the ► button and then ▲ or ▼ button to select **Clock**.

3 Press the ► button and then ◀ or ▶ button to select either the year, date or time option.

Once selected, use the ▲ or ▼ button to set the year, date, and time options.

4 Press the **EXIT** button to return to normal TV viewing.

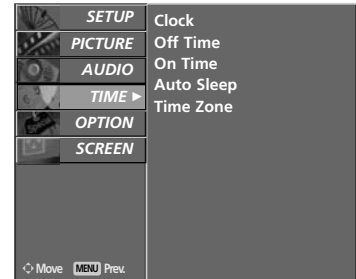

1

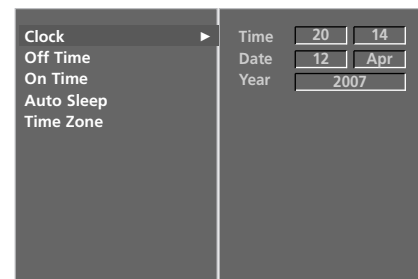

2 3

TIME SETTING

AUTO ON/OFF TIMER SETTING

The Off time function automatically switches the TV to standby at a preset time.

Two hours after the TV is switched on by the on time function it will automatically switch back to standby mode unless a button has been pressed.

Once the on time/off time is set, these functions operate daily at the preset time.

The Off time function overrides the On timer function if both are set to the same time.

The TV must be in standby mode for the On timer to work.

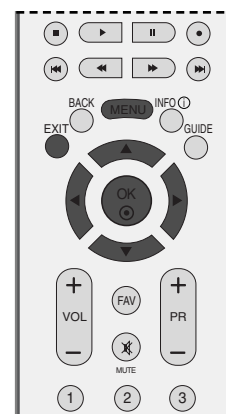

1 Press the **MENU** button and then **▲** or **▼** button to select the **TIME** menu.

2 Press the **▶** button and then **▲** or **▼** button to select **Off Time/On Time**.

3 Press the **▶** button and then **▲** or **▼** button to select **On**.

- To cancel **On/Off Time** function, select **Off**.

4 Press the **▶** button and then **▲** or **▼** button to set the hour.

5 Press the **▶** button and then **▲** or **▼** button to set the minutes.

6 For On Time function only

- **Programme:** Press the **▶** button and then **▲** or **▼** button to select **TV, DTV** or **Radio** in the **Mode** menu. And then, Press the **▶** button and then **▲** or **▼** button to select the programme.

- **Volume:** Press the **▶** button and then **▲** or **▼** button to adjust volume level at switch-on.

7 Press the **EXIT** button to return to normal TV viewing.

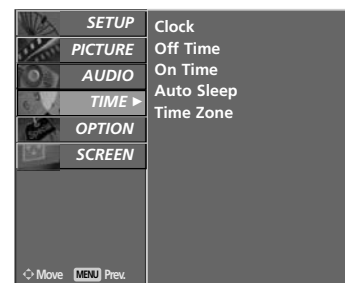

1

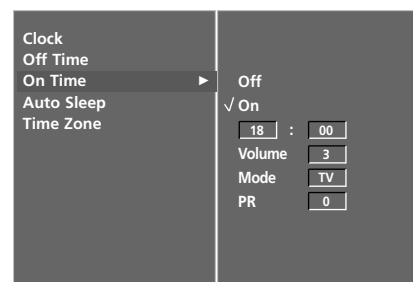

2 3 4 5 6

AUTO SHUT-OFF SETTING

If the TV is switched on and there is no input signal, it will switch off automatically after 10 minutes.



- 1 Press the **MENU** button and then **▲** or **▼** button to select the **TIME** menu.
- 2 Press the **▶** button and then **▲** or **▼** button to select **Auto Sleep**.
- 3 Press the **▶** button and then **▲** or **▼** button to select **On** or **Off**.
- 4 Press the **EXIT** button to return to normal TV viewing.

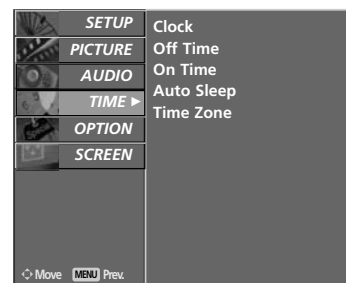

1



2 3

TIME SETTING

TIME ZONE SETUP

TV time is set **Paris GMT +1** when time is set automatically by a digital signal.

You can not select another time zone.

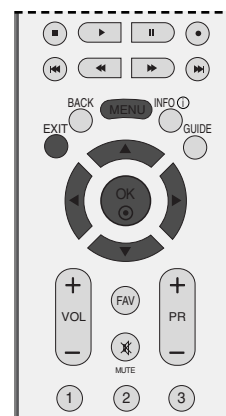

1 Press the **MENU** button and then **▲** or **▼** button to select the **TIME** menu.

2 Press the **▶** button and then **▲** or **▼** button to select **Time Zone**.

It will be displayed **Paris GMT +1**.

3 Press the **EXIT** button to return to normal TV viewing.

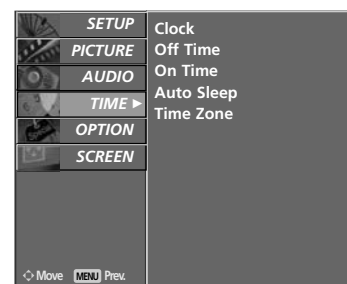

SLEEP TIMER SETTING

You do not have to remember to switch the TV off before you go to sleep.

The sleep timer automatically switches the TV to standby after the preset time has elapsed.

a Press the **SLEEP** button repeatedly to select the number of minutes.

The display ' - - - **Min** ' will appear on the screen, followed by **10, 20, 30, 60, 90, 120, 180** and **240**.

b When the number of minutes required is displayed on the screen, the timer begins to count down from the number of minutes selected.

c To view the remaining sleep time, press the **SLEEP** button once.

d To cancel the sleep time, repeatedly press the **SLEEP** button until the display ' - - - **Min** ' appears.

e When you switch the TV off, the preset sleep time is cancelled.

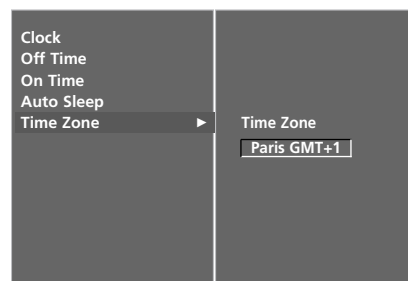

PARENTAL CONTROL / RATINGS

SET PASSWORD & LOCK SYSTEM

Enter the password, press '0', '0', '0', '0' on the remote control handset.



1 Press the **MENU** button and then **▲** or **▼** button to select the **OPTION** menu.

2 Press the **▶** button and then **▲** or **▼** button to select **Lock System**.

3 Press the **▶** button and then **◀** or **▶** button to select **On**.

To set the password

Press the **▼** button and then use the **NUMBER** buttons to input a 4-digit password.

Be sure to remember this number!

Re-enter new password for confirm.

If you forget your password, press '7', '7', '7', '7' on the remote control handset.

4 Press the **EXIT** button to return to normal TV viewing.

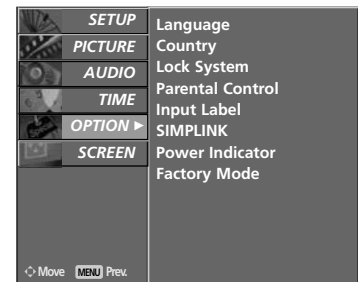

1

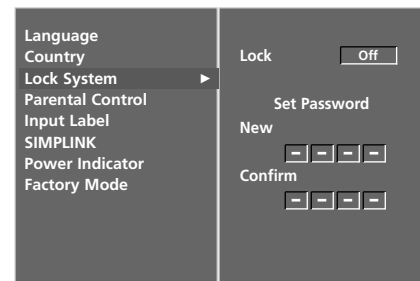

2 3

PARENTAL CONTROL / RATINGS

PARENTAL CONTROL

This function operates according to information from the broadcasting station. Therefore if the signal has incorrect information, this function does not operate.

This allows you to set up blocking schemes to block specific channels and ratings.

A password is required to gain access to this menu.

This TV is programmed to remember which option it was last set to even if you switch the TV off.



1 Press the **MENU** button and then **▲** or **▼** button to select the **OPTION** menu.

2 Press the **▶** button and then **▲** or **▼** button to select **Parental Control**.
Then, press the **▶** button to enter the password as requested.
The TV is set up with the initial password "0-0-0-0".

3 Press the **▶** button and then **▲** or **▼** button to select **Parental Guidance** or **Key Lock**.

Parental Guidance (In Digital Mode only)

Prevents children from watching certain adult's TV programmes, according to the ratings limit set.

Key Lock

The TV can be set so that the remote control is required to control it. This feature can be used to prevent unauthorized viewing.

4 Press the **◀** or **▶** button to make appropriate adjustments.

5 Press the **EXIT** button to return to normal TV viewing.

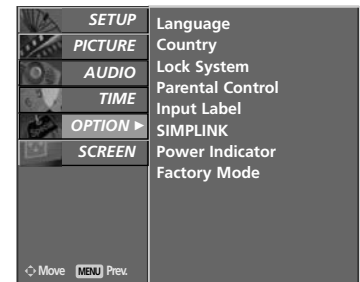

1

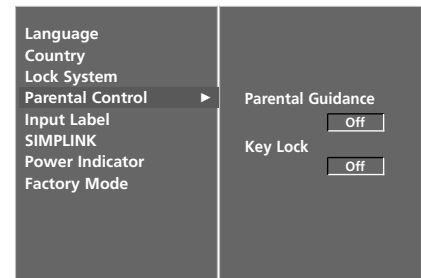

2 3 4

In **Key Lock 'On'**, if the TV is turned off, press the **⏻ / I**, **INPUT**, **PR ▲** or **▼** button on the TV or **POWER**, **INPUT**, **D/A TV**, **PR +** or **-** or **NUMBER** buttons on the remote control.

With the **Key Lock On**, the display '**Key Lock On**' appears on the screen if any button on the front panel is pressed while viewing the TV.

TELETEXT

This feature is not available in all countries.

Teletext is a free service broadcast by most TV stations which gives up-to-the-minute information on news, weather, television programmes, share prices and many other topics.

The teletext decoder of this TV can support the SIMPLE, TOP and FASTEXT systems. SIMPLE (standard teletext) consists of a number of pages which are selected by directly entering the corresponding page number. TOP and FASTEXT are more modern methods allowing quick and easy selection of teletext information.

SWITCH ON/OFF

Press the **TEXT** button to switch to teletext. The initial page or last page viewed appears on the screen.

Two page numbers, TV station name, date and time are displayed on the screen headline. The first page number indicates your selection, while the second shows the current page displayed.

Press the **TEXT** or **EXIT** button to switch off teletext. The previous mode reappears.

SIMPLE TEXT

■ Page selection

- 1 Enter the desired page number as a three digit number with the NUMBER buttons. If during selection you press a wrong number, you must complete the three digit number and then re-enter the correct page number.
- 2 The **PR+** or **-** button can be used to select the preceding or following page.

TOP TEXT

The user guide displays four fields-red, green, yellow and blue at the bottom of the screen. The yellow field denotes the next group and the blue field indicates the next block.

■ Block / group / page selection

- 1 With the blue button you can progress from block to block.
- 2 Use the yellow button to proceed to the next group with automatic overflow to the next block.
- 3 With the green button you can proceed to the next existing page with automatic overflow to the next group. Alternatively the **PR+** button can be used.
- 4 The red button returns to the previous selection. Alternatively the **PR-** button can be used.

■ Direct page selection

As with SIMPLE teletext mode, you can select a page by entering it as a three digit number using the NUMBER buttons in TOP mode.

TELETEXT

FASTEXT

The teletext pages are colour coded along the bottom of the screen and are selected by pressing the corresponding coloured button.

■ Page selection

- 1 Press the  button to select the index page.
- 2 You can select the pages which are colour coded along the bottom line with corresponding coloured buttons.
- 3 AS with SIMPLE teletext mode, you can select a page by entering its three digit page number with the NUMBER buttons in FASTEXT mode.
- 4 The PR+ or - button can be used to select the preceding or following page.

SPECIAL TELETEXT FUNCTIONS



■ REVEAL

Press this button to display concealed information, such as solutions to riddles or puzzles.
Press this button again to remove the information from the display.



■ UPDATE

Displays the TV picture on the screen while waiting for a new teletext page. The display will appear at the top left hand corner of the screen. When the updated page is available then display will change to the page number.
Press this button again to view the updated teletext page.



■ TIME

When viewing a TV programme, press this button to display the time at the top right hand corner of the screen.
Press this button again to remove the display. In the teletext mode, press this button to select a sub page number. The sub page number is displayed at the bottom of the screen. To hold or change the sub page, press the RED/GREEN, PR+ or - or NUMBER buttons.
Press again to exit this function.



■ HOLD

Stops the automatic page change which will occur if a teletext page consists of 2 or more sub pages. The number of sub pages and the sub page displayed is, usually, shown on the screen below the time. When this button is pressed the stop symbol is displayed at the top left-hand corner of the screen and the automatic page change is inactive. To continue press this button again.

APPENDIX

TROUBLESHOOTING

The TV does not operate properly.

The remote control does not work	<ul style="list-style-type: none">■ Check to see if there is any object between the TV and the remote control causing an obstruction. Ensure you are pointing the remote control directly at the TV.■ Ensure that the batteries are installed with correct polarity (+ to +, - to -).■ Ensure that the correct remote operating mode is set: TV, VCR etc.■ Install new batteries.
Power is suddenly turned off	<ul style="list-style-type: none">■ Is the sleep timer set?■ Check the power control settings. Has the Power supply been interrupted.■ Is Auto sleep activated on this station?

The video function does not work.

No picture & No sound	<ul style="list-style-type: none">■ Check whether the TV is switched on.■ Try another channel. The problem may be with the broadcast.■ Is the power cord inserted correctly into the mains?■ Check your antenna direction and/or location.■ Test the mains outlet by plugging another TV into the same outlet.
Picture appears slowly after switching on	<ul style="list-style-type: none">■ This is normal, the image is muted during the TV startup process. Please contact your service centre, if the picture has not appeared after five minutes.
No or poor colour or poor picture	<ul style="list-style-type: none">■ Adjust Colour in menu option.■ Allow a sufficient distance between the TV and the VCR.■ Try another channel. The problem may be with the broadcast.■ Are the video cables installed properly?■ Activate any function to restore the brightness of the picture.
Horizontal/vertical bars or picture shaking	<ul style="list-style-type: none">■ Check for local interference such as an electrical appliance or power tool.
Poor reception on some channels	<ul style="list-style-type: none">■ Station or cable channel experiencing problems, tune to another station.■ Station signal is weak, reposition the antenna to receive weaker stations.■ Check for sources of possible interference.
Lines or streaks in pictures	<ul style="list-style-type: none">■ Check antenna (Change the position of the antenna).
No picture when connecting HDMI	<ul style="list-style-type: none">■ Check HDMI cable over version 1.3. If the HDMI cables don't support HDMI version 1.3, it can cause flickers or no screen display. In this case use the latest cables that support HDMI version 1.3.

APPENDIX

The audio function does not work.

Picture OK & No sound	<ul style="list-style-type: none"> ■ Press the VOL + or - button. ■ Sound muted? Press MUTE button. ■ Try another channel. The problem may be with the broadcast. ■ Are the audio cables installed properly?
No output from one of the speakers	<ul style="list-style-type: none"> ■ Adjust Balance in menu option.
Unusual sound from inside the TV	<ul style="list-style-type: none"> ■ A change in ambient humidity or temperature may result in an unusual noise when the TV is switched on or off and does not indicate a fault with the TV.
No sound when connecting HDMI or USB	<ul style="list-style-type: none"> ■ Check HDMI cable over version 1.3. ■ Check USB cable over version 2.0.

*This feature is not available for all models.

There is a problem in PC mode. (Only PC mode applied)

The signal is out of range (Invalid format)	<ul style="list-style-type: none"> ■ Adjust resolution, horizontal frequency or vertical frequency. ■ Check the input source.
Vertical bar or stripe on background & Horizontal Noise & Incorrect position	<ul style="list-style-type: none"> ■ Use Auto configure or adjust clock, phase or H/V position. (Option)
Screen colour is unstable or single colour	<ul style="list-style-type: none"> ■ Check the signal cable. ■ Reinstall the PC video card.

MAINTENANCE

Early malfunctions can be prevented. Careful and regular cleaning can prolong the life of your new TV.

Caution: Be sure to switch the power off and unplug the power cord before you begin any cleaning.

Cleaning the Screen

- 1 A good way to keep the dust off your screen for a while is to wet a soft cloth in a mixture of lukewarm water and a little fabric softener or dish washing detergent. Wring the cloth until it is almost dry, and then use it to wipe the screen.
- 2 Ensure there is no excess water on the screen. Allow any water or dampness to evaporate before switching on.

Cleaning the Cabinet

- To remove dirt or dust, wipe the cabinet with a soft, dry, lint-free cloth.
- Do not to use a wet cloth.

Extended Absence

CAUTION

- ▶ If you expect to leave your TV dormant for prolonged periods (such as a holiday), unplug the power cord to protect against possible damage from lightning or power surges.

APPENDIX

PRODUCT SPECIFICATIONS

MODELS		32LG55**	37LG55**	42LG55**
		32LG5500-ZB	37LG5500-ZB	42LG5500-ZB
Dimensions (Width x Height x Depth)	with stand	813.8 x 598.8 x 231.9 mm 32.1 x 23.6 x 9.2 inches	936.4 x 684.4 x 293.8 mm 36.9 x 270 x 11.6 inches	1032.0 x 894.8 x 293.8 mm 40.7 x 35.3 x 11.6 inches
	without stand	813.8 x 540.4 x 95.5 mm 32.1 x 21.3 x 3.8 inches	936.4 x 612.8 x 88.0 mm 36.9 x 24.2 x 3.5 inches	1032.0 x 662.3 x 89.0 mm 40.7 x 26.1 x 3.5 inches
Weight	with stand	14.1 kg / 31.1 lbs	18.3 kg / 40.4 lbs	22.5 kg / 49.6 lbs
	without stand	12.6 kg / 27.8 lbs	15.6 kg / 34.4 lbs	20.0 kg / 44.1 lbs
Power requirement		AC100-240V~ 50/60Hz 1.7A	AC100-240V~ 50/60Hz 1.8A	AC100-240V~ 50/60Hz 2.2A
Power Consumption		170W	180W	220W
MODELS		47LG55**	52LG55**	42LG75**
		47LG5500-ZB	52LG5500-ZB	42LG7500-ZB
Dimensions (Width x Height x Depth)	with stand	1156.2 x 813.1 x 342.9 mm 45.6 x 32.0 x 13.5 inches	1291.7 x 892.17 x 342.9 mm 50.9 x 35.2 x 13.5 inches	1026.2 x 734.0 x 293.4 mm 40.4 x 28.9 x 11.6 inches
	without stand	1156.2 x 739.2 x 103.0 mm 45.6 x 29.1 x 4.1 inches	1291.7 x 817.0 x 115.3 mm 50.9 x 32.2 x 4.6 inches	1026.2 x 687.9 x 111.8 mm 40.4 x 27.1 x 4.4 inches
Weight	with stand	29.2 kg / 64.4 lbs	39.5 kg / 87.1 lbs	23.2 kg / 51.2 lbs
	without stand	24.6 kg / 54.3 lbs	34.9 kg / 77.0 lbs	20.5 kg / 45.2 lbs
Power requirement		AC100-240V~ 50/60Hz 3.0A	AC100-240V~ 50/60Hz 3.3A	AC100-240V~ 50/60Hz 2.3A
Power Consumption		300W	330W	230W
Television System		PAL/SECAM B/G/D/K, PAL I/II, SECAM L/L'		
Program Coverage		VHF: E2 ~ E12, UHF: E21 ~ E69, CATV: S1 ~ S20, HYPER: S21 ~ S47		
External Antenna Impedance		75 Ω		
Environment condition	Operating Temperature	0 ~ 40°C / 32 ~ 104°F		
	Operating Humidity	Less than 80%		
	Storage Temperature	-20 ~ 60°C / -4 ~ 140°F		
	Storage Humidity	Less than 85%		

■ The specifications shown above may be changed without prior notice for quality improvement.

MODELS		42PG35**	50PG35**	42PG65**
		42PG3500-ZA	50PG3500-ZA	42PG6500-ZA
Dimensions (Width x Height x Depth)	with stand	1039.5 x 726.0 x 307.6 mm 41.0 x 28.6 x 12.1 inches	1232.0 x 850.0 x 363.6 mm 48.5 x 33.5 x 14.4 inches	1044.0 x 735.4 x 308.0 mm 41.1 x 29.0 x 12.2 inches
	without stand	1039.5 x 673.7 x 84.0 mm 41.0 x 26.6 x 3.3 inches	1232.0 x 793.0 x 84.0 mm 48.5 x 31.2 x 3.3 inches	1044.0 x 680.6 x 79.6 mm 41.1 x 26.8 x 3.2 inches
Weight	with stand	28.0 kg / 61.8 lbs	42.3 kg / 93.3 lbs	27.8 kg / 61.3 lbs
	without stand	25.0 kg / 55.1 lbs	38.3 kg / 84.5 lbs	25 kg / 55.2 lbs
Power requirement		AC100-240V~ 50/60Hz 3.1A	AC100-240V~ 50/60Hz 4.2A	AC100-240V~ 50/60Hz 3.2A
Power Consumption		310W	420W	320W
MODELS		50PG65**	50PG45**	50PG75**
		50PG6500-ZA	50PG4500-ZA	50PG7500-ZB
Dimensions (Width x Height x Depth)	with stand	1235.6 x 849.3 x 364.1 mm 48.7 x 33.5 x 14.4 inches	1232.0 x 850.0 x 363.6 mm 48.5 x 33.5 x 14.4 inches	1235.6 x 849.3 x 364.1 mm 48.7 x 33.5 x 14.4 inches
	without stand	1235.6 x 792.8 x 79.6 mm 48.7 x 31.3 x 3.2 inches	1232.0 x 793.0 x 84.0 mm 48.5 x 31.2 x 3.3 inches	1235.6 x 792.8 x 79.6 mm 48.7 x 31.3 x 3.2 inches
Weight	with stand	43.7 kg / 96.4 lbs	42.3 kg / 93.3 lbs	45.7 kg / 100.8 lbs
	without stand	39.7 kg / 87.6 lbs	38.3 kg / 84.5 lbs	41.7 kg / 92.0 lbs
Power requirement		AC100-240V~ 50/60Hz 4.5A	AC100-240V~ 50/60Hz 5.2A	AC100-240V~ 50/60Hz 5.2A
Power Consumption		450W	520W	520W
Television System		PAL/SECAM B/G/D/K, PAL I/II, SECAM L/L'		
Program Coverage		VHF: E2 ~ E12, UHF: E21 ~ E69, CATV: S1 ~ S20, HYPER: S21 ~ S47		
External Antenna Impedance		75 Ω		
Environment condition	Operating Temperature	0 ~ 40°C / 32 ~ 104°F		
	Operating Humidity	Less than 80%		
	Storage Temperature	-20 ~ 60°C / -4 ~ 140°F		
	Storage Humidity	Less than 85%		

■ The specifications shown above may be changed without prior notice for quality improvement.

APPENDIX

PROGRAMMING THE REMOTE CONTROL

The remote control is a multi brand or universal remote. It can be programmed. to operate most remote controlled devices from other manufacturers.

Note that the remote control may not control all models from other brands.

Programming a code into a remote mode

- 1** Testing your remote control.
To find out whether your remote control can operate other components without programming, turn on a component such as a VCR and press the corresponding mode button (such as a DVD or VCR) on the remote control, while pointing at the component. Test the **POWER** and **PR +** or **-** buttons to see if the component responds correctly. If the component does not operate correctly, the remote control requires programming to operate the device.
- 2** Switch on the component to be programmed, then press the corresponding mode button (such as DVD or VCR) on the remote control. The remote control button of the desired device is illuminated.
- 3** Press the **MENU** and **MUTE** buttons simultaneously, the remote control is ready to be programmed with the code.
- 4** Enter a code number using the number buttons on the remote control.
Programming code numbers for the corresponding component can be found on the following pages. If the code is correct, the device will turn off.
- 5** Press the **MENU** button to store the code.
- 6** Test the remote control functions to see if the component responds correctly. If not, repeat from step 2.

DVD

Brand	Codes	Brand	Codes	Brand	Codes
APEX DIGITAL	022	mitsubishi	002	RCA	005 006
DENON	020 014	NAD	023	SAMSUNG	011 015
GE	005 006	ONKYO	008 017	SONY	007
HARMAN KARDON	027	PANASONIC	003 009	THOMPSON	005 006
JVC	012	PHILIPS	013	TOSHIBA	019 008
LG	001 010 016 025	PIONEER	004 026	YAMAHA	009 018
MAGNAVOX	013	PROCEED	021	ZENITH	010 016 025
MARANTZ	024	PROSCAN	005 006		

VCR

Brand	Codes	Brand	Codes	Brand	Codes
AIWA	034	MAGNAVOX	031 033 034 041	SAMSUNG	032 040 102 104
AKAI	016 043 046 124 125 146	MARANTZ	067 068 012 031 033 067 069		105 107 109 112 113 115 120 122 125
AMPRO	072	MARTA	101	SANSUI	022 043 048 135
ANAM	031 033 103	MATSUI	027 030	SANYO	003 007 010 014 102 134
AUDIO DYNAMICS	012 023 039 043	MEI	031 033	SCOTT	017 037 112 129 131
BROKSONIC	035 037 129	MEMOREX	003 010 014 031 033 034 053 072 101 102 134 139	SEARS	003 008 009 010 013 014 017 020 031 042 073 081 101
CANON	028 031 033	MGA	045 046 059	SHARP	031 054 149
CAPEHART	108	MINOLTA	013 020	SHINTOM	024
CRAIG	003 040 135	MITSUBISHI	013 020 045 046 049 051 059 061 151	SONY	003 009 031 052 056 057 058 076 077 078 149
CURTIS MATHES	031 033 041	MTC	034 040	SOUNDESIGN	034
DAEWOO	005 007 010 064 065 108 110 111 112 116 117 119	MULTITECH	024 034	STS	013
DAYTRON	108	NEC	012 023 039 043 048	SYLVANIA	031 033 034 059 067
DBX	012 023 039 043	NORDMENDE	043	SYMPHONIC	034
DYNATECH	034 053	OPTONICA	053 054	TANDY	010 034
ELECTROHOME	059	PANASONIC	066 070 074 083 133 140 145	TATUNG	039 043
EMERSON	006 017 025 027 029 031 034 035 036 037 046 101 129 131 138 153	PHILCO	013 020 031 033 063	TEAC	034 039 043
FISHER	003 008 009 010	PHILIPS	031 034 067 031 033 034 054 067 071 101	TECHNICS	031 033 070
FUNAI	034	PILOT	101	TEKNIKA	019 031 033 034 101
GE	031 033 063 072 107 109 144 147	PIONEER	013 021 048	THOMAS	034
GO VIDEO	132 136	PORTLAND	108	TMK	006
HARMAN KARDON	012 045	PULSAR	072	TOSHIBA	008 013 042 047 059 082 112 131
HITACHI	004 018 026 034 043 063 137 150	QUARTZ	011 014	TOTEVISION	040 101
INSTANTREPLAY	031 033	QUASAR	033 066 075 145	UNITECH	040
JCL	031 033	RCA	013 020 033 034 040 041 062 063 107 109 140 144 145 147	VECTOR RESEARCH	012
JCPENNY	012 013 015 033 040 066 101	REALISTIC	003 008 010 014 031 033 034 040 053 054 101	VICTOR	048
JENSEN	043	RICO	058	VIDEO CONCEPTS	012 034 046
JVC	012 031 033 043 048 050 055 060 130 150 152	RUNCO	148	VIDEOSONIC	040
KENWOOD	014 034 039 043 047 048	SALORA	014	WARDS	003 013 017 024 031 033 034 040 053 054 131
LG (GOLDSTAR)	001 012 013 020 101 106 114 123			YAMAHA	012 034 039 043
LLOYD	034			ZENITH	034 048 056 058 072 080 101
LXI	003 009 013 014 017 034 101 106				
MAGIN	040				

APPENDIX

IR CODES

1. How to Connect

- Connect your wired remote control to the Remote Control port on the TV.

2. Remote Control IR Codes

■ Output waveform

Single pulse, modulated with 37.917KHz signal at 455KHz

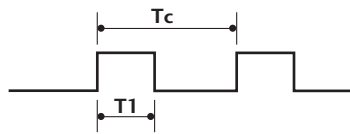

Carrier frequency
 $FCAR = 1/TC = fOSC/12$
 Duty ratio = $T1/TC = 1/3$

■ Configuration of frame

1st frame



Repeat frame

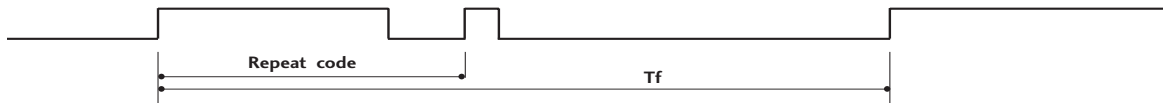

■ Lead code

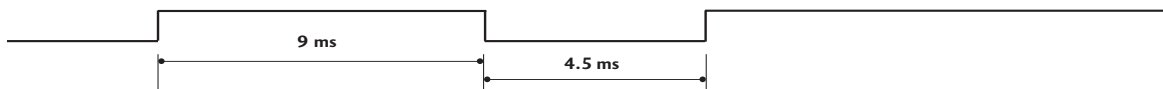

■ Repeat code

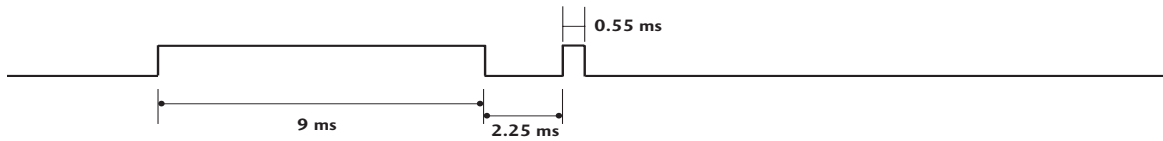

■ Bit description



■ Frame interval: Tf

The waveform is transmitted as long as a key is depressed.



Code (Hexa)	Function	Note
00	PR +	R/C BUTTON
01	PR -	R/C BUTTON
02	VOL +	R/C BUTTON
03	VOL -	R/C BUTTON
40	Up (▲)	R/C BUTTON
41	Down (▼)	R/C BUTTON
06	Right (▶)	R/C BUTTON
07	Left (◀)	R/C BUTTON
08	POWER	R/C BUTTON (POWER ON/OFF)
09	MUTE	R/C BUTTON
10	Number Key 0	R/C BUTTON
11	Number Key 1	R/C BUTTON
12	Number Key 2	R/C BUTTON
13	Number Key 3	R/C BUTTON
14	Number Key 4	R/C BUTTON
15	Number Key 5	R/C BUTTON
16	Number Key 6	R/C BUTTON
17	Number Key 7	R/C BUTTON
18	Number Key 8	R/C BUTTON
19	Number Key 9	R/C BUTTON
0B	INPUT	R/C BUTTON
AA	INFO ⓘ	R/C BUTTON
AB	GUIDE	R/C BUTTON
56	SUBTITLE	R/C BUTTON
5B	EXIT	R/C BUTTON
1E	FAV	R/C BUTTON
1A	Q.VIEW	R/C BUTTON
50	D/A TV	R/C BUTTON
F0	TV/RADIO	R/C BUTTON
7E	SIMPLINK	R/C BUTTON
E0	BRIGHT +	R/C BUTTON
E1	BRIGHT -	R/C BUTTON
0A	I/II	R/C BUTTON
0E	SLEEP	R/C BUTTON
43	MENU	R/C BUTTON
44	OK(⊙)	R/C BUTTON
53	LIST	R/C BUTTON
20	TEXT	R/C BUTTON
2A	REVEAL	R/C BUTTON
26	TIME	R/C BUTTON
28	BACK	R/C BUTTON
62	UPDATE	R/C BUTTON
70	INDEX	R/C BUTTON
65	HOLD	R/C BUTTON
61	BLUE Key	R/C BUTTON
63	YELLOW Key	R/C BUTTON
71	GREEN Key	R/C BUTTON
72	RED Key	R/C BUTTON
79	RATIO	R/C BUTTON
B0	▶	R/C BUTTON
BA	II	R/C BUTTON
B2	I◀◀	R/C BUTTON
B3	▶▶I	R/C BUTTON
8F	◀◀	R/C BUTTON
8E	▶▶	R/C BUTTON
B1	■	R/C BUTTON
BD	●	R/C BUTTON

APPENDIX

EXTERNAL CONTROL DEVICE SETUP

RS-232C Setup

Connect the RS-232C (serial port) input jack to an external control device (such as a computer or an A/V control system) to control the TV's functions externally.

Connect the serial port of the control device to the RS-232C jack on the TV back panel.

Note: RS-232C connection cables are not supplied with the TV.

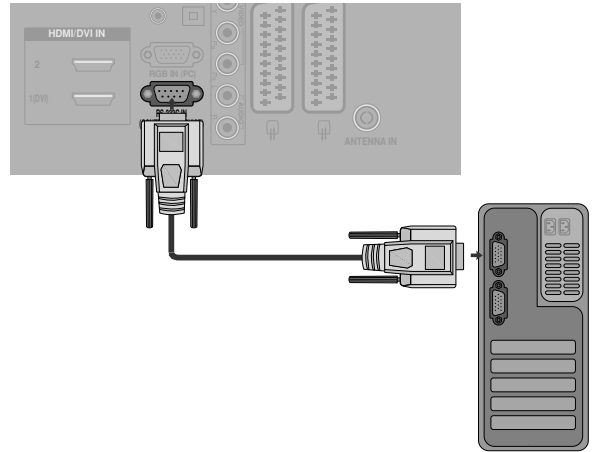

Type of Connector; D-Sub 9-Pin Male

No.	Pin Name
1	No connection
2	RXD (Receive data)
3	TXD (Transmit data)
4	DTR (DTE side ready)
5	GND
6	DSR (DCE side ready)
7	RTS (Ready to send)
8	CTS (Clear to send)
9	No Connection

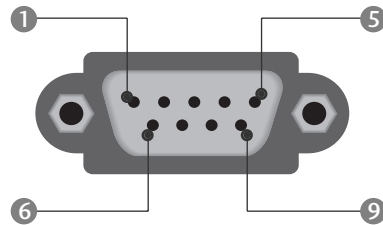

APPENDIX

RS-232C Configurations

7-Wire Configurations (Standard RS-232C cable)

	PC	TV	
RXD	2 ● ——— ●	3	TXD
TXD	3 ● ——— ●	2	RXD
GND	5 ● ——— ●	5	GND
DTR	4 ● ——— ●	6	DSR
DSR	6 ● ——— ●	4	DTR
RTS	7 ● ——— ●	8	CTS
CTS	8 ● ——— ●	7	RTS
	D-Sub 9	D-Sub 9	

3-Wire Configurations (Not standard)

	PC	TV	
RXD	2 ● ——— ●	3	TXD
TXD	3 ● ——— ●	2	RXD
GND	5 ● ——— ●	5	GND
DTR	4	6	DTR
DSR	6	4	DSR
RTS	7	7	RTS
CTS	8	8	CTS
	D-Sub 9	D-Sub 9	

Set ID

Use this function to specify a set ID number.
Refer to 'Real Data Mapping' ► p.101

It is not possible to use **ISM Method** and **Low power** in LCD TV models.

It is possible to use **Power Indicator** in LCD TV models only.



- 1 Press the **MENU** button and then ▲ or ▼ button to select the **OPTION** menu.
- 2 Press the ► button and then ▲ or ▼ button to select **Factory Mode**.
- 3 Press the ► button and then ▲ or ▼ button to select **Set ID**.
- 4 Press the ◀ or ▶ button to adjust **Set ID** to choose the desired TV ID number. The adjustment range of SET ID is 1~99.
- 5 Press the **EXIT** button to return to normal TV viewing.

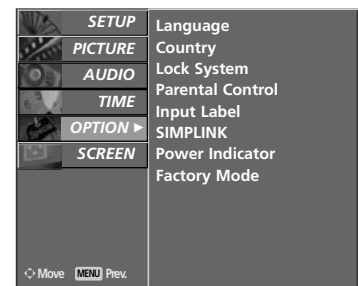

1

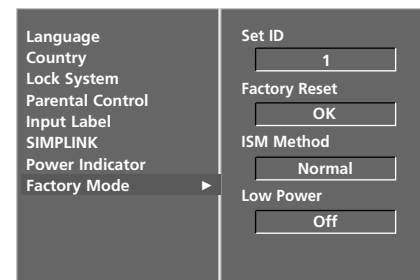

2

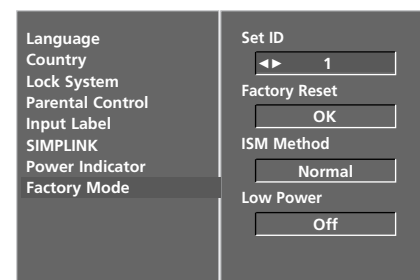

3 4

APPENDIX

Communication Parameters

- Baud rate : 9600 bps (UART)
- Data length : 8 bits
- Parity : None
- Stop bit : 1 bit
- Communication code : ASCII code
- Use a crossed (reverse) cable.

Command Reference List

	COMMAND 1	COMMAND 2	DATA (Hexadecimal)
01. Power	k	a	00 ~ 01
02. Aspect Ratio	k	c	Refer to p. 99
03. Screen Mute	k	d	00 ~ 01
04. Volume Mute	k	e	00 ~ 01
05. Volume Control	k	f	00 ~ 64
06. Contrast	k	g	00 ~ 64
07. Brightness	k	h	00 ~ 64
08. Colour	k	i	00 ~ 64
09. Tint	k	j	00 ~ 64
10. Sharpness	k	k	00 ~ 64
11. OSD Select	k	l	00 ~ 01
12. Remote control lock mode	k	m	00 ~ 01
13. Balance	k	t	00 ~ 64
14. Colour Temperature	k	u	00 ~ 03
15. Red Adjustment	k	v	00 ~ 50
16. Green Adjustment	k	w	00 ~ 50
17. Blue Adjustment	k	\$	00 ~ 50
18. Abnormal Status	k	z	00 ~ a
19. ISM Method	j	p	Refer to p. 101
20. Low Power	j	q	00 ~ 01
21. Auto Configure	j	u	01
22. Channel Select Command	m	a	Refer to p. 102
23. Send IR Code	m	c	Key Code
24. Back Light	m	g	0 ~ 64
25. Input select (Main)	x	b	Refer to p. 102

Transmission / Receiving Protocol

Transmission

[Command1][Command2][][Set ID][][Data][Cr]

- * [Command 1] : First command to control the TV.
(j, k, m or x)
- * [Command 2] : Second command to control the TV.
- * [Set ID] : You can adjust the set ID to choose desired monitor ID number in option menu.
Adjustment range is 1 ~ 99.
When selecting Set ID '0', every connected TV is controlled.
Set ID is indicated as decimal (1~99) on menu and as Hexa decimal (0x0~0x63) on transmission/receiving protocol.
- * [DATA] : To transmit command data.
Transmit 'FF' data to read status of command.
- * [Cr] : Carriage Return
ASCII code '0x0D'
- * [] : ASCII code 'space (0x20)'

OK Acknowledgement

[Command2][][Set ID][][OK][Data][x]

- * The TV transmits ACK (acknowledgement) based on this format when receiving normal data. At this time, if the data is data read mode, it indicates present status data. If the data is data write mode, it returns the data of the PC computer.

Error Acknowledgement

[Command2][][Set ID][][NG][Data][x]

- * The TV transmits ACK (acknowledgement) based on this format when receiving abnormal data from nonviable functions or communication errors.

- Data 01: Illegal Code
02: not support function
03: Wait more time

01. Power (Command: k a)

- ▶ To control Power On/Off of the TV.

Transmission

```
[k][a][ ][Set ID][ ][Data][Cr]
```

Data 00 : Power Off 01 : Power On

Ack

```
[a][ ][Set ID][ ][OK][Data][x]
```

- ▶ To show Power On/Off.

Transmission

```
[k][a][ ][Set ID][ ][FF][Cr]
```

Ack

```
[a][ ][Set ID][ ][OK][Data][x]
```

* Similarly, if other functions transmit '0xFF' data based on this format, Acknowledgement data feed back presents status about each function.

02. Aspect Ratio (Command: k c) (Main Picture Size)

- ▶ To adjust the screen format. (Main picture format)
You can also adjust the screen format using the RATIO button on remote control or in the SCREEN menu.

Transmission

```
[k][c][ ][Set ID][ ][Data][Cr]
```

Data 01 : Normal screen (4:3) 06 : 14:9
 02 : Wide screen (16:9) 07 : Just Scan
 03 : Zoom1 (Only 37/42/47/52LG55**,
 04 : Zoom2 42LG75**, 50PG45**, 50PG75**)
 05 : Original

Ack

```
[c][ ][Set ID][ ][OK][Data][x]
```

* Using the PC input, you select either 16:9 or 4:3 screen aspect ratio.

03. Screen Mute (Command: k d)

- ▶ To select screen mute on/off.

Transmission

```
[k][d][ ][Set ID][ ][Data][Cr]
```

Data 00 : Screen mute off (Picture on)
 01 : Screen mute on (Picture off)

Ack

```
[d][ ][Set ID][ ][OK][Data][x]
```

04. Volume Mute (Command: k e)

- ▶ To control volume mute on/off.
You can also adjust mute using the MUTE button on remote control.

Transmission

```
[k][e][ ][Set ID][ ][Data][Cr]
```

Data 00 : Volume mute on (Volume off)
 01 : Volume mute off (Volume on)

Ack

```
[e][ ][Set ID][ ][OK][Data][x]
```

05. Volume Control (Command: k f)

- ▶ To adjust volume.
You can also adjust volume with the VOLUME buttons on remote control.

Transmission

```
[k][f][ ][Set ID][ ][Data][Cr]
```

Data Min : 00 ~ Max : 64

* Refer to 'Real data mapping 1': See page 101.

Ack

```
[f][ ][Set ID][ ][OK][Data][x]
```

06. Contrast (Command: k g)

- ▶ To adjust screen contrast.
You can also adjust contrast in the PICTURE menu.

Transmission

```
[k][g][ ][Set ID][ ][Data][Cr]
```

Data Min : 00 ~ Max : 64

* Refer to 'Real data mapping 1': See page 101.

Ack

```
[g][ ][Set ID][ ][OK][Data][x]
```

07. Brightness (Command: k h)

- ▶ To adjust screen brightness.
You can also adjust brightness in the PICTURE menu.

Transmission

```
[k][h][ ][Set ID][ ][Data][Cr]
```

Data Min : 00 ~ Max : 64

* Refer to 'Real data mapping 1': See page 101.

Ack

```
[h][ ][Set ID][ ][OK][Data][x]
```

APPENDIX

08. Colour (Command: k i)

- ▶ To adjust the screen colour.
You can also adjust colour in the PICTURE menu.

Transmission

```
[k][i][ ][Set ID][ ][Data][Cr]
```

Data Min : 00 ~ Max : 64
* Refer to 'Real data mapping 1'. See page 101.

Ack

```
[i][ ][Set ID][ ][OK][Data][x]
```

09. Tint (Command: k j)

- ▶ To adjust the screen tint.
You can also adjust tint in the PICTURE menu.

Transmission

```
[k][j][ ][Set ID][ ][Data][Cr]
```

Data Red : 00 ~ Green : 64
* Refer to 'Real data mapping 1'. See page 101.

Ack

```
[j][ ][Set ID][ ][OK][Data][x]
```

10. Sharpness (Command: k k)

- ▶ To adjust the screen sharpness.
You can also adjust sharpness in the PICTURE menu.

Transmission

```
[k][k][ ][Set ID][ ][Data][Cr]
```

Data Min : 00 ~ Max : 64
* Refer to 'Real data mapping 1'. See page 101.

Ack

```
[k][ ][Set ID][ ][OK][Data][x]
```

11. OSD Select (Command: k l)

- ▶ To select OSD (On Screen Display) on/off when controlling remotely.

Transmission

```
[k][l][ ][Set ID][ ][Data][Cr]
```

Data 00 : OSD off 01 : OSD on

Ack

```
[l][ ][Set ID][ ][OK][Data][x]
```

12. Remote control lock mode (Command: k m)

- ▶ To lock the front panel controls on the TV and remote control.

Transmission

```
[k][m][ ][Set ID][ ][Data][Cr]
```

Data 00 : Lock off 01 : Lock on

Ack

```
[m][ ][Set ID][ ][OK][Data][x]
```

- * If you are not using the remote control, use this mode.
When main power is on/off, external control lock is released.

13. Balance (Command: k t)

- ▶ To adjust balance.
You can also adjust balance in the AUDIO menu.

Transmission

```
[k][t][ ][Set ID][ ][Data][Cr]
```

Data Min : 00 ~ Max : 64
* Refer to 'Real data mapping 1'. See page 101.

Ack

```
[t][ ][Set ID][ ][OK][Data][x]
```

14. Colour Temperature (Command: k u)

- ▶ To adjust colour temperature. You can also adjust Colour Temperature in the PICTURE menu.

Transmission

```
[k][u][ ][Set ID][ ][Data][Cr]
```

Data 00: Cool 01: Medium 02: Warm 03: User

Ack

```
[u][ ][Set ID][ ][OK][Data][x]
```

15. Red Adjustment (Command: k v)

- ▶ To adjust red in colour temperature.

Transmission

```
[k][v][ ][Set ID][ ][Data][Cr]
```

Data Min : 00 ~ Max : 50
* Refer to 'Real data mapping 2'.

Ack

```
[v][ ][Set ID][ ][OK][Data][x]
```

16. Green Adjustment (Command: k w)

- ▶ To adjust green in colour temperature.

Transmission

```
[k][w][ ][Set ID][ ][Data][Cr]
```

Data Min : 00 ~ Max : 50

* Refer to 'Real data mapping 2'.

Ack

```
[w][ ][Set ID][ ][OK][Data][x]
```

17. Blue Adjustment (Command: k \$)

- ▶ To adjust blue in colour temperature.

Transmission

```
[k][$][ ][Set ID][ ][Data][Cr]
```

Data Min : 00 ~ Max : 50

* Refer to 'Real data mapping 2'.

Ack

```
[$][ ][Set ID][ ][OK][Data][x]
```

18. Abnormal State (Command: k z)

- ▶ To recognize an abnormal state.

Transmission

```
[k][z][ ][Set ID][ ][FF][ ][Cr]
```

Data FF : Read

Ack

```
[z][ ][Set ID][ ][OK][Data][x]
```

Data 00: Normal (Power on and signal exist)
 01: No signal (Power on)
 02: Turn the TV off by remote control
 03: Turn the TV off by sleep time function
 04: Turn the TV off by RS-232C function
 05: 5V down
 06: AC down
 07: Turn the TV off by Fan Alarm function
 08: Turn the TV off by Off time function
 09: Turn the TV off by Auto sleep function
 a: Turn the TV off by AV Board detect

* This function is "read only".

19. ISM Method (Command: j p)

- ▶ To control the ISM method. You can also adjust ISM Method in OPTION menu.

It is not possible to use this function with LCD TV models.

Transmission

```
[j][p][ ][Set ID][ ][Data][Cr]
```

Data 00: Normal

01: White wash

02: Orbiter

03: Inversion

Ack

```
[p][ ][Set ID][ ][OK/NG][Data][x]
```

20. Low Power (Command: j q)

- ▶ To reduce the power consumption of the TV. You can also adjust Low Power in OPTION menu.

It is not possible to use this function with LCD TV models.

Transmission

```
[j][q][ ][Set ID][ ][Data][ ][Cr]
```

Data 00 : Off

01 : On

Ack

```
[q][ ][Set ID][ ][OK/NG][Data][x]
```

* Real data mapping 1

```
00 : Step 0
⋮
A : Step 10 (Set ID 10)
⋮
F : Step 15 (Set ID 15)
10 : Step 16 (Set ID 16)
⋮
64 : Step 100
⋮
6E : Step 110
⋮
73 : Step 115
74 : Step 116
⋮
C7 : Step 199
⋮
FE : Step 254
FF : Step 255
```

* Real data mapping 2

```
00 :-40
01 :-39
02 :-38
⋮
28 : 0
⋮
4E : +38
4F : +39
50 : +40
```

APPENDIX

21. Auto Configure (Command: j u)

- ▶ To adjust picture position and minimize image shaking automatically. It works only in RGB (PC) mode.

Transmission

[j][u][][Set ID][][Data][Cr]

Data 01: To set

Ack

[u][][Set ID][][OK/NG][Data][x]

22. Channel Select Command (Command: m a)

- ▶ Select channel to following physical number.

Transmission

[m][a][][Set ID][][Data0][][Data1][][Data2][Cr]

Data 00 : High channel data

Data 01 : Low channel data

ex. No. 47 -> 00 2F (2FH)
No. 394 -> 01 88 (188H),
DTV No. 0 -> Don't care

Data 02 0x00 : ATV Main

0x10 : DTV Main

Channel data range

Analogue - Min: 00 ~ Max: 63 (0~99)

Digital - Min: 00 ~ Max: 3E7 (0~999)

Ack

[a][][Set ID][][OK/NG][Data][x]

Data Min: 00 ~ Max: 7D

23. Send IR Code (Command: m c)

- ▶ To send IR remote key code.

Transmission

[m][c][][Set ID][][Data][Cr]

Data Key code - Refer to page 95.

Ack

[c][][Set ID][][OK/NG][Data][x]

24. Back Light (Command: m g)

- ▶ To adjust the screen back light.
You can also adjust back light in the PICTURE menu.
It is possible to use this function with LCD TV models.

Transmission

[m][g][][Set ID][][Data][Cr]

Data Min : 00 ~ Max : 64

* Refer to 'Real data mapping 1'. See page 101.

Ack

[g][][Set ID][][OK][Data][x]

25. Input select (Command: x b) (Main Picture Input)

- ▶ To select input source for main picture.

Transmission

[x][b][][Set ID][][Data][Cr]

Data Structure

MSB				LSB			
0	0	0	0	0	0	0	0
└ External Input ┘				└ Input Number ┘			

External Input				Data
0	0	0	0	DTV
0	0	0	1	Analogue
0	0	1	0	AV
0	0	1	1	Component
0	1	0	0	RGB
0	1	0	1	HDMI

Input Number				Data
0	0	0	0	Input1
0	0	0	1	Input2
0	0	1	0	Input3
0	0	1	1	Input4

Ack

[b][][Set ID][][OK/NG][Data][x]

LG Electronics Inc.