



Model: MDS713

(MDS713-A/X0U, MDS713V, MDS713C, MDS713S, MDS713W)

MDD263

(MDD263-A/X0U, MDS263V)

ENGLISH

PORTUGUÊS

Français



Safety Precaution



CAUTION
RISK OF ELECTRIC SHOCK
DO NOT OPEN



CAUTION: TO REDUCE THE RISK OF ELECTRIC SHOCK DO NOT REMOVE COVER (OR BACK) NO USER-SERVICEABLE PARTS INSIDE REFER SERVICING TO QUALIFIED SERVICE PERSONNEL.



This lightning flash with arrowhead symbol within an equilateral triangle is intended to alert the user to the presence of uninsulated dangerous voltage within the product's enclosure that may be of sufficient magnitude to constitute a risk of electric shock to persons.



The exclamation point within an equilateral triangle is intended to alert the user to the presence of important operating and maintenance (servicing) instructions in the literature accompanying the product.

WARNING: TO PREVENT FIRE OR ELECTRIC SHOCK HAZARD, DO NOT EXPOSE THIS PRODUCT TO RAIN OR MOISTURE.

WARNING: Do not install this equipment in a confined space such as a book case or similar unit.

CAUTION: Do not block any ventilation openings. Install in accordance with the manufacturer's instructions.

Slots and openings in the cabinet are provided for ventilation and to ensure reliable operation of the product and to protect it from over heating. The openings should be never be blocked by placing the product on a bed, sofa, rug or other similar surface. This product should not be placed in a built-in installation such as a bookcase or rack unless proper ventilation is provided or the manufacturer's instruction has been adhered to.

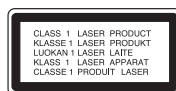

CAUTION: This product employs a Laser System.

To ensure proper use of this product, please read this owner's manual carefully and retain it for future reference. Should the unit require maintenance, contact an authorized service center.

Use of controls, adjustments or the performance of procedures other than those specified herein may result in hazardous radiation exposure.

To prevent direct exposure to laser beam, do not try to open the enclosure. Visible laser radiation when open. DO NOT STARE INTO BEAM.

CAUTION: The apparatus should not be exposed to water (dripping or splashing) and no objects filled with liquids, such as vases, should be placed on the apparatus.

CAUTION concerning the Power Cord

Most appliances recommend they be placed upon a dedicated circuit; That is, a single outlet circuit which powers only that appliance and has no additional outlets or branch circuits. Check the specification page of this owner's manual to be certain.

Do not overload wall outlets. Overloaded wall outlets, loose or damaged wall outlets, extension cords, frayed power cords, or damaged or cracked wire insulation are dangerous. Any of these conditions could result in electric shock or fire. Periodically examine the cord of your appliance, and if its appearance indicates damage or deterioration, unplug it, discontinue use of the appliance, and have the cord replaced with an exact replacement part by an authorized service center.

Protect the power cord from physical or mechanical abuse, such as being twisted, kinked, pinched, closed in a door, or walked upon. Pay particular attention to plugs, wall outlets, and the point where the cord exits the appliance.

To disconnect power from the mains, pull out the mains cord plug. When installing the product, ensure that the plug is easily accessible.

in NIGERIA

POWER: This unit operates on a mains supply of 200-240V, 50/60Hz.

WIRING : This unit is supplied with a BSI 1363 approved 13 amp mains plug, fused at 3 amp. When replacing the fuse always use a 3 amp BS 1362, BSI or ASTA approved type. Never use this plug with the fuse cover omitted. To obtain a replacement fuse cover contact your dealer. If the type of plug supplied is not suitable for the mains sockets in your home, then the plug should be removed and a suitable type fitted. Please refer to the wiring instructions below:

WARNING: A mains plug removed from the mains lead of this unit must be destroyed. A mains plug with bared wires is hazardous if inserted in a mains socket.







Do not connect either wire to the earth pin, marked with the letter E or with the earth symbol \perp or coloured green or green and yellow.

If any other plug is fitted, use a 3 amp fuse, either in the plug, or at the distribution board.

IMPORTANT: The wires in this mains lead are coloured in accordance with the following codes:

- **BLUE: NEUTRAL, BROWN: LIVE** - As the colours of the wires in the mains lead of this unit may not correspond with the coloured marking identifying the terminals in your plug, proceed as follows: The wire which is coloured blue must be connected to the terminal which is marked with the letter N or coloured black. The wire which is coloured brown must be connected to the terminal which is marked with the letter L or coloured red.

Types of Playable Discs

Type	Logo
DVD-VIDEO: Discs such as movies that can be purchased or rented.	
DVD-R: Video mode and finalized only	
DVD-RW: Video mode and finalized only	
DVD+R: Video mode only Supports the double layer disc also	
DVD+RW: Video mode only	
Video CD (VCD/SVCD):	
Audio CD:	

In addition, this unit can play a DVD±R/RW, SVCD and CD-R or CD-RW that contains audio titles, MP3, WMA, JPEG files.
Depending on the conditions of the recording equipment or the CD-R/RW (or DVD±R/RW) disc itself, some CD-R/RW (or DVD±R/RW) discs may not be played on the unit due to the recording quality or physical condition of the disc, or the characteristics of the recording device and authoring software. The disc will not play if it has not been correctly finalized. Player does not support these kinds of discs.

"Dolby", "Pro Logic", and the double-D symbol are trademarks of Dolby Laboratories.

Manufactured under license from Dolby Laboratories.

Manufactured under license under U.S. Patent #'s: 5,451,942; 5,956,674; 5,974,380; 5,978,762; 6,487,535 & other U.S. and worldwide patents issued & pending. DTS and DTS Digital Surround are registered trademarks and the DTS logos and Symbol are trademarks of DTS, Inc. © 1996-2007 DTS, Inc. All Rights Reserved.(MDS713)

About the Symbol Display

"" may appear on your TV display during operation and indicates that the function explained in this owner's manual is not available on that specific DVD video disc.

Regional code

This unit has a regional code printed on the rear of the unit. This unit can play only DVD discs labeled same as the rear of the unit or "ALL".

- Most DVD discs have a globe with one or more numbers in it clearly visible on the cover. This number must match your unit's regional code or the disc cannot play.
- If you try to play a DVD with a different regional code from your player, the message "Check Regional Code" appears on the TV screen.

Copyrights

It is forbidden by law to copy, broadcast, show, broadcast via cable, play in public, or rent copyrighted material without permission. This product features the copy protection function developed by Macrovision. Copy protection signals are recorded on some discs. When recording and playing the pictures of these discs picture noise will appear. This product incorporates copyright protection technology that is protected by method claims of certain U.S. patents and other intellectual property rights owned by Macrovision Corporation and other rights owners. Use of this copyright protection technology must be authorized by Macrovision Corporation, and is intended for home and other limited viewing uses only unless otherwise authorized by Macrovision Corporation. Reverse engineering or disassembly is prohibited.

CONSUMERS SHOULD NOTE THAT NOT ALL HIGH DEFINITION TELEVISION SETS ARE FULLY COMPATIBLE WITH THIS PRODUCT AND MAY CAUSE ARTIFACTS TO BE DISPLAYED IN THE PICTURE. IN CASE OF 525 OR 625 PROGRESSIVE SCAN PICTURE PROBLEMS, IT IS RECOMMENDED THAT THE USER SWITCH THE CONNECTION TO THE 'STANDARD DEFINITION' OUTPUT. IF THERE ARE QUESTIONS REGARDING OUR TV SET COMPATIBILITY WITH THIS MODEL 525p AND 625p UNIT, PLEASE CONTACT OUR CUSTOMER SERVICE CENTER.

Welcome to your new DVD Mini Hi-Fi System

Contents

Safety Precaution	2	Connecting your portable USB player	18
Types of Playable Discs	3	USB Direct Recording	19
Setting up	5	Language Codes	20
Main Unit	6	Area Codes	20
Hooking up the unit	7	Troubleshooting	21
Remote control	8	Specifications	22
OSD Initial language setting (Optional) ..	9		
Initial Setting the Area Code (Optional) ..	9		
Adjust the settings	9-10		
Displaying Disc Information	11		
Setting the clock	11		
Use your player as an alarm clock	11		
Setting the sound mode	12		
Playing a Disc	13		
Playing a DivX Movie file	14		
Listening to Audio CD,MP3 or WMA files ..	14-15		
Viewing photo files	15-16		
Listening to the radio	16		
Listening to the cassette tapes	17		
Tape recording	17		
CD Synchronized Recording	18		
Listening to music from your portable player	18		

Power Save Mode

You can set up the unit into an economic power save mode.

In power-on status, press and hold **STANDBY/ON**  button for about 3 seconds.

- Nothing is displayed in the display window when the unit is turned off.

To cancel, press **STANDBY/ON** , **CLOCK**, **TIMER** or **REVERSE MODE/DEMO**.

Setting up

Attaching the speakers to the unit

Connect the wires to the unit.

Match each wire's coloured band to the same coloured connection terminal on the reverse of the unit.

To connect the cable to the unit, press each plastic finger pad to open the connection terminal. Insert the wire and release the finger pad. The connector will open ready to receive a cable.

MDS713 MODEL

Connect the red end of each wire to the terminals marked +(plus) and the black end to the terminals marked - (minus).

To connect the cable to the center speakers, press each plastic finger pad to open the connection terminals on the back of center speaker. Insert the wire and release the finger pad.(MDS713 MODEL)

COLOUR	SPEAKER	POSITION
Grey	Rear	Behind you and to your right
Blue	Rear	Behind you and to your left
Green	Centre	Above screen, directly in front of you.
Orange	Sub Woofer	
Red	Front	In front of you, to the right of the screen
White	Front	In front of you, to the left of the screen

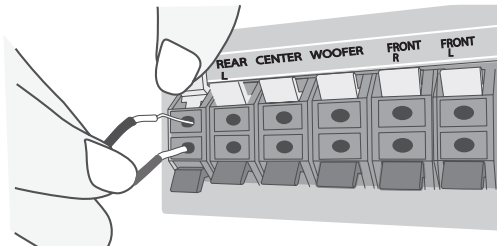

MDD263 MODEL

COLOUR	SPEAKER	POSITION
Red	Front	In front of you, to the right of the screen
White	Front	In front of you, to the left of the screen

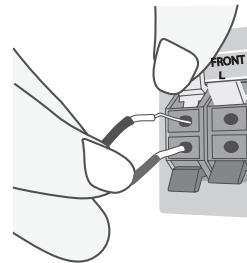

Connect the red end of each wire to the terminals marked +(plus) and the black end to the terminals marked - (minus).

Be careful of the following

- Be careful to make sure children not to put their hands or any objects into the speaker duct.
- Speaker duct : A hall for plentiful bass sound on speaker cabinet (enclosure).

Remote control Operation

Point the Remote Control at the remote sensor and press the buttons.

Remote control Battery Installation

Detach the battery cover on the rear of the remote control, and insert two R03 (size AAA) batteries with ⊕ and ⊖ aligned correctly. Do not mix old and new batteries. Never mix different types of batteries (standard, alkaline, etc.).

Main unit

Disc tray

STANDBY/ON 
Turn on or off.

- **TIMER** (Use your player as an alarm clock.)
With the timer function you can turn DVD/CD, TAPE,USB play and radio reception on or off at a desired time .
- **CLOCK** (See setting the Clock)
- **EQ** You can choose 7 fixed sound impression.
- **REVERSE MODE** scroll through a selection of cassette playing options.
- Press **REVERSE MODE/DEMO** in power off state to demonstrate the function on display window. To cancel it,press **STANDBY /ON**  or **REVERSE MODE/DEMO.** again.





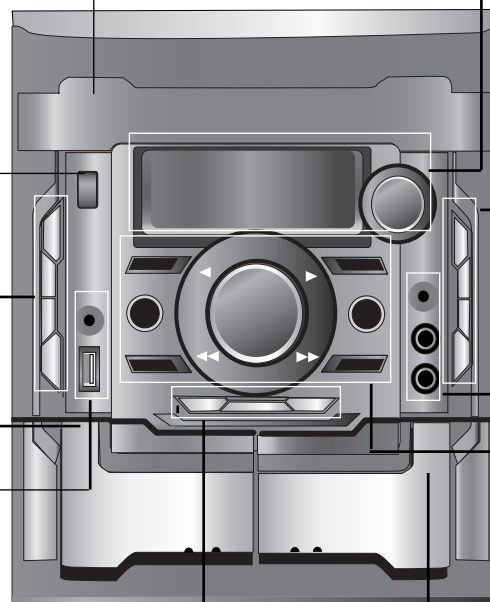





▲PUSH EJECT position- TAPE1

- **USB connector**
Connect a remote USB compatible player here.
- **Headphone jack**
Connect a headphone plug (∅3.5 mm) into the jack to listen to the sound through headphones (not supplied).
- **XDSS Plus (MP3 Optimizer)**
Reinforce the treble, bass and surround effect.XDSS ON will show in the display,press again for NORMAL (Page 12)
- **STOP** button
- **USER EQ** sound quality adjustment.



▲PUSH EJECT position- TAPE2

•Display window

- **MULTI JOG** Turn the MULTI JOG to right and left step by step.
- Manual tuning /CD skip/CLOCK adjust.
- **▲ OPEN**
- **DISC SKIP** Choose a desired disc.
- **DUBB./CD SYNC./ST.MO.** CD to Tape.
Synchronized Recording or to record from tape to tape.
- **ST.MO.** To improve the FM reception on TUNER
- **SET** confirms the time you have selected when setting the clock.
- CDII Pause
- **MIC1/MIC2** (Optional) Connect the microphone. (∅6.3 mm)
- **PORT. IN** For connecting a portable device and playing it through the system's speaker.
- **Function select buttons**
To select the Functions press. (TUNER, TAPE,AUX/PORTABLE,DVD/CD,USB).
- **REC./II** USB direct Recording (Page19)/ TAPE Recording. (Page17)
- **VOLUME Adjustment**
- **REWIND or FAST FORWARD** ( ) - TAPE
- Auto Tuning ( ) -TUNER
- **SCAN** ( ) buttons -CD
- **USER EQ SET**( )
- **FORWARD / REVERSE PLAY** ( ) -TAPE
- **PLAY** or X1.5 play- CD (Page 13)
- **PRESET** () Choose a "Preset number" for Radio station.

Hooking up the unit

VIDEO OUT / COMPONENT VIDEO OUT (PROGRESSIVE SCAN) / AUX IN

VIDEO OUT jack connection

Connect the VIDEO OUT jack on the unit to the corresponding input jacks on your TV using a Video cable.

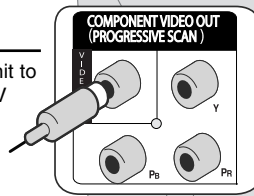

COMPONENT VIDEO OUT (PROGRESSIVE SCAN) jacks connection

Connect one end of the component(Y PB PR) cable to the COMPONENT VIDEO OUT (PROGRESSIVE SCAN) jack on the unit and other end to the COMPONENT INPUT jack on your TV

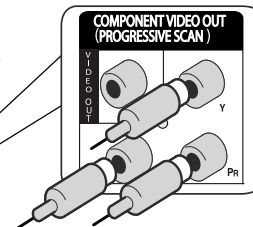

Antenna connection

Fit the AM loop aerial to its stand

Connect the AM loop aerial to the player.

Connect the FM aerial

The reception will be at its best when the two loose ends of the aerial are in a straight line and horizontal.

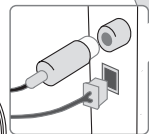
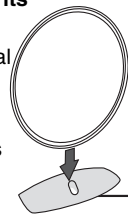

AUX IN (R/L) jacks connection

Connect a VCR or Auxiliary device, etc. to the INPUT jack of this unit.

Press the INPUT button on the remote control until the "AUX" indicator is displayed in the display window.

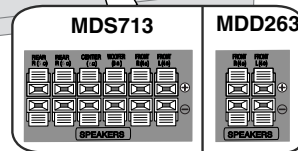
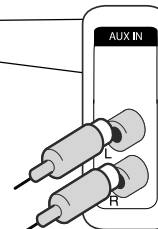

Remote control

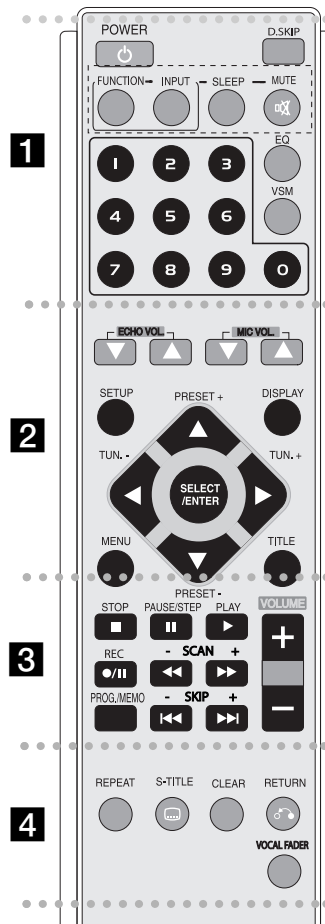

1 **POWER:** Switches the unit ON or OFF.

DISC SKIP Choose a desired disc.

MUTE : Press MUTE to mute your unit., for example, to answer the telephone.

FUNCTION : (DVD/CD →TAPE→ FM→ AM)

INPUT : Changes the input source (USB→AUX → PORTABLE)

SLEEP : You can set the unit to turn off automatically at a specified time.

- **DIMMER** Dims the LED (Light-emitting diode) of front panel by half in power-on status.

EQ (EQUALIZER Effect) : You can choose 7 fixed sound impressions.(page 12)

VSM : Press **VSM** to set the VIRTUAL sound.(page 12)

0-9 numerical buttons: Selects numbered options in a menu.

ECHO VOL.(▼ / ▲) : Adjusts echo volume

MIC VOL.(▼ / ▲) : Adjusts microphone volume

SETUP : Accesses or removes setup menu

MENU : Accesses the menu on a DVD disc.

DISPLAY: Accesses On-Screen Display.

TITLE : If the current DVD title has a menu, the title menu appears on the screen. Otherwise, the disc menu may appear.

◀ / ▶ / ▲ / ▼ (left/right/up/down):Used to navigate on-screen displays.

SELECT/ENTER : Acknowledges menu selection.

PRESET (-/+) (▼/▲) : Selects programme of Radio.

TUN.(-/+) (◀/▶): Tunes in the desired radio station.

3 **PLAY (▶):** Starts playback.

- **Tape reverse playback** press (▶) once again.

- **1.5 speed playback**

The 1.5 speed allows you to watch the pictures and listen to the sound quicker than playing at a normal speed on the disc.- (page 13)

- **MONO/STEREO** FM mode state,selects MONO or STEREO by pressing PLAY (▶) button.

STOP (■): Stops playback or recording.

PAUSE/STEP(⏸): Pause playback.

REC (●/⏻) : USB DIRECT RECORDING /TAPE RECORD

You can record one desired file or all of the music files in AUDIO CD to USB -(page 19).or Records from a CD or radio to cassette.- (page 17)

- **SCAN(◀◀/▶▶) :** Search backward or forward.

- **SKIP (◀◀ / ▶▶):** Go to next or previous chapter/ track/Title.

PROG./MEMO. : Accesses or removes Program menu.

VOLUME (+/-) : Adjusts speaker volume.

- **REPEAT :** Repeats a Chapter/ Track/ Title all.

S-TITLE: During playback,S - TITLE repeatedly to select a desired subtitle language.

CLEAR: Removes a track number on the Program List.

RETURN (↶): Press to move back wards in the menu.

VOCAL FADER : You can enjoy the function as karaoke, by reducing singer vocal of music in the various source.

MP3/WMA/CD/DTS(MDS713)/DD(Dolby Digital) etc. except for Karaoke mode. (Page12)

OSD Initial language setting (Optional)

After factory setting ,this beginning menu language will only be displayed at DVD or USB mode if you turn on the power at the first time .

	ON PLAYER	ON REMOTE
1. Turn the power on: Appear the language list display window.	⏻STAND-BY/ON	⏻POWER
2. Select the language :		▲▼◀▶
3. Press		SELECT/ENTER
4.To confirm press		SELECT/ENTER

Initial Setting the Area Code (Optional)

After factory setting ,To set the Area code you have to as below.

	ON REMOTE
1. Display setup menu:	SETUP
2. Select LOCK menu on the first level:	▲▼
3. Move to second level: Appears the activated Area code on the second level.	▶
4. Move to third level:	▶
5. Enter the new pass word and then, press	Numerical button of 0~ 9 then, SELECT/ENTER
6. Recheck entered new pass word and then, press	Numerical button of 0~ 9 then, SELECT/ENTER
7. Select a code for a geographic area: After select,Rating and Password will be activated.(page20)	▲▼◀▶
8. Press Enter.	SELECT/ENTER

Adjust the settings

	ON REMOTE
1. Display setup menu:	SETUP
2. Select a desired option on the first level:	▲▼
3. Move to second level:	▶
4. Select a desired option on the second level:	▲▼
5. Move to third level:	▶
6.Change the setting:	▲▼ and SELECT/ENTER

Adjust the settings - more you can do

Adjust the language settings

OSD– Select a language for the Setup menu and on-screen display.

Disc Audio/Subtitle/Disc Menu – Select a language for the Menu/Audio/Subtitle.

[Original]: Refers to the original language in which the disc was recorded.

[Others]: To select another language, press number buttons then SELECT/ENTER to enter the corresponding 4-digit number according to the language code list in the reference chapter . If you make a mistake while entering number, press CLEAR to delete numbers then correct it.

[OFF] (for Disc Subtitle): Turn off Subtitle.

Adjust the display settings

TV Aspect – Select which screen aspect to use based on the shape of your TV screen.

[4:3]: Select when a standard 4:3 TV is connected.

[16:9]: Select when a 16:9 wide TV is connected.

Display Mode – If you selected 4:3, you'll need to define how you would like widescreen programs and films to be displayed on your TV screen.

[Letterbox]: This displays a widescreen picture with black bands at the top and bottom of the screen.

[Panscan]: This fills the entire 4:3 screen, cropping the picture as necessary.

Progressive Scan-

Progressive Scan Video provides the high quality pictures with less flickering. If you are using the Component Video jacks for connection to a TV or monitor that is compatible with a progressive scan signal, set [Progressive Scan] to [On].

Press SELECT/ENTER to confirm your selection.

- If you not press ENTER within 10 seconds it will be [OFF].

Adjust the audio settings**5.1 Speaker Setup (Optional)**

Press SELECT/ENTER, and the 5.1 Speaker Setup menu appears. Use ◀ / ▶ to select the desired speaker. Adjust options using ▲ / ▼ / ◀ / ▶ buttons. Press SELECT/ENTER to confirm your selection. Returns to the previous menu.

[Speaker]: Select a speaker that you want to adjust.

[Size]: Since the speaker settings are fixed, you cannot change the settings.

[Volume]: Press ◀ / ▶ to adjust the output level of the selected speaker. (-5dB ~ 5dB)

[Distance]: If you connected speakers to your unit, setting the Distance lets the speakers know how far the sound has to travel to reach your set listening point. This allows the sound from each speaker to reach the listener at the same time.

Press ◀ / ▶ to adjust the Distance of the selected speaker. (You can't adjust front / Woofer speakers)

[Test]: Press ◀ / ▶ to test the signals of each speaker. Adjust the volume to match the volume of test signals memorized in the system.

DRC (Dynamic Range Control) – Make the sound clear when the volume is turned down (Dolby Digital only). Set to [On] for this effect.

Vocal – Select [On] to mix karaoke channels into normal stereo. This function is effective for multi-channel karaoke DVDs only.

Adjust the lock settings

To access the lock options, you must enter the 4-digit password. If you have not yet entered a password you are prompted to do so. Enter a 4-digit password. Enter it again to verify. If you make a mistake while entering number, press CLEAR to delete numbers then correct it.

If you forget your password you can reset it. Press SETUP and Input '210499'. The password has now been cleared.

Rating – Select a rating level. The lower the level, the stricter the rating. Select [UNLOCK] to deactivate the rating.

Password – Sets or changes the password for lock settings.

[New]: Enter a new 4-digits password using the numerical buttons then press SELECT/ENTER. Enter the password again to confirm.

[Change]: Enter the new password twice after entering the current password.

Area code – Select a code for a geographic area as the playback rating level. This determines which area's standards are used to rate DVDs controlled by the parental lock. See the Area Codes on page 20.

Adjust the others settings

PBC (Playback Control) – Playback control provides special navigation features that are available on some Video CDs. Select [On] to use this feature.

DivX (R) Registration - We provide you with the DivX® VOD (Video On Demand) registration code that allows you to rent and purchase videos using the DivX® VOD service.

For more information, visit www.divx.com/vod.

Press SELECT/ENTER when [Select] icon is highlighted and you can view the registration code of the unit.

Semi Karaoke - When a chapter/ title / track is fully finished, this function shows the score in the screen with a fanfare sound.

• **Semi Karaoke on** : Turn the "Semi Karaoke" function on.

When you finished singing a score will appear on the screen.

• **Semi Karaoke off** : Turn the "Semi Karaoke" function off.

Fanfare and score do not appears on the screen

Available discs for the Semi Karaoke function:

- DVD ,DVD Karaoke ,VCD discs with more than 2 tracks

- This function operate on the DVD/CD mode.

- The Semi Karaoke function is available only when a microphone is connected.

- When you watching movies, "off" the Semi Karaoke at the SETUP menu or enjoy it without connecting the MIC if the fanfare or score appears during changing a chapter.







Bit Rate - Select Bit Rate signal speed 96kbps or 128kbps (Rec. Bit rate)

Displaying Disc Information

	ON REMOTE
1. Press	DISPLAY
2. Select a item	▲▼
3. Adjust the Display menu settings	◀▶
4. To return the exit	DISPLAY

Displaying Disc Information - more you can do

You can select an item by pressing ▲▼ and change or select the setting by pressing ▶◀.

 1/1	Current title (or track) number/total number of titles (or tracks)
 13/18	Current chapter number/total number of chapters
 0:39:02	Elapsed playing time
 1 ENG DSD 5CH	Selected audio language or channel
 Off	Selected subtitle
 1/1	Selected angle/total number of angles
 Bypass	Selected Sound mode

Symbol Used in this Manual

All discs and file listed below	ALL	MP3 files	MP3
DVD and finalized DVD±R/RW	DVD	WMA files	WMA
Video CDs	VCD	DivX files	DivX
Audio CDs	ACD		

Setting the Clock

	ON PLAYER	ON REMOTE
1. Turn the power on:	⏻ STANDBY/ON	⏻ POWER
2. Press for at least 2 seconds:	CLOCK	
3. Choose from either: AM 12:00 (for an am and pm display) or 0:00 (for a 24 hour display)	MULTI JOG	
4. Confirm your selection:	SET	
5. Select the hours:	MULTI JOG	
6. Press:	SET	
7. Select the minutes:	MULTI JOG	
8. Press:	SET	

Use your player as an alarm clock

Press and hold **TIMER** for two seconds. Each function, DVD/CD,USB TAPE,TUNER flashes for two seconds. Press **SET** when the function you want to be woken by is showing.

If you choose TUNER, "PLAY" and "REC" flashes in the display window alternately. Choose one of them by pressing the **SET** and then, select the preset using **MULTI JOG** and press **SET**.

If you choose DVD/CD,USB or TAPE you will be shown below.

You will be shown the "ON TIME" display. This is where you set the time you want the alarm to go off. Use **MULTI JOG** to change the hours and minutes and **SET** to save. You will then be shown the "OFF TIME" display. This is where you set the time you want the function to stop. Use **MULTI JOG** to change the hours and minutes and press **SET** to save.

Next you will be shown the volume (VOL) you want to be woken by. Use **MULTI JOG** to change the volume and **SET** to save. Switch the system off. The clock icon "⌚" shows that the alarm is set.

When the system is turned off you can check the time the alarm is set for by pressing **TIMER**. You can also turn the alarm on and off by pressing **TIMER**. To set the alarm to go off at a different time, switch the system on and reprogramme following the same steps as initially.

Fall asleep while listening to your player

You can set the unit to turn off automatically at a specified time. Each time you press SLEEP the setting changes in the following order. (DIMMER ON)→SLEEP 180 →150 →120→90 →80 → 70 → 60→ 50 → 40 → 30 → 20 →10 →(DIMMER OFF)

DIMMER

Press SLEEP once. The LED (Light-emitting diode) of front panel is turned off and the display window will be darkened by half. To cancel it, press SLEEP repeatedly until dim off.

Setting the sound mode

XDSS Plus (Extreme Dynamic Sound System)

Press **XDSS Plus** to reinforce treble, bass and the surround effect. The "XDSS ON" or "NORMAL" indicator lights.

This function optimizes for compressed MP3 files

DVD **DivX** **VCD** **ACD** : XDSS ON ↔ NORMAL

WMA **MP3**: XDSS ON → MP3 -- OPT ON
→ NORMAL → XDSS ON .

EQ (EQUALIZER Effect)

You can choose 7 fixed sound impressions.

Each time you press the button the setting changes in the display window as shown below. (AUTO EQ operates only in the MP3/ WMA files which include the Tag information.)

NORMAL → NATURAL → ARABIC (Optional) → (AUTO EQ) → POP → CLASSIC → ROCK → JAZZ → NORMAL.

USER EQ

To Select a USER EQ Press the USER EQ button.

When "USER EQ" is displayed ,Press SET/CDII

Select the sound effect you want among BASS , MIDDLE or TREBLE by pressing ◀ ▶ on the front panel.

Adjust sound level (MIN, -4 to +4, MAX) turning MULTI JOG

VSM (VIRTUAL SOUND MATRIX) :

Press **VSM** to set the virtual sound or to change sound mode repeatedly.

• 2.1Ch source : 3D STEREO

Real time 3D positioned sound rendering technology with stereo sources, optimized for stereo speakers. Listeners may experience amazing virtual surround effects with their own multimedia players. (MDD263 ONLY)

BYPASS → VIRTUAL → ON STAGE → PLII MOVIE → PLII MUSIC → PLII MTRX → BYPASS

• 5.1 Ch Source : Multichannel sound

The Multichannel sound changes the sound in 5.1 ch into a virtual one in the 10.1 ch so that it provides such a feeling that you listen to the sound simultaneously from the right and left speakers and center speaker.

BYPASS → VIRTUAL → BYPASS (MDS713 ONLY)

VOCAL FADER

You can enjoy the function as karaoke, by reducing singer vocal of music in the various source.(MP3/WMA/CD/DTS(MDS713)/DD(Dolby Digital) etc.) except for Karaoke mode.

- This function available to use only when a microphone is connected.

Press VOCAL FADER button then you can see "FADE ON" or "FADE OFF" on the front display.

- This function supports for 2 channel or more.

Using Microphone

You can sing to a music source by connecting a microphone to the unit.

Connect your microphone to the MIC1/ MIC 2 (Optional) Jacks.

"  " will be shown in the display window.

Play the music you want.

Playing a Disc

	ON PLAYER	ON REMOTE
1. Open the disc tray:	OPEN▲	
2. Insert a disc:		
3. Close the disc tray:	OPEN▲	
4. To Start playback:	▶	▶
5. To stop playback:	■ STOP	■ STOP

Playing a Disc - more you can do

Playing a DVD or Video CD that has a menu **DVD VCD**

Most DVD or Video CD now have menus which load first before the film begins to play. You can navigate these menus using ▲▼◀▶ or number button to highlight an option. Press **SELECT/ENTER** to select.

Skip to the next/previous chapter/track **ALL**

Press **SKIP (▶▶)** to move to the next chapter/track.
 Press **SKIP (◀◀)** to return to the beginning of the current chapter/track.
 Press **SKIP (◀◀)** twice briefly to step back to the previous chapter/track.
 Or use the MULTI JOG on the front panel by turning to left or right.

Pause a playback **ALL**

Press **PAUSE/STEP (||)** to pause playback. Press **PLAY (▶)** to continue playback.

Frame-by-Frame playback **DVD DivX VCD**

Press **PAUSE/STEP (||)** repeatedly to play Frame-by-Frame playback.

Playing repeatedly **ALL**

Press **REPEAT** repeatedly to select an item to be repeated. The current title, chapter or track will be played back repeatedly. To return to normal playback, press **REPEAT** repeatedly to select [Off]. On a Video CD with PBC, you must set PBC to Off to use this function.

DivX VCD : Track → All → Off

ACD WMA MP3 : TRACK → ALL → [OFF No display]

DVD : Chapter → Title → Off

Selecting a subtitle language **DVD DivX**

During playback, press **S-TITLE (☐)** repeatedly to select a desired subtitle language.

Fast forward or fast reverse

DVD DivX VCD ACD WMA MP3

Press **SCAN (◀◀ or ▶▶)** to play fast forward or fast reverse during playback. You can change the various playback speed by pressing **SCAN (◀◀ or ▶▶)** repeatedly. Press **PLAY (▶)** to continue play at normal speed.

Watch and listen 1.5 times faster **DVD VCD ACD WMA MP3**

Press **PLAY** when a disc is already playing to watch and listen to a DVD 1.5 times faster than normal playback speed. ▶x1.5 will appear on the screen. Press **PLAY** again to return to normal playback speed.

Slow down the playing speed **DVD VCD**

While playback is paused, press **SCAN (▶▶)** to slow down forward playback. You can change the various playback speed by pressing **SCAN (▶▶)** repeatedly. Press **PLAY (▶)** to continue play at normal speed.
 DVD disc can operate Slow down Forward/ Reverse playback only.

Viewing the title menu **DVD**

Press **TITLE** to display the disc's title menu, if available.

Viewing the DVD menu **DVD**

Press **MENU** to display the disc menu, if available.

Starting play from selected time **DVD DivX VCD**

Searches for the starting point of entered time code. Press **DISPLAY** then select clock icon. Enter a time then press **SELECT/ENTER**. For example, to find a scene at 1 hours, 10 minutes, and 20 seconds, enter "11020" and press **SELECT/ENTER**. If you enter the wrong number, press **CLEAR** to enter again. On a Video CD with PBC, you must set PBC to Off to use this function.

Last Scene Memory **DVD**

This unit memorizes last scene from the last disc that is viewed. The last scene remains in memory even if you remove the disc from the player or switch off the unit. If you load a disc that has the scene memorized, the scene is automatically recalled.

Screen Saver

The screen saver appears when you leave the unit in Stop mode for about five minutes.

System Select (OPTIONAL)

You must select the appropriate system mode for your TV system. Remove any disc that might be in the unit, press and hold **PAUSE/STEP (II)** for more than five seconds to be able to select a system (PAL, NTSC, AUTO).

Mixed disc or USB Flash Drive – DivX, MP3/WMA and JPEG

When playing a disc or USB Flash Drive contained with DivX, MP3/WMA and JPEG files together, you can select which menu of files you would like to play by pressing **TITLE**.

Playing a DivX movie file

	ON PLAYER	ON REMOTE
1. Open the disc tray:	OPEN ▲	
2. Insert a Disc:	-	
3. Close the disc tray:	OPEN ▲	
4. Select a movie file from the menu:	MULTI JOG	▲ ▼
5. To Start playback:	▶	SELECT/ENTER
6. To stop playback:	■ STOP	■ STOP

Playing a DivX movie file - more you can do

Changing the character set to display DivX® subtitle correctly

If the subtitle dose not display properly,press and hold S-TITLE button about 3seconds to display the language code menu and then,press S-TITLE button repeatedly to change the language code until the subtitle is displayed properly.

DivX disc compatibility with this player is limited as follows:

- Available resolution size of the DivX file is under 800x600 (W x H) pixel.
- The file name of the DivX subtitle is available by 45 characters.
- If there is impossible code to express in the DivX file, it may be displayed as " _ " mark on the display.
- **If the number of the screen frame is over 30 per 1 second, this unit may not operate normally.**
- **If the video and audio structure of recorded files are not interleaved, either video or audio is outputted.**

Playable DivX file : ".avi ", ".mpg ", ".mpeg ", ".divx"

Playable Subtitle format : SubRip(*.srt/*.txt) ,SAMI(*.smi), SubStation Alpha(*.ssa/*.txt) MicroDVD(*.sub/*.txt) SubViewer 2.0(*.sub/*.txt) VobSub(*.sub)

Playable Codec format : "DIVX3.xx ", "DIVX4.xx ", "DIVX5.xx ", "MP43 ", "3IVX "

Playable Audio format : "AC3 ", "DTS (MDS713) ", "PCM ", "MP3 ", "WMA "

- Sampling frequency: within 32 - 48 kHz (MP3),within 32 - 48kHz (WMA)
- Bit rate: within 32 - 320kbps (MP3), 40 - 192kbps (WMA)

Listening to Audio CD, MP3 or WMA files

	ON PLAYER	ON REMOTE
1. Open the disc tray:	OPEN ▲	
2. Insert a Disc:	-	
3. Close the disc tray:	OPEN ▲	
4. Select a music file from the menu:	MULTI JOG	▲ ▼
5. To Start playback:	▶	▶ PLAY/ SELECT/ENTER
6. To stop playback:	■ STOP	■ STOP

Listening to Audio CD, MP3 or WMA files - more you can do

Creating your own program

You can play the contents of a disc in the order you want by arranging the order of the musics on the disc. The program is cleared when the disc is removed. Select a desired music then press PROG./MEMO. or select " " and then press SELECT/ENTER to add the music to the program list. To add all music in the disc, select " " and then press SELECT/ENTER. Select a music from the program list then press SELECT/ENTER to start programmed playback. To clear a music from the program list, select the music you want to clear then press CLEAR or select " " icon and then press SELECT/ENTER. To clear all music from the program list, select " " then press SELECT/ENTER.

Displaying file information (ID3 TAG)

While playing a MP3 file containing file information, you can display the information by pressing DISPLAY repeatedly.

MP3 / WMA disc compatibility with this player is limited as follows:

- Sampling frequency: within 32 - 48 kHz (MP3), within 24 - 48kHz (WMA)
- Bit rate: within 32 - 320kbps (MP3), 40 - 192kbps (WMA)
- The unit cannot read an MP3/WMA file that has a file extension other than ".mp3" / ".wma".
- CD-R physical format should be ISO 9660
- If you record MP3 / WMA files using software that cannot create a file system (eg. Direct-CD) it is impossible to playback MP3 / WMA files. We recommend that you use Easy-CD Creator, which creates an ISO 9660 file system.
- File names should have a maximum of 8 letters and must incorporate an .mp3 or .wma extension.
- They should not contain special letters such as / ? * : " < > | etc.
- The total number of files on the disc should be less than 999.

This unit requires discs and recordings to meet certain technical standards in order to achieve optimal playback quality. Pre-recorded DVDs are automatically set to these standards. There are many different types of recordable disc formats (including CD-R containing MP3 or WMA files) and these require certain pre-existing conditions (see above) to ensure compatible playback.

Customers should note that permission is required in order to download MP3 / WMA files and music from the Internet. Our company has no right to grant such permission. Permission should always be sought from the copyright owner.

Viewing photo files

	ON PLAYER	ON REMOTE
1. Open the disc tray:	OPEN▲	
2. Insert a Disc:	-	
3. Close the disc tray:	OPEN▲	
4. Select a photo file on the menu:	MULTI JOG	▲▼
5. Display the selected file in full screen:	▶	SELECT/ENTER
6. To stop playback:	■ STOP	■ STOP

Viewing photo files - more you can do

Viewing photo files as a slide show

Use ▲▼◀▶ to highlight () icon then press SELECT/ENTER to start slide show.

You can change slide show speed using ◀▶ when () icon is highlighted.

Skip to the next/previous photo

Press SKIP (◀◀ or ▶▶) to view the previous/next photo.
Or use the MULTI JOG on the front panel by turning to left or right.

Rotate a photo

Use ▲▼◀▶ to rotate the photo in full screen.

Pause a slide show

Press PAUSE/STEP (||) to pause a slide show. Press PLAY to continue the slide show.

JPEG disc compatibility with this player is limited as follows:

- Depending upon the size and the number of JPEG files, it could take a long time for the this unit. to read the disc's contents. If you don't see an on-screen display after several minutes, some of the files may be too large — reduce the resolution of the JPEG files to less than 2M pixels as 2760 x 2048 pixels and burn another disc.
- The total number of files and folders on the disc should be less than 999.
- Some discs may not operate due to a different recording format or the condition of disc.
- Ensure that all the selected files have the “.jpg” extensions when copying into the CD layout.
- If the files have “.jpg” or “.jpeg” extensions, please rename them as “.jpg” file.
- File names without “.jpg” extension will not be able to be read by this unit. Even though the files are shown as JPEG image files in Windows Explorer.

Listening to the radio - more you can do**Look for radio stations automatically**

Press ◀◀ / ▶▶ on the front panel (or press **TUN.- /TUN.+** on the remote control) for more than 0.5 second. The tuner will scan automatically and stop when it finds a radio station.

Delete all the saved stations

Press and hold **PROG./MEMO.** for two seconds. “ERASE ALL” shows. Press **PROG./MEMO.** to erase all the saved stations.

Choose a ‘preset number’ for a radio station

Select a station you want by turning **MULTI JOG** on the front panel or **TUN.- /TUN.+** on the remote control. Press **PROG./MEMO.**, the station flashes. Press **PRESET (+/-)** on the remote control to select the preset number you want. Press **PROG./MEMO.** to save it.

If a FM program is noisy ; Press **ST./MO.** repeatedly so that “MONO” appears in the display window. There will be no stereo effect, but the reception will improve. Press **ST./MO.** again to restore the stereo effect.
To improve reception; Reposition the supplied antennas.

Listening to the radio

	ON PLAYER	ON REMOTE
1. Select FM/ AM:	TUNER	FUNCTION
2. Select the radio station:	MULTI JOG	TUN.- / TUN.+
3. To ‘save’ a radio station: A preset number will show in the display.		PROG./MEMO.
4. To select a ‘saved’ station:	◀ ▶	PRESET(+/-)
5. To confirm press: Up to 50 radio stations can be saved		PROG./MEMO.

Listening to the cassette tapes

	ON PLAYER	ON REMOTE
1. Open the tape door:	▲PUSH EJECT	
2. Insert the tape:		
3. Close the tape door:		
4. Select the TAPE function:	TAPE	FUNCTION
5. Start the tape playing:	▶ or ◀	▶ or ▶ one more
6. To stop a tape playing:	■ STOP	■ STOP

Listen to cassette tapes - more you can do

Play Fast backward or Forward

After pressing ◀◀ or ▶▶ during playback, or stop, press ▶ (or ▶ again on the remote) at a point you want.

Auto Stop Deck :

After playing one side of the tape, the unit stop automatically.

Auto Reverse Deck :

You can select direction of the cassette you want by pressing the **REVERSE MODE** button repeatedly.

Press **TAPE** to select Tape .You can set the tape to play one side ⇄ , both sides ⇄ , or both sides six times (⇄) , by pressing **REVERSE MODE** one or more times.

Dubbing

This function shows how to record from tape to tape
Press **TAPE** to select tape function.

TAPE1 - Insert a playback tape to dub.

TAPE2 - Insert a blank tape.

Press **DUBB.** as show below. to stop dubbing, press ■ **STOP**.

Tape Recording

Recording from Audio CD to cassette

	ON PLAYER	ON REMOTE
1. Open the tape door:	▲ PUSH EJECT	
2. Insert a blank tape:		
3. Close the tape door:		
4. Selects the (DVD/CD) mode	DVD/CD	FUNCTION
5. Press: Appears "USB REC" or "TAPE REC" on the display window	REC./II	●/II
6. Selects "TAPE REC"	REC./II	●/II
7. To stop a Recording:	■ STOP	■ STOP

Recording from other source to cassette

	ON PLAYER	ON REMOTE
1. Open the tape door:	▲ PUSH EJECT	
2. Insert a blank tape:		
3. Selects the (TUNER/AUX/USB/PORTABLE) function:	TUNER, AUX/ PORTABLE or USB)	FUNCTION
4. Press: "REC" will blink on the display window.	REC./II	●/II
5. To Start the Recording:	REC./II	●/II
6. To pause a Recording:	REC./II	●/II
To stop a Recording:	■ STOP	■ STOP

CD Synchronized Recording

	ON PLAYER	ON REMOTE
1. Open the tape door:	▲ PUSH EJECT	
2. Insert a blank tape:		
3. Select the DVD/CD function:	DVD/CD	FUNCTION
4. Start the Recording in the stop mode : The synchronized recording is started automatically after about 7 seconds.	DUBB./CD SYNC./ST.MO.	
5. To stop a Recording:	■ STOP	■ STOP

Listening to music from your portable player

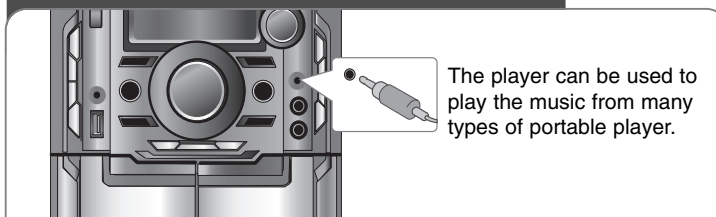

	ON PLAYER	ON REMOTE
1. Connect the portable player by plugging the unit into PORT. IN on the side of the player:		
2. Turn the power on:	STANDBY/ON	POWER
3. Select the PORTABLE function:	AUX/PORTABLE	INPUT
4. Turn the portable player on and start it playing:		

Connecting your portable USB player

The advantage of connecting your portable USB player through the system's USB port is that the portable device can be controlled from the system. Connect the portable player to the system using a USB cable (not supplied).

	ON PLAYER	ON REMOTE
1. Select the USB function:	USB	INPUT
2. The display will show "SEARCHING", followed by the number of files displayed:		
3. Select a Title MENU :		TITLE
4. start selected file:	▶	SELECT/ENTER
5. Before disconnecting the portable USB player, change to any other function by pressing:	(TUNER/AUX/PORTABLE/TAPE/DVD/CD)	FUNCTION or INPUT
6. Remove : the USB player		

Compatible USB Devices

- Devices which require additional program installation when you have connected it to a computer, are not supported.
- MP3 Player : Flash type MP3 player.
The MP3 player requiring installation of a driver is not supported.
- USB Flash Drive : Devices that support USB2.0 or USB1.1.

USB device requirement

- **Do not extract the USB device in operating.**
- A back up demands to prevent a data damage.
- If you use a USB extension cable or USB hub, the USB device might not be recognized.
- A device using NTFS file system is not supported. (Only FAT (16/32) file system is supported.)
- The USB function of this unit does not support all USB devices.
- Digital camera and mobile phone are not supported.
- This unit is not supported when the total number of files is 1000 or more.
- If the drive of USB device is two or more, a drive folder is displayed on the screen. If you want to move to the previous menu after you select a folder, press RETURN.

USB Direct Recording

Record AUDIO CD source to USB

This function enable you to record music to a connected USB storage device from Audio CD

	ON PLAYER	ON REMOTE
1. Select the DVD/CD mode:	DVD/CD	FUNCTION
2. Select the track (file) :	MULTI JOG	◀◀/▶▶
3. Press Appears "USB REC" or "TAPE REC" on the display window.	REC./II	●/II
4. Selects "USB REC" :	REC./II	●/II
5. To stop a Recording:	■ STOP	■ STOP

USB Direct Recording - more you can do

Record AUDIO CD source to USB

One track recording : If the usb recording is played during playback of the cd, the only track would be recording into the USB.

All track recording: If the usb REC button is pressed at the CD stop, all track would be recording.

Program list recording: USB Records after selecting the tracks pressing the PROG./MEMO. button if you want to record the track you want.

NOTES :

- When you start the USB direct recording ,you can check the Recording percentage rate for the USB record on the display window during the recording.
- During the recording is no sound and not operate for volume .
- When you stop recording during playback ,the file that has been recorded at that time will be stored
- If you disconnect the USB without STOP button while recording ,the file can not delete in the PC.
- It is impossible to record from " MIC IN"
- Playable USB REC. Bit rate : 96/128kbps (Refer to the SET UP page)
- During USB record can not operate Pause key for Audio CD only.
- Multicard reader device can not be use for USB record.
- USB port of the unit can not be connected to PC. The unit can not be used as a storage device.
- If the USB can not record appears "NO USB","ERROR","USB FULL" , "NO REC" on the display window.
- File will be stored to CD_REC folder in a format "TRK_001.mp3".
- In the state CD-G ,DTS disc USB Record is not operated.
- If you record more 999 files on CD_REC folder appears "ERROR" on the display.
- New files are numbered in numeric sequence. if the total number of the files are more than 999, delete some or store some in PC.
- External HDD,Card reader, Locked device and MP3 player is not supported.

The making of unauthorized copies of copy-protected material, including computer programs, files, broadcasts and sound recordings, may be an infringement of copyrights and constitute a criminal offence.

This equipment should not be used for such purposes.

**Be responsible
Respect copyrights**

Language Codes

Use this list to input your desired language for the following initial settings: Disc Audio, Disc Subtitle, Disc Menu.

Language	Code	Language	Code	Language	Code	Language	Code	Language	Code	Language	Code
Afar	6565	Croatian	7282	Hausa	7265	Lingala	7678	Quechua	8185	Tajik	8471
Afrikaans	6570	Czech	6783	Hebrew	7387	Lithuanian	7684	Rhaeto-Romance	8277	Tamil	8465
Albanian	8381	Danish	6865	Hindi	7273	Macedonian	7775	Rumanian	8279	Telugu	8469
Ameharic	6577	Dutch	7876	Hungarian	7285	Malagasy	7771	Russian	8285	Thai	8472
Arabic	6582	English	6978	Icelandic	7383	Malay	7783	Samoan	8377	Tonga	8479
Armenian	7289	Esperanto	6979	Indonesian	7378	Malayalam	7776	Sanskrit	8365	Turkish	8482
Assamese	6583	Estonian	6984	Interlingua	7365	Maori	7773	Scots Gaelic	7168	Turkmen	8475
Aymara	6588	Faroese	7079	Irish	7165	Marathi	7782	Serbian	8382	Twi	8487
Azerbaijani	6590	Fiji	7074	Italian	7384	Moldavian	7779	Serbo-Croatian	8372	Ukrainian	8575
Bashkir	6665	Finnish	7073	Javanese	7487	Mongolian	7778	Shona	8378	Urdu	8582
Basque	6985	French	7082	Kannada	7578	Nauru	7865	Sindhi	8368	Uzbek	8590
Bengali, Bangla	6678	Frisian	7089	Kashmiri	7583	Nepali	7869	Singhalese	8373	Vietnamese	8673
Bhutani	6890	Galician	7176	Kazakh	7575	Norwegian	7879	Slovak	8375	Volapük	8679
Bihari	6672	Georgian	7565	Kirghiz	7589	Oriya	7982	Slovenian	8376	Welsh	6789
Breton	6682	German	6869	Korean	7579	Panjabi	8065	Spanish	6983	Wolof	8779
Bulgarian	6671	Greek	6976	Kurdish	7585	Pashto, Pushto	8083	Sudanese	8385	Xhosa	8872
Burmese	7789	Greenlandic	7576	Laothian	7679	Persian	7065	Swahili	8387	Yiddish	7473
Byelorussian	6669	Guarani	7178	Latin	7665	Polish	8076	Swedish	8386	Yoruba	8979
Chinese	9072	Gujarati	7185	Latvian, Lettish	7686	Portuguese	8084	Tagalog	8476	Zulu	9085

Area Codes

Choose a area code from this list.

Area	Code	Area	Code	Area	Code	Area	Code	Area	Code	Area	Code
Afghanistan	AFT	Costa Rica	CR	Greenland	GL	Maldives	MV	Paraguay	PY	Sri Lanka	LK
Argentina	AR	Croatia	HR	Hong Kong	HK	Mexico	MX	Philippines	PH	Sweden	SE
Australia	AU	Czech Republic	CZ	Hungary	HU	Monaco	MC	Poland	PL	Switzerland	CH
Austria	AT	Denmark	DK	India	IN	Mongolia	MN	Portugal	PT	Taiwan	TW
Belgium	BE	Ecuador	EC	Indonesia	ID	Morocco	MA	Romania	RO	Thailand	TH
Bhutan	BT	Egypt	EG	Israel	IL	Nepal	NP	Russian Federation	RU	Turkey	TR
Bolivia	BO	El Salvador	SV	Italy	IT	Netherlands	NL	Saudi Arabia	SA	Uganda	UG
Brazil	BR	Ethiopia	ET	Jamaica	JM	Netherlands Antilles	AN	Senegal	SN	Ukraine	UA
Cambodia	KH	Fiji	FJ	Japan	JP	New Zealand	NZ	Singapore	SG	United States	US
Canada	CA	Finland	FI	Kenya	KE	Nigeria	NG	Slovak Republic	SK	Uruguay	UY
Chile	CL	France	FR	Kuwait	KW	Norway	NO	Slovenia	SIB	Uzbekistan	UZ
China	CN	Germany	DE	Libya	LY	Oman	OM	South Africa	ZA	Vietnam	VN
Colombia	CO	Great Britain	GB	Luxembourg	LU	Pakistan	PK	South Korea	KR	Zimbabwe	ZW
Congo	CG	Greece	GR	Malaysia	MY	Panama	PA	Spain	ES		

Troubleshooting

Symptom	Cause	Correction
POWER		
No power	The power cord is not plugged in.	Plug in the power cord.
RADIO		
No sound	The function switch is not set to the Radio mode.	Set the switch to the Radio mode.
Some noise occurs.	There are electronic devices near the player.	Set the player far from the devices.
	The antenna is positioned or connected poorly	Check the antenna connection and adjust its position
DVD/CD		
The unit does not start playback	An unplayable disc is inserted. The disc is placed upside down.	Insert a playable disc. Place the disc with the playback side down.
No picture	The disc is not placed within the guide.	Place the disc on the disc tray correctly inside the guide. Clean the disc.
	The TV is not set to receive the video signal	Select the appropriate video input model on the TV so the picture from the unit appears on the TV
REMOTE CONTROL		
The remote control does not work properly.	The remote control is not pointed at the remote sensor of the unit directly.	Point the remote control to front panel directly of the unit.
	The batteries in the remote control are exhausted.	Replace the batteries with new ones.
TAPE		
Unable to record	Record protect tabs are removed.	Cover holes on back edge of tape with tap.

Specifications

jGeneral				
Power supply	Refer to main label.			
Power consumption	Refer to main label.			
Net Weight	6.2 kg			
External dimensions (W x H x D)	273 x 326 x 380 mm			
Operating conditions	Temperature: 5°C to 35°C, Operation status: Horizontal			
Operating humidity	5% to 85%			
Tuner				
FM Tuning Range	87.5 - 108.0 MHz or 65.0 - 74.0 MHz, 87.5 - 108.0 MHz			
Intermediate Frequency	10.7 MHz			
AM Tuning Range	522 - 1,620 kHz or 520 - 1,720 kHz			
Intermediate Frequency	450 kHz			
Amplifier				
OUTPUT POWER	Front: 130 W + 130 W (4Ω, THD 10 %) Surround : 90 W + 90 W (6 Ω, THD 10 %) Center : 90W (6 Ω, THD 10 %) Subwoofer: 180 W (3 Ω, THD 10 %)			
DVD/VCD/CD player			Cassette tape player	
Frequency response (audio)	40 - 20000 Hz		F.F/REW Time	120 sec (C-60)
Signal-to-noise ratio (audio)	More than 75 dB (1 kHz)		Frequency Response	250 - 8000 Hz
Signal-to-noise ratio (video)	More than 55 dB (1 kHz)		Signal to Noise Ratio	43 dB
Dynamic range (audio)	More than 80 dB		Channel Separation	50 dB (P/B)/45 dB (R/P)
Video output	1.0 V (p-p), 75 Ω		Erase Ratio	55 dB (MTT-5511)
Component Video output	(Y) 1.0 V (p-p), 75 Ω (Pb)/(Pr) 0.7 V (p-p), 75 Ω			
Speakers				
	MDS263V	MDS713C	MDS713S	MDS713W
	MDS713V	Center Speaker	Surround Speaker	Subwoofer
	Front Speaker			
Type	2 Way 3 Speaker	1way 2 speaker	2way 2 speaker	1way 1 speaker
Impedance	4 Ω	6Ω	6 Ω	3 Ω
Rated Input Power	130 W	90 W	90 W	180W
Max. Input Power	260W	180 W	180W	360W
Net Dimensions (W x H x D)	212x 413x 301mm	273x 110x 161 mm	212 X 325 X 263 mm	273 X 325 X 372 mm
Net Weight	5.5 kg	1.76kg	3.4 kg	7.03 kg

Designs and specifications are subject to change without prior notice.

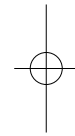
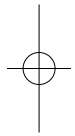
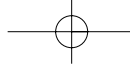

P/NO : MFL42712916

