



**LG**

**MDD112**

(MDD112-A/D/X0U, MDS112V)

**MDD72**

(MDD72-A/D/X0U, MDS72V)

**English**

## **Mini Home Theater**

Read the manual carefully before using the unit.

**FRENCH**

## **Mini Home Theater**

Veillez lire attentivement le présent manuel avant d'utiliser l'appareil.





**WARNING:** TO REDUCE THE RISK OF ELECTRIC SHOCK DO NOT REMOVE COVER (OR BACK) NO USER-SERVICEABLE PARTS INSIDE REFER SERVICING TO QUALIFIED SERVICE PERSONNEL.



This lightning flash with arrowhead symbol within an equilateral triangle is intended to alert the user to the presence of uninsulated dangerous voltage within the product's enclosure that may be of sufficient magnitude to constitute a risk of electric shock to persons.



The exclamation point within an equilateral triangle is intended to alert the user to the presence of important operating and maintenance (servicing) instructions in the literature accompanying the appliance.

**WARNING:** TO REDUCE THE RISK OF FIRE OR ELECTRIC SHOCK, DO NOT EXPOSE THIS PRODUCT TO RAIN OR MOISTURE.

**CAUTION:** Do not block any ventilation openings. Install in accordance with the manufacturer's instructions.

Slots and openings in the cabinet are provided for ventilation and to ensure reliable operation of the product and to protect it from over heating.

The openings should be never be blocked by placing the product on a bed, sofa, rug or other similar surface. This product should not be placed in a built-in installation such as a bookcase or rack unless proper ventilation is provided or the manufacturer's instruction have been adhered to.

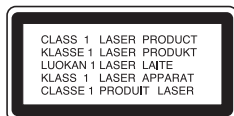

**CAUTION:**

This Product employs a Laser System.

To ensure proper use of this product, please read this owner's manual carefully and retain for future reference, should the unit require maintenance, contact an authorized service location-see service procedure.

Use of controls, adjustments or the performance of procedures other than those specified herein may result in hazardous radiation exposure.

To prevent direct exposure to laser beam, do not try to open the enclosure. Visible laser radiation when open. **DO NOT STARE INTO BEAM.**

**CAUTION:** The apparatus shall not be exposed to water, dripping or splashing and that no objects filled with liquids, such as vases, shall be placed on the apparatus.

**CAUTION concerning the Power Cord**

**Most appliances recommend they be placed upon a dedicated circuit;**

That is, a single outlet circuit which powers only that appliance and has no additional outlets or branch circuits. Check the specification page of this owner's manual to be certain.

Do not overload wall outlets. Overloaded wall outlets, loose or damaged wall outlets, extension cords, frayed power cords, or damaged or cracked wire insulation are dangerous. Any of these conditions could result in electric shock or fire.

Periodically examine the cord of your appliance, and if its appearance indicates damage or deterioration, unplug it, discontinue use of the appliance, and have the cord replaced with an exact replacement part by an authorized servicer.

Protect the power cord from physical or mechanical abuse, such as being twisted, kinked, pinched, closed in a door, or walked upon. Pay particular attention to plugs, wall outlets, and the point where the cord exits the appliance.

To disconnect power from the mains, pull out the mains cord plug. When installing the product, ensure that the plug is easily accessible.

**POWER SAVE MODE**

You can set up the unit into an economic power save mode.

In power-on status, press and hold (POWER) button for about 3 seconds.

- Nothing is displayed in the display window when the unit goes into the power save mode.

To cancel power save mode, press (POWER).

# Introduction

## Installation

TV Connection	4
Antenna Connection	4
Speaker system connection	5
Optional Equipment Connection	5

## Operation

Operate using the front Panel	5
Operate using the Remote Control	6
Additional features	9

## Setup

Initial Settings	10
------------------	----

## Playing an Audio CD or MP3/WMA/JPEG/DivX file

Playing an Audio CD or MP3/WMA file	12
Programmed Playback	12
Viewing a JPEG file	12
Playing a DivX Movie file	13

## Presetting the Radio Stations / Listening

Presetting the radio stations	14
Listening to the radio	14

## RDS Operation - Optional

Timer function	16
Setting the Clock	16
Timer Function	16

## Operation with TAPE

## Reference

Language Codes	18
Area Codes	18
Troubleshooting	19
Specifications	





## Before use

### About the symbol display

“” may appear on the TV screen during operation. This icon means the function explained in this owner's manual is not available on that specific DVD video disc.

### About the disc symbols for instructions

A section of which title has one of the following symbols is applicable only to the disc represented by the symbol.

-  DVD
-  Audio CDs
-  MP3 file
-  WMA file
-  JPEG file
-  DivX file



## About the symbols for instructions

**Caution** Indicates hazards likely to cause harm to the unit itself or other material damage.

**Note** Indicates special operating features of this unit.

**Tip** Indicates tips and hints to make the task easier.

## Playable Discs

	DVD (8 cm / 12 cm disc)
	Audio CD (8 cm / 12 cm disc)

In addition, this unit can play a DVD±R, DVD±RW and CD-R or CD-RW that contains audio titles, MP3, WMA, JPEG or DivX files.

## Note

- Depending on the conditions of the recording equipment or the CD-R/RW (or DVD±R/RW) disc itself, some CD-R/RW (or DVD±R/RW) discs cannot be played on the unit.
- Do not attach any seal or label to either side (the labeled side or the recorded side) of a disc.
- Do not use irregularly shaped CDs (e.g., heart-shaped or octagonal). It may result in malfunctions.

## Regional Code

This unit has a regional code printed on the rear of the unit. This unit can play only DVD discs labelled as the same as the rear of the unit or “ALL”.

## Notes on Regional Codes

- Most DVD discs have a globe with one or more numbers in it clearly visible on the cover. This number must match your unit's regional code or the disc cannot play.
- If you try to play a DVD with a different regional code from your player, the message “Check Regional Code” appears on the TV screen.

## Installation

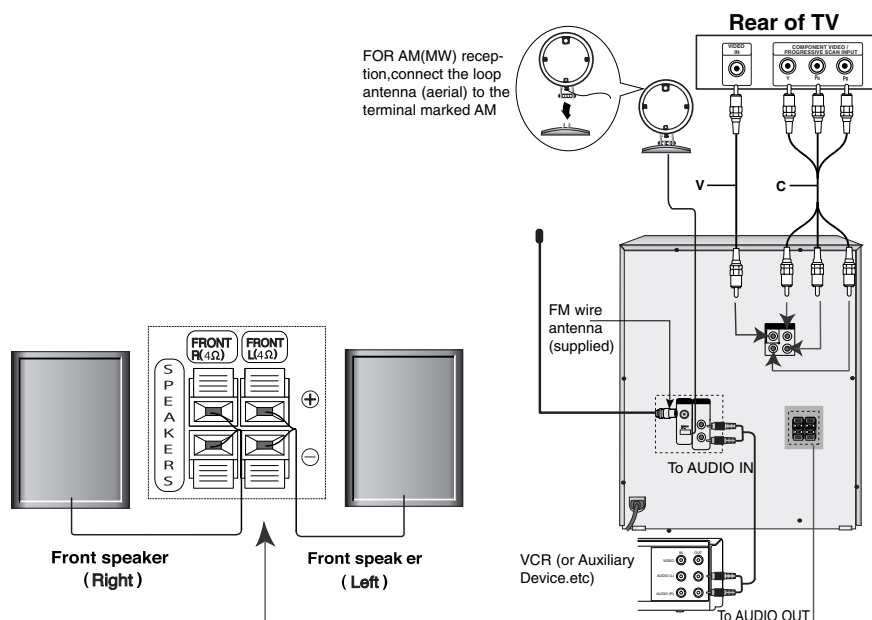

### TV Connection

#### Tip

- Depending on your TV and other equipment you wish to connect, there are various ways you could connect the unit. Use one of the connections described below.
- Please refer to the manuals of your TV, VCR, Stereo System or other devices as necessary to make the best connections.

#### Caution

- Make sure the unit is connected directly to the TV. Select the correct AV input on your TV.
- Do not connect your unit to TV via your VCR. The DVD image could be distorted by the copy protection system.
- If your television is a high-definition or “digital ready” television, you may take advantage of the DVD/CD unit’s progressive scan output for higher video resolution.
- If your TV does not accept your resolution setting, abnormal picture appears on the screen. Please read owner’s manual for TV then set the resolution that your TV can accept.

#### Video connection

Connect the VIDEO OUT jack from the unit to the VIDEO IN jack on the TV using the video cable supplied (V).

#### Component Video connection

Connect the COMPONENT VIDEO OUT (PROGRESSIVE SCAN) (Y PB PR) jacks from the unit to the corresponding jacks on the TV using a Y PB PR cable (C).

#### Progressive Scan connection

- If your television is a high-definition or “digital ready” television, you may take advantage of this unit’s progressive scan output for higher video resolution.
- If your TV does not accept the Progressive Scan format, the picture will appear scrambled if you try Progressive Scan on the unit.

Connect the COMPONENT VIDEO OUT (PROGRESSIVE SCAN) (Y PB PR) jacks from the unit to the corresponding jacks on the TV using an optional Y PB PR cable (C).

### Antenna Connection

Connect the supplied FM/AM antennas to listen to the radio.

- Connect the AM loop antenna to the AM antenna connector.
- Connect the FM wire antenna to the FM antenna connector.

#### Note

- To prevent noise pickup, keep the AM loop antenna away from the unit and other component.
- Be sure to fully extend the FM wire antenna.
- After connecting the FM wire antenna, keep it as horizontal as possible.

## Speaker System Connection

Connect the speaker wires the speaker terminals.

### Note

- Be sure to match the speaker wires to the appropriate terminal on the components, + to + and – to –. If the cables are reversed, the sound will be distorted and will lack bass.
- If you use front speakers with low maximum input rating, adjust the volume carefully to avoid excessive output on the speakers.

## Optional Equipment Connection

You can use VCR or other unit connected to the AUX connector.

## Operation

### Operation using the front Panel

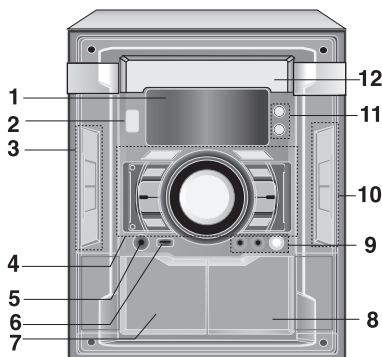

1. **DISPLAY WINDOW**
2. **(/I)POWER button**
3. **• CD SYNCHRO RECORDING (CD SYNC./ DUBBING (DUBB.)/ (ST./MONO) button**
  - EQ button
  - REC/II button
  - USB / DEMO button

**DEMO** : Press **DEMO** in power off state to demonstrate the function in the display window.  
To cancel it, press (/I)POWER or **DEMO** again. During demonstration in power-on status, you can cancel it by using the **CLOCK**, **TIMER** buttons.
4. **• XDSS/MP3 OPT.button**
  - XTS-PRO button
  - FUNCTION SELECT buttons (TUNER,TAPE,AUX, CD/DVD)
  - CD SKIP/SEARCH (,,,), CD SCAN (,,,)
  - REWIND/ FAST FORWARD - TAPE, TUNING (-/+) (,,,),
  - PRESET (-) button
  - PRESET (+)/ FORWARD PLAY () button
  - Volume control knob
5. **HEADPHONE Jack (PHONES): ∅ 3.5 mm**

### 6. USB () port

Connect the USB port of a USB Memory (or MP3 player ,etc.) to the USB port on the front of the unit.

#### Removing the USB device from the unit

- 1.Choose a other functions except USB function in order to remove the USB.
- 2.Remove the USB device from the unit

#### Note

Besides Basic Playback, if you want to operate other functions, see the CD Playback section.

- Don't extract the USB device while operating.
- Music files (MP3/WMA), image files (JPEG) and Video files can be played.
- This unit cannot use a USB HUB.
- Recommended Memory Cards.  
Compact Flash Card (CFC), Micro Drive (MD), Smart Media Card (SMC), Memory Stick (MS), Secure Digital Card (SD), Multimedia Card (MMC), Memory Stick Pro (MS-Pro)  
- Compatible with: FAT16, FAT32  
- Only use the memory cards recommended.
- Devices which require additional program installation when you have connected the unit to a computer are not supported.
- In case of a USB HDD, make sure to connect an auxiliary power cord to the USB HDD for proper operation. Up to four primary partitions of a drive are supported. If there is an extension partition, it will not be supported.
- If the drive of USB device is two or more, a drive folder is displayed on the screen. If you want to move to the initial menu after you select a folder, press RETURN.
- Digital cameras and mobile phones are not supported.

- 7 **▲ PUSH EJECT position (TAPE 1)**
8. **▲ PUSH EJECT position (TAPE 2)**
9. **• MIC VOLUME(MIC VOL.) knob : OPTIONAL**  
• MIC Jacks (MIC1/ MIC2): ∅3.5 mm : OPTIONAL
10. **• OPEN/CLOSE (▲ OP./CL.) button**
  - DISC SKIP (D.SKIP) button
  - SET/CD/II/RDS-OPTIONAL
  - STOP (■) button
- 11 **• TIMER button**
  - CLOCK button
12. **DISC DOOR**

## Operate using the Remote Control

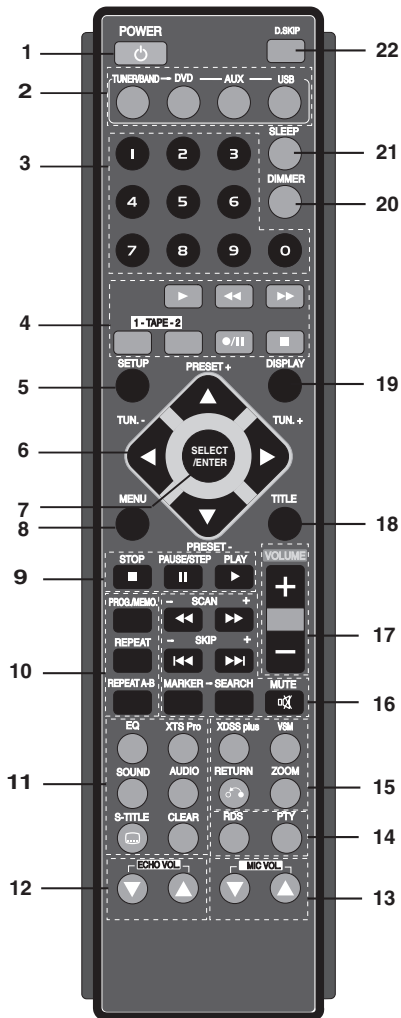

1. **POWER** (⏻)
2. **FUNCTION SELECT**  
(TUNER/BAND, DVD, AUX, USB)
3. **NUMERIC buttons (0-9)**  
Selects a service, program number directly or selects numbered options in a menu.
4. **TAPE FUNCTION**
  - **PLAY** (▶)
  - **REWIND/ FAST FORWARD PLAY** (◀◀ / ▶▶)
  - **TAPE 1-2 SELECT buttons (1-TAPE-2)**
  - **RECORD/ RECORD PAUSE** (●/||)
  - **TAPE STOP** (■)

### 5. SETUP

6. • **Arrow buttons** ◀/▶/▲/▼ (left/right/up/down)  
(Selects an option in the menu)
  - **PRESET +/- (▲/▼)**  
Press PRESET +/- repeatedly to select the preset station you want.  
Each time you press the button, the unit tunes in one preset station at a time.  
Preset radio stations in the unit's memory first (see "Presetting radio stations")
  - **TUN.(-/+) (◀/▶)**  
For manual tuning, press TUN (-/+) repeatedly  
For automatic tuning, press and hold TUN. (-/+) for about two seconds on the front panel.

### 7. SELECT/ENTER

Acknowledges the menu selection.

### 8. MENU

Accesses the menu on a DVD disc.

### 9. • STOP (■)

#### • PAUSE(II)/ STEP

During playback, press II to pause playback.

#### • ALL

Press II repeatedly to play Frame-by-Frame.

#### • DVD DivX

#### • PLAY (▶)

- To Play disc and file

### 1.5 speed playback (DVD MP3 WMA ACD)

You can quickly enjoy a movie and music.

The 1.5 speed allows you to watch the pictures and listen to the sound quicker than playing at a normal speed on the disc.

1. Press the PLAY button during the normal playback.  
The screen will appear at 1.5 speed with sound .
2. To return to normal PLAY, press PLAY.

### 10. • PROG./MEMO.

Accesses or removes Program menu.  
Enter a radio station's frequency into the tuner.

#### • REPEAT

During playback, press REPEAT repeatedly to select a desired repeat mode.

DVD Video discs: Chapter/Title/Off

Audio CD, DivX/MP3/WMA discs: Track/All/Off

#### • REPEAT A-B (DVD)

During playback, press REPEAT A-B to select a point A and a point B and repeats a sequence from point A (Starting point) to point B (End point).  
Press REPEAT A-B to exit.

#### Note

The A-B repeat function is available only in the current title.

**11. • EQ (EQUALIZER Effect)**

You can choose 7 fixed sound impressions and adjust the BASS, MIDDLE and TREBLE.

-You can select a desired sound mode by using **EQ** button on the front panel or the remote control. When you want to change a sound mode press the **EQ** button repeatedly within 3 seconds. Each time you press the button the setting changes in the display window as shown below.

NORMAL → ARABIC → USER EQ → POP → CLASSIC → ROCK → DRAMA → JAZZ → NORMAL...

You can set the BASS, MIDDLE and TREBLE on the USER EQ mode.

1. Select the USER EQ mode by using **EQ** button. "USER EQ" will be displayed in the display window.
2. Press the **SET/CDII** button on the front panel when "USER EQ" is displayed in the display window. "BASS 0" will be displayed in the display window
3. Select the BASS, MIDDLE or TREBLE you want by pressing the **PRESET (-/+)** buttons on the front panel.
4. Press the **TUNING (-/+)** buttons on the front panel to set the sound level you want. (MIN, -4 ~ +4, MAX steps)
5. Repeat the 3-4 steps as above.
6. When the sound level is completed, press the the **SET/CDII** button on the front panel.

**• XTS- Pro**

This unique sound quality developed by our technology creates the optimum sound for you to play the perfect playback of the original sound and to feel the living sound source.

Each time you press XTS Pro the setting changes in the following order.

XTS -- P ON ↔ NORMAL

**Note** : The XTS Pro function will not be operated when a headphone has been connected

**• SOUND**

You can enjoy surround sound simply by selecting one of the pre-programmed sound fields according to the program you want to listen to (2 ch. sound only). Press **SOUND** button repeatedly.

BYPASS → ON STAGE → STUDIO → CLUB → HALL → THEATER 1 → CHURCH → BYPASS...

**Note** : Initial sound mode is BYPASS.

**• AUDIO**

**AUDIO language**: During playback, press **AUDIO** repeatedly to hear a different audio language or audio track. **DVD DivX**

(**AUDIO channel**): Press **AUDIO** repeatedly during playback to hear a different audio channel (Stereo., Left or Right).

**• SUBTITLE (S-TITLE)**

**SUBTITLE DVD DivX**

During playback, press **S-TITLE** repeatedly to select a desired subtitle language.

**• CLEAR**

Removes a track number on the program menu or a mark on the **MARKER SEARCH** menu.

**12. ECHO VOL. (●/●)**

You can give an echo effect to the sound from the microphones. Press **ECHO VOL. (●/●)** on the remote control to increase the echo volume or decrease it. (MIN, 1 - 14, MAX steps)

**13. MIC VOL. (●/●)- OPTIONAL**

Adjust the microphone volume by turning MIC volume knob. (MIN, 1 - 14, MAX steps)

**Note**

- When not using the microphone, set the MIC volume knob to minimum or turn off the MICs and remove the microphone from the MIC Jacks.
- If the microphone is set too near the speaker, a howling sound may be produced. In this case, move the microphone away from the speaker or decrease the sound level by using the MIC volume control.
- If sound through the microphone is extremely loud, it may be distorted. In this case, turn the MIC volume control toward minimum.

**14. RDS.PTY - OPTIONAL**

Views the various displays of the RDS options.

**15. • XDSS plus/ MP3 OPT.**

**XDSS (Extreme Dynamic Sound System)**

Press **XDSS plus** to reinforce treble, bass and the surround effect. The "XDSS ON" or "NORMAL" indicator lights.

**DVD/DivX/ACD** : XDSS ON ↔ NORMAL

**MP3/WMA** : XDSS ON → MP3 -- OPT ON  
→ NORMAL → XDSS ON .

**MP3 Optimizer**

This function optimizes for compressed MP3 files.

It improves the bass sound to make sweet sound. Each time you press "**MP3 OPT**".

The setting changes in the following order.

XDSS ON → MP3 -- OPT ON → NORMAL

• **VSM (Virtual Sound Matrix)**

Press **VSM** to set the VIRTUAL sound.

Source	Display	Effect
2.1 ch.	VIRTUAL	3D STEREO
5.1 ch	VIRTUAL	Virtual surround

● **3D STEREO**

Realtime 3D positioned sound rendering technology with stereo sources, optimized for stereo speakers. Listeners may experience amazing virtual surround effects with their own multimedia players.

● **Virtual surround**

A patent pending downmix technology converts 5.1 channel to 2 channel sound having directional information of audio.

● **ZOOM**

During playback or in the pause mode, press **ZOOM** to enlarge the video image (3 steps).

You can move through the zoomed picture using **◀/▶/▲/▼** buttons.

**Note** : Zoom may not work on some DVDs.

● **RETURN (↶)**

Removes the setup menu.

**16. • MARKER - SEARCH**

**To enter a Marker**

You can start playback from up to nine memorized points. To enter a marker, press **MARKER** at the desired point on the disc. The Marker icon appears on the TV screen briefly. Repeat to enter up to nine markers.

**To Recall or Clear a Marked Scene**

1. During disc playback, press **SEARCH**. The marker search menu appears on the screen.
2. Within 10 seconds, press **◀ / ▶** to select a marker number that you want to recall or clear.
3. Press **SELECT/ENTER** and playback starts from the marked scene. Or press **CLEAR** and the marker number is erased from the list.
4. You can play any marker by inputting its number on the marker search menu.

● **MUTE (🔇)**

Press **MUTE** to temporarily stop the sound the (🔇) indicator flashes on display window. To cancel it, press volume **(-/+)** or **MUTE** again.

● **SKIP (⏮ / ⏭)**

During playback, press **SKIP (⏮ or ⏭)** to go to the next chapter/track or to return to the beginning of the current chapter/track.

Press **SKIP ⏮** twice briefly to step back to the previous chapter/track.

● **SLOW**

In the pause mode, press **◀◀ or ▶▶** to select required speed.

DVD : **◀◀** (1/2, 1/4, 1/8, 1/16) or **▶▶** (1/2, 1/4, 1/8, 1/16)

● **SCAN (◀◀ / ▶▶)**

During playback, press **SCAN (◀◀ or ▶▶)** repeatedly to select the required scan speed.

DVD : 5 steps

(▶▶, ▶▶▶, ▶▶▶▶, ▶▶▶▶▶, ▶▶▶▶▶▶),  
(◀◀, ◀◀◀, ◀◀◀◀, ◀◀◀◀◀, ◀◀◀◀◀◀)

DivX disc :4 steps

(▶▶, ▶▶▶, ▶▶▶▶, ▶▶▶▶▶)  
(◀◀, ◀◀◀, ◀◀◀◀, ◀◀◀◀◀)

WMA/MP3, Audio CD

◀◀ (X2, X4, X8) or ▶▶ (X2, X4, X8)

**17. VOLUME (-/+)**

Adjusts speaker volume.

**18. TITLE**

(Use the **TITLE** button to display the title screen included on DVD video discs.)

**19. DISPLAY**

1. Press **DISPLAY** to show various information about the disc loaded on-screen.

The displayed items differ depending on the disc type or playing status.

2. You can select an item by pressing **▲ / ▼** and change or select the setting by pressing **◀ / ▶**.

- Title (Track) – Current title (or track) number/total number of titles (or tracks).
- Chapter – Current chapter number/ total number of chapters.
- Time – Elapsed playing time.
- Audio – Selected audio language or channel.
- Subtitle – Selected subtitle.
- Angle – Selected angle/ total number of angles.
- Sound – Selected sound mode.

**Note** : If a button is not pressed for a few seconds, the on-screen display disappears.



**20. DIMMER**

This function dims the LED (Light-emitting diode) of front panel by half in power-on status.

Press **DIMMER** once. The LED (Light-emitting diode) of front panel is turned off and the display window will be darkened by half. To cancel it, press **DIMMER** again.

**21. SLEEP**

You can set the unit to turn off automatically at a specified time.

1. Press **SLEEP** to set the desired sleep time. The **SLEEP** indicator and the sleep time appears in the display window.

2. Each time you press **SLEEP** the setting changes in the following order.

**SLEEP 180 → 150 → 120 → 90 → 80 → 70 → 60 → 50 → 40 → 30 → 20 → 10 → OFF (No display) → SLEEP 180...**

**Note :** You can check the remaining time before the unit turn off  
Press **SLEEP**. The remaining time appears in the display window.

**22. DISC SKIP (D.SKIP)**

This function is used when you want to change the current during playing disc.

**Additional features****Time Search** **DVD** **DivX**

To start playing at any chosen time on the disc:

1. Press **DISPLAY** during playback.
2. Press **▲ / ▼** to select the time clock icon and "--:--:--" appears.
3. Input the required start time in hours, minutes, and seconds from left to right. If you enter the wrong numbers, press **CLEAR** to remove the numbers you entered. Then input the correct numbers.
4. Press **SELECT/ENTER** to confirm. Playback starts from the selected time.

**Screen Saver**

The screen saver appears when you leave the unit in Stop mode for about five minutes.

**Last Scene Memory** **DVD**

This unit memorizes the last scene from the last disc that is viewed. The last scene remains in the memory even if you remove the disc from the unit or switch off the unit. If you load a disc that has the scene memorized, the scene is automatically recalled.

**Note**

This unit does not memorize the scene of a disc if you switch off the unit before commencing to play the disc.

**System Select**

You must select an appropriate system mode for your TV system. If **NO DISC** appears in the display window, press and hold **PAUSE/STEP** remote control for more than 5 seconds to be able to select a system (PAL, NTSC or AUTO).

- When the selected system is not compatible with the system of your TV, normal colour picture may not be displayed.

**NTSC:** Select when the unit is connected with NTSC-TV.

**PAL:** Select when the unit is connected with PAL-TV.

**AUTO:** Select when the unit is connected with Multi system TV.

**Camera Angle** **DVD**

If the disc contains scenes recorded at different camera angles, you can change to a different camera angle during playback.

1. Press **DISPLAY** and then press the **▲ / ▼** to select a angle. The number of the current angle appears in the display window.
2. Select a desired angle pressing the **◀ / ▶** buttons.

## Setup

### Initial Settings

By using the Setup menu, you can make various adjustments to items such as picture and sound. You can also set a language for the subtitles and the Setup menu, among other things. For details on each Setup menu item, read the page 10 to 11



- 1 LANGUAGE - OSD / Disc Audio / Subtitle / Menu**
- 2 DISPLAY - TV Aspect / Display Mode / Progressive Scan**
- 3 AUDIO - Dynamic Range Control (DRC) / Vocal**
- 4 LOCK (Parental Control) - Rating / Password / Area Code**
- 5 OTHERS - PBC / DivX(R) Registration**

#### To display and exit the Menu:

Press **SETUP** to display the menu. A second press of **SETUP** will take you back to initial screen.

#### To go to the next level:

Press **▶** on the Remote Control.

#### To go back to the previous level:

Press **◀** on the Remote Control.

### General Operation

1. Press **SETUP**. The Setup menu appears.
2. Use **▲ / ▼** to select the desired option then press **▶** to move to the second level. The screen shows the current setting for the selected item, as well as alternate setting(s).
3. Use **▲ / ▼** to select the second desired option and then press **▶** to move to the third level.
4. Use **▲ / ▼** to select the desired setting then press **SELECT/ENTER** to confirm your selection. Some items require additional steps.
5. Press **SETUP** or **PLAY** to exit the Setup menu.

### LANGUAGE

#### OSD

Select a language for the Setup menu and the on-screen display.

#### Disc Audio / Subtitle / Menu

Select the language you prefer for the audio track (disc audio), subtitles, and the disc menu.

**Original** – Refers to the original language in which the disc was recorded.

**Other** – To select another language, press numeric buttons and then **SELECT/ENTER** to enter the corresponding 4-digit number according to the language code list on the page 18. If you enter the wrong language code, press **CLEAR**.

### DISPLAY

#### TV Aspect

**4:3** – Select when a standard 4:3 TV is connected.

**16:9** – Select when a 16:9 wide TV is connected.

#### Display Mode

The display Mode setting works only when the TV Aspect mode is set to "4:3".

**Letterbox** – Displays a wide picture with bands on the upper and lower portions of the screen.

**Panscan** – Automatically displays the wide picture on the entire screen and cuts off the portions that do not fit.

#### Progressive Scan

Progressive Scan Video provides the high quality pictures with less flickering. If you are using the Component Video jacks for connection to a TV or monitor that is compatible with a progressive scan signal, set [Progressive Scan] to [On]. Press **SELECT/ENTER** to confirm your selection. The confirm menu will appear.

#### To Turn ON progressive scan:

Connect component out of the unit to the input of your monitor/television, set your television or monitor to Component Input.

1. Select "Progressive Scan" on the DISPLAY menu then press **▶**
2. Select "On" using the **▲ / ▼** buttons.
3. Pressing **SELECT/ENTER** will set the player to Progressive scan mode.

#### Caution

Once the setting for progressive scan output is entered, an image will only be visible on a progressive scan compatible TV or monitor. If you set Progressive Scan to on in error, you must reset the unit. First, remove the disc in the unit. Next, press **STOP** on the remote control ( **■** ) and hold it for five seconds before releasing it. The video output will be restored to the standard setting, and a picture will once again be visible on a conventional analog TV or monitor.

## AUDIO

Each DVD disc has a variety of audio output options. Set the unit's AUDIO options according to the type of audio system you use.

### Dynamic Range Control (DRC)

With the DVD\*1 format, you can hear a program's soundtrack in the most accurate and realistic presentation, thanks to digital audio technology. However, you may wish to compress the dynamic range of the audio output (the difference between the loudest sounds and the quietest ones). Then, you may listen to a movie at a lower volume without losing clarity of sound. Set DRC to On for this effect.

\*1: Dolby Digital only

### Vocal

Set Vocal to On only when a multi-channel karaoke DVD is playing. The karaoke channels on the disc will mix into normal stereo sound.

## LOCK (Parental Control)

### Rating

Blocks playback of rated DVDs based on their contents. Not all discs are rated.

1. Select "Rating" on the LOCK menu then press ►.
2. To access the LOCK options, you must input the password you have created. If you have not yet entered password, you are prompted to do so.  
Input a password and press **SELECT/ENTER**. Enter it again and press **SELECT/ENTER** to verify. If you make a mistake before pressing **SELECT/ENTER**, press CLEAR.
3. Select a rating from 1 to 8 using the ▲ / ▼ buttons.  
**Rating 1-8:** Rating one (1) has the most restrictions and rating eight (8) is the least restrictive.  
**Unlock:** If you select unlock, parental control is not active and the disc plays in full.
4. Press **SELECT/ENTER** to confirm your rating selection, then press SETUP to exit the menu.

### Password

You can enter or change password.

1. Select Password on the LOCK menu and then press ►.
2. Follow the step 2 as shown above (Rating).  
To change the password, press **SELECT/ENTER** when the "Change" option is highlighted. Input a password and press **SELECT/ENTER**. Enter it again and press **SELECT/ENTER** to verify.
3. Press SETUP to exit the menu.

### If you forget your password

If you forget your password, you can clear it using the following steps:

1. Press SETUP to display the Setup menu.
2. Input the 6-digit number "210499" and press **SELECT/ENTER**. The password is cleared.

### Area Code

Enter the code of the area whose standards were used to rate the DVD video disc, based on the list on page .

1. Select "Area Code" on the LOCK menu then press ►.

2. Follow step 2 as shown in rating section.
3. Select the first character using ▲ / ▼ buttons.
4. Press ► and select the second character using ▲ / ▼ buttons.
5. Press **SELECT/ENTER** to confirm your Area code selection.

## OTHERS

### PBC(Playback Control)

Playback control provides special navigation features that are available on some disc. Select [On] to use this feature.

### DivX(R) Registration

We provide you the DivX® VOD (Video On Demand) registration code that allows you to rent and purchase videos based on the DivX® VOD service. For more information, visit [www.divx.com/vod](http://www.divx.com/vod).

1. Select "DivX(R) Registration" option and then press ►.
2. Press **SELECT/ENTER** while "Select" is selected and the registration code will appear.  
Use the registration code to purchase or rent the videos from DivX® VOD service at [www.divx.com/vod](http://www.divx.com/vod). Follow the instructions and download the video onto a disc for playback on this unit.
3. Press **SELECT/ENTER** to exit.

### Note

All the downloaded videos from DivX® VOD can only be played back on this unit.

### Semi Karaoke

When a chapter/ title / track is fully finished, this function shows the score in the screen with a fanfare sound.

### Semi Karaoke on :

- Turn the "Semi Karaoke" function on.  
When you finished singing a score will appear on the screen.

### Semi Karaoke off :

- Turn the "Semi Karaoke" function off.  
Fanfare and score do not appears on the screen

Available discs for the Semi Karaoke function:

- DVD discs
- DVD Karaoke discs

### Note

- This function operate on the DVD/CD mode.
- The Semi Karaoke function is available only when a microphone is connected.
- Watching movies, "off" the Semi Karaoke or enjoy it without connecting the MIC at the SETUP menu if the fanfare or score appears during changing a chapter.

## Playing an Audio CD or MP3/WMA/JPEG/DivX file

### Playing an Audio CD or MP3/WMA file

This unit can play Audio CDs or MP3/WMA files.

#### MP3/ WMA/ Audio CD

Once you insert a cd with MP3/WMA files or Audio, a menu appears on the TV screen.

Press **▲ / ▼** to select a track/file and then press **PLAY** or **SELECT/ENTER**, and playback starts. You can use variable playback functions. Refer to the page 6 -9.

#### ID3 TAG

When playing a file containing information such as track titles, you can see the information by pressing **DISPLAY** repeatedly. The information [ Folder and file name, Song, Artist, Album, Genre, Comment, Time information ] of the MP3/WMA file will be shown in the display window and TV screen.

To move next or previous files, press the **SKIP** (**◀◀ / ▶▶**) button.

#### Tip

- Press **MENU** to move to the next page.
- On a CD with MP3/WMA and JPEG, you can switch MP3/WMA and JPEG. Press **TITLE**, and **MUSIC** or **PHOTO** top of the menu is highlighted.

### Programmed Playback

The program function enables you to store your favorite tracks from any disc in the unit memory. A program can contain 300 tracks.

1. Insert a disc.  
Audio CD and MP3/WMA Discs:
2. Select a track on the "List", and then press **PROG.** or select **"Add"** icon and then press **SELECT/ENTER** to place the selected track on the "Program" list. Repeat to place additional tracks on the list.

#### Note

You can add all tracks in the disc. Select **"Add All"** icon then press **SELECT/ENTER**.

3. Select the track you want to start playing on the "Program" list. Press **MENU** to move to the next page.
4. Press **PLAY** or **SELECT/ENTER** to start. Playback begins in the order in which you programmed the tracks. Playback stops after all of the tracks on the "Program" list have played once.
5. To resume normal playback from programmed playback, select a track of **AUDIO CD** (or **MP3/WMA**) list and then press **PLAY**.

#### Repeat Programmed Tracks

1. Press **REPEAT** when playing a disc. The repeat icon appears.

2. Press **REPEAT** to select a desired repeat mode.
  - **TRACK**: repeats the current track
  - **ALL**: repeats all the tracks on programmed list.
  - **Off(No display)**: does not play repeatedly.

#### Erasing a Track from "Program" List

1. Use **▲ ▼** to select the track that you wish to erase from the Program list.
2. Press **CLEAR**. Alternatively, select **"Delete"** icon then press **SELECT/ENTER** to place the selected track on the Program list. Repeat to erase additional tracks on the list.

#### Erasing the Complete Program List

Use **▲ / ▼** to select **"Del all"** and then press **SELECT/ENTER**.

#### Note

The programs are also cleared when the disc is removed.

### Viewing a JPEG file

This unit can play discs with JPEG files.

Before playing JPEG recordings, read the notes on JPEG Recordings on the right.

1. Insert a disc and close the tray.  
The **PHOTO** menu appears on the TV screen.
2. Press **▲ / ▼** to select a folder, and then press **SELECT/ENTER**.  
A list of files in the folder appears.  
If you are in a file list and want to return to the previous Folder list, use the **▲ / ▼** buttons on the Remote to highlight **⏪** and press **SELECT/ENTER**.
3. If you want to view a particular file, press **▲ / ▼** to highlight a file and press **SELECT/ENTER** or **PLAY**.  
While viewing a file, you can press **STOP** to move to the previous menu (JPEG menu).

#### Tip

- There are four Slide Speed options **■** :  
> (Slow), >> (Normal), >>> (Fast) and II (off).  
Use **▲ /▼ /◀ /▶** to highlight the Speed. Then, use **◀ / ▶** to select the option you want to use and then press **SELECT/ENTER**.
- If you set Speed option to Off, the slide is not active.

#### Slide Show

Use **▲ ▼ ◀ ▶** to highlight the **■** (Slide Show) then press **ENTER**.

#### Still Picture

1. Press **PAUSE/STEP** during the slide show.  
The unit will now go into the **PAUSE** mode.
2. To return to the slide show, press **PLAY** or press **PAUSE/STEP** again.

### Moving to another File

Press (◀◀ or ▶▶) once during viewing a picture to advance to the next or previous file.

### Rotating the picture

Press ▲/▼/◀/▶ during showing a picture to rotate the picture clockwise or counter-clockwise.

### Zoom

Each time ZOOM is pressed the setting changes in the following order.

Zoom on ↔ Zoom off

Press ▲ ▼ ◀ ▶ to enlarge the video image.

Press ▲ ▼ ◀ ▶ to reduce the video image.

### Playing a DivX Movie file

Using this unit you can play DivX disc.

1. Insert a disc and close the tray. The MOVIE menu appears on the TV screen.
2. Press ▲ / ▼ to select a folder and then press **SELECT/ENTER**. A list of files in the folder appears. If you are in a file list and want to return to the Folder list, use the ▲ / ▼ buttons on the remote to highlight **FL** and press **SELECT/ENTER**.

3. If you want to view a particular file, press ▲ / ▼ to highlight a file and press **SELECT/ENTER** or **PLAY**.
4. Press **STOP** to exit.

### Tip

- Press **MENU** to move to the next page.
- On a CD with MP3/WMA, JPEG and MOVIE file, you can switch **MUSIC**, **PHOTO** and **MOVIE** menu. Press **TITLE** and **MUSIC**, **PHOTO** and **MOVIE** word on top of the menu is highlighted.

### Note

- Be sure to select "SUBTITLE ON" mode by pressing the subtitle file every time before playing a DivX file .
- When the subtitle has more than two languages in the file, original subtitle is only available.
- You can not adjust sound mode and **VIRTUAL** sound during the DivX file playing.

### Notice for displaying the Divx subtitle

If the subtitle does not display properly during playback, press and hold **S-TITLE** for about 3 seconds then press **S-TITLE** to select another language code until the subtitle is displayed properly .

#### MP3 / WMA disc compatibility with this player is limited as follows:

- Sampling frequency: within 32 - 48 kHz (MP3), within 24 - 48kHz (WMA)
- Bit rate: within 32 - 320kbps (MP3), 40 - 192kbps (WMA)
- File extensions: ".mp3" / ".wma"
- CD-ROM file format: ISO9660
- We recommend that you use Easy-CD Creator, which creates an ISO 9660 file system.
- The total number of characters for file name: maximum 8 characters (excluding file extensions like mp3/wma)
- They should not contain special letters such as / ? \* : " < > | etc.
- The total number of files on the disc should be less than 999.

**Customers should note that permission is required in order to download MP3 / WMA files and music from the Internet. Our company has no right to grant such permission. Permission should always be sought from the copyright owner.**

#### JPEG disc compatibility with this player is limited as follows:

- Image file size: less than 2M pixels(2760 x 2048 pixels) recommended (It may take longer to display a larger than 2M pixel size files)
- Maximum files : Under 999.

- Some discs may not operate due to a different recording format or the condition of disc.

- File extensions: ".jpg"

#### DivX disc compatibility with this player is limited as follows:

- Available resolution: within 800x600 (W x H) pixels
- The file name of the DivX subtitle is available by 45 characters.
- If there is impossible code to express in the DivX file, it may be displayed as " \_ " mark on the display.
- **Frame rate : less than 30 fps**
- **If the video and audio structure of recorded files is not interleaved, either video or audio is out-putted.**
- **Playable DivX file:** ".avi", ".mpg", ".mpeg", ".divx"
- **Playable Subtitle format:** SubRip(\*.srt/\*.txt), SAMI(\*.smi), SubStation Alpha(\*.ssa/\*.txt), MicroDVD(\*.sub/\*.txt), SubViewer 2.0(\*.sub/\*.txt), VobSub(\*.sub)
- **Playable Codec format:** DIVX3.xx ", "DIVX4.xx ", "DIVX5.xx ", "MP43 ", "3IVX "
- **Playable Audio format:** "AC3 ", "PCM ", "MP3 ", "WMA "
- Sampling frequency: within 32 - 48 kHz (MP3), within 24 - 48kHz (WMA)
- Bit rate: within 32 - 320kbps (MP3), 40 - 192kbps (WMA)

## Presetting the Radio Stations / Listening

### Presetting the radio stations

You can preset 50 stations for FM and AM. Before tuning, make sure that you have turned the volume down to the minimum level.

- 1 Press TUNER/BAND on the remote control to show either FM or AM in the display window. Or Press TUNER on the front panel. Every time you press this button, AM and FM changes alternately.
- 2 Select a station you want by pressing TUNING (-/+) on the front panel or ◀ / ▶ on the remote control.

#### Note

##### • Automatic Tuning

- Press TUNING (-/+) or ◀ / ▶ for more than 0.5 second.
- Scanning stops when the unit tunes in a station.

##### • Manual Tuning

- Press TUNING (-/+) or ◀ / ▶ briefly and repeatedly.
- 3 Press PROG./MEMO. on the remote control. A preset number will flash in the display window.
  - 4 Press ▲ / ▼ on the remote control to select the preset number you want.
  - 5 Press PROG./MEMO. again. The station is stored.
  - 6 Repeat steps 1 (or 2) to 5 to store other stations.

### To clear all memorized stations

Press and hold PROG./MEMO. on the remote control for about two seconds, "ERASE ALL" appears in the display window and then press PROG./MEMO. on the remote control, the stations are cleared.

#### For your reference

If all stations have already been entered, "FULL" message will appear in the display window for a moment and then a preset number will flash. To change the preset number, follow the steps 4-5 .

### To recall preset numbers

Press and hold ▲ / ▼ on the remote control until the desired preset number appears or press the button repeatedly.

### Listening to the radio

- 1 Press TUNER/BAND on the remote control to show either FM or AM in the display window. Or Press TUNER on the front panel. The last received station is tuned in.
- 2 Press ▲ / ▼ on the remote control repeatedly to select the preset station you want. Each time you press this button, the unit tunes in the next preset station.
- 3 Adjust the volume by turning VOLUME CONTROL KNOB (or pressing VOLUME (-/+) on the remote control) repeatedly.

### To listen to non-preset radio stations

- For manual tuning, see "Manual Tuning".
- For automatic tuning, see "Automatic Tuning".

### To select a preset radio station directly

You can use the number buttons on the remote control to select a preset radio station directly. For example, to listen to preset station 4, press 4 on the remote control. To listen to preset station 19, press 1 then 9 (within 3 seconds).

### To turn the radio off

Press POWER to turn off the unit or select another function mode (DVD/CD, TAPE, AUX or USB) .

#### For your reference

- If a FM program is noisy ; Press ST./MONO repeatedly so that that "STEREO" disappears in the display window. There will be no stereo effect, but the reception will improve. Press ST./MONO again to restore the stereo effect.
- To improve reception; Reposition the supplied antennas.

## RDS Operation - Optional

This unit is equipped with RDS (Radio Data System), which brings a wide range of information to FM radio. RDS, now being used in many countries, is a system for transmitting station call signs or network information, a description of station programme type text message about the station or specifics of musical selection and the correct time.

### RDS TUNING

When a FM station is tuned in and it contains RDS data, the unit will automatically display the station's call sign and the RDS indicator will light in the Display Window as well as indicators for the RDS services programme (PS), programme type recognition (PTY), Radio text (RT) and Clock Time (CT) if transmitted by the station.

### RDS DISPLAY OPTIONS

The RDS system is capable of transmitting a wide variety of information in addition to the initial call sign that appears when a station is first tuned. In normal RDS operation the display will indicate the station name, broadcast network or call letters. Pressing **RDS** on the remote control enables you to cycle through the various data types in the sequence:

**(PS ↔ FREQUENCY ↔ PTY ↔ RT ↔ CT)**

- **PS (Programme Service name)**- The name of the channel is shown in the Display Window.
- **PTY (Programme type recognition)**- The name of the programme type is shown in the Display Window.
- **RT (Radiotext)**- A "text" message contains special information from the broadcast station. Note that this message may scroll across the display to permit message.
- **CT (Time controlled by the channel)**- Enables the unit to receive the actual time and show it in the Display Window.

#### Note

Some RDS stations may not choose to include some of these additional features. If the data required for the selected mode is not being transmitted, the Display Window will show a **PTY NONE**, **RT NONE**, **CT NONE**, or **PS NONE** message.

### Programme Search (PTY)

A major benefit of RDS is its ability to encode broadcasts with Programme Type (PTY) codes that indicate the type of material being broadcast. The following list shows the abbreviations used to indicate each PTY along with an explanation of the PTY.

NEWS	News
AFFAIRS	Current Affairs
INFO	Information
SPORT	Sports
EDUCATE	Educational
DRAMA	Drama
CULTURE	Culture
SCIENCE	Science
VARIED	Varied Speech Programme
POP M	Popular Music
ROCK M	Rock Music
EASY M	Easy Listening Music
LIGHT M	Light Music
CLASSICS	Classical Music
OTHER M	Other Music
WEATHER	Weather Information
FINANCE	Financial Programmes
CHILDREN	Children's Programmes
SOCIAL	Social Affairs Programmes
RELIGION	Religious Broadcasts
PHONE IN	Phone-In Programmes
TRAVEL	Travel and Touring
LEISURE	Leisure and Hobby
JAZZ	Jazz Music
COUNTRY	Country Music
NATION M	National Music
OLDIES	Oldies Music
FOLK M	Folk Music
DOCUMENT	Documentary Programmes
TEST	Station Alarm Test Message
ALARM !	Emergency Broadcast Information

You may search for a specific Programme Type (PTY) by following these steps:

1. Press TUNER to select the FM mode.
2. Press PTY on the remote control, the display will show the last PTY in use.
3. Press PTY repeatedly to select a desired PTY.
4. When the PTY is selected, press TUN.(-/+).The unit will go into an automatic search mode. When a station is tuned, the search will stop.

## Timer function

### Setting the Clock

- 1 **Press CLOCK.**  
(If the clock requires setting, press and hold **CLOCK** for more than 2 seconds.)  
- The hours display begins to blink.
- 2 **Select a 24 hour cycle or 12 hour cycle by pressing** ◀◀ ◀/▶▶ ▶▶▶▶ **on the front panel.**
- 3 **Press SET/CDII to confirm the selected hour cycle.**
- 4 **Use** ◀◀ ◀/▶▶ ▶▶▶▶ **on the front panel to set the correct hours.**
- 5 **Press SET/CDII.**
- 6 **Use** ◀◀ ◀/▶▶ ▶▶▶▶ **on the front panel to set the correct minutes.**
- 7 **Press SET/CDII and the correct time is shown in the display window.**

### Timer Function

With the **TIMER** function you can have the radio reception, CD play, USB play and TAPE play turned on and off at the desired time.

- 1 **Press CLOCK to check the current time.**

#### For your reference

If you don't set clock, timer function doesn't work.

- 2 **Press TIMER to enter the timer setting mode.**  
"TUNER→DVD/CD →USB →TAPE" flash in the display window in turn.

#### For your reference

- If you want to correct the previous memorized **TIMER** setting, press and hold the **TIMER** button more than 2 seconds.
- If you want to check the previous memorized **TIMER** setting, press **TIMER** button briefly.  
- The previous memorized timer setting for on Time and "⏸" indicator appears in the display window.

- 3 **Press SET/CDII when the desired function flashes.**
- 4 **a. 1) When you select TUNER function, 'PLAY' and 'REC' indicator flash in the display window alternately for about 3 seconds.**  
'PLAY' indicator : TUNER play only  
'REC' indicator : TUNER play and recording
- 2) **Press SET/CDII when the desired function flashes.**

- 3) **Select the previous memorized preset number by pressing** ◀◀ ◀/▶▶ ▶▶▶▶ **on the front panel and press SET/CDII .**

'ON TIME' indicator appears for about 0.5 seconds in the display window and then disappears.

- b. **When you select DVD/ CD, USB or TAPE function,**

'ON TIME' indicator appears for about 0.5 seconds in the display window and then disappears.

- 5 **Set the hour to switch on by pressing** ◀◀ ◀/▶▶ ▶▶▶▶ **on the front panel.**

- 6 **Press SET/CDII.**

- 7 **Set the minute to switch on by pressing** ◀◀ ◀/▶▶ ▶▶▶▶ **on the front panel.**

- 8 **Press SET/CDII to confirm the turn on minutes time.**

'OFF TIME' indicator appears for about 0.5 seconds in the display window and then disappears.

- 9 **Set the hour to switch off by pressing** ◀◀ ◀/▶▶ ▶▶▶▶ **on the front panel.**

- 10 **Press SET/CDII.**

- 11 **Set the minute to switch off by pressing** ◀◀ ◀/▶▶ ▶▶▶▶ **on the front panel.**

- 12 **Press SET/CDII.**

- 13 **Adjust the volume level by pressing** ◀◀ ◀/▶▶ ▶▶▶▶ **on the front panel.**

- 14 **Press SET/CDII.**

"⏸" appears in the display window and the timer setting has been completed.

- 15 **Turn the system off.**

The selected timer functions are automatically switched on and off at the preset times.

#### To cancel or check the timer

Each time the **TIMER** button is pressed you can select the timer set or cancel. You can also check the timer setting status.

To activate or check the timer, press the **TIMER** button repeatedly so that "⏸" appears in the display window.

To cancel the **TIMER**, press the **TIMER** button repeatedly so that "⏸" disappears from the display window.

#### Note

- If you insert the DVD or DivX except audio CD/MP3/WMA on the unit, the timer function will be operated to the TUNER.
- This is not supported in the multi card reader.





## Reference

### Language Codes

Use this list to input your desired language for the following initial settings: Disc Audio, Disc Subtitle, Disc Menu.

Language	Code	Language	Code	Language	Code	Language	Code
Abkhazian	6566	Fiji	7074	Lingala	7678	Singhalese	8373
Afar	6565	Finnish	7073	Lithuanian	7684	Slovak	8375
Afrikaans	6570	French	7082	Macedonian	7775	Slovenian	8376
Albanian	8381	Frisian	7089	Malagasy	7771	Somali	8379
Ameharic	6577	Galician	7176	Malay	7783	Spanish	6983
Arabic	6582	Georgian	7565	Malayalam	7776	Sudanese	8385
Armenian	7289	German	6869	Maltese	7784	Swahili	8387
Assamese	6583	Greek	6976	Maori	7773	Swedish	8386
Aymara	6588	Greenlandic	7576	Marathi	7782	Tagalog	8476
Azerbaijani	6590	Guarani	7178	Moldavian	7779	Tajik	8471
Bashkir	6665	Gujarati	7185	Mongolian	7778	Tamil	8465
Basque	6985	Hausa	7265	Nauru	7865	Tatar	8484
Bengali; Bangla	6678	Hebrew	7387	Nepali	7869	Telugu	8469
Bhutani	6890	Hindi	7273	Norwegian	7879	Thai	8472
Bihari	6672	Hungarian	7285	Oriya	7982	Tibetan	6679
Breton	6682	Icelandic	7383	Panjabi	8065	Tigrinya	8473
Bulgarian	6671	Indonesian	7378	Pashto, Pushto	8083	Tonga	8479
Burmese	7789	Interlingua	7365	Persian	7065	Turkish	8482
Byelorussian	6669	Irish	7165	Polish	8076	Turkmen	8475
Cambodian	7577	Italian	7384	Portuguese	8084	Twi	8487
Catalan	6765	Japanese	7465	Quechua	8185	Ukrainian	8575
Chinese	9072	Javanese	7487	Rhaeto-Romance	8277	Urdu	8582
Corsican	6779	Kannada	7578	Rumanian	8279	Uzbek	8590
Croatian	7282	Kashmiri	7583	Russian	8285	Vietnamese	8673
Czech	6783	Kazakh	7575	Samoan	8377	Volapük	8679
Danish	6865	Kirghiz	7589	Sanskrit	8365	Welsh	6789
Dutch	7876	Korean	7579	Scots Gaelic	7168	Wolof	8779
English	6978	Kurdish	7585	Serbian	8382	Xhosa	8872
Esperanto	6979	Laotian	7679	Serbo-Croatian	8372	Yiddish	7473
Estonian	6984	Latin	7665	Shona	8378	Yoruba	8979
Faroese		Latvian, Lettish	7686	Sindhi	8368	Zulu	9085

### Area Codes Choose a area code from this list.

Area	Code	Area	Code	Area	Code	Area	Code
Afghanistan	AF	Ethiopia	ET	Malaysia	MY	Saudi Arabia	SA
Argentina	AR	Fiji	FJ	Maldives	MV	Senegal	SN
Australia	AU	Finland	FI	Mexico	MX	Singapore	SG
Austria	AT	France	FR	Monaco	MC	Slovak Republic	SK
Belgium	BE	Germany	DE	Mongolia	MN	Slovenia	SI
Bhutan	BT	Great Britain	GB	Morocco	MA	South Africa	ZA
Bolivia	BO	Greece	GR	Nepal	NP	South Korea	KR
Brazil	BR	Greenland	GL	Netherlands	NL	Spain	ES
Cambodia	KH	Heard and McDonald Islands	HM	Netherlands Antilles	AN	Sri Lanka	LK
Canada	CA	Hong Kong	HK	New Zealand	NZ	Sweden	SE
Chile	CL	Hungary	HU	Nigeria	NG	Switzerland	CH
China	CN	India	IN	Norway	NO	Taiwan	TW
Colombia	CO	Indonesia	ID	Oman	OM	Thailand	TH
Congo	CG	Israel	IL	Pakistan	PK	Turkey	TR
Costa Rica	CR	Italy	IT	Panama	PA	Uganda	UG
Croatia	HR	Jamaica	JM	Paraguay	PY	Ukraine	UA
Czech Republic	CZ	Japan	JP	Philippines	PH	United States	US
Denmark	DK	Kenya	KE	Poland	PL	Uruguay	UY
Ecuador	EC	Kuwait	KW	Portugal	PT	Uzbekistan	UZ
Egypt	EG	Libya	LY	Romania	RO	Vietnam	VN
El Salvador	SV	Luxembourg	LU	Russian Federation	RU	Zimbabwe	ZW

## Troubleshooting

Check the following guide for the possible cause of a problem before contacting service.

### **Sy** Symptom/ **Ca** Cause/ **Co** Correction

#### **Sy** No power.

- Ca** The power cord is disconnected.
- Co** Plug the power cord securely into the wall outlet.

#### **Sy** The power is on, but the unit does not work.

- Ca** No disc is inserted.
- Co** Insert a disc. (Check that the DVD or, audio CD indicator in the DVD display is lit)

#### **Sy** No picture.

- Ca** The TV is not set to receive DVD signal output.
- Co** Select the appropriate video input mode on the TV so the picture from the unit appears on the TV screen.
- Ca** The video cable is not connected securely.
- Co** Connect the video cable into the jacks securely.
- Ca** The connected TV power is turned off.
- Co** Turn on the TV.

#### **Sy** There is no sound or only a very low-level sound is heard.

- Ca** The equipment connected with the audio cable is not set to receive DVD signal output.
- Co** Select the correct input mode of the unit so you can hear the sound from the unit.
- Ca** The audio cables are not connected securely.
- Co** Connect the audio cable into the jacks securely.
- Ca** The power of the equipment connected with the audio cable is turned off.
- Co** Turn on the equipment connected with the audio cable.
- Ca** The audio connecting cable is damaged.
- Co** Replace it with new one.

#### **Sy** The playback picture is poor.

- Ca** The disc is dirty.
- Co** Clean the disc.
- Sy** The unit does not start playback.
- Ca** An unplayable disc is inserted.
- Co** Insert a playable disc. (Check the disc type, colour system and Regional code.)
- Ca** The disc is placed upside down.
- Co** Place the disc with the playback side down.
- Ca** The disc is not placed within the guide.
- Co** Place the disc on the disc tray correctly inside the guide.
- Ca** The disc is dirty.
- Co** Clean the disc.

- Ca** A menu is on the TV screen.

- Co** Press the SETUP button to turn off the menu screen.

- Ca** The Rating level is set.

- Co** Cancel the Rating function or change the rating level.

#### **Sy** Loud hum or noise is heard.

- Ca** The disc is dirty.
- Co** Clean the disc.
- Ca** The speakers and components are connected poorly.
- Co** Connect the speakers and components securely.
- Ca** The unit is located too close to the TV.
- Co** Move your TV away from the audio components.

#### **Sy** Radio stations cannot be tuned in.

- Ca** The antenna is positioned or connected poorly.
- Co** Connect the antenna securely.
- Ca** The signal strength of the stations is too weak (when tuning in with automatic tuning).
- Co** Tune in the station manually.
- Ca** No stations have been preset or preset stations have been cleared (when tuning by scanning preset stations).
- Co** Preset the stations (page 14).

#### **Sy** The Remote Control does not work properly.

- Ca** The Remote Control is not pointed at the remote sensor of the unit.
- Co** Point the Remote Control at the remote sensor of the unit.
- Ca** The Remote Control is too far from the unit.
- Co** Use the Remote Control within about 23 ft (7 m).
- Ca** There is an obstacle in the path of the Remote Control and the unit.
- Co** Remove the obstacle.
- Ca** The batteries in the Remote Control are exhausted.
- Co** Replace the batteries with new ones.

#### **Sy** The front panel display is too dim.

- Ca** Nothing is displayed on the front panel display.
- Co** Press DIMMER on the Remote Control.

## **Specifications**

### **General**

Power supply	Refer to the main label.
Power consumption	Refer to the main label.
Net Weight	5.5 kg
External dimensions (W x H x D)	272 X 322 X 354 mm

### **Tuner/Amplifier**

FM Tuning Range	87.5 - 108.0 MHz or 65 -74 MHz, 87.5 -108.0 MHz
Intermediate Frequency	10.7 MHz
Signal to Noise Ratio	60/55 dB (Mono/Stereo)
Frequency Response	50 - 10000 Hz
AM Tuning Range	522 - 1620 kHz or 520 - 1720 kHz
Intermediate Frequency	450 kHz
Signal to Noise Ratio	30 dB
Frequency Response	140 - 1800 Hz
Output Power	50 W + 50 W (4 $\Omega$ , THD 10 %) (MDD112) 30 W + 30 W (4 $\Omega$ , THD 10 %) (MDD72)
T.H.D	0.5 %
Frequency Response	40 - 20000 Hz
Signal-to-noise ratio	75 dB

### **DVD/CD player**

Frequency response (audio)	40 - 20000 Hz
Signal-to-noise ratio (audio)	More than 75 dB (1 kHz)
Signal-to-noise ratio (video)	More than 55 dB (1 kHz)
Dynamic range (audio)	More than 80 dB
Video output	1.0 V (p-p), 75 $\Omega$
Component Video output	(Y) 1.0 V (p-p), 75 $\Omega$ (Pb)/(Pr) 0.7 V (p-p), 75 $\Omega$

### **Cassette tape player**

Tape Speed	3000 $\pm$ 3 % (MTT-111. NORMAL-SPEED)
Wow Flutter	0.25 % (MTT -111, JIS-WTD)
F.F/REW. Time	120 sec (C-60)
Frequency Response	250 - 8000 Hz
Signal to Noise Ratio	43 dB
Channel Separation	50 dB (P/B)/45 dB (R/P)
Erase Ratio	55 dB (MTT-5511)

### **Speakers**

Speaker Name	Front Speaker (L/R)
Type	Bass Reflex 2Way 2Speaker
Impedance	4 $\Omega$
Frequency Response	55 - 20000 Hz (MDS112V) 60 - 20000 Hz (MDS72V)
Sound Pressure Level	83 dB/W (1m) (MDS112V) 83 dB/W (1m) (MDS72V)
Rated Input Power	50 W (MDS112V) 30 W (MDS72V)
Max. Input Power	100 W (MDS112V) 60 W (MDS72V)
Net Dimensions (W x H x D)	220 X 326 X 242 mm
Net Weight	3.4 kg (MDS112V) 3.19 kg (MDS72V)

**Designs and specifications are subject to change without notice for improvement.**