



DVD KARAOKE SYSTEM

OWNER'S MANUAL

MODEL : DKS-5550Q (DKS-5550)
DKS-5650Q (DKS-5650)



Please read this manual carefully before operating your set.
Retain it for future reference.

Designs and specifications are subject to change without
notice for improvement.

The working life of this product is 7 years since the date of
purchase.

Safety Precautions



WARNING: TO REDUCE THE RISK OF ELECTRIC SHOCK DO NOT REMOVE COVER (OR BACK) NO USER-SERVICEABLE PARTS INSIDE REFER SERVICING TO QUALIFIED SERVICE PERSONNEL.



This lightning flash with arrowhead symbol within an equilateral triangle is intended to alert the user to the presence of uninsulated dangerous voltage within the product's enclosure that may be of sufficient magnitude to constitute a risk of electric shock to persons.



The exclamation point within an equilateral triangle is intended to alert the user to the presence of important operating and maintenance (servicing) instructions in the literature accompanying the appliance.

WARNING: TO REDUCE THE RISK OF FIRE OR ELECTRIC SHOCK, DO NOT EXPOSE THIS PRODUCT TO RAIN OR MOISTURE.

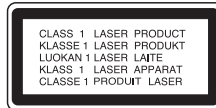

CAUTION:

This Digital Video Disc Player employs a Laser System.

To ensure proper use of this product, please read this owner's manual carefully and retain for future reference, should the unit require maintenance, contact an authorized service location—see service procedure.

Use of controls, adjustments or the performance of procedures other than those specified herein may result in hazardous radiation exposure.

To prevent direct exposure to laser beam, do not try to open the enclosure. Visible laser radiation when open. DO NOT STARE INTO BEAM.

CAUTION: The apparatus shall not be exposed to water, dripping or splashing and that no objects filled with liquids, such as vases, shall be placed on the apparatus.

CAUTION concerning the Power Cord

Most appliances recommend they be placed upon a dedicated circuit;

That is, a single outlet circuit which powers only that appliance and has no additional outlets or branch circuits. Check the specification page of this owner's manual to be certain.

Do not overload wall outlets. Overloaded wall outlets, loose or damaged wall outlets, extension cords, frayed power cords, or damaged or cracked wire insulation are dangerous. Any of these conditions could result in electric shock or fire.

Periodically examine the cord of your appliance, and if its appearance indicates damage or deterioration, unplug it, discontinue use of the appliance, and have the cord replaced with an exact replacement part by an authorized servicer.

Protect the power cord from physical or mechanical abuse, such as being twisted, kinked, pinched, closed in a door, or walked upon. Pay particular attention to plugs, wall outlets, and the point where the cord exits the appliance.



Disposal of your old appliance

1. When this crossed-out wheeled bin symbol is attached to a product it means the product is covered by the European Directive 2002/96/EC.
2. All electrical and electronic products should be disposed of separately from the municipal waste stream via designated collection facilities appointed by the government or the local authorities.
3. The correct disposal of your old appliance will help prevent potential negative consequences for the environment and human health.
4. For more detailed information about disposal of your old appliance, please contact your city office, waste disposal service or the shop where you purchased the product.

Table of Contents

Introduction	
Safety Precautions	2
Table of Contents	3
Before Use	3
Front Panel and Rear Panel	4
Remote Control	5
Preparation	
Connections	6-7
Before Operation	8-13
Operation	
Operation with DVD	14-16
Operation with Audio CD and MP3/WMA Disc	16-17
Programmed Playback	17
Operation with JPEG Disc	18
Operation with DivX Disc	19
Operation with KARAOKE	20-24
Reference	
Language Code List	25
Country Code List	25
Troubleshooting/Specifications	

About Symbols

About the symbol display

“” may appear on the TV screen during operation. This icon means the function explained in this owner’s manual is not available on that specific DVD video disc.

About the disc symbols for instructions

A section whose title has one of the following symbol is applicable only to the disc represented by the symbol.

 DVD
 Audio CDs
 MP3 disc
 WMA disc
 JPEG disc
 DivX disc

About the symbols for instructions



 Indicates hazards likely to cause harm to the unit itself or other material damage.

 Indicates special operating features of this unit.

 Indicates tips and hints for making the task easier.

Before Use

Playable Discs

	DVD (8 cm / 12 cm disc)
	Audio CD (8 cm / 12 cm disc)

In addition, this unit can play a DVD±R, DVD±RW and CD-R or CD-RW that contains audio titles, MP3, WMA, JPEG or DivX files.

Notes

- Depending on the conditions of the recording equipment or the CD-R/RW (or DVD±R/RW) disc itself, some CD-R/RW (or DVD±R/RW) discs cannot be played on the unit.
- Do not attach any seal or label to either side (the labeled side or the recorded side) of a disc.
- Do not use irregularly shaped CDs (e.g., heart-shaped or octagonal). It may result in malfunctions.

Regional code of the DVD player and DVDs

This DVD player is designed and manufactured for playback of region “5” encoded DVD software. The region code on the labels of some DVD discs indicates which type of player can play those discs. This unit can play only DVD discs labeled “5” or “ALL”. If you try to play any other discs, the message “Check Regional Code” will appear on the TV screen. Some DVD discs may not have a region code label even though their playback is prohibited by area limits.



Note on DTS-encoded CDs

When playing DTS-encoded CDs, excessive audio level may be heard from the analog stereo output. To avoid possible damage to the audio system, turn down the volume before playing back such discs, adjust the volume gradually, and keep the volume level low. To enjoy DTS Digital Surround™ playback, an external 5.1 channel DTS Digital Surround™ decoder system must be connected to the digital output of the unit.

Front Panel and Rear Panel

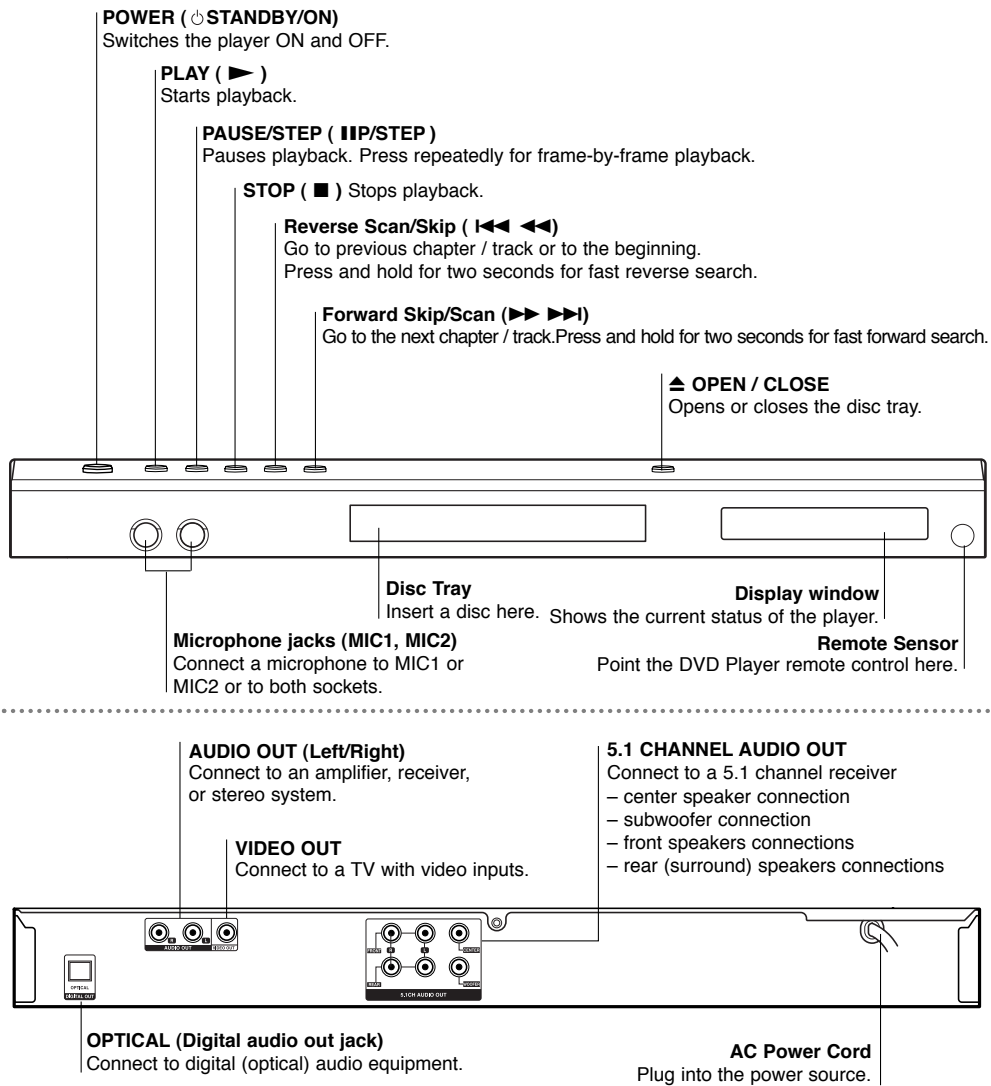

Do not touch the inner pins of the jacks on the rear panel. Electrostatic discharge may cause permanent damage to the unit.

Remote Control

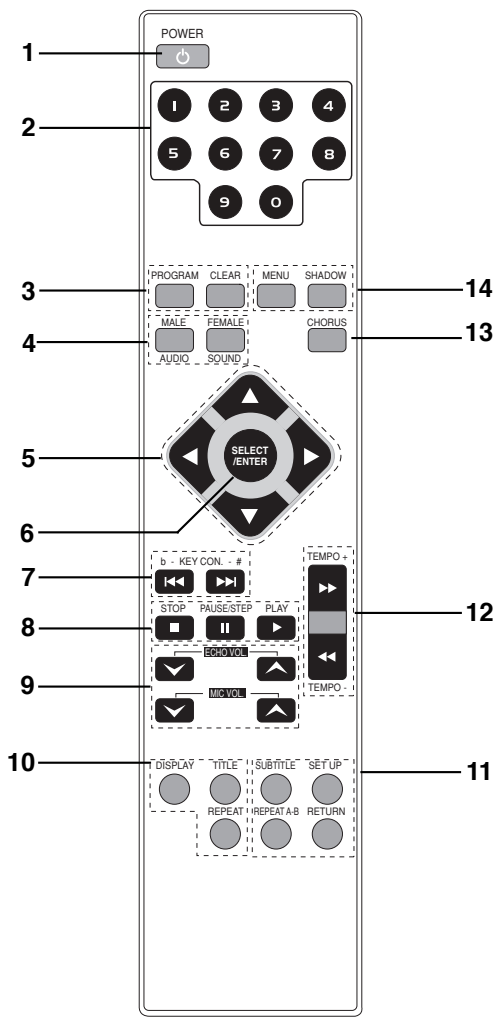

1. POWER button
2. NUMERIC buttons (0-9)
3.
 - PROGRAM button
 - CLEAR button
4.
 - AUDIO button
 - MALE button
 - SOUND button
 - FEMALE button
5. ARROW buttons (▲ / ▼ / ◀ / ▶)
(For use in highlighting a selection on a GUI menu screen, TITLE and MENU screen.)
6. SELECT/ENTER button
7. KEY CONTROL (b/#) buttons
8.
 - STOP (■) button
 - PAUSE(⏸)/ STEP button
 - PLAY (▶) button
9.
 - ECHO volume control (ECHO VOL. ▼ / ▲) button
 - Microphone volume control (MIC VOL. ▼ / ▲) button
10.
 - DISPLAY button
 - TITLE button
 - REPEAT button
11.
 - SUBTITLE button
 - SET UP button
 - REPEAT A-B button
 - RETURN button
12. TEMPO(-/+) buttons (◀◀ / ▶▶)
13. CHORUS button
(When a Song with chorus function is played, use this button.)
14.
 - MENU button
 - SHADOW button

Remote Control Operation Range

- Point the remote control at the remote sensor and press the buttons.
- **Distance:** About 23 ft (7 m) from the front of the remote sensor
 - **Angle:** About 30° in each direction of the front of the remote sensor

Remote control battery installation

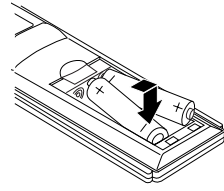

Detach the battery cover on the rear of the remote control, and insert two R03 (size AAA) batteries with + and - aligned correctly.

Caution
Do not mix old and new batteries. Never mix different types of batteries (standard, alkaline, etc.).

Connections

Tips

- Depending on your TV and other equipment you wish to connect, there are various ways you could connect the player. Use only one of the connections described below.
- Please refer to the manuals of your TV, VCR, Stereo System or other devices as necessary to make the best connections.

Caution

- Make sure the DVD Player is connected directly to the TV. Tune the TV to the correct video input channel.
- Do not connect the DVD Player's AUDIO OUT jack to the phono in jack (record deck) of your audio system.
- Do not connect your DVD Player via your VCR. The DVD image could be distorted by the copy protection system.

Connecting to a TV

Video connection

- 1 Connect the VIDEO OUT jack on the DVD Player to the video in jack on the TV using the video cable (V).
- 2 Connect the Left and Right AUDIO OUT jacks of the DVD Player to the audio left/right in jacks on the TV (A) using the audio cables.

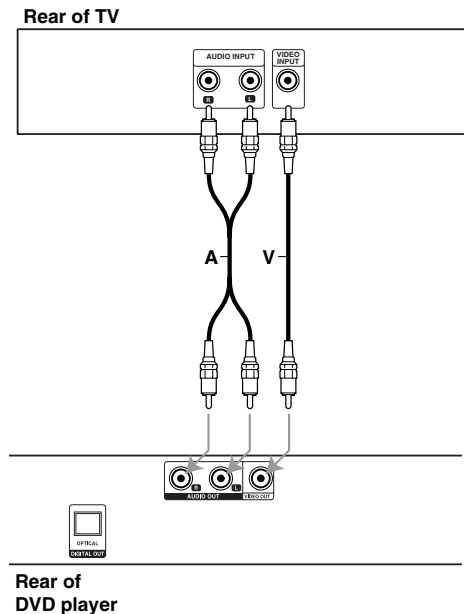

Connecting to Optional Equipment

Connecting to an amplifier equipped with two channel analog stereo

Connect the Left and Right AUDIO OUT jacks on the DVD Player to the audio left and right in jacks on your amplifier, receiver, or stereo system, using the audio cables (A).

Connecting to an amplifier equipped with two channel digital stereo (PCM) or to an Audio/ Video receiver equipped with a multi-channel decoder (Dolby Digital™ or MPEG 2)

Connect one of the DVD Player's DIGITAL OPTICAL OUT jacks to the corresponding in jack on your amplifier. Use an optional digital audio cable. (O)

Digital Multi-channel sound

A digital multi-channel connection provides the best sound quality. For this you need a multi-channel Audio/Video receiver that supports one or more of the audio formats supported by your DVD Player (MPEG 2 va Dolby Digital). Check the receiver manual and the logos on the front of the receiver.

Caution:

Due to the DTS Licensing agreement, the digital output will be in DTS digital out when DTS audio stream is selected.

Rear of DVD player

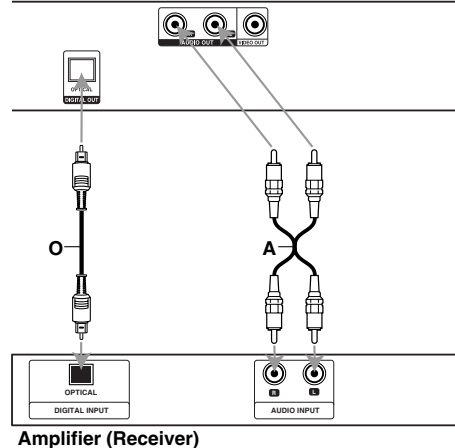

Notes

- If the audio format of the digital output does not match the capabilities of your receiver, the receiver will produce a strong, distorted sound or no sound at all.
- Six Channel Digital Surround Sound via digital connection can only be obtained if your receiver is equipped with a Digital Multi-channel decoder.
- To see the audio format of the current DVD in the on-screen display, press AUDIO.

Connections

Connecting to Optional Equipment (continued)

Analog connection to a multi-channel A/V receiver with 6 Channel connectors (Dolby Digital, DTS)

This DVD Player contains a multi-channel decoder. This enables playback of DVDs recorded in Multi-channel Surround without the need for an optional decoder.

- 1** Connect the CENTER and WOOFER jacks for the Center speaker and the Subwoofer (**C**) to the corresponding jacks on your receiver.
- 2** Connect the Left and Right FRONT speaker jacks (**F**) to the corresponding jacks on your receiver.
- 3** Connect the Left and Right REAR speaker jacks (**R**) to the corresponding jacks on your receiver.
- 4** Make the appropriate Sound settings for Analog Output and Speaker Settings in the setup menu. See page 11.

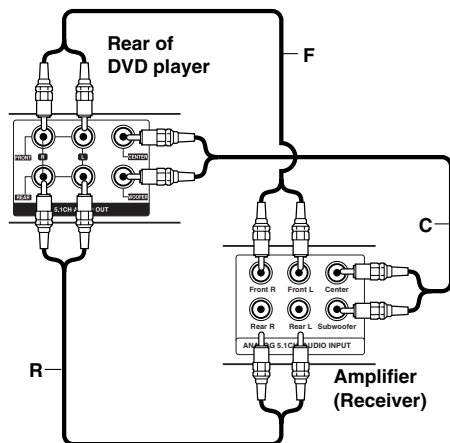

Before Operation

Mini Glossary for Audio Stream & Surround mode

DIGITAL

The Dolby Digital surround format lets you enjoy up to 5.1 channels of digital surround sound from a Dolby Digital program source. If you play DVDs with “” mark, you can enjoy even better sound quality, greater spatial accuracy, and improved dynamic range. Manufactured under license from Dolby Laboratories. “Dolby”, “Pro Logic” and double-D symbol are trademarks of Dolby Laboratories.

BYPASS





Outputs the sound from the front left and right speakers and subwoofer.

Sound Mode

You can enjoy surround sound simply by selecting one of the pre-programmed sound fields according to the program you want to listen to.

When DVD is inserted

You can change the Digital Audio Output mode by pressing the **AUDIO** button on the remote control during playback. Although the DVD contents differ from disc to disc, the following explains the basic operation when this feature is used.



- a) After you select 2 channel (For example  or ) by pressing AUDIO button, press SOUND button repeatedly.
 - “BYPASS” indicator will be only displayed on the display window.
- b) After you select 5.1 channel (For example  or ) by pressing AUDIO button, press SOUND button.
 - “” indicator will be displayed on the TV screen.

When CD is inserted

Each time you press SOUND button, the sound mode of Audio CD is changed on the display window as the following order.

BYPASS → STUDIO → CLUB → HALL → THEATER 1
→ CHURCH → BYPASS...

For your reference

- Initial sound of DVD function is **BYPASS**.
- You can identify the encoding format of program software by looking at its packaging.
 - Dolby Digital discs are labelled with the  logo.
 - Dolby Surround encoded programs are labelled with the  logo.
 - DTS Digital Surround discs are marked with DTS.

Note

When you play sound tracks with 96kHz sampling frequency, the output signals will be converted to 48kHz (sampling frequency).

Before Operation





General Explanation

This manual gives basic instructions for operating the DVD Karaoke. Some DVDs require specific operation or allow only limited operation during playback. When this occurs, the symbol  appears on the TV screen, indicating that the operation is not permitted by the DVD Karaoke or is not available on the disc.





On-Screen Display

General playback status can be displayed on the TV screen. Some items can be changed on the menu.

On-screen display operation

- 1** Press **DISPLAY** during playback.
- 2** Press  /  to select an item.
The selected item will be highlighted.
- 3** Press  or  to change the setting of an item.
The number buttons can be also be used for setting numbers (e.g., title number). For some functions, press **SELECT/ENTER** to execute the setting.













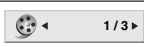

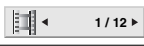

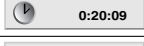
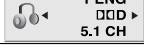
Temporary Feedback Field Icons

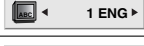
-  **Title** Repeat title
-  **A - B** Repeat sequence
-  Resume play from this point
-  Action prohibited or not available

Notes

- Some discs may not provide all of the features on the on-screen display example shown below.
- If no button is pressed for 10 seconds, the on-screen display disappears.

Example: On-Screen Display during playing DVD

Items	Function / Action using  /  to select item	Selection Method
Title Number 	Shows the current title number and total number of titles / skips to the desired title number.	 /  , Numbers, or SELECT/ENTER
Chapter Number 	Shows the current chapter number and total number of chapters / skips to the desired chapter number.	 /  , Numbers, or SELECT/ENTER
Time search 	Shows the elapsed playing time / searches by elapsed time.	Numbers, SELECT/ENTER
Audio language and Digital Audio Output mode 	Shows the current audio soundtrack language, encoding method, and channel number / changes the setting.	 /  or AUDIO
Subtitle language 	Shows the current subtitle language / changes the setting.	 /  or SUBTITLE
Angle 	Shows the current angle number and total number of angles / changes the angle.	 / 
Sound 	Shows the current sound mode / changes the setting.	 /  or SOUND

Before Operation

Initial Settings

By using the Setup menu, you can make various adjustments to items such as picture and sound. You can also set a language for the subtitles and the Setup menu, among other things. For details on each Setup menu item, see pages 10 to 13.

To display and exit the Menu:

Press **SETUP** to display the menu. A second press of **SETUP** will take you back to initial screen.

To go to the next level:

Press **▶** on the remote control.

To go back to the previous level:

Press **◀** on the remote control.

General Operation

- 1 Press SETUP.**
The setup menu appears.
- 2 Use ▲/▼ to select the desired option then press ▶ to move to the second level.**
The screen will be shown the current setting for the selected item, as well as alternate setting(s).
- 3 Use ▲/▼ to select the second desired option then press ▶ to move to the third level.**
- 4 Use ▲/▼ to select the desired setting then press SELECT/ENTER to confirm your selection.**
Some items require additional steps.
- 5 Press SETUP or PLAY to exit the setup menu.**

LANGUAGE

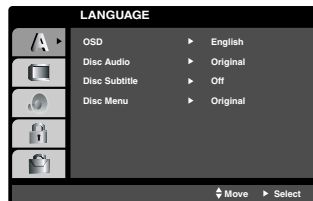

OSD

Select a language for the Setup menu and on-screen display.

Disc Audio / Subtitle / Menu **DVD**

Select the language you prefer for the audio track (disc audio), subtitles, and the disc menu.

Original: Refers to the original language in which the disc was recorded.

Other: To select another language, press number buttons to enter the corresponding 4-digit number according to the language code list on page 25. If you enter the wrong language code, press **CLEAR** on the remote control.

DISPLAY



TV Aspect **DVD**

4:3: Select when a standard 4:3 TV is connected.
16:9: Select when a 16:9 wide TV is connected.

Display Mode **DVD**

Display Mode setting works only when the TV Aspect mode is set to "4:3".

Letterbox: Displays a wide picture with bands on the upper and lower portions of the screen.

Panscan: Automatically displays the wide picture on the entire screen and cuts off the portions that do not fit.

Before Operation

AUDIO

Each DVD disc has a variety of audio output options. Set the player's AUDIO options according to the type of audio system you use.

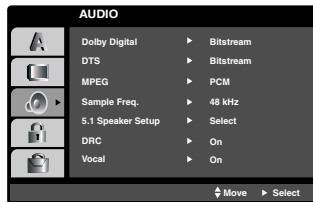

Dolby Digital / DTS / MPEG **DVD**

Bitstream: Select "Bitstream" if you connect the DVD Player's DIGITAL OUT jack to an amplifier or other equipment with a Dolby Digital, DTS or MPEG decoder.

PCM : Select when connected to a two-channel digital stereo amplifier. DVDs encoded in Dolby Digital or MPEG will be automatically downmixed to two-channel PCM audio.

Sample Freq. (Frequency) **DVD**

If your receiver or amplifier is NOT capable of handling 96 kHz signals, select 48 kHz. When this choice is made, this unit automatically converts any 96 kHz signals to 48 kHz so your system can decode them.

If your receiver or amplifier is capable of handling 96 kHz signals, select 96 kHz. When this choice is made, this unit passes each type of signal through without any further processing. Check the documentation for your amplifier to verify its capabilities.

5.1 Speaker Setup **DVD**

Select speaker settings, including volume balance and distance, or test the speaker settings. Speaker settings are only active on the Analog Multi-Channel Output.

Speaker Setup

Make the following settings for the built-in 5.1 channel surround decoder.

1. Press SETUP. The setup menu appears.
2. Use / to select the AUDIO option then press to move to the second level.
3. Use / to select the Speaker Setup option then press to move to the third level. "Select" is highlighted.
4. Press SELECT/ENTER and 5.1 Speaker Setup menu appears.

5. Use / to select the desired speaker.
6. Adjust options using / / / buttons.
7. Press SELECT/ENTER to confirm your selection. Returns to the previous menu.

Speaker selection

Select a speaker that you want to adjust. [Front speaker (Front L), Front speaker (Front R), Center Speaker (Center), Subwoofer (Woofer), Rear speaker (Rear L) or Rear speaker (Rear R)]

Size

Since the speaker settings are fixed, you cannot change the setting.

Volume

Press / to adjust the output level of the selected speaker. (-5dB ~ 5dB)

Distance

If you have connected speakers to your DVD Player, setting the Distance lets the speakers know how far the sound has to travel to reach your set listening point. This allows the sound from each speaker to reach the listener at the same time.

Press / to adjust the Distance of the selected speaker.

Test

Select "All" to test the signals of each speaker. Adjust the volume to match the volume of test signals memorized in the system.

(When the size of the Front L/R speaker is selected to "Large", the subwoofer (Woofer) is not available.)

Front L → Center → Front R → Rear R → Rear L → Woofer

You can adjust the volume during operating the test tone, first use / to select Volume or Speaker option then use / buttons to select volume or speaker, so that all speaker's volume is same from the listener's position.

Dynamic Range Control (DRC) **DVD**

With the DVD format, you can hear a program's soundtrack in the most accurate and realistic presentation possible, thanks to digital audio technology. However, you may wish to compress the dynamic range of the audio output (the difference between the loudest sounds and the quietest ones). This allows you to listen to a movie at a lower volume without losing clarity of sound. Set DRC to On for this effect.

Vocal **DVD**

Set Vocal to On only when a multi-channel Karaoke DVD is playing. The karaoke channels on the disc will mix into a normal stereo sound.

Before Operation

LOCK (Parental Control)



Rating **DVD**

Some movies contain scenes that may not be suitable for children to view. Many of these discs contain parental control information that applies to the complete disc or to certain scenes on the disc. Movies and scenes are rated from 1 to 8, depending on the country. Some discs offer more suitable scenes as an alternative.

The parental control feature allows you to block access to scenes below the rating you input, thereby preventing your children from being able to view material you believe is unsuitable.

1 Select "Rating" on the LOCK menu then press **▶**.

2 To access the Rating, Password and Country Code features, you must input the 4-digit security code you created.

If you have not yet entered a security code you are prompted to do so.

Input a 4-digit code and press SELECT/ENTER. Enter it again and press SELECT/ENTER to verify. If you make a mistake before pressing SELECT/ENTER, press CLEAR.

3 Select a rating from 1 to 8 using the **▲/▼** buttons.

Rating 1-8: Rating one (1) has the most restrictions and rating eight (8) is the least restrictive.

Unlock

If you select unlock, parental control is not active and the disc plays in full.

Note

If you set a rating for the player, all disc scenes with the same rating or lower are played. Higher rated scenes are not played unless an alternate scene is available on the disc. The alternative must have the same rating or a lower one. If no suitable alternative is found, playback stops. You must enter the 4-digit password or change the rating level in order to play the disc.

4 Press SELECT/ENTER to confirm your rating selection, then press SETUP to exit the menu.

Password (Security Code)

You can enter or change password.

- 1 Select Password on the LOCK menu then press **▶**.
- 2 Follow step 2 as shown left (Rating). "Change" or "New" is highlighted.
- 3 Enter the new 4-digit code, then press SELECT/ENTER. Input it again to verify.
- 4 Press SETUP to exit the menu.

If you forget your Security Code

If you forget your security code you can clear it using the following steps:

- 1 Input the 6-digit number "210499" on the setup menu and the security code is cleared.
- 2 Enter a new code as described above.

Note

When "INPUT PASSWD ■■■■■■" appears on the TV screen, press STOP (**■**) and then press SETUP to move to the setup menu.

Country Code **DVD**

Enter the code of the country/area whose standards were used to rate the DVD video disc, based on the list in the reference chapter.

1 Select "Country Code" on the LOCK menu then press **▶**.

2 Follow step 2 as shown left (Rating).

3 Select the first character using **▲/▼** buttons.

4 Shift the cursor using **▶** button and select the second character using **▲/▼** buttons.

5 Press SELECT/ENTER to confirm your country code selection.

Before Operation

OTHERS

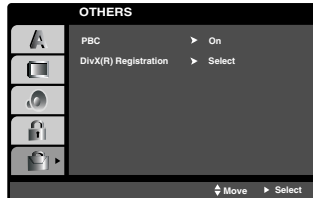

PBC (Playback Control)

Playback control provides special navigation features that are available on some disc. Select [On] to use this feature.

DivX(R) Registration **DivX**

You can show the DivX DRM (Digital Rights Management) Registration code for your unit only.

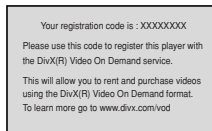

The Registration code is used for VOD (Video-On-Demand) service agent. You can purchase or rental an encrypt movie file.

N Notes

If you rent the DivX VOD file, it has several options of viewing limits as show below.

- Display the number which you can watch the file.

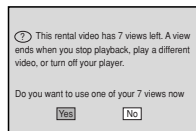

- The rental has been expired.

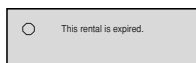

- Display the authorization error.

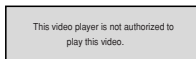

Operation with DVD

Playing a DVD

Playback Setup

- Turn on the TV and select the video input source connected to the unit.
- Audio system: Turn on the audio system and select the input source connected to the unit.

- 1** Press **▲ OPEN/CLOSE** button to open the disc tray.
- 2** Load your chosen disc in the tray, with the playback side facing down.
- 3** Press **▲ OPEN/CLOSE** button to close the tray. Playback starts automatically. If playback does not start, press **PLAY**.
In some cases, the disc menu might appear instead.

T If a menu screen is displayed

The menu screen may be displayed first after loading a DVD which contains a menu.

DVD

Use the **▲ / ▼ / ◀ / ▶** buttons to select the title/chapter you want to view, then press **SELECT/ENTER** to start. Press **TITLE** or **MENU** to return to the menu screen.

N Notes

- If parental control is set and the disc is not within the rating settings you must input the password. (See "LOCK" on page 12.)
- DVDs may have a region code. Your player will not play discs that have a region code different from your player. The region code for this player is 5 (five).

General Features

N Note

Unless stated otherwise, all operations described use the remote control. Some features may also be available on the Setup menu.

Moving to another TITLE **DVD**

When a disc has more than one title, you can move to another title. Press **DISPLAY** while playback is stopped then the appropriate number (0-9) or use **◀ / ▶** to move to another title.

You can play any title by inputting its number while playback is stopped.

Moving to another CHAPTER/TRACK

DVD **DivX**

When a title on a disc has more than one chapter or a disc has more than one track, you can move to another chapter/track as follows:

- Press **◀◀** or **▶▶** briefly during playback to select the next chapter/track or to return to the beginning of the current chapter/track.
- Press **◀◀** twice briefly to step back to the previous chapter/track.
- To go directly to any chapter during DVD playback, press **DISPLAY** and press **▲ / ▼** to select the chapter/track icon. Then, input the chapter/track number or use **◀ / ▶**.

Search **DVD** **DivX**

- 1 Press **◀◀** or **▶▶** during playback.
The player will now go into **SEARCH** mode.
- 2 Press **◀◀** or **▶▶** repeatedly to select the required speed.
DVD; X2, X4, X8, X16, X100
DivX; X2, X4, X8, X16
- 3 To exit **SEARCH** mode, press **PLAY**.

Still Picture and Frame-by-frame playback

DVD **DivX**

- 1 Press **PAUSE/STEP** on the remote control during playback.
The player will now go into **PAUSE** mode.
- 2 You can advance the picture frame-by-frame by pressing **PAUSE/STEP** repeatedly on the remote control.
- 3 To exit still motion mode, press **PLAY**.

Slow Motion **DVD**

- 1 Press **PAUSE/STEP** on the remote control during playback.
The player will enter **PAUSE** mode.
- 2 Use the **◀◀▶▶** to select the required speed: **◀◀** 1/2, **◀◀** 1/4, **◀◀** 1/8 or **◀◀** 1/16 [(backward) - DVD only] or **▶▶** 1/2, **▶▶** 1/4, **▶▶** 1/8 or **▶▶** 1/16 (forward).
- 3 To return to normal **PLAY**, press **PLAY**.

Operation with DVD

General Features (continued)

Repeat **DVD** **DivX**

You can play a title/chapter/all/track on a disc. Press REPEAT during playback to select a desired repeat mode.

DVD Video Discs - Repeat Chapter/Title/Off

- Chapter: repeats the current chapter.
- Title: repeats the current title.
- Off: does not play repeatedly.

DivX - Repeat Track/All/Off

- Track: repeats the current track
- All: repeats all the tracks on a disc.
- Off: does not play repeatedly.



Repeat A-B **DVD**

To repeat a sequence in a title:

- 1 Press A-B at your chosen starting point. "A -" appears briefly on the TV screen.
- 2 Press A-B again at your chosen end point. "A - B" appears briefly on the TV screen, and the repeat sequence begins.
- 3 To cancel the sequence, press A-B.





Time Search **DVD**

The Time Search function allows you to start playing at any chosen time on the disc.

- 1 Press DISPLAY during playback. The on-screen display appears on the screen. The Time Search box shows the elapsed playing time of the current disc.
- 2 Within 10 seconds, press  /  to select the Time Search icon in the on-screen display. The "--:--:" appears in the Time Search box.
- 3 Within 10 seconds, use the number buttons to enter the required start time. Enter hours, minutes, and seconds from left to right in the box. If you enter the wrong numbers, press CLEAR to remove the numbers you entered. Then enter the correct numbers.
- 4 Within 10 seconds, press SELECT/ENTER to confirm the start time. Playback starts from the selected time on the disc. If you enter an invalid time, playback will continue from the current point.

Special DVD Features **DVD**

Checking the contents of DVD Video discs: Menus

DVDs may offer menus that allow you to access special features. To use the disc menu, press MENU. Then, press the appropriate number button to select an option. Or, use the  /  /  /  buttons to highlight your selection, then press SELECT/ENTER.

Title Menu **DVD**

- 1 Press TITLE. If the current title has a menu, the menu will appear on the screen. Otherwise, the disc menu may appear.
- 2 The menu can list camera angles, spoken language and subtitle options, and chapters for the title.
- 3 To remove the title menu, press TITLE again.

Disc Menu **DVD**

Press MENU. The disc menu is displayed.

Changing the Audio Language **DVD**

Press AUDIO repeatedly during playback to hear a different audio language or audio track.

Subtitle **DVD**

Press SUBTITLE repeatedly during playback to see the different subtitle languages.

Note

If  appears, the feature is not available on the disc.

Operation with DVD and Video CD

Special DVD Features **DVD**

System Select

You must select the appropriate system mode for your TV system. If NO DISC appears in the display window, press and hold **PIP/STEP** on the front panel for more than 5 seconds to be able to select a system (PAL, NTSC, or AUTO).

- When the selected system does not coincide with the system of your TV, normal color picture may not be displayed.

AUTO: Select when DVD player is connected with Multi system TV.

NTSC: Select when DVD player is connected with NTSC-TV.

PAL: Select when DVD player is connected with PAL-TV.

Last Scene Memory **DVD**

This player memorizes the user settings for the last disc that you have viewed. Settings remain in memory even if you remove the disc from the player or switch off the player. If you load a disc that has its settings memorized, the latest stop position is automatically recalled.

N Notes

- Settings are stored in memory for use any time.
- This player does not memorize settings of a disc if you switch off the player before commencing to play it.

Screen Saver

The screen saver picture appears when you leave the DVD Player in stop mode for about five minutes. After the Screen Saver has been engaged for about five minutes, the DVD Player will automatically turn itself off.

Operation with Audio CD and MP3/WMA Disc

Playing an Audio CD and MP3/WMA

Disc **CD** **MP3** **WMA**

The DVD Karaoke can play MP3/WMA formatted recordings on CD-ROM, CD-R, or CD-RW discs.

Audio CD

Once you insert an audio CD a menu appears on the TV screen. Press **▲** / **♥** to select a track then press **PLAY** or **SELECT/ENTER** and playback starts.



MP3 / WMA

1. Press **▲** / **♥** to select a folder, and press **SELECT/ENTER** to see the folder contents.
2. Press **▲** / **♥** to select a track then press **PLAY** or **SELECT/ENTER**. Playback starts.

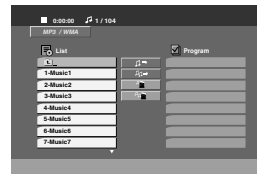

N Notes

- If you are in a file list on the MP3/WMA menu and want to return to the Folder list, use the **▲** / **♥** to highlight **List** and press **SELECT/ENTER**.
- Press **MENU** to go to the next page.
- On a CD with MP3/WMA file and JPEG file, you can switch MP3/WMA and JPEG menu. Press **TITLE** and MP3/WMA or JPEG word on top of the menu is highlighted. Then, use **◀** / **▶** to select MP3/WMA or JPEG then press **SELECT/ENTER**.

Pause **CD** **MP3** **WMA**

- 1 Press **PAUSE/STEP** during playback.
- 2 To return to playback, press **PLAY** or press **PAUSE/STEP** again.

Moving to another Track **CD** **MP3** **WMA**

- Press **◀** or **▶** briefly during playback to go to the next track or to return to the beginning of the current track.
- Press **◀** twice briefly to step back to the previous track.
- In case of audio CD, to go directly to any track, enter the track number using the numbered buttons (0-9) during playback.

Operation with Audio CD and MP3/WMA Disc

Repeat Track/All/Off **CD** **MP3** **WMA**

You can play a title/chapter/all/track on a disc.

- 1 Press REPEAT when playing a disc. The repeat icon appears.
- 2 Press REPEAT to select a desired repeat mode.
 - Track: repeats the current track
 - All: repeats all the tracks on a disc.
 - Off(No display): does not play repeatedly.

Search **CD** **MP3** **WMA**

- 1 Press ◀◀ or ▶▶ during playback.
The player will now go into SEARCH mode.
- 2 To exit SEARCH mode, press PLAY.

MP3 / WMA disc compatibility with this player is limited as follows:

- Sampling frequency: within 32 - 48 kHz (MP3), within 24 - 48kHz (WMA)
- Bit rate: within 32 - 320kbps (MP3), 40 - 192kbps (WMA)
- The player cannot read an MP3/WMA file that has a file extension other than ".mp3" / ".wma".
- CD-R physical format should be ISO 9660
- If you record MP3 / WMA files using software that cannot create a file system (eg. Direct-CD) it is impossible to playback MP3 / WMA files. We recommend that you use Easy-CD Creator, which creates an ISO 9660 file system.
- File names should have a maximum of 8 letters and must incorporate an .mp3 or .wma extension.
- They should not contain special letters such as / ? * : " < > | etc.
- The total number of files on the disc should be less than 999.

This DVD player requires discs and recordings to meet certain technical standards in order to achieve optimal playback quality. Pre-recorded DVDs are automatically set to these standards. There are many different types of recordable disc formats (including CD-R containing MP3 or WMA files) and these require certain pre-existing conditions (see above) to ensure compatible playback.

Customers should note that permission is required in order to download MP3 / WMA files and music from the Internet. Our company has no right to grant such permission. Permission should always be sought from the copyright owner.

Programmed Playback **CD** **MP3** **WMA**

The Program function enables you to store your favorite tracks from any disc in the player memory. A program can contain 300 tracks (Audio CD/MP3/WMA).

1 Insert a disc.

Audio CD and MP3/WMA Discs:

Audio CD or MP3/WMA menu appears as below.



Audio CD Menu



MP3/WMA Menu

2 Select a track on the List.

- 3 Press PROGRAM. Or, select "⏪ → Add" icon then SELECT/ENTER to place the selected track on the Program list. Repeat to place additional tracks on the list.

Note

You can add all tracks in the disc. Select "⏪ → Add All" icon then press SELECT/ENTER.

- 4 Select the track you want to start playing on the Program list.

Tip

Press MENU to move to the next page.

- 5 Press PLAY or SELECT/ENTER to start.

Playback begins in the order in which you programmed the tracks and "PROG." appears on the display window. Playback stops after all of the tracks on the Program list have played once.

Repeat Programmed Tracks

You can play a title/chapter/all/track on a disc.

- 1 Press REPEAT when playing a disc. The repeat icon appears.
- 2 Press REPEAT to select a desired repeat mode.
 - TRACK: repeats the current track
 - ALL: repeats all the tracks on a disc.
 - Off (No display): does not play repeatedly.

Erasing a Track from Program List

- 1 Use ⏪ / ♥ / ◀ / ▶ to select the track that you wish to erase from the Program list.
- 2 Press CLEAR. Or, select "🗑️ (Delete)" icon then Press SELECT/ENTER to place the selected track on the Program list. Repeat to erase additional tracks on the list.

Erasing the Complete Program List

Select "🗑️ (Del all)", then press SELECT/ENTER. The complete Program for the disc is erased.

Note

The programs are also cleared when the disc is removed.

To resume normal playback from programmed playback

Select a track on the List then press SELECT/ENTER. "PROG." disappears from the display window.

Operation with JPEG Disc

Viewing a JPEG disc **JPEG**

This unit can play discs with JPEG files. Before playing JPEG recordings, read the notes on JPEG Recordings on right.

- 1 **Insert a disc and close the tray.**
The JPEG menu appears on the TV screen.

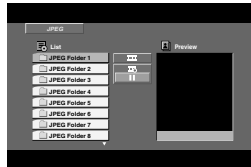

- 2 Press **▲/▼** to select a folder, and press **SELECT/ENTER**. A list of files in the folder appears.

T Tip

If you are in a file list and want to return to the Folder list, use the **▲/▼** buttons on the remote to highlight “**..**” and press **SELECT/ENTER** to return to the previous menu screen.

- 3 **If you want to view a particular file, press ▲/▼ to highlight a file and press SELECT/ENTER or PLAY.**
Slide Show starts from the selected file if Speed option is not Off.
While viewing a file, you can press **STOP(■)** to move to the previous menu (JPEG menu).

T Tip

- Press **MENU** to move to the next page.
- There are four Slide Speed options: **■** : > (Slow), >> (Normal), >>> (Fast) and II (off).
Use **▲/▼/◀/▶** to highlight the Speed. Then, use **◀/▶** to select the option you want to use then press **SELECT/ENTER**.
- If you set Speed option to Off, Slide Show is not active.

Slide Show

Use **▲/▼/◀/▶** to highlight the **■** (Slide Show) then press **SELECT/ENTER**.

Moving to another File

Press **◀◀** or **▶▶** once during viewing a picture to advance to the next file or to the previous file.

Still Picture

- 1 Press **PAUSE/STEP** during slide show.
The player will now go into PAUSE mode.
- 2 To return to the slide show, press **PLAY** or press **PAUSE/STEP** again.

JPEG disc compatibility with this player is limited as follows:

- Depending upon the size and number of JPEG files, it could take a long time for the DVD player to read the disc's contents. If you don't see an on-screen display after several minutes, some of the files may be too large — reduce the resolution of the JPEG files to less than 2760 x 2048 pixels and burn another disc.
- The total number of files and folders on the disc should be less than 999.
- Some discs may be incompatible due to a different recording format or the condition of disc.
- Ensure that all the selected files have the “.jpg” extensions when copying into the CD layout.
- If the files have “.jpe” or “.jpeg” extensions, please rename them as “.jpg” file.
- File names without “.jpg” extension will not be able to be read by this DVD player. Even though the files are shown as JPEG image files in Windows Explorer.

Operation with DivX Disc

The unit can play the DivX files.

- 1 Insert a disc and close the tray.**
The DivX menu appears on the TV screen.

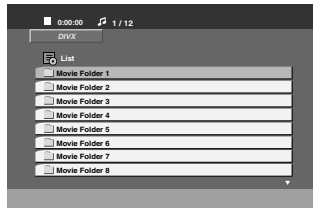

- 2 Press \blacktriangle / \blacktriangledown to select a folder, and press SELECT/ENTER to see the folder contents.**

Tip

If you are in a file list and want to return to the Folder list, use the \blacktriangle / \blacktriangledown buttons on the remote control to highlight " " and press SELECT/ENTER to return to the previous menu screen.

- 3 If you want to view a particular file, press \blacktriangle / \blacktriangledown to highlight a file and press SELECT/ENTER or PLAY.**
Playback starts.

Notes

- Be sure to select "SUBTITLE ON" mode by pressing the subtitle file every time before playing a DivX file .
- When the subtitle has more than two languages in the file, original subtitle is only available.

Display **DivX**

Press DISPLAY during playback.

General playback status can be displayed on the TV screen.

DivX disc compatibility with this player is limited as follows:

- Available resolution size of the DivX file is under 720x576 (W x H) pixel.
- The file name of the DivX subtitle is available by 20-40 characters (differs from language).
- If there is impossible code to express in the DivX file, it may be displayed as " _ " mark on the display.
- **If the number of the screen frame is over 30 per 1 second, this unit may not operate normally.**
- **If the video and audio structure of recorded file is not interleaved, either video or audio is out-putted.**
- **If the file is recorded with GMC, the unit supports some of 1-point of the record level.**
* GMC?
GMC is the acronym for Global Motion Compensation. It is an encoding tool specified in MPEG4 standard. Some MPEG4 encoder, like DivX or Xvid, have this option. There are different levels of GMC encoding, usually called 1-point, 2-point, or 3-point GMC.

Playable DivX subtitle file

- ".srt ", ".smi ", ".sub "

Playable DivX file

- ".avi ", ".mpg ", ".mpeg "

Playable Codec format

- "DIVX3.xx ", "DIVX4.xx ", "DIVX5.xx ", "XVID ", "MP43 ", "3IVX ", "MP42 "

Playable Audio format

- "AC3 ", "DTS ", "PCM ", "MP3 ", "WMA "
- Sampling frequency: within 32 - 48 kHz (MP3), within 24 - 48kHz (WMA)
- Bit rate: within 32 - 320kbps (MP3), 40 - 192kbps (WMA)

Operation with KARAOKE

You can play KARAOKE(singing along) with CD by connecting a microphone to the unit.
You can enjoy KARAOKE with a stereo-recorded disc, even if it is a non-karaoke disc, by reducing the singer's voice.

Karaoke Basic Playback

- 1** Check if the system is connected.
(Refer to the page 6-7.)
- 2** Turn on the powers of TV (or Amplifier) and DVD Karaoke and enter to the video mode on TV.
- 3** Press **▲ OPEN/CLOSE** to open the disc tray and load supplied karaoke disc in the tray with the label facing up.
- 4** Press **▲ OPEN/CLOSE** to close the tray.

[TV Screen]



- 5** Connect the microphone to the MIC 1 or MIC 2 jack.
- 6** Select the melody number you want by pressing **NUMERIC** buttons.
If you cancel the selected melody number, press the **CLEAR**.
- 7** Press **PLAY**.
The selected melody number is played.
Sing in tone with microphone.
After melody ends, it is stopped automatically and score appears.

Note
Don't connect the microphone during playing DivX disc.

Karaoke Advanced Playback

Return Function

This is a function that returns to the preceding MENU.

Press the **RETURN**.

Note

If there is no preceding menu (in case of the first menu), this function may not be executed.

To Adjust MIC Volume

Press the Microphone volume control (**MIC VOL.** /) button on the remote control clockwise to increase the volume, or counterclockwise to decrease it. (0~15 steps)

To Adjust ECHO Volume

You can give an echo effect to the sound from the microphones.

Press the ECHO volume control (**ECHO VOL.** /) button on the remote control clockwise to increase the echo, or counterclockwise to decrease it. (0~15 steps)

Key Control

You can change the key to suit your vocal range.
You can adjust the key to 13 steps (6steps higher, 6steps lower and the original key).
- The setting appears on the screen.

Press **KEY CONTROL (b/#)** repeatedly on the remote control or turn **KEY CONTROL (b/#)** on the front panel to find the key that suits your vocal range.

- To flatten the key one by one, press the **KEY CONTROL (b)** repeatedly during playback.
- To sharp the key one by one, press the **KEY CONTROL (#)** repeatedly during playback.
- To return to the original key, press the **KEY CONTROL (b/#)** repeatedly to appear the original key.

Operation with KARAOKE

Reserving the Songs

When you want to make a reservation of next melody, you can enjoy the most 8 melodies reservation Without waiting.

1 Press the **NUMERIC** buttons to reserve melody number you want in the karaoke disc play mode.

Melody number appears on the TV screen.

2 Press **PROGRAM**.

The melody number is made a reservation.

3 Repeat steps 1-2.

You can reserve 8 songs.

Tip

After the one song finishes its playback, the next song will be playback automatically.

To cancel the reserved song

Each time you press CLEAR, the reserved song will be cancelled one by one.

To cancel or change the wrong reserved song

Press the PROGRAM to move to the desired position, then press the CLEAR to cancel the reserved song.

Male/Female Function

If you want to sing a song of MAN's or WOMEN's key, press MALE(♂)/FEMALE(♀) button repeatedly to change MAN's or WOMEN's key.

Tempo Change

You can use this function when you want to play fast or slow.

- Press **TEMPO +** repeatedly during singing to play faster.
- Press **TEMPO -** repeatedly during singing slower.

Shadow Function

If some CD caption and the song's subtitle are mixed up, the song's subtitle may be invisible. In this case, to highlight the song's subtitle, press SHADOW.

- It will be highlighted by background shadow image.

Karaoke MENU Playback

Preparation

Press **MENU** on the karaoke mode.

The main MENU appears on the screen.

Main MENU (On the TV screen)

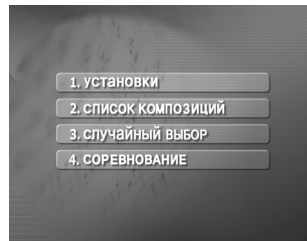

SETUP (УСТАНОВКИ)

1 Select **1. УСТАНОВКИ** by pressing **▲/▼** on the main menu.

2 Use **◀/▶** to select the desired option, and press **SELECT/ENTER**.



SCORE ON/OFF (1. БАЛЛЫ Вкл Выкл)

Вкл : When singing by selection of melody, song score comes out after one piece of song is ended.

To cancel it, select the **Выкл**.

FANFARE ON/OFF (2. ФАНФАРЫ Вкл Выкл)

Вкл : In condition of POWER ON, scoring fanfare operates. The fanfare sound comes out after singing finished.

To cancel it, select the **Выкл**.

LYRIC ON/OFF (3. ТЕКСТ ПЕСНИ Вкл Выкл)

Вкл : When singing by selection of melody, song lyric appears on the TV screen.

To cancel it, select the **Выкл**.

CHORUS ON/OFF (4. БЭК-ВОКАЛ Вкл Выкл)

Вкл : When singing by selection of melody, song chorus is heard a sound.

To cancel it, select the **Выкл**.

Note

To move to the main menu, press **MENU** or **RETURN**.

Operation with KARAOKE

MUSIC LIST (СПИСОК КОМПОЗИЦИЙ)

LOCAL SONG (1. РОССИЙСКИЕ ПЕСНИ) and POP SONG (2. ЗАРУБЕЖНЫЕ ПЕСНИ)

- 1 Select 2. СПИСОК КОМПОЗИЦИЙ by pressing the / on the main menu. The LOCAL SONG, POP SONG and CLASSIC menu will be shown on the TV screen.

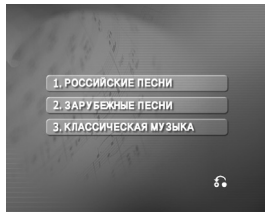

- 2 Select 1. РОССИЙСКИЕ ПЕСНИ or 2. ЗАРУБЕЖНЫЕ ПЕСНИ by pressing the / , and press SELECT/ ENTER. SONG LIST and SINGER LIST menu will be shown on the TV screen.

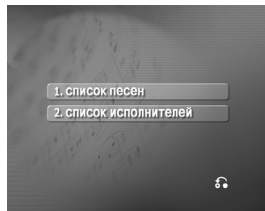

SONG LIST (1. СПИСОК ПЕСЕН)

- 1 Select 1. СПИСОК ПЕСЕН and select the initial of the song title you want by pressing the / , then press SELECT/ ENTER.

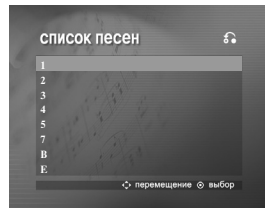

- 2 Select the song title you want by pressing the / , and press SELECT/ ENTER.

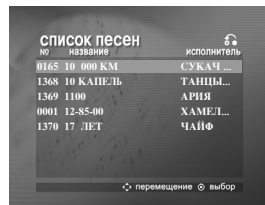

SINGER LIST (2. СПИСОК ИСПОЛНИТЕЛЕЙ)

- 1 Select 2. СПИСОК ИСПОЛНИТЕЛЕЙ and select the initial of the singer you want by pressing the / in the SONG LIST and SINGER LIST menu, and press SELECT/ ENTER.

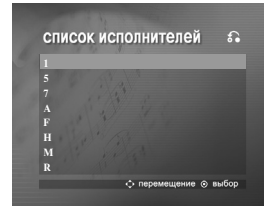

- 2 Select the singer you want by pressing the / , and press SELECT/ ENTER.

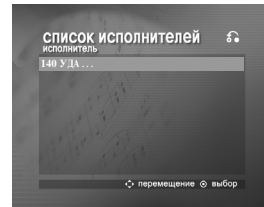

- 3 Select the song title of the singer you want by pressing the / , and press SELECT/ ENTER.



Note

- To move the previous mode, select the by pressing the / , then press SELECT/ ENTER.
- The special letters may not be displayed on the TV screen.

Operation with KARAOKE

CLASSIC (3. КЛАССИЧЕСКАЯ МУЗЫКА)

- 1** Select **3. КЛАССИЧЕСКАЯ МУЗЫКА** by pressing the **▲/▼**, and press **SELECT/ ENTER** in the **LOCAL SONG, POP SONG** and **CLASSIC** menu. The **CLASSIC LIST** and **COMPOSER LIST** menu will be shown on the TV screen.

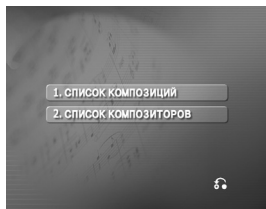

CLASSIC LIST (1. СПИСОК КОМПОЗИЦИЙ)

- 1** Select **1. СПИСОК КОМПОЗИЦИЙ** and select the initial of the song title you want by pressing the **▲/▼**, then press **SELECT/ ENTER**.

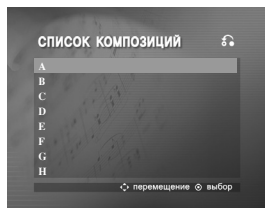

- 2** Select the song title you want by pressing the **▲/▼**, and press **SELECT/ ENTER**.



COMPOSER LIST (2. СПИСОК КОМПОЗИТОРОВ)

- 1** Select **2. СПИСОК КОМПОЗИТОРОВ** and select the initial of the composer you want by pressing the **▲/▼** in the **CLASSIC LIST** and **COMPOSER LIST** menu, and press **SELECT/ ENTER**.

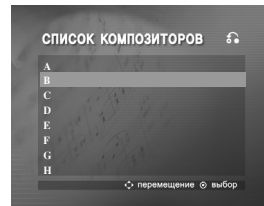

- 2** Select the composer you want by pressing the **▲/▼**, and press **SELECT/ ENTER**.

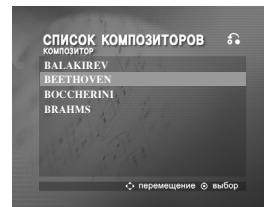

- 3** Select the song title of the composer you want by pressing the **▲/▼**, and press **SELECT/ ENTER**.



Note

To move the previous mode, select the **↶** by pressing the **▲/▼**, then press **SELECT/ ENTER**.

Operation with KARAOKE

RANDOM (случайный выбор)

- 1** Select **3. СЛУЧАЙНЫЙ ВЫБОР** by pressing **▲/♥** on the main menu.

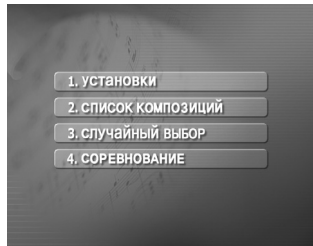

- 2** Press **SELECT/ENTER** to begin randomly.

CHALLENGE (СОРЕВНОВАНИЕ)

It has a function which enjoy a song game dividing by two teams of red team & blue team.

- 1** Select **4. СОРЕВНОВАНИЕ** by pressing **▲/♥** on the main menu.
It appears as below.

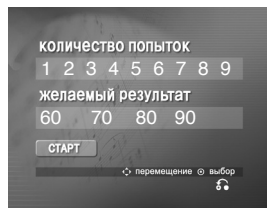

- 2** Select **КОЛИЧЕСТВО ПОПЫТОК** by pressing **▲/♥**, and select one of **NUMERIC** buttons 1~9 by pressing **◀/▶** to select winner's number, then press **SELECT/ENTER**.
- 3** Select **желаемый результат** by pressing **▲/♥**, and select one of 60,70,80 or 90 by pressing **◀/▶** to select success score, then press **SELECT/ENTER**.
- 4** Select **СТАРТ** by pressing **▲/♥**, then press **SELECT/ENTER**.
It appears as below.



- 5** Select number you want by pressing **▲/♥** and press **SELECT/ENTER**.
Sing along with the accompaniment.

- 6** Repeat step 4~5.
Change the team of red team or blue team alternately.

- 7** When reaching the targeted winning number, the **ПОЗДРАВЛЯЕМ** will be shown on the TV screen.
It appears as below.



- 8** Whether you keep going the song game or not, select **1. ДА** or **2. НЕТ** by pressing **▲/♥** as below.

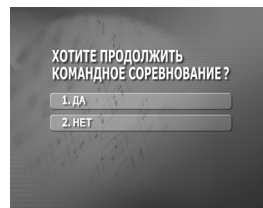

Language Code List

Use this list to input your desired language for the following initial settings:
Disc Audio, Disc Subtitle, Disc Menu.

Language	Code	Language	Code	Language	Code	Language	Code
Abkhazian	6566	Finnish	7073	Macedonian	7775	Slovenian	8376
Afar	6565	French	7082	Malagasy	7771	Somali	8379
Afrikaans	6570	Galician	7176	Malay	7783	Spanish	6983
Albanian	8381	Georgian	7565	Malayalam	7776	Sudanese	8385
Ameharic	6577	German	6869	Maltese	7784	Swahili	8387
Arabic	6582	Greek	6976	Maori	7773	Swedish	8386
Armenian	7289	Greenlandic	7576	Marathi	7782	Tagalog	8476
Assamese	6583	Guarani	7178	Moldavian	7779	Tajik	8471
Azerbaijani	6590	Gujarati	7185	Mongolian	7778	Tamil	8465
Bashkir	6665	Hausa	7265	Nauru	7865	Tatar	8484
Basque	6985	Hebrew	7387	Nepali	7869	Telugu	8469
Bengali; Bangla	6678	Hindi	7273	Norwegian	7879	Thai	8472
Bhutani	6890	Hungarian	7285	Oriya	7982	Tibetan	6679
Bihari	6672	Icelandic	7383	Panjabi	8065	Tigrinya	8473
Breton	6682	Indonesian	7378	Pashto, Pushto	8083	Tonga	8479
Bulgarian	6671	Interlingua	7365	Persian	7065	Turkish	8482
Burmese	7789	Irish	7165	Polish	8076	Turkmen	8475
Byelorussian	6669	Italian	7384	Portuguese	8084	Twí	8487
Cambodian	7577	Japanese	7465	Quechua	8185	Ukrainian	8575
Catalan	6765	Javanese	7487	Rhaeto-Romance	8277	Urdu	8582
Chinese	9072	Kannada	7578	Rumanian	8279	Uzbek	8590
Corsican	6779	Kashmiri	7583	Russian	8285	Vietnamese	8673
Croatian	7282	Kazakh	7575	Samoan	8377	Volapük	8679
Czech	6783	Kirghiz	7589	Sanskrit	8365	Welsh	6789
Danish	6865	Korean	7579	Scots Gaelic	7168	Wolof	8779
Dutch	7876	Kurdish	7585	Serbian	8382	Xhosa	8872
English	6978	Laotian	7679	Serbo-Croatian	8372	Yiddish	7473
Esperanto	6979	Latin	7665	Shona	8378	Yoruba	8979
Estonian	6984	Latvian, Lettish	7686	Sindhi	8368	Zulu	9085
Faroese	7079	Lingala	7678	Singhalese	8373		
Fiji	7074	Lithuanian	7684	Slovak	8375		

REFERENCE

Country Code List

Choose a country code from this list.

Country	Code	Country	Code	Country	Code	Country	Code
Afghanistan	AF	Ethiopia	ET	Malaysia	MY	Saudi Arabia	SA
Argentina	AR	Fiji	FJ	Maldives	MV	Senegal	SN
Australia	AU	Finland	FI	Mexico	MX	Singapore	SG
Austria	AT	France	FR	Monaco	MC	Slovak Republic	SK
Belgium	BE	Germany	DE	Mongolia	MN	Slovenia	SI
Bhutan	BT	Great Britain	GB	Morocco	MA	South Africa	ZA
Bolivia	BO	Greece	GR	Nepal	NP	South Korea	KR
Brazil	BR	Greenland	GL	Netherlands	NL	Spain	ES
Cambodia	KH	Islands	HM	Dutch Antilles	AN	Sri Lanka	LK
Canada	CA	Hong Kong	HK	New Zealand	NZ	Sweden	SE
Chile	CL	Hungary	HU	Nigeria	NG	Switzerland	CH
China	CN	India	IN	Norway	NO	Taiwan	TW
Colombia	CO	Indonesia	ID	Oman	OM	Thailand	TH
Congo	CG	Israel	IL	Pakistan	PK	Turkey	TR
Costa Rica	CR	Italy	IT	Panama	PA	Uganda	UG
Croatia	HR	Jamaica	JM	Paraguay	PY	Ukraine	UA
Czech Republic	CZ	Japan	JP	Philippines	PH	United States	US
Denmark	DK	Kenya	KE	Poland	PL	Uruguay	UY
Ecuador	EC	Kuwait	KW	Portugal	PT	Uzbekistan	UZ
Egypt	EG	Libya	LY	Romania	RO	Vietnam	VN
El Salvador	SV	Luxembourg	LU	Russian Federation	RU	Zimbabwe	ZW

Troubleshooting / Specifications

Check the following guide for the possible cause of a problem before contacting service.

Symptom	Possible Cause	Correction
No power.	• The power cord is disconnected.	• Plug the power cord into the wall outlet securely.
The power is on, but the DVD player does not work.	• No disc is inserted.	• Insert a disc. (Check that the DVD or audio CD indicator in the display window is lit.)
No picture.	• The TV is not set to receive DVD signal output.	• Select the appropriate video input mode on the TV.
	• The video cable is not connected securely.	• Connect the video cable securely.
No sound.	• The equipment connected with the audio cable is not set to receive DVD signal output.	• Select the correct input mode of the audio receiver so you can listen to the sound from the DVD player.
	• The power of the equipment connected with the audio cable is turned off.	• Turn on the equipment connected with the audio cable.
	• The AUDIO options are set to the wrong position.	• Set the Digital Audio Output to the correct position, then turn on the DVD player again by pressing POWER.
The DVD player does not start playback.	• An unplayable disc is inserted.	• Insert a playable disc. (Check the disc type, color system, and regional code.)
	• The rating level is set.	• Cancel the rating function or change the rating level.
The remote control does not work properly.	• The remote control is not pointed at the remote sensor on the DVD player.	• Point the remote control at the remote sensor of the DVD player.
	• The remote control is too far from the DVD player.	• Operate the remote control closer to the DVD player.

General

Power requirements AC 110-240 V, 50/60 Hz
 Power consumption 14 W
 Dimensions (approx.) .430 X 43 X 260 mm (w x h x d)
 Mass (approx.) 2.3 kg
 Operating temperature . . . 5°C to 35°C (41°F to 95°F)
 Operating humidity 5 % to 90 %

Outputs

VIDEO OUT 1 Vp-p 75 Ω,
 sync negative, RCA jack x 1
 Audio output (optical audio) 3 V (p-p), 75 Ω,
 Optical connector x 1
 Audio output (analog audio) . . . 2.0 Vrms (1 KHz, 0 dB),
 600 Ω, RCA jack (L, R) x 1

System

Laser Semiconductor laser, wavelength 650 nm
 Signal system PAL/NTSC/AUTO
 Frequency response DVD (PCM 96 kHz): 8 Hz to 44 kHz
 DVD (PCM 48 kHz): 8 Hz to 22 kHz
 CD: 8 Hz to 20 kHz
 Signal-to-noise ratio More than 100 dB
 (ANALOG OUT connector only)
 Harmonic distortion Less than 0.008 %
 Dynamic range More than 100 dB (DVD)
 More than 95 dB (CD)

- Design and specifications are subject to change without notice.

Manufactured under license from Dolby Laboratories. Dolby, MLP Lossless and the double-D symbol are trademarks of Dolby Laboratories. Confidential unpublished works. Copyright 1992-1997 Dolby Laboratories. All rights reserved.

DTS and DTS Digital Surround are registered trademarks of Digital Theater Systems, Inc.

P/NO : MFL39518837