

User's Guide

L1730SF

Make sure to read the **Important Precautions** before using the product.
Keep the User's Guide(CD) in an accessible place for future reference.

See the label attached on the back cover and quote this information to your dealer when you require service.

This unit has been engineered and manufactured to ensure your personal safety, however improper use may result in potential electrical shock or fire hazards. In order to allow the proper operation of all safeguards incorporated in this display, observe the following basic rules for its installation, use, and servicing.

On Safety

Use only the power cord supplied with the unit. In case you use another power cord, make sure that it is certified by the applicable national standards if not being provided by the supplier. If the power cable is faulty in any way, please contact the manufacturer or the nearest authorized repair service provider for a replacement.

The power supply cord is used as the main disconnection device. Ensure that the socket-outlet is easily accessible after installation.

Operate the display only from a power source indicated in the specifications of this manual or listed on the display. If you are not sure what type of power supply you have in your home, consult with your dealer.

Overloaded AC outlets and extension cords are dangerous. So are frayed power cords and broken plugs. They may result in a shock or fire hazard. Call your service technician for replacement.

Do not Open the Display.

- There are no user serviceable components inside.
- There are Dangerous High Voltages inside, even when the power is OFF.
- Contact your dealer if the display is not operating properly.

To Avoid Personal Injury :

- Do not place the display on a sloping shelf unless properly secured.
- Use only a stand recommended by the manufacturer.
- Do not drop an object on or apply impact to the product. Do not throw any toys or objects on the product screen.
It can cause injury to human, problem to product and damage the display.

To Prevent Fire or Hazards:

- Always turn the display OFF if you leave the room for more than a short period of time. Never leave the display ON when leaving the house.
- Keep children from dropping or pushing objects into the display's cabinet openings. Some internal parts carry hazardous voltages.
- Do not add accessories that have not been designed for this display.
- When the display is to be left unattended for an extended period of time, unplug it from the wall outlet.
- In the presence of thunder and lightning, never touch the power cord and signal cable because it can be very dangerous. It can cause electric shock.

On Installation

Do not allow anything to rest upon or roll over the power cord, and do not place the display where the power cord is subject to damage.

Do not use this display near water such as near a bathtub, washbowl, kitchen sink, laundry tub, in a wet basement, or near a swimming pool.

Displays are provided with ventilation openings in the cabinet to allow the release of heat generated during operation. If these openings are blocked, built-up heat can cause failures which may result in a fire hazard. Therefore, NEVER:

- Block the bottom ventilation slots by placing the display on a bed, sofa, rug, etc.
- Place the display in a built-in enclosure unless proper ventilation is provided.
- Cover the openings with cloth or other material.
- Place the display near or over a radiator or heat source.

Do not rub or strike the Active Matrix LCD with anything hard as this may scratch, mar, or damage the Active Matrix LCD permanently.

Do not press the LCD screen with your finger for a long time as this may cause some afterimages.

Some dot defects may appear as Red, Green or Blue spots on the screen. However, this will have no impact or effect on the display performance.

If possible, use the recommended resolution to obtain the best image quality for your LCD display. If used under any mode except the recommended resolution, some scaled or processed images may appear on the screen. However, this is characteristic of the fixed-resolution LCD panel.

On Cleaning

- Unplug the display before cleaning the face of the display screen.
- Use a slightly damp (not wet) cloth. Do not use an aerosol directly on the display screen because over-spraying may cause electrical shock.

On Repacking

- Do not throw away the carton and packing materials. They make an ideal container in which to transport the unit. When shipping the unit to another location, repack it in its original material.

On Disposal

- The fluorescent lamp used in this product contains a small amount of mercury.
- Do not dispose of this product with general household waste.
Disposal of this product must be carried out in accordance to the regulations of your local authority.

Connecting the Display

- Before setting up the monitor, ensure that the power to the monitor, the computer system, and other attached devices is turned off.

Positioning your display

1. Remove the tape.

<Image 1>

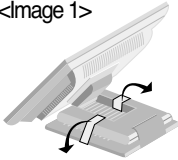

Put the set as the picture below <Image 1> to remove the tape.

<Image 2>

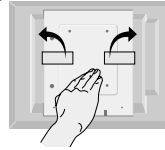

Do not remove the tape with the set up side down as the <Image 2> The base part may spring up to injure your hand.

2. Adjust the position of the panel in various ways for maximum comfort.

- Tilt Range : -20° ~ 140°

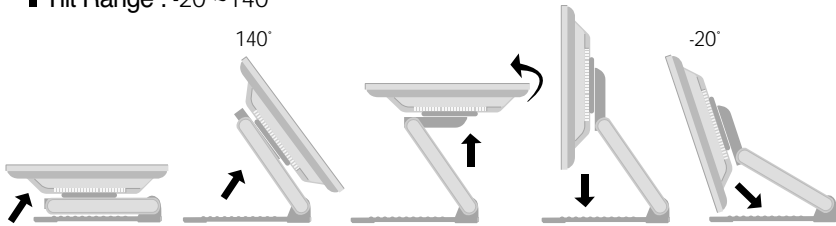

Ergonomic

It is recommended that in order to maintain an ergonomic and comfortable viewing position, the forward tilt angle of the monitor should not exceed 5 degrees.

- Height Range : maximum 2.41inch (61.3mm)

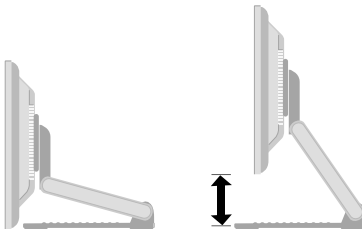

- Landscape & Portrait : You can rotate the panel 90° clockwise.
(* For detailed information, please refer to the Pivot Software CD provided.)

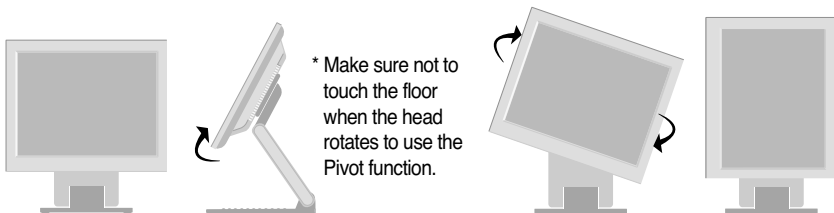



Using the Computer

1. Connect the signal cable. When attached, tighten the thumbscrews to secure the connection. ①
2. Connect the power cord into a proper power outlet that is easily accessible and close to the display. ②

NOTE

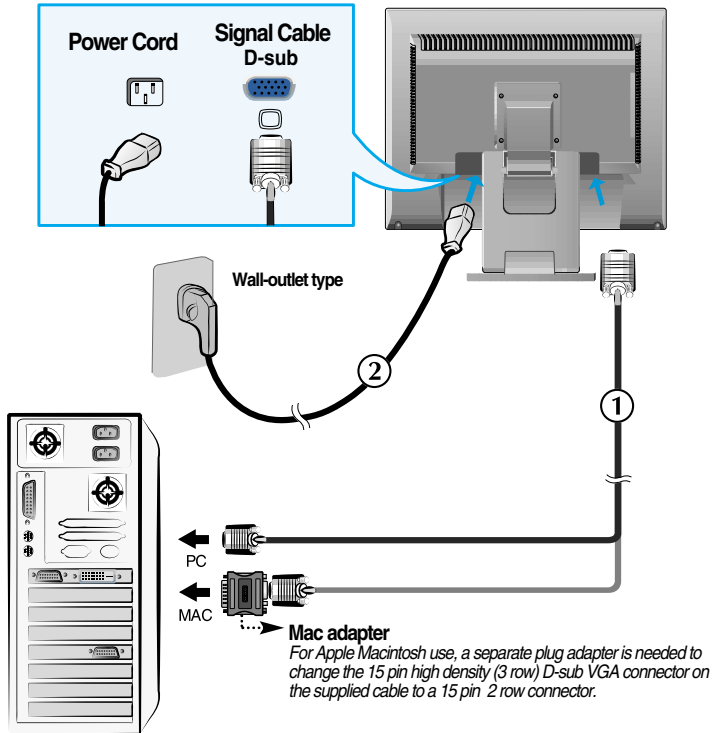
- This is a simplified representation of the rear view.
- This rear view represents a general model; your display may differ from the view as shown.



3. Press  button on the front switch panel to turn the power on. When monitor power is turned on, the 'Self Image Setting Function' is executed automatically. (Only analog mode)



NOTE

'Self Image Setting Function'? This function provides the user with optimal display settings. When the user connects the monitor for the first time, this function automatically adjusts the display to optimal settings for individual input signals.

'SET/AUTO' Function? When you encounter problems such as blurry screen, blurred letters, screen flicker or tilted screen while using the device or after changing screen resolution, press the SET/AUTO function button to improve resolution.

To Use Touch Screen

Select and Install the driver CD provided.



Make sure you have the driver installation CD bundled with the product.

ITM DRIVER

- 1) Insert the driver installation CD for the ITM touch screen.
 - 2) See the touch screen software installation CD for more information and assistance.
 - 3) Connect the USB cable or the RS-232C cable for the touch screen after the driver installation.
- * The software drivers support the following Microsoft Windows operating systems: Windows 95, 98, ME, 2000, XP and NT 4.0.

Hantouch DRIVER

- 1) Connect the USB cable or the RS-232C cable for touch screen before installing the driver.
 - 2) Insert the Hantouch touch screen driver installation CD.
 - 3) Open the [My Computer] -> [LG Driver] -> [Drivers] folder, then select the driver appropriate for your OS.
 - 4) For more information, see the installation manual in the touch screen software installation CD bundled with the product.
- * The software drivers support the following Microsoft Windows operating systems: Windows 95, 98, ME, 2000, XP and NT 4.0.
- For more information about installation for other OS, see the driver installation CD.

* Do not select "install PS/2 interface driver" while installing the touch screen driver for the Hantouch.

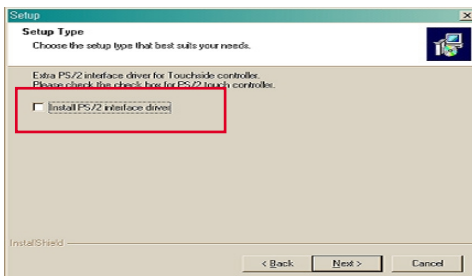

<USB cable for the touch screen>

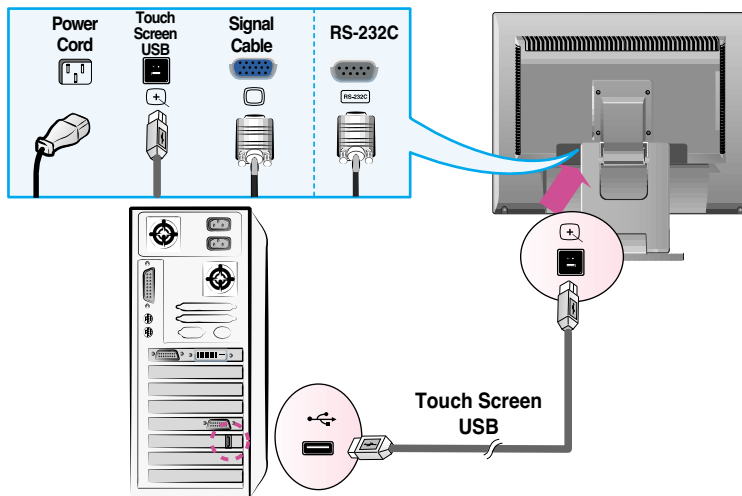

< RS-232C cable for the touch screen >

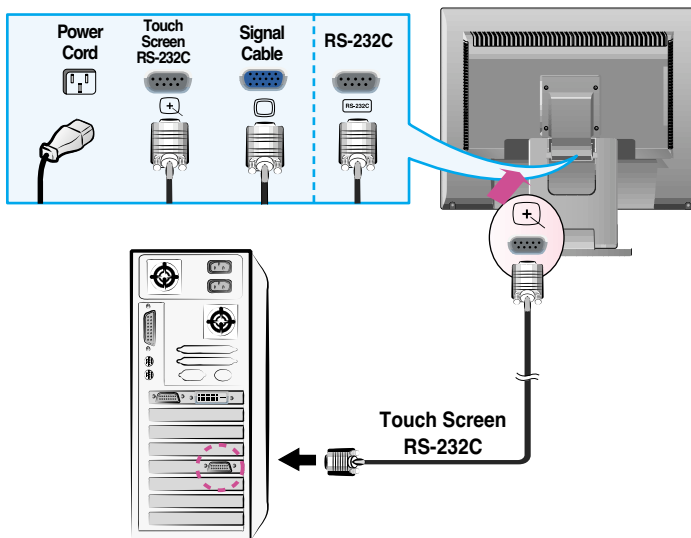

NOTE

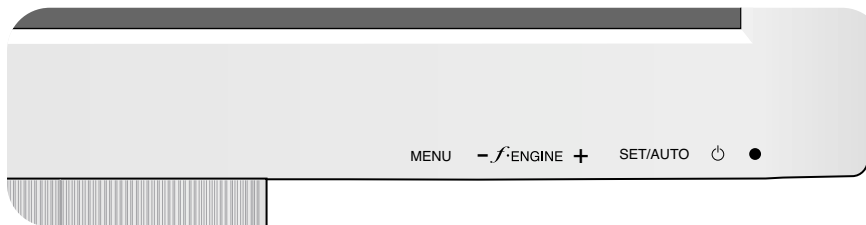

- Your purchased product and its accessories may look different from the items illustrated in this manual.

Front Panel Controls

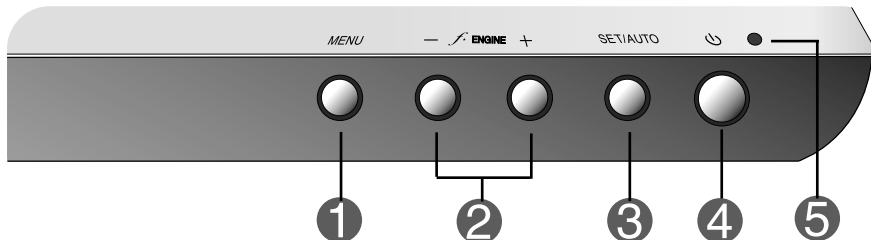

Bottom



Control	Function
<p>1 MENU Button</p> 	<p>Use this button to enter or exit the On Screen Display.</p> <hr/> <p>OSD LOCKED/UNLOCKED</p> <p>This function allows you to lock the current control settings, so that they cannot be inadvertently changed. Press and hold the MENU button for 5 seconds. The message "OSD LOCKED" should appear.</p> <p>You can unlock the OSD controls at any time by pushing the MENU button for 5 seconds. The message "OSD UNLOCKED" should appear.</p>
<p>2 - + Buttons</p> <p><i>f</i>·ENGINE</p> 	<p>Use these buttons to select or adjust functions in the On Screen Display.</p> <hr/> <p>For more information, refer to page A14.</p>

Control	Function
<p>3 SET/AUTO Button</p> 	<p>Use this button to enter a selection in the On Screen Display.</p> <hr/> <p>AUTO IMAGE ADJUSTMENT When adjusting your display settings, always press the SET/AUTO button before entering the On Screen Display(OSD). This will automatically adjust your display image to the ideal settings for the current screen resolution size (display mode). The best display mode is 1280x1024</p>
<p>4 Power Button</p>	<p>Use this button to turn the display on or off.</p>
<p>5 Power Indicator</p>	<p>This Indicator lights up green when the display operates normally(On Mode). If the display is in Sleep Mode (Energy Saving), this indicator color changes to amber.</p>

Screen Adjustment

Making adjustments to the image size, position and operating parameters of the display is quick and easy with the On Screen Display Control system. A short example is given below to familiarize you with the use of the controls. The following section is an outline of the available adjustments and selections you can make using the OSD.

NOTE

- Allow the display to stabilize for at least 30 minutes before making image adjustments.

To make adjustments in the On Screen Display, follow these steps:

MENU → - + → SET/AUTO → - + → MENU

- 1 Press the MENU Button, then the main menu of the OSD appears.
- 2 To access a control, use the - or + Buttons. When the icon you want becomes highlighted, press the SET/AUTO Button.
- 3 Use the - / + Buttons to adjust the image to the desired level. Use the SET/AUTO Button to select other sub-menu items.
- 4 Push the MENU Button once to return to the main menu to select another function. Push the MENU Button twice to exit from the OSD.

Automatic save

With the OSD open, once you have made an adjustment the monitor automatically save any adjustments you have made, even if you exit the menu or open another menu. If you make an adjustment and then wait for the OSD to disappear, the adjustment will also be saved.

On Screen Display(OSD) Selection and Adjustment

The following table indicates all the On Screen Display control, adjustment, and setting menus.

Main menu	Sub menu			Reference
PICTURE	BRIGHTNESS		●	To adjust the brightness, contrast and gamma of the screen
	CONTRAST		●	
	GAMMA		●	
COLOR	PRESET	sRGB	●	To customize the color of the screen
		6500K	●	
		9300K	●	
	RED		●	
	GREEN		●	
	BLUE		●	
POSITION	HORIZONTAL		●	To adjust the position of the screen
	VERTICAL		●	
TRACKING	CLOCK		●	To improve the clarity and stability, sharpness of the screen
	PHASE		●	
	SHARPNESS		●	
SETUP	LANGUAGE		●	To customize the screen status for a user's operating environment
	OSD POSITION	HORIZONTAL	●	
		VERTICAL	●	
	WHITE BALANCE		●	
	POWER INDICATOR		●	
	FACTORY RESET		●	
	SET ID		●	
FLATRON F-ENGINE	MOVIE /TEXT		●	To select or customize desired image settings
	USER		●	
	NORMAL		●	
● : Adjustable				

NOTE

- The order of icons may differ depending on the model (A10~A14).

On Screen Display(OSD) Selection and Adjustment

You were introduced to the procedure of selecting and adjusting an item using the OSD system. Listed below are the icons, icon names, and icon descriptions of the all items shown on the Menu.

Press the MENU Button, then the main menu of the OSD appears.



Menu Name — PICTURE

Icons —

- RGB
- BRIGHTNESS
- CONTRAST
- GAMMA

Sub-menus —



Button Tip

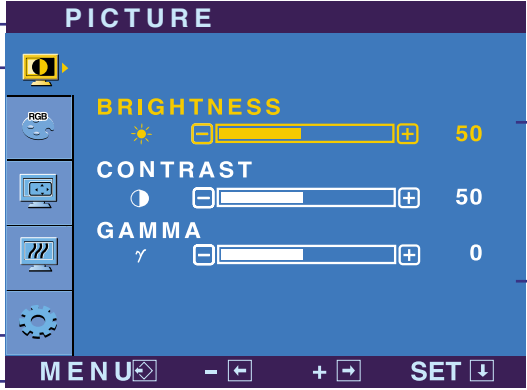

- MENU  : Exit
- - + : Adjust (Decrease/Increase)
- SET  : Enter
-  : Select another sub-menu



NOTE



- OSD (On Screen Display) menu languages on the monitor may differ from the manual.

Main menu	Sub menu	Description
	PICTURE	
	BRIGHTNESS CONTRAST GAMMA	To adjust the brightness of the screen. To adjust the contrast of the screen. Set your own gamma value. : -50/0/50 On the monitor, high gamma values display whitish images and low gamma values display high contrast images.
<ul style="list-style-type: none"> ■ MENU : Exit ■ - : Decrease ■ + : Increase ■ SET : Select another sub-menu 		

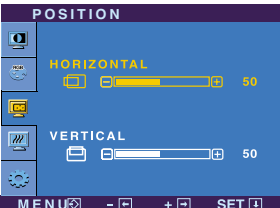
	COLOR	
	PRESET <input checked="" type="checkbox"/> RED <input type="checkbox"/> GREEN <input type="checkbox"/> BLUE	Select the screen color. • sRGB: Set the screen color to fit the SRGB standard color specification. • 6500K: Slightly reddish white. • 9300K: Slightly bluish white. Set your own red color levels. Set your own green color levels. Set your own blue color levels.
<ul style="list-style-type: none"> ■ MENU : Exit ■ - : Decrease ■ + : Increase ■ SET : Select another sub-menu 		

	POSITION	
	HORIZONTAL VERTICAL	To move image left and right. To move image up and down.
<ul style="list-style-type: none"> ■ MENU : Exit ■ - : Decrease ■ + : Increase ■ SET : Select another sub-menu 		

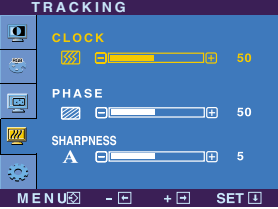
On Screen Display(OSD) Selection and Adjustment

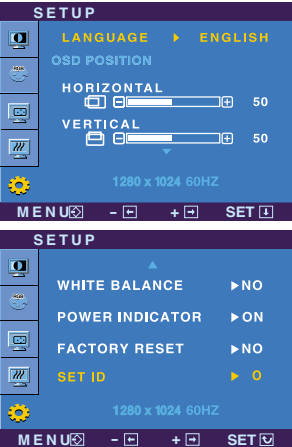
Main menu	Sub menu	Description
 <p>TRACKING</p>  <ul style="list-style-type: none"> ■ MENU : Exit ■ - : Decrease ■ + : Increase ■ SET : Select another sub-menu 	<p>CLOCK</p> <p>PHASE</p> <p>SHARPNESS</p>	<p>To minimize any vertical bars or stripes visible on the screen background. The horizontal screen size will also change.</p> <p>To adjust the focus of the display. This item allows you to remove any horizontal noise and clear or sharpen the image of characters.</p> <p>To adjust the clearness of the screen.</p>
 <p>SETUP</p>  <ul style="list-style-type: none"> ■ MENU : Exit ■ - : Adjust ■ + : Adjust ■ SET : Select another sub-menu 	<p>LANGUAGE</p> <p>OSD POSITION</p> <p>WHITE BALANCE</p> <p>POWER INDICATOR</p> <p>FACTORY RESET</p> <p>SET ID</p>	<p>To choose the language in which the control names are displayed.</p> <p>To adjust position of the OSD window on the screen.</p> <p>If the output of the video card is different the required specifications, the color level may deteriorate due to video signal distortion. Using this function, the signal level is adjusted to fit into the standard output level of the video card in order to provide the optimal image. Activate this function when white and black colors are present in the screen.</p> <p>Use this function to set the power indicator on the front side of the monitor to ON or OFF. If you set OFF, it will go off. If you set ON at any time, the power indicator will automatically be turned on.</p> <p>Restore all factory default settings except "LANGUAGE." Press the + button to reset immediately.</p> <p>You can assign a unique SET ID NO (name assignment) to each monitor when several monitors are connected for display. Specify the number (0 ~ 99) using the -, + button and exit. Use the assigned SET ID to individually control each monitor using the Monitor Control Program.</p>

If this does not improve the screen image, restore the factory default settings.

If necessary, perform the white balance function again. This function will be enabled only when the input signal is an analog signal.

On Screen Display(OSD) Selection and Adjustment

- ■ ■ The OSD screen will appear when you press the **F-ENGINE** button on the front of the monitor.

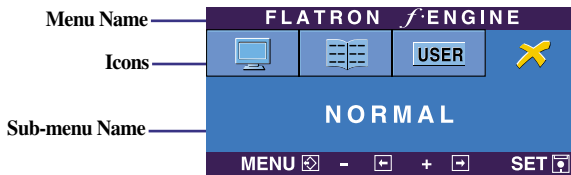

FLATRON F-ENGINE

When you execute F-ENGINE, two tone will appear on the screen as shown in the picture. The applied screen will appear on the left side, whereas the non-applied screen will appear on the right side. Press the SET button to use the adjusted screen.

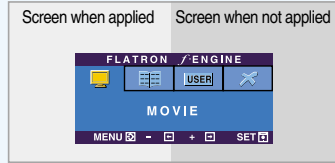

Main menu	Sub menu	Description
	MOVIE TEXT	This feature lets you easily select the best image setting, which is optimized to the environment (ambient illumination, image types, etc.). MOVIE: For animation images in videos or movies. TEXT: For text images (Word processing, etc.)
<ul style="list-style-type: none"> ■ MENU : Exit ■ - , + : Move ■ SET : Select 		

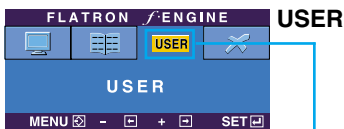

USER User
You can manually adjust the brightness, ACE or RCM. You can save or restore the adjusted value even when in a different environment.

To adjust the **USER** sub-menu function, Press the **SET** Button

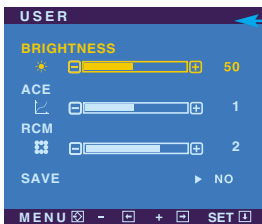

- ... (Brightness): Adjusts screen brightness.
- ... **ACE** (Adaptive Clarity Enhancer): Selects the clarity mode.
- ... **RCM** (Real Color Management): Selects the color mode.

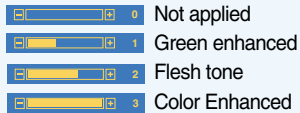

- **MENU** : Exit
- **-** : Decrease
- **+** : Increase
- **SET** : Select another sub-menu

Select the **SAVE** sub-menu using the **SET** button and save the **YES** value using the **buttons**.

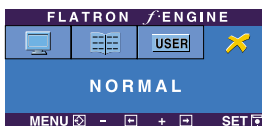

NORMAL This is under normal operating conditions.

Check the following before calling for service.

No image appears	
<ul style="list-style-type: none">● Is the power cord of the display connected?	<ul style="list-style-type: none">• Check and see if the power cord is connected properly to the power outlet.
<ul style="list-style-type: none">● Is the power indicator light on?	<ul style="list-style-type: none">• Press the Power button.
<ul style="list-style-type: none">● Is the power on and the power indicator blue or green?	<ul style="list-style-type: none">• Adjust the brightness and the contrast.
<ul style="list-style-type: none">● Is the power indicator amber?	<ul style="list-style-type: none">• If the display is in power saving mode, try moving the mouse or pressing any key on the keyboard to bring up the screen.• Try to turn on the PC.
<ul style="list-style-type: none">● Do you see an "OUT OF RANGE" message on the screen?	<ul style="list-style-type: none">• This message appears when the signal from the PC (video card) is out of horizontal or vertical frequency range of the display. See the 'Specifications' section of this manual and configure your display again.
<ul style="list-style-type: none">● Do you see a "CHECK SIGNAL CABLE" message on the screen?	<ul style="list-style-type: none">• This message appears when the signal cable between your PC and your display is not connected. Check the signal cable and try again.

Do you see a "OSD LOCKED" message on the screen?	
<ul style="list-style-type: none">● Do you see "OSD LOCKED" when you push MENU button?	<ul style="list-style-type: none">• You can secure the current control settings, so that they cannot be inadvertently changed. You can unlock the OSD controls at any time by pushing the MENU button for 5 seconds. The message "OSD UNLOCKED" should appear.

Display image is incorrect

● **Display Position is incorrect.**

- Press the **SET/AUTO** button to automatically adjust your display image to the ideal setting. If the results are unsatisfactory, adjust the image position using the **H position and V position** icon in the on screen display.
- Check **Control Panel --> Display --> Settings** and see if the frequency or the resolution were changed. If yes, readjust the video card to the recommend resolution.

● **On the screen background, vertical bars or stripes are visible.**

- Press the **SET/AUTO** button to automatically adjust your display image to the ideal setting. If the results are unsatisfactory, decrease the vertical bars or stripes using the **CLOCK** icon in the on screen display.

● **Any horizontal noise appearing in any image or characters are not clearly portrayed.**

- Press the **SET/AUTO** button to automatically adjust your display image to the ideal setting. If the results are unsatisfactory, decrease the horizontal bars using the **PHASE** icon in the on screen display.
- Check **Control Panel --> Display --> Settings** and adjust the display to the recommended resolution or adjust the display image to the ideal setting. Set the color setting higher than 24 bits (true color).

● **The screen color is mono or abnormal.**

- Check if the signal cable is properly connected and use a screwdriver to fasten if necessary.
- Make sure the video card is properly inserted in the slot.
- Set the color setting higher than 24 bits (true color) at **Control Panel - Settings**.

● **The screen blinks.**

- Check if the screen is set to interlace mode and if yes, change it to the recommend resolution.



Have you installed the display driver?

- | | |
|---|--|
| <ul style="list-style-type: none">● Have you installed the display driver?
● Do you see an "Unrecognized monitor, Plug&Play (VESA DDC) monitor found" message? | <ul style="list-style-type: none">• Be sure to install the display driver from the display driver CD (or diskette) that comes with your display. Or, you can also download the driver from our web site: http://www.lge.com.
• Make sure to check if the video card supports Plug&Play function. |
|---|--|

Touch screen does not work.

- | | |
|---|--|
| <ul style="list-style-type: none">● Did you install the touch screen driver? | <ul style="list-style-type: none">• Install the touch screen driver on the installation CD bundled with the product.• Make sure that the USB cable or the RS-232C cable for touch screen is connected to your PC.• Make sure your PC and accessories are USB-enabled or support RS-232C. |
|---|--|

Specifications

Display	17 inches (43.2 cm) Flat Panel Active matrix-TFT LCD Anti-Glare coating Visible diagonal size : 43.2 cm 0.264 mm pixel pitch		
Sync Input	Horizontal Freq.	30 - 83kHz (Automatic)	
	Vertical Freq.	56 - 75Hz (Automatic)	
	Input Form	Separate Sync, Positive / Negative Composite Sync, Positive / Negative SOG (Sync On Green)	
Video Input	Signal Input	15 pin D-Sub Connector	
	Input Form	RGB Analog (0.7Vp-p/75ohm)	
Resolution	Max	VESA 1280 x 1024@75Hz	
	Recommend	VESA 1280 x 1024@60Hz	
Plug&Play	DDC 2B		
Power Consumption	On Mode	: 35W	
	Sleep Mode	≤ 2W	
	Off Mode	≤ 1W	
Dimensions & Weight (with tilt stand)	Full Up Position		Folded Position
			
	Width	39.80 cm / 15.67 inches	39.80 cm / 15.67 inches
	Height	39.00 cm / 15.35 inches	11.76 cm / 4.63 inches
	Depth	22.80 cm / 8.98 inches	32.90 cm / 12.95 inches
	Net	6.7 kg (14.77 lbs)	
Tilt Range	Tilt Range	-20° ~ 140° (Head)	
	Height Range	2.41inch (61.3mm)	
	Rotate	90° clockwise	
Power Input	AC 100-240V ~ 50/60Hz 1.0A		
Environmental Conditions	Operating Conditions		
	Temperature	10°C to 35 °C	
	Humidity	10 % to 80 % non-Condensing	
	Storage Conditions		
Temperature	-20°C to 60 °C		
Humidity	5 % to 90 % non-Condensing		
Tilt Stand	Attached(<input type="checkbox"/>), Detachable (<input type="checkbox"/>)		
Power cord	Wall-outlet type or PC-outlet type		

NOTE

- Information in this document is subject to change without notice.

Preset Modes (Resolution)

Display Modes (Resolution)			Horizontal Freq. (kHz)	Vertical Freq. (Hz)
1	VGA	640 x 350	31.469	70
2	VGA	720 x 400	31.468	70
3	VGA	640 x 480	31.469	60
4	VESA	640 x 480	37.500	75
5	VESA	800 x 600	37.879	60
6	VESA	800 x 600	46.875	75
7	MAC	832 x 624	49.725	75
8	VESA	1024 x 768	48.363	60
9	VESA	1024 x 768	60.023	75
10	MAC	1152 x 870	68.681	75
11	VESA	1152 x 900	61.805	65
*12	VESA	1280 x 1024	63.981	60
13	VESA	1280 x 1024	79.976	75

*Recommend Mode

Indicator

MODE	LED Color
On Mode	green
Sleep Mode	amber
Off Mode	off

Controlling the Multiple Monitors

Use this method to connect several monitors to a single PC.

You can control several monitors at a time by connecting them to a single PC.

Connecting the cable

Connect the RS-232C cable as shown in the picture.

* The RS-232C protocol is used for communication between the PC and monitor.
You can turn the monitor on/off, select an input source or adjust the OSD menu from your PC.

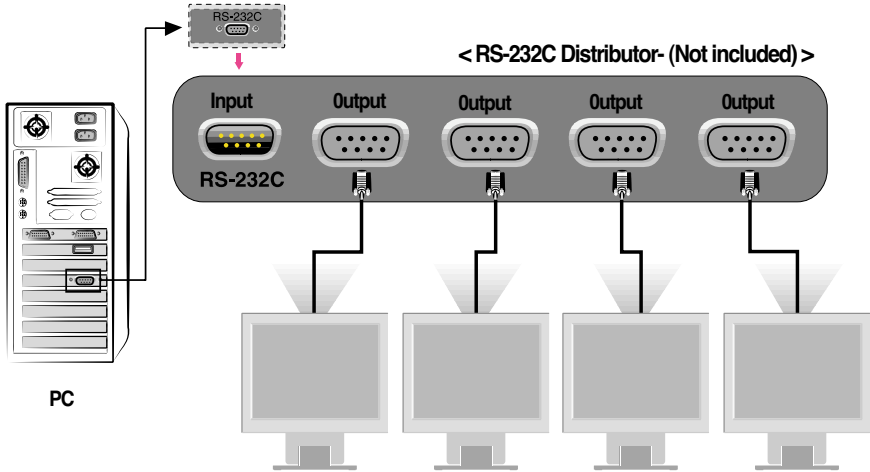

RS-232C Configurations

7-Wire Configurations (Standard RS-232C cable)

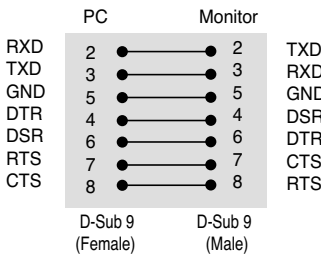

3-Wire Configurations (Not Standard)

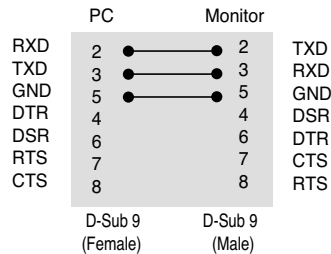

Communication Parameter

- ▶ Baud Rate : 9600bps (UART)
- ▶ Data Length : 8bits
- ▶ Parity Bit : NONE
- ▶ Stop Bit : 1bit
- ▶ Flow Control : NONE
- ▶ Use a straight cable

Command Reference List

	COMMAND1	COMMAND2	DATA(Hexa)
01. Power	k	a	0, 1
02. Contrast	k	g	0 - 64
03. Brightness	k	h	0 - 64
04. Color	k	u	0, 2

Transmission / Receiving Protocol

Transmission

[Command1][Command2][][Set ID][][Data][Cr]

- * [Command 1]: First command.
- * [Command 2]: Second command.
- * [Set ID]: You can adjust the set ID to choose desired monitor ID number in Setup menu. Adjustment range is 0~99. When selecting Set ID '0', every connected monitor set is controlled. Set ID is indicated as decimal (0~99) on menu and as Hexa decimal (0x0~0x63) on transmission/receiving protocol.
- * [DATA]: To transmit command data.
Transmit 'FF' data to read status of command.
- * [Cr]: Carriage Return
ASCII code '0x0D'
- * []: ASCII code Space (0x20)

OK Acknowledgement

[Command2][][Set ID][][OK][Data][x]

- * The Monitor transmits ACK (acknowledgement) based on this format when receiving normal data. At this time, if the data is data read mode, it indicates present status data. If the data is data write mode, it returns the data of the PC computer.

Error Acknowledgement

[Command2][][Set ID][][NG][Data][x]

- * The Monitor transmits ACK (acknowledgement) based on this format when receiving abnormal data from non-viable functions or communication errors.

Data 1: Illegal Code

2: Not supported function

3: Wait more time

Transmission / Receiving Protocol

Power On (Command:a)

- ▶ To control Power On/Off of the monitor.

Transmission

```
[k][a][ ][Set ID][ ][Data][Cr]
```

Data 0 : Power Off 1 : Power On

Acknowledgement

```
[a][ ][Set ID][ ][OK][Data][x]
```

- ▶ To show Power On/Off.

Transmission

```
[k][a][ ][Set ID][ ][FF][Cr]
```

Data 0 : Power Off 1 : Power On

Acknowledgement

```
[a][ ][Set ID][ ][OK][Data][x]
```

Contrast (Command:g)

- ▶ To adjust screen contrast.

You can also adjust contrast in the Contrast/Brightness menu.

Transmission

```
[k][g][ ][Set ID][ ][Data][Cr]
```

Data Min : 0 ~ Max : 64

- Refer to 'Real data mapping' as shown below.

Acknowledgement

```
[g][ ][Set ID][ ][OK][Data][x]
```

* Real data mapping

0 : Step 0

⋮

A : Step 10 (SET ID 10)

⋮

F : Step 15 (SET ID 15)

10 : Step 16 (SET ID 16)

⋮

64 : Step 100

● Transmission / Receiving Protocol

Brightness (Command:h)

▶ To adjust screen brightness.

You can also adjust brightness in the Contrast/Brightness menu.

Transmission

```
[k][h][ ][Set ID][ ][Data][Cr]
```

Data Min : 0 ~ Max : 64

- Refer to 'Real data mapping' as shown below.

Acknowledgement

```
[h][ ][Set ID][ ][OK][Data][x]
```

* Real data mapping

0 : Step 0

⋮

A : Step 10 (SET ID 10)

⋮

F : Step 15 (SET ID 15)

10 : Step 16 (SET ID 16)

⋮

64 : Step 100

Color (Command:U)

▶ To adjust the screen color.

You can also adjust color in the Color adjustment menu.

Transmission

```
[k][u][ ][Set ID][ ][Data][Cr]
```

Data 0 : User

1 : 6500K

2 : 9300K

Acknowledgement

```
[u][ ][Set ID][ ][OK][Data][x]
```

How to Install the VESA Standard wall mounting

VESA wall mounting

Connected to another object
(stand type and wall-mounted type.
This monitor accepts a VESA-compliant
mounting interface pad.- **optional**)
For further information, refer to the
VESA Wall Mounting Instruction Guide.

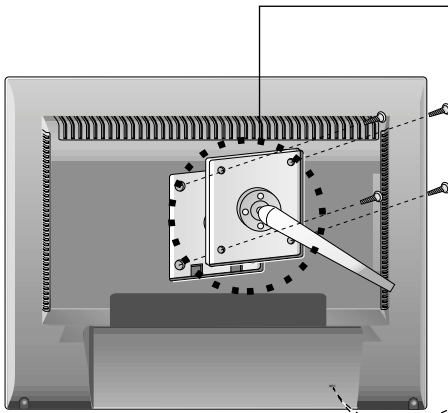

Kensington Security Slot- optional

Connected to a locking
cable that can be purchased
separately at most
computer stores

