



Please read this manual carefully before operating your set.

Retain it for future reference.

Record model number and serial number of the set.

See the label attached on the bottom of the set and quote this information to your dealer when you require service.

Model number :

Serial number :

LG DLP PROJECTOR

AH115 OWNER'S MANUAL

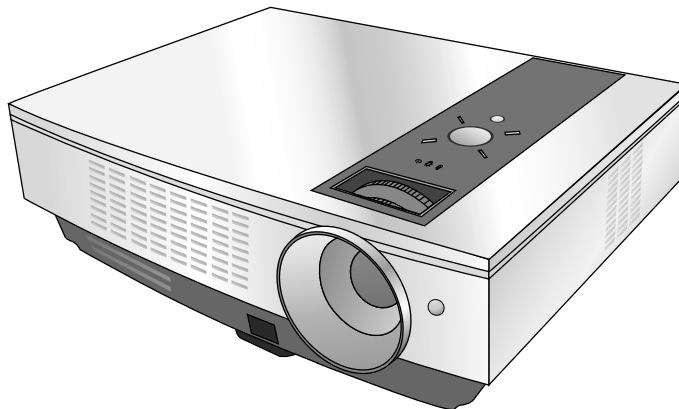

DLP PROJECTOR

Warning

This is a class B product. In a domestic environment this product may cause radio interference, in which case the user may be required to take adequate measures.

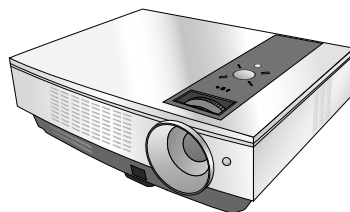

Contents

Safety Instructions	4	Special Menu Options	
Names of parts		Selecting Language	22
Main Body	7	Using ARC Function	22
Connecting Part	7	Overscan Function	23
Control Panel	8	Flip horizontal Function	23
Remote Control	9	Flip vertical Function	23
Installing Batteries	9	Auto sleep Function	23
Projector Status Indicators	10	Using Keystone Function	24
Accessories	11	Using Blank Function	24
Optional Extras	11	Selecting Blank image color	24
Installing and Composition		Lamp mode Function	25
Installation Instructions	12	Checking lamp time	25
Basic Operation of the Projector	13	Using Still Function	25
Using Kensington Security System	14	Screen Menu Options	
Turning on the Projector	15	Auto Configure Function	26
Turning off the Projector	15	Using Phase Function	26
Focus and Position of the Screen Image	16	Using Clock Function	26
Selecting source mode	16	Using Horizontal Function	27
Connection		Using Vertical Function	27
Connecting to a Desktop PC	17	Information	
Connecting to a Notebook PC	17	Supported Monitor Display	28
Connecting to a Video Source	17	Maintenance	28
Connecting to a DVD	18	Replacing the Lamp	29
Connecting to a D-TV Set-Top Box	18	How to fix the lens cap to the projector	31
Function		Specifications	32
Video Menu Options			
Adjusting Video	19		
APC (Auto Picture Control)	19		
Auto Color Temperature Control	20		
Gamma Function	20		
Brilliant Color™ Function	20		
White peaking Function	21		
Black level Function	21		



Disposal of your old appliance

1. When this crossed-out wheeled bin symbol is attached to a product it means the product is covered by the European Directive 2002/96/EC.
2. All electrical and electronic products should be disposed of separately from the municipal waste stream via designated collection facilities appointed by the government or the local authorities.
3. The correct disposal of your old appliance will help prevent potential negative consequences for the environment and human health.
4. For more detailed information about disposal of your old appliance, please contact your city office, waste disposal service or the shop where you purchased the product.

Safety Instructions

Please take note of the safety instructions to prevent any potential accident or misuse of the projector.

→ Safety Instructions are given in two forms as detailed below.

 **WARNING** : The violation of this instruction may cause serious injuries and even death.

 **NOTES** : The violation of this instruction may cause light injuries or damage to the projector.

→ After reading this manual, keep it in the place that the user always can contact easily.

Indoor Installation

WARNING

Do not place the Projector in direct sunlight or near heat sources such as radiators, fires and stove etc.

This may cause a fire hazard !

Do not place inflammable materials beside the projector

This may cause a fire hazard !

Do not allow children to hang on the installed projector.

It may cause the projector to fall, causing injury or death.

Indoor Installation

NOTES

Disconnect from the mains and remove all connections before moving.

Do not place the projector close to sources of steam or oil such as a humidifier.

This may create a fire hazard or an electric shock hazard !

Do not place the projector where it might be exposed to dust.

This may cause a fire hazard or damage to the unit!

When installing the projector on a table, be careful not to place it near the edge.

This may cause the projector to fall causing serious injury to a child or adult and serious damage to the projector.

Only use a suitable stand.

Only use the projector on a level and stable surface.

It may fall and cause injury and/or damage to the unit.

Ensure good ventilation around the projector. The distance between the projector and the wall should be more than 30cm/12 inches.

An excessive increase in its internal temperature may cause a fire hazard or damage to the unit!

Do not block the vents of the projector or restrict air-flow in any way.

This would cause the internal temperature to increase and could cause a fire hazard or damage to the unit!

Do not place the projector directly on a carpet, rug or place where ventilation is restricted.

This would cause its internal temperature to increase and might create a fire hazard or damage the unit.

Outdoor Installation

WARNING

Do not use the projector in a damp place such as a bathroom where it is likely to get wet.

This may cause a fire or an electric shock hazard !

Power

WARNING

Earth wire should be connected.

If the earth wire is not connected, there is a possible danger of electric shock caused by the current leakage.

If grounding methods are not possible, a separate circuit breaker should be installed by a qualified electrician.

Do not connect ground to telephone wires, lightning rods or gas pipe.

The mains plug should be inserted fully into the power outlet to avoid a fire hazard !

This may cause a fire hazard or damage the unit.

Do not place heavy objects on the power cord.

This may cause a fire or an electric shock hazard !

Power

 **WARNING**

Do not use too many plugs on the Mains multi-outlet.
It may result in overheating of the outlet and causes a fire hazard !

Power

 **NOTES**

Never touch the power plug with a wet hand
This may cause an electric shock hazard !

Hold the plug firmly when unplugging. If you pull the cord, it may be damaged.
This may cause a fire hazard !

Prevent dust collecting on the power plug pins or outlet.
This may cause a fire hazard !

Do not plug when the power cord or the plug is damaged or any part of the power outlet is loose.
This may cause a fire or an electric shock hazard or damage to the unit!

Ensure the power cord does not come into contact with sharp or hot objects such as a heater.
This may cause a fire or an electric shock hazard or damage to the unit!

Place the projector where people will not trip or tread on the power lead.
This may cause a fire or an electric shock hazard or damage to the unit!

Do not turn the projector On/Off by plugging-in or unplugging the power plug to the wall outlet. (Do not use the power plug for switch.)
It may cause mechanical failure or could cause an electric shock.

Using

 **WARNING**

Do not place anything containing liquid on top of the projector such as flowerpot, cup, cosmetics or candle.
This may cause a fire hazard or damage to the unit!

In case of impact shock or damage to the projector switch it off and unplug it from the mains outlet and contact your service center.
This may cause a fire or an electric shock hazard or damage to the unit!

Do not allow any objects to fall into the projector.
This may cause an electric shock hazard or damage to the unit!

If water is spilt into the projector unplug it from the mains supply outlet immediately and consult your Service Agent.
This may cause an electric shock hazard or damage to the unit!

Dispose of used batteries carefully and safely.
In the case of a battery being swallowed by a child please consult a doctor immediately.

In the event that an image does not appear on the screen please switch it off and unplug it from the mains supply and contact your Service Agent.
This may cause a fire or an electric shock hazard or damage to the unit!

Do not remove any covers (except lens cover). High risk of Electric Shock!

Don't look directly onto the lens when the projector is in use. Eye damage may occur!

Do not touch metal parts during or soon after operation since the vents and lamp cover will remain very hot!

CAUTION concerning the Power Cord

Most appliances recommend they be placed upon a dedicated circuit; that is, a single outlet circuit which powers only that appliance and has no additional outlets or branch circuits. Check the specification page of this owner's manual to be certain.

Do not overload wall outlets. Overloaded wall outlets, loose or damaged wall outlets, extension cords, frayed power cords, or damaged or cracked wire insulation are dangerous. Any of these conditions could result in electric shock or fire. Periodically examine the cord of your appliance, and if its appearance indicates damage or deterioration, unplug it, discontinue use of the appliance, and have the cord replaced with an exact replacement part by an authorized service personnel.

Protect the power cord from physical or mechanical abuse, such as being twisted, kinked, pinched, closed in a door, or walked upon. Pay particular attention to plugs, wall outlets, and the point where the cord exits the appliance.

Using

 WARNING

Never touch the wall outlet when there is leakage of gas, open the windows and ventilate.

It can cause a fire or a burn by a spark.

Do not drop the projector or allow impact shock.

This may cause mechanical failure or personal injury !

Don't look at laser beam directly as it can cause eye damage!

Always open the lens door or remove the lens cap when the projector lamp is on.

Using

 NOTES

Do not place heavy objects on top of projector.

This may cause mechanical failure or personal injury!

Take care not to impact the lens particularly when moving the projector.

Do not touch the lens of the projector. It is delicate and easily damaged.

Do not use any sharp tools on the projector as this will damage the casing.

Cleaning

 WARNING

Do not use water while cleaning the projector

This may cause damage to the projector or an electric shock hazard.

In the unlikely event of smoke or a strange smell from the projector, switch it off , unplug it from the wall outlet and contact your dealer or service centre.

This may cause a fire or an electric shock hazard or damage to the unit!

Use an air spray or soft cloth that is moist with a neutral detergent and water for removing dust or stains on the projection lens.

Cleaning

 NOTES

Contact the Service Center once a year to clean the internal parts of the projector.

Accumulated dust can cause mechanical failure.

When cleaning the plastic parts such as projector case, unplug the power and wipe it with a soft cloth. Do not use cleanser, spray water or wipe with a wet cloth. Especially, never use cleanser (glass cleaner), automobile or industrial shiner, abrasive or wax, benzene, alcohol etc., which can damage the product. Use an air spray or soft cloth that is moist with a neutral detergent and water for removing dust or stains on the projection lens.

It can cause fire, electric shock or product damage (deformation, corrosion and damage).

Others

 WARNING

Do not attempt to service the projector yourself. Contact your dealer or service centre.

This may cause damage to the projector and could give an electric Shock as well as invalidating the warranty !

Others

 NOTES

Be sure to unplug if the projector is not to be used for a long period.

Accumulated dust may cause a fire hazard or damage to the unit!

Refer lamp servicing to qualified service personnel.

Do not mix new batteries with old batteries.

This may cause the batteries to over-heat and leak.

Only use the specified type of battery.

This could cause damage to the remote control.

Names of parts

Main Body

* The projector is manufactured using high-precision technology. You may, however, see on the Projector screen tiny black points and/or bright points (red, blue, or green). This can be a normal result of the manufacturing process and does not always indicate a malfunction.

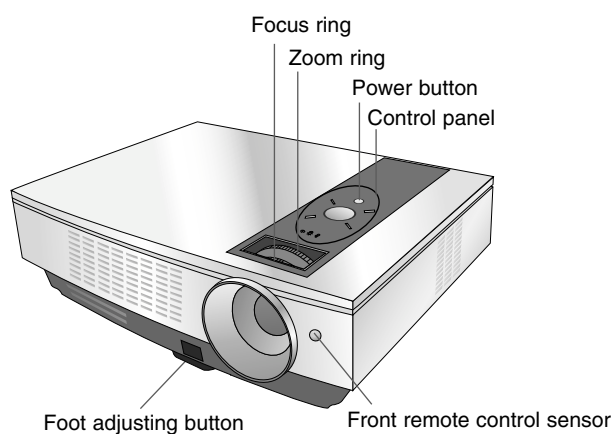

Connecting Part

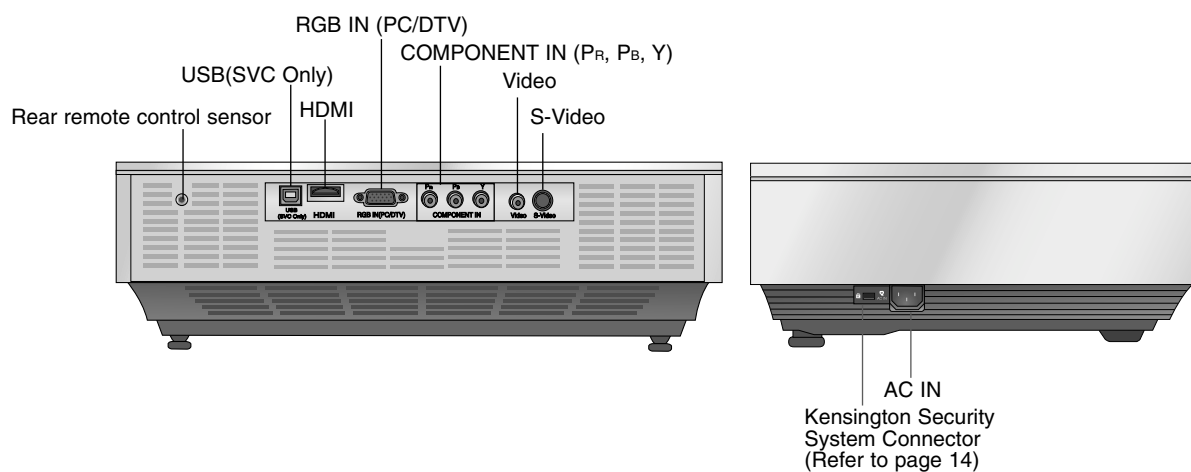

Control Panel

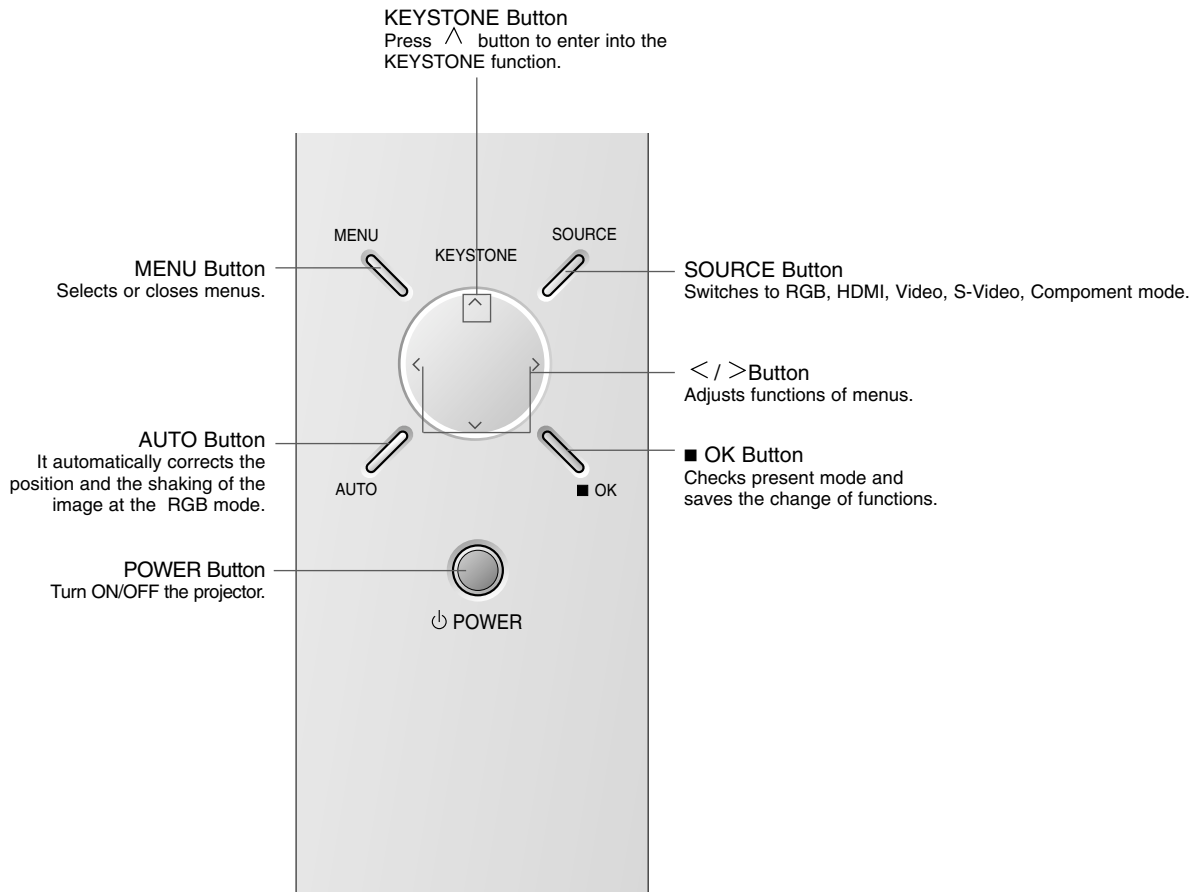

Remote Control

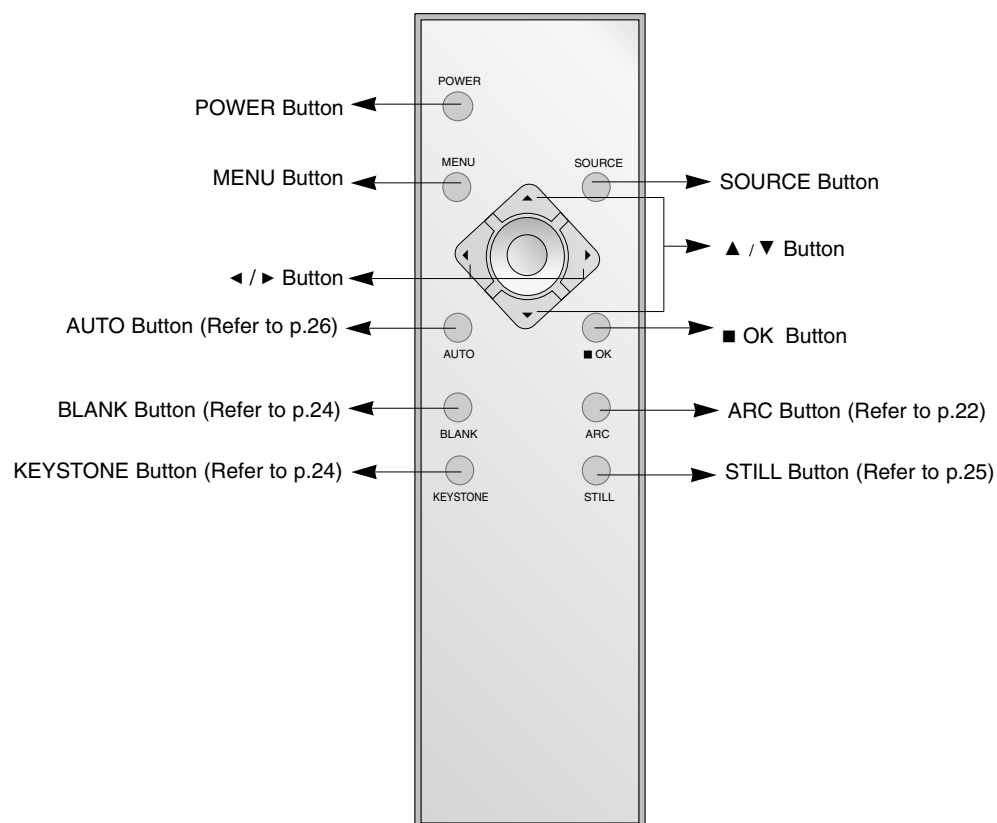

Installing Batteries

CAUTION

RISK OF EXPLOSION IF BATTERY IS REPLACED WITH AN INCORRECT TYPE.
DISPOSE OF USED BATTERIES ACCORDING TO THE INSTRUCTIONS.

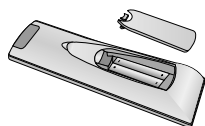

- Open the battery compartment cover on the back of the remote control.
- Insert the specified type of batteries with correct polarity, match “+” with “+”, and match “-” with “-”.
- Don't mix used batteries with new batteries.

Projector Status Indicators

* Lamp indicator, operation indicator and temperature indicator at the top of the projector show the user the operating status of the projector.

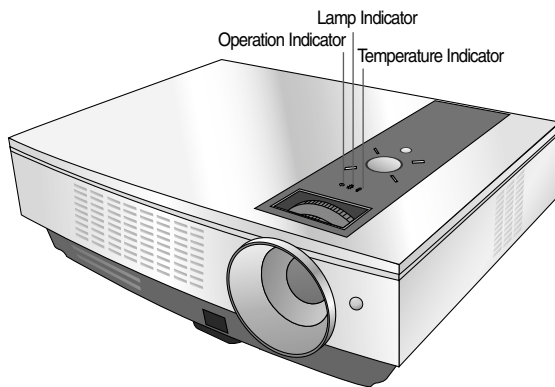

Operation Indicator	Orange	Standby.
	Green(flashing)	Lamp is starting up.
	Green	Unit is in operation (Lamp is turned on)
	Orange(flashing)	Projector lamp is cooling (2 min.)
	Off	Power off.
Lamp Indicator	Red	Projector lamp is reaching the end of its life and needs to be replaced with a new lamp.
	Red(flashing)	The projector is experiencing an error. Retry Power On again later. If lamp indicator is red (flashing) again, contact the service center.
	Green(flashing)	The lamp cover is open.
Temperature Indicator	Orange	A high temperature state has been detected. Turn the Projector off.
	Red	The Projector has turned off due to excessive heat.
	Red (flashing)	Power has turned off due to problem with the internal cooling fan. Contact your service center.

Accessories



Remote Control

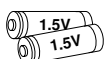

2 Batteries



Owner's manual



Power Cord



Computer Cable



Video Cable



Lens cap and Strap

Optional Extras

- * Contact your dealer to purchase these items.
- * When applying a ceiling installer, use only the ceiling installer for projector.
- * Contact your service personnel for replacing of lamp.

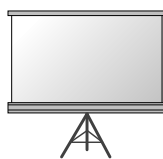

Projection Screen

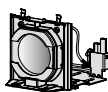

Lamp



SCART to RCA jack (option)

Ceiling installer for projector

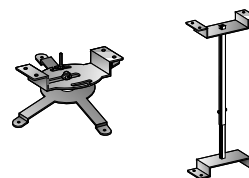

S-Video Cable



HDMI Cable



Component Cable

Installing and Composition

Installation Instructions

* Don't place the projector in the following conditions. It may cause malfunction or product damage.

● Provide proper ventilation for this projector.

● The projector is equipped with ventilation holes(intake) on the bottom and ventilation holes(exhaust) on the front. Do not block or place anything near these holes, or internal heat build-up may occur, causing picture degradation or damage to the projector.

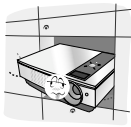

● Do not place the projector on a carpet, rug or other similar surface. It may prevent a adequate ventilation of the projector bottom. This product should be mounted to a wall or ceiling only.

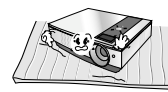

● Never push projector or spill any kind of liquid into the projector.



● Leave an adequate distance(30cm/12 inches or more) around the projector.

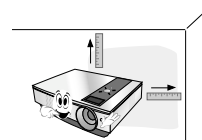

● Place this projector in adequate temperature and humidity conditions.

● Install this projector only in a location where adequate temperature and humidity is available. (refer p.32)

● Don't place the projector where it can be covered with dust.

● This may cause overheating of the projector.

● Do not obstruct the slots and openings of the projector. This may cause overheating and create a fire hazard.

● The projector is manufactured using high-precision technology. You may, however, see tiny black points and/or bright points (red, blue, or green) that continuously appear on the projector Screen. This is a normal result of the manufacturing process and does not indicate a malfunction.

● To display DTV programs, it is necessary to purchase a DTV receiver (Set-top Box) and connect it to the projector.

● If there is no input signal, the Menu will not be displayed on screen.

Basic Operation of the Projector

1. Place the projector on a sturdy and horizontal surface with the PC or AV source.
2. Place the projector with the desired distance from the screen. The distance between the projector and the screen determines the actual size of the image.
3. Position the projector so that the lens is set at a right angle to the screen. If the projector is not set at a right angle, the screen image will be crooked. If this is so then the keystone adjustment may correct this (Refer to page 24.).
4. Connect the cables of the projector to a wall power socket and other connected sources.

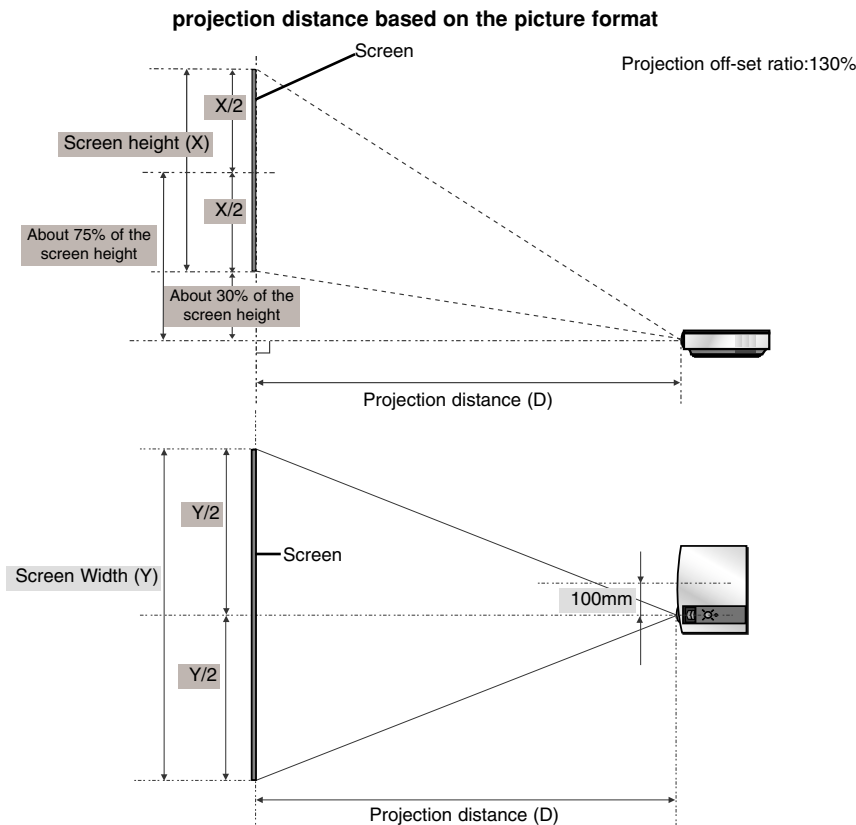

16:9 Scale					
Image				Projection Distance	
Diagonal Size (inch)	Diagonal Size (mm)	Horizontal Size (mm)	Vertical Size (mm)	Wide Distance (mm)	Tele Distance (mm)
40	1016	886	498	1399	1666
50	1270	1107	623	1754	2089
60	1524	1328	747	2109	2511
70	1778	1550	872	2464	2934
80	2032	1771	996	2819	3357
90	2286	1992	1121	3175	3780
100	2540	2214	1245	3530	4203
120	3048	2657	1494	4240	5049
140	3556	3099	1743	4950	5895
160	4064	3542	1992	5661	6741
180	4572	3985	2241	6371	7587
200	5080	4428	2491	7082	8433
220	5588	4870	2740	7792	9279
240	6096	5313	2989	8502	10125
260	6604	5756	3238	9213	10971
280	7112	6199	3487	9923	11817
300	7620	6641	3736	10633	12663

* The longest/shortest distance show status when adjusted by the zoom function.

Using Kensington Security System

- The projector has a 'Kensington' Security System Connector on the back panel. Connect the 'Kensington' Security System cable as below.
- For the detailed installation and use of the Kensington Security System, refer to the user's guide attached to the Kensington Security System set. And for further information, contact <http://www.kensington.com>, the internet homepage of the Kensington company that deals with expensive electronic equipment such as notebook PCs or projectors.
- Kensington Security System is an optional item.

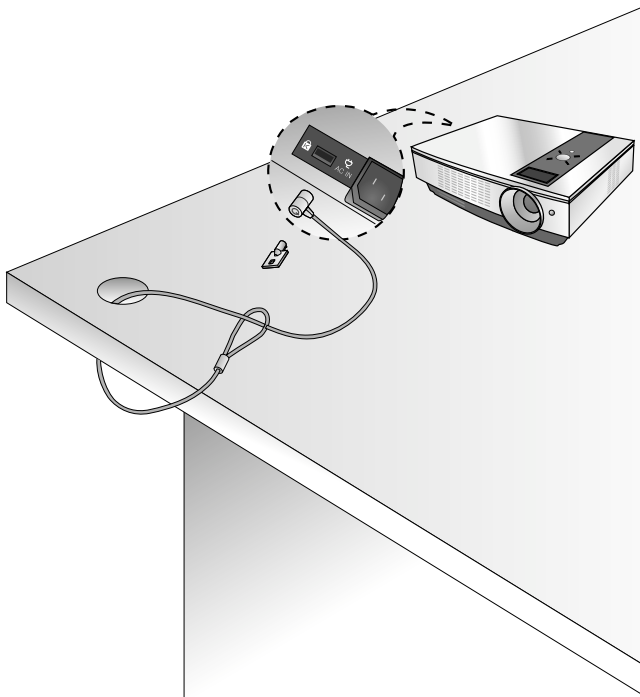

Turning on the Projector

1. Connect power cord correctly.
2. Remove the lens cap. If it is left on, it could become deformed due to the heat produced by the projection lamp.
3. Press the **POWER** button on the remote control or top cover.
(Green operation indicator flashes if lamp is in start-up cycle.)
 - An image will appear after the operation indicator light turns (Green).
 - Select the source mode with the SOURCE button.

Note!

* Do not disconnect the power cord during the suction/discharge fan in operation. If the power cord is disconnected during the suction/ discharge fan in operation, it may takes longer to activate the lamp after turning on the power and the lifespan of the lamp may be shortened.

Turning off the Projector

1. Press the **POWER** button on the top cover or remote control.
2. Press the **POWER** button on the top cover or remote control again to turn off the power.
3. If the operation indicator LED is orange and blinking, do not disconnect the supply until the operation indicator LED is lit constantly (orange).
 - If the operation indicator LED is orange and blinking, the power button on the top cover or on the remote control will not operate.

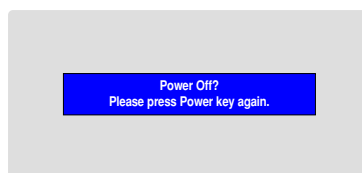

Focus and Position of the Screen Image

When an image appears on the screen, check if it is in focus and fits well to the screen.

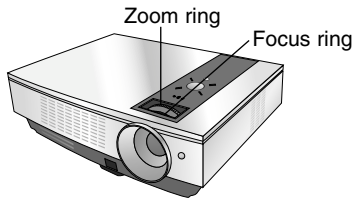

- To adjust the focus of the image, rotate the focus ring which is the outer ring on the lens.
- To adjust the size of the image, rotate the zoom ring which is the inner ring on the lens.

To raise or lower the image on the screen, extend or retract the foot at the bottom of the projector by pushing foot adjusting button as below.

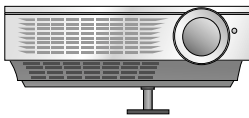

1. While pressing the foot adjusting button, raise or lower the projector to place the screen image in the proper position.
2. Release the button to lock the foot in its new position.
3. Turn the foot at the back left or right to make a fine tune of the length of the projector.
After raising the front foot, do not press down on the projector.

Selecting source mode

1. Press the **SOURCE** button.

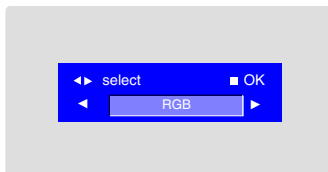

2. Each press of the ◀, ▶ button changes the display as below.

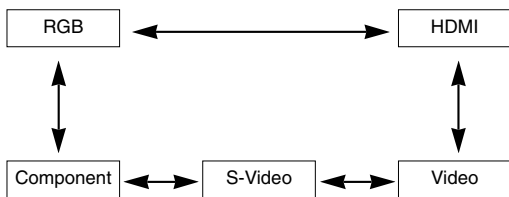

Connection

Connecting to a Desktop PC

- * You can connect the projector to a computer of VGA, SVGA, XGA and SXGA output.
- * Refer to page 28 for the supported monitor displays of the projector.

< How to connect >

Connect computer cable to **RGB IN (PC/DTV)** of the projector.

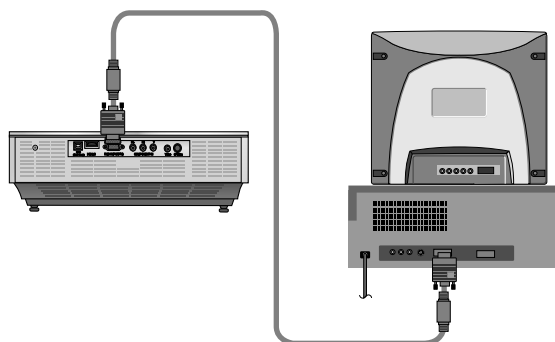

Connecting to a Notebook PC

< How to connect >

Connect computer cable to **RGB IN (PC/DTV)** of the projector.

- * If you set your computer to output the signal to both the display of your computer and the external projector, the picture of the external projector may not appear properly. In such cases, set the output mode of your computer to output the signal only to the external projector. For details, refer to the operating instructions supplied with your computer.

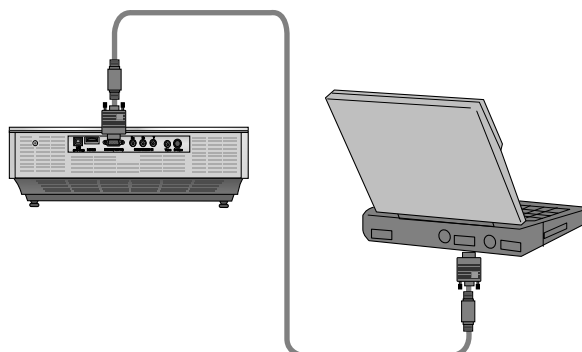

Connecting to a Video Source

- * You can connect a VTR, a camcorder or any other compatible video image source to the projector.

< How to connect 1 >

a. Connect the Video input jacks of the projector to the output jacks of the A/V source with Video cable.

< How to connect 2 >

b. Connect the S-Video input jack of the projector to the S-Video output jack of an A/V source with an S-Video cable.

- * You can get better picture quality when connecting S-Video source to the projector.

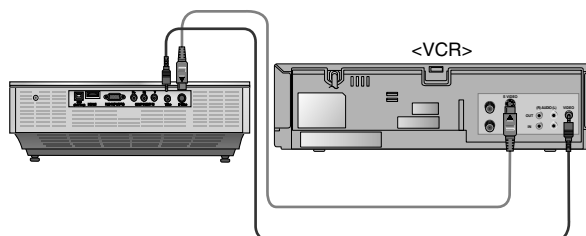

Connecting to a DVD

* The output jacks (Y, Pb, Pr) of the DVD might be labelled as Y, Pb, Pr / Y, B-Y, R-Y / Y, Cb, Cr according to the equipment.

< How to connect >

a. Connect the DVD Component cable to **Component Pr, Pb, Y** of the projector.

* When connecting the component cable, match the jack colors with the component cable. (Y=green, Pb=blue, Pr=red)

b. Only when the DVD device has the HDMI terminal, the HDMI mode can be set.

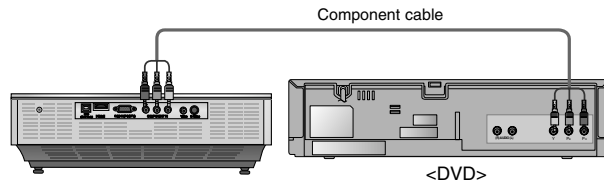

Signal	Component	RGB/DTV	HDMI/DVI
480i	O	X	X
480p	O	O	O
720p	O	O	O
1080i	O	O	O
576i	O	X	X
576p	O	O	O

Connecting to a D-TV Set-Top Box

* To receive D-TV programmes, it is necessary to purchase a D-TV receiver (Set-Top Box) and connect it to the projector.

* Please refer to the owner's manual of the D-TV Set-Top Box for the connection between projector and D-TV Set-Top Box.

< How to connect an RGB source >

a. Connect RGB cable to **RGB IN (PC/DTV)** of the projector.

* When it is connected to the D-TV Set-top box with DVI output, you can watch at the HDMI mode by using the DVI to HDMI cable.

b. Use a DTV receiver with DTV 480p(576p)/720p/1080i mode.

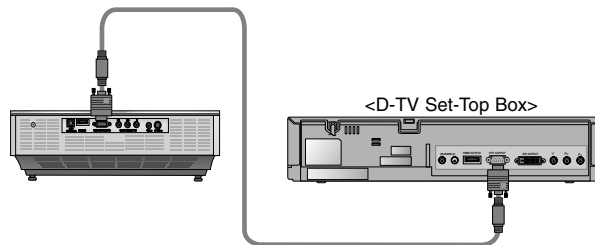

< How to connect a HDMI source >

a. Connect the **HDMI** terminal of the projector to the **HDMI** output terminal of the D-TV Set-Top Box via HDMI cable.

b. Use a DTV receiver with DTV 480p(576p)/720p/1080i mode.

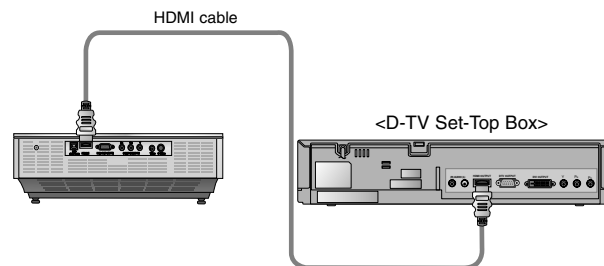

< How to connect a Component source >

a. Connect the D-TV Set-Top Box Component cable to **Component Pr, Pb, Y** of the projector.

* When connecting the component cable, match the jack colors with the component cable. (Y=green, Pb=blue, Pr=red)

b. Use a DTV receiver with DTV 480p(576p)/720p/1080i mode.

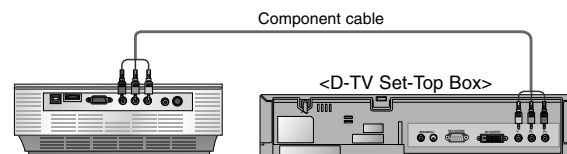

Function

* In this manual, the OSD(On Screen Display) may be different from your Projector's because it is just an example to help with the Projector operation.

* If there is no input signal present, the Menu will not be displayed.

* This operating guide explains operation of RGB(PC) mode mainly.



Video Menu Options

Adjusting Video

1. Press the **MENU** button and then use ◀, ▶ button to select the  menu.

2. Press the ▲, ▼ button to select a video item you want to adjust.

3. Press the ◀, ▶ button to adjust the screen condition as you want.

- Each adjustment of  menu options will not affect other inputs. As required, re-adjust  menu options for the following input source : Video/S-Video/Component (480i(576i)), Component (480p(576p), 720p, 1080i)
- To restore the original image condition after changing it, press **OK** button after selecting **[Reset]** item.
- When receiving an NTSC signal, the picture item **Tint** is displayed and can be adjusted.(60Hz only)
- To exit the menu display, repeatedly, press the **MENU** button.

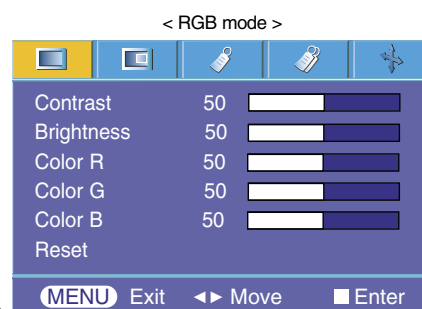

APC (Auto Picture Control)

* Use APC to set the projector for the best picture appearance.

* This function will not work at the RGB mode and the HDMI mode.

1. Press the **MENU** button and then use ◀, ▶ button to select the  menu.

2. Press the ▲, ▼ button to select **APC** item.

3. Press the ◀, ▶ button to adjust the screen condition as you want.

- Each press of the ▲, ▼ button changes the screen as shown below.

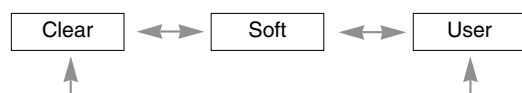

- To exit the menu display, repeatedly, press the **MENU** button.

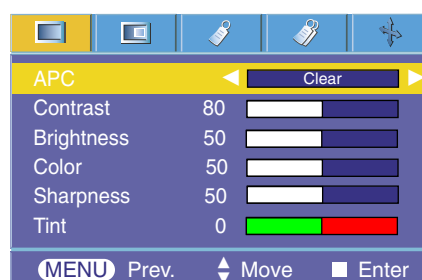

Auto Color Temperature Control

- To initialize values (reset to default settings), select the **Normal** option.

1. Press the **MENU** button and then use ◀, ▶ button to select the  menu.
2. Press the ▲, ▼ button to select **ACC** item.
3. Press the ◀, ▶ button to make desired adjustments.

- Each press of the ◀, ▶ button changes the screen as shown below.

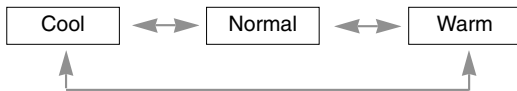

- To exit the menu display, repeatedly, press the **MENU** button.



Gamma Function

1. Press the **MENU** button and then use ◀, ▶ button to select the  menu.
2. Press the ▲, ▼ button to select **Gamma** item.
3. Press the ◀, ▶ button to adjust the screen condition as required.

- Each press of the ▲, ▼ button changes the screen as shown below.



- To exit the menu display, repeatedly, press the **MENU** button.



Brilliant Color™ Function

1. Press the **MENU** button and then use ◀, ▶ button to select the  menu.
2. Press the ▲, ▼ button to select **Brilliant Color™** item.
3. Press the ◀, ▶ button to select On or Off.

* What is the **Brilliant Color™** function?

This function increases the entire brightness of the screen or decreases it a little to make the rich grayscale color.



White peaking Function

1. Press the **MENU** button and then use ◀, ▶ button to select the  menu.
2. Press the ▲, ▼ button to select **White peaking** item.
3. Press the ◀, ▶ button to adjust the screen condition as you want.

- Adjust to higher setting to achieve brighter picture. Adjust to lower setting for darker picture.
- To exit the menu display, repeatedly, press the **MENU** button.
- Only when the **Brilliant Color™** function is enabled, it can use the **White peaking** function.

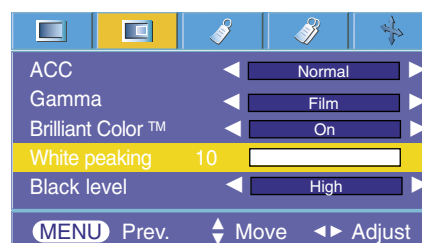

Black level Function

1. Press the **MENU** button and then use ◀, ▶ button to select the  menu.
2. Press the ▲, ▼ button to select **Black level** item.
3. Press the ◀, ▶ button to select Low or High.

- This function works in the following mode : HDMI(YCbCr)

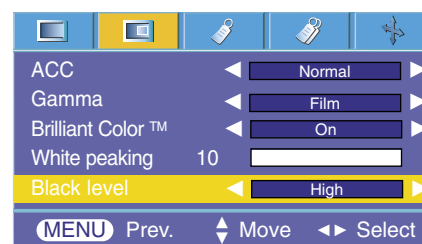

* What is the **Black level** function?

When you watch the movie, this function adjusts the set to the best picture appearance. Adjusting the contrast and the brightness of the screen using the black level of the screen.

Special Menu Options

Selecting Language

1. Press the **MENU** button and then use ◀, ▶ button to select the  menu.
2. Press the ▲, ▼ button to select **Language** item.
3. Press the ◀, ▶ button to select the language you want to use.
 - On-Screen-Display (OSD) is displayed in the selected language.
 - To exit the menu display, repeatedly, press the **MENU** button.

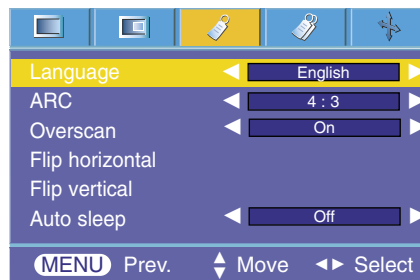

Using ARC Function

1. Press the **ARC** button.
Each press of the button changes the display as below.

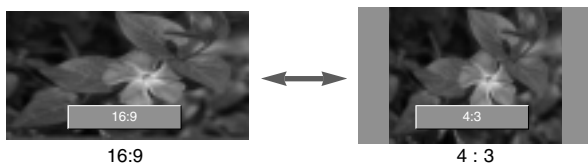

Note!

You can also use this function by using the **MENU** button.

Overscan Function

1. Press the **MENU** button and then use ◀, ▶ button to select the  menu.
2. Press the ▲, ▼ button to select **Overscan** item.
3. Press the ◀, ▶ button to select On or Off.

- The **Overscan** function can be adjusted at RGB-DTV, HDMI-DTV or Component mode only.

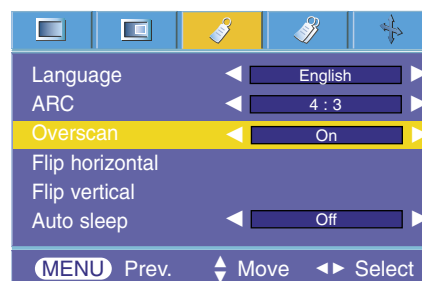

Flip horizontal Function

- * This function reverses the projected image horizontally. Use this function when rear projecting an image.

1. Press the **MENU** button and then use ◀, ▶ button to select the  menu.
2. Press the ▲, ▼ button to select **Flip horizontal** item.
3. Press the **OK** button to see reversed image.

- Each time you press the **OK** button, the image will be reversed.
- To exit the menu display, repeatedly, press the **MENU** button.

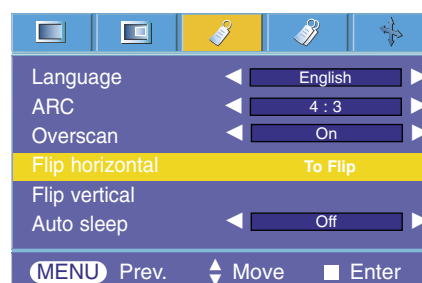

Flip Vertical Function

- * This function reverses the projected image vertically.
- * When you hang the projector upside down from the ceiling, you will need to reverse the image vertically and horizontally.

1. Press the **MENU** button and then use ◀, ▶ button to select the  menu.
2. Press the ▲, ▼ button to select **Flip Vertical** item.
3. Press the **OK** button to see reversed image.

- Each time you press the **OK** button, the image will be reversed.
- To exit the menu display, repeatedly, press the **MENU** button.

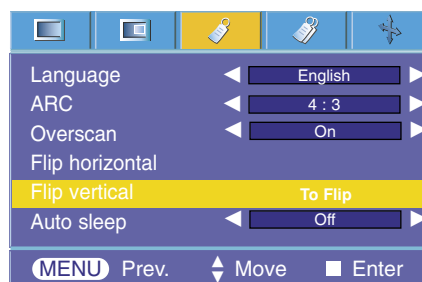

Auto sleep Function

- * The sleep timer turns the projector off at the preset time.

1. Press the **MENU** button and then use ◀, ▶ button to select the  menu.
2. Press the ▲, ▼ button to select **Auto sleep** item.
3. Press the ◀, ▶ button to select the desired preset time.

- To exit the menu display, repeatedly, press the **MENU** button.

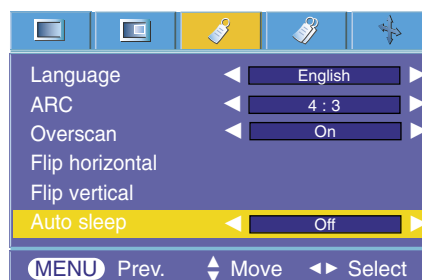

Special Menu Options

Using Keystone Function

* Use this function when the screen is not at a right angle to the projector and the image is a trapezoid shape.

* Only use the **Keystone** function when you can't get the best angle of projection.

1. Press the **KEYSTONE** button.
2. Press the **▲, ▼** button to select **V Keystone** or **H Keystone**.
3. Press the **◀, ▶** button to make desired adjustments.
 - **Keystone** can be adjusted from -20 to +20.
 - You can also access this function via the **MENU** button.

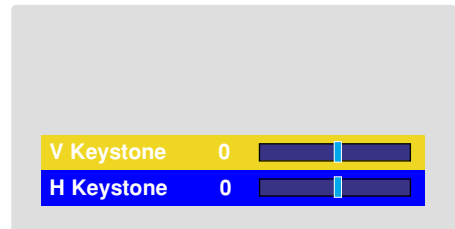

Using Blank Function

* This function may be effective if you need to get the attention of the audience during presentations, meetings or briefings.

1. Press the **BLANK** button.
 - The screen turns off to a background color.
 - You can choose the background color. (Refer to 'Selecting blank image color')
2. Press any button to cancel the blank function.
 - To temporarily turn off the lamp, press BLANK on the remote control. Do not block the projection lens with any objects when the projector is under operation as this could cause the objects to become heated and deformed or even cause a fire.

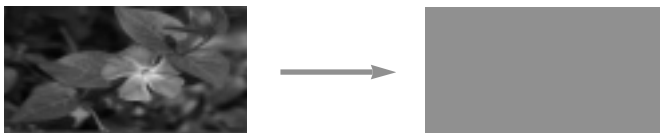

Selecting Blank image color

1. Press the **MENU** button and then use **◀, ▶** button to select the  menu.
2. Press the **▲, ▼** button to select **Blank image** item.
3. Press the **◀, ▶** button to select the color you want to use.
 - Background color will be altered to the selected Blank function color.
 - To exit the menu display, repeatedly, press the **MENU** button.

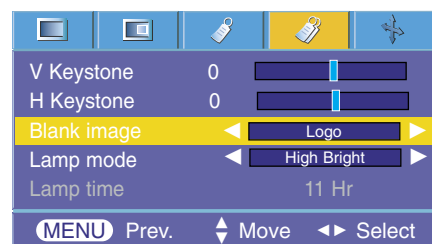

Lamp mode Function

1. Press the **MENU** button and then use ◀, ▶ button to select the  menu.
2. Press the ▲, ▼ button to select **Lamp mode** item.
3. Press the ◀, ▶ button to select **High Bright** or **Economic**.
 - To exit the menu display, repeatedly, press the **MENU** button.

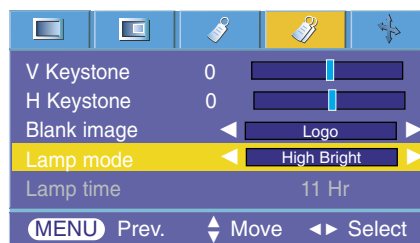

Checking Lamp time

1. Press the **MENU** button and then use ◀, ▶ button to select the  menu.
2. The used lamp time is displayed.
 - When projector lamp is reaching the end of its life, the lamp indicator will turn red.
 - The lamp warning LED illuminates red continuously in the case of excessive lamp time.
 - To exit the menu display, repeatedly, press the **MENU** button.

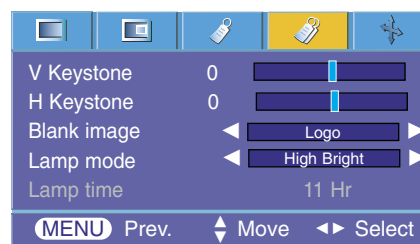

Using Still Function

1. Press the **STILL** button.

* You can freeze the input image.

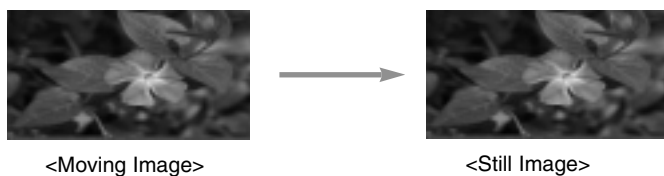

2. To exit STILL, press any button .

* The STILL function will release automatically after approximately 10 minutes.

Screen Menu Options

Auto Configure Function

- * This function assures you of getting the best video quality by automatically adjusting the horizontal size and synchronization of the image.
- * Auto Tracking function works in RGB PC input only.



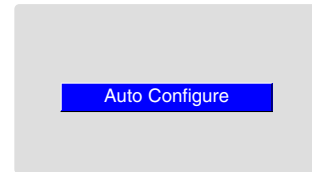



1. Press the **AUTO** button of the remote controller.
 - Image positioning and synchronization are automatically adjusted.
2. If any more manual adjustment is needed according to the various PC mode inputs even after the auto-correction, execute **Phase, Clock, Horizontal** and **Vertical** function in  menu. In certain circumstances, you can't get the best picture quality by only using auto-correction.



Note!

You can also use this function by using the MENU button. (Only in RGB mode)
For best results, perform this function while displaying a still image.





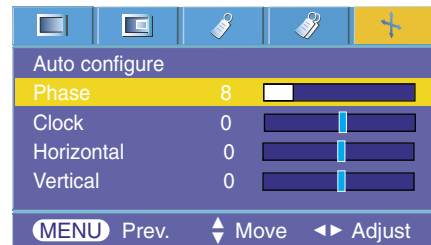

Using Phase Function

1. Press the **MENU** button and then use ,  button to select the  menu.
2. Press the ,  button to select **Phase** item.
3. Press the ,  button to make desired adjustments.

- **Phase** adjustment range is 0 ~31.
- To exit the menu display, repeatedly, press the **MENU** button.
- The variable range can be different depends on input resolutions.



Using Clock Function

1. Press the **MENU** button and then use ,  button to select the  menu.
2. Press the ,  button to select **Clock** item.
3. Press the ,  button to make desired adjustments.

- **Clock** adjustment range is -20 ~+20.
- To exit the menu display, repeatedly, press the **MENU** button.
- The variable range can be different depends on input resolutions.

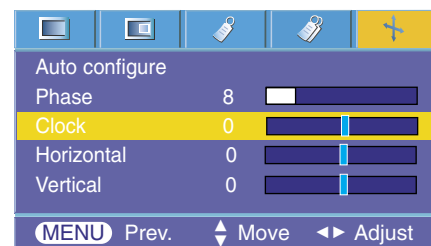

Using Horizontal Function

1. Press the **MENU** button and then use ▲, ▼ button to select the  menu.

2. Press the ▲, ▼ button to select **Horizontal** item.

3. Press the ◀, ▶ button to make desired adjustments.

- **Horizontal** adjustment range is -25 ~+25.
- To exit the menu display, repeatedly, press the **MENU** button.
- The variable range can be different depends on input resolutions.

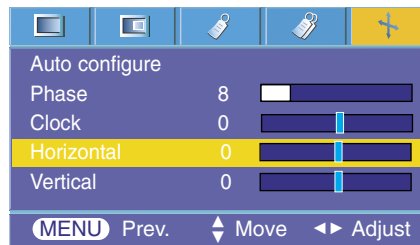

Using Vertical Function

1. Press the **MENU** button and then use ▲, ▼ button to select the  menu.

2. Press the ▲, ▼ button to select **Vertical** item.

3. Press the ◀, ▶ button to make desired adjustments.

- **Vertical** adjustment range is -25 ~+25.
- To exit the menu display, repeatedly, press the **MENU** button.
- The variable range can be different depends on input resolutions.

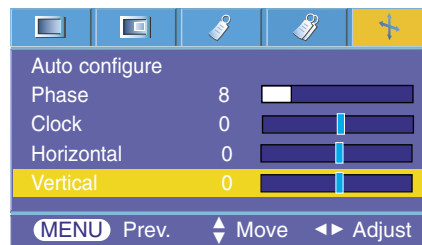

Supported Monitor Display

* The following table lists the display formats supported by the projector.

Sources	Format	Vertical Freq.(Hz)	Horizontal Freq.(kHz)
EGA	640X350	70.09Hz	31.468kHz
	640X350	85.08Hz	37.861kHz
PC98	640X400	85.08Hz	37.861kHz
DOS	720X400	70.08Hz	31.469kHz
	720X400	85.03Hz	37.927kHz
VGA	640X480	59.94Hz	31.469kHz
	640X480	72.80Hz	37.861kHz
	640X480	75.00Hz	37.500kHz
	640X480	85.00Hz	43.269kHz
SVGA	800X600	56.25Hz	35.156kHz
	800X600	60.31Hz	37.879kHz
	800X600	72.18Hz	48.077kHz
	800X600	75.00Hz	46.875kHz
	800X600	85.06Hz	53.674kHz
XGA	1024X768	60.00Hz	48.363kHz
	1024X768	70.06Hz	56.476kHz
	1024X768	75.02Hz	60.023kHz
	1024X768	84.99Hz	68.677kHz
SXGA	1152X864	60.05Hz	54.348kHz
	1152X864	70.01Hz	63.995kHz
	1152X864	75.00Hz	67.500kHz
	1280X768	60.00Hz	47.693kHz
	1280X960	60.00Hz	60.000kHz
	1280X1024	60.02Hz	63.981kHz
	1280X1024	75.025Hz	79.976kHz

* If the projector does not support the input signal, "Out of Range" message appears on the screen.

* The projector supports DDC1/2B type as Plug & Play function. (Auto recognition of PC monitor)

* The Synchronization input form for horizontal and vertical frequencies are Separate.

* According to PC, the optimum vertical frequency may not be displayed up to the optimum frequency of set in 'Registration information (Display registration information)'. (ex, The optimum vertical frequency may be displayed up to 85Hz or under in the resolution of 640X480 or 800X600.)

* In case of the use of HDMI to HDMI cable, PC shall not be supported.

<DVD/DTV Input>

Signal	Component-*1	RGB(DTV)-*2	HDMI(DTV)-*3
NTSC(60Hz)	480i	O	X
	480p	O	O
	720p	O	O
	1080i	O	O
PAL(50Hz)	576i	O	X
	576p	O	O
	720p	O	O
	1080i	O	O

* Cable type

1- Component Cable

2- Computer Cable

3- HDMI Cable

* Recommended 720p for a better image.

Maintenance

* The projector needs little maintenance. You should keep the lens clean because any dirt or stains may appear on the screen. If any parts need to be replaced, contact your dealer. When cleaning any part of the projector, always turn the power off and unplug the projector first.

Cleaning the lens

Clean the lens whenever you notice dirt or dust on the surface of it. Wipe the lens surface gently with an air spray or a soft, dry lint-free cloth.

To remove dirt or stains on the lens, moisten a soft cloth with water and a neutral detergent and wipe the lens surface gently.

Cleaning the Projector Case

To clean the projector case, first unplug the power cable. To remove dirt or dust, wipe the casing with a soft, dry, lint-free cloth. To remove stubborn dirt or stains, moisten a soft cloth with water and a neutral detergent and then wipe the casing. Do not use alcohol, benzene, thinners or other chemical detergents as these can cause the casing to be warped or discolored.

Replacing the Lamp

Lamp Replacement

The change interval of lamp may depend on the use environment of Projector. You can see the used lamp time in the LAMP TIME section of the Menu (pg.25). You must replace the lamp when:

- The projected image gets darker or starts to deteriorate.
- The lamp indicator is red.
- The message “Replace the lamp” appears on the screen when turning the projector on.

<Front panel of the Projector>

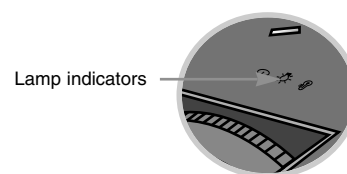

Be careful when replacing lamp

- Press the POWER button on the control panel or remote control to turn off power.
- If the operation indicator LED is orange and blinking, do not disconnect the main supply until the operation indicator LED is lit up constantly (orange).
- Allow the lamp to cool for 1 hour before replacing it.
- Replace only with the same type lamp from an LG Electronics Service Center. Using another manufacturers lamp may cause damage to the Projector and lamp.
- Pull out the lamp only when replacing the lamp.
- Keep the lamp unit out of reach of children. Keep the Lamp away from heat sources such as radiators, stoves etc.
- To reduce the risk of fire do not expose the lamp to liquids or foreign materials.
- Do not place the lamp near any heat source.
- Make sure the new lamp is securely tightened with screws. If not, the image may be dark or there could be an increased risk of fire.
- Never touch the lamp unit glass otherwise image quality may be compromised or lamp life maybe reduced.

To obtain a replacement Lamp unit

Lamp model number is on page 32. Check the lamp model and then purchase it from an LG Electronics Service Center. Using another manufacturers lamp may cause damage to the projector.

Lamp unit disposal

Dispose of the used lamp by returning it to the LG Electronics Service Center.

Replacing the Lamp

- 1 Turn off the projector and unplug the power cable. Carefully place on a cushioned surface.

(Allow the lamp to cool for 1 hour before removing the used lamp from the projector.)

- 2 Unscrew the screw from the lamp cover using a screwdriver.

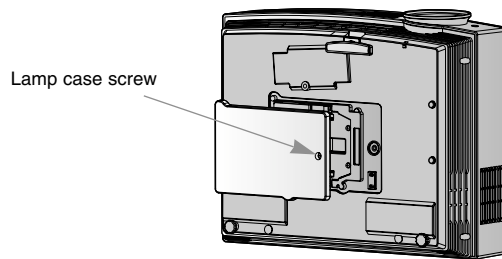

- 3 After lifting the lamp cover off, remove the two retaining screws on the lamp case with a screwdriver.

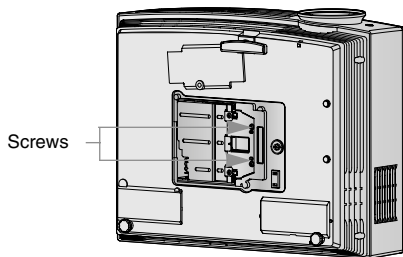

- 4 Lift the lamp up from the projector.

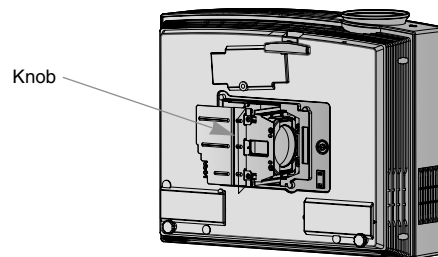

- 5 Pull out the handle slowly and remove the lamp case.

- 6 Insert the new lamp gently into the correct position. Make sure it is inserted correctly.

- 7 Tighten the screws you removed in step 3.

(Make sure they are fixed firmly.)

- 8 Close the lamp cover and install the screws from step 2 to install the cover.

(If the lamp cover is not installed correctly the unit will not power on.)

Note!

Using another manufacturer's lamp may cause damage to the projector or lamp. Make sure the lamp cover is securely fastened. If the lamp cover is not installed correctly the unit will not power on. If this fault persists contact an LG Authorized Service Center.

Regarding the projector lamp control

WARNING

- Don't turn off the projector at least in 5 minutes after activating it.
 - The frequent On/Off changes may cause the lamp function to deteriorate.
- Don't pull out the power cord while activating the projector and the cooling fan.
 - It may cause the lamp life-span to shorten and get damaged.
- The life-span of projector may considerably depend on the use environment and treatment conditions.
- The projector uses the high pressure mercury lamp so that the serious caution is essential. The shock or abuse while using may cause lamp to blow off with explosion.
- When you continue to use the projector after an interval of lamp replacement, the lamp may be blown off with explosion.
- The following treatment should be done, in case of lamp blow-off.
 - Pull off the power cord immediately.
 - Let some fresh air in immediately (Ventilation).
 - Check the product condition at the nearer service center and replace it with new lamp, if necessary.
 - Don't try to disassemble the product without the authorized technician.

How to fix the lens cap to the projector

How to fix the lens cap

- 1** Prepare the lens cap and the strap supplied as accessories.

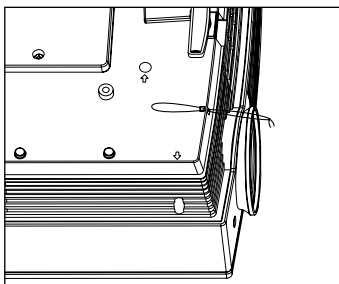

- 2** Insert the non-knot end of the strap into the hole at the bottom of the lens section of the projector.

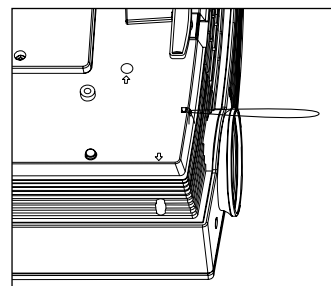

- 3** Fix the strap at the hole of the projector into the hole of the lens cap, and then pass the lens cap through the strap lasso.

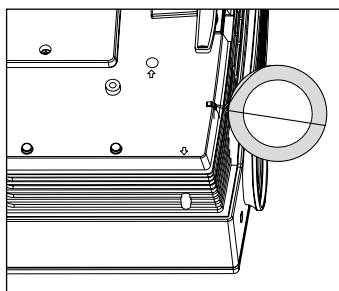

- 4** They are completely assembled as shown at the below figure.

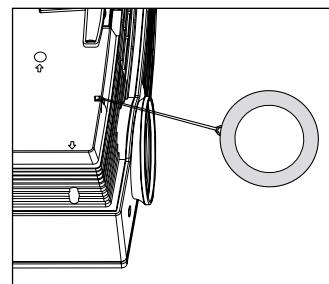

Specifications

MODEL	AH115 (AH115-JD)
Resolution	1280(Horizontal) x 720(Vertical)pixel
Horizontal / Vertical Ratio	16:9(horizontal:vertical)
DLP panel size	0.62 inches
Screen size (Projection distance)	Wide : 1.40 ~ 10.63m(40 ~ 300 inches) Tele : 1.66 ~ 12.66m(40 ~ 300 inches)
Projection OFF SET	130%
Remote control distance	12m
Zoom ratio	1:1.2
Video compatibility	NTSC/PAL/SECAM/NTSC4.43/PAL-M/PAL-N
Power	AC 100 - 240V~50/60Hz, 3A-1A
Height(mm/inches)	114/4.5 (with leg)
Breadth(mm/inches)	346/13.6
Length(mm/inches)	263/10.4

Operating Condition

Temperature

In operation : 32~104°F(0°C~40°C)
In storage and transit : -4~140°F(-20°C~60°C)

Humidity

In operation : 0~ 75% relative humidity by dry hygrometer
Not in operation : 0 ~ 85% relative humidity by dry hygrometer

Projector Lamp

Lamp model

AJ-LAH1

Lamp power consumption

210W

