



# Network Blu-ray Disc Player Owner's Manual

Model: BD300

Before connecting, operating or adjusting this product,  
please read this instruction booklet carefully and completely.



As an ENERGY STAR® Partner, LG has determined that this product or product models meet the ENERGY STAR® guidelines for energy efficiency.

ENERGY STAR® is a U.S. registered mark.



**CAUTION: TO REDUCE THE RISK OF ELECTRIC SHOCK DO NOT REMOVE COVER (OR BACK) NO USER-SERVICEABLE PARTS INSIDE REFER SERVICING TO QUALIFIED SERVICE PERSONNEL.**



This lightning flash with arrowhead symbol within an equilateral triangle is intended to alert the user to the presence of uninsulated dangerous voltage within the product's enclosure that may be of sufficient magnitude to constitute a risk of electric shock to persons.



The exclamation point within an equilateral triangle is intended to alert the user to the presence of important operating and maintenance (servicing) instructions in the literature accompanying the product.

**WARNING: TO PREVENT FIRE OR ELECTRIC SHOCK HAZARD, DO NOT EXPOSE THIS PRODUCT TO RAIN OR MOISTURE.**

**WARNING:** Do not install this equipment in a confined space such as a book case or similar unit.

**CAUTION:**

Do not block any ventilation openings. Install in accordance with the manufacturer's instructions.

Slots and openings in the cabinet are provided for ventilation and to ensure reliable operation of the product and to protect it from over heating.

The openings should never be blocked by placing the product on a bed, sofa, rug or other similar surface. This product should not be placed in a built-in installation such as a bookcase or rack unless proper ventilation is provided or the manufacturer's instruction have been adhered to.

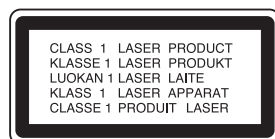

**CAUTION:**

This product employs a Laser System.

To ensure proper use of this product, please read this owner's manual carefully and retain it for future reference. Should the unit require maintenance, contact an authorized service centre.

Use of any controls, adjustments, or procedures other than those specified herein may result in hazardous radiation exposure.

To prevent direct exposure to laser beam, do not try to open the enclosure. Visible laser radiation when open. DO NOT STARE INTO BEAM.

**CAUTION:** The apparatus should not be exposed to water (dripping or splashing) and no objects filled with liquids, such as vases, should be placed on the apparatus.

**CAUTION concerning the Power Cord**

**Most appliances recommend they be placed upon a dedicated circuit;**

That is, a single outlet circuit which powers only that appliance and has no additional outlets or branch circuits. Check the specification page of this owner's manual to be certain.

Do not overload wall outlets. Overloaded wall outlets, loose or damaged wall outlets, extension cords, frayed power cords, or damaged or cracked wire insulation are dangerous. Any of these conditions could result in electric shock or fire. Periodically examine the cord of your appliance, and if its appearance indicates damage or deterioration, unplug it, discontinue use of the appliance, and have the cord replaced with an exact replacement part by an authorized servicer.

Protect the power cord from physical or mechanical abuse, such as being twisted, kinked, pinched, closed in a door, or walked upon. Pay particular attention to plugs, wall outlets, and the point where the cord exits the appliance.

To disconnect power from the mains, pull out the mains cord plug. When installing the product, ensure that the plug is easily accessible.

**Disposal of your old appliance**



1. When this crossed-out wheeled bin symbol is attached to a product it means the product is covered by the European Directive 2002/96/EC.
2. All electrical and electronic products should be disposed of separately from the municipal waste stream via designated collection facilities appointed by the government or the local authorities.
3. The correct disposal of your old appliance will help prevent potential negative consequences for the environment and human health.
4. For more detailed information about disposal of your old appliance, please contact your city office, waste disposal service or the shop where you purchased the product.



**This product is manufactured to comply with EMC Directive 2004/108/EC and Low Voltage Directive 2006/95/EC.**

European representative :  
LG Electronics Service Europe B.V.  
Veluwezoom 15, 1327 AE Almere, The Netherlands  
(Tel : +31-036-547-8940)

# Contents

<b>Introduction</b> .....	<b>5-11</b>
About the $\odot$ Symbol Display .....	5
Symbols Used in this Manual .....	5
Notes on Discs .....	5
Moisture Condensation .....	5
Handling the Unit .....	5
Playable Discs .....	6
Regional Code .....	6
BD-ROM Disc Features .....	7
Compatibility Notes .....	8
Certain System Requirements .....	8
Important Notice for TV colour system .....	8
Using USB Device .....	9
Using the Home Menu .....	9
Front Panel .....	10
Display Window .....	10
Remote Control .....	11
Remote Control Operation .....	11
<b>Installation and Setup</b> .....	<b>12-23</b>
Rear Panel .....	12
HDMI connection .....	13
Connections to Your TV .....	14
Connecting to an Amplifier .....	15
Internet connection .....	16
Resolution Setting .....	17-18
Initial Settings .....	19
- General Operation .....	19
- [DISPLAY] Menu .....	19
- [LANGUAGE] Menu .....	20
- [AUDIO] Menu .....	20
- [LOCK] Menu (Parental Control) .....	21
- [NETWORK] Menu .....	22
- [OTHERS] Menu .....	23
<b>Operations</b> .....	<b>24-32</b>
General playback features .....	24-25
If a disc menu screen is displayed .....	26
Enlarge the playback image .....	26
Time Search .....	26
Skip Search .....	26
Marker Search .....	26
Using Colour (A, B, C, D) Buttons .....	26
Last Scene Memory .....	26
Screen Saver .....	26
Displaying Disc Information On-Screen .....	27
Enjoying BD-LIVE™ or BONUS VIEW™ in BD-Video .....	28
Playing a DivX movie file .....	29
Playing a DVD VR Format Disc .....	30
Playing an Audio CD or MP3/WMA files .....	31
Viewing a Photo file .....	32
<b>Reference</b> .....	<b>33-40</b>
Controlling a TV with the Supplied Universal Remote Control .....	33
To programme the remote to control the TV using the manufacturer code .....	33
Code numbers of controllable TVs .....	34-35
Language Codes .....	36
Area Codes .....	36
Troubleshooting .....	37
Customer Support .....	37
Specifications .....	38
This unit's Audio Output Specifications .....	39
Open source software notice .....	40

## Notes on Copyrights

- Because AACS (Advanced Access Content System) is approved as content protection system for BD format, similar to use of CSS (Content Scramble System) for DVD format, certain restrictions are imposed on playback, analogue signal output, etc., of AACS protected contents. The operation of this product and restrictions on this product may vary depending on your time of purchase as those restrictions may be adopted and/or changed by AACS after the production of this product.  
Furthermore, BD-ROM Mark and BD+ are additionally used as content protection systems for BD format, which imposes certain restrictions including playback restrictions for BD-ROM Mark and/or BD+ protected contents. To obtain additional information on AACS, BD-ROM Mark, BD+, or this product, please contact an authorized Customer Service Centre.
- Many BD-ROM/DVD discs are encoded with copy protection. Because of this, you should only connect your player directly to your TV, not to a VCR. Connecting to a VCR results in a distorted picture from copy-protected discs.
- This product incorporates copyright protection technologies that are protected by certain U.S. patents and other intellectual property rights owned by Macrovision Corporation and other rights owners. Use of this copyright protection technology must be authorized by Macrovision Corporation and is intended for home and other limited viewing uses only, unless otherwise authorized by Macrovision Corporation. Reverse engineering or disassembly is prohibited.
- Under the U.S. Copyright laws and Copyright laws of other countries, unauthorized recording, use, display, distribution, or revision of television programmes, videotapes, BD-ROM discs, DVDs, CDs and other materials may subject you to civil and/or criminal liability.

Manufactured under licence from Dolby Laboratories. Dolby and the double-D symbol are trademarks of Dolby Laboratories.

Manufactured under licence under U.S. Patent #: 5,451,942; 5,956,674; 5,974,380; 5,978,762; 6,487,535 & other U.S. and worldwide patents issued & pending. DTS is a registered trademark and the DTS logos, Symbol, DTS-HD and DTS-HD Advanced Digital Out are trademarks of DTS, Inc. © 1996-2007 DTS, Inc. All Rights Reserved.

HDMI, the HDMI logo and High-Definition Multimedia Interface are trademarks or registered trademarks of HDMI licensing LLC.

“BD-LIVE” logo is trademark of Blu-ray Disc association.

“DVD Logo” is trademark of DVD Format/Logo Licensing Corporation.



### What is SIMPLINK?

Some functions of this unit are controlled by the TV's remote control when this unit and LG TV's with SIMPLINK are connected through HDMI connection.

- Controllable functions by LG TV's remote control; Play, Pause, Scan, Skip, Stop, Power Off, etc.
- Refer to the TV owner's manual for the details of SIMPLINK function.
- LG TV's with SIMPLINK function have the logo as shown above.

### Note:

Depending on the disc type or playing status, some SIMPLINK operation may differ from your purpose or not work.

### To use BD-Live functionality

You must attach an external USB device using the USB port (see page 9).

# Introduction

To ensure proper use of this product, please read this owner's manual carefully and retain for future reference.

This manual provides information on the operation and maintenance of your player. Should the unit require service, contact an authorized service centre.

## About the $\circ$ Symbol Display

" $\circ$ " may appear on your TV display during operation and indicates that the function explained in this owner's manual is not available on that specific media.

## Symbols Used in this Manual

### Note:

Indicates special notes and operating features.

### Tip:

Indicates tips and hints for making the task easier.

A section whose title has one of the following symbols are applicable only to the disc represented by the symbol.

<b>BD</b>	BD-ROM disc
<b>DVD</b>	DVD-Video, DVD $\pm$ R/RW in Video mode or VR mode and finalized
<b>AVCHD</b>	DVD $\pm$ R/RW in AVCHD format
<b>DivX</b>	DivX files
<b>ACD</b>	Audio CDs
<b>MP3</b>	MP3 files
<b>WMA</b>	WMA files
<b>PHOTO</b>	Photo files

## Notes on Discs

### Handling Discs

Do not touch the playback side of the disc. Hold the disc by the edges so that fingerprints do not get on the surface. Never stick paper or tape on the disc.



### Storing Discs

After playing, store the disc in its case. Do not expose the disc to direct sunlight or sources of heat and never leave it in a parked car exposed to direct sunlight.

### Cleaning Discs

Fingerprints and dust on the disc can cause poor picture quality and sound distortion. Before playing, clean the disc with a clean cloth. Wipe the disc from the centre out.

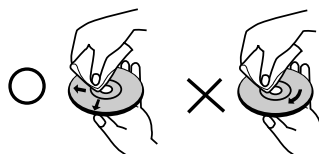

Do not use strong solvents such as alcohol, benzene, thinner, commercially available cleaners, or anti-static spray intended for older vinyl records.

## Moisture Condensation

Never operate this product immediately after moving it from a cold location to a warm location. Leave it for two or three hours without operating it. If you use this product in such a situation, it may damage discs and internal parts.

## Handling the Unit

### When shipping the unit

Please save the original shipping carton and packing materials. If you need to ship the unit, for maximum protection, re-pack the unit as it was originally packed at the factory.

### Keeping the exterior surfaces clean

Use the supplied cloth for cleaning the surfaces of the player.

- Do not use volatile liquids such as insecticide spray near the unit.
- Wiping with strong pressure may damage the surface.
- Do not leave rubber or plastic products in contact with the unit for a long period of time.

### Cleaning the unit

To clean the player, use a soft, dry cloth. If the surfaces are extremely dirty, use a soft cloth lightly moistened with a mild detergent solution.

Do not use strong solvents such as alcohol, benzene, or thinner, as these might damage the surface of the unit.

### Maintaining the Unit

The unit is a high-tech, precision device. If the optical pick-up lens and disc drive parts are dirty or worn, the picture quality could be diminished.

For details, please contact your nearest authorized service centre.

## Playable Discs



### Blu-ray Disc

- Discs such as movies that can be purchased or rented
- BD-R/RE discs that contain audio titles, DivX, MP3, WMA, or Photo files.



### DVD-VIDEO (8 cm / 12 cm disc)

- Discs such as movies that can be purchased or rented



### DVD-R (8 cm / 12 cm disc)

- Video mode and finalized only
- Supports the dual layer disc also
- AVCHD format



### DVD-RW (8 cm / 12 cm disc)

- VR mode, Video mode and finalized only
- AVCHD format



### DVD+R (8 cm / 12 cm disc)

- Finalized disc only
- Supports the dual layer disc also
- AVCHD format



### DVD+RW (8 cm / 12 cm disc)

- Video mode and finalized only
- AVCHD format



### Audio CD (8 cm / 12 cm disc)

- Music CDs or CD-Rs/CD-RWs in music CD format that can be purchased



### CD-R/CD-RW (8 cm / 12 cm disc)

- CD-R/CD-RW discs that contain audio titles, DivX, MP3, WMA, or Photo files.

### AVCHD (Advanced Video Codec High Definition)

- This player can playback AVCHD format discs. These discs are normally recorded and used in camcorders.
- The AVCHD format is a high definition digital video camera format.
- The MPEG-4 AVC/H.264 format is capable of compressing images at higher efficiency than that of the conventional image compressing format.
- Some AVCHD discs use the "x.v.Colour" format.
- This player can playback AVCHD discs using "x.v.Colour" format.
- "x.v.Colour" is a trademark of Sony Corporation.
- "AVCHD" and the AVCHD logo are trademarks of Matsushita Electronic Industrial Co., Ltd. and Sony Corporation.
- Some AVCHD format discs may not play, depending on the recording condition.
- AVCHD format discs need to be finalized.
- "x.v.Colour" offers a wider colour range than normal DVD camcorder discs.

## Regional Code

This unit has a regional code printed on the rear of the unit. This unit can play only BD-ROM or DVD discs labelled same as the rear of the unit or "ALL".

### Notes:

- Depending on the conditions of the recording equipment or the CD-R/RW (or DVD±R/RW) disc itself, some CD-R/RW (or DVD±R/RW) discs cannot be played on the unit.
- Do not attach any seal or label to either side (the labelled side or the recorded side) of a disc.
- Do not use irregularly shaped CDs (e.g., heart-shaped or octagonal). Doing so may result in malfunctions.
- Depending on the recording software & the finalization, some recorded discs (CD-R/RW or DVD±R/RW) may not be playable.
- DVD±R/RW and CD-R/RW discs recorded using a personal computer or a DVD or CD Recorder may not play if the disc is damaged or dirty, or if there is dirt or condensation on the player's lens.
- If you record a disc using a personal computer, even if it is recorded in a compatible format, there are cases in which it may not play because of the settings of the application software used to create the disc. (Check with the software publisher for more detailed information.)
- This player requires discs and recordings to meet certain technical standards in order to achieve optimal playback quality. Pre-recorded DVDs are automatically set to these standards. There are many different types of recordable disc formats (including CD-R containing MP3 or WMA files) and these require certain pre-existing conditions to ensure compatible playback.
- Customers should note that permission is required in order to download MP3 / WMA files and music from the Internet. Our company has no right to grant such permission. Permission should always be sought from the copyright owner.

## BD-ROM Disc Features

BD-ROM Discs can store 25 GB (single layer) or 50 GB (dual layer) on a single sided disc - about 5 to 10 times the capacity of a DVD.

BD-ROM Discs also support the highest quality HD video available in the industry (up to 1920 x 1080) - Large capacity means no compromise on video quality. Furthermore, a BD-ROM disc has the same familiar size and look as DVD.

- The following BD-ROM disc features are disc dependent and will vary.
- Appearance and navigation of features will also vary from disc to disc.
- Not all discs will have the features described below.
- BD-ROM, Hybrid disc have both BD-ROM and DVD (or CD) layers on one side. On such discs, BD-ROM layer will be only played back in this player.

### Video highlights

The BD-ROM format for movie distribution supports three highly advanced video codecs, including MPEG-2, MPEG4 AVC (H.264), and SMPTE VC1. HD video resolutions are also available:

- 1920 x 1080 HD
- 1280 x 720 HD

### For High-Definition Playback

To view high-definition contents from BD-ROM discs, an HDTV is required. Some discs may require HDMI OUT for viewing of high-definition contents. Ability to view high-definition contents in BD-ROM discs may be limited depending on the resolution of your TV.

### Graphic planes

Two individual, full HD resolution (1920x1080) graphic planes (layers) are available, on top of the HD video layer. One plane is assigned to video-related, frame accurate graphics (like subtitles), and the other plane is assigned to interactive graphic elements, such as buttons or menus.

For both planes, various wipes, fades and scroll effects may be available.

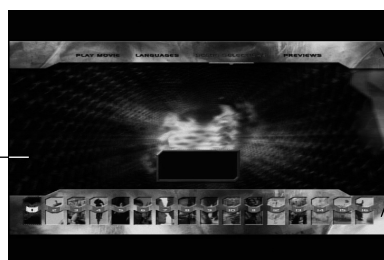

Graphic Plane

HD Video

### Menu sounds

When you highlight or select a menu option, sounds can be heard such as button clicks or a voice-over explaining the highlighted menu choice.

### Multi-page/PopUp Menus

With DVD-Video, playback is interrupted each time a new menu screen is accessed. Due to BD-ROM disc's ability to preload data from the disc without interrupting playback, a menu can consist of several pages.

You can browse through the menu pages or select different menu paths, while the audio and video remain playing in the background.

### Interactivity

Certain BD-ROM Discs may contain animated menus and/or trivia games.

### User Browsable Slideshows

With BD-ROM Discs, you can browse through various still pictures while the audio remains playing.

### Subtitles

Depending on what is contained on the BD-ROM disc, you may be able to select different font styles, sizes and colours for some subtitles. Subtitles may also be animated, scrolled or faded in and out.

### BD-J Interactive Capability

The BD-ROM format supports Java for interactive functions. "BD-J" offers content providers almost unlimited functionality when creating interactive BD-ROM titles.

### BD-ROM Disc Compatibility

This player supports BD-ROM Profile 2.

- Discs supporting BD-Live (BD-ROM version 2 Profile 2) that allows interactive functions to be used when this unit is connected to the Internet in addition to the BONUSVIEW function.
- Discs supporting BONUSVIEW (BD-ROM version 2 Profile 1 version 1.1/Final Standard Profile) that allows Virtual packages or Picture-in-Picture functions to be used.

## Compatibility Notes

- Because BD-ROM are a new format, certain disc, digital connection and other compatibility issues are possible. If you experience compatibility problems, please contact an authorized Customer Service Centre.
- Viewing high-definition content and up-converting standard DVD content may require an HDMI-capable input or HDCP-capable DVI input on your display device.
- Some BD-ROM and DVD discs may restrict the use of some operation commands or features.
- Dolby TrueHD, Dolby Digital Plus and DTS-HD are supported with maximum 7.1 channels if you use HDMI connection for the audio output of the unit.
- You can use the USB device that is used to store some disc related information, including downloaded on-line content. The disc you are using will control how long this information is retained.

## Certain System Requirements

For high definition video playback:

- High definition display that has COMPONENT or HDMI input jacks.
- BD-ROM disc with high definition content.
- HDMI or HDCP capable DVI input on your display device is required for some content (as specified by disc authors).
- For up-conversion of standard definition DVD, an HDMI or HDCP capable DVI input on your display device is required for copy protected content.

For Dolby® Digital Plus, Dolby TrueHD and DTS-HD multi-channel audio playback:

- An amplifier/receiver with a built-in (Dolby Digital, Dolby Digital Plus, Dolby TrueHD, DTS or DTS-HD) decoder.
- Main, centre, surround speakers and subwoofer as necessary for chosen format.

## Important Notice for TV colour system

The colour system of this player differs according to currently playing discs.

For example, when the player plays back the disc recorded in the NTSC colour system, the image is outputted as a NTSC signal.

Only the multi system colour TV can receive all signals outputted from the player.

### Notes:

- If you have a PAL colour system TV, you will see just distorted images when using discs recorded in NTSC.
- The multi system colour TV changes the colour system automatically according to input signals. In case that the colour system is not changed automatically, turn it off and then on to see normal images on screen.
- If you try to record a NTSC output signal from the player with your recorder, the recorder may not record the signal correctly.



## Using USB Devices

This unit can play the movie, music and photo files contained on the USB device.

### Inserting/Removing the USB Device

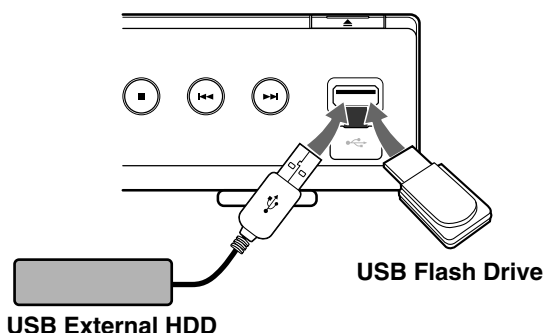

#### Inserting the USB device

Insert straight-in until it fits into place.

#### Removing the USB device

Withdraw the USB device or cable carefully.

#### Notes:

- This unit supports only USB Flash Drive and USB External HDD with FAT16 or FAT32 format.
- The USB device can be used for the local storage for enjoying BD-Live discs with Internet
- This unit can support up to 4 partitions of the USB device.
- Do not extract the USB device during operation (play, etc.).
- A USB device which requires additional programme installation when you have connected it to a computer, is not supported.
- USB device: USB device that support USB1.1 and USB2.0.
- Movie Files (DivX), Music files (MP3/WMA) and photo files (JPEG/PNG) can be played. For details of operations on each file, refer to relevant pages.
- Regular back up is recommended to prevent data loss.
- If you use a USB extension cable or USB HUB, the USB device may not be recognised.
- Some USB device may not work with this unit.
- Digital camera and mobile phone are not supported.
- USB Port on the unit cannot be connected to PC. The unit cannot be used as a storage device.

### Using the USB Device

1. Connect a USB Device.
2. Press HOME on the Remote Control.
3. Select [Movie], [Music] or [Photo] option then press ENTER.
4. Select [USB] then press ENTER. MOVIE, MUSIC or PHOTO menu will appear. Details for the menu are on pages 29-32.

## Using the Home Menu

From the Home Menu screen you can access all the Media for playback and setting of the unit.

1. Press HOME and the Home Menu appears.

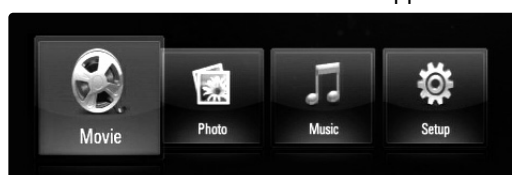

2. Use ◀ / ▶ to select the desired option then press ENTER.

[Movie] – Start video media's playback or displays MOVIE menu. (pages 29-30)

[Photo] – Displays PHOTO menu. (page 32)

[Music] – Displays MUSIC menu. (page 31)

[Setup] – Displays Setup menu. (page 19)

#### Tip:

If you select the [Photo] or [Music] option when the USB Device is connected and a disc is inserted simultaneously, the menu for selecting a media will appear. Select a media then press ENTER.

For example:

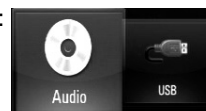

#### Notes:

- The unit will be in stop mode then HOME menu will appear if you press HOME during playback.
- If you insert a DVD or an unplayable disc that is formatted as ISO9660 or UDF, the [Movie], [Photo] or [Music] option can be selected in the HOME menu. But you cannot play it

## Front Panel

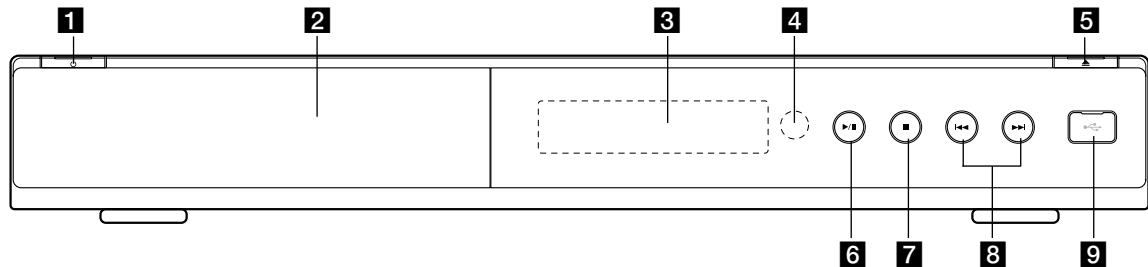

**1** **⏻ (POWER) Button**

Switches the unit ON or OFF.

**2** **Disc Tray**

Insert a disc here.

**3** **Display Window**

Shows the current status of the player.

**4** **Remote Sensor**

Point the Remote Control here.

**5** **⏮ (OPEN/CLOSE)**

Opens or closes the disc tray.

**6** **▶ / ⏸ (PLAY / PAUSE)**

Starts playback.

Pause playback temporarily, press again to exit pause mode.

**7** **■ (STOP)**

Stops playback.

**8** **⏮ / ⏭ (SKIP)**

Go to next or previous track/chapter.

**9** **USB Port**

Connect a USB Device.

## Display Window

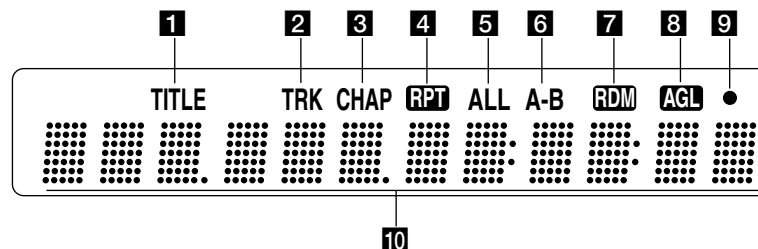

**1** **TITLE Indicator**

Indicates current title number.

**2** **TRK (Track) Indicator**

Indicates current track number.

**3** **CHAP (Chapter) Indicator**

Indicates current chapter number.

**4** **Repeat Mode Indicator**

Indicates when playing in repeat mode.

**5** **ALL Repeat Mode Indicator**

Indicates when playing in all repeat mode.

**6** **A-B Repeat Mode Indicator**

Indicates when playing in A-B repeat mode.

**7** **RDM (Random) Indicator**

Indicates when playing in random order.

**8** **AGL (Angle) Indicator**

Indicates when playing a scene recorded with multi angles.

**9** **Remote Control Indicator**

Indicates when Remote Control signal is received.

**10** **Character Indicators**

Indicates total playing time, elapsed time, title number, chapter number or message, etc.

## Remote Control

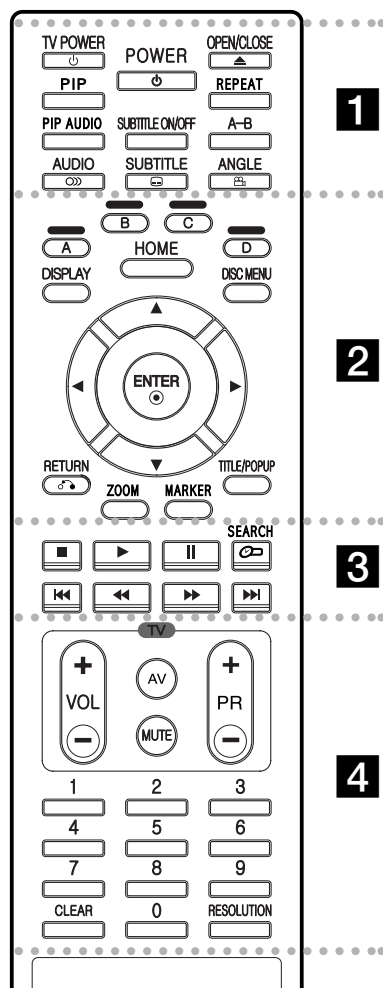

- • • • • **1** • • • • •
- POWER:** Switches the player ON or OFF.
- TV POWER:** Switches the TV ON or OFF.

**OPEN/CLOSE (▲):** Opens and closes the disc tray.

**PIP\*:** Switches on/off Secondary Video (Picture-in-picture) (BD-ROM only).

**REPEAT:** Repeat a desired section.

**PIP AUDIO\*:** Switch on/off Secondary Audio (BD-ROM only).

**SUBTITLE ON/OFF:** Switches the subtitle on or off.

**A-B:** Repeat sequence.

**AUDIO (⊞):** Selects an audio language or audio channel.

**SUBTITLE (☐):** Selects a subtitle language.

**ANGLE (⊞):** Selects a disc camera angle, if available.

**1**

**2**

**3**

**4**

• • • • • **2** • • • • •

**Colour (A, B, C, D) buttons:** Use to navigate BD-ROM menus. They are also used for [PHOTO] and [MUSIC] menu.

**DISPLAY:** Displays or exits On-Screen Display.

**HOME:** Displays or exits Home Menu.

**DISC MENU:** Accesses menu on a disc.

**Direction buttons:** Select an option in the menu.

**ENTER (⊙):** Acknowledges menu selection.

**RETURN (↶):** Exits the menu or resumes playback. The resume play function may work depending on the BD-ROM disc.

**ZOOM:** Displays or exits the [Zoom] menu.

**MARKER:** Marks any point during playback.

**TITLE/POPUP:** Displays the DVD title menu or BD-ROM's popup menu, if available.

• • • • • **3** • • • • •

**(STOP):** Stops playback.

**(PLAY):** Starts playback.

**(PAUSE/STEP):** Pauses playback.

**SEARCH:** Displays or exits the search menu.

**◀◀ / ▶▶ (SCAN):** Search backward or forward.

**◀◀◀ / ▶▶▶ (SKIP):** Go to next or previous chapter.

• • • • • **4** • • • • •

**TV Control Buttons:** See page 33.

**0-9 numerical buttons:** Select numbered options in a menu.

**CLEAR:** Removes a mark on the search menu or a number when setting the password.

**RESOLUTION:** Sets the output resolution for HDMI and COMPONENT VIDEO OUT jacks.

\* Depending on a disc type or the pre-recorded contents of the BD-ROM disc, different functions may be executed or there is no response when pressing some buttons (depending on media used).

## Remote Control Operation

Point the Remote Control at the remote sensor and press the buttons.

### Caution

Do not mix old and new batteries. Never mix different types of batteries (standard, alkaline, etc.).

## Remote Control Battery Installation

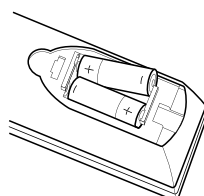

Remove the battery cover on the rear of the Remote Control, and insert two R03 (size AAA) batteries with + and - matched correctly.

# Installation and Setup

## Rear Panel

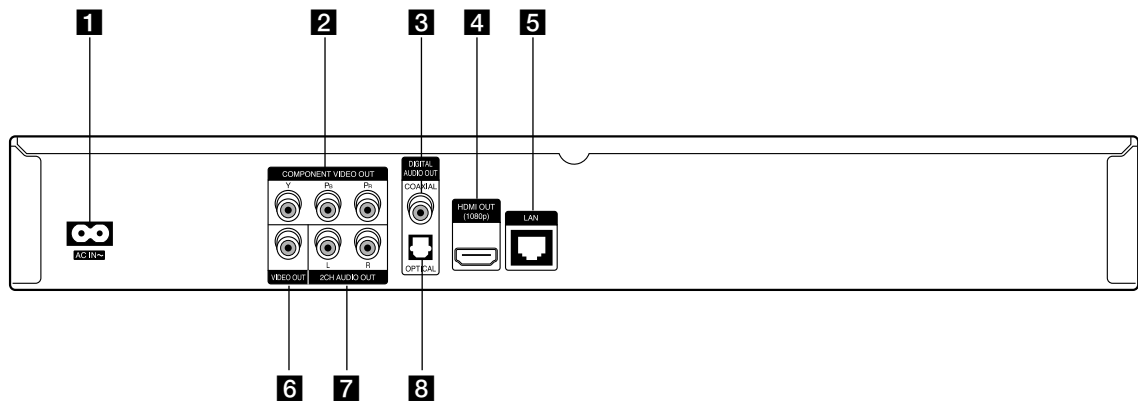

**1 AC IN connector**

Connect the supplied power cord.

**2 COMPONENT VIDEO OUT (Y Pb Pr)**

Connect to a TV with Y Pb Pr inputs.

**3 DIGITAL AUDIO OUT (COAXIAL)**

Connect to digital (coaxial) audio equipment.

**4 HDMI OUT (Type A)**

Connect to TV with HDMI inputs. (Interface for digital audio and video)

**5 LAN port**

Connect a network with an always-on broadband connection.

**6 VIDEO OUT**

Connect to a TV with video inputs.

**7 2CH AUDIO OUT (Left/Right)**

Connect to a TV with 2 channel audio inputs.

**8 DIGITAL AUDIO OUT (OPTICAL)**

Connect to digital (optical) audio equipment.

## HDMI connection

If you have a HDMI TV or monitor, you can connect it to this player using a HDMI cable.

1. Connect the HDMI jack on the player to the HDMI jack on a HDMI compatible TV or monitor (**H**).
2. Set the TV's source to HDMI (refer to TV's Owner's manual).

### Notes:

- You must select a HDMI audio output and a maximum sampling frequency that your TV accepts using [HDMI] and [Sampling Freq.] options on the setup menu (see page 20).
- If a connected HDMI device does not accept the audio output of the unit, the HDMI device's audio sound may be distorted or may not output.

### Tips:

- When you use HDMI connection, you can change the resolution for the HDMI output. (Refer to "Resolution Setting" on page 17.)
- Select the type of video output from the HDMI OUT jack using [HDMI colour Setting] option on the setup menu (see page 19).

### Cautions

- Changing the resolution when the connection has already been established may result in malfunctions. To solve the problem, turn off the player and then turn it on again.
- When the HDMI connection with HDCP is not verified, TV screen is changed to black screen. In this case, check the the HDMI connection, or disconnect the HDMI cable.
- If there is noise or lines on the screen, please check the HDMI cable (length is generally limited to 4.5m).

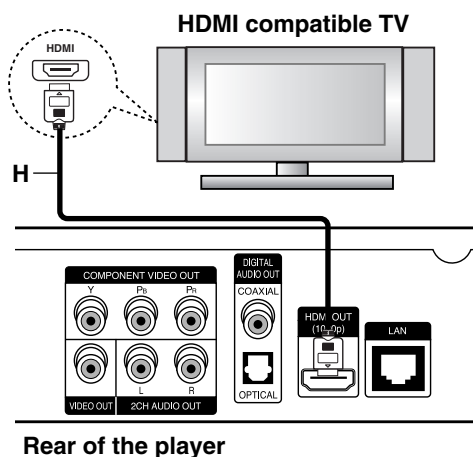

### Additional Information for HDMI

- When you connect a HDMI or DVI compatible device make sure of the following:
  - Try switching off the HDMI/DVI device and this player. Next, switch on the HDMI/DVI device and leave it for around 30 seconds, then switch on this player.
  - The connected device's video input is set correctly for this unit.
  - The connected device is compatible with 720x576p, 1280x720p, 1920x1080i or 1920x1080p video input.
- Not all HDCP-compatible HDMI or DVI devices will work with this player.
  - The picture will not be displayed properly with non-HDCP device.
  - This player does not playback and TV screen is changed to black screen.

## Connections to Your TV

Make one of the following connections, depending on the capabilities of your existing equipment.

### Tips

- Depending on your TV and other equipment you wish to connect, there are various ways you could connect the player. Use only one of the connections described below.
- Please refer to the manuals of your TV, Stereo System or other devices as necessary to make the best connections.

### Caution

- Make sure the player is connected directly to the TV. Tune the TV to the correct video input channel.
- Do not connect the player's AUDIO OUT jack to the phono in jack (record player) of your audio system.
- Do not connect your player via your VCR. The image could be distorted by the copy protection system.

### Component Video Connection

Connect the COMPONENT VIDEO OUT jacks on the player to the corresponding input jacks on the TV using Y Pb Pr cables (**C**).

### Tip:

When you use COMPONENT VIDEO OUT connection, you can change the resolution for the output. (Refer to "Resolution setting" on page 17.)

### Video Connection

Connect the VIDEO OUT jack on the player to the video in jack on the TV using a video cable (**V**).

### Audio (Left/Right) Connection

Connect the left and right AUDIO OUT jacks of the player to the audio left and right IN jacks on the TV using the audio cables (**A**).

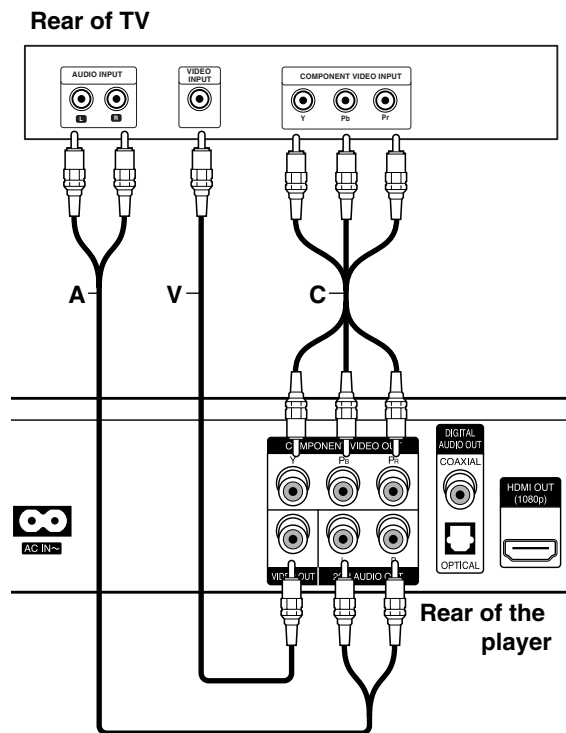

## Connecting to an Amplifier

Make one of the following connections, depending on the capabilities of your existing equipment.

### Note:

Since many factors affect the type of audio output, see "The unit's Audio Output Specifications" on page 39 for details.

### Connecting to an Amplifier via 2 Channel Audio Output

Connect the Left and Right 2CH AUDIO OUT jacks on the player to the audio left and right in jacks on your amplifier, receiver, or stereo system, using audio cables (**A**).

### Connecting to an Amplifier via Digital Audio Output (Optical or Coaxial)

1. Connect the player's DIGITAL AUDIO OUT jack to the corresponding in jack (OPTICAL **O** or COAXIAL **X**) on your amplifier. Use an optional digital (optical **O** or coaxial **X**) audio cable.
2. You will need to activate the player's digital output. (See "[AUDIO] Menu" on pages 20.)

### Connecting to an Amplifier via HDMI Output

1. Connect the player's HDMI OUT jack to the corresponding in jack on your amplifier. Use a HDMI cable (**H1**).
2. You will need to activate the player's digital output. (See "[AUDIO] Menu" on pages 20.)

### Tip:

Connect the amplifier's HDMI output jack to HDMI input jack on your TV using a HDMI cable (**H2**) if your amplifier has a HDMI output jack.

### Digital Multi-channel sound

A digital multi-channel connection provides the best sound quality. For this you need a multi-channel Audio/Video Receiver that supports one or more of the audio formats supported by your player. Check the receiver manual and the logos on the front of the receiver. (PCM Stereo, PCM Multi-Ch, Dolby Digital, Dolby Digital Plus, Dolby TrueHD, DTS and/or DTS-HD)

### Notes:

- You must select a digital audio output and a maximum sampling frequency that your Amplifier (or AV receiver) accepts using [SPDIF], [HDMI] and [Sampling Freq.] options on the setup menu (see page 20).
- With digital audio connection (SPDIF or HDMI), Disc Menu button sounds from the BD-ROM may not be heard if the [SPDIF] or [HDMI] option is set to [Primary Pass-Thru].
- If the audio format of the digital output does not match the capabilities of your receiver, the receiver will produce a strong, distorted sound or no sound at all.
- Multi-channel Digital Surround Sound via digital connection can only be obtained if your receiver is equipped with a Digital Multi-channel decoder.
- To see the audio format of the current disc in the on-screen display, press AUDIO.

### Rear of the player

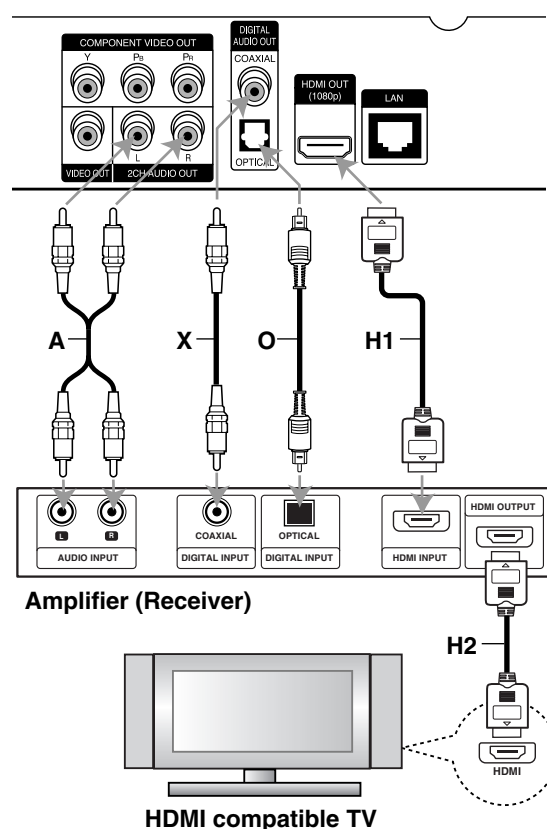

## Internet connection

This player can be connected to a local area network (LAN) via the LAN port on the rear panel. After making the physical connection the player needs to be set up for network communication. This is done from the [Setup] menu — see “[NETWORK] Menu” on page 22 for detailed instructions.

Connect the player’s LAN port to the corresponding port on your Modem or Router using a LAN cable. Use a commercially available straight LAN cable (Category 5/CAT5 or better with RJ45 connector).

By connecting the unit to broadband Internet, you can use a disc that offers BD-Live function (see page 28).

### Caution:

- When plugging or unplugging the LAN cable, hold the plug portion of the cable. When unplugging, do not pull on the LAN cable but unplug while pressing down on the lock.
- Do not connect a modular phone cable to the LAN port.
- Since there are various connection configurations, please follow the specifications of your telecommunication carrier or internet service provider.

### Rear of the player

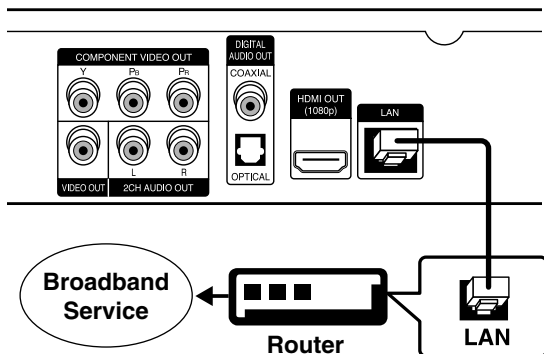

### Notes:

- Depending on the internet service provider (ISP), the number of devices that can receive internet service may be limited by the applicable terms of service. For details, contact your ISP.
- Our company is not responsible for any malfunction of the player and/or the internet connection feature due to communication errors/malfunctions associated with your broadband internet connection, or other connected equipment.

- Our company is not responsible for any trouble in your internet connection.
- The features of BD-ROM discs made available through the Internet Connection feature are not created or provided by our company, and our company is not responsible for their functionality or continued availability. Some disc related material available by the Internet Connection may not be compatible with this player. If you have questions about such content, please contact the producer of the disc.
- Some internet contents may require a higher bandwidth connection.
- Even if the player is properly connected and configured, some internet contents may not operate properly because of internet congestion, the quality or bandwidth of your internet service, or problems at the provider of the content.
- Some internet connection operations may not be possible due to certain restrictions set by the Internet service provider (ISP) supplying your broadband Internet connection.
- Any fees charged by an ISP including, without limitation, connection charges are your responsibility.
- A 10 Base-T or 100 Base-TX LAN port is required for connection to this player. If your internet service does not allow for such a connection, you will not be able to connect the player.
- You must use a Router to use xDSL service.
- A DSL modem is required to use DSL service and a cable modem is required to use cable modem service. Depending on the access method of and subscriber agreement with your ISP, you may not be able to use the internet connection feature contained in this player or you may be limited to the number of devices you can connect at the same time. (If your ISP limits subscription to one device, this player may not be allowed to connect when a PC is already connected.)
- The use of a “Router” may not be allowed or its usage may be limited depending on the policies and restrictions of your ISP. For details, contact your ISP directly.
- Your ISP may protect this player from being connected to network when confirming MAC ADDRESS. In that case, contact your ISP to request to initialize MAC ADDRESS.



## Resolution Setting

The player provides several output resolutions for HDMI OUT and COMPONENT VIDEO OUT jacks. You can change the resolution using [Setup] menu or pressing the RESOLUTION button in stop mode.

### Note:

Since several factors affect the resolution of video output, see "Video output according to the Resolution setting" on next page.

**Auto** – If the HDMI OUT jack is connected for TVs providing display information (EDID), automatically selects the resolution best suited to the connected TV. If the COMPONENT VIDEO OUT is only connected, this changes the resolution to 1080i as default resolution.

**1080p** – Outputs 1080 lines of progressive video. (only for HDMI connection)

**1080i** – Outputs 1080 lines of interlaced video.

**720p** – Outputs 720 lines of progressive video.

**576p** – Outputs 576 lines progressive video.

**576i** – Outputs 576 lines of interlaced video.

### How to change the resolution using RESOLUTION button

Press RESOLUTION button in stop mode.

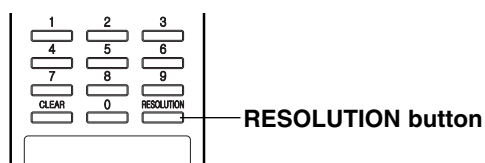

### How to change the resolution using Setup menu

1. Press HOME and the Home Menu appears.
2. Select [Setup] and press ENTER. The Setup menu appears.
3. Use ▲ / ▼ to select [DISPLAY] option then press ► to move to the second level.
4. Use ▲ / ▼ to select the [Resolution] option then press ► to move to the third level.



5. Use ▲ / ▼ to select the desired resolution then press ENTER to confirm your selection.

### Available resolution according to connection and media format

#### HDMI OUT connection

- For the 576i resolution setting, real output resolution of HDMI OUT will change to 576p.
- If you select a resolution manually and then connect the HDMI jack to TV and your TV does not accept it, the resolution setting is set to [Auto].
- If you select a resolution that your TV does not accept, the warning message will appear. After resolution change, if you cannot see the screen, please wait 20 seconds and the resolution will automatically revert back to the previous resolution.
- The 1080p video output frame rate may be automatically set to either 24Hz or 50Hz depending both on the capability and preference of the connected TV and based on the native video frame rate of the content on the BD-ROM disc.

#### COMPONENT VIDEO OUT connection

- For the 1080p resolution setting with unprotected media, real output resolution of COMPONENT VIDEO OUT will change to 1080i.
- For the 720p, 1080i, 1080p resolution setting with protected media, real output resolution of COMPONENT VIDEO OUT will change to 576i or 576p depending on the connectivity of HDMI cable.
- BD or DVD could prevent up-scaling on analogue output.

#### VIDEO OUT connection

- The resolution of the VIDEO OUT jack is fixed to 576i.

### Notes:

- Depending on your display, some of the resolution settings may result in the picture disappearing or an abnormal picture appearing. In this case, press HOME key then RESOLUTION repeatedly until the picture re-appear.
- This player supports simultaneous output of all video out jacks. The resolution of the HDMI output will not be the same as the resolution output on the component video output.

## Video output according to the Resolution setting

### • When the copy unprotected media is playing back

Video Output Resolution Setting	HDMI OUT	COMPONENT VIDEO OUT		VIDEO OUT
		HDMI connected	HDMI disconnected	
576i	576p	576i		576i
576p	576p	576i	576p	576i
720p	720p	720p		576i
1080i	1080i	1080i		576i
1080p / 24Hz Mode	1080p / 24Hz Mode	576i	1080i	576i
1080p / 50Hz Mode	1080p / 50Hz Mode	576i	1080i	576i

### • When the copy protected media is playing back

Video Output Resolution Setting	HDMI OUT	COMPONENT VIDEO OUT		VIDEO OUT
		HDMI connected	HDMI disconnected	
576i	576p	576i		576i
576p	576p	576i	576p	576i
720p	720p	576i	576p	576i
1080i	1080i	576i	576p	576i
1080p / 24Hz Mode	1080p / 24Hz Mode	576i	576p	576i
1080p / 50Hz Mode	1080p / 50Hz Mode	576i	576p	576i

## Initial Settings

By using the Setup menu, you can make various adjustments to items such as picture and sound. You can also set a language for the subtitles and the Setup menu, amongst other things. For details on each Setup menu item, see pages 19 to 23.

### To display and exit the Menu:

Press HOME and the Home Menu appears. Select [Setup] then press ENTER, and Setup menu appears.

Press RETURN or HOME to exit the Setup menu.

### To go to the next level:

Press ► on the Remote Control.

### To go back to the previous level:

Press ◀ on the Remote Control.

## General Operation

1. Press HOME and the Home Menu appears.
2. Select [Setup] and press ENTER. The Setup menu appears.



3. Use ▲ / ▼ to select the desired option then press ► to move to the second level. The screen shows the current setting for the selected item, as well as alternate setting(s).
4. Use ▲ / ▼ to select the second desired option then press ► to move to the third level.
5. Use ▲ / ▼ to select the desired setting then press ENTER to confirm your selection. Some items require additional steps.
6. Press RETURN or HOME to exit the Setup menu.

## [DISPLAY] Menu



## TV Aspect Ratio

**[4:3 Letter Box]** – Select when a standard 4:3 TV is connected. Displays theatrical images with masking bars above and below the picture.

**[4:3 Pan Scan]** – Select when a standard 4:3 TV is connected. Displays pictures cropped to fill your TV screen. Both sides of the picture are cut off.

**[16:9 Wide]** – Select when a 16:9 wide TV is connected.

### Note:

You cannot select [4:3 Letter Box] and [4:3 Pan Scan] option when the resolution is set to higher than 720p.

## Resolution

Sets the output resolution of the Component and HDMI video signal. Refer to “Resolution Setting” on page 17 for details about the resolution.

## 1080p Display Mode

When the resolution is set to 1080p, select [24Hz] for smooth presentation of film material (1080/24p) with an HDMI-equipped display compatible with 1080/24p input.

### Notes:

- When you select [24Hz], you may experience some picture disturbance when the video switches video and film material. In this case, select [50Hz].
- Even when [1080p Display Mode] is set to [24Hz], if your TV is not compatible with 1080/24p, the actual frame frequency of the video output will be 50Hz or 60Hz to match the video source format.

## HDMI Color Setting

Select the type of output from the HDMI OUT jack. For this setting, please refer to the manuals of your display device.

**[YCbCr]** – Select when connecting to a HDMI display device.

**[RGB]** – Select when connecting to an RGB display device.

## [LANGUAGE] Menu



### Display Menu

Select a language for the Setup menu and on-screen display.

### Disc Menu / Disc Audio / Disc Subtitle

Select the language you prefer for the audio track (disc audio), subtitles, and the disc menu.

**[Original]** – Refers to the original language in which the disc was recorded.

**[Other]** – Press ENTER to select another language. Use number buttons then ENTER to enter the corresponding 4-digit number according to the language code list on page 36.

**[Off] (for Disc Subtitle)** – Turn off Subtitle.

### Note:

Depending on the disc, your language setting may not work for some discs.

## [AUDIO] Menu

Each disc has a variety of audio output options. Set the player's Audio options according to the type of audio system you use.

### Note:

Since many factors affect the type of audio output, see "The unit's Audio Output Specifications" on page 39 for details.



### HDMI / SPDIF (Digital Audio Output)

Select the output sound format when a device equipped with a HDMI or Digital Audio input jack is connected to the HDMI OUT or DIGITAL AUDIO OUT jack on this player.

**[PCM Stereo]** – Select if you connect this unit's HDMI OUT or DIGITAL AUDIO OUT jack to a device with two-channel digital stereo decoder.

**[PCM Multi-Ch] (HDMI only)** – Select if you connect this unit's HDMI OUT jack to a device with multi-channel digital decoder.

**[DTS Re-Encode]** – Select if you connect this unit's HDMI OUT or DIGITAL AUDIO OUT jack to a device with DTS decoder.

**[Primary Pass-Thru]** – Select if you connect this unit's DIGITAL AUDIO OUT and HDMI OUT jack to a device with LPCM, Dolby Digital, Dolby Digital Plus, Dolby TrueHD, DTS and DTS-HD.

### Notes:

- When [HDMI] option is set to [PCM Multi-CH], the audio may output as PCM Stereo if the PCM Multi-Ch information is not detected from HDMI device with EDID.
- When [HDMI] and [SPDIF] options are set to [DTS Re-Encode], the DTS audio will output on BD-ROM disc, and the original audio will output on the other discs (like [Primary Pass-Thru]).

### Sampling Freq. (Maximum Sampling Frequency)

**[192KHz]** – Select this if your A/V Receiver or Amplifier is capable of handling 192 KHz signals.

**[96KHz]** – Select this if your A/V Receiver or Amplifier is NOT capable of handling 192 KHz signals. When this choice is made, this unit automatically converts any 192 KHz signals to 96 KHz so your system can decode them.

**[48KHz]** – Select this if your A/V Receiver or Amplifier is NOT capable of handling 192 KHz and 96 KHz signal. When this choice is made, this unit automatically converts any 192 KHz and 96 KHz signals to 48 KHz so your system can decode them.

Check the documentation for your A/V Receiver or Amplifier to verify its capabilities.

### DRC (Dynamic Range Control)

When a disc encoded in Dolby Digital or Dolby Digital Plus is playing back, you may wish to compress the dynamic range of the audio output (the difference between the loudest sounds and the quietest ones). This allows you to listen to a movie at a lower volume without losing clarity of sound. Set DRC to [On] for this effect.

### Note:

The DRC setting can be changed only when a disc is not inserted or the unit is in complete stop mode.

## [LOCK] Menu (Parental Control)

The [LOCK] settings affect only BD and DVD playback.



### Password

You can enter or change the password.

1. Select [Password] option on the [LOCK] menu then press ►.
2. To create new password, press ENTER when the [New] option is highlighted. Input new password and press ENTER. Enter it again and press ENTER to verify.

To change the password, press ENTER when the [Change] option is highlighted, then input old password and press ENTER. Input new password and press ENTER. Enter it again and press ENTER to verify.

To delete the password, select [Delete] option then press ENTER, then input old password and press ENTER. The password is deleted.

#### Tip:

If you make a mistake before pressing ENTER, press CLEAR. Then input the correct password.

#### If you forget your password

If you forget your password, you can clear it using the following steps:

1. Remove any disc that might be in the player.
2. Select [Password] option.
3. Use Number buttons to enter the 6-digit number "210499".  
The "PIN CLEAR" appears in the display window and the password is deleted.

### Rating

Blocks playback of rated disc based on their content. (Not all discs are rated.)

1. Select [Rating] on the [LOCK] menu then press ►.
2. To access this option, you must input the password you have created. If you have not yet entered password, you will be prompted to do so. Input a password and press ENTER. Enter it again and press ENTER to verify. If you make a mistake before pressing ENTER, press CLEAR.
3. Select a rating from 1 to 8 using the ▲ / ▼ buttons.

**[Rating 1-8]** – Rating one (1) has the most restrictions and rating eight (8) is the least restrictive.

**[Unlock]** – If you select unlock, parental control is not active and the disc plays in full.

4. Press ENTER to confirm your rating selection.

### BD Age

Set an age limit for BD-ROM playback.

1. Select [BD Age] on the [LOCK] menu then press ►.
2. Follow step 2 as shown above (Rating).
3. Use number buttons to input an age limit for BD-ROM viewing.

**[255]** – All BD-ROM can be played.

**[0-254]** – Prohibits play of BD-ROM with corresponding ratings recorded on them.

4. Press ENTER to confirm your selection.

### Area Code

Enter the code of the area whose standards were used to rate the DVD video disc, based on the list on page 36.

1. Select [Area Code] on the [LOCK] menu then press ►.
2. Follow step 2 as shown above (Rating).
3. Select the first character using ▲ / ▼ buttons then press ENTER.
4. Select the second character using ▲ / ▼ buttons then press ENTER to confirm your selection.

## [NETWORK] Menu

The [NETWORK] settings are needed to use the BD Live feature.

Some BD-ROM discs may enable you to access special BD-ROM sites, if you connect the player to the Internet. For example, if a BD-ROM site includes content such as links to future movie trailers, you can watch the downloaded on-line content on the player.

You do not need to connect to a PC to use this function.

### **Preparations:**

- This feature requires an always-on broadband internet connection. (see page 16.)
- A BD-ROM disc compatible with this feature is required. Not all BD-ROM discs are compatible.

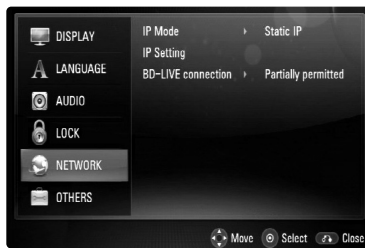

### **IP Mode**

If there is a DHCP server on the local area network (LAN), this player will automatically be allocated an IP address. If you're using a broadband router or broadband modem that has a DHCP (Dynamic Host Configuration Protocol) server function, select [Dynamic IP]. The IP address will automatically be determined.

If there is no DHCP server on the network and you want to set the IP address manually, select [Static IP] then set the [IP Address], [Subnet Mask], [Gateway] and [DNS Server] using [IP Setting] option.

### **Note:**

The [IP Mode] menu shows if the internet is connected or not. "Ø" will appear when connection has failed.

### **IP Setting**

This option is available only if [IP Mode] option is set to [Static IP].

Use the ▲ / ▼ / ◀ / ▶ buttons to select a field; use the number buttons to enter a value. Press ENTER when [OK] is highlighted to finish and exit the screen.

### **BD-LIVE connection**

You can restrict Internet access when BD-Live functions are used.

**[Permitted]** – Internet access is permitted for all BD-Live contents.

**[Partially permitted]** – Internet access is permitted only for BD-Live contents which have content owner certificates. Internet access and AACIS Online functions are prohibited for all BD-Live contents without a certificate.

**[Prohibited]** – Internet access is prohibited for all BD-Live contents.

## [OTHERS] Menu



### Skin

Changes the background of the initial screen.

### Java Font Size **BD**

You can adjust the default text size displayed for the BD-J contents during BD-ROM playback.

This setting is only valid when BD-J contents do not set the size of text.

Please select a font size bigger than 24 when the player is connected with a HD TV.

### Initialize

You can reset the player to its original factory settings, initialize the BD storage or deactivate the player.

1. Select [Initialize] option then press ►.
2. Press ▲ / ▼ to select the desired option then press ENTER.

The confirm message will appear.

**[Factory Set]** – If you need to, you can reset the player to all its factory settings. Some options cannot be reset. (Rating, Password and Area Code, etc.)

**[BD Storage Clear]** – Initializes the BD contents from the connected USB device.

3. Use ◀ / ▶ to select [Yes] or [No] then press ENTER.

### DivX Registration Code

We provide you the DivX® VOD (Video On Demand) registration code that allows you to rent and purchase videos using the DivX® VOD service. For more information, visit [www.divx.com/vod](http://www.divx.com/vod).

1. Select [DivX Reg. Code] option then press ►.
2. Press ENTER or ► and the registration code will appear.
3. Use the registration code to purchase or rent the videos from DivX® VOD service at [www.divx.com/vod](http://www.divx.com/vod). Follow the instructions and download the video onto a disc for playback on this unit.

### Note:

All the downloaded videos from DivX® VOD can only be played back on this unit.

# Operations

## General playback features

1. Load your chosen disc in the tray, with the playback side down.
2. Start playback using the HOME menu (see page 9).

Buttons	Operations	Discs
OPEN / CLOSE (▲)	Opens or closes the disc tray.	All Discs
■ (STOP)	<p>Stops the playback.</p> <p>The unit records the stopped point, depending on the disc. "■■■" appears on the screen briefly. Press ► (PLAY) to resume playback (from the scene point). If you press STOP (■) again or unload the disc ("■" appears on the screen.), the unit will clear the stopped point. (■■■ = Resume Stop, ■ = Complete Stop)</p> <p><b>Notes:</b></p> <ul style="list-style-type: none"> <li>• The resume point may be cleared when a button is pressed (for example; POWER, OPEN/CLOSE, etc).</li> <li>• On BD-Video discs including BD-J, the resume play function does not work.</li> <li>• On BD-ROM interactive title, the unit will be in Complete Stop mode if you press STOP once during playback.</li> </ul>	<p>All Discs</p> <p>BD DVD ACD MP3 WMA AVCHD</p>
(PAUSE)	<p>During playback, press    to pause playback.</p> <p><b>Tip:</b> During Audio CD or MP3/WMA playback, press    once again to resume playback.</p> <p>Press    repeatedly to play Frame-by-Frame.</p>	<p>All Discs</p> <p>DVD BD AVCHD DivX</p>
◀◀ / ▶▶ (SKIP)	<p>During playback, press ◀◀ or ▶▶ to go to the next chapter/track/file or to return to the beginning of the current chapter/track/file.</p> <p>Press ◀◀ twice briefly to step back to the previous chapter/track/file.</p>	All Discs
◀◀ / ▶▶ (SCAN)	<p>During playback, press SCAN (◀◀ or ▶▶) repeatedly to select the required scan speed.</p> <p>- DVD, BD, AVCHD, DivX: 5 steps, - Audio CD, MP3, WMA: 3 steps</p> <p>While the playback is paused, press SCAN ▶▶ repeatedly to play in slow motion (4 steps, forward only).</p>	<p>All Discs</p> <p>DVD BD AVCHD DivX</p>
REPEAT	<p>During playback, press REPEAT repeatedly to select a desired repeat mode.</p> <p>DVD, BD, AVCHD: Chapter/Title/Off Audio CD, MP3, WMA: Track/All/Off</p> <p><b>Note:</b></p> <p>If you press ▶▶ once during Repeat Chapter/Track playback, the repeat playback cancels.</p>	<p>DVD BD ACD MP3 WMA AVCHD</p>
A-B	<p>During playback, each press of A-B button to select point A and point B and repeats a sequence from point A (Starting point) to point B (End point).</p> <p>To cancel the sequence, press A-B.</p>	<p>DVD BD ACD AVCHD</p>

Continued →



## General playback features (Continued)

Buttons	Operations	Discs
TITLE/POPUP	If the current DVD or BD-ROM disc has a menu, the Title menu or Popup menu appears on the screen. Depending on the disc, the menu may not be available.	<b>DVD</b> <b>BD</b> <b>AVCHD</b>
DISC MENU	The menu appears on the screen. Depending on the disc, the menu may not be available.	<b>DVD</b> <b>BD</b> <b>AVCHD</b>
ANGLE (⌂)	During playback of the disc contains scenes recorded at different camera angles, press ANGLE repeatedly to select a desired angle.  <b>Note:</b> When you are playing a disc containing scenes recorded at different camera angles, the angle indicator will appear on the TV screen for a while and display window during scenes recorded at different angles as an indication that angle switching is possible.	<b>DVD</b> <b>BD</b>
SUBTITLE (☒)	During playback, press SUBTITLE repeatedly to select a desired subtitle language.  <b>Note:</b> Some discs allow you to change subtitle selections only via the disc menu. If this is the case, press TITLE/POPUP or DISC MENU button and choose the appropriate subtitle from the selections on the disc menu.	<b>DVD</b> <b>BD</b> <b>AVCHD</b> <b>DivX</b>
SUBTITLE ON/OFF	During playback, press SUBTITLE ON/OFF to switch the subtitle on or off.	<b>DVD</b> <b>BD</b> <b>AVCHD</b> <b>DivX</b>
AUDIO (⌂)	During playback, press AUDIO repeatedly to hear a different audio language or audio track.  <b>Notes:</b> <ul style="list-style-type: none"> <li>Some discs allow you to change audio selections only via the disc menu. If this is the case, press TITLE/POPUP or DISC MENU button and choose the appropriate audio from the selections on the disc menu.</li> <li>Immediately after you have switched sound, there may be a temporary discrepancy between the display and actual sound.</li> <li>On BD-ROM disc, the multi audio format (5.1CH or 7.1CH) is displayed with [MultiCH] in the on-screen display.</li> </ul>	<b>DVD</b> <b>BD</b> <b>AVCHD</b> <b>DivX</b>

### Notes on general features:

- When you turn on the player or replace a disc, the player returns to the initial default setting. Depending on a disc, a specific type of audio the disc has is output.
- Depending on the pre-recorded contents of the BD-ROM, some functions may not be available or may be operated differently than other media.

## If a disc menu screen is displayed

**DVD** **BD** **AVCHD**

The menu screen may be displayed after first loading a disc which contains a menu.

Use ◀ / ▶ / ▲ / ▼ buttons to select the title/chapter you want to view, then press ENTER to start playback.

## Enlarge the playback image

**DVD** **BD** **AVCHD** **DivX**

1. During playback or pause mode, press ZOOM to display the [Zoom] menu.
2. Use ◀ / ▶ to select zoom mode (16 steps). Press RETURN to make the menu disappear.
3. To return to the normal picture size, select [Off] on the [Zoom] menu.

### **Note:**

This function may not work on some disc or titles.

## Time Search **DVD** **BD** **AVCHD** **DivX**

To start playing at any chosen time on the disc:

1. Press DISPLAY during playback.
2. Press ▲ / ▼ to select the time clock icon and "--:--:--" appears.
3. Input the required start time in hours, minutes, and seconds from left to right. For example, to find a scene at 2 hours, 10 minutes, and 20 seconds, enter "21020" and press ENTER. If you enter the wrong numbers, press CLEAR to remove the numbers you entered. Then input the correct numbers.
4. Press ENTER to confirm. Playback starts from the selected time.

### **Note:**

This function may not work on some disc or titles.

## Skip Search **DVD** **BD** **AVCHD** **DivX**

You can skip the playback 15 seconds forward or backward using the search menu.

1. During playback, press SEARCH and the search menu appears on the screen.
2. Press ◀ / ▶ to skip the playback forward or backward.

### **Tip:**

You can select a point that you want to skip by pressing and holding ◀ / ▶ button.

## Marker Search **DVD** **BD** **AVCHD** **DivX**

### To enter a Marker

You can start playback from up to nine memorized points. To enter a marker, press MARKER at the desired point on the disc. The Marker icon appears on the TV screen briefly. Repeat to enter up to nine markers.

### To Recall or Clear a Marked Scene

1. Press SEARCH and the search menu appears on the screen.
2. Press a number button to select a marker number that you want to recall. Playback starts from the marked scene.

OR

Press ▼ to highlight a marker number. Use ◀ / ▶ to select a marked scene that you want to recall or clear.

Press ENTER and playback starts from the marked scene. Press CLEAR and the marked scene is erased from the search menu.

### **Notes:**

- This function may not work on some disc or titles.
- All marked points are cleared if you press STOP (■) twice (complete stop), the title is changed or if you unload the disc.

## Using colour (A, B, C, D) Buttons **BD**

These buttons are available only during BD-J contents playback. Use the appropriate buttons as indicated by the display. Depending on the disc contents, the functions of each button may differ.

## Last Scene Memory **DVD** **BD**

This unit memorizes last scene from the last disc that is viewed. The last scene remains in memory even if you remove the disc from the unit or switch off the unit. If you load a disc that has the scene memorized, the scene is automatically recalled.

### **Notes:**

- Settings are stored in memory for use any time.
- This unit does not memorize settings of a disc if you switch off the unit before commencing to play it.
- Last Scene Memory function for a previous disc is erased once a different disc is played.
- This function may not work depending on the disc.

## Screen Saver

The screen saver appears when you leave the player in Stop mode for about five minutes.

## Displaying Disc Information On-Screen

**DVD** **BD** **AVCHD** **DivX**

You can display various information about the disc loaded on-screen.

1. Press DISPLAY to show various playback information.  
The items displayed differ depending on the disc type or playing status.



2. During BD-ROM or DVD playback, you can select an item by pressing ▲ / ▼ and change or select the setting by pressing ◀ / ▶.
  - Title – Current title number/total number of titles.
  - Chapter – Current chapter number/total number of chapters.
  - Time – Elapsed playing time.
  - Audio – Selected audio language or channel.
  - Subtitle – Selected subtitle.
  - Angle – Selected angle/total number of angles.

### Notes:

- If no button is pressed for a few seconds, the on-screen display disappears.
- A title number cannot be selected on some discs.
- An item may not be available on some discs or titles.
- If BD interactive title is playing back, some setting information is displayed on the screen but prohibited to be changed.

## Enjoying BD-LIVE™ or BONUS VIEW™ in BD-Video **BD**

This unit allows you to enjoy functions such as picture-in-picture, secondary audio and Virtual packages, etc., with BD-Video supporting BONUSVIEW (BD-ROM version 2 Profile 1 version 1.1/ Final Standard Profile). In addition to the BONUSVIEW function, BD-Video supporting BD-Live (BD-ROM version 2 Profile 2) that has a network extension function allows you to enjoy more functions such as online games by connecting this unit to the Internet.

### Playing secondary video (picture-in-picture) and secondary audio

Secondary video can be played from a disc compatible with the picture-in-picture function.

For the playback method, refer to the instructions for the disc.

- To turn on/off secondary video, press PIP. Secondary video is played. Press the button to turn it ON and OFF.
- To turn on/off audio with the secondary video, press PIP AUDIO. The secondary audio is played. Press the button to turn it ON and OFF.

#### Notes:

- Discs may not always be played back according to the settings on this unit, as certain playback formats are prioritized on certain discs.
- Only the primary video is played during search/slow-motion or frame-by-frame.
- When the secondary video is turned off, the secondary audio does not play.
- This function may not work depending on the disc.

### Enjoying BD-Live discs with Internet

#### Preparations:

- The unit must be connected to the Internet and set up to use the BD-Live functions (see page 16 and 22).
- A USB device is required to use this function. Connect a USB device (see page 9).
- The free space in the USB device must be more than 1GB.

This unit supports BD-Live, a new BD-Video function that allows you to use the following interactive functions when connected to the Internet. (The usable functions and the operating method may vary with each disc. For details, refer to the instructions for the disc.)

- Additional contents such as movie's trailer, subtitles and BD-J, etc. can be downloaded to USB device to play them.
- Special video data, etc. may be played back while they are being downloaded to a USB device.

#### Caution:

Do not extract the USB device while contents are being downloaded to it. Doing so may result in malfunctions.

#### AACS Online

When discs supporting BD-Live are played back, the player or disc IDs may be sent to the content provider via the Internet.

Services and functions to be provided differ depending on the disc.

- You can be introduced to other similar movies if you record your viewing history on the server by using these IDs.
- Game score histories can be saved.

#### Notes:

- It may take up to several minutes to load and start enjoying BD-Live contents.
- Depending on a disc, the BD-Live function may not be operated if [BD-LIVE connection] option is set to [Partially Permitted]. (See page 22.)
- The connection to the Internet may take time or the Internet may not be connected depending on the connection environment. It is required that you use a broadband connection.
- Do not remove the USB device during operation. The USB device may be damaged. Stop playback and turn off the menu beforehand.

#### Tip:

Special video data, etc. may be played back while they are being downloaded to a USB device using one function of BD-Live. The playback may be paused depending on the communication environment.

Some functions may be disabled to prevent skipping to sections that have not been downloaded, etc.

## Playing a DivX Movie File

The player can play DivX files. Before playing DivX files, read "DivX file requirement" on right.

1. Insert a disc containing DivX files, or connect the USB Device containing DivX files.
2. Press HOME and Home Menu appears.
3. Select [Movie] then press ENTER.  
The MOVIE menu appears on the TV screen.

### Note:

When the USB Device is connected and a disc is inserted simultaneously, the menu for selecting a media will appear. Select a media then press ENTER.



2. Press ▲ / ▼ to select a title then press ENTER or ► (PLAY) and playback starts.  
You can use variable playback functions.  
Refer to pages 24-27.
3. Press DISC MENU to move to the list menu.

### Note:

On the [MOVIE] menu, use red or blue colour button to move to the previous or next page.

## Notice for displaying the DivX subtitle

If the subtitle does not display properly, press and hold SUBTITLE for 3 seconds during playback. The language code will appear. Press SUBTITLE repeatedly to select another language code until the subtitle is displayed properly and then press ENTER.

## DivX file requirement

DivX file compatibility with this player is limited as follows:

- Available resolution size: 720x576 (W x H) pixel.
- The file names of DivX and subtitle are limited to 50 characters.
- DivX file extensions: ".avi", ".divx", ".mpg", ".mpeg"
- Playable DivX subtitle: SubRip (.srt / .txt), SAMI (.smi), SubStation Alpha (.ssa/.txt), MicroDVD (.sub/.txt), SubViewer 1.0 (.sub), SubViewer 2.0 (.sub/.txt), TMPlayer (.txt), DVD Subtitle System (.txt)
- Playable Codec format: "DIVX3.xx", "DIVX4.xx", "DIVX5.xx", "XVID", "DIVX6.xx" (Standard playback only)
- Only the playback function is supported with DivX 6.0 in the unit.
- Playable Audio format: "Dolby Digital", "DTS", "MP3", "WMA"
- Sampling frequency: within 8 - 48 kHz (MP3), within 32 - 48 kHz (WMA)
- Bit rate: within 8 - 320 kbps (MP3), within 32 - 384 kbps (WMA)
- CD-R/RW, DVD±R/RW, BD-R/RE Format: ISO 9660+JOLIET, UDF and UDF Bridge format
- Maximum Files/Disc: Less than 1999 (total number of files and folders)
- Not all the WMA Audio format is compatible with this unit.

## Playing a DVD VR Format Disc

This unit will play DVD-RW disc that is recorded using the Video Recording (VR) format.

1. Insert a disc and close the tray.  
The [MOVIE] menu appears on the TV screen

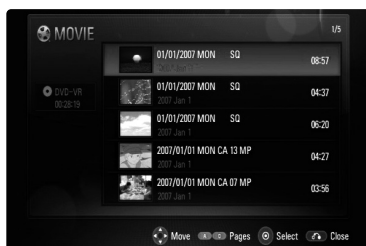

2. Press ▲ / ▼ to select a title then press ► (PLAY) and playback starts.  
You can use variable playback functions. Refer to pages 24-27.
3. Press DISC MENU to move to the list menu.

### Notes:

- On the [MOVIE] menu, use red or blue colour button to move to the previous or next page.
- Unfinalized DVD-VR format discs may not be played in this player.
- Some DVD-VR disc are made with CPRM data by DVD RECORDER. This unit cannot support these kinds of discs.

### What is CPRM?

CPRM is a copy protection system (with scramble system) only allowing the recording of 'copy once' broadcast programmes. CPRM stands for Content Protection for Recordable Media.

## MOVIE menu options

1. Use ▲ / ▼ to select a title on the [MOVIE] menu then press ENTER.  
The menu options appear.
2. Use ▲ / ▼ to select an option, then press ENTER.

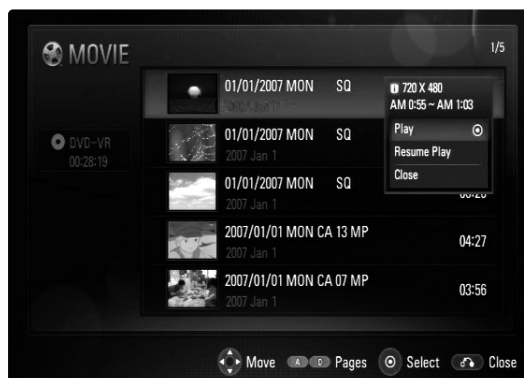

- **[Play]** Starts playback of the selected title.
- **[Resume Play]** Starts playback from where you stopped it previously.
- **[Close]** Exits menu options. Also you can disappear it by pressing RETURN button.

## Playing an Audio CD or MP3/WMA files **ACD** **MP3** **WMA**

The player can play Audio CDs and MP3/WMA files. Before playing MP3/WMA files, read "MP3/WMA audio file requirement" on right.

1. Insert Audio CD or a disc containing MP3/WMA files, or connect the USB Device containing MP3/WMA files
2. Press HOME and Home Menu appears.
3. Select [Music] then press ENTER. The MUSIC menu appears on the TV screen.

### Note:

When the USB Device is connected and a disc is inserted simultaneously, the menu for selecting a media will appear. Select a media then press ENTER.

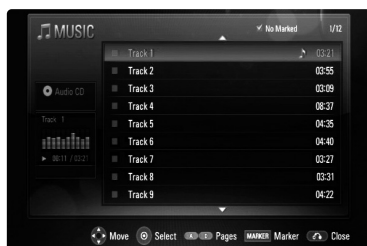

Example) Audio CD

4. Use ▲/▼ to select a track or file then press ► (PLAY). Playback starts. You can use variable playback functions. Refer to page 24.
5. To stop playback at any time, press STOP (■).

### Tips:

- To go directly to any track or file and play, enter the track/file number using the numbered buttons (0-9).
- The playback may start automatically if the Audio CD is inserted.
- Select a folder then press ENTER and you can view the files in the folder. If you want to move to the upper directory, use ◀ or ▲/▼ to highlight [UP Folder] and press ENTER.
- On the MUSIC menu, use red or blue colour button to move to the previous or next page.
- The equalizer indicator is not coupled with the music in play back.
- If there is impossible code to express in the file name, it may be displayed as illegible.

## MUSIC menu options

1. Use ▲ / ▼ to select a track or file on the MUSIC menu then press ENTER. The menu options appear.
2. Use ▲ / ▼ to select an option, then press ENTER.



- **[Play]** Starts playback of the selected track or file.
- **[Select Play]** Plays back only the marked track(s) or file(s). Use MARKER for selecting the multiple files or tracks.
- **[Random]** Starts or stops random playback. By pressing ►► during random playback, the unit selects another track and resumes random playback.
- **[Unmark All]** Unmarks all marked files or tracks.
- **[Close]** Exits menu options. Also you can make it disappear by pressing the RETURN button.

### Note:

You cannot use [Select Play] and [Random] functions simultaneously.

## MP3/WMA audio file requirement

**File extensions:** ".mp3", ".wma"

**Sampling frequency:** 8 - 48 kHz

**Bit rate:** 8 - 320kbps

**CD-R/RW, DVD±R/RW, BD-R/RE Format:** ISO 9660+JOLIET, UDF and UDF Bridge format

**Maximum Files/Disc:** Less than 1999 (total number of files and folders)

### Notes on MP3/WMA file

- Depending on the size and number of the MP3/WMA files, it may take several minutes to read the contents of the media.
- This unit cannot support the ID3 Tag embedded in the MP3 file.

## Viewing a Photo file **PHOTO**

This unit can play a photo files. Before playing photo recordings, read “Photo file requirement” below.

1. Insert a disc containing photo files, or connect the USB Device containing photo files.
2. Press HOME and Home Menu appears.
3. Select [Photo] then press ENTER. The PHOTO menu appears on the TV screen.

### Note:

When the USB Device is connected and a disc is inserted simultaneously, the menu for selecting a media will appear. Select a media then press ENTER.



4. Use ▲▼◀▶ to select a file and press ENTER. The selected image is displayed in full screen.



5. To stop viewing at any time, press STOP (■). The PHOTO menu appears.

### Tips:

- To go directly to any file and play, enter the file number using the numbered buttons (0-9).
- You can advance to the previous or next file by pressing ◀◀ or ▶▶ during viewing a photo file in full screen.
- You can start the slide show by pressing ▶ (PLAY) while the PHOTO menu appears.
- Select a folder then press ENTER and you can view the files in the folder. If you want to move to the upper directory, use ▲/▼/◀/▶ to highlight [UP Folder] and press ENTER.
- On the PHOTO menu, use red or blue colour button to move to the previous or next page.
- If there is impossible code to express in the file name, it may be displayed as illegible.

## Options during viewing a photo file in full screen

1. Follow steps 1-4 as shown left (Viewing a Photo file).
2. You can use variable options during viewing a picture.
3. Use ▲▼◀▶ to select an option.

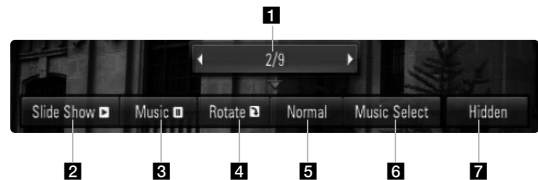

- 1 Use ◀/▶ to advance to the previous or next file.
- 2 Use ENTER to start or pause the slide show.
- 3 Use ENTER to play or pause the background music. This option is available after the background music is selected using [Music Select] option.
- 4 Use ENTER to rotate the picture clockwise. This option is not available during slide show.
- 5 Use ENTER to set the Slide Show speed.
- 6 Selects the background music.
  - 1) Press ENTER and the menu will appear.
  - 2) Use ▲▼◀▶ to select a media or folder where there are music file(s).
  - 3) Press ENTER to confirm your selection.
- 7 Press ENTER to exit the option menu. To make the menu appear again, press ENTER.

### Photo file requirement

**File extensions:** “.jpg”, “.jpeg”, “.png”

#### Recommended size:

Less than 3,000 x 3,000 x 24 bit/pixel  
Less than 3,000 x 2,250 x 32 bit/pixel

#### CD-R/RW, DVD±R/RW, BD-R/RE Format:

ISO 9660+JOLIET, UDF and UDF Bridge format

#### Maximum Files/Disc:

Less than 1999 (total number of files and folders)

#### Notes on Photo file

- Progressive and lossless compression photo image files are not supported.
- Depending on the size and number of the photo files, it may take several minutes to read the contents of the media.



# Reference

## Controlling a TV with the Supplied Universal Remote Control

You can control the volume, input source, and power state of your TV with the supplied Universal Remote Control.

If your TV is listed in the table on pages 34-35, set the appropriate manufacturer code. Follow steps 1-2 as shown right.

You can control your TV using the buttons below.

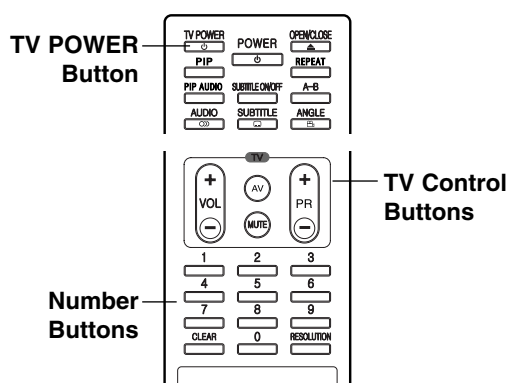

By pressing	You can
TV POWER	Turn the TV on or off.
AV	Switch the TV's input source between the TV and other input sources.
PR +/-	Scan up or down through memorized channels.
VOL +/-	Adjust the volume of the TV.
MUTE	Temporarily turns TV sound OFF, press again to restore.

### Note:

Depending on the unit being connected, you may not be able to control your TV using some of the buttons.

## To programme the remote to control the TV using the manufacturer code

If your TV is listed in the table on the next page, set the appropriate manufacturer code.

- While holding down TV POWER button, press the number buttons to select the manufacturer code for your TV (Refer to table on the next page).
  - If more than one code number is listed, try entering them one at a time until you find the one that works with your TV.
- Release TV POWER button.

### Notes:

- Depending on your TV, some or all buttons may not function on the TV, even after entering the correct manufacturer code.
- If you enter a new code number, the code number previously entered will be erased.
- When you replace the batteries of the remote, the code number you have set may be reset to the default setting. Set the appropriate code number again.

## Code numbers of controllable TVs

If more than one code number is listed, try entering them one at a time until you find the one that works with your TV.

BRANDS	CODES
ADMIRAL	137 204
ADYSON	159 219
AKAI	009 010 108 132 133 135 139 140 156 174 175
AKURA	064 086 108 110 155 171
ALBA	009 060 064
ALLSTAR	108
AMSTRAD	006 025 157
AMWAY	108
ANITECH	010 049 108 185 219
ANTECNO	064
ARC EN CIEL	173 179 239
ASA	087 102 108 235 236
ASBERG	185
ASORA	171
ATLANTIC	089 197
AUDIOSONIC	085
AUTOVOX	159 163 197
BANK	232
BEKO	045 085 086 108 250
BESTAR	086
BLAUPUNKT	031 091 092 096 097 098 099 210 253
BONDSTEC	163
BOSCH	210
BRANDT	173 179 225 239
ELECTRONIQUE	
BRIONVEGA	204
BSR	144
BUSH	009 136 139 144 232
CENTURY	165 204
CGE	139 165 210
CIE	025 108 170
CLATRONIC	009 010 064 108 144 149 159 164 165 171 185
CLARIVOX	033
CONDOR	108 149 191
CONIC	219
CONTEC	171 222
CONTINENTAL	173 179 225 239
EDISON	
COSMOS	108
CROSLEY	165 204
CROWN	084 085 086 108 144 171 185
CS-ELECTRONICS	064
DAEWOO	051 108 120 127 170
DANSAI	010 219
DE GRAAF	108 134
DECCA	070 108 159 161 162 184 189 190 206
DECCAVIDEO	108
DUAL	233
DUMONT	204

BRANDS	CODES
ELBE	058 144 157 160 192 246
ELBIT	108 248
ELECTROVENDA	108
ELEKTRONIKA	108
ELIN	108
ELITE	064 149
ELMAN	144
ELTA	010 171
EMERSON	108 204
ESC	108
ETRON	133
EUROPHON	144 159
EXPERT	089
FENNER	171
FERGUSON	078 079 080 160 182 195 198 199 200 201 202
FINLANDIA	194 195
FINLUX	008 087 102 104 105 107 108 140 144 159 161 174 189 235 236
FIRST-LINE	144
FISHER	086 208 222 233
FORMENTI	108 149
FRABA	108
FRONTECH	136 171 220
FUBA	073 109
FUJITSU GENERAL	088 159 197
FUNAI	010
GALAXIS	108 185
GALERIA	171
GBC	137 144 171
GEC	011 108 129 147 159 189
GELOSO	064 137 144 164 171
GENERAL	171
GENERAL TECHNIC	171
GOLDHAND	159 171
GOLDSTAR	038 050 108 110 136 144 159 163 166 171 191 219 237
GOODMANS	009 064 108 109 110 120 159 170 171
GORENJE	086
GPM	010 064
GRANADA	027 105 108 111 121 134 140 159 162 167 187 194 195 238
GRUNDIG	091 092 093 094 095 097 098 100 101 172 232 238
HCM	010 108 159 171
HIFIVOX	173 179 239
HINARI	010 064 108 133 171
HIT	204

BRANDS	CODES
HITACHI	011 013 015 017 021 022 023 024 028 029 030 035 039 040 041 048 053 054 055 056 057 120 127 128 129 134 135 140 143 145 147 151 156 159 173 193 219
HYPER	009 159 163 171
ICE	009 010 064 108 171
IMPERIAL	043 049 108 139 144 154 165 255
INGERSOLL	171
INNO HIT	159 189 237
INTERBUY	010
INTERCORD	233
INTERFUNK	108 109 113 130 133 134 135 137 141 146 147 148 165 179 210
INTERVISION	010 086 108 132 144 166
IRRADIO	163 235 237
ITC	144 159
ITS	009 010 064 171
ITT	141 151 186
JVC	009 169
KAIDO	136
KAPSCH	089 147 148 197
KARCHER	084 108
KATHREIN	109
KAWA	009
KENDO	060 108 137 157
KENNEDY	197
KNEISSEL	108
KONKA	009
KORTING	086 204 209
KUBA	233
KUBA ELECTRONIC	233
KURA	134
LENCO	108 170
LG	001(Default) 038 050 108 110 136 144 159 163 166 171 191 219 237
LIESENKOTTER	108 210
LIFETEC	010 064 108 170
LOEWE	109 113 204 205
LOGIK	070 227
LUMA	137 197
LUXOR	102 104 132 133 134 135 138 140 143 145 153 156 174 186 237
M ELECTRONIC	103 104
MAGNADYNE	163 164 204
MAGNAFON	199
MAGNASONIC	108
MARANTZ	108
MARSHAL	064
MATSUI	009 016 025 060 061 062 063 070 108 131 136 152 154 159 171 172

BRANDS	CODES
MERRIT	132
METZ	047 092 097 098 100 101 108 204 207 254
MITSUBISHI	075 076 077 097 113 204 222 224 240
MIVAR	044 042 159 235
MNARTT	007
MTC	086 109 134
MULTITECH	136 159 171 185
MURPHY	232
NAONIS	137
NECKERMANN	037 059 060 092 098 100 101 108 109 113 115 118 119 134 135 137 143 157 159
NEI	064 108
NIKKAI	219
NIKKO	108
NOBLIKO	232 235
NOGAMATIC	173 179 239
NOKIA	014 019 032 102 103 104 108 132 133 134 135 138 140 141 145 146 147 148 156 174
NORDMENDE	129 173 179 180 181 193 195 225 226 228 239
NORMN	108
NOVA	087
OCEANIC	032 103 104 135 140 156
OKANO	108
ONWA	009 010 064
ORAVA	108
ORBITER	086
ORION	025 059 060 061 062 064 070 108 110 118 219
OSAKE	106
OTTO-VERSAND	002 005 009 014 059 060 081 082 083 085 092 097 098 100 101 108 109 111 113
PAEL	235
PANASONIC	002 003 005 167 168 229
PATHE CINEMA	144
PATHE MARCONI	173 179 225 239
PHILCO	090 108 139 144 148 165 204
PHILIPS	065 066 067 068 069 092 108 109 111 112 114 115 116 119 122 123 124 125 193 212 251 252
PIONEER	193
PRANDONI-PRINCE	137 235
PRIMA	219
PRO VISION	108

BRANDS	CODES
PROFEX	108 136 171
PROFITRONIC	108
QUELLE	002 010 014 019 025 059 060 072 084 086 087 088 092 097 098 100 101 102 175
RADIOLA	108
RADIOTONE	010 085 108 171
REDIFUSSION	187
REVOX	109
REX	088 089 137 157 158 164 197 246 247
RFT	064 085 135 204
RITAR	138
ROADSTAR	108
ROSITA	171
SABA	079 146 147 173 179 181 193 195 225 226 239
SAISHO	025 060 070 136 159
SAKIO	171
SALORA	019 032 103 104 132 133 134 135 137 138 140 142 143 145 150 156 174 237 241
SAMBERS	235
SAMSUNG	004 010 050 086 108 117 126 171 220 237
SANY	193
SANYO	014 018 019 020 032 034 071 086 087 189 218 221 222 223
SCHNEIDER	009 064 088 108 133 141 159 163 233
SEG	010 064 108 144 159 165 171 185 219
SEI-SINUDYNE	025 108 204 212
SELECO	088 089 137 157 197 222
SENTRA	064 133
SHARP	081 082 083 222
SHINTOM	108
SHINTOSHI	108
SHIVAKI	108
SIAREM	204
SIEMENS	092 096 097 098 100 101 108 210 218 219 221
SIESTA	085
SILVER	010 064
SINGER	108 164 204
SINUDYNE	118 131
SMARAGO	172
SOLAVOX	133
SONOLOR	140 156
SONTEC	108
SONY	072 074 211 212 213 214 215 216 217 222

BRANDS	CODES
SPECTRA	170
STARLITE	108 171
STARLUX	171
STERN	088 089 137 157 197
SUNSTAR	108 171
SUPERTECH	108 139 152 171
TADISTAR	108
TASHIKO	108 159 218
TEC	108 139 144 159 170 171
TECHLINE	185
TECHNISAT	108 165
TECNISON	108 171
TEKON	171
TELEAVIA	173 178 179 225 239
TELEFUNKEN	079 177 179 181 193 195 200 210
TELEOPTA	171
TELERNT	109
TELETECH	165 171
TELETEXT	115
TELETON	088
TELETON	089 134 159 197
TENSAI	064 108 144 149 171 191
TENSON	171
TESLA	204
THOMSON	052 078 079 134 173 178 179 181 193 195 225 239
THORN	011 014 016 018 026 028 066 072 075 087 097 102 108 116 135 141 145 146 160
THORN-FERGUSON	160 188 200 227
TOSHIBA	012 016 026 036 037 222 232
TOWADA	144 185
TRISTAR	010 064
TRIUMPH	025 219 236
UHER 089	108 109 149 185 197 233
ULTRAVOX	108 164 185 204
UNIVERSUM	174
UNIVOX	204
VESTEL	108
VIDEOSAT	165
VIDEOTON	178 193
VIDEOWAY	230
VISION	108 149
VOXSON	137 204
WALTHAM	178
WATSON	064 108 149 171
WEGA	208 222
WHITE	108 110 149
WESTINGHOUSE	
YOKO	010 064 108 136 144 159 164 170 171
ZANUSSI	137 197
ZENITH	231

## Language Codes

Use this list to input your desired language for the following initial settings:  
Disc Audio, Disc Subtitle, Disc Menu.

Language	Code	Language	Code	Language	Code	Language	Code
Abkhazian	6566	Fiji	7074	Lingala	7678	Singhalese	8373
Afar	6565	Finnish	7073	Lithuanian	7684	Slovak	8375
Afrikaans	6570	French	7082	Macedonian	7775	Slovenian	8376
Albanian	8381	Frisian	7089	Malagasy	7771	Somali	8379
Ameharic	6577	Galician	7176	Malay	7783	Spanish	6983
Arabic	6582	Georgian	7565	Malayalam	7776	Sudanese	8385
Armenian	7289	German	6869	Maltese	7784	Swahili	8387
Assamese	6583	Greek	6976	Maori	7773	Swedish	8386
Aymara	6589	Greenlandic	7576	Marathi	7782	Tagalog	8476
Azerbaijani	6590	Guarani	7178	Moldavian	7779	Tajik	8471
Bashkir	6665	Gujarati	7185	Mongolian	7778	Tamil	8465
Basque	6985	Hausa	7265	Nauru	7865	Tatar	8484
Bengali; Bangla	6678	Hebrew	7387	Nepali	7869	Telugu	8469
Bhutani	6890	Hindi	7273	Norwegian	7879	Thai	8472
Bihari	6672	Hungarian	7285	Oriya	7982	Tibetan	6679
Breton	6682	Icelandic	7383	Panjabi	8065	Tigrinya	8473
Bulgarian	6671	Indonesian	7378	Pashto, Pushto	8083	Tonga	8479
Burmese	7789	Interlingua	7365	Persian	7065	Turkish	8482
Byelorussian	6669	Irish	7165	Polish	8076	Turkmen	8475
Cambodian	7577	Italian	7384	Portuguese	8084	Twi	8487
Catalan	6765	Japanese	7465	Quechua	8185	Ukrainian	8575
Chinese	9072	Javanese	7487	Rhaeto-Romance	8277	Urdu	8582
Corsican	6779	Kannada	7578	Rumanian	8279	Uzbek	8590
Croatian	7282	Kashmiri	7583	Russian	8285	Vietnamese	8673
Czech	6783	Kazakh	7575	Samoan	8377	Volapük	8679
Danish	6865	Kirghiz	7589	Sanskrit	8365	Welsh	6789
Dutch	7876	Korean	7579	Scots Gaelic	7168	Wolof	8779
English	6978	Kurdish	7585	Serbian	8382	Xhosa	8872
Esperanto	6979	Laothian	7679	Serbo-Croatian	8372	Yiddish	7473
Estonian	6984	Latin	7665	Shona	8378	Yoruba	8979
Faroese	7079	Latvian, Lettish	7686	Sindhi	8368	Zulu	9085

## Area Codes

Choose an Area code from this list.

Area	Code	Area	Code	Area	Code	Area	Code
Afghanistan	AF	Ethiopia	ET	Malaysia	MY	Saudi Arabia	SA
Argentina	AR	Fiji	FJ	Maldives	MV	Senegal	SN
Australia	AU	Finland	FI	Mexico	MX	Singapore	SG
Austria	AT	France	FR	Monaco	MC	Slovak Republic	SK
Belgium	BE	Germany	DE	Mongolia	MN	Slovenia	SI
Bhutan	BT	Great Britain	GB	Morocco	MA	South Africa	ZA
Bolivia	BO	Greece	GR	Nepal	NP	South Korea	KR
Brazil	BR	Greenland	GL	Netherlands	NL	Spain	ES
Cambodia	KH	Herd and McDonald Islands	HM	Netherlands Antilles	AN	Sri Lanka	LK
Canada	CA	Hong Kong	HK	New Zealand	NZ	Sweden	SE
Chile	CL	Hungary	HU	Nigeria	NG	Switzerland	CH
China	CN	India	IN	Norway	NO	Taiwan	TW
Colombia	CO	Indonesia	ID	Oman	OM	Thailand	TH
Congo	CG	Israel	IL	Pakistan	PK	Turkey	TR
Costa Rica	CR	Italy	IT	Panama	PA	Uganda	UG
Croatia	HR	Jamaica	JM	Paraguay	PY	Ukraine	UA
Czech Republic	CZ	Japan	JP	Philippines	PH	United States	US
Denmark	DK	Kenya	KE	Poland	PL	Uruguay	UY
Ecuador	EC	Kuwait	KW	Portugal	PT	Uzbekistan	UZ
Egypt	EG	Libya	LY	Romania	RO	Vietnam	VN
El Salvador	SV	Luxembourg	LU	Russian Federation	RU	Zimbabwe	ZW

## Troubleshooting

Symptom	Possible Cause	Correction
No power.	<ul style="list-style-type: none"> <li>The power cord is disconnected.</li> </ul>	<ul style="list-style-type: none"> <li>Plug the power cord into the wall outlet securely.</li> </ul>
The power is on, but the player does not work.	<ul style="list-style-type: none"> <li>No disc is inserted.</li> </ul>	<ul style="list-style-type: none"> <li>Insert a disc. (Check the disc indicator in the display window is lit.)</li> </ul>
No picture.	<ul style="list-style-type: none"> <li>The TV is not set to receive DVD signal output.</li> </ul>	<ul style="list-style-type: none"> <li>Select the appropriate video input mode on the TV.</li> </ul>
	<ul style="list-style-type: none"> <li>The video cable is not connected securely.</li> </ul>	<ul style="list-style-type: none"> <li>Connect the video cable securely.</li> </ul>
	<ul style="list-style-type: none"> <li>The selected resolution is not capable with your TV.</li> </ul>	<ul style="list-style-type: none"> <li>Select another resolution using RESOLUTION button.</li> </ul>
No sound.	<ul style="list-style-type: none"> <li>The equipment connected with the audio cable is not set to receive disc signal output.</li> </ul>	<ul style="list-style-type: none"> <li>Select the correct input mode of the audio receiver so you can listen to the sound from the player.</li> </ul>
	<ul style="list-style-type: none"> <li>The power of the equipment connected with the audio cable is turned off.</li> </ul>	<ul style="list-style-type: none"> <li>Turn on the equipment connected with the audio cable.</li> </ul>
	<ul style="list-style-type: none"> <li>The [AUDIO] options are set to the wrong position.</li> </ul>	<ul style="list-style-type: none"> <li>Set the [AUDIO] options to the correct position (see page 20).</li> </ul>
The player does not start playback.	<ul style="list-style-type: none"> <li>An unplayable disc is inserted.</li> </ul>	<ul style="list-style-type: none"> <li>Insert a playable disc. (Check the disc type and regional code.)</li> </ul>
	<ul style="list-style-type: none"> <li>The rating level is set.</li> </ul>	<ul style="list-style-type: none"> <li>Change the rating level.</li> </ul>
BD-Live feature does not work.	<ul style="list-style-type: none"> <li>External USB device is not connected.</li> </ul>	<ul style="list-style-type: none"> <li>Connect a FAT16 or FAT32 formatted USB device to the USB port (see page 9).</li> </ul>
	<ul style="list-style-type: none"> <li>Internet connection is not established.</li> </ul>	<ul style="list-style-type: none"> <li>Ensure that the unit is correctly connected to the local area network and can access the internet (see page 16).</li> </ul>
The Remote Control does not work properly.	<ul style="list-style-type: none"> <li>The Remote Control is not pointed at the remote sensor on the player.</li> </ul>	<ul style="list-style-type: none"> <li>Point the Remote Control at the remote sensor of the player.</li> </ul>
	<ul style="list-style-type: none"> <li>The Remote Control is too far from the player.</li> </ul>	<ul style="list-style-type: none"> <li>Operate the Remote Control closer to the player.</li> </ul>

### Resetting the Player

If you observe any of the following symptoms...

- When the Player is plugged in, but the power will not turn on or off.
- When the display window is not working.
- When the Player does not operate normally.

You can reset the Player as follows:

- Press and hold the POWER button for more than five seconds. This will force the Player to power off. Press the POWER button again to turn the Player back on.
- Unplug the power cord and then plug the power cord again after more than five seconds.

## Customer Support

You can update the Player using the latest software to enhance the products operation and/or add new features. To obtain the latest software for this player (if updates have been made), please visit <http://www.lgservice.com> or contact LG Electronics customer care centre.

## Specifications

### General

<b>Power requirements:</b>	AC 200-240 V~, 50/60 Hz
<b>Power consumption:</b>	26W
<b>Dimensions (W x H x D):</b>	Approx. 430 x 58 x 277 mm (16.9 x 2.3 x 10.9 inches) without foot
<b>Net Weight (Approx.):</b>	3 kg
<b>Operating temperature:</b>	5 °C to 35 °C
<b>Operating humidity:</b>	5 % to 90 %

### Outputs

<b>VIDEO OUT:</b>	1.0 V (p-p), 75 $\Omega$ , sync negative, RCA jack x 1
<b>COMPONENT VIDEO OUT:</b>	(Y) 1.0 V (p-p), 75 $\Omega$ , sync negative, RCA jack x 1 (Pb)/(Pr) 0.7 V (p-p), 75 $\Omega$ , RCA jack x 2
<b>HDMI OUT (video/audio):</b>	19 pin (HDMI standard, Type A)
<b>ANALOGUE AUDIO OUT:</b>	2.0 Vrms (1 kHz, 0 dB), 600 $\Omega$ , RCA jack (L, R) x 1
<b>DIGITAL OUT (COAXIAL):</b>	0.5 V (p-p), 75 $\Omega$ , RCA jack x 1
<b>DIGITAL OUT (OPTICAL):</b>	3 V (p-p), Optical jack x 1

### System

<b>Laser:</b>	Semiconductor laser, wavelength: 405nm / 650 nm
<b>Signal system:</b>	Standard PAL/NTSC colour TV system
<b>Frequency response:</b>	20 Hz to 20 kHz (48 kHz, 96 kHz, 192 kHz sampling)
<b>Signal-to-noise ratio:</b>	More than 100 dB (ANALOGUE OUT connectors only)
<b>Harmonic distortion:</b>	Less than 0.008%
<b>Dynamic range:</b>	More than 95 dB
<b>LAN port:</b>	Ethernet jack x 1, 10BASE-T/100BASE-TX
<b>Accessories:</b>	Video cable (1) Audio cable (1) Remote control (1) Batteries (2)

**Note:** Design and specifications are subject to change without prior notice.

## The unit's Audio Output Specifications

Jack/ Setting	Analogue Output Stereo	SPDIF (DIGITAL AUDIO OUT) *5		
		PCM Stereo	DTS Re-encode *3 *6	Primary Pass-Thru *1
Dolby Digital	PCM 2ch	PCM 2ch	DTS	Dolby Digital
Dolby Digital Plus	PCM 2ch	PCM 2ch	DTS	Dolby Digital
Dolby TrueHD	PCM 2ch	PCM 2ch	DTS	Dolby Digital
DTS	PCM 2ch	PCM 2ch	DTS	DTS
DTS-HD	PCM 2ch	PCM 2ch	DTS	DTS
Linear PCM 2ch	PCM 2ch	PCM 2ch	DTS	PCM 2ch
Linear PCM 5.1ch	PCM 2ch	PCM 2ch	DTS	PCM 2ch
Linear PCM 7.1ch	PCM 2ch	PCM 2ch	DTS	PCM 2ch

Jack/ Setting	HDMI OUT			
	PCM Stereo	PCM Multi-Ch *3	DTS Re-encode *6	Primary Pass-Thru *1, *2
Dolby Digital	PCM 2ch	PCM 5.1ch	DTS	Dolby Digital
Dolby Digital Plus	PCM 2ch	PCM 7.1ch	DTS	Dolby Digital Plus
Dolby TrueHD	PCM 2ch	PCM 7.1ch	DTS	Dolby TrueHD
DTS	PCM 2ch	PCM 5.1ch	DTS	DTS
DTS-HD	PCM 2ch	PCM 5.1ch	DTS	DTS-HD
Linear PCM 2ch	PCM 2ch	PCM 2ch	DTS	PCM 2ch
Linear PCM 5.1ch	PCM 2ch	PCM 5.1ch	DTS	PCM 5.1ch
Linear PCM 7.1ch	PCM 2ch	PCM 7.1ch	DTS	PCM 7.1ch **

### Notes:

- \*1 The secondary and interactive audio may not be included in the output bitstream if [SPDIF] or [HDMI] option is set to [Primary Pass-Thru]. (Except LPCM Codec : the output always include interactive and secondary audio.)
- \*2 This player automatically selects the HDMI audio according to the decoding capability of the connected HDMI device even though [HDMI] option is set to [Primary Pass-Thru].
- \*3 The [PCM Multi-CH]/[Primary Pass-Thru] setting of the [HDMI] option and [DTS re-encode] setting of the [SPDIF] option cannot be set together. If you set the [HDMI] option to [PCM Multi-CH] or [Primary Pass-Thru], the [SPDIF] option is set to [PCM Stereo] automatically. Also, if you set the [SPDIF] option to [DTS Re-encode] and the [HDMI] option is set to [PCM Stereo] automatically.
- \*4 The LPCM audio recorded at 192kHz sampling frequency will be outputted as stereo sound.
- \*5 On the PCM audio output, the sampling frequency of HDMI/SPDIF (DIGITAL AUDIO OUT) is limited to 96 kHz.
- \*6 If the [HDMI] or [SPDIF] option is set to [DTS re-encode], the audio output is limited to 48 kHz and 5.1 ch. If the [HDMI] or [SPDIF] option is set to [DTS re-encode], the DTS Re-encode audio is outputted for BD-ROM discs, and the original audio is outputted for the other discs (like [Primary Pass-Thru]).
- If [HDMI] option is set to [PCM Multi-CH] and [SPDIF] option is set to [Primary Pass-Thru] when the unit plays back Dolby Digital Plus audio, SPDIF (DIGITAL AUDIO OUT) jack is limited to "PCM 2ch".
- If the HDMI connection is version 1.3 and Dolby Digital Plus/Dolby TrueHD/DTS-HD is outputted from HDMI OUT jack, SPDIF (DIGITAL AUDIO OUT) jack is limited to "PCM 2ch" (When the HDMI and SPDIF are connected simultaneously).
- The audio is always output as PCM 48kHz/16 bit during Audio CD or MP3/WMA file is playing back.
- The Dolby TrueHD audio recorded on the BD disc is consist of Dolby Digital and TrueHD audio. The Dolby Digital audio is outputted through DIGITAL AUDIO OUT jacks and DD displays on the screen if the player does not use Lossless audio. (for example, when [HDMI] is set to [PCM Stereo] or [DTS Re-encode] and [SPDIF] is set to [Primary Pass-Thru])

## Open source software notice

The following GPL executables and LGPL libraries used in this product are subject to the GPL2.0/LGPL2.1 Licence Agreements:

### GPL EXECUTABLES:

Linux kernel 2.6, bash, busybox, dhcpcd, mtd-utils, net-tools, procps, sysutils, tinylogin

### LGPL LIBRARIES:

uClibc, DirectFB, iconv, cairo

LG Electronics offers to provide source code to you on CD-ROM for a charge covering the cost of performing such distribution, such as the cost of media, shipping and handling upon e-mail request to LG Electronics at:

[\*\*opensource@lge.com\*\*](mailto:opensource@lge.com)

This offer is valid for a period of three(3) years from the date of the distribution of this product by LG Electronics.

You can obtain a copy of the GPL, LGPL licences from [\*\*http://www.gnu.org/licenses/old-licenses/gpl-2.0.html\*\*](http://www.gnu.org/licenses/old-licenses/gpl-2.0.html) and [\*\*http://www.gnu.org/licenses/old-licenses/lgpl-2.1.html\*\*](http://www.gnu.org/licenses/old-licenses/lgpl-2.1.html)

This software is based in part on the work of the Independent JPEG Group copyright © 1991-1998, Thomas G. Lane.

This product includes

- Freetype library : Copyright © 2003 The FreeType Project ([\*\*www.freetype.org\*\*](http://www.freetype.org)).
- libpng library: Copyright © 2004 Glenn Randers-Pehrson
- Zlib compression library: Copyright © 1995-2002 Jean-loup Gailly and Mark Adler
- cryptographic software written by Eric Young ([\*\*ey@cryptsoft.com\*\*](mailto:ey@cryptsoft.com)).
- software written by Tim Hudson ([\*\*tjh@cryptsoft.com\*\*](mailto:tjh@cryptsoft.com)).
- software developed by the OpenSSL Project for use in the OpenSSL Toolkit. ([\*\*http://www.openssl.org\*\*](http://www.openssl.org))

This product includes other open source software.

- Copyright © David L. Mills 1992-2006
- Copyright © 1998-2003 Daniel Veillard.
- Copyright © 1998, 1999, 2000 Thai Open Source Software Centre Ltd.
- Copyright © 1990 The Regents of the University of California.
- Copyright © 1998-2005 The OpenSSL Project.

All rights reserved.

Permission is hereby granted, free of charge, to any person obtaining a copy of this software and associated documentation files (the "Software"), to deal in the Software without restriction, including without limitation the rights to use, copy, modify, merge, publish, distribute, sublicense, and/or sell copies of the Software, and to permit persons to whom the Software is furnished to do so, subject to the following conditions:

THE SOFTWARE IS PROVIDED "AS IS", WITHOUT WARRANTY OF ANY KIND, EXPRESS OR IMPLIED, INCLUDING BUT NOT LIMITED TO THE WARRANTIES OF MERCHANTABILITY, FITNESS FOR A PARTICULAR PURPOSE AND NONINFRINGEMENT. IN NO EVENT SHALL THE AUTHORS OR COPYRIGHT HOLDERS BE LIABLE FOR ANY CLAIM, DAMAGES OR OTHER LIABILITY, WHETHER IN AN ACTION OF CONTRACT, TORT OR OTHERWISE, ARISING FROM, OUT OF OR IN CONNECTION WITH THE SOFTWARE OR THE USE OR OTHER DEALINGS IN THE SOFTWARE.