

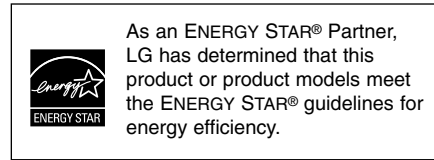

ENGLISH

DV4S2H



ENERGY STAR® is a U.S. registered mark.

No. : MFL58825949

Safety Precaution



CAUTION: TO REDUCE THE RISK OF ELECTRIC SHOCK. DO NOT REMOVE COVER (OR BACK). NO USER-SERVICEABLE PARTS INSIDE. REFER SERVICING TO QUALIFIED SERVICE PERSONNEL.

 This lightning flash with arrowhead symbol within an equilateral triangle is intended to alert the user to the presence of uninsulated dangerous voltage within the product's enclosure that may be of sufficient magnitude to constitute a risk of electric shock to persons.

 The exclamation point within an equilateral triangle is intended to alert the user to the presence of important operating and maintenance (servicing) instructions in the literature accompanying the product.

WARNING: TO PREVENT FIRE OR ELECTRIC SHOCK HAZARD, DO NOT EXPOSE THIS PRODUCT TO RAIN OR MOISTURE.

WARNING: Do not install this equipment in a confined space such as a book case or similar unit.

CAUTION: Do not block any ventilation openings. Install in accordance with the manufacturer's instructions. Slots and openings in the cabinet are provided for ventilation and to ensure reliable operation of the product and to protect it from over heating. The openings shall be never be blocked by placing the product on a bed, sofa, rug or other similar surface. This product shall not be placed in a built-in installation such as a bookcase or rack unless proper ventilation is provided or the manufacturer's instruction has been adhered to.

CAUTION: This product employs a Laser System. To ensure proper use of this product, please read this owner's manual carefully and retain it for future reference. Shall the unit require maintenance, contact an authorized service center.

Use of controls, adjustments or the performance of procedures other than those specified herein may result in hazardous radiation exposure.

To prevent direct exposure to laser beam, do not try to open the enclosure. Visible laser radiation when open. DO NOT STARE INTO BEAM.

CAUTION: The apparatus shall not be exposed to water (dripping or splashing) and no objects filled with liquids, such as vases, shall be placed on the apparatus.

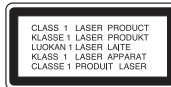

CAUTION concerning the Power Cord

Most appliances recommend they be placed upon a dedicated circuit;

That is, a single outlet circuit which powers only that appliance and has no additional outlets or branch circuits. Check the specification page of this owner's manual to be certain. Do not overload wall outlets. Overloaded wall outlets, loose or damaged wall outlets, extension cords, frayed power cords, or damaged or cracked wire insulation are dangerous. Any of these conditions could result in electric shock or fire.

Periodically examine the cord of your appliance, and if its appearance indicates damage or deterioration, unplug it, discontinue use of the appliance, and have the cord replaced with an exact replacement part by an authorized service center.

Protect the power cord from physical or mechanical abuse, such as being twisted, kinked, pinched, closed in a door, or walked upon. Pay particular attention to plugs, wall outlets, and the point where the cord exits the appliance.







To disconnect power from the mains, pull out the mains cord plug. When installing the product, ensure that the plug is easily accessible.

Manufactured under license from Dolby Laboratories. "Dolby" and the double-D symbol are trademarks of Dolby Laboratories.

HDMI, the HDMI logo and High-Definition Multimedia Interface are trademarks or registered trademarks of HDMI licensing LLC.

"DVD Logo" is a trademark of DVD Format/Logo Licensing Corporation.

Contents	Safety Precaution	2
	Types of Playable Discs	3
	Hooking up the unit	4-6
	Remote Control	7
	Main Unit	8
	Adjust the settings	9-10
	Displaying Disc Information	10
	Playing a Disc	11-12
	Playing a DivX movie file	12
	Listening to Music Disc or files	13
	Viewing photo files	13-14
	Using an USB Flash Drive	14
Language Codes	15	
Area Codes	15	
Troubleshooting	16	
Specifications	16	

Types of Playable Discs	
Type	Logo
DVD-VIDEO: Discs such as movies that can be purchased or rented.	
DVD-R: Video mode and finalized only	
DVD-RW: VR mode, Video mode and finalized only	
DVD+R: Video mode only	
DVD+RW: Video mode only	
Audio CD: Music CDs or CD-R/CD-RW in music CD format that can be purchased.	
This unit plays DVD±R/RW and CD-R/RW that contains audio titles, DivX, MP3, WMA and/or JPEG files. Some DVD±RW/DVD±R or CD-RW/CD-R cannot be played on this unit due to the recording quality or physical condition of the disc, or the characteristics of the recording device and authoring software.	

About the  Symbol Display

“  ” may appear on your TV display during operation and indicates that the function explained in this owner’s manual is not available on that disc.

Regional Codes

This unit has a regional code printed on the rear of the unit. This unit can play only DVD discs labeled same as the rear of the unit or “ALL”.

- Most DVD discs have a globe with one or more numbers in it clearly visible on the cover. This number must match your unit’s regional code or the disc cannot play.
- If you try to play a DVD with a different regional code from your player, the message “Check Regional Code” appears on the TV screen.

Copyrights

It is forbidden by law to copy, broadcast, show, broadcast via cable, play in public, or rent copyrighted material without permission. This product features the copy protection function developed by Macrovision. Copy protection signals are recorded on some discs. When recording and playing the pictures of these discs picture noise will appear. This product incorporates copyright protection technology that is protected by U.S. patents and other intellectual property rights. Use of this copyright protection technology must be authorized by Macrovision, and is intended for home and other limited viewing uses only unless otherwise authorized by Macrovision. Reverse engineering or disassembly is prohibited.

CONSUMERS SHOULD NOTE THAT NOT ALL HIGH DEFINITION TELEVISION SETS ARE FULLY COMPATIBLE WITH THIS PRODUCT AND MAY CAUSE ARTIFACTS TO BE DISPLAYED IN THE PICTURE. IN CASE OF 525 OR 625 PROGRESSIVE SCAN PICTURE PROBLEMS, IT IS RECOMMENDED THAT THE USER SWITCH THE CONNECTION TO THE ‘STANDARD DEFINITION’ OUTPUT. IF THERE ARE QUESTIONS REGARDING OUR TV SET COMPATIBILITY WITH THIS MODEL 525p AND 625p UNIT, PLEASE CONTACT OUR CUSTOMER SERVICE CENTER.

Hooking up the unit

Audio and Video Connection

The unit Audio/Video jacks are color coded (yellow for video, red for right audio and white for left audio). If your TV has only one input for audio (mono), connect it to the left (white) audio jack on the unit.

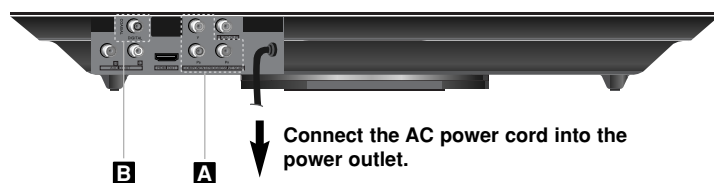
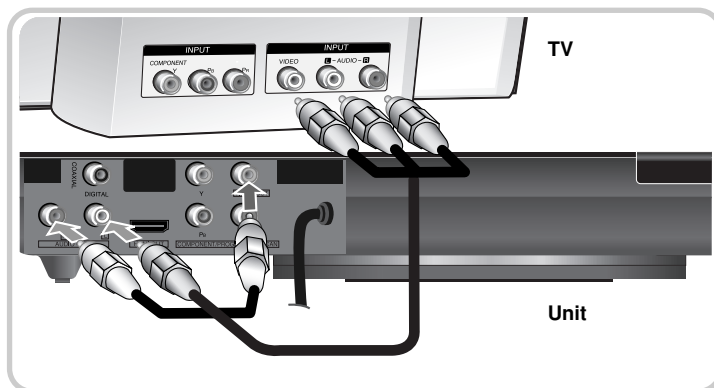

4

Hooking up the unit - more you can do

A Component Video Connections

Connect the COMPONENT/PROGRESSIVE SCAN OUT jacks on the unit to the corresponding input jacks on your TV using a YPbPr cable.

- You will still need to connect the left and right audio cables (red and white) to the TV, or digital audio cable to your stereo.

Resolution Setting

- You can change the resolution for component video output. Press RESOLUTION repeatedly to select the desired resolution - 576i(480i), 576p(480p), 720p, 1080i, 1080p.
- For 720p, 1080p and 1080i resolution on the component video output, only non-copy protected discs can be played back. If the disc is copy protected, it will be displayed at the 576p(480p) or 576i(480i) resolution.
- Depending on your TV, some of the resolution settings may result in the picture disappearing or an abnormal picture appearing. In this case, press RESOLUTION repeatedly until the picture re-appears.

B Digital Audio Output Connection

Connect one of the unit's DIGITAL AUDIO OUT (COAXIAL) jack to the corresponding jack on your amplifier.

- If the audio format of the digital output does not match the capabilities of your amplifier, the amplifier will produce a strong, distorted sound or no sound at all.
- To see the audio format of the current disc in the on-screen display, press AUDIO.
- This unit does not perform internal (2 channel) decoding of a DTS sound track. To enjoy DTS multi channel surround, you must connect this unit to a DTS compatible amplifier via one of this unit's digital audio outputs.

HDMI Connection

Connect the HDMI OUT jack on the unit to the HDMI input jack on an HDMI compatible TV using an HDMI cable.

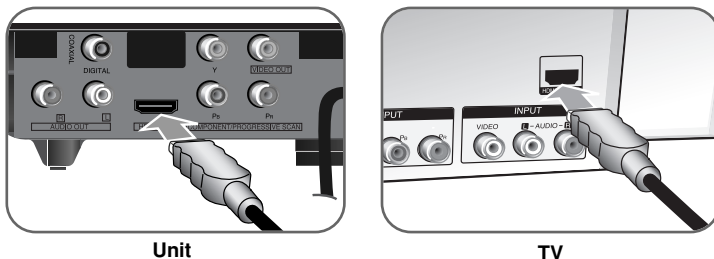

Resolution Setting

You can change the resolution for HDMI output. Press RESOLUTION repeatedly to select the desired resolution - 576i(480i), 576p(480p), 720p, 1080i, 1080p. The resolution may not be selected depending on the connection or TV.

Note for 1080p resolution

The unit is able to provide a 1080p full HD image to most 1080p-capable TVs in the market today. However, there are some 1080p TVs available from certain companies that are limited in the types of 1080p images that can be accepted. Specifically, 1080p-capable TVs that don't accept images in 60Hz can't display an image from this unit.

About HDMI

HDMI (High Definition Multimedia Interface) supports both video and audio on a single digital connection for use with DVD Players, Set-Top Boxes, and other AV devices. HDMI was developed to provide the technologies of HDCP (High-bandwidth Digital Content Protection).

HDCP is used to protect digital content transmitted and received.

HDMI has the capability to support standard, enhanced or high-definition video plus standard to multi-channel surround-sound audio, HDMI features include uncompressed digital video, a bandwidth of up to 5 gigabytes per second, one connector (instead of several cables and connectors), and communication between the AV source and AV devices such as DTVs.

Notes on HDMI connection

- If your TV is not capable of handling 96 kHz sampling frequency, set the [Sampling Freq.] option to [48 kHz] on the setup menu (See page 9).
- If your TV is not equipped with Dolby Digital and MPEG decoder, set the [Dolby Digital] and [MPEG] options to [PCM] on the setup menu (See page 9).
- Depending on your TV, some of the resolution settings may result in the picture disappearing or an abnormal picture appearing. In this case, press RESOLUTION repeatedly until the picture re-appears.
- Changing the resolution when the unit is connected with HDMI connector may result in malfunctions. To solve the problem, turn off the unit and then turn it on again.
- When you connect a HDMI or DVI compatible device make sure of the following:
 - Try switching off the HDMI/DVI device and this unit. Next, switch on the HDMI/DVI device and leave it for around 30 seconds, then switch on this unit.
 - The connected device's video input is set correctly for this unit.
 - The connected device is compatible with 720X576i(480i), 720X576p(480p), 1280X720p, 1920X1080i or 1920X1080p video input.
 - The 1080p, 720p and 576p(480p) resolutions are the progressive scan applied resolution.
- Not all HDCP-compatible DVI devices will work with this unit.
 - The picture will not be displayed properly with non-HDCP device.

How to attach the Cable Cover

If you want to, install it as shown below.

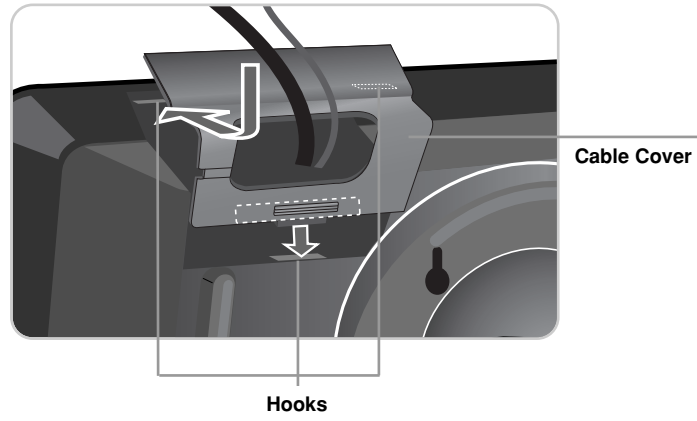

Using the round shaped support

To set up this unit on the table or other level space, rotate the round shaped support on the back of the unit to the arrow direction as show below.

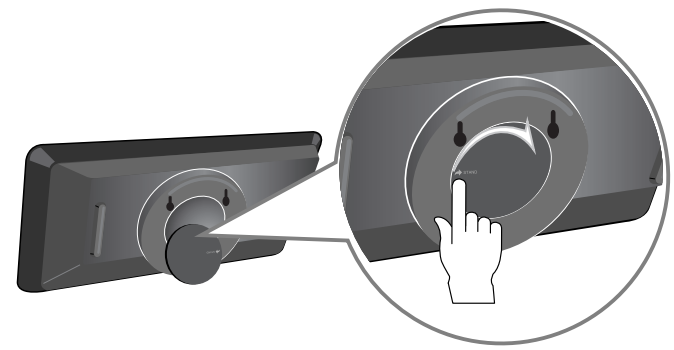

6

Wall Mounting

If you want to, you can mount the unit on a wall.

You need to have hooks available that snugly fit into the hanging holes in the back of the unit. Screw your hooks into the wall.

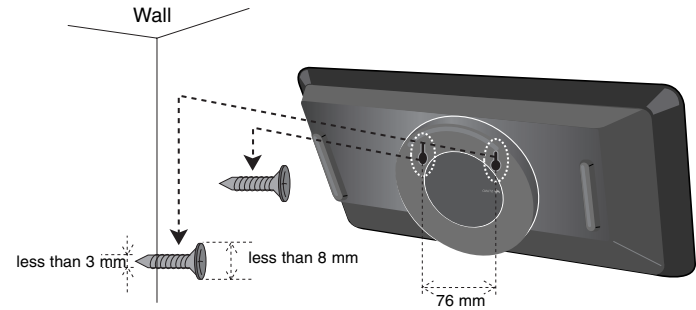

Ensure that the unit locks onto the hooks and that the hooks are strong enough to support the weight before releasing the hand.

Remote control



1

2

3

4

1

POWER (⏻) : Switches the unit ON or OFF.
OPEN/CLOSE (⏮) : Opens and closes the disc tray.
AUDIO (🔊) : Selects an audio language or audio channel.
SUBTITLE (🗣️) : Selects a subtitle language.
ANGLE (📷) : Selects a DVD camera angle, if available.
SETUP : Accesses or exits the setup menu.

2

SCAN (⏮ / ⏭) : Search backward or forward.
SKIP (⏮ / ⏭) : Go to next or previous chapter/track/File.
PAUSE/STEP (⏸) : Pauses playback temporarily/press repeatedly for frame-by-frame playback.
PLAY (▶) : Starts playback.
STOP (■) : Stops playback.

3

DVD MENU : Accesses the DVD menu.
TITLE : Accesses the disc's title menu, if available.
<> v ^ : Navigates the menus.
ENTER (⊙) : Confirms menu selection.
DISPLAY : Accesses On-Screen Display.
RETURN (↶) : Press to move backwards in the menu or exit the menu. Change the USB mode.

4

Numerical buttons: Selects numbered items in a menu.
CLEAR : Removes a track number on the Program List.
PROGRAM : Enters the program edit mode.
A-B : Repeats a section.
REPEAT : Repeats a chapter, track, title or all.
ZOOM : Enlarges video image.
RESOLUTION : You can change the resolution depending on your TV.

Put the battery into the Remote Control

Pinch the battery holder clip together then pull the tab to remove the battery holder. Insert the battery with the + facing in the same direction as the + on the battery holder. Replace the battery holder with battery into the Remote Control unit making sure that it is fully inserted.

- Replace Remote Control unit battery with 3V micro lithium cells such as CR. 2025 or its equivalent.
- Dispose of battery safety in accordance with local laws. Do not dispose of in fire.

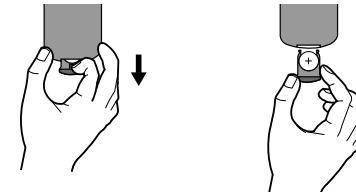

Warning for replaceable lithium battery

- Danger of explosion if battery incorrectly replaced.
- Replace only with the same type battery.
- Additional warning marking close to the battery if intended to be replaced by users.

Warning : The battery used in this device may present a fire or chemical burn hazard if mistreated. Do not recharge, disassemble, incinerate, or heat above 100 °C (212 °F). Replace the battery with Matsushita Elec. Ind. Co., Ltd. (Panasonic), part no. CR. 2025 only. Use of another battery may present a risk of fire or explosion. Dispose of used batteries. Keep batteries away from children. Do not disassemble or dispose of in fire.

Main Unit

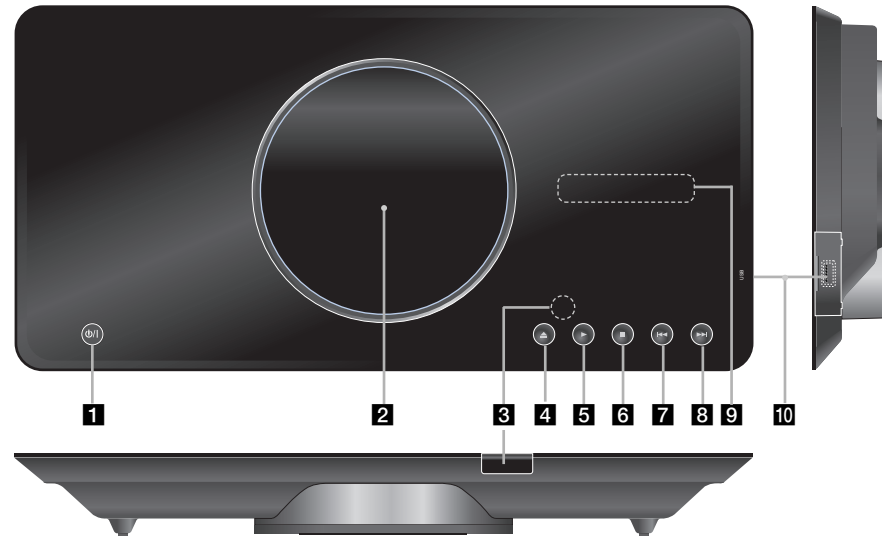

1 **⏻/⏻ (Power)**
Turn the unit ON or OFF.

2 **Disc Tray**
Insert a disc here.

3 **Remote sensor**
Point the remote control here.

4 **⏮ (Open / Close)**
Opens or closes the disc tray.

5 **▶ (Play)**
Starts playback.

6 **■ (Stop)**
Stops playback.

7 **⏮ (Skip)**
Returns to the beginning of current chapter or track or go to the previous chapter, track or File.

8 **⏭ (Skip)**
Go to next chapter, track or File.

9 **Display window**
Shows the current status of the unit.

10 **USB Port**
Connect an USB Flash Drive.

Precautions in using the touch buttons

- Use the touch pad with clean and dry hands.
- Do not press the buttons on the touch pad with too much force.
- Do not touch the button on the touch pad with any conductive material such as metallic object. It may cause a malfunction.

Adjust the settings	
	ON REMOTE
1 Display setup menu:	SETUP
2 Select a desired option on the first level:	▲▼
3 Move to second level:	▶
4 Select a desired option on the second level:	▲▼
5 Move to third level:	▶
6 Change the setting:	▲▼ / ENTER

Adjust the settings - more you can do

When you turn on for the first time (optional)

The menu for a language selection will appear when you turn on the unit for the first time. You must select a language to use the unit. Use ▲▼◀▶ to select a language then press **ENTER** and the confirm menu will appear. Use ◀▶ to select [Enter] then press **ENTER**.

Adjust the language settings

Menu Language – Select a language for the Setup menu and on-screen display.

Disc Audio/Subtitle/Menu – Select a language for the Disc Audio/Subtitle/Menu.

- [Original]: Refers to the original language in which the disc was recorded.
- [Other]: To select another language, press number buttons then **ENTER** to enter the corresponding 4-digit number according to the language code list. (see page 15) If you make a mistake while entering number, press **CLEAR** to delete numbers then correct it.
- [Off] (for Disc Subtitle): Turn off Subtitle.

Adjust the display settings

TV Aspect – Select which screen aspect to use based on the shape of your TV screen.

- [4:3]: Select when a standard 4:3 TV is connected.
- [16:9]: Select when a 16:9 wide TV is connected.

Display Mode – If you selected 4:3, you'll need to define how you would like widescreen programs and films to be displayed on your TV screen.

- [Letterbox]: This displays a widescreen picture with black bands at the top and bottom of the screen.
- [Panscan]: This fills the entire 4:3 screen, cropping the picture as necessary.

Adjust the audio settings

Dolby Digital / DTS / MPEG – Selects the type of digital audio signal when using the DIGITAL AUDIO OUT jack.

- [Bitstream]: Select this when you connect this unit's DIGITAL AUDIO OUT jack to an amplifier with a built-in Dolby Digital, DTS or MPEG decoder.
- [PCM] (for Dolby Digital / MPEG): Select this when you connect this unit's DIGITAL AUDIO OUT jack to an amplifier without a built-in Dolby Digital or MPEG decoder.
- [Off] (for DTS): Select this when you connect this unit's DIGITAL AUDIO OUT jack to an amplifier without a built-in DTS decoder.

Sample Freq. (Frequency) – Selects the sampling frequency of the audio signal.

- [48 KHz]: The audio signals are always converted to 48 kHz.
- [96 KHz]: The audio signals are output in their original format.

DRC (Dynamic Range Control) – Make the sound clear when the volume is turned down (Dolby Digital only). Set to [On] for this effect.

Vocal – Set to [On] only when a multi-channel karaoke DVD is playing. The karaoke channels on the disc mix into normal stereo sound.

Adjust the lock settings

You must set the [Area Code] option to use the lock options. Select [Area Code] option then press **▶**. Enter a 4-digit password then press **ENTER**. Enter it again then press **ENTER** to verify. If you make a mistake while entering number, press **CLEAR** then correct it.

If you forget your password you can reset it. First, remove the disc in the unit. Display setup menu then input the 6-digit number "210499". The "P CLR" appear in the display window and the password is deleted.

Rating – Select a rating level. The lower the level, the stricter the rating. Select [Unlock] to deactivate the rating.

Password – Sets or changes the password for lock settings.

[New]: Enter a new 4-digits password using the numerical buttons then press **ENTER**. Enter the password again to confirm.

[Change]: Enter the new password twice after entering the current password.

Area Code – Select a code for a geographic area as the playback rating level. This determines which area's standards are used to rate DVDs controlled by the parental lock. (See page 15)

Adjust the others settings

B.L.E. (Black Level Expansion) – To select the black level of playback pictures. Set your preference and monitor's ability.

DivX(R) VOD – DivX® is a digital video format created by DivX, Inc. This is an official DivX Certified device that plays DivX video in HD resolutions. This DivX Certified ® device must be registered in order to play DivX Video-on-Demand (VOD) content. First generate the DivX VOD registration code for your device and submit it during the registration process. [Important: DivX VOD content is protected by a DivX DRM (Digital Rights Management) system that restricts playback to registered DivX Certified devices. If you try to play DivX VOD content not authorized for your device, the message "Authorization Error" will be displayed and your content will not play.] Learn more at www.divx.com/vod.







Press **ENTER** when [Select] icon is highlighted and you can view the registration code of the unit. All the downloaded videos from DivX® VOD can only be played back on this unit.

Displaying Disc Information

	ON REMOTE
1 Press DISPLAY :	DISPLAY
2 Select a item:	▲▼
3 Adjust the Display menu settings:	◀▶ / ENTER
4 To return the exit:	DISPLAY

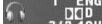
Displaying Disc Information - more you can do

You can select an item by pressing **▲▼** and change or select the setting by pressing **◀▶**.

 1 / 6	Current title (or track) number/total number of titles (or tracks)
 5 / 42	Current chapter number/total number of chapters
 0:13:45	Elapsed playing time
 1 ENG D D D	Selected audio language or channel
 3 / 2 1CH	Selected subtitle
 OFF	Selected subtitle
 1 / 1	Selected angle/total number of angles

Symbol Used in this Manual

ALL	All discs and file listed below	ACD	Audio CDs
DVD	DVD and finalized DVD±R/RW	CD-G	CD-G discs
MP3	MP3 files	DivX	DivX files
WMA	WMA files		

Playing a Disc

	ON REMOTE
1 Open the disc tray:	▲ OPEN/CLOSE
2 Insert a Disc:	-
3 Close the disc tray:	▲ OPEN/CLOSE
4 Start playback:	▶ PLAY
5 To stop playback:	■ STOP

Playing a Disc - more you can do

Stops the playback

The unit records the stopped point depending on the disc. "■■■" appears on the screen briefly. Press **PLAY** (▶) to resume playback (from the scene point). If you press **STOP** (■) again or unload the disc ("■" appears on the screen), the unit will clear the stopped point.

(■■■ = Resume Stop, ■ = Complete Stop)

The resume point may be cleared when a button is pressed (for example : POWER, OPEN/CLOSE, etc).

Playing a DVD that has a menu **DVD**

Most DVD now have menus which load first before the film begins to play. You can navigate these menus using ▲▼◀▶ or number button to highlight an option. Press **ENTER** to select.

Playing a DVD VR disc

This unit will play DVD-RW disc that is recorded using the Video Recording (VR) format. When you insert a disc DVD VR disc, the menu will appear on the screen. Use ▲▼ to select a title then press **PLAY** (▶). To display DVD-VR menu, press **DVD MENU** or **TITLE**.

Some DVD-VR disc are made with CPRM data by DVD RECORDER. Player does not support these kinds of discs.

Skip to the next/previous chapter/track **ALL**

Press **SKIP** (▶▶) to move to the next chapter/track.
Press **SKIP** (◀◀) to return to the beginning of the current chapter/track.
Press **SKIP** (◀◀) twice briefly to step back to the previous chapter/track.

Pause a playback **ALL**

Press **PAUSE/STEP** (||) to pause playback. Press **PLAY** (▶) to continue playback.

Frame-by-Frame playback **DVD DivX**

Press **PAUSE/STEP** (||) repeatedly to play Frame-by-Frame playback.

Playing repeatedly **ALL**

Press **REPEAT** repeatedly to select an item to be repeated. The current title, chapter or track will be played back repeatedly. To return to normal playback, press **REPEAT** repeatedly to select [Off].

Fast forward or fast reverse

DVD DivX ACD WMA MP3

Press **SCAN** (◀◀ or ▶▶) to play fast forward or fast reverse during playback. You can change the various playback speed by pressing **SCAN** (◀◀ or ▶▶) repeatedly. Press **PLAY** (▶) to continue play at normal speed.

Repeating a specific portion (A-B) **DVD DivX ACD**

Press **A-B** at the beginning of the portion you wish to repeat and again at the end of the portion. Your selected portion will be repeated continually. To return to normal playback, press **A-B** to select [Off].

Selecting a subtitle language **DVD DivX**

During playback, press **SUBTITLE** (☒) repeatedly to select a desired subtitle language.

Watching from a different angle **DVD**

If the angle indicator appears on the screen for a moment, you can select a different camera angle by pressing **ANGLE** (☒) repeatedly.

Hearing a different audio **DVD DivX CD-G**

During playback, press **AUDIO** (☒) repeatedly to switch between the available audio languages, channels or encoding methods.

Slow down the playing speed **DivX DVD (Forward only)**

While playback is paused, press **SCAN** (▶▶) to slow down forward playback. You can change the various playback speed by pressing **SCAN** (▶▶) repeatedly. Press **PLAY** (▶) to continue play at normal speed.

Watching a enlarged video image **DVD** **DivX**

During playback or pause mode, press **ZOOM** repeatedly to select zoom mode. You can move through the zoomed picture using **▲▼◀▶** buttons. Press **CLEAR** to exit.

Viewing the title menu **DVD**

Press **TITLE** to display the disc's title menu, if available.

Viewing the DVD menu **DVD**

Press **DVD MENU** to display the disc menu, if available.

Starting play from selected time **DVD** **DivX**

Searches for the starting point of entered time code. Press **DISPLAY** then select clock icon. Enter a time then press **ENTER**. For example, to find a scene at 1 hours, 10 minutes, and 20 seconds, enter "11020" and press **ENTER**. If you enter the wrong number, press **CLEAR** to enter again.

Last Scene Memory **DVD** **ACD**

This unit memorizes last scene from the last disc that is viewed. The last scene remains in memory even if you remove the disc from the player or switch off the unit. If you load a disc that has the scene memorized, the scene is automatically recalled.

Screen Saver

The screen saver appears when you leave the unit in Stop mode for about five minutes. If the Screen Saver is displayed for five minutes, the unit automatically turns itself off.

System Select

You must select the appropriate system mode for your TV system. Remove any disc that might be in the unit, press and hold **PAUSE/STEP (II)** for more than five seconds to be able to select a system (PAL, NTSC).

Mixed disc or USB Flash Drive – DivX, MP3/WMA and JPEG

When playing a disc or USB Flash Drive contained with DivX, MP3/WMA and JPEG files together, you can select which menu of files you would like to play by pressing **TITLE**.

Playing a DivX movie file

You can enjoy the high quality images such as HD DivX file (720p) with this unit.

	ON REMOTE
1 Open the disc tray:	▲ OPEN/CLOSE
2 Insert a disc:	-
3 Close the disc tray:	▲ OPEN/CLOSE
4 Select a movie file from the menu:	▲▼, DVD MENU
5 Start playback:	▶ PLAY
6 To stop playback:	■ STOP

Playing a DivX movie file - more you can do**Changing the character set to display DivX® subtitle correctly**

Press and hold **SUBTITLE** for 3 seconds during playback. The language code will appear. Press **◀▶** to select another language code until the subtitle is displayed properly and then press **ENTER**.

DivX file requirement

DivX file compatibility with this player is limited as follows:

- Available resolution size: 1280x720 (W x H) pixel
- The file names of DivX and subtitle are limited to 45 characters
- DivX file extensions: ".avi", ".mpg", ".mpeg"
- Playable DivX subtitle: SubRip (.srt / .txt), SAMI (.smi), SubStation Alpha (.ssa/.txt), MicroDVD (.sub/.txt), SubViewer 2.0 (.sub/.txt), TMPlayer (.txt), DVD Subtitle System (.txt)
- Playable Codec format: "DIVX3.xx", "DIVX4.xx", "DIVX5.xx", "MP43", "3IVX"
- Only the playback function is supported with DivX 6.0 in the unit
- Playable Audio format: "Dolby Digital", "PCM", "MP3", "WMA"
- Sampling frequency: within 8 - 48 kHz (MP3), within 32 - 48 kHz (WMA)
- Bit rate (MP3/WMA): within 8 - 320 kbps (MP3), within 32 - 192 kbps (WMA)
- Bit rate (DivX file): less than 7.2 Mbps (CD-R/RW)
less than 9.7 Mbps (USB Flash Drive, DVD±R/RW)
- CD-R/RW, DVD±R/RW Format: ISO 9660
- Maximum Files/Disc: Less than 600 (total number of files and folders)
- This unit can support a DivX file size up to 4GB.

Listening to Music Disc or files

	ON REMOTE
1 Open the disc tray:	▲ OPEN/CLOSE
2 Insert a disc:	-
3 Close the disc tray:	▲ OPEN/CLOSE
4 Select a music from the menu:	▲▼, DVD MENU
5 Start playback:	▶ PLAY
6 To stop playback:	■ STOP

Listening to Music Disc or files - more you can do

Creating your own program

You can play the contents of a disc in the order you want by arranging the order of the musics on the disc. To add a music(s) on the program list, press **PROGRAM** to enter the program edit mode (Ⓢ) mark appears on the menu. Select a desired music on the [List] then press **ENTER** to add the music to the program list. Select a music from the program list then press **ENTER** to start programmed playback. To clear a music from the program list, select the music you want to clear then press **CLEAR** in program edit mode. To clear all music from the program list, select [Clear All] then press **ENTER** in program edit mode. The program is cleared when the disc is removed or the unit is turned off.

Playing an CD-G disc

Once you insert an CD-G disc, a menu appears on the screen. Use ▲▼ to select a track then press **PLAY** (▶). To display the CD-G menu during playback, press **STOP** (■) twice. You can display the setup menu by pressing **SETUP** only when CD-G menu appears on the TV screen.

Displaying file information (ID3 TAG)

While playing a MP3 file containing file information, you can display the information by pressing **DISPLAY** repeatedly.

MP3/WMA music file requirement

MP3/WMA compatibility with this unit is limited as follows:

- File extensions: ".mp3", ".wma"
- Sampling frequency: within 8 - 48 kHz (MP3), within 32 - 48kHz (WMA)
- Bit rate: within 8 - 320kbps (MP3), within 32 - 192kbps (WMA)
- CD-R/RW, DVD±R/RW Format: ISO 9660
- Maximum Files/Disc: Less than 600 (total number of files and folders)

Viewing photo files

	ON REMOTE
1 Open the disc tray:	▲ OPEN/CLOSE
2 Insert a disc:	-
3 Close the disc tray:	▲ OPEN/CLOSE
4 Select a photo file on the menu:	▲▼, DVD MENU
5 Display the selected file in full screen:	▶ PLAY
6 To return to the menu:	■ STOP

Viewing photo files - more you can do

Viewing photo files as a slide show

Use ▲▼ ◀▶ to highlight (■) icon then press **ENTER** to start slide show. You can change slide show speed using ◀▶ when (■) icon is highlighted.

Skip to the next/previous photo

Press **SKIP** (◀◀ or ▶▶) to view the previous/next photo.

Rotate a photo

Use ▲▼ to rotate the photo in full screen counterclockwise or clockwise while viewing a photo in full screen.

Pause a slide show

Press **PAUSE/STEP** (||) to pause a slide show. Press **PLAY** (▶) to continue the slide show.

Listening to music during slide show

You can listen to music during slide show, if the disc contain music and photo files together. Use ▲▼◀▶ to highlight (🎵) icon then press **ENTER** to start slide show.

Watching a enlarged photo image

While viewing a photo in full screen, press **ZOOM** repeatedly to select zoom mode. You can move through the zoomed photo using ▲▼◀▶ buttons. Press **CLEAR** to exit.

Photo file requirement

JPEG file compatibility with this unit is limited as follows:

- File extensions: ".jpg"
- Photo size: Less than 2MB recommended
- CD-R/RW, DVD±R/RW Format: ISO 9660
- Maximum Files/Disc: Less than 600 (total number of files and folders)

Using an USB Flash Drive

You can play MP3/WMA/JPEG/DivX files in the USB Flash Drive with version 2.0 / 1.1.

	ON REMOTE
1 Connect an USB Flash Drive to the USB port on the unit:	-
2 Display the menu screen in stop mode:	↶ RETURN
3 Select a file:	▲▼, DVD MENU
4 Play the file:	▶ PLAY
5 Remove the USB Flash Drive:	-

Notes an USB Flash Drive

- You can switch USB and DISC mode by pressing **RETURN** (↶) only in stop mode.
- Do not extract the USB device in operating.
- Regular back up is recommended to prevent data loss.
- If you use an USB extension cable or USB HUB, the USB device might not be recognized.
- Music files (MP3/WMA), photo files (JPEG) and DivX files can be played. For details of operations on each files, refer to relevant pages.
- This unit is not supported when the total number of files is more than 600.
- The USB function of this unit does not support all kinds of USB devices.
- Digital camera and mobile phone are not supported.
- USB port of the unit can not be connected to PC. The unit can not be used as a storage device.

Language Codes

Use this list to input your desired language for the following initial settings: Disc Audio, Disc Subtitle, Disc Menu.

Language	Code	Language	Code	Language	Code	Language	Code	Language	Code	Language	Code
Afar	6565	Croatian	7282	Hausa	7265	Lingala	7678	Quechua	8185	Tajik	8471
Afrikaans	6570	Czech	6783	Hebrew	7387	Lithuanian	7684	Rhaeto-Romance	8277	Tamil	8465
Albanian	8381	Danish	6865	Hindi	7273	Macedonian	7775	Rumanian	8279	Telugu	8469
Ameharic	6577	Dutch	7876	Hungarian	7285	Malagasy	7771	Russian	8285	Thai	8472
Arabic	6582	English	6978	Icelandic	7383	Malay	7783	Samoan	8377	Tonga	8479
Armenian	7289	Esperanto	6979	Indonesian	7378	Malayalam	7776	Sanskrit	8365	Turkish	8482
Assamese	6583	Estonian	6984	Interlingua	7365	Maori	7773	Scots Gaelic	7168	Turkmen	8475
Aymara	6588	Faroese	7079	Irish	7165	Marathi	7782	Serbian	8382	Twi	8487
Azerbaijani	6590	Fiji	7074	Italian	7384	Moldavian	7779	Serbo-Croatian	8372	Ukrainian	8575
Bashkir	6665	Finnish	7073	Japanese	7465	Mongolian	7778	Shona	8378	Urdu	8582
Basque	6985	French	7082	Kannada	7578	Nauru	7865	Sindhi	8368	Uzbek	8590
Bengali; Bangla	6678	Frisian	7089	Kashmiri	7583	Nepali	7869	Singhalese	8373	Vietnamese	8673
Bhutani	6890	Galician	7176	Kazakh	7575	Norwegian	7879	Slovak	8375	Volapük	8679
Bihari	6672	Georgian	7565	Kirghiz	7589	Oriya	7982	Slovenian	8376	Welsh	6789
Breton	6682	German	6869	Korean	7579	Panjabi	8065	Spanish	6983	Wolof	8779
Bulgarian	6671	Greek	6976	Kurdish	7585	Pashto, Pushto	8083	Sudanese	8385	Xhosa	8872
Burmese	7789	Greenlandic	7576	Laotian	7679	Persian	7065	Swahili	8387	Yiddish	7473
Byelorussian	6669	Guarani	7178	Latin	7665	Polish	8076	Swedish	8386	Yoruba	8979
Chinese	9072	Gujarati	7185	Latvian, Lettish	7686	Portuguese	8084	Tagalog	8476	Zulu	9085

Area Codes

Choose a area code from this list.

Area	Code	Area	Code	Area	Code	Area	Code	Area	Code	Area	Code
Afghanistan	AF	Costa Rica	CR	Greenland	GL	Maldives	MV	Paraguay	PY	Sri Lanka	LK
Argentina	AR	Croatia	HR	Hong Kong	HK	Mexico	MX	Philippines	PH	Sweden	SE
Australia	AU	Czech Republic	CZ	Hungary	HU	Monaco	MC	Poland	PL	Switzerland	CH
Austria	AT	Denmark	DK	India	IN	Mongolia	MN	Portugal	PT	Taiwan	TW
Belgium	BE	Ecuador	EC	Indonesia	ID	Morocco	MA	Romania	RO	Thailand	TH
Bhutan	BT	Egypt	EG	Israel	IL	Nepal	NP	Russian Federation	RU	Turkey	TR
Bolivia	BO	El Salvador	SV	Italy	IT	Netherlands	NL	Saudi Arabia	SA	Uganda	UG
Brazil	BR	Ethiopia	ET	Jamaica	JM	Netherlands Antilles	AN	Senegal	SN	Ukraine	UA
Cambodia	KH	Fiji	FJ	Japan	JP	New Zealand	NZ	Singapore	SG	United States	US
Canada	CA	Finland	FI	Kenya	KE	Nigeria	NG	Slovak Republic	SK	Uruguay	UY
Chile	CL	France	FR	Kuwait	KW	Norway	NO	Slovenia	SI	Uzbekistan	UZ
China	CN	Germany	DE	Libya	LY	Oman	OM	South Africa	ZA	Vietnam	VN
Colombia	CO	Great Britain	GB	Luxembourg	LU	Pakistan	PK	South Korea	KR	Zimbabwe	ZW
Congo	CG	Greece	GR	Malaysia	MY	Panama	PA	Spain	ES		

Troubleshooting

Symptom	Cause	Correction
No power.	The power cord is disconnected.	Plug the power cord into the wall outlet securely.
The power is on, but the unit does not work.	No disc is inserted.	Insert a disc.
No picture.	The TV is not set to receive the signal from the unit.	Select the appropriate video input mode on the TV.
	The video cable is not connected securely.	Connect the video cable securely.
No sound.	The equipment connected with the audio cable is not set to receive the signal from the unit.	Select the correct input mode of the audio amplifier.
	The AUDIO options are set to the wrong position.	Set the AUDIO settings to the correct position.
The unit does not start playback.	An unplayable disc is inserted.	Insert a playable disc. (Check the disc type and regional code.)
	The rating level is set.	Change the rating level.
The remote control does not work properly.	The remote control is not pointed at the remote sensor on the unit.	Point the remote control at the remote sensor of the unit.
	The remote control is too far from the unit.	Operate the remote control closer to the unit.

Specifications

General

Power requirements	AC 200-240 V, 50/60 Hz
Power consumption	8W
Dimensions (Approx.)	430 x 52 x 212 (W x H x D)
Net Weight (Approx.)	1.4 kg
Operating temperature	5 °C to 35 °C
Operating humidity	5 % to 90 %
Laser	Semiconductor laser
Signal system	PAL / NTSC

Inputs

USB IN	4 pin (USB 2.0, 1.1 standard)
--------	-------------------------------

Outputs

Video Output	1.0 V (p-p), 75 Ω, sync negative, RCA jack (L, R) x 1
Component Video Output	(Y) 1.0 V (p-p), 75 Ω, sync negative, RCA jack x 1 (Pb)/(Pr) 0.7 V (p-p), 75 Ω, RCA jack x 2
HDMI Output	19 pin (HDMI standard, Type A)
Audio Output	2.0 Vrms (1 KHz, 0 dB), 600 Ω, RCA jack (L, R) x 1
Digital Output (Coaxial)	0.5 V (p-p), 75 Ω, RCA jack x 1

Accessories

Video/Audio cable, Remote Control, Lithium Battery

Designs and specifications are subject to change without prior notice.