



## LCD TV | PLASMA TV OWNER'S MANUAL

### LCD TV MODELS

42LB7RF\*  
47LB7RF\*  
47LY3RF\*  
52LB9RF\*  
47LB9R\*

### PLASMA TV MODELS

60PY3RF\*  
60PC4R\*

Please read this manual carefully before operating your set.  
Retain it for future reference.  
Record model number and serial number of the set.  
Refer to the label on the back cover and quote this information.  
To your dealer when requiring service.

**1080P**  
FULL HD

ONLY 42LB7RF\*  
47LB7RF\*  
47LY3RF\*  
52LB9RF\*  
60PY3RF\*



# ACCESSORIES

Ensure that the following accessories are included with your TV. If an accessory is missing, please contact the dealer where you purchased the product.

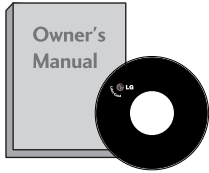

Owner's Manual



Batteries



Power Cord

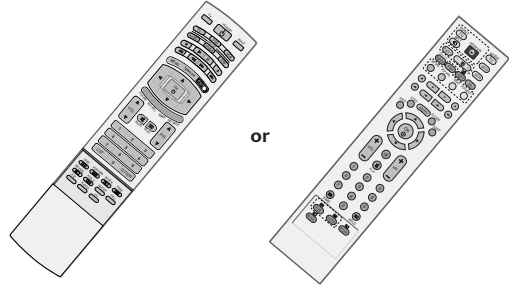

or

Remote Control

## For 60PC4R\* models

This feature is not available for all models.



2- Wall brackets  
2- TV brackets



2- TV Bracket Bolts

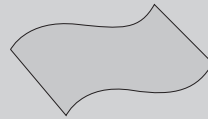

Polishing Cloth  
Polishing cloth for use on the screen

\*Lightly wipe any stains or fingerprints on the surface of the TV with the polishing cloth.

Do not use excessive force. This may cause scratching or discolouration.

## For 60PY3RF\* models

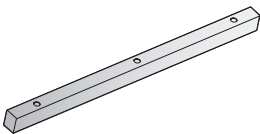

Desk-type stand  
fixture protection cover  
Refer to p. 14



2-Rubber cap  
Refer to p. 13



3-bolts  
Refer to p. 14

This feature is not available for all models.



2- TV Brackets  
2- Wall Brackets



2- TV Bracket Bolts

## LCD TV models



or



Cable Management

Except 47LB9R\*, 52LB9RF\*



4-bolts for stand assembly  
See below for detail information.  
(Refer to p.8)

This feature is not available for all models.



Twister Holder  
Arrange the wires with the  
twister holder.



2- TV Brackets  
2- Wall Brackets



2- TV Bracket Bolts

# CONTENTS

ACCESSORIES .....	1
-------------------	---

## PREPARATION

Front Panel Controls .....	4
Back Panel Information .....	6
Stand Installation .....	8
Swivel Stand .....	9
Attaching the TV to a Wall .....	10
Back Cover for Wire Arrangement.....	11
Desktop Pedestal Installation .....	13
Wall Mount: Horizontal installation .....	14
Antenna Connection.....	15

## EXTERNAL EQUIPMENT SETUP

HD Receiver Setup .....	16
DVD Setup.....	19
VCR Setup.....	22
Other A/V Source Setup .....	25
PC Setup.....	26
- Screen Setup for PC Mode .....	29
AV Output Setup .....	33
External Stereo Setup .....	33

## WATCHING TV / PROGRAMME CONTROL

Remote Control Key Functions.....	34
Turning on the TV .....	38
Programme Selection .....	38
Volume Adjustment.....	38
On Screen Menus Selection and Adjustment .....	39
Auto Programme Tuning.....	40
Manual Programme Tuning.....	41
Fine Tuning .....	42
Assigning a Station Name .....	43
Booster .....	44
Programme Edit .....	45
Favourite Programme .....	46
Calling the Programme List.....	47
Input Source Selection .....	48
 .....	49
Key lock.....	51

## PICTURE CONTROL

Watching PIP(Picture-in-Picture) .....	52
Picture Size (Aspect Ratio)Control .....	54
Preset Picture Settings	
- Picture Mode-Preset.....	56
- Auto Colour Tone Control(Warm/Medium/Cool) 57	
Manual Picture Adjustment	
- Picture Mode-User Option.....	58
- Colour Tone - User Option.....	59
<b>XD</b> - Picture Improvement Technology.....	60
Advanced - Cinema .....	61
Advanced - TruMotion .....	61
Advanced - Black(Darkness) Level.....	62
Picture Reset.....	63
<b>XD</b> Demo .....	64
TruMotion Demo .....	64
Image Sticking Minimization(ISM) Method .....	65
Low-Power Picture Mode.....	66
Index.....	67

**SOUND & LANGUAGE CONTROL**

Preset Sound Settings - Sound Mode.....	68
Sound Setting Adjustment - User Mode .....	69
Auto Volume Leveler .....	70
Balance .....	71
TV Speakers On/Off Setup .....	72
I/II	
- Stereo/Dual Reception .....	73
- NICAM Reception .....	74
- Speaker Sound Output Selection.....	74
On-Screen Menu Language Selection .....	75

**TIME SETTING**

Clock Setting.....	76
Auto On/Off Timer Setting .....	77
Sleep Timer Setting.....	78
Auto Shut-off Setting .....	79

**TELETEXT**

Switch On/Off .....	80
SIMPLE Text .....	80
TOP Text.....	81
FASTEXT.....	81
Special Teletext Functions.....	82

**APPENDIX**

Troubleshooting.....	83
Maintenance .....	85
Product Specifications .....	86
Programming the Remote Control .....	88
IR Codes.....	91
External Control Through RS-232C .....	94

# PREPARATION

## FRONT PANEL CONTROLS

- This is a simplified representation of the front panel. Image shown may differ from your TV.
- If your product has a protection film attached, remove the film and then wipe the product with a polishing cloth.

### 60PY3RF\*

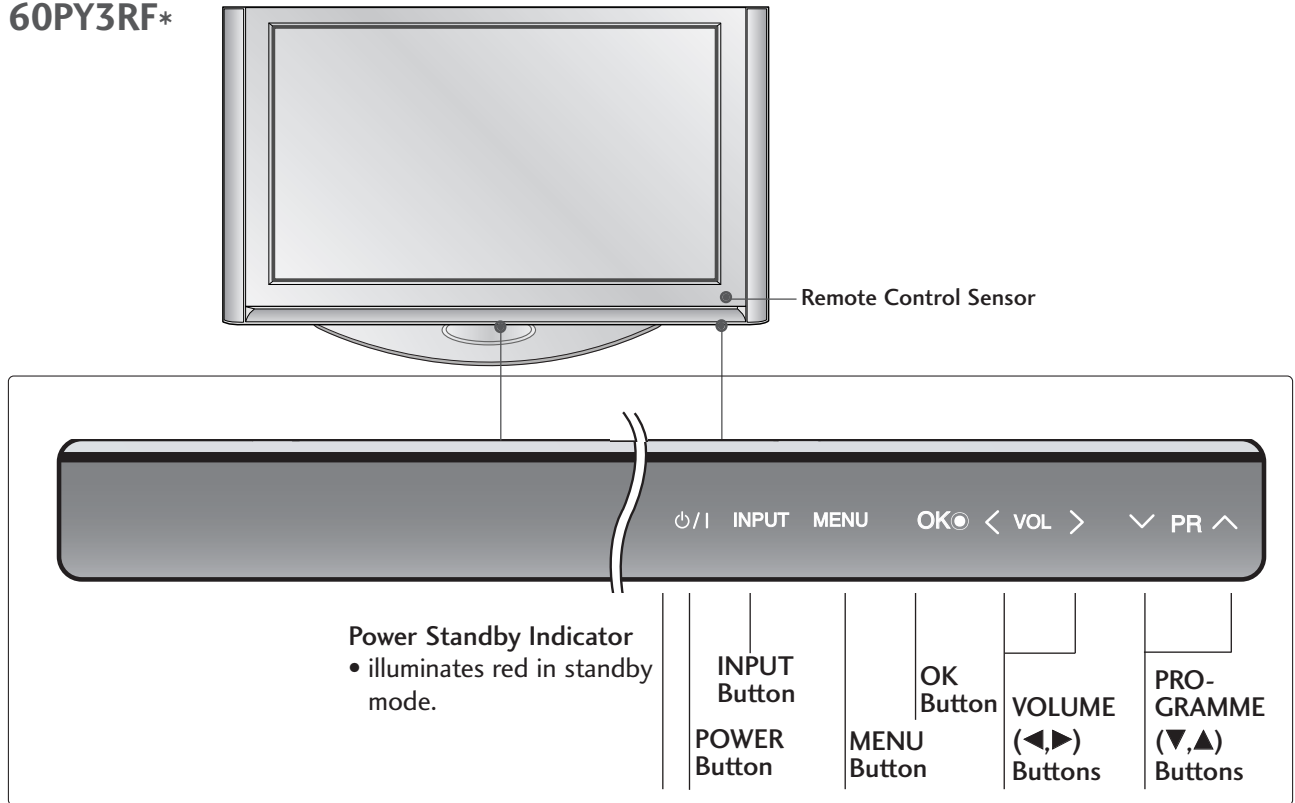

### 60PC4R\*

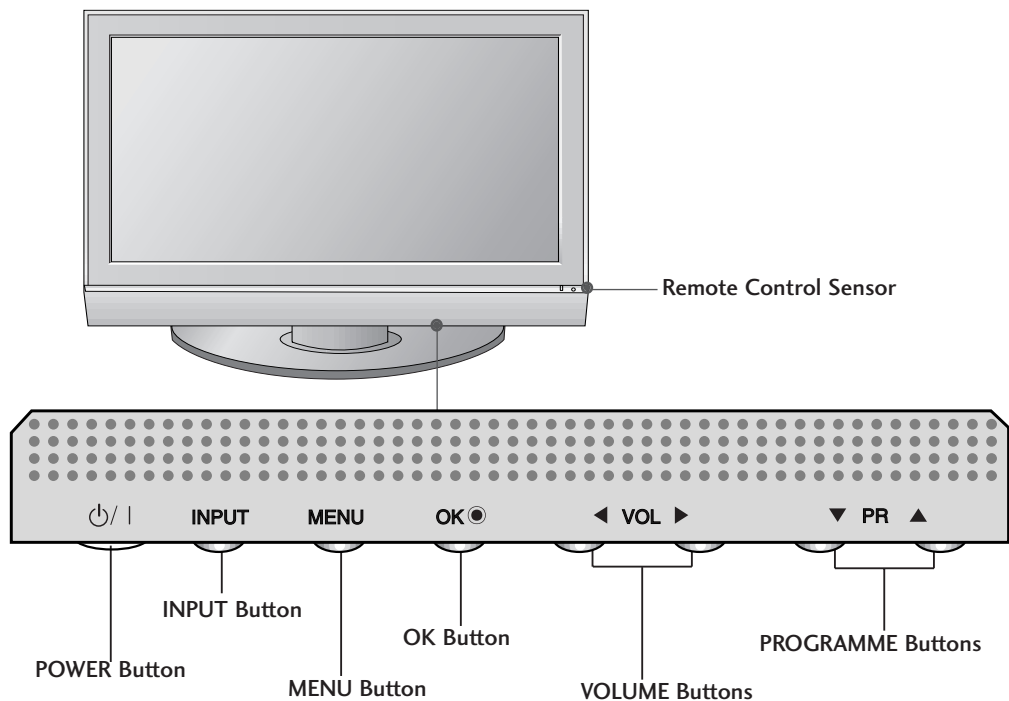

### 42/47LB7RF\*

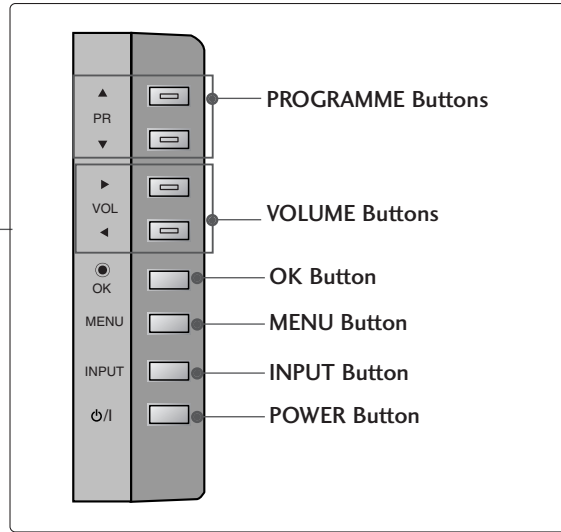
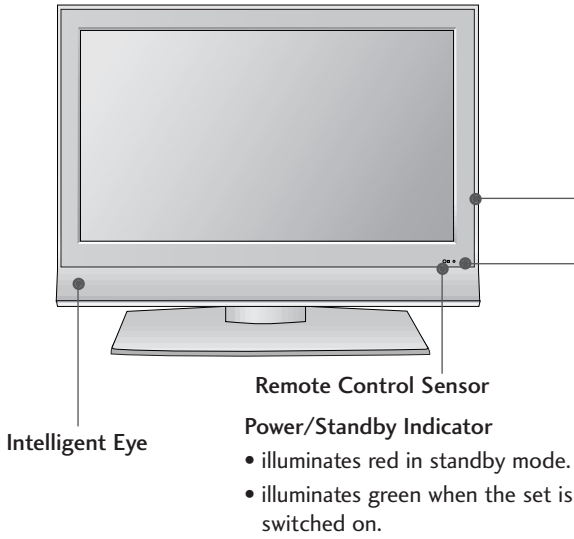

### 47LB9R\*, 52LB9RF\*

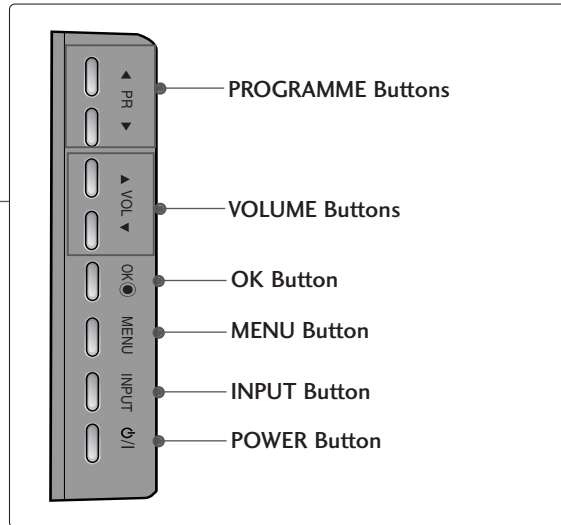
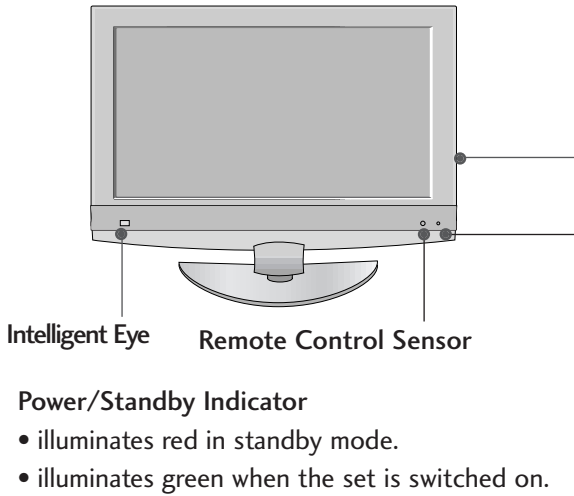

### 47LY3RF\*

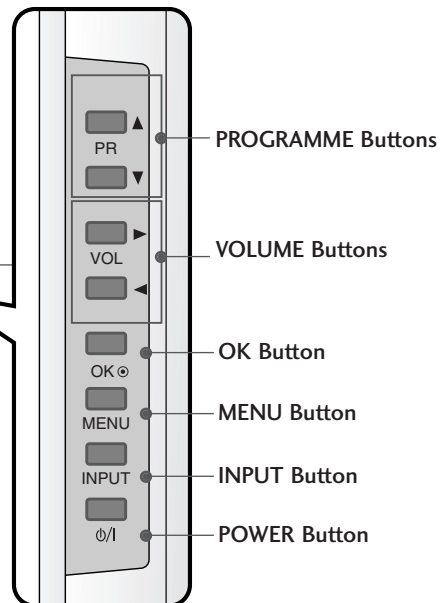
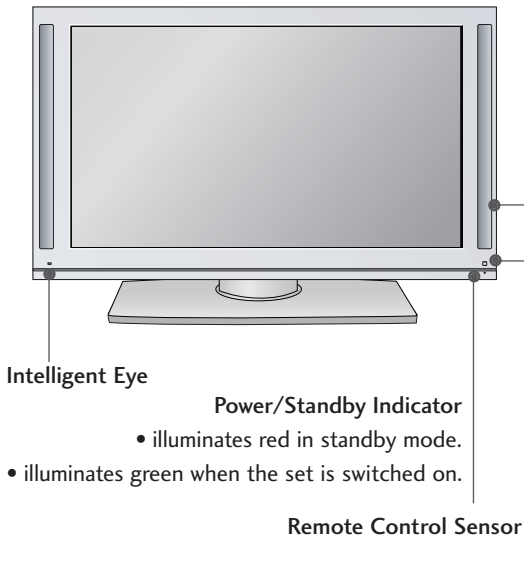

# PREPARATION

## BACK PANEL INFORMATION

- This is a simplified representation of the back panel. Image shown may differ from your TV.

### Plasma TV Models

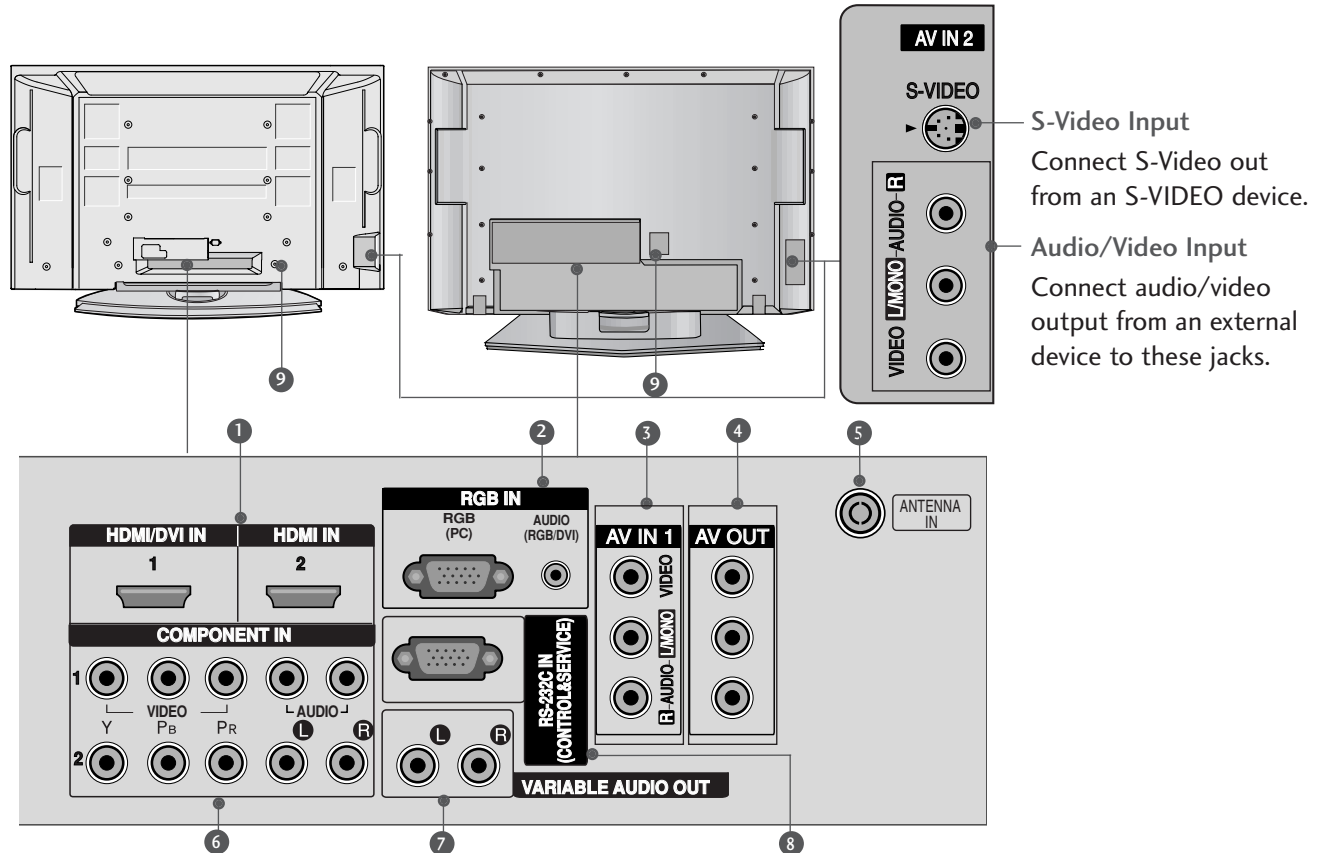

- 1 HDMI/DVI1, HDMI2 Input**  
Connect a HDMI signal to HDMI IN.  
Or DVI(VIDEO)signal to HDMI/DVI port with DVI to HDMI cable.
- 2 RGB/Audio Input**  
Connect the monitor output from a PC to the appropriate input port.
- 3 Audio/Video Input (AV IN 1)**  
Connect audio/video output from an external device to these jacks.
- 4 AV Output**  
Connect second TV or monitor to the AV OUT socket on the set.
- 5 Antenna Input**  
Connect RF antenna (UHF) to this jack.
- 6 Component Input 1/2**  
Connect a component video/audio device to these jacks.
- 7 Variable Audio Output**  
Connect an external amplifier or add a subwoofer to your surround sound system.
- 8 RS-232C Input(CONTROL&SERVICE)Port**  
Connect the serial port of the control devices to the RS-232C jack.
- 9 Power Cord Socket**  
This TV operates on an AC power. The voltage is indicated on the Specifications page. Never attempt to operate the TV on DC power.



## LCD TV Models

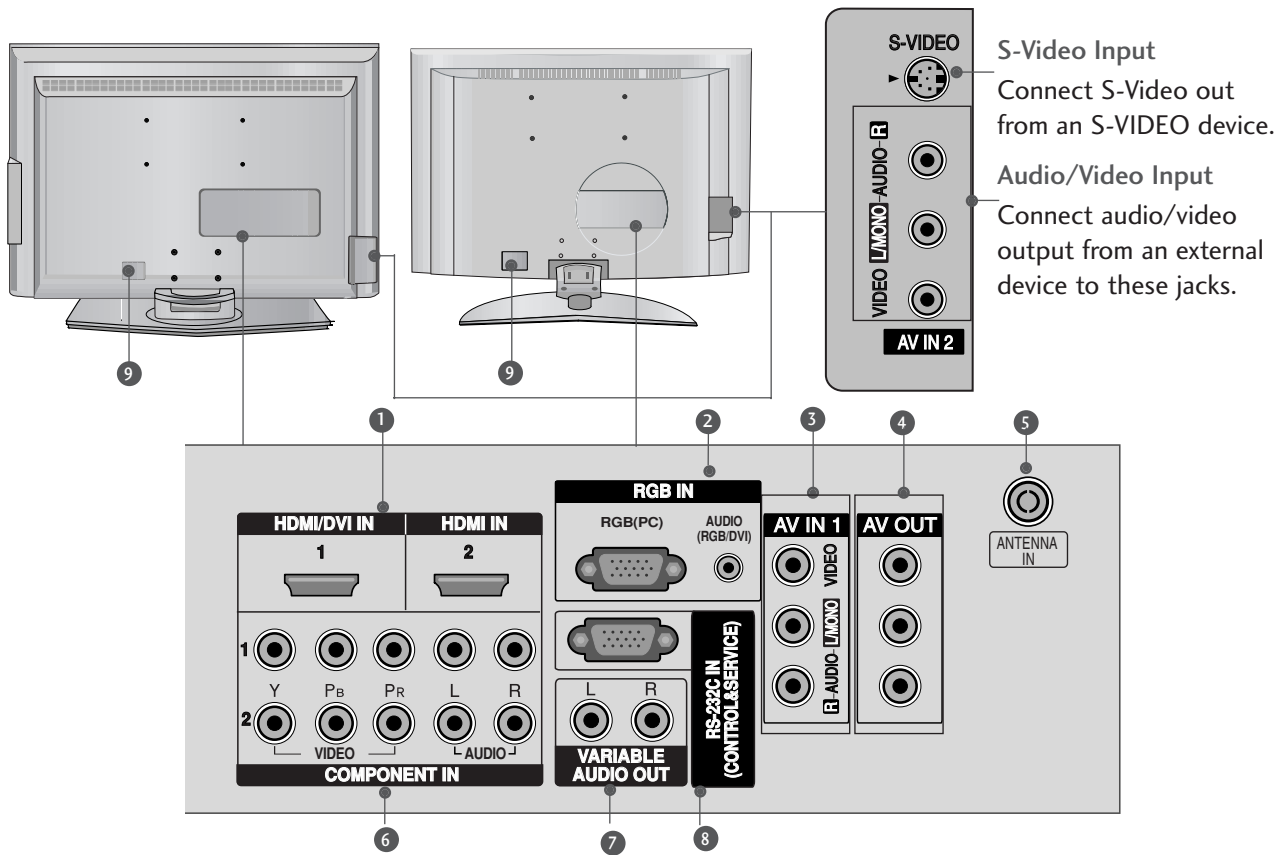

- 1** HDMI/DVI1, HDMI2 Input  
Connect a HDMI signal to HDMI IN.  
Or DVI(VIDEO)signal to HDMI/DVI port with DVI to HDMI cable.
- 2** RGB/Audio Input  
Connect the monitor output from a PC to the appropriate input port.
- 3** Audio/Video Input (AV IN 1)  
Connect audio/video output from an external device to these jacks.
- 4** AV Output  
Connect second TV or monitor to the AV OUT socket on the set.
- 5** Antenna Input  
Connect RF antenna (UHF) to this jack.
- 6** Component Input 1/2  
Connect a component video/audio device to these jacks.
- 7** Variable Audio Output  
Connect an external amplifier or add a subwoofer to your surround sound system.
- 8** RS-232C Input(CONTROL&SERVICE)Port  
Connect the serial port of the control devices to the RS-232C jack.
- 9** Power Cord Socket  
This TV operates on an AC power. The voltage is indicated on the Specifications page. Never attempt to operate the TV on DC power.

# PREPARATION

## STAND INSTALLATION (42/47LB7RF\* only)

- 1 Carefully place the product screen side down on a cushioned surface to protect the screen from damage.

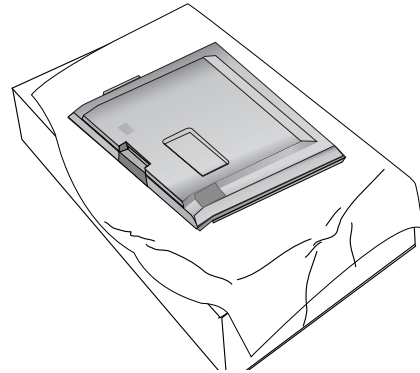

- 2 Assemble the product as shown.

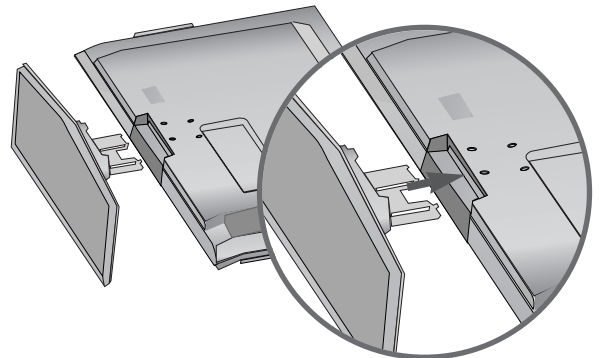

- 3 Fix the 4 bolts securely using the holes in the back of the product.

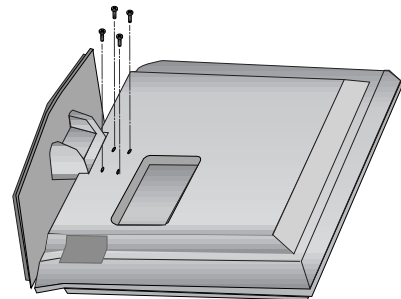

## SWIVEL STAND (60PY3RF\* only)

After installing the TV, you can adjust the TV set manually to the left or right direction by 20 degrees to suit your viewing position.



### ! NOTE

- ▶ Before adjusting the angle, you must remove the cable management and loosen (to the left) the shaft bolt on the middle of stand's back. And when stand be level with TV, you must close (to the right) the shaft bolt to set the hole.

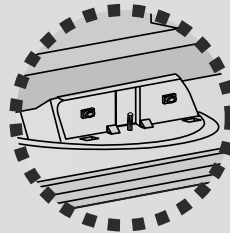

# PREPARATION

## ATTACHING THE TV TO A WALL

- This feature is not available for all models.
- Position the TV close to the wall to avoid the possibility of it falling when pushed.
- The instructions shown below are a safer way to set up the TV, which is to fix it to the wall, avoiding the possibility of it falling forwards if pulled. This will prevent the TV from falling forward and causing injury. This will also prevent the TV from damage. Ensure that children do not climb or hang from the TV.

Plasma TV models

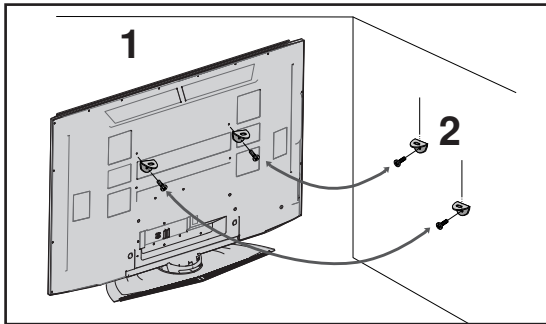

LCD TV models

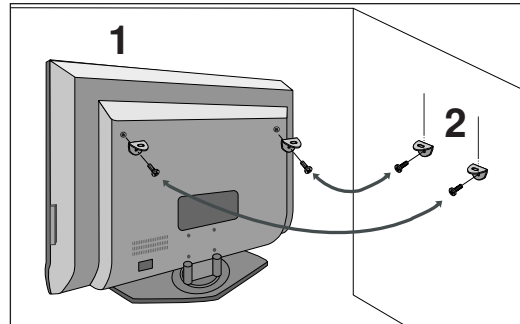

- 1 Use the eye-bolts or TV brackets/bolts to fix the product to the wall as shown in the picture. (If your TV has bolts in the eyebolts, loosen then bolts.)  
\* Insert the eye-bolts or TV brackets/bolts and tighten them securely in the upper holes.
- 2 Secure the wall brackets with bolts (must purchase separately) to the wall. Ensure that both brackets are even.

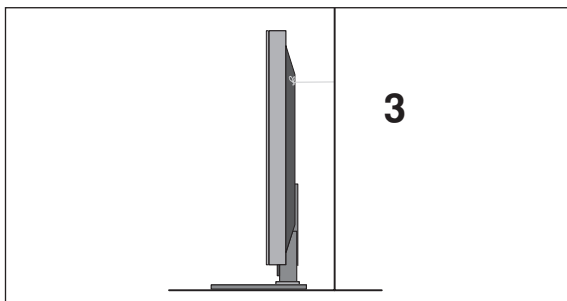

- 3 Use a strong cord (must purchase separately) to secure the TV. Secure the cord in such a way that it becomes taut when the TV is in position.

### ! NOTE

- ▶ When moving the TV undo the cords first.
- ▶ Use a platform or cabinet string and large enough to support the size and weight of the TV.
- ▶ To use the TV safely make sure that the height of the bracket on the wall and on the TV is the same.

# BACK COVER FOR WIRE ARRANGEMENT

## Plasma TV models

- 1 Grip the **CABLE MANAGEMENT** and push the cover upwards.

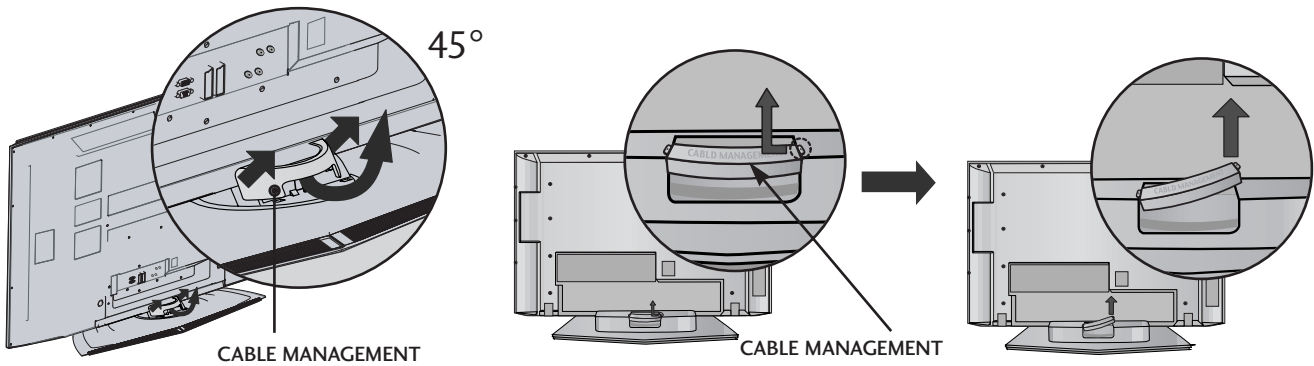

- 2 Connect the cables as necessary.  
To connect additional equipment, see the **External equipment Setup** section of the manual.



- 3 Install the **CABLE MANAGEMENT** as shown.

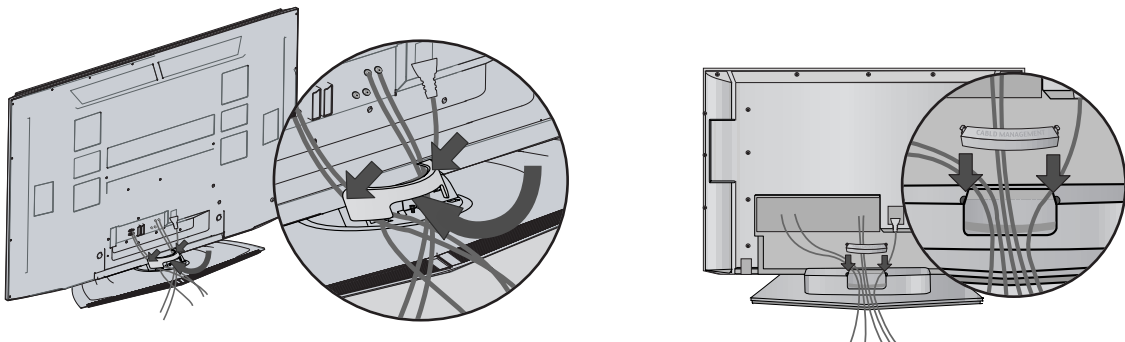

# PREPARATION

## LCD TV models

- 1** Connect the cables as necessary.

To connect additional equipment, see the **External equipment Connections** section.

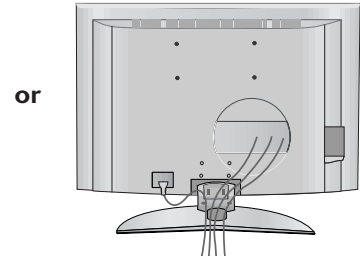
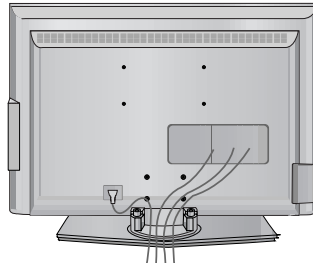

- 2** Install the **CABLE MANAGEMENT** as shown.

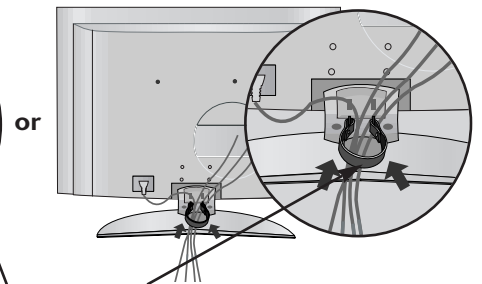
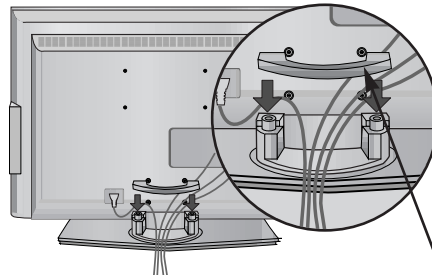

CABLE MANAGEMENT

(Insert it as pushing the loops on the both sides of the cable management.)

- 3** Bundle the cables using the supplied twister holder.  
(This feature is not available for all models.)

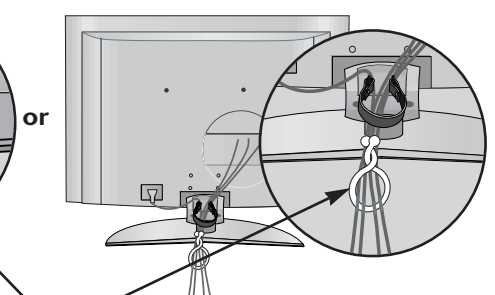
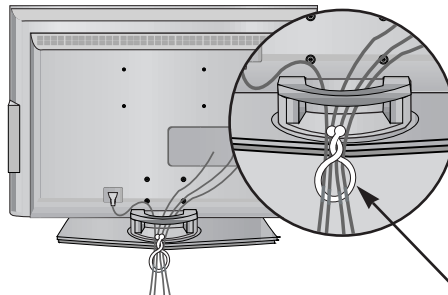

TWIST HOLDER

## How to remove the cable management

Hold the **CABLE MANAGEMENT** with both hands and pull it upward.

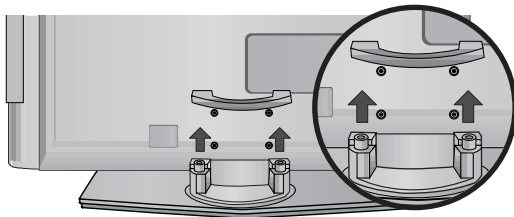

or

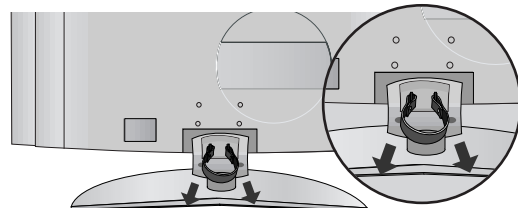

(Pull it out as holding the loops on the both sides of the cable management.)

### ! NOTE

- ▶ Do not use the **CABLE MANAGEMENT** to lift the TV.
- If the TV is dropped, you may be injured or the TV may be damaged.

- The TV can be installed in various ways such as on a wall, or on a desktop etc.
- The TV is designed to be mounted horizontally.

## EARTHING

Ensure that you connect the earth wire to prevent possible electric shock. If grounding methods are not possible, have a qualified electrician install a separate circuit breaker.

Do not try to earth the TV by connecting it to telephone wires, lightening rods or gas pipes.

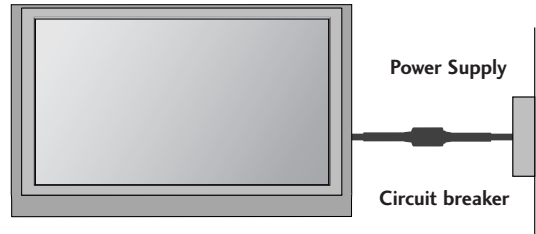

## DESKTOP PEDESTAL INSTALLATION

For adequate ventilation allow a clearance of 4" (10cm) all around the TV .

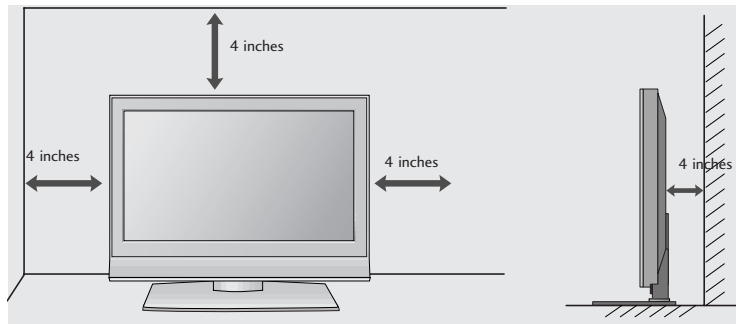
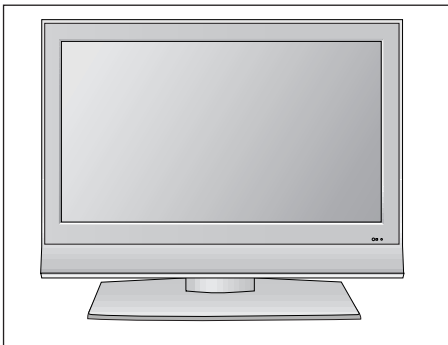

When not using the desk-type stand (60PY3RF\* only)

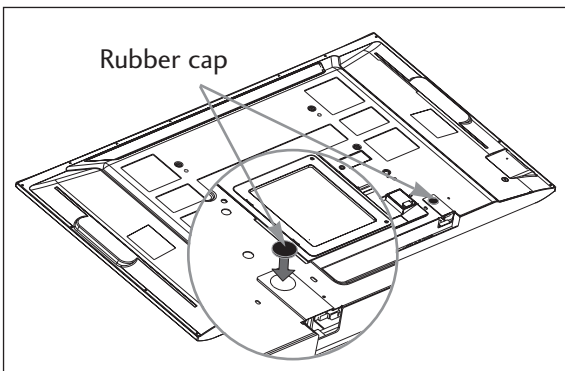

When not using the desk-type stand, install the supplied rubber caps for protecting the desk-type stand fixture as shown at the figure.

# PREPARATION

## WALL MOUNT: HORIZONTAL INSTALLATION

For adequate ventilation allow a clearance of 4" (10cm) all around the TV. Detailed installation instructions are available from your dealer, see the optional Tilt Wall Mounting Bracket Installation and Setup Guide.

PREPARATION

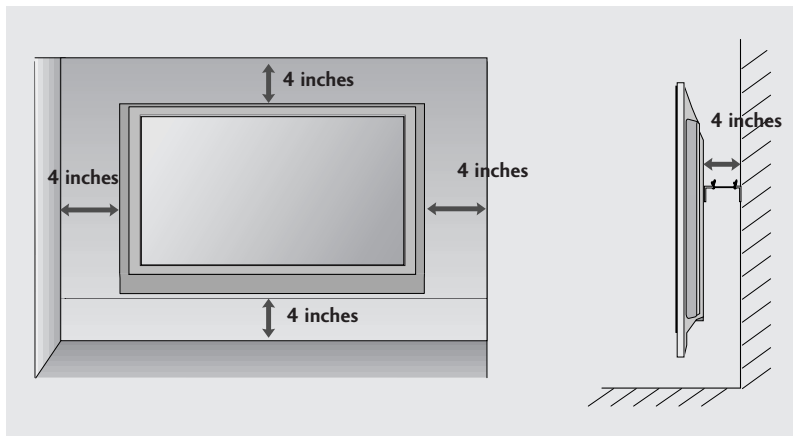
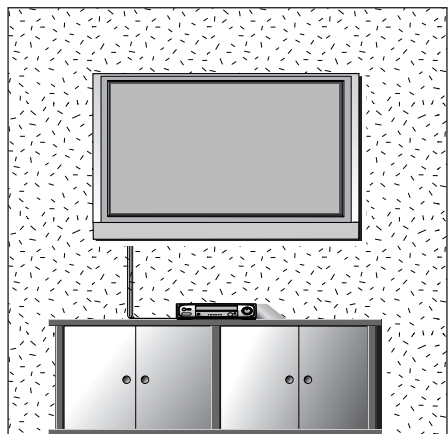

If you want to install the desk-type stand fixture protection cover (60PY3RF\* only)

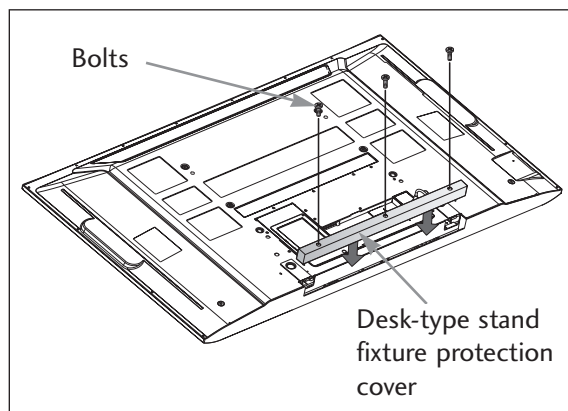

To prevent the foreign materials from entering the desk-type stand fixture, fix the desk-type stand fixture protection cover by using the supplied bolts as shown at the figure.



- To prevent damage do not connect to the mains outlet until all connections are made between the devices.

## ANTENNA CONNECTION

- For optimum picture quality, adjust antenna direction.
- An antenna cable and converter are not supplied.

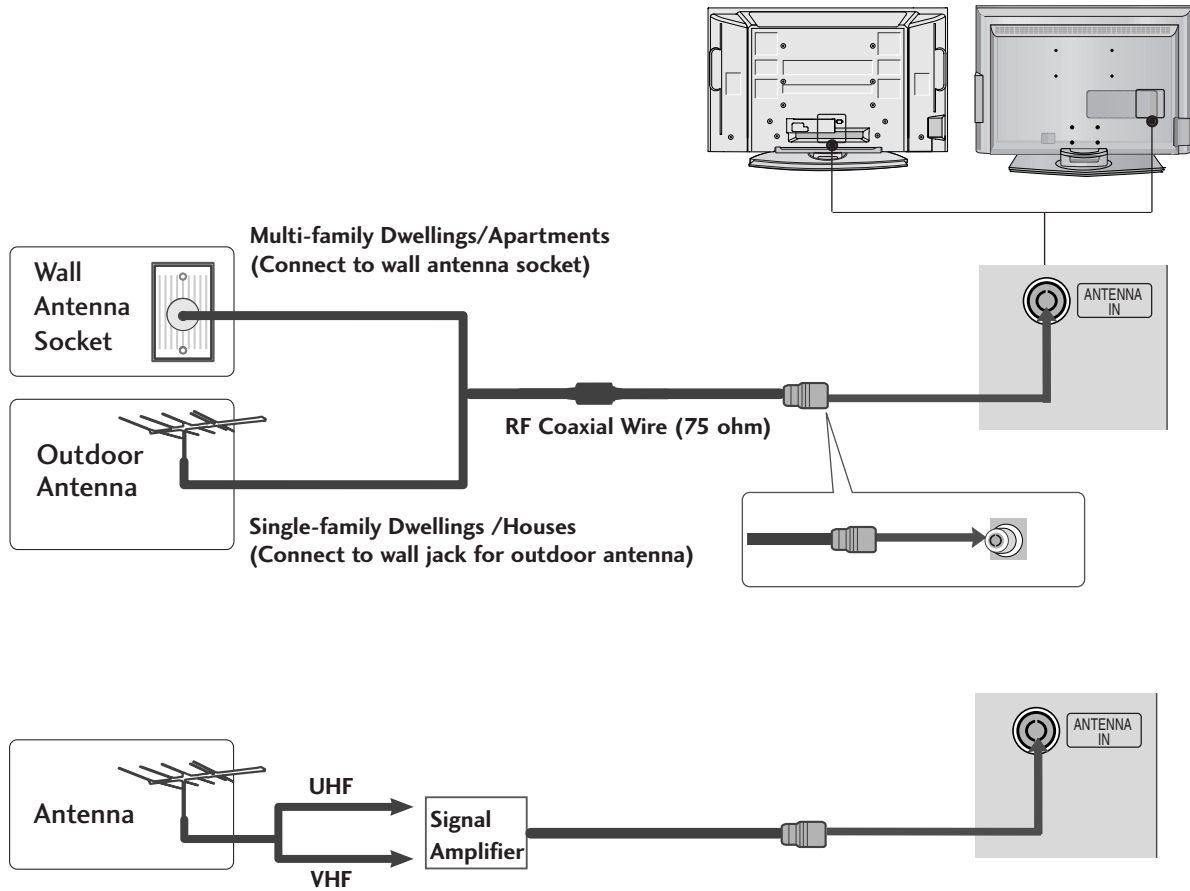

- In poor signal areas, to achieve better picture quality it may be necessary to install a signal amplifier to the antenna as shown above.
- If signal needs to be split for two TVs, use an antenna signal splitter for connection.

# EXTERNAL EQUIPMENT SETUP

- To avoid damaging any equipment, never plug in any power cords until you have finished connecting all equipment.
- This section on EXTERNAL EQUIPMENT SETUP mainly uses diagrams for the Plasma TV models.

## HD RECEIVER SETUP

### When connecting with a component cable

- 1 Connect the video outputs (Y, PB, PR) of the digital set top box to the **COMPONENT IN VIDEO** jacks on the set.
- 2 Connect the audio output of the digital set-top box to the **COMPONENT IN AUDIO** jacks on the set.
- 3 Turn on the digital set-top box.  
(Refer to the owner's manual for the digital set-top box.)
- 4 Select **Component1** input source using the **INPUT** button on the remote control.  
If connected to **COMPONENT IN2**, select **Component2** input source.

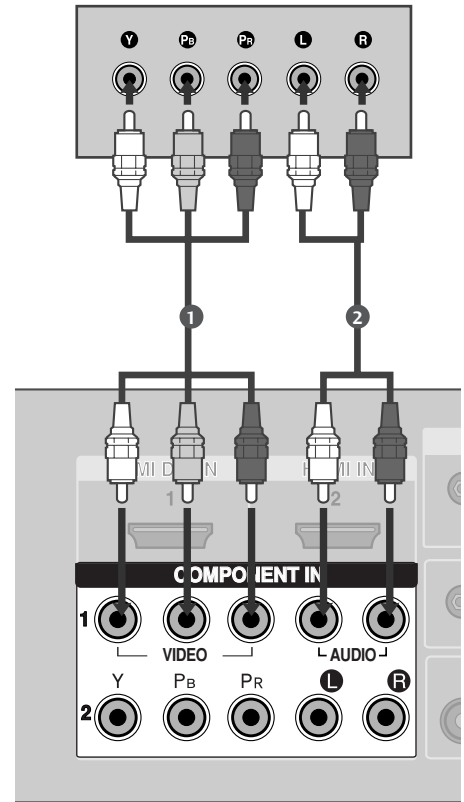

Signal	Component 1/2	HDMI1/DVI, HDMI2
480i/576i	Yes	No
480p/576p	Yes	Yes
720p	Yes	Yes
1080i	Yes	Yes
1080p(50Hz/60Hz)	Yes	Yes

## When connecting with a HDMI cable

- 1 Connect the HDMI output of the digital set-top box to the **HDMI/DVI IN 1** or **HDMI IN 2** jack on the set.
- 2 Select **HDMI1/DVI** or **HDMI2** input source using the **INPUT** button on the remote control.
- 3 Turn on the digital set-top box.  
(Refer to the owner's manual for the digital set-top box.)

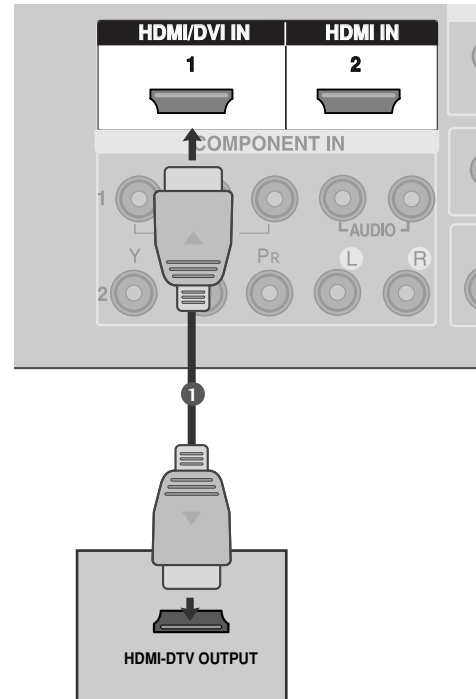

### ! NOTE

- ▶ If the digital set-top box supports Auto HDMI function, the output resolution of the source device will be automatically set to 1280x720p.
- ▶ If the digital set-top box player does not support Auto HDMI, you need to set the output resolution appropriately.

To get the best picture quality, adjust the output resolution of the source device to 1920x1080i/1080p.  
(60PC4R\*, 47LB9R\* : 1280x720p)

# EXTERNAL EQUIPMENT SETUP

## When connecting with a HDMI to DVI cable

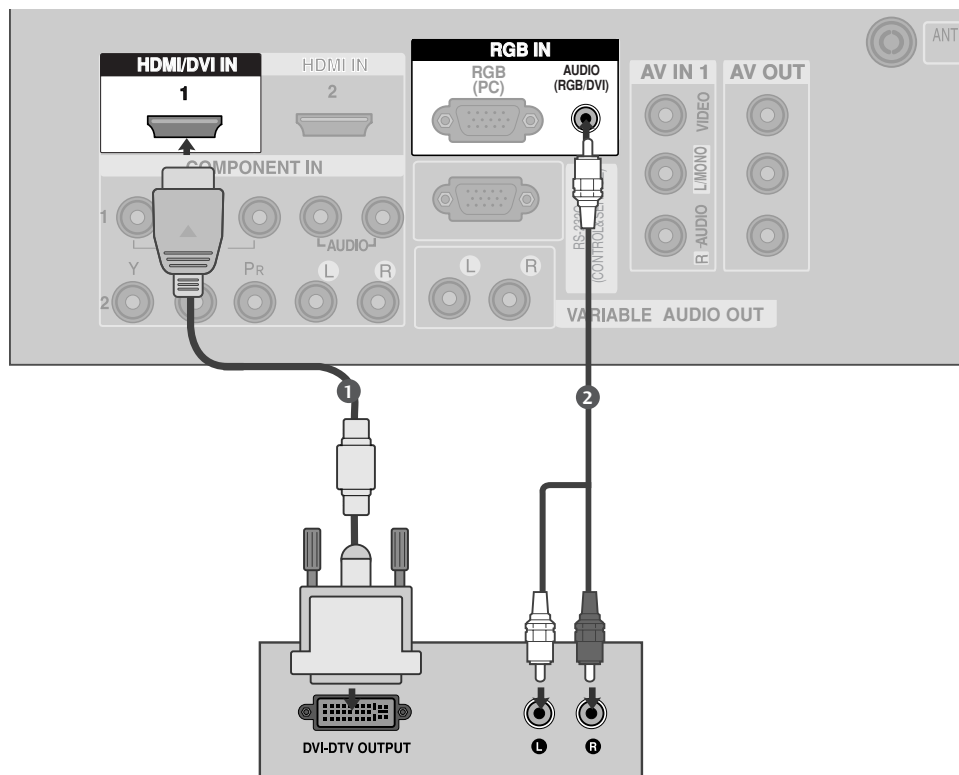

- 1 Connect the DVI output of the digital set-top box to the **HDMI/DVI IN 1** jack on the set.
- 2 Connect the audio output of the digital set-top box to the **AUDIO (RGB/DVI)** jack on the set.
- 3 Turn on the digital set-top box. (Refer to the owner's manual for the digital set-top box.)
- 4 Select **HDMI1/DVI** input source using the **INPUT** button on the remote control.

# DVD SETUP

## When connecting with a component cable

- 1 Connect the video outputs (Y, PB, PR) of the DVD to the **COMPONENT IN VIDEO** jacks on the set.
- 2 Connect the audio outputs of the DVD to the **COMPONENT IN AUDIO** jacks on the set.
- 3 Turn on the DVD player, insert a DVD.
- 4 Select **Component1** input source using the **INPUT** button on the remote control.  
If connected to **COMPONENT IN2**, select **Component2** input source.
- 5 Refer to the DVD player's manual for operating instructions.

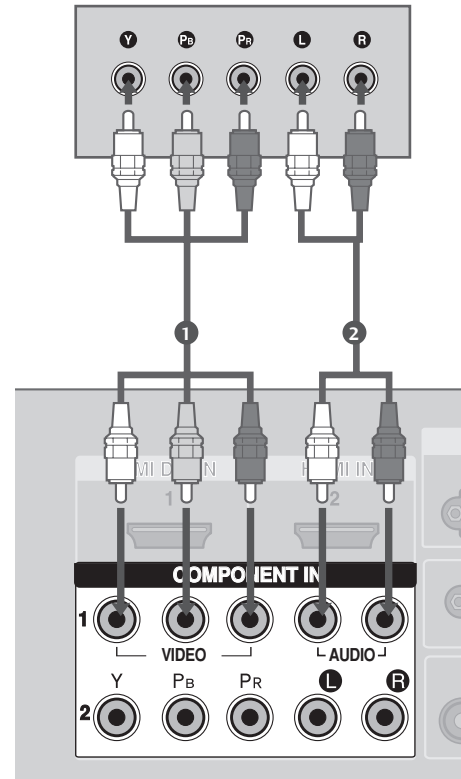

### Component Input ports

To achieve better picture quality, connect a DVD player to the component input ports as shown below.

Component ports on the TV	Y	P <sub>B</sub>	P <sub>R</sub>
---------------------------	---	----------------	----------------

Video output ports on DVD player	Y	P <sub>B</sub>	P <sub>R</sub>
	Y	B-Y	R-Y
	Y	C <sub>b</sub>	C <sub>r</sub>
	Y	P <sub>b</sub>	P <sub>r</sub>

# EXTERNAL EQUIPMENT SETUP

## When connecting with an S-Video cable

- 1 Connect the S-VIDEO output of the DVD to the S-VIDEO input on the set.
- 2 Connect the audio outputs of the DVD to the AUDIO input jacks on the set.
- 3 Turn on the DVD player, insert a DVD.
- 4 Select **AV2** input source using the **INPUT** button on the remote control.
- 5 Refer to the DVD player's manual for operating instructions.

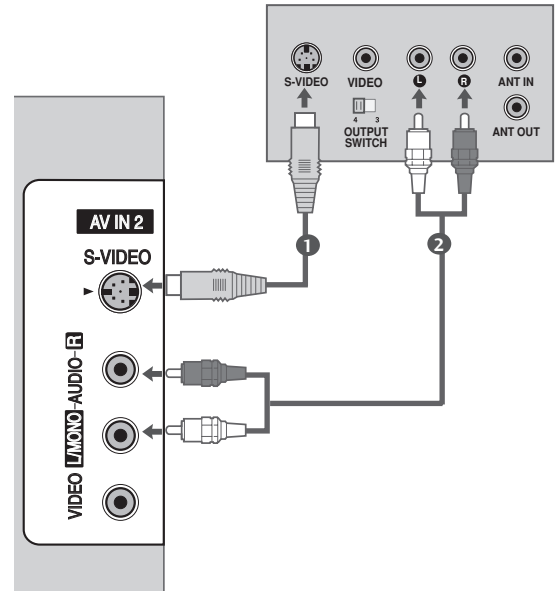

## When connecting HDMI cable

- 1 Connect the HDMI output of the DVD to the **HDMI/DVI IN 1** or **HDMI IN 2** jack on the set.
- 2 Select **HDMI1/DVI** or **HDMI2** input source using the **INPUT** button on the remote control.
- 3 Refer to the DVD player's manual for operating instructions.

### ! NOTE

- ▶ If the DVD supports Auto HDMI function, the DVD output resolution will be automatically set to 1280x720p.
- ▶ If the DVD player does not support Auto HDMI, you must set the output resolution appropriately.

To get the best picture quality, adjust the output resolution of the DVD to 1920x1080i/1080p. (60PC4R\*, 47LB9R\*: 1280x720p)

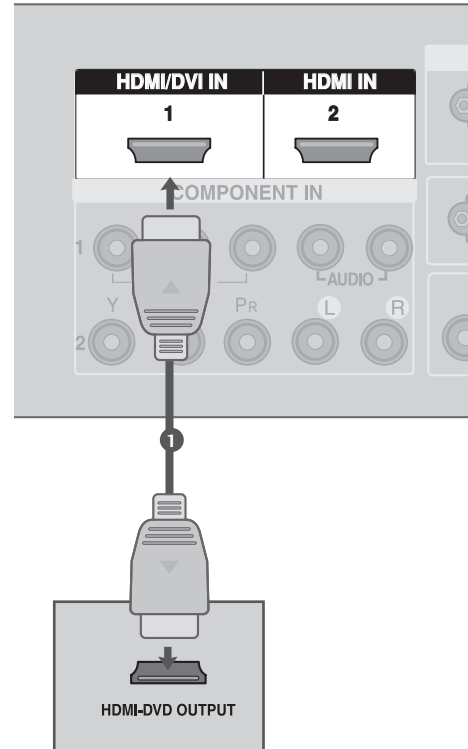

# EXTERNAL EQUIPMENT SETUP

## VCR SETUP

- To avoid picture noise (interference), allow adequate distance between the VCR and TV.
- Typically a frozen still picture from a VCR. If 4:3 picture format is used for an extended period the fixed images on the sides of the screen may remain visible.

### When connecting with an antenna

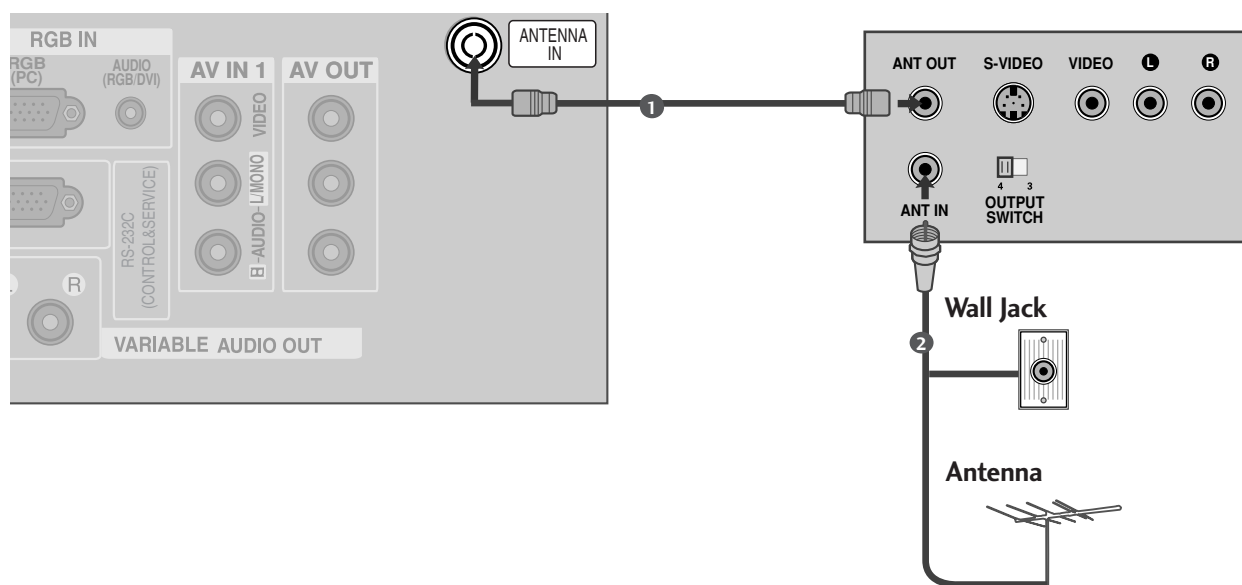

- 1 Connect the **ANT OUT** socket of the VCR to the **ANTENNA IN** socket on the set.
- 2 Connect the antenna cable to the **ANT IN** socket of the VCR.
- 3 Press the **PLAY** button on the VCR and match the appropriate programme between the TV and VCR for viewing.



## When connecting with a RCA cable

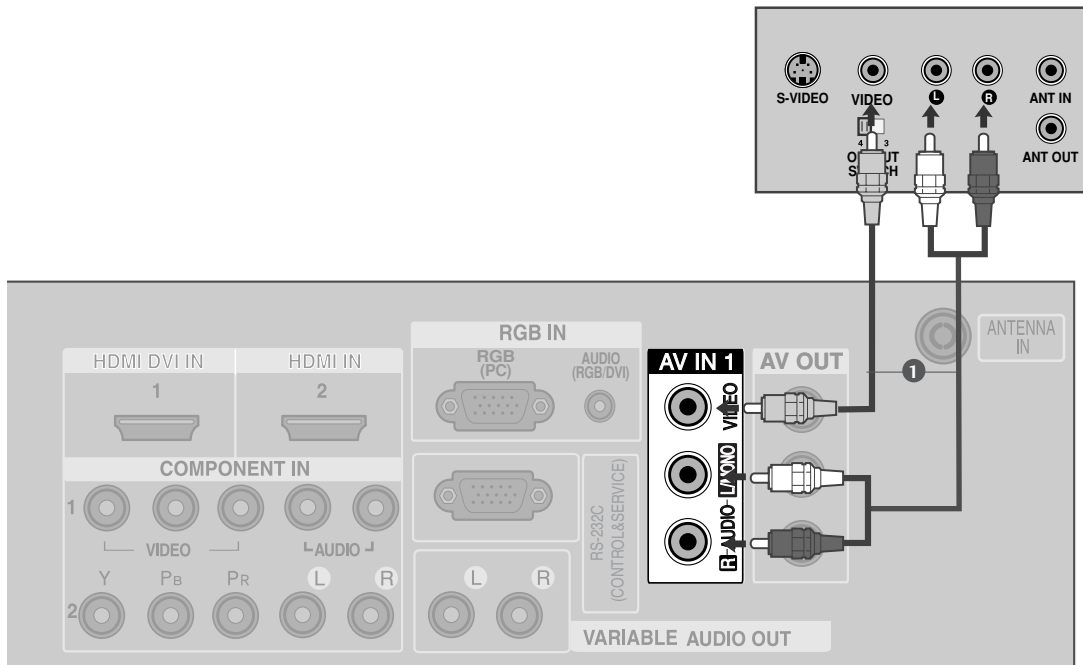

- 1 Connect the **AUDIO/VIDEO** jacks between TV and VCR. Match the jack colours (Video = yellow, Audio Left = white, and Audio Right = red)
- 2 Insert a video tape into the VCR and press PLAY on the VCR. (Refer to the VCR owner's manual.)
- 3 Select **AV1** input source using the **INPUT** button on the remote control.  
If connected to **AV IN2**, select **AV2** input source.

### ! NOTE

- ▶ If you have a mono VCR, connect the audio cable from the VCR to the **AUDIO L/MONO** jack of the set.

# EXTERNAL EQUIPMENT SETUP

## When connecting with an S-Video cable

- 1 Connect the S-VIDEO output of the VCR to the **S-VIDEO** input on the set. The picture quality is improved; compared to normal composite (RCA cable) input.
- 2 Connect the audio outputs of the VCR to the **AUDIO** input jacks on the set.
- 3 Insert a video tape into the VCR and press **PLAY** on the VCR. (Refer to the VCR owner's manual.)
- 4 Select **AV2** input source using the **INPUT** button on the remote control.

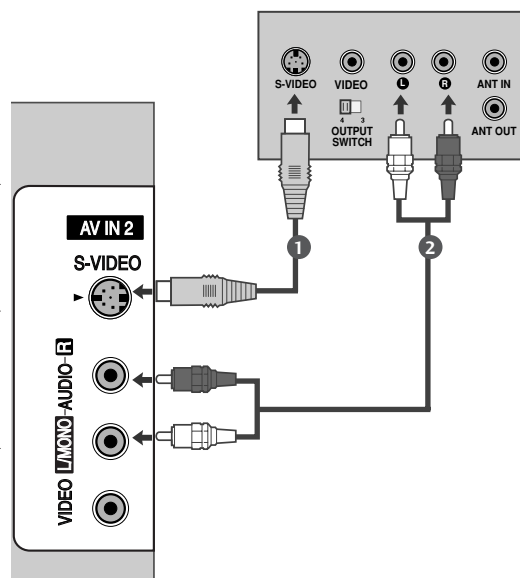

### ! NOTE

- ▶ If both S-VIDEO and VIDEO sockets have been connected to the S-VHS VCR simultaneously, only the S-VIDEO can be received.

## OTHER A/V SOURCE SETUP

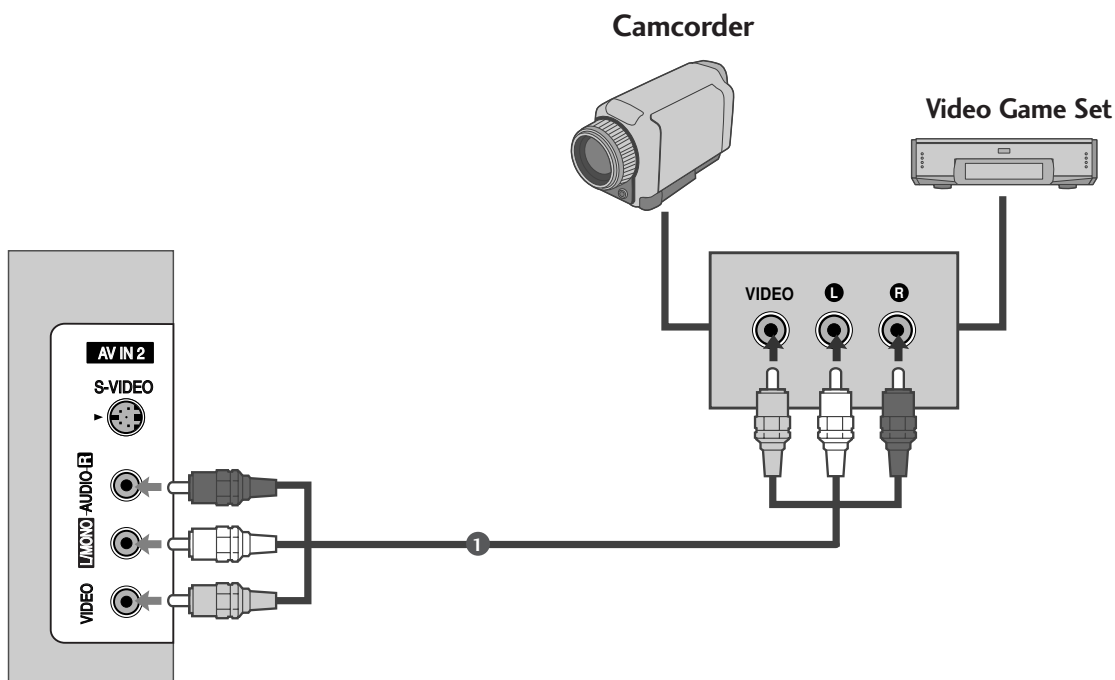

- 1 Connect the **AUDIO/VIDEO** jacks between TV and external equipment. Match the jack colours. (Video = yellow, Audio Left = white, and Audio Right = red)
- 2 Select **AV2** input source using the **INPUT** button on the remote control. If connected to **AV IN1**, select **AV1** input source.
- 3 Operate the corresponding external equipment. Refer to external equipment operating guide.

# EXTERNAL EQUIPMENT SETUP

## PC SETUP

This TV provides Plug and Play capability, meaning that the PC adjusts automatically to the TV's settings.

### When connecting with a D-sub 15 pin cable

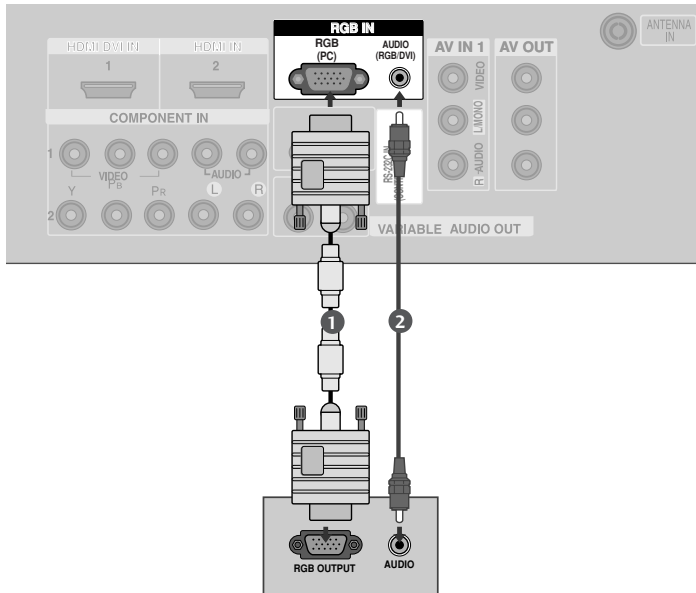

- 1 Connect the RGB output of the PC to the **RGB (PC)** jack on the set.  
.....
- 2 Connect the PC audio output to the **AUDIO(RGB/DVI)** jack on the set.  
.....
- 3 Turn on the PC and the set.  
.....
- 4 Select **RGB PC** input source using the **INPUT** button on the remote control.

### ! NOTE

- ▶ Check the image on your TV. There may be interference relating to resolution, vertical pattern, contrast or brightness in PC mode. If noise is present, change the PC output to another resolution, change the refresh rate to another rate or adjust the brightness and contrast on the VIDEO menu until the picture is clear. If the refresh rate of the PC graphic card can not be changed, change the PC graphic card or consult the manufacturer of the PC graphic card.

## When connecting with a HDMI to DVI cable

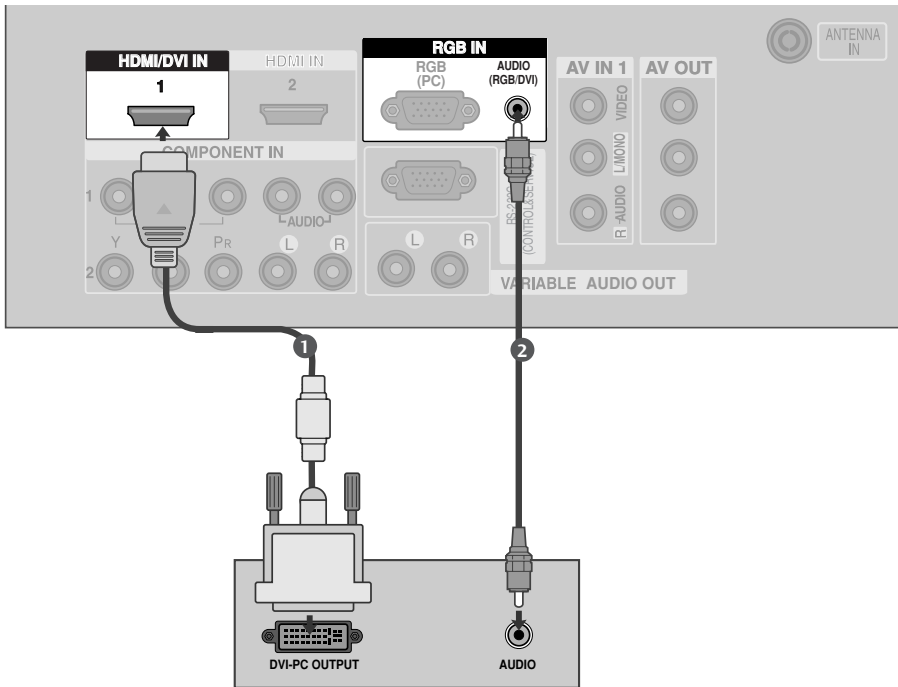

- 1 Connect the DVI output of the PC to the **HDMI/DVI IN 1** jack on the set.

---

- 2 Connect the PC audio output to the **AUDIO (RGB/DVI)** jack on the set.

---

- 3 Turn on the PC and the set.

---

- 4 Select **HDMI1/DVI** input source using the **INPUT** button on the remote control.

### ! NOTE

- ▶ HDMI2 source does not support DVI source.
- ▶ If the PC has a DVI output and no HDMI output, a separated audio connection is necessary.
- ▶ If the PC does not support Auto DVI, you need to set the output resolution appropriately.

# EXTERNAL EQUIPMENT SETUP

## Supported Display Resolution (RGB[PC]/HDMI[PC]mode)

Resolution	Horizontal Frequency(kHz)	Vertical Frequency(Hz)	
720x400	31.5	70.1	
640x480	31.5	59.9	
800x600	37.9	60.3	
1024x768	48.4	60.0	
1280x768	47.8	59.9	(60PC4R*, 47LB9R* only)
1360x768	47.7	59.8	
1280x1024	63.7	59.5	(Except 60PC4R*, 47LB9R*)
1400x1050	65.3	60.0	
1600x1200	75.0	60.0	
1920x1080	66.6	60.0	

### ! NOTE

- ▶ To get the best picture quality, adjust the PC graphics card to 1920x1080, 60Hz.(60PC4R\*, 47LB9R\*: 1360x768, 60Hz)
- ▶ Depending on the graphics card, DOS mode may not work if a HDMI to DVI Cable is in use.
- ▶ When Source Devices connected with HDMI Input, output TV SET Resolution (480p, 720p, 1080i) and TV SET Display fit EIA/CEA-861-B Specification to Screen. If not, refer to the Manual of HDMI Source Devices or contact your service center.
- ▶ If the HDMI Source Device is not connected to the Cable or if there is a poor cable connection, "No signal" is displayed in the HDMI Input. In this case, that Video Resolution is not supported.
- ▶ Avoid keeping a fixed image on the screen for prolonged periods of time. The fixed image may become permanently imprinted on the screen.
- ▶ The synchronization input form for Horizontal and Vertical frequencies is separate.
- ▶ If you use too long an RGB-PC cable, there may be interference on the screen. We recommend using under 5m of the cable. This provides the best picture quality.

## Screen Setup for PC mode

### Auto Configure (RGB [PC] mode only)

Automatically adjusts picture position and minimizes image instability. After adjustment, if the image is still not correct, your set is functioning properly but needs further adjustment.

#### Auto configure

This function is for automatic adjustment of the screen position, clock, and phase. The displayed image will be unstable for a few seconds while the auto configuration is in progress..

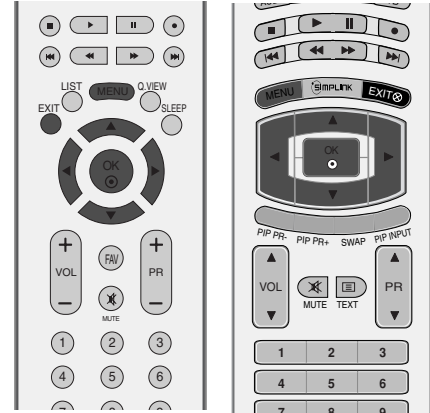

- 1 Press the **MENU** button and then use **▲ / ▼** button to select the **PICTURE** menu.
- 2 Press the **▶** button and then use **▲ / ▼** button to select **Screen**.
- 3 Press the **▶** button and then use **▲ / ▼** button to select **Auto Config..**
  - When **Auto config.** has finished, OK will be shown on screen.
  - If the position of the image is still not correct, try Auto adjustment again.
- 4 Press the **▶** button to start **Auto Config..**
  - If picture needs to be adjusted again after Auto adjustment in RGB (PC), you can adjust the **Manual Config..**
- 5 Press the **EXIT** button to return to TV viewing.

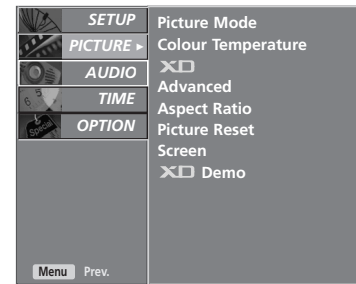

1



2

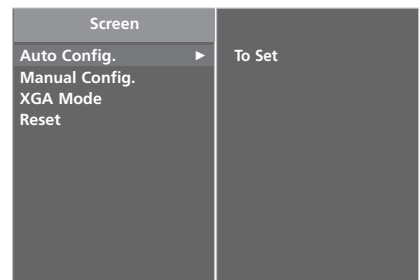

3 4

# EXTERNAL EQUIPMENT SETUP

## Adjustment for screen Phase, Clock, Position

If the picture is not clear after auto adjustment and especially if characters are still trembling, adjust the picture phase manually.

It is not available to use this function in 1:1 Pixel mode.

To correct the screen size, adjust **Clock**.

This function works in the following mode : RGB[PC], COMPONENT (480i/480p/576i/576p/720p/1080i/1080p), HDMI (480p/576p/720p/1080i/1080p).

It is not available to use Phase, Clock function in COMPONENT (480i/480p/576i/576p/720p/1080i/1080p), HDMI (480p/576p/720p/1080i/1080p).

**Clock** Clock This function is to minimize any vertical bars or stripes visible on the screen background the horizontal screen size will also change.

**Phase** This function allows you to remove any horizontal noise and clear or sharpen the image of characters.

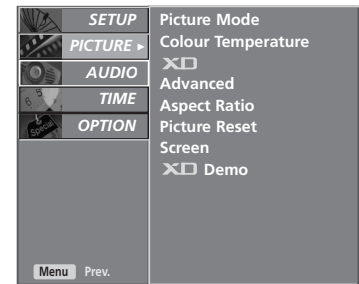
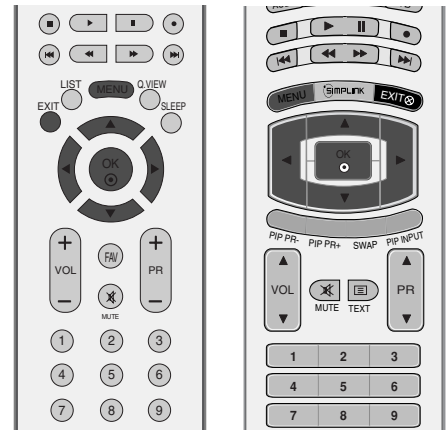

- 1 Press the **MENU** button and then use ▲ / ▼ button to select the **PICTURE** menu.
- 2 Press the ► button and then use ▲ / ▼ button to select **Screen**.
- 3 Press the ► button and then use ▲ / ▼ button to select **Manual Config..**
- 4 Press the ► button and then use ▲ / ▼ button to select **Phase, Clock, H-Position** or **V-Position**.
- 5 Press the ◀ / ▶ button to make appropriate adjustments.
- 6 Press the **EXIT** button to return to TV viewing.

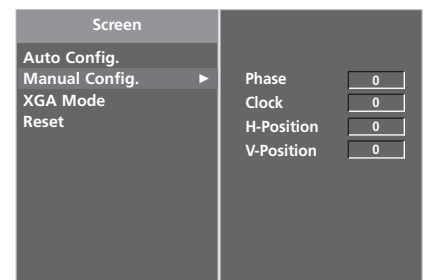

### NOTE

▶ In HDMI or COMPONENT mode, 1080p works at 50Hz/60Hz only.



## Selecting Wide XGA mode

To view a normal picture, match the resolution of RGB mode and selection of XGA mode.

This function works in the following mode: RGB[PC] mode.

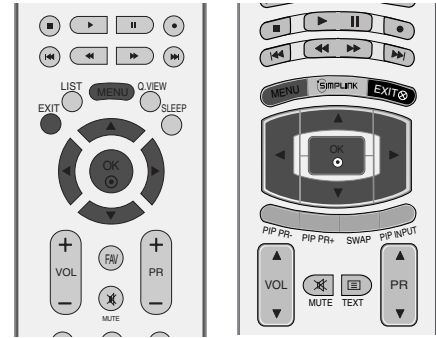

- 1 Press the **MENU** button and then use ▲ / ▼ button to select the **PICTURE** menu.
- 2 Press the ► button and then use ▲ / ▼ button to select **Screen**.
- 3 Press the ► button and then use ▲ / ▼ button to select **XGA Mode**.
- 4 Press the ► button and then use ▲ / ▼ button to select the desired XGA resolution.
- 5 Press the **EXIT** button to return to TV viewing.

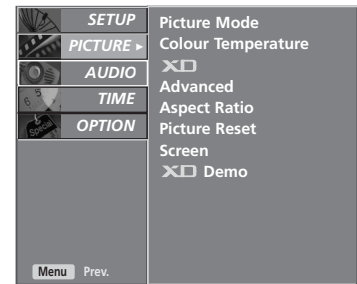

1



2

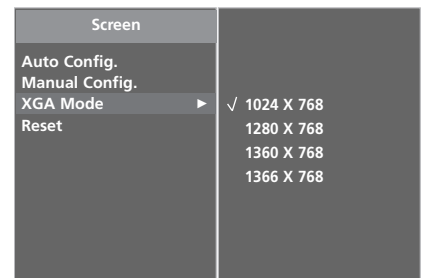

3 4

## Initializing (Reset to original factory settings)

This function operates in current mode.  
To initialize the adjusted value

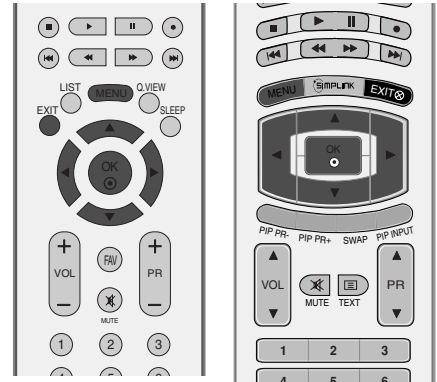

- 1 Press the MENU button and then use ▲ / ▼ button to select the **PICTURE** menu.
- 2 Press the ► button and then use ▲ / ▼ button to select **Screen**.
- 3 Press the ► button and then use ▲ / ▼ button to select **Reset**.
- 4 Press the ► button.
  - You can initialize Position.
- 5 Press the EXIT button to return to TV viewing.

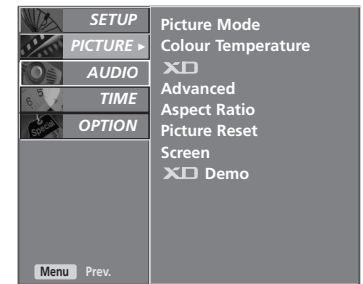

1

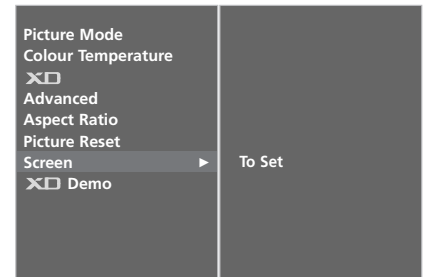

2

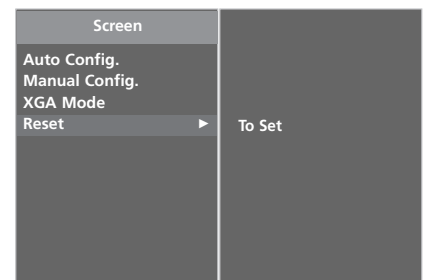

3 4



# WATCHING TV / PROGRAMME CONTROL

## REMOTE CONTROL KEY FUNCTIONS

When using the remote control, aim it at the remote control sensor on the TV.

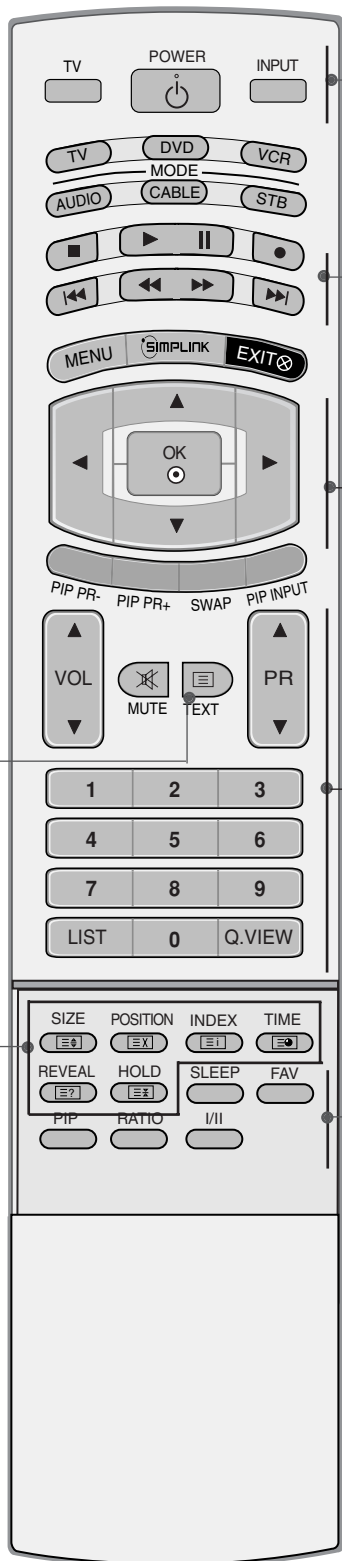

**TV** Returns to the TV viewing from any mode. Switches the set on from standby.

**POWER** Switches the set on from standby or off to standby.

**INPUT** External input mode rotate in regular sequence.

**VCR/DVD control buttons** Controls video cassette recorders or DVD players when you select DVD or VCR mode button. Control connected AV devices by pressing the ▲ or ▼ or ◀ or ▶, OK buttons and buttons for play, stop, pause, fast reverse, fast forward, chapter skip. (The ● button does not provide such functions.)

**THUMBSTICK (Up/Down/Left Right)** Allows you to navigate the on-screen menus and adjust the system settings to your preference.

**OK** Accepts your selection or displays the current mode.

**VOLUME UP /DOWN** Adjusts the volume.

**MUTE** Switches the sound on or off.

**1 TELETEXT BUTTONS** These buttons are used for teletext. For further details, see the 'Teletext' section.

**Programme UP/DOWN** Selects a programme.

**0~9 number button** Selects a programme. Selects numbered items in a menu.

**LIST** Displays the programme list.

**Q.VIEW** Returns to the previously viewed programme.

**SLEEP** Sets the sleep timer.

**FAV** Displays the selected favourite programme.

**PIP** Switches the sub picture PIP, DW or off mode.

**RATIO** Selects your desired picture format.

**I/II** Selects the sound output.

WATCHING TV / PROGRAMME CONTROL

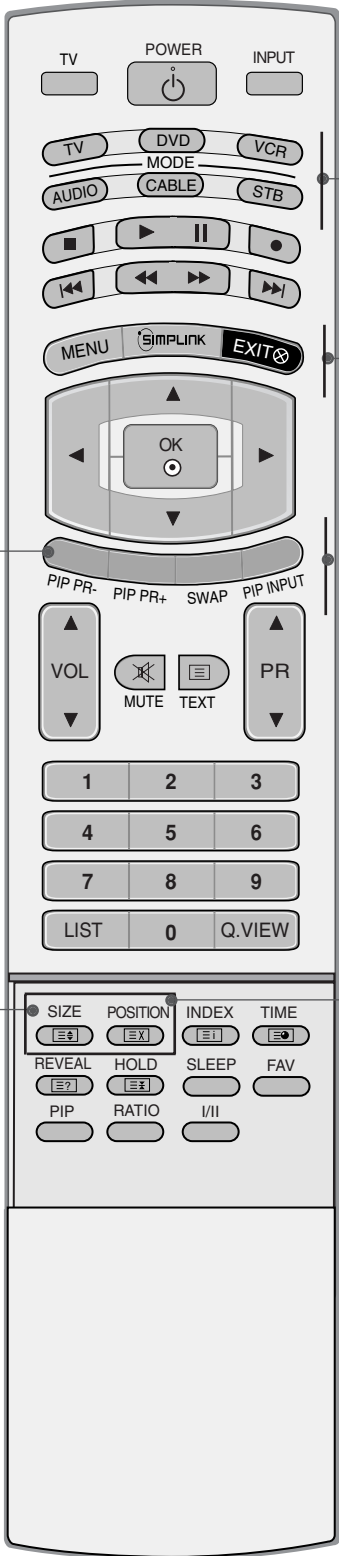

**MODE** Selects the remote operating modes.

**MENU** Selects a menu.

**SIMPLINK** See a list of AV devices connected to TV. When you toggle this button, the Simplink menu appears at the screen. (▶ p.49)

**EXIT** Clears all on-screen displays and returns to TV viewing from any menu.

**2** **PIP PR** Selects a programme for the sub picture.  
- /+  
**SWAP** Exchanges the main/sub images in PIP/Double window.

**PIP INPUT** Selects the input source for the sub picture in PIP/Double window mode.

**Coloured buttons** These buttons are used for teletext (only **TELETEXT** models) or **Programme edit**.

**SIZE** Adjusts the sub picture size.

**POSITION** Moves the sub picture.

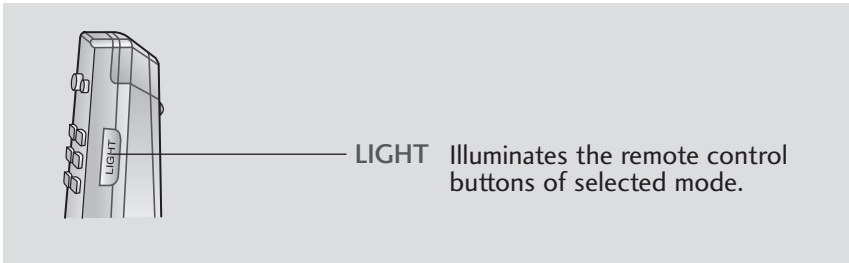

### Installing Batteries

- Open the battery compartment cover on the back and install the batteries matching correct polarity (+with +,- with -).
- Install two 1.5V AA batteries. Don't mix old or used batteries with new ones.
- Close cover.

# WATCHING TV / PROGRAMME CONTROL

## REMOTE CONTROL KEY FUNCTIONS

When using the remote control, aim it at the remote control sensor on the TV.



**POWER** Switches the set on from standby or off to standby.

**TV INPUT** Returns to the TV viewing from any mode. Switches the set on from standby.

**INPUT** If you press the button once, the input source OSD will appear on screen as shown. Press the ▲ / ▼ button and then OK button to select the desired input source (TV, AV1, AV2, Component1, Component2, RGB, HDMI1/DVI or HDMI2).

**RATIO** Selects your desired picture format.

**Brightness adjustment** Adjusts screen brightness. This returns to the default settings brightness by changing mode source.

**1** **PIP** Switches the sub picture PIP, DW mode.

**PIP PR - /+** Selects a programme for the sub picture.

**SWAP** Exchanges the main/sub images in PIP/Double window.

**PIP INPUT** Selects the input source for the sub picture in PIP/DW picture mode.

**SIZE** Adjusts the sub picture size.

**POSITION** Moves the sub picture.

**VCR/DVD control buttons** Controls video cassette recorders or DVD players when you select DVD or VCR mode button. Control connected AV devices by pressing the ▲ / ▼ / ◀ / ▶, OK buttons and buttons for play, stop, pause, fast reverse, fast forward, chapter skip. (The ○ button does not provide such functions.)

**EXIT** Clears all on-screen displays and returns to TV viewing from any menu.

**LIST** Displays the programme list.

**MENU** Selects a menu.

**Q.VIEW** Returns to the previously viewed programme.

**SLEEP** Sets the sleep timer.



**MODE** Selects the remote operating modes.

**2 TELETEXT BUTTONS** These buttons are used for teletext. For further details, see the 'Teletext' section.

**SIMPLINK** See a list of AV devices connected to TV. When you toggle this button, the Simplink menu appears at the screen. (▶ p.49)

**I/II** Selects the sound output.

**Coloured buttons** These buttons are used for teletext (on TELETEXT models only) or **Programme edit**.

**THUMBSTICK** Allows you to navigate the on-screen menus and adjust the system settings to your preference. (Up/Down/Left/Right)

**OK** Accepts your selection or displays the current mode.

**VOLUME UP/DOWN** Adjusts the volume.

**FAV** Displays the selected favourite programme.

**MUTE** Switches the sound on or off.

**Programme UP/DOWN** Selects a programme.

**0~9 number buttons** Selects a programme. Selects numbered items in a menu.

### Installing Batteries

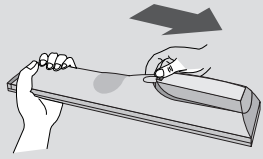

- Open the battery compartment cover on the back and install the batteries matching correct polarity (+with +,-with -).
- Install two 1.5V AA batteries. Do not mix old or used batteries with new ones.
- Close cover.

# WATCHING TV / PROGRAMME CONTROL

## TURNING ON THE TV

When your TV is turned on, you will be able to use its features.

- 1 Firstly, connect the power cord correctly.  
At this stage, the TV switches to standby mode.
  - In standby mode to turn TV on, press the  $\phi/1$ , **INPUT**, **PR ▲ / ▼** button on the TV or press the **POWER**, **TV**, **INPUT**, **PR ▲ / ▼**(or **PR + / -**), **Number(0~9)** button on the remote control and the TV will switch on.

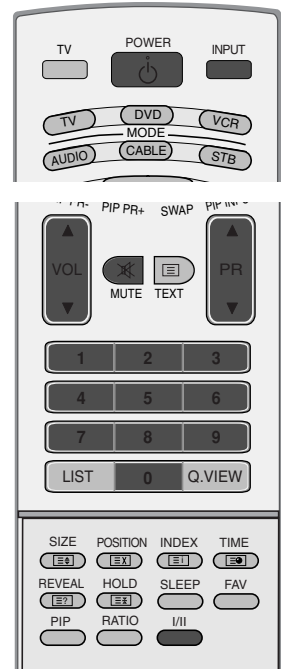

## PROGRAMME SELECTION

- 1 Press the **PR ▲ / ▼**(or **PR + / -**) or **NUMBER** buttons to select a programme number.

## VOLUME ADJUSTMENT

- 1 Press the **VOL ▲ / ▼**(or **VOL + / -**) button to adjust the volume.
- 2 If you wish to switch the sound off, press the **MUTE** button.
- 3 You can cancel the Mute function by pressing the **MUTE**, **VOL ▲ / ▼**(or **VOL + / -**) or **I/II** button.

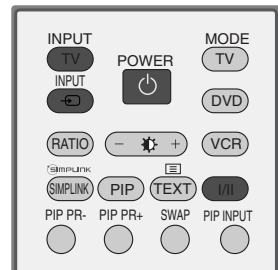



# ON SCREEN MENUS SELECTION AND ADJUSTMENT

Your TV's OSD (On Screen Display) may differ slightly from that shown in this manual. The OSD mainly use pictures for the Plasma TV models.

- 1 Press the **MENU** button and then ▲ / ▼ button to display each menu.
- 2 Press the ► button and then ▲ / ▼ button to select a menu item.
- 3 Change the setting of an item in the sub or pull-down menu with ◀ / ▶ button. You can move to a higher level menu by pressing the **OK** or **MENU** button.

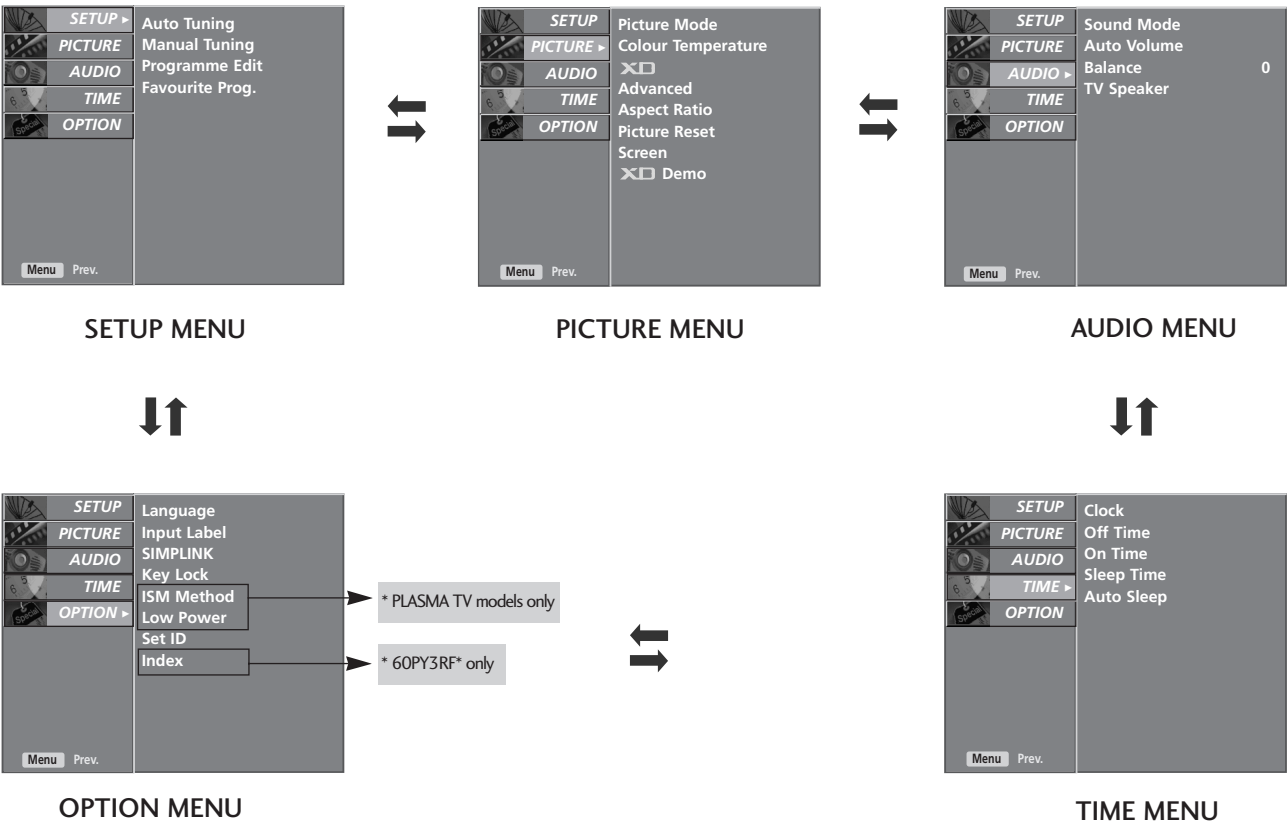

## ! NOTE

- a. The OSD (On Screen Display) function enables you to adjust the screen status conveniently since it provides graphical presentation.
- b. In this manual, the OSD (On Screen Display) may be different from your TV's because it is just example to help the TV operation.
- c. In the teletext mode, menus are not displayed

# WATCHING TV / PROGRAMME CONTROL

## AUTO PROGRAMME TUNING

Up to 100 TV stations can be stored by programme numbers (0 to 99). Once you have preset the stations, you will be able to use the PR ▲ / ▼ (or PR + / -) or NUMBER buttons to scan the stations you have programmed.

Stations can be tuned using automatic or manual modes.

All stations which can be received are stored by this method. It is recommended that you use Auto tuning during installation of this set.

**1** Press the **MENU** button and then ▲ / ▼ button to select the **SETUP** menu.

**2** Press the ► button and then ▲ / ▼ button to select **Auto Tuning**.

**3** Press the ► button and then ▲ / ▼ button to select **System**.

**4** Press the ◀ / ▶ button to select a TV system menu;  
 BG: PAL B/G, SECAM B/G (Europe / East Europe / Asia / New/Zeland / M.East / Africa / Australia)  
 I : PAL I/II (U.K. / Ireland / Hong Kong / South Africa)  
 DK: PAL D/K, SECAM D/K (East Europe / China / Africa / CIS)  
 M : (USA / Korea / Philippines)

**5** Press the ▲ / ▼ button to select **Storage From**.

**6** Press the ◀ / ▶ button or NUMBER buttons to select the beginning programme number. If you use NUMBER buttons, any number under 10 is entered with a numeric '0' in front of it, i.e. '05' for 5.

**7** Press the ▲ / ▼ button to select **Start**.

**8** Press the ► button to begin auto tuning.  
 All receivable stations are stored.

To stop auto tuning, press the **MENU** button.

When auto tuning is complete, the Programme.

Edit menu appears on the screen. See the Programme edit section to edit the stored programme.

**9** Press the **EXIT** button to return to normal TV viewing.

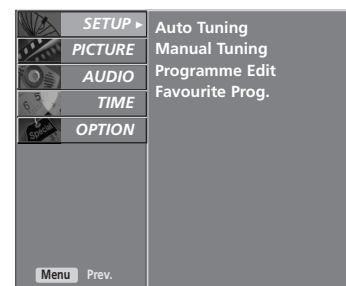
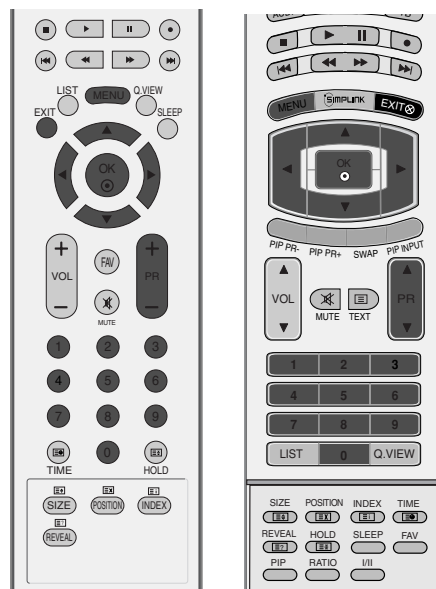

**1**

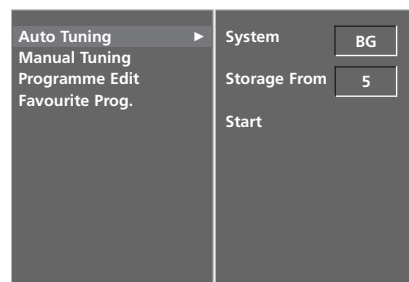

**2 3 4 5 6 7**

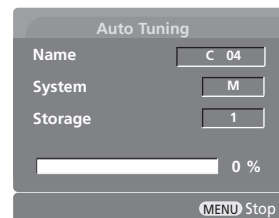

**8**

# MANUAL PROGRAMME TUNING

Manual programme lets you manually tune and arrange the stations in whatever order you desire.

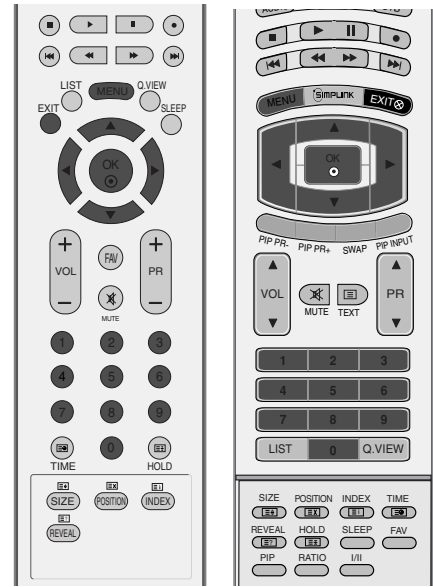

- 1 Press the **MENU** button and then **▲ / ▼** button to select the **SETUP** menu.
- 2 Press the **▶** button and then **▲ / ▼** button to select **Manual Tuning**.
- 3 Press the **▶** button and then **▲ / ▼** button to select **Storage**.
- 4 Press the **◀ / ▶** button or **NUMBER** buttons to select the desired programme number (0 to 99). If you use **NUMBER** buttons, any number under 10 is entered with a numeric '0' in front of it, i.e. '05' for 5.
- 5 Press the **▲ / ▼** button to select **System**.
- 6 Press the **◀ / ▶** button to select a TV system menu;
  - BG: PAL B/G, SECAM B/G (Europe / East Europe / Asia / NewZealand / M.East / Africa / Australia)
  - I : PAL I/II (U.K. / Ireland / Hong Kong / South Africa)
  - DK: PAL D/K, SECAM D/K (East Europe / China / Africa / CIS)
  - M : (USA / Korea / Philippines)
- 7 Press the **▲ / ▼** button to select **Band**.
- 8 Press the **◀ / ▶** button to select **V/UHF** or **Cable**.
- 9 Press the **▲ / ▼** button to select **Channel**.
- 10 You can select the desired programme number with the **◀ / ▶** button or number buttons. If possible, select the programme number directly with the number buttons. Any number under 10 is entered with a numeric '0' in front of it, i.e. '05' for 5.
- 11 Press the **▲ / ▼** button to select **Search**.
- 12 Press the **◀ / ▶** button to commence searching. If a station is found the search will stop.
- 13 Press the **OK** button to store it.
- 14 To store another station, repeat steps 3 to 13.
- 15 Press the **EXIT** button to return to normal TV viewing.



1

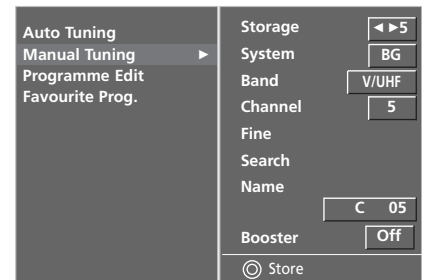

- 2
- 3
- 4
- 5
- 6
- 7
- 8
- 9
- 10
- 11
- 12

# WATCHING TV / PROGRAMME CONTROL

## FINE TUNING

Normally fine tuning is only necessary if reception is poor.

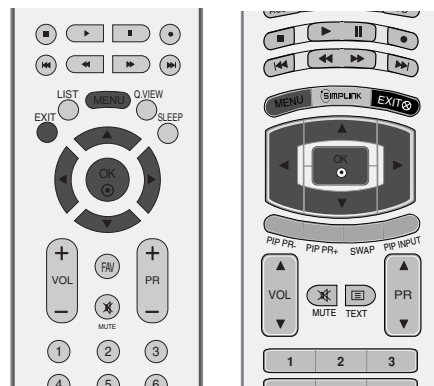

1 Press the **MENU** button and then ▲ / ▼ button to select the **SETUP** menu.

2 Press the ► button and then ▲ / ▼ button to select **Manual Tuning**.

3 Press the ► button and then ▲ / ▼ button to select **Fine**.

4 Press the ◀ / ▶ button to fine tune for the best picture and sound.

5 Press the **OK** button to store it.

6 Press the **EXIT** button to return to normal TV viewing.



1

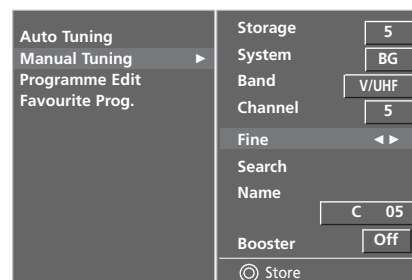

2 3 4 5

# ASSIGNING A STATION NAME

You can assign a station name up to five characters to each programme number.

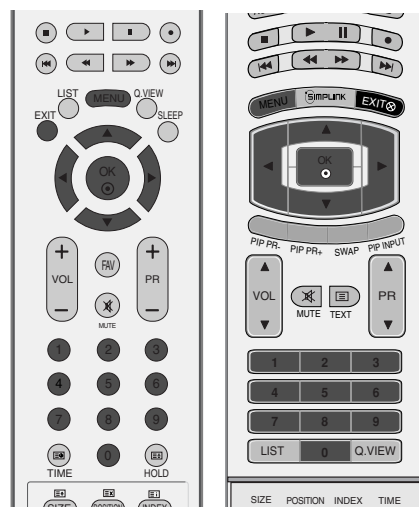

1 Press the **MENU** button and then **▲ / ▼** button to select the **SETUP** menu.

2 Press the **▶** button and then **▲ / ▼** button to select **Manual Tuning**.

3 Press the **▶** button and then **▲ / ▼** button to select **Name**.

4 Press the **▶** button and then **▲ / ▼** button. You can use a blank, **+**, **-**, the number **0** to **9** and the alphabet **A** to **Z**.

5 Press the **◀ / ▶** button to select the position and make your choice of the second character, and so on.

6 Press the **OK** button to store it.

7 Press the **EXIT** button to return to normal TV viewing.



1

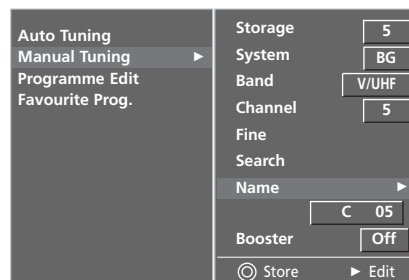

2 3 4 5 6

# WATCHING TV / PROGRAMME CONTROL

## BOOSTER<sup>(60PY3RF\* only)</sup>

In some models, **Booster** is an optional function. Only a set with **Booster** can perform this function.

If reception is poor select **Booster** to On.

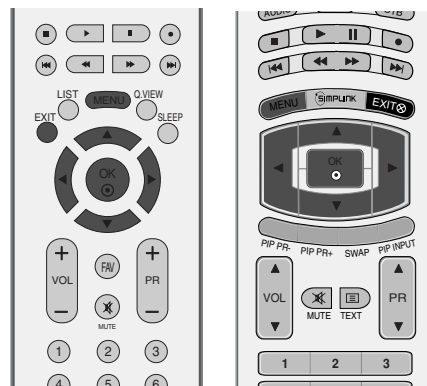

**1** Press the **MENU** button and then **▲ / ▼** button to select the **SETUP** menu.

**2** Press the **▶** button and then **▲ / ▼** button to select **Manual Tuning**.

**3** Press the **▶** button and then use **▲ / ▼** button to select **Booster**.

**4** Press the **▶** button and then use **◀ / ▶** button to select **On** or **Off**.

**5** Press the **EXIT** button to return to normal TV viewing.

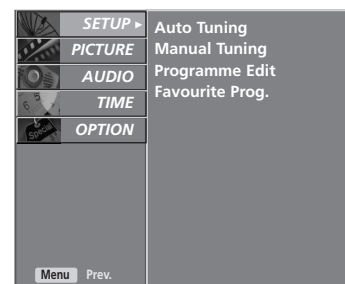

**1**

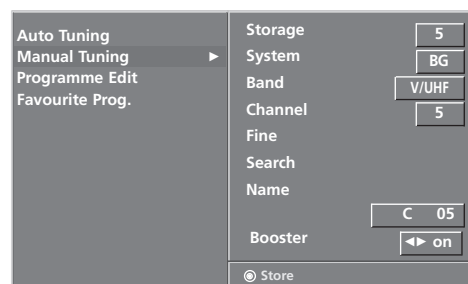

**2 3**

# PROGRAMME EDIT

This function enables you to delete or skip stored programmes. You can also move some channels to other programme numbers or copy a blank channel data into the selected programme number.

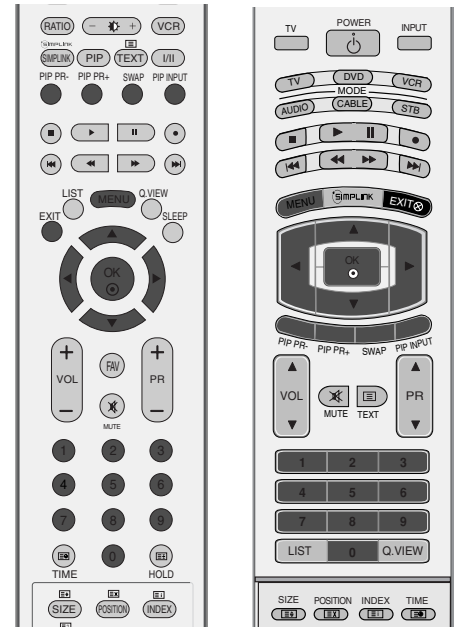

- 1 Press the **MENU** button and then ▲ / ▼ button to select the **SETUP** menu.
- 2 Press the ► button and then ▲ / ▼ button to select **Programme Edit**.
- 3 Press the ► button to display the Programme edit menu.

### ■ Deleting a programme

1. Select a programme to be deleted with the ▲ / ▼ / ◀ / ▶ button.
2. Press the RED button twice.  
The selected programme is deleted, all the following programmes are shifted up one position.

### ■ Copying a programme

1. Select a programme to be copied with the ▲ / ▼ / ◀ / ▶ button.
2. Press the GREEN button.  
All the following programmes are shifted down one position.

### ■ Moving a programme

1. Select a programme to be moved with the ▲ / ▼ / ◀ / ▶ button.
2. Press the YELLOW button.
3. Move the programme to the desired programme number with the ▲ / ▼ / ◀ / ▶ button.
4. Press the YELLOW button again to release this function.

### ■ Skipping a programme number

1. Select a programme number to be skipped with the ▲ / ▼ / ◀ / ▶ button.
2. Press the BLUE button. The skipped programme turns to blue.
3. Press the BLUE button again to release the skipped programme.

When a programme number is skipped it means that you will be unable to select it using the ▲ / ▼ button during normal TV viewing. If you want to select the skipped programme, directly enter the programme number with the NUMBER buttons or select it in the programme edit or table menu.

- 4 Press the **EXIT** button to return to normal TV viewing.



1



2

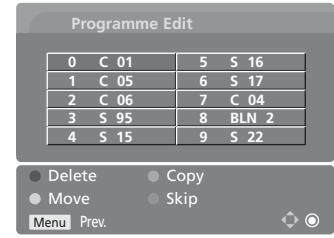

3

# WATCHING TV / PROGRAMME CONTROL

## FAVOURITE PROGRAMME

This function lets you select your favourite programmes directly.

Repeatedly press the **FAV** button to select stored favourite programmes.

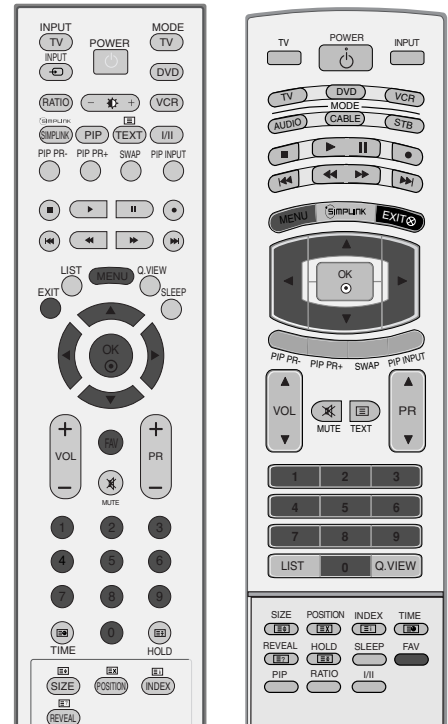

- 1 Press the **MENU** button and then **▲ / ▼** button to select the **SETUP** menu.

---

- 2 Press the **▶** button and then **▲ / ▼** button to select **Favourite Prog..**

---

- 3 Press the **▶** button.

---

- 4 Press the **▲ / ▼** button to select - - - - -.

---

- 5 Select a desired programme with the **◀ / ▶** button or **NUMBER** buttons. Any number under 10 is entered with a numeric '0' in front of it, i.e. '05' for 5.

---

- 6 To store another programme, repeat steps **4** to **5**. You can store up to 8 programmes.

---

- 7 Press the **EXIT** button to return to normal TV viewing.



1

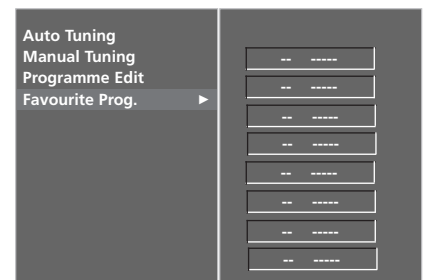

2 3 4 5



# CALLING THE PROGRAMME LIST

You can check the programmes stored in the memory by displaying the programme list.

## ■ Displaying programme list

Press the **LIST** button to display the Programme list menu.

The programme list appears on the screen.

One programme list contains ten programmes as shown.

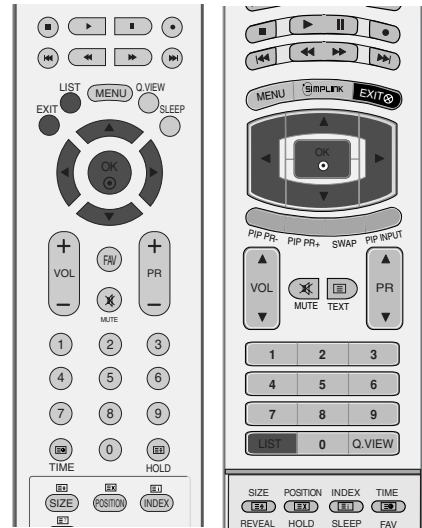

## ! NOTE

- a. You may find some blue programmes. They have been set up to be skipped by auto programming or in the programme edit mode.
- b. Some programmes with the channel number shown in the programme list indicate there is no station name assigned.

## ■ Selecting a programme in the programme list

Select a programme with the **▲ / ▼ / ◀ / ▶** button.

Then press the **OK** button. The set switches to the chosen programme number.

## ■ Paging through a programme list

There are 10 programme list pages in which contain 100 programmes. Pressing the **▲ / ▼ / ◀ / ▶** button repeatedly turns the pages.

Press the **LIST** button to return to normal TV viewing.

0	-----	5	S 02
1	C 01	6	S 04
2	C 04	7	C 08
3	C 05	8	S 11
4	BLN 2	9	S 28

# WATCHING TV / PROGRAMME CONTROL

## INPUT SOURCE SELECTION

Selects a label for each input source which is not in use when you press **INPUT** button.

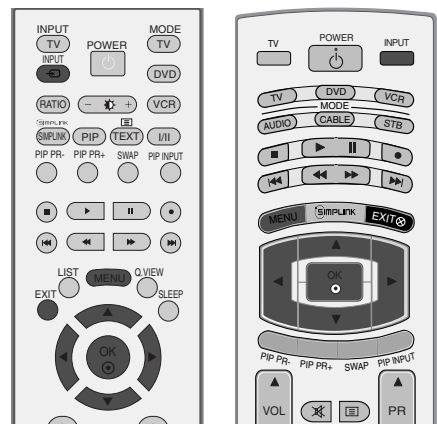

- 1 Press the **MENU** button and then use ▲ or ▼ button to select the **OPTION** menu.
- 2 Press the ► button and then use ▲ or ▼ button to select **Input Label**.
- 3 Press the ► button and then use ▲ or ▼ button to select the source: AV1, AV2, Component1/2, RGB, HDMI1/DVI or HDMI2.
- 4 Press the ► button and then use ▲ or ▼ button to select the label.
- 5 Press **EXIT** button to return to normal TV viewing.



1



2

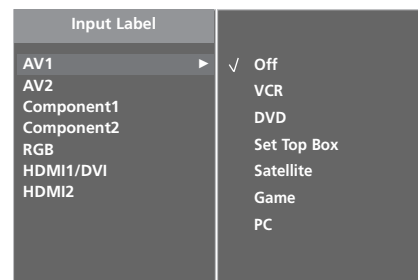

3



This function operates only with devices with the SIMPLINK logo.

Please check the SIMPLINK logo.

This allows you to control and play other AV devices connected to the display through HDMI cable without additional cables and settings.

If you do not require the SIMPLINK menu, select "OFF".

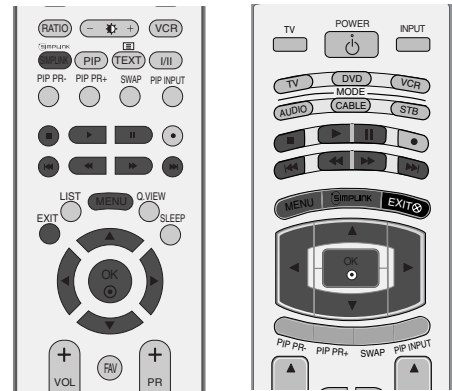

1 Press the **MENU** button and then ▲ / ▼ button to select the **OPTION** menu.

2 Press the ► button and then ▲ / ▼ button to select **SIMPLINK**.

3 Press the ► button and then ▲ / ▼ button to select **On** or **Off**.

4 Press the **EXIT** button to return to normal TV viewing.



1

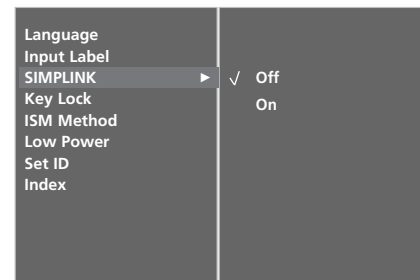

2 3

# WATCHING TV / PROGRAMME CONTROL

## SIMPLINK Functions

### Disc playback

Control connected AV devices by pressing the ▲ / ▼ / ◀ / ▶, OK buttons and buttons for play, stop, pause, fast reverse, fast forward, chapter skip. (The  button does not provide such functions)

### Direct Play

After connecting AV devices to the TV, you can directly control the devices and play media without additional settings.

### Select AV device

Enables you to select one of AV devices connected to TV and play it.

### Power off all devices

When you switch off the TV, all connected devices are turned off.

### Switch audio-out

Offers an easy way to switch audio-out.

\* A device, which is connected to the TV through a HDMI cable but does not support SIMPLINK, does not provide this function.

## SIMPLINK Menu

Press the ▲ / ▼ / ◀ / ▶ button and then OK button to select the desired SIMPLINK source.

- 1 **TV viewing** : Switch to the previous TV programme regardless of the current mode.
- 2 **DISC playback** : Select and play discs. When multiple discs are available, the titles of the discs are conveniently displayed at the bottom of the screen.
- 3 **VCR playback** : Control the connected VCR.
- 4 **HDD Recordings playback** : Control recordings stored in HDD.
- 5 **Audio Out to Home theatre/Audio Out to TV** : Select Home theater or TV speaker for Audio Out.



### NOTE

- ▶ Connect the HDMI/DVI IN or HDMI IN terminal of the TV to the rear terminal (HDMI terminal) of the SIMPLINK device with the HDMI cable.
- ▶ After connecting the HDMI terminal for the home theatre with SIMPLINK function using the above method, connect the VARIABLE AUDIO OUT terminal on the back of the TV to the VARIABLE AUDIO IN terminal on the back of the SIMPLINK device with the VARIABLE AUDIO OUT cable.
- ▶ When operating an external device with SIMPLINK, press the TV button from the MODE buttons on the remote control.
- ▶ When you switch the Input source using the INPUT button on the remote control, you can stop the operation of a device controlled by SIMPLINK.
- ▶ When you select or operate a media device with home theatre function, the speaker automatically switches to home theatre speaker (HT speaker).

# KEY LOCK

The TV can be set so that the remote control is needed to control it.

This feature can be used to prevent unauthorized viewing.

This set is programmed to remember which option it was last set to even if you turn the set off.

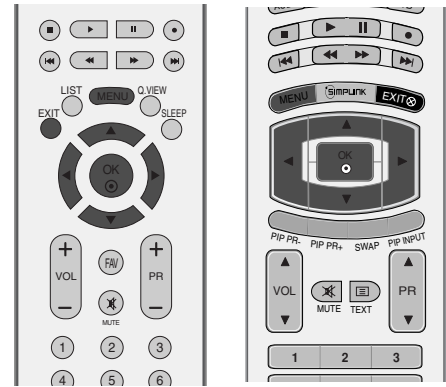

**1** Press the **MENU** button and then **▲ / ▼** button to select the **OPTION** menu.

**2** Press the **▶** button and then **▲ / ▼** button to select **Key Lock**.

**3** Press the **▶** button and then **▲ / ▼** button to select **On** or **Off**.

**4** Press the **EXIT** button to return to normal TV viewing.

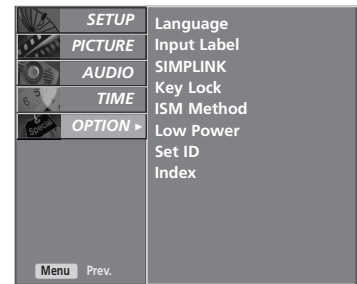

**1**

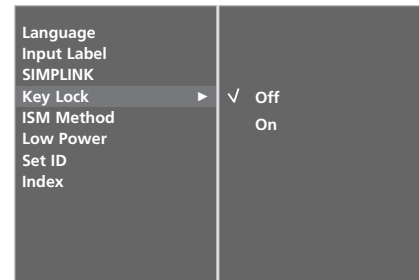

**2 3**

## ! NOTE

- ▶ In **Key Lock 'On'**, if the set is turned off, press the **⏻ / I**, **INPUT**, **PR ▲ / ▼** button on the set or **POWER**, **INPUT**, **TV**, **PR ▲ / ▼ (PR +/-)** or **NUMBER** buttons on the remote control then the set will be turned on.
- ▶ With the **Key Lock On**, the display **'Key Lock on'** appears on the screen if any button on the front panel is pressed while viewing the set.

# PICTURE CONTROL

## WATCHING PIP(PICTURE-IN-PICTURE)

PIP lets you view 2 different inputs (sources) on your TV screen at the same time. One source will be large, and the other source will show a smaller inset image.

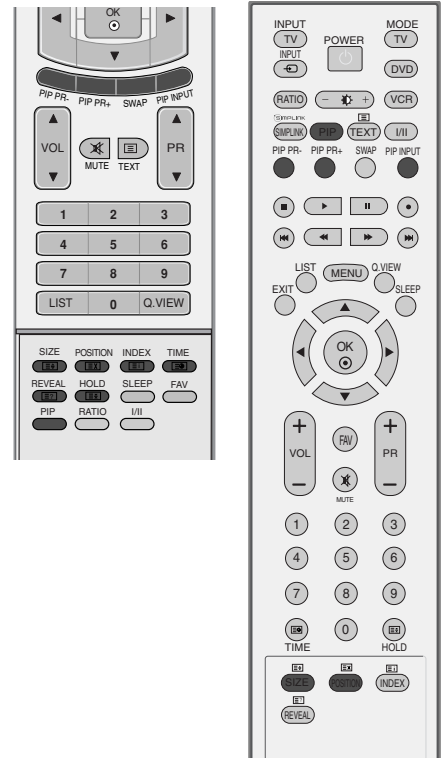

## Watching PIP/Double Window

Press the **PIP** button to access the sub picture.  
Each press of PIP changes the PIP options.

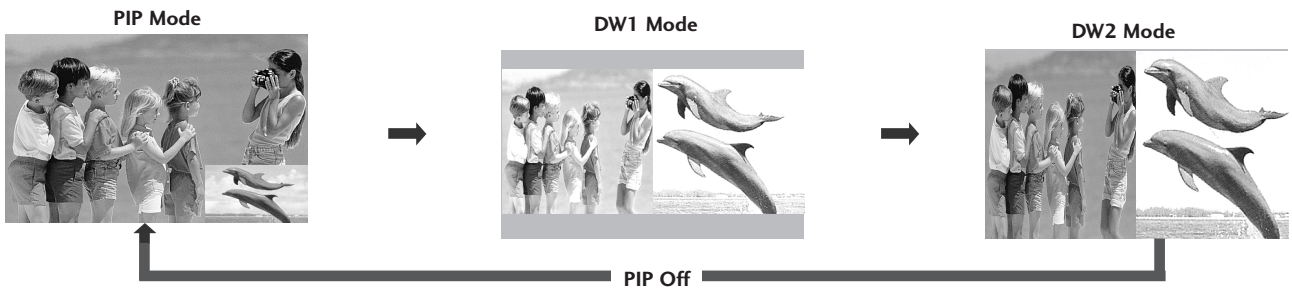

## Programme Selection for Sub Picture

Press the **PIP PR +/-** button to select a programme for the sub picture.

The selected programme number is displayed just below the programme number of main picture.

## Input Source Selection for Sub Picture

Press the **PIP INPUT** button to select the input source for the sub picture.  
Each press of **PIP INPUT** button is pressed, each input source for the sub picture is displayed.

## Sub Picture Size Adjustment (PIP mode only)

Press the **SIZE** button to adjust the sub picture size.  
With **SIZE** button in PIP mode, sub picture is adjusted.

## Moving the Sub Picture (PIP mode only)

Press the **POSITION** button.  
Repeatedly press the **POSITION** button then sub picture moves.

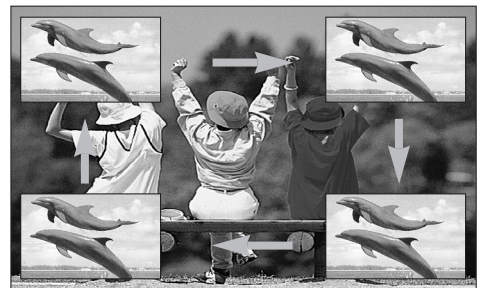

# PICTURE CONTROL

## PICTURE SIZE (ASPECT RATIO) CONTROL

You can watch the screen in various picture formats; **Spectacle**, **Original**, **4:3**, **16:9**, **14:9**, **Zoom1/2** and **1:1 Pixel**.

If a fixed image is displayed on the screen for a long time, that fixed image may become imprinted on the screen and remain visible.

There might be uncomfortable in full mode. Then change into other mode.

You can adjust the enlarge proportion using ▲ / ▼ button.

This function works in the following signal.

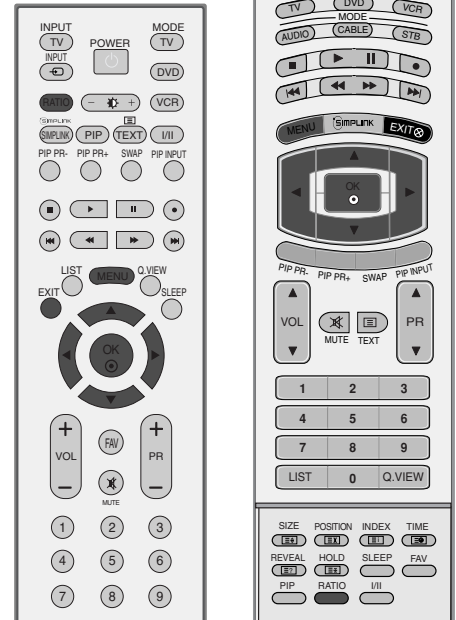

- 1 Press the **RATIO** button repeatedly to select the desired picture format.  
You can also adjust **Aspect Ratio** in the **PICTURE** menu.

### • Spectacle

When your TV receives the wide screen signal, when selected it will adjust the picture horizontally, in non-linear proportion, to fill the entire screen.

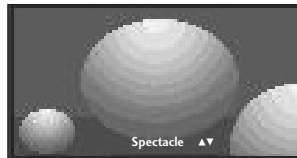

### • Original

When your TV receives a wide screen signal it will automatically change to the picture format to be broadcast.



### • 4:3

The following selection will allow you to view a picture with an original 4:3 aspect ratio, grey bars will appear on both the left and right hand of the screen.

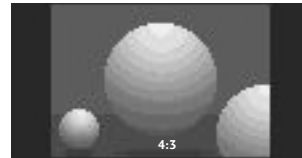

### • 16:9

The following selection will allow you to adjust the picture horizontally, in linear proportion, to fill the entire screen (useful for viewing 4:3 formatted DVDs).

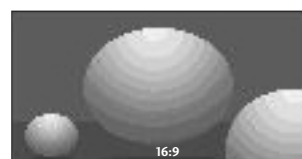



- **14:9**

You can view a picture format of 14:9 or a general TV programme in the 14:9 mode. The screen 14:9 is viewed in the same way as in 4:3, but is magnified to the left and right hand side.

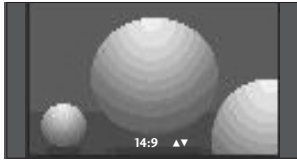

- **Zoom1**

The following selection will allow you to view the picture without any alteration, while filling the entire screen. However, the top and bottom of the picture will be cropped.

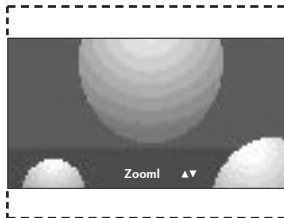

- **Zoom2**

Choose Zoom 2 when you wish the picture to be altered, both horizontally extended and vertically cropped. The picture adopting a compromise between alteration and screen coverage.

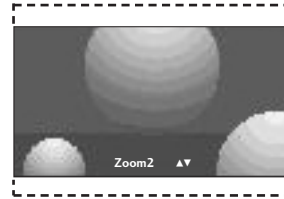

- **1:1 Pixel** (Except 60PC4R\*, 47LB9R\*)

Following Selection will lead to you view the picture of best quality without loss of original picture in high resolution image.

**! NOTE**

- ▶ You can only select **4:3**, **16:9** (Wide) in RGB-PC, HDMI-PC mode only.
- ▶ You can select **4:3**, **16:9**, **Zoom1**, **Zoom2** in Component, HDMI-DTV mode only.
- ▶ In HDMI(1080i 50Hz/60Hz, 1080p 50Hz/60Hz) mode, 1:1 Pixel is available.

# PICTURE CONTROL

## PRESET PICTURE SETTINGS

### Picture Mode-Preset

**Intelligent Eye** Adjusts picture according to the surrounding conditions. (LCD TV models only)

**Dynamic** Select this option to display a sharp image.

**Standard** The most general and natural screen display status.

**Mild** Select this option to display a mild image.

**User 1/2** Selection this option to use a user defined setting.

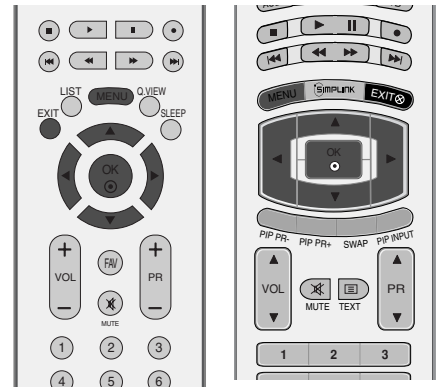

**1** Press the **MENU** button and then **▲ / ▼** button to select the **PICTURE** menu.

**2** Press the **▶** button and then **▲ / ▼** button to select **Picture Mode**.

**3** Press the **▶** button and then **▲ / ▼** button to select **Intelligent Eye** (LCD TV models only), **Dynamic**, **Standard**, **Mild**, **User 1** or **User 2**.

**4** Press the **EXIT** button to return to normal TV viewing.

- Picture Mode adjusts the TV for the best picture appearance. Select the preset value in the **Picture Mode** menu based on the programme category.
- Intelligent Eye (LCD TV models only), Dynamic, Standard and Mild are programmed for optimum picture reproduction at the factory and cannot be changed.
- When the Intelligent eye function is on, the most suitable picture is automatically adjusted according to the surrounding conditions. (LCD TV models only)

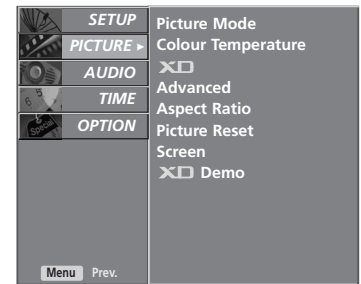

**1**

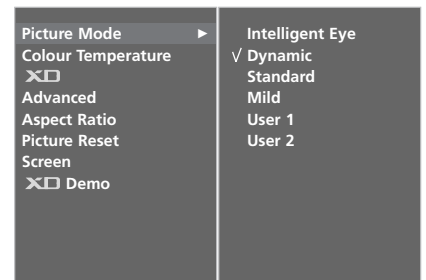

**2 3**

## Auto Colour Tone Control(Warm/Medium/Cool)

To initialize values (reset to default settings), select the Cool option.

Choose one of three automatic colour adjustments. Set to warm to enhance hotter colours such as red, or set to cool to see less intense colours with more blue.

This menu is activated after selecting “User1” or “User2” in the Picture Mode.

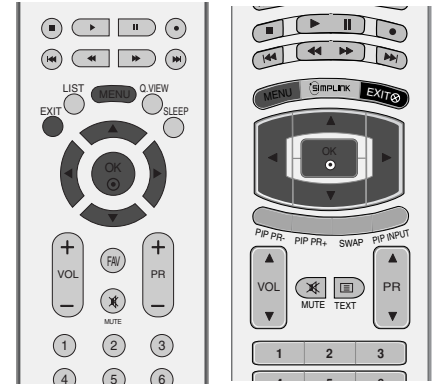

1 Press the **MENU** button and then ▲ / ▼ button to select the **PICTURE** menu.

2 Press the ► button and then ▲ / ▼ button to select **Colour Temperature**.

3 Press the ► button and then ▲ / ▼ button to select either **Cool**, **Medium**, **Warm** or **User**.

4 Press the **EXIT** button to return to normal TV viewing.

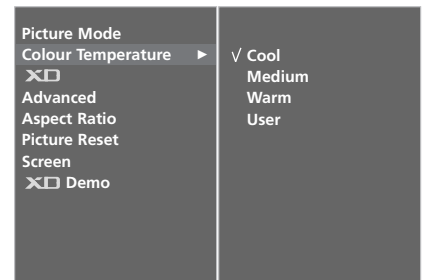
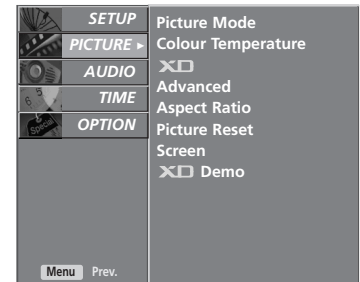

# PICTURE CONTROL

## MANUAL PICTURE ADJUSTMENT

### Picture Mode-User Option

- Contrast** Adjusts the difference between light and dark levels in the picture.
- Brightness** Increases or decreases the amount of white in the picture.
- Colour** Adjusts intensity of all colours.
- Sharpness** Adjusts the level of crispness in the edges between the light and dark areas of the picture. The lower the level, the softer the image.
- Tint** Adjusts the balance between red and green levels.

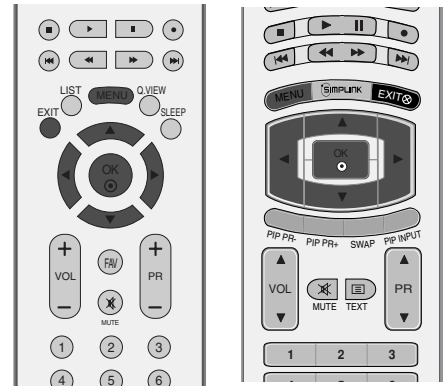

- 1 Press the **MENU** button and then **▲ / ▼** button to select the **PICTURE** menu.
- 2 Press the **▶** button and then **▲ / ▼** button to select **Picture Mode**.
- 3 Press the **▶** button and then **▲ / ▼** button to select **User 1** or **User 2**.
- 4 Press the **▶** button and then **▲ / ▼** button to select the desired picture option (**Contrast**, **Brightness**, **Colour**, **Sharpness** and **Tint**).
- 5 Press the **◀ / ▶** button to make appropriate adjustments.
- 6 Press the **EXIT** button to return to normal TV viewing.

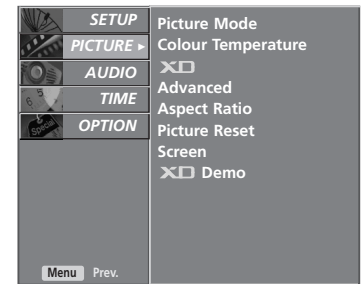

1

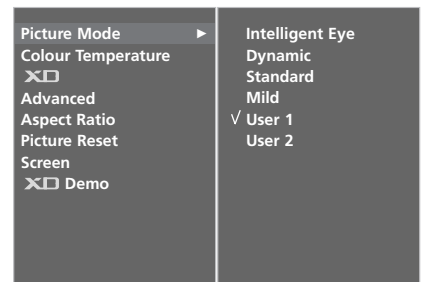

2 3



4 5

### NOTE

- ▶ You cannot adjust colour, sharpness and tint in the RGB-PC mode.

## Colour Tone - User Option

To adjust red, green, blue to the colour temperature you prefer.

It is possible to use this function in “User1” or “User2” of **Picture mode** only.

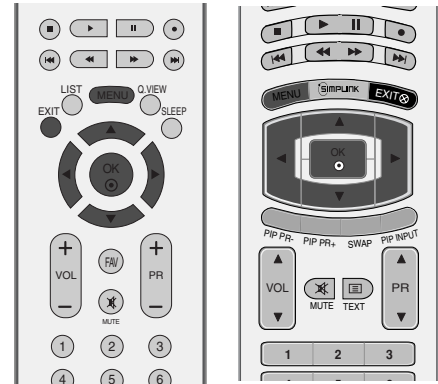

- 1 Press the **MENU** button and then ▲ / ▼ button to select the **PICTURE** menu.

---

- 2 Press the ► button and then ▲ / ▼ button to select **Colour Temperature**.

---

- 3 Press the ► button and then ▲ / ▼ button to select **User**.

---

- 4 Press the ► button and then ▲ / ▼ button to select **Red**, **Green** or **Blue**.

---

- 5 Press the ◀ / ▶ button to make appropriate adjustments.

---

- 6 Press the **EXIT** button to return to normal TV viewing.



1

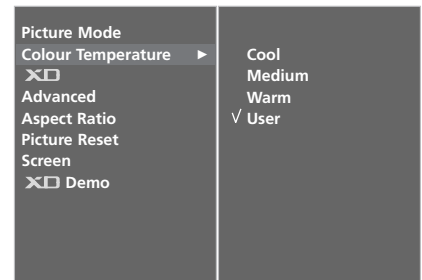

2 3

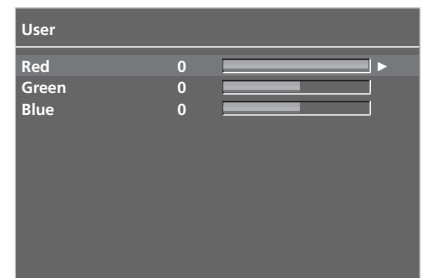

4 5

# PICTURE CONTROL

## XD - PICTURE IMPROVEMENT TECHNOLOGY

XD is LG electronic's unique picture improving technology to display a real HD source through an advanced digital signal processing algorithm.

It is not possible to use this function in RGB/HDMI-PC mode.

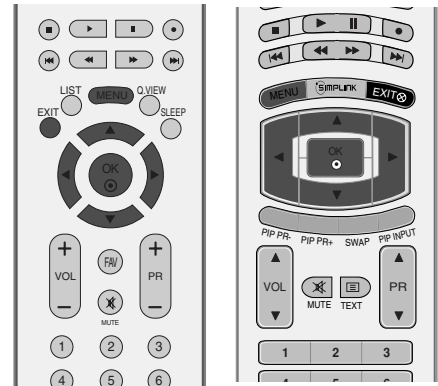

- 1 Press the MENU button and then ▲ / ▼ button to select the **PICTURE** menu.
- 2 Press the ► button and then ▲ / ▼ button to select **XD**.
- 3 Press the ► button and then ▲ / ▼ button to select **Auto** or **Manual**.
- 4 Press the EXIT button to return to TV viewing.

### \* Manual Selection

This menu is activated after selecting the **User1** or **User2** of Picture Mode.

- 1 Press the ► button and then ▲ / ▼ button to select **XD Contrast**, **XD Colour**, **XD NR** or **MPEG NR**.
- 2 Press the ► button and then ◀ / ▶ button to select **On** or **Off**.
- 3 Press the EXIT button to return to normal TV viewing.

- **XD Contrast** : Optimises the contract automatically according to the brightness of the reflection.
- **XD Colour** : Adjusts the colour of the reflection automatically to reproduce as close as possible to natural colours.
- **XD NR** : Removes interference up to the point where it does not damage the.
- **MPEG NR** : Reduces interference which may appear on the screen while watching TV.

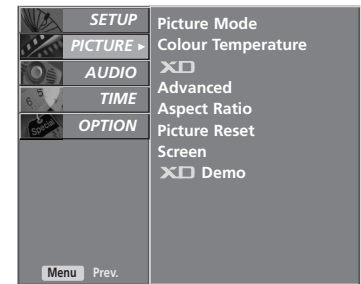

1

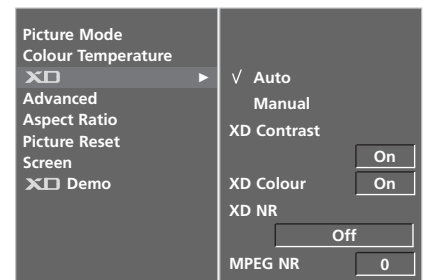

2 3

## ADVANCED - CINEMA

To set the TV up for the best picture quality for viewing films. This feature operates only in Analog TV, AV and Component 480i/576i mode.

- 1 Press the **MENU** button and then **▲ / ▼** button to select the **PICTURE** menu.
- 2 Press the **▶** button and then **▲ / ▼** button to select **Advanced**.
- 3 Press the **▶** button and then **▲ / ▼** button to select **Cinema**.
- 4 Press the **◀ / ▶** button to select **On** or **Off**.
- 5 Press the **EXIT** button to return to normal TV viewing.

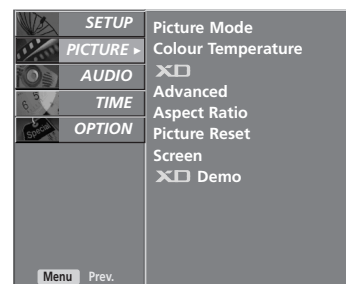
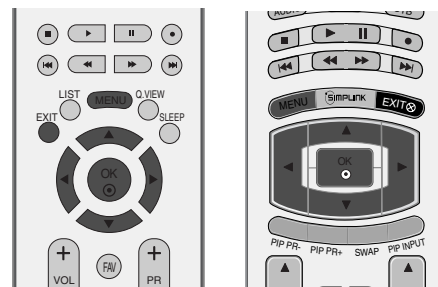

1

## ADVANCED - TRUMOTION (47LY3RF\* only)

It is used for the best picture quality without any motion blur or judder when you enter a quick image or Film Source.

It is not possible to use this function in RGB-PC, HDMI-PC, 1:1 Pixel and PIP mode.

- 1 Press the **MENU** button and then **▲ / ▼** button to select the **PICTURE** menu.
- 2 Press the **▶** button and then **▲ / ▼** button to select **Advanced**.
- 3 Press the **▶** button and then **▲ / ▼** button to select **TruMotion**.
- 4 Press the **◀ / ▶** button to select **Off, Low** or **High**.

- **Low** : Set amount of film judder to low.
- **High** : Set amount of film judder to high.

\* If you have some problem in viewing picture, set **TruMotion** to **Low** or **Off**.

- 5 Press the **EXIT** button to return to normal TV viewing.

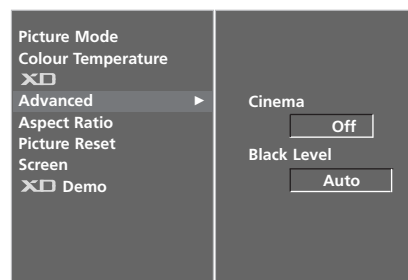

2 3

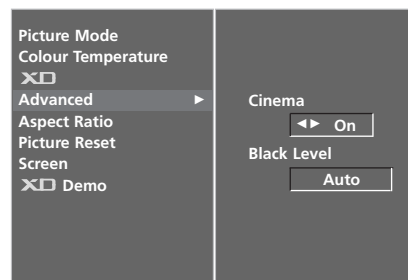

4

\* 47LY3RF\* only

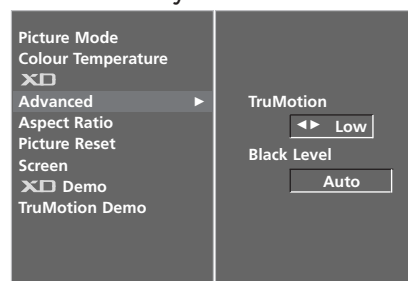

4

# PICTURE CONTROL

## ADVANCED - BLACK(DARKNESS) LEVEL

When you view a film this function adjust the set to best picture quality.

This function works in the following mode: AV (NTSC-M) or HDMI.

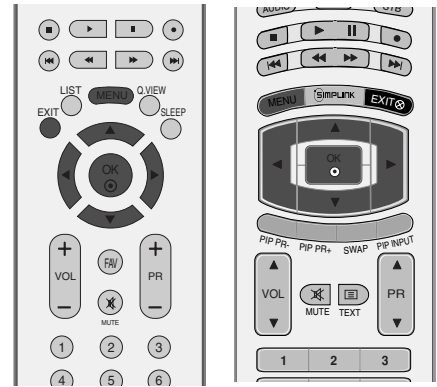

- 1 Press the **MENU** button and then ▲ / ▼ button to select the **PICTURE** menu.

---

- 2 Press the ► button and then ▲ / ▼ button to select **Advanced**.

---

- 3 Press the ► button and then ▲ / ▼ button to select **Black Level**.

---

- 4 Press the ◀ / ▶ button to select **Low** or **high**.
  - **Low** : The reflection of the screen gets darker.
  - **High** : The reflection of the screen gets brighter.

---

- 5 Press the **EXIT** button to return to normal TV viewing.

### ! NOTE

#### ■ Auto

Realizing the black level of the screen and set it to High or Low automatically.

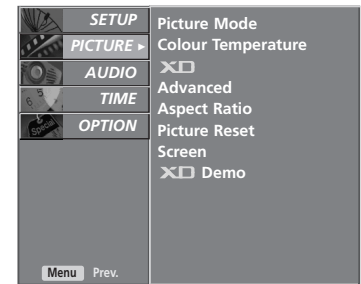

1

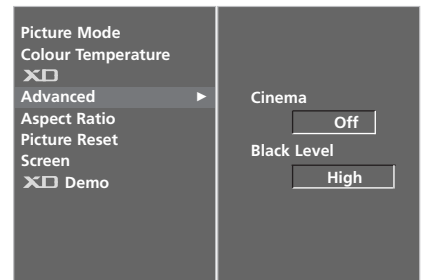

2 3

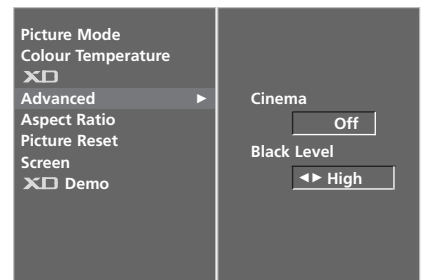

4



# PICTURE RESET

Returns to the default factory setting for Picture Mode, Colour Temperature, XD, Advanced and Aspect Ratio.

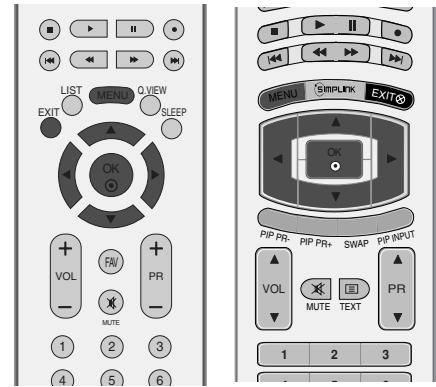

- 1 Press the **MENU** button and then **▲ / ▼** button to select the **PICTURE** menu.
- 2 Press the **▶** button and then **▲ / ▼** button to select **Picture Reset**.
- 3 Press the **▶** button to initialize the adjusted value.
- 4 Press the **EXIT** button to return to normal TV viewing.

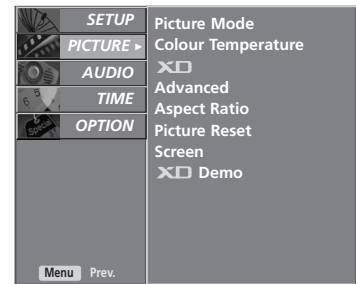

1

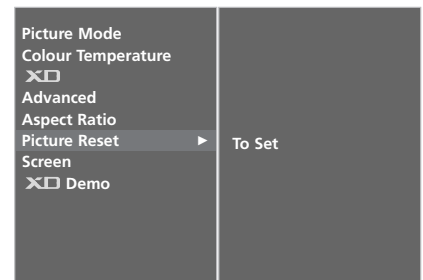

2 3

# PICTURE CONTROL

## XD DEMO

Use it to see the difference between XD Demo on and XD Demo off.

It is not possible to use this function in RGB/HDMI-PC mode.

- 1 Press the MENU button and then ▲ / ▼ button to select the **PICTURE** menu.
- 2 Press the ► button and then ▲ / ▼ button to select **XD Demo**.
- 3 Press the ► button to begin **XD Demo**.
- 4 To stop **XD Demo**, press the MENU button.

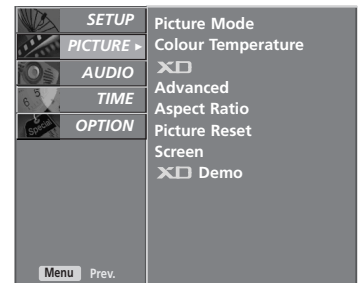
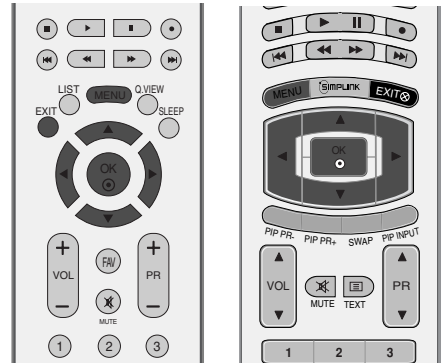

1

## TRUMOTION DEMO (47LY3RF\* only)

Use it to see the difference between TruMotion Demo on and TruMotion Demo off.

It's not available to use this function in RGB/HDMI-PC mode.

- 1 Press the MENU button and then ▲ / ▼ button to select the **PICTURE** menu.
- 2 Press the ► button and then ▲ / ▼ button to select **TruMotion Demo**.
- 3 Press the ► button to begin **TruMotion Demo**.
- 4 To stop **TruMotion Demo**, press the MENU button.

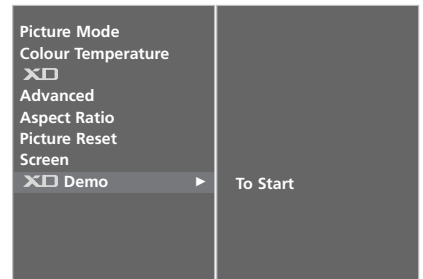

2 3

\* 47LY3RF\* only

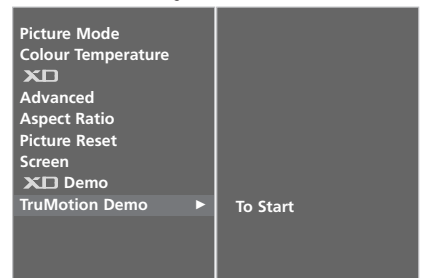

2 3

• XD Demo



• TruMotion Demo



# IMAGE STICKING MINIMIZATION(ISM)METHOD

A frozen or still picture from a PC/Video game displayed on the screen for prolonged periods will result in a ghost image remaining even when you change the image. Avoid allowing a fixed image to remain on the screen for prolonged periods.

It is not possible to use this function in LCD models.

## White wash

White wash removes permanent images from the screen.

Note: An excessive permanent image may be impossible to clear entirely with White Wash.

## Orbiter

Orbiter may help prevent ghost images. However, it is best not to allow any fixed image to remain on the screen. To avoid a permanent image on the screen, the screen will move every 2 minutes.

## Inversion

This function inverts the panel colour of the screen.

The panel colour is automatically inverted every 30 minutes.

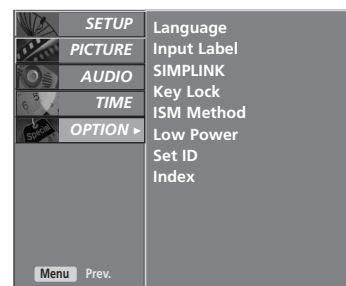
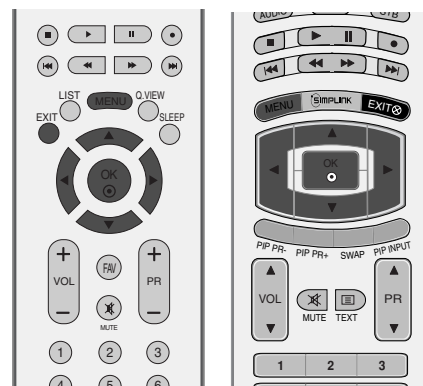

1

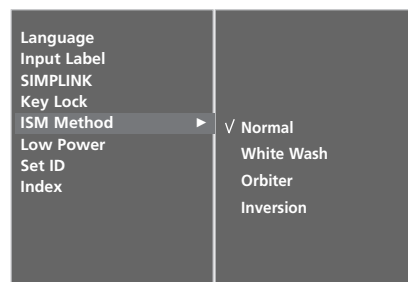

2 3

- 1 Press the **MENU** button and then **▲ / ▼** button to select the **OPTION** menu.
- 2 Press the **▶** button and then **▲ / ▼** button to select **ISM Method**.
- 3 Press the **▶** button and then **▲ / ▼** button to select either **Normal**, **White Wash**, **Orbiter** or **Inversion**. If you do not need this function, set Normal.
- 4 Press the **EXIT** button to return to TV viewing.

# PICTURE CONTROL

## LOW-POWER PICTURE MODE

This function allows you to reduce the power consumption of the set.

It is not possible to use this function in LCD models.

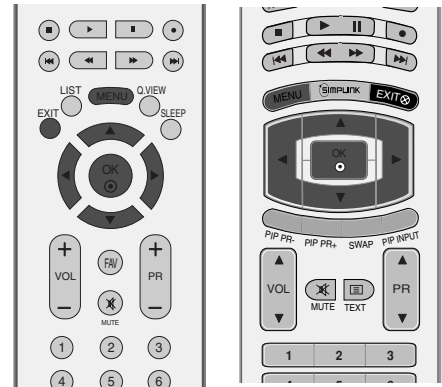

- 1 Press the **MENU** button and then ▲ / ▼ button to select the **OPTION** menu.
- 2 Press the ► button and then ▲ / ▼ button to select **Low Power**.
- 3 Press the ► button and then ▲ / ▼ button to select **On** or **Off**.
- 4 Press the **EXIT** button to return to TV viewing.



1

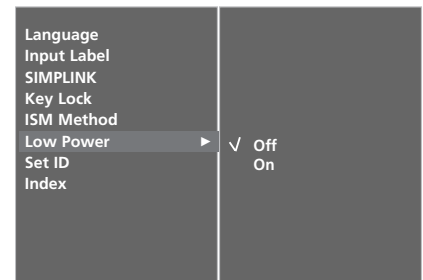

2 3

# INDEX (60PY3RF\* only)

You can switch FRONT DISPLAY on or off.

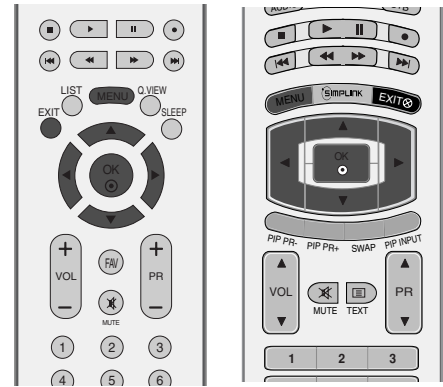

- 1 Press the **MENU** button and then ▲ / ▼ button to select the **OPTION** menu.
- 2 Press the ► button and then ▲ / ▼ button to select **Index**.
- 3 Press the ► button and then ▲ / ▼ button to select **On** or **Off**.

When you select **On** mode, the FRONT DISPLAY illuminates brightly.

- 4 Press the **EXIT** button to return to TV viewing.

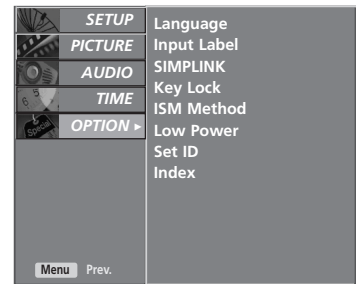

1

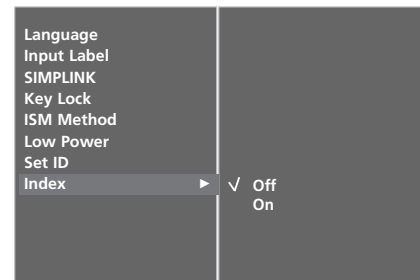

2 3

# SOUND & LANGUAGE CONTROL

## PRESET SOUND SETTINGS-SOUND MODE

You can select your preferred sound setting; SRS TSXT, Standard, Music, Movie or Sports and you can also adjust the frequency of the equalizer.

Sound Mode lets you enjoy the best sound without any Special adjustment as the TV sets the appropriate sound options based on the programme content.

**SRS TSXT, Standard, Music, Movie, and Sports** are preset for optimum sound quality at the factory and are not adjustable.

**SRS TSXT** Select this option for the most realistic sound.

**Standard** Commanding and natural audio.

**Music** Select this option to enjoy the original sound when listening to music.

**Movie** Select this option to enjoy sublime sound.

**Sports** Select this option when watching sports broadcasting.

**User** Select this option for user-defined audio settings.

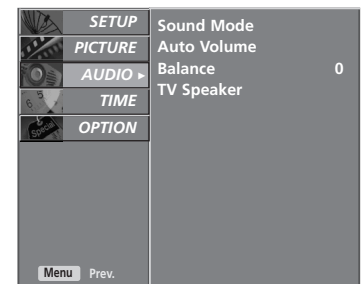
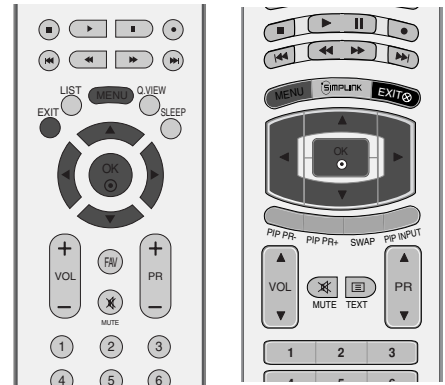

**1** Press the **MENU** button and then **▲ / ▼** button to select the **AUDIO** menu.

**2** Press the **▶** button and then **▲ / ▼** button to select **Sound Mode**.

**3** Press the **▶** button and then **▲ / ▼** button to select **SRS TSXT, Standard, Music, Movie, Sports** or **User**.

**4** Press the **EXIT** button to return to normal TV viewing.

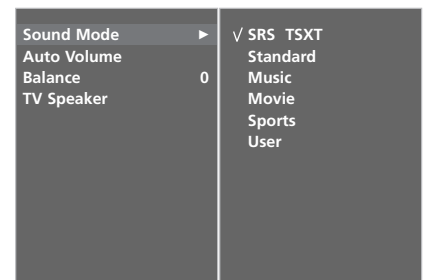

**2 3**

- ▶ is a trademark of SRS Labs, Inc.
- ▶ TruSurround XT technology is incorporated under license from SRS Labs, Inc.

# SOUND SETTING ADJUSTMENT - USER MODE

Adjusting the audio equalizer.

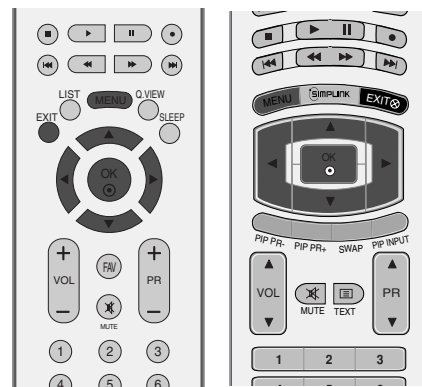

1 Press the **MENU** button and then **▲ / ▼** button to select the **AUDIO** menu.

2 Press the **▶** button and then **▲ / ▼** button to select **Sound Mode**.

3 Press the **▶** button and then **▲ / ▼** button to select **User**.

4 Press the **▶** button.

5 Select a frequency band by pressing the **◀ / ▶** button. Set the desired sound level with the **▲ / ▼** button.

6 Press the **EXIT** button to return to normal TV viewing.



1

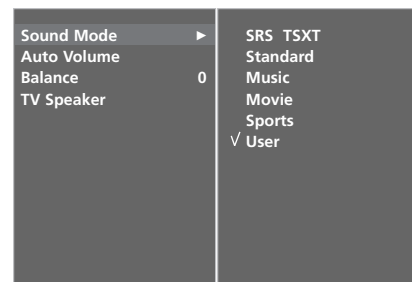

2 3 4

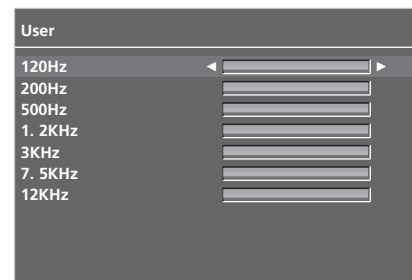

5

# SOUND & LANGUAGE CONTROL

## AUTO VOLUME LEVELER

Auto Volume automatically remains on the same level of volume if you change programmes.

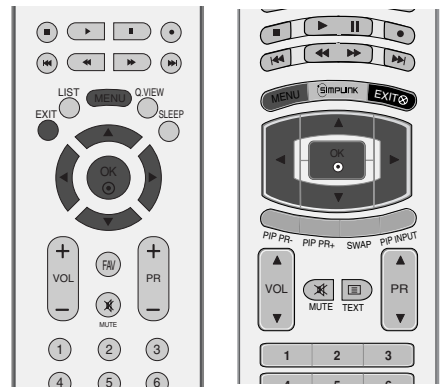

- 1 Press the **MENU** button and then **▲ / ▼** button to select the **AUDIO** menu.
- 2 Press the **▶** button and then **▲ / ▼** button to select **Auto Volume**.
- 3 Press the **▶** button and then **▲ / ▼** button to select **On** or **Off**.
- 4 Press the **EXIT** button to return to normal TV viewing.



1

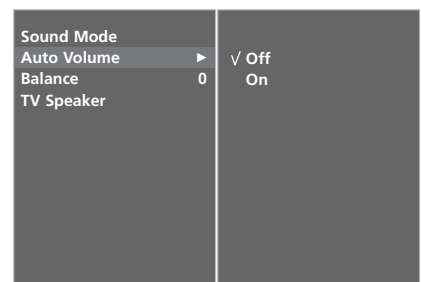

2 3



# BALANCE

You can adjust the sound balance of the speakers to the preferred levels.

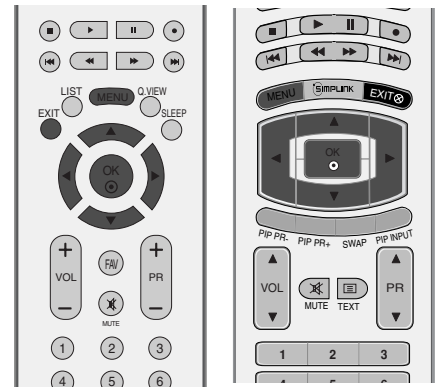

- 1 Press the **MENU** button and then **▲ / ▼** button to select the **AUDIO** menu.
- 2 Press the **▶** button and then **▲ / ▼** button to select **Balance**.
- 3 Press the **▶** button and then **◀ / ▶** button to make desired adjustment.
- 4 Press the **EXIT** button to return to normal TV viewing.

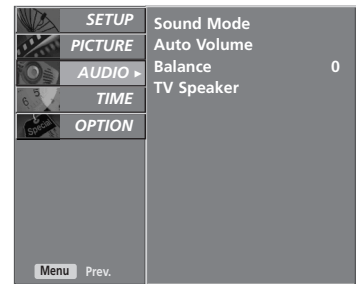

1

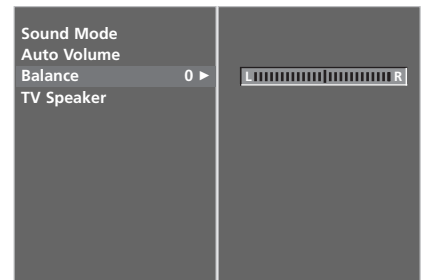

2 3

# SOUND & LANGUAGE CONTROL

## TV SPEAKERS ON/OFF SETUP

You can adjust the internal speaker status.

In AV, COMPONENT, RGB and HDMI mode, internal speaker audio can be operational even when there is no video signal.

If you want to use your external hi-fi stereo system, turn off the internal speakers of the set.

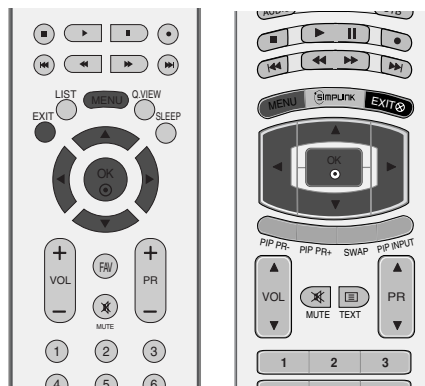

**1** Press the **MENU** button and then **▲ / ▼** button to select the **AUDIO** menu.

**2** Press the **▶** button and then **▲ / ▼** button to select **TV Speaker**.

**3** Press the **▶** button and then **▲ / ▼** button to select **On** or **Off**.

**4** Press the **EXIT** button to return to normal TV viewing.

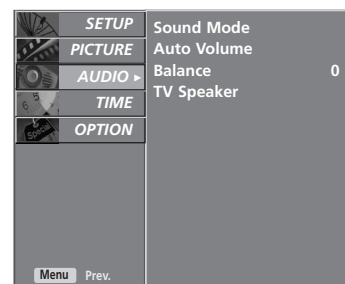

**1**

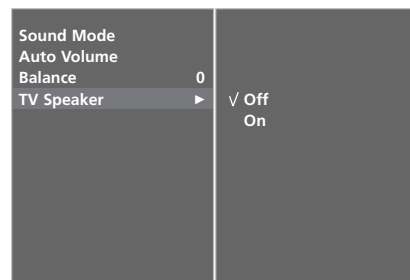

**2 3**

# I/II

## Stereo/Dual Reception

When a programme is selected, the sound information for the station appears after the programme number and station name disappear.

Broadcast	On Screen Display
Mono	<b>MONO</b>
Stereo	<b>STEREO</b>
Dual	<b>DUAL I</b>

### ■ Mono sound selection

If the stereo signal is weak in stereo reception, you can switch to mono by pressing the I/II button twice. In mono reception, the clarity of sound is improved. To switch back to stereo, press the I/II button twice.

### ■ Language selection for dual language broadcast

If a programme can be received in two languages (dual language), you can switch to **DUAL I**, **DUAL II** or **DUAL I+II** by pressing the I/II button repeatedly.

- DUAL I** Sends the primary broadcast language to the loudspeakers.
- DUAL II** Sends the secondary broadcast language to the loudspeakers.
- DUAL I+II** Sends a separate language to each loudspeaker.

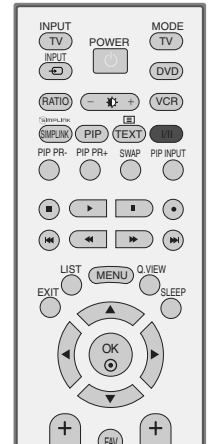
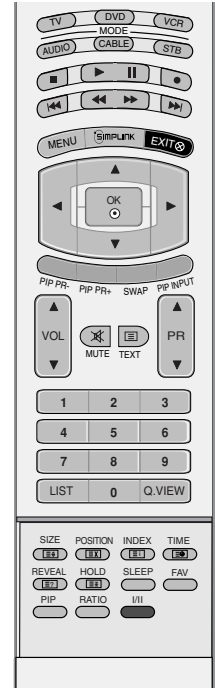

# SOUND & LANGUAGE CONTROL

## NICAM Reception

If the set is equipped with a receiver for NICAM reception, high quality NICAM (Near Instantaneous Companding Audio Multiplex) digital sound can be received.

Sound output can be selected according to the type of broadcast received as by pressing the I/II button repeatedly.

- 
- 1 When **NICAM mono** is received, you can select **NICAM MONO** or **FM MONO**.
  - 2 When **NICAM stereo** is received, you can select **NICAM STEREO** or **FM MONO**.  
If the stereo signal is weak, switch to **FM MONO**.
  - 3 When **NICAM dual** is received, you can select **NICAM DUAL I**, **NICAM DUAL II** or **NICAM DUAL I+II** or **MONO**.
- 

## Speaker Sound Output Selection

In AV, S-Video, Component, RGB and HDMI mode, you can select output sound for the left and right loudspeakers.

Repeatedly press the I/II button to select the sound output.

**L+R:** Audio signal from audio L input is sent to the left loudspeaker and audio signal from audio R input is sent to the right loudspeaker.

**L+L:** Audio signal from audio L input is sent to left and right loudspeakers.

**R+R:** Audio signal from audio R input is sent to left and right loudspeakers.

# ON-SCREEN MENU LANGUAGE SELECTION

The menus can be shown on the screen in the selected language. First select your language.

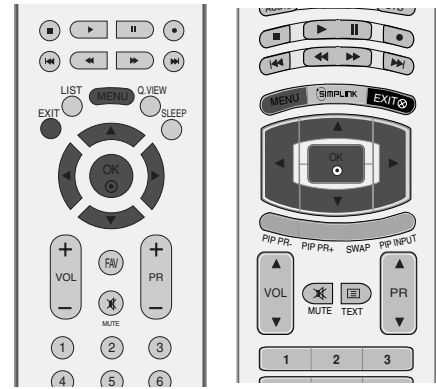

---

1 Press the **MENU** button and then use ▲ / ▼ button to select the **OPTION** menu.

---

2 Press the ► button and then use ▲ / ▼ button to select **Language**.

---

3 Press the ► button and then use ▲ / ▼ button to select your desired language.

---

4 Press the **OK** button.

---

5 Press the **EXIT** button to return to normal TV viewing.

---

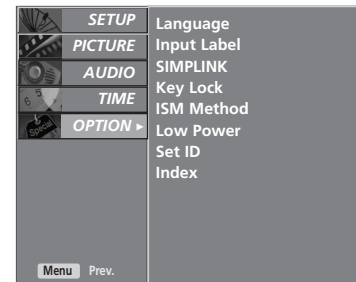

# TIME SETTING

## CLOCK SETTING

You must set the time correctly before using on/off timer function.

If current time setting is erased by a power failure or the set is unplugged, reset the clock.

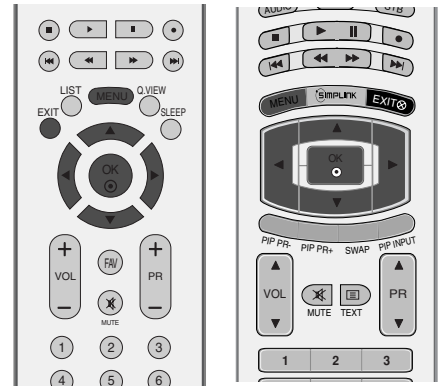

1 Press the **MENU** button and then **▲ / ▼** button to select the **TIME** menu.

2 Press the **▶** button and then **▲ / ▼** button to select **Clock**.

3 Press the **▶** button and then **▲ / ▼** button to set the hour.

4 Press the **▶** button and then **▲ / ▼** button to set the minutes.

5 Press the **EXIT** button to return to normal TV viewing.



1

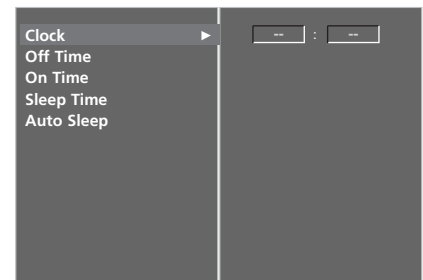

2 3 4

# AUTO ON/OFF TIMER SETTING

The Off time function automatically switches the set to standby at a preset time.

Two hours after the set is switched on by the on time function it will automatically switch back to standby mode unless a button has been pressed.

Once the on time/off time is set, these functions operate daily at the preset time.

The Off time function overrides the On timer function if both are set to the same time.

The set must be in standby mode for the On Timer to work.

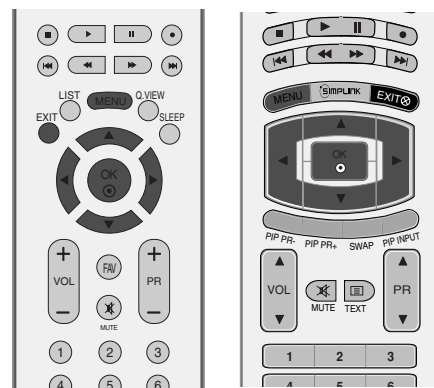

1 Press the **MENU** button and then **▲ / ▼** button to select the **TIME** menu.

2 Press the **▶** button and then **▲ / ▼** button to select **On/Off Time**.

3 Press the **▶** button and then **▲ / ▼** button to select **On**.  
 • To cancel **On/Off Time** function, select **Off**.

4 Press the **▶** button and then **▲ / ▼** button to set the hour.

5 Press the **▶** button and then **▲ / ▼** button to set the minutes.

6 **For On Time function only**  
 • **Programme:** Press the **▶** button and then **▲ / ▼** button to select the programme.  
 • **Volume:** Press the **▶** button and then **▲ / ▼** button to adjust volume level at switch-on.

7 Press the **EXIT** button to return to normal TV viewing.

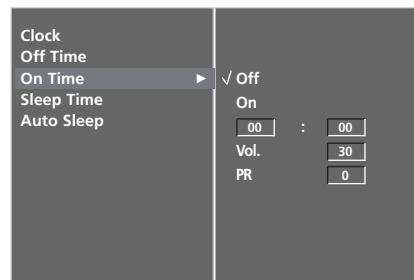
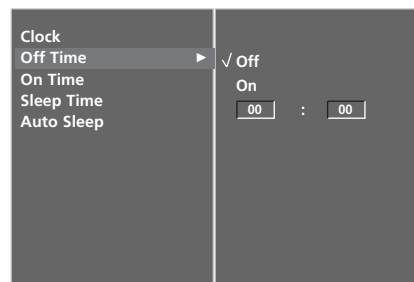

# TIME SETTING

## SLEEP TIMER SETTING

You do not have to remember to switch the set off before you go to sleep. The sleep timer automatically switches the set to standby after the preset time has elapsed.

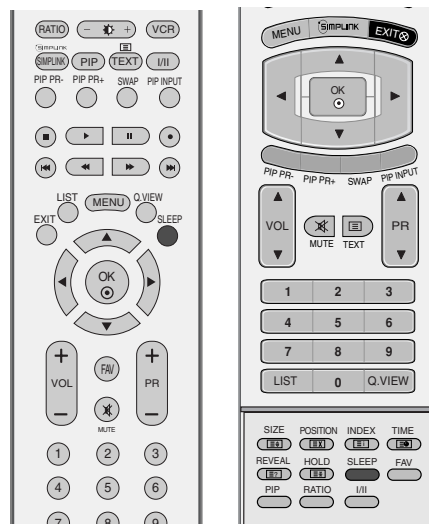

- 1 Press the **SLEEP** button repeatedly to select the number of minutes. The display '  - - -Min ' will appear on the screen, followed by 10, 20, 30, 60, 90, 120, 180 and 240.
- 2 When the number of minutes required is displayed on the screen, the timer begins to count down from the number of minutes selected.

■ You can also set up the Sleep Timer in the **TIME** menu.

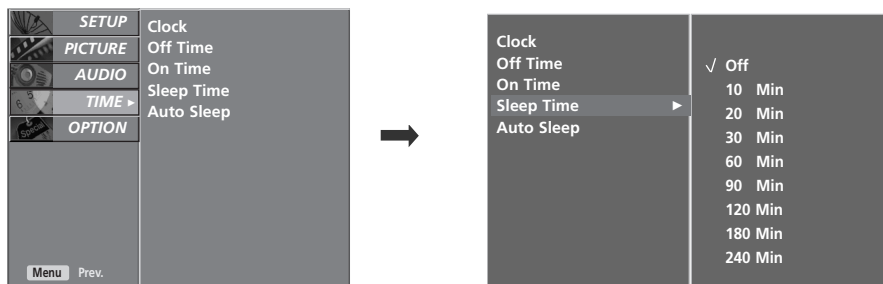

### ! NOTE

- ▶ To view the remaining sleep time, press the **SLEEP** button once.
- ▶ To cancel the sleep time, repeatedly press the **SLEEP** button until the display '  - - -Min ' appears.
- ▶ When you switch the set off, the set releases the preset sleep time.



# AUTO SHUT-OFF SETTING

If the TV set is switched on and there is no input signal, it will switch off automatically after 10 minutes.

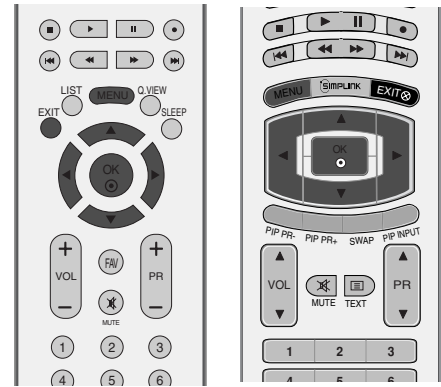

1 Press the **MENU** button and then ▲ / ▼ button to select the **TIME** menu.

2 Press the ► button and then ▲ / ▼ button to select **Auto Sleep**.

3 Press the ► button and then ▲ / ▼ button to select **On** or **Off**.

4 Press the **EXIT** button to return to normal TV viewing.



1

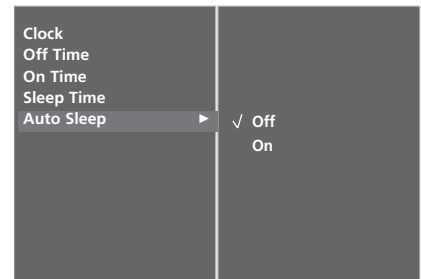

2 3

# TELETEXT

**This feature is not available in all countries.**

Teletext is a free service broadcast by most TV stations which gives up-to-the-minute information on news, weather, television programmes, share prices and many other topics.

The teletext decoder of this TV can support the SIMPLE, TOP and FASTEXT systems. SIMPLE (standard teletext) consists of a number of pages which are selected by directly entering the corresponding page number. TOP and FASTEXT are more modern methods allowing quick and easy selection of teletext information.

## SWITCH ON/OFF

Press the **TEXT** button to switch to teletext. The initial page or last page viewed appears on the screen.

Two page numbers, TV station name, date and time are displayed on the screen headline. The first page number indicates your selection, while the second shows the current page displayed.

Press the **TEXT** or **EXIT** button to switch off teletext. The previous mode reappears.

## SIMPLE TEXT

### ■ Page selection

- 1 Enter the desired page number as a three digit number with the **NUMBER** buttons. If during selection you press a wrong number, you must complete the three digit number and then re-enter the correct page number.
- 2 The **PR ▲ / ▼** (or **PR +/-**) button can be used to select the preceding or following page.

## TOP TEXT

The user guide displays four fields-red, green, yellow and blue at the bottom of the screen. The yellow field denotes the next group and the blue field indicates the next block.

### ■ Block / group / page selection

- ① With the blue button you can progress from block to block.
- ② Use the yellow button to proceed to the next group with automatic overflow to the next block.
- ③ With the green button you can proceed to the next existing page with automatic overflow to the next group. Alternatively the **PR ▲** (or **PR +**) button can be used.
- ④ The red button return to the previous selection. Alternatively the **PR ▼** (or **PR -**) button can be used.

### ■ Direct page selection

As with SIMPLE teletext mode, you can select a page by entering it as a three digit number using the NUMBER buttons in TOP mode.

## FASTEXT

The teletext pages are colour coded along the bottom of the screen and are selected by pressing the corresponding coloured button.

### ■ Page selection

- ① Press the  button to select the index page.
- ② You can select the pages which are colour coded along the bottom line with corresponding coloured buttons.
- ③ AS with SIMPLE teletext mode, you can select a page by entering its three digit page number with the NUMBER buttons in FASTEXT mode.
- ④ The **PR▲ / ▼** (or **PR +/-**) button can be used to select the preceding or following page.

## SPECIAL TELETEXT FUNCTIONS



### ■ REVEAL

Press this button to display concealed information, such as solutions to riddles or puzzles.  
Press this button again to remove the information from the display.



### ■ SIZE

Selects double height text.  
Press this button to enlarge the top half of the page.  
Press this button again to enlarge the bottom half of the page.  
Press this button again to return to the normal display.



### ■ UPDATE

Displays the TV picture on the screen while waiting for a new teletext page. The display will appear at the top left hand corner of the screen. When the updated page is available then display will change to the page number. Press this button again to view the updated teletext page.



### ■ TIME

When viewing a TV programme, press this button to display the time at the top right hand corner of the screen. Press this button again to remove the display. In the teletext mode, press this button to select a sub page number. The sub page number is displayed at the bottom of the screen. To hold or change the sub page, press the RED/GREEN, **PR▲ / ▼** (or **PR +/-**) or NUMBER buttons.  
Press again to exit this function.



### ■ INDEX

Select the each index page



### ■ HOLD

Stops the automatic page change which will occur if a teletext page consists of 2 or more sub pages. The number of sub pages and the sub page displayed is, usually, shown on the screen below the time.  
When this button is pressed the stop symbol is displayed at the top left-hand corner of the screen and the automatic page change is inactive.  
To continue press this button again.

# APPENDIX

## TROUBLESHOOTING

The TV set does not operate properly.	
<b>The remote control does not work</b>	<ul style="list-style-type: none"><li>■ Check to see if there is any object between the product and the remote control causing obstruction.</li><li>■ Are batteries installed with correct polarity (+ to +, - to -)?</li><li>■ Correct remote operating mode set: TV, VCR etc.?</li><li>■ Install new batteries.</li></ul>
<b>Power is suddenly turned off</b>	<ul style="list-style-type: none"><li>■ Is the sleep timer set?</li><li>■ Check the power control settings. Has the Power supply been interrupted.</li><li>■ Is Auto sleep activated on this station.</li></ul>

The video function does not work.	
<b>No picture &amp; No sound</b>	<ul style="list-style-type: none"><li>■ Check whether the TV set is switched on.</li><li>■ Try another channel. The problem may be with the broadcast.</li><li>■ Is the power cord inserted correctly into the mains?</li><li>■ Check your antenna direction and/or location.</li><li>■ Test the mains outlet by plugging another product into the same outlet.</li></ul>
<b>Picture appears slowly after switching on</b>	<ul style="list-style-type: none"><li>■ This is normal, the image is muted during the product startup process. Please contact your service center, if the picture has not appeared after five minutes.</li></ul>
<b>No or poor colour or poor picture</b>	<ul style="list-style-type: none"><li>■ Adjust Colour in menu option.</li><li>■ Allow a sufficient distance between the product and the VCR.</li><li>■ Try another channel. The problem may be with the broadcast.</li><li>■ Are the video cables installed properly?</li><li>■ Activate any function to restore the brightness of the picture.</li></ul>
<b>Horizontal/vertical bars or picture shaking</b>	<ul style="list-style-type: none"><li>■ Check for local interference such as an electrical appliance or power tool.</li></ul>
<b>Poor reception on some channels</b>	<ul style="list-style-type: none"><li>■ Station or cable product experiencing problems, tune to another station.</li><li>■ Station signal is weak, reposition the antenna to receive weaker stations.</li><li>■ Check for sources of possible interference.</li></ul>
<b>Lines or streaks in pictures</b>	<ul style="list-style-type: none"><li>■ Check antenna (Change the position of the antenna).</li></ul>

# APPENDIX

## The audio function does not work.

<b>Picture OK &amp; No sound</b>	<ul style="list-style-type: none"><li>■ Press the <b>VOL(or Volume)</b> button.</li><li>■ Sound muted? Press <b>MUTE</b> button.</li><li>■ Try another channel. The problem may be with the broadcast.</li><li>■ Are the audio cables installed properly?</li></ul>
<b>No output from one of the speakers</b>	<ul style="list-style-type: none"><li>■ Adjust Balance in menu option.</li></ul>
<b>Unusual sound from inside the product</b>	<ul style="list-style-type: none"><li>■ A change in ambient humidity or temperature may result in an unusual noise when the product is switched on or off and does not indicate a fault with the product.</li></ul>

## There is a problem in PC mode. (Only PC mode applied)

<b>The signal is out of range.</b>	<ul style="list-style-type: none"><li>■ Adjust resolution, horizontal frequency, or vertical frequency.</li><li>■ Check the input source.</li></ul>
<b>Vertical bar or stripe on background &amp; Horizontal Noise &amp; Incorrect position</b>	<ul style="list-style-type: none"><li>■ Use Auto configure or adjust clock, phase, or H/V position.</li></ul>
<b>Screen colour is unstable or single colour</b>	<ul style="list-style-type: none"><li>■ Check the signal cable.</li><li>■ Reinstall the PC video card.</li></ul>

# MAINTENANCE

Early malfunctions can be prevented. Careful and regular cleaning can prolong the life of your new TV.  
Caution: Be sure to switch the power off and unplug the power cord before you begin any cleaning.

## Cleaning the Screen

- 1 A good way to keep the dust off your screen for a while is to wet a soft cloth in a mixture of lukewarm water and a little fabric softener or dish washing detergent. Wring the cloth until it's almost dry, and then use it to wipe the screen.
- 2 Ensure there is no excess water on the screen. Allow any water or dampness to evaporate before switching on.

## Cleaning the Cabinet

- To remove dirt or dust, wipe the cabinet with a soft, dry, lint-free cloth.
- Do not to use a wet cloth.

## Extended Absence

### CAUTION

- ▶ If you expect to leave your TV dormant for prolonged periods (such as a holiday), unplug the power cord to protect against possible damage from lightning or power surges.

# APPENDIX

## PRODUCT SPECIFICATIONS

<b>42LB7RF*</b> 42LB7RF-TB	Dimensions (Width x Height x Depth)	with stand	1033.4 x 750.0 x 287.6 mm 40.7 x 29.5 x 11.3 inches
		without stand	1033.4 x 686.8 x 88.5 mm 40.7 x 27.0 x 3.5 inches
	Weight	with stand	24.9 kg / 54.9 lbs
		without stand	20.4 kg / 45.0 lbs
Power requirement		AC100-240V~ 50/60Hz 2.5A	
<b>47LB7RF*</b> 47LB7RF-TB	Dimensions (Width x Height x Depth)	with stand	1144.3 x 825.5 x 331.0 mm 45.1 x 32.5 x 13.0 inches
		without stand	1144.3 x 754.7 x 103.0 mm 45.1 x 29.7 x 4.1 inches
	Weight	with stand	37.6 kg / 82.9 lbs
		without stand	31.5 kg / 69.4 lbs
Power requirement		AC100-240V~ 50/60Hz 3.2A	
<b>47LB9R*</b> 47LB9R-TD 47LB9R1-TB	Dimensions (Width x Height x Depth)	with stand	1150 x 859 x 381 mm 45.3 x 33.8 x 15.0 inches
		without stand	1150 x 768 x 103 mm 45.3 x 30.2 x 4.0 inches
	Weight	with stand	38 kg / 83.8 lbs
		without stand	32 kg / 70.5 lbs
Power requirement		AC100-240V~ 50/60Hz 3.0A	
<b>52LB9RF*</b> 52LB9RF-TD 52LB9RF1-TB	Dimensions (Width x Height x Depth)	with stand	1289.0 x 950.0 x 421.0 mm 50.7 x 37.4 x 16.6 inches
		without stand	1289.0 x 858.0 x 112.0 mm 50.7 x 33.8 x 4.4 inches
	Weight	with stand	49.2 kg / 108.5 lbs
		without stand	40.2 kg / 88.6 lbs
Power requirement		AC100-240V~ 50/60Hz 3.5A	
Television System External Antenna Impedance		PAL/SECAM B/G/D/K, PAL I/II, NTSC-M 75 ohm	
Environment condition	Operating Temperature Operating Humidity		0 ~ 40°C / 32 ~ 104°F Less than 80%
	Storage Temperature Storage Humidity		-20 ~ 60°C / -4 ~ 140°F Less than 85%

■ The specifications shown above may be changed without prior notice for quality improvement.



# PRODUCT SPECIFICATIONS

<b>47LY3RF*</b> 47LY3RF-TB	Dimensions (Width x Height x Depth)	with stand	1236.9 x 795.6 x 325.6 mm 48.7 x 31.3 x 12.8 inches
		without stand	1236.9 x 725.5 x 103.0 mm 48.7 x 28.6 x 4.1 inches
	Weight	with stand	40.5 kg / 89.3 lbs
		without stand	34.0 kg / 75.0 lbs
Power requirement			AC100-240V~ 50/60Hz 3.2A
<b>60PY3RF*</b> 60PY3RF-TB	Dimensions (Width x Height x Depth)	with stand	1613.6 x 1036.8 x 452 mm 63.5 x 40.8 x 17.8 inches
		without stand	1613.6 x 970.0 x 118.5 mm 63.5 x 38.2 x 4.5 inches
	Weight	with stand	82.6 kg / 182.0 lbs
		without stand	66.6 kg / 146.8 lbs
Power requirement			AC100-240V~ 50/60Hz 6.5A
<b>60PC4R*</b> 60PC4R-TB	Dimensions (Width x Height x Depth)	with stand	1548 x 1061 x 448 mm 60.9 x 41.8 x 17.6 inches
		without stand	1548 x 988 x 98.5 mm 60.9 x 38.9 x 3.9 inches
	Weight	with stand	72.5 kg / 159.8 lbs
		without stand	60 kg / 132.3 lbs
Power requirement			AC100-240V~ 50/60Hz 5.8A
Television System External Antenna Impedance		PAL/SECAM B/G/D/K, PAL I/II, NTSC-M 75 ohm	
Environment condition	Operating Temperature Operating Humidity		0 ~ 40°C / 32 ~ 104°F Less than 80%
	Storage Temperature Storage Humidity		-20 ~ 60°C / -4 ~ 140°F Less than 85%

- The specifications shown above may be changed without prior notice for quality improvement.

## PROGRAMMING THE REMOTE CONTROL

The remote control is a multi brand or universal remote. It can be programmed. to operate most remote controlled devices from other manufacturers.

Note that the remote control may not control all models from other brands.

### Programming a code into a remote mode

---

- 1 To find out whether your remote can operate the device without programming, turn on the device such as a VCR and press the corresponding mode button on the remote.

After that, press the **POWER** button. If the device is turned off then it responds properly and the remote need not to be programmed.

If not, the remote should be programmed to operate the device. The programming procedures are explained below.

- 2 Press the **MENU** and **MUTE** button continuously at the same time for 2 seconds, the current selected device button will be illuminated.

If you don't press any button for 20 seconds, the light on the mode button will be turned off. In that case, you have to repeat from step 2.

- 3 Enter code numbers using the number button on the remote by referring the code table on the following pages. When pressing the button, the light blinks at a time.

If the device turned off, the programming is successful.

- 4 Press the **MENU** button to store the code. After blinking twice, this code is stored.

- 5 Test the remote functions to see if the device responds properly. If not, repeat from step 2.
-

# PROGRAMMING THE REMOTE CONTROL

The remote control is a multi brand or universal remote. It can be programmed. to operate most remote controlled devices from other manufacturers.

Note that the remote control may not control all models from other brands.

## Programming a code into a remote mode

- 1** Testing your remote control.  
To find out whether your remote control can operate other components without programming, turn on a component such as a VCR and press the corresponding mode button (such as a **DVD** or **VCR**) on the remote control, while pointing at the component.  
Test the **POWER** and **PR + / -** buttons to see if the component responds correctly.  
If the component does not operate correctly, the remote control requires programming to operate the device.
- 2** Switch on the component to be programmed, then press the corresponding mode button (such as **DVD** or **VCR**) on the remote control.  
The remote control button of the desired device is illuminated.
- 3** Press the **MENU** and **MUTE** buttons simultaneously, the remote control is ready to be programmed with the code.
- 4** Enter a code number using the number buttons on the remote control. Programming code numbers for the corresponding component can be found on the following pages. If the code is correct, the device will turn off.
- 5** Press the **MENU** button to store the code.
- 6** Test the remote control functions to see if the component responds correctly.  
If not, repeat from step 2.



# IR CODES

## 1. How to Connect

- Connect your wired remote control to the Remote Control port on the TV.

## 2. Remote Control IR Codes

### ■ Output waveform

Single pulse, modulated with 37.917KHz signal at 455KHz

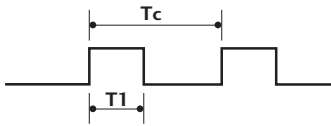

Carrier frequency  
 $FCAR = 1/T_C = f_{OSC}/12$   
 Duty ratio =  $T_1/T_C = 1/3$

### ■ Configuration of frame

1st frame

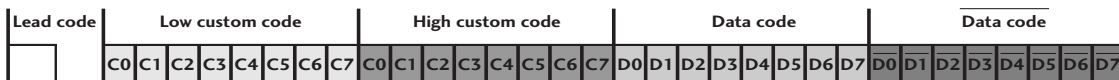

Repeat frame

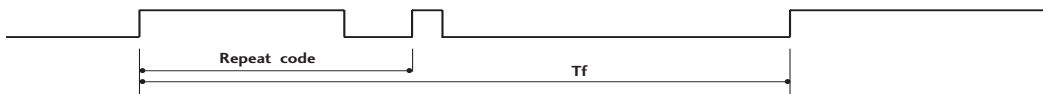

### ■ Lead code

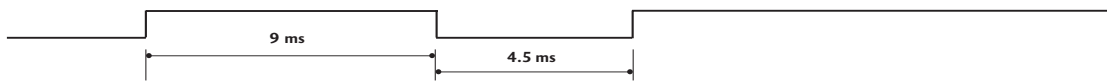

### ■ Repeat code

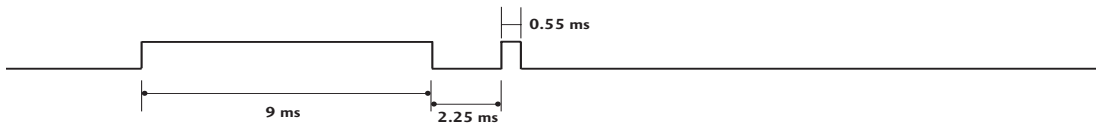

### ■ Bit description



### ■ Frame interval: $T_f$

The waveform is transmitted as long as a key is depressed.



# APPENDIX

## REMOTE CONTROL IR CODES

Code (Hexa)	Function	Note	Code (Hexa)	Function	Note
0B	INPUT	R/C Button	40	▲	R/C Button
08	POWER	R/C Button (Power On/Off)	41	▼	R/C Button
43	MENU	R/C Button	1E	FAV	R/C Button
03	VOL ▼	R/C Button	B0h	▶	R/C Button
02	VOL ▲	R/C Button	B1h	■	R/C Button
00	PR ▲	R/C Button	0A	I/II	R/C Button
01	PR ▼	R/C Button	B2h	⏮	R/C Button
09	MUTE	R/C Button	B3h	⏭	R/C Button
0E	SLEEP	R/C Button	0F	TV	R/C Button
10 ~ 19	Number Key 0 ~ 9	R/C Button	BDh	●	R/C Button
60	PIP	R/C Button	B4h	⏪	R/C Button
61	PIP INPUT	R/C Button	B5h	⏩	R/C Button
63	SWAP	R/C Button	7E	SIMPLINK	R/C Button
64	SIZE	R/C Button	20	TEXT	R/C Button
07	◀	R/C Button	53	LIST	R/C Button
06	▶	R/C Button	1A	Q.VIEW	R/C Button
72	PIP PR-	R/C Button	70	INDEX	R/C Button
71	PIP PR+	R/C Button	26	TIME	R/C Button
5B	EXIT	R/C Button	2A	REVEAL	R/C Button
62	POSITION	R/C Button	65	HOLD	R/C Button
79	RATIO	R/C Button	BAh	⏸	R/C Button

## REMOTE CONTROL IR CODES

Code (Hexa)	Function	Note	Code (Hexa)	Function	Note
0F	TV	R/C Button	72	RED	R/C Button
0B	INPUT	R/C Button	71	GREEN	R/C Button
08	POWER	R/C Button (Power On/Off)	63	YELLOW	R/C Button
60	PIP	R/C Button	61	BLUE	R/C Button
0E	SLEEP	R/C Button	02	VOL +	R/C Button
20	TEXT	R/C Button	03	VOL -	R/C Button
0A	I/II	R/C Button	00	PR +	R/C Button
43	MENU	R/C Button	01	PR -	R/C Button
79	RATIO	R/C Button	09	MUTE	R/C Button
5B	EXIT	R/C Button	53	LIST	R/C Button
07	◀	R/C Button	10 ~ 19	Number Key 0 ~ 9	R/C Button
06	▶	R/C Button	1E	FAV	R/C Button
40	▲	R/C Button	1A	Q.VIEW	R/C Button
41	▼	R/C Button	64	SIZE	R/C Button
44	OK	R/C Button	62	POSITION	R/C Button
72	PIP PR-	R/C Button	70	INDEX	R/C Button
71	PIP PR+	R/C Button	26	TIME	R/C Button
7E	SIMPLINK	R/C Button	2A	REVEAL	R/C Button
61	PIP INPUT	R/C Button	E0	☀ +	R/C Button
65	HOLD	R/C Button	E1	☀ -	R/C Button

# APPENDIX

## EXTERNAL CONTROL THROUGH RS-232C

Connect the RS-232C input jack to an external control device (such as a computer or an A/V control system) and control the TV's functions externally.

Connect the serial port of the control device to the RS-232C jack on the TV back panel.

RS-232C connection cables are not supplied with the TV.

### RS-232C Setup

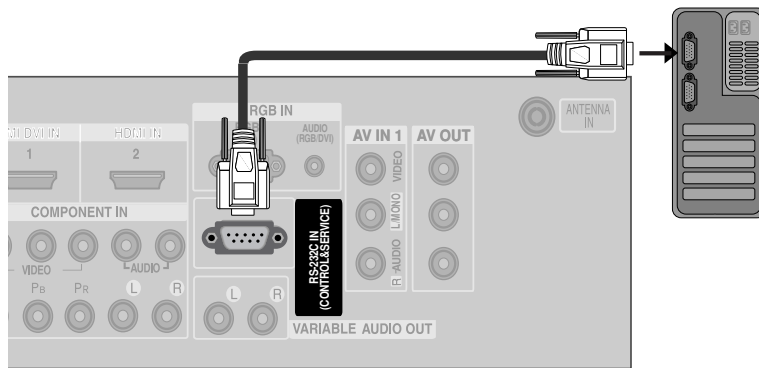

### Type of Connector; D-Sub 9-Pin Male

No.	Pin Name
1	No connection
2	RXD (Receive data)
3	TXD (Transmit data)
4	DTR (DTE side ready)
5	GND
6	DSR (DCE side ready)
7	RTS (Ready to send)
8	CTS (Clear to send)
9	No Connection

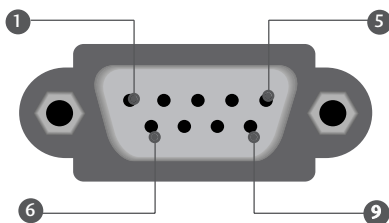



## RS-232C Configurations

### 7-Wire Configurations (Standard RS-232C cable)

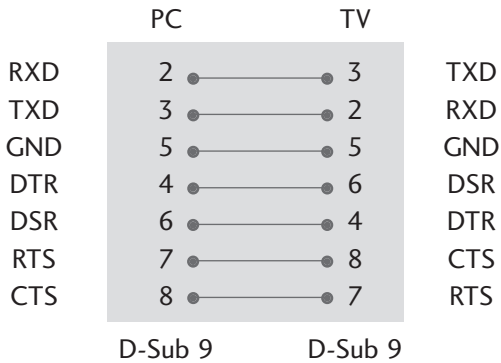

### 3-Wire Configurations (Not standard)

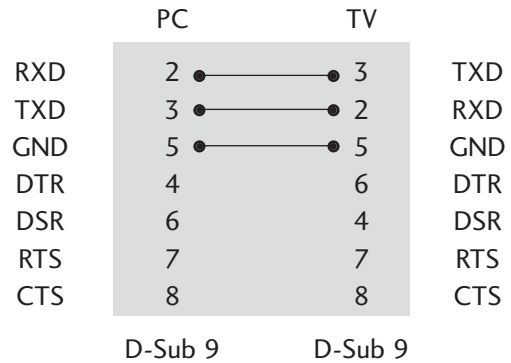

## Set ID

Use this function to specify a set ID number.  
Refer to 'Real Data Mapping' 1. See page p.99

- 1 Press the **MENU** button and then use ▲ / ▼ button to select the **OPTION** menu.
- 2 Press the ► button and then use ▲ / ▼ button to select **Set ID**.
- 3 Press the ► button and then use ◀ / ▶ button to adjust **Set ID** to choose the desired TV ID number.
  - The adjustment range of SET ID is 1~99.
- 4 Press **EXIT** button to return to normal TV viewing.



1

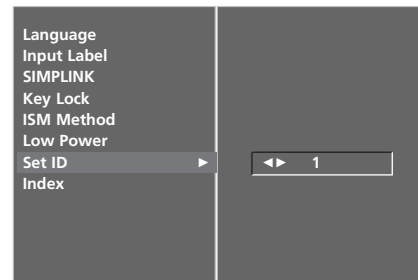

2 3

## Communication Parameters

- Baud rate : 9600 bps (UART)
- Data length : 8 bits
- Parity : None
- Stop bit : 1 bit
- Communication code : ASCII code
- Use a crossed (reverse) cable.

## Command Reference List

	COMMAND1	COMMAND2	DATA (Hexadecimal)		COMMAND1	COMMAND2	DATA (Hexadecimal)
01. Power	k	a	0 ~ 1	15. Balance	k	t	0 ~ 64
02. Aspect Ratio	k	c	*	16. Colour Temperature	k	u	0 ~ 3
03. Screen Mute	k	d	0 ~ 1	17. Red Adjustment	k	v	0 ~ 3C (or 50)
04. Volume Mute	k	e	0 ~ 1	18. Green Adjustment	k	w	0 ~ 3C (or 50)
05. Volume Control	k	f	0 ~ 64	19. Blue Adjustment	k	\$	0 ~ 3C (or 50)
06. Contrast	k	g	0 ~ 64	20. Abnormal Status	k	z	FF
07. Brightness	k	h	0 ~ 64	21. ISM Method	j	p	0 ~ 3
08. Colour	k	i	0 ~ 64	22. Low Power	j	q	0 ~ 1
09. Tint	k	j	0 ~ 64	23. Orbiter Time Setting	j	r	1 ~ FE
10. Sharpness	k	k	0 ~ 64	24. Orbiter Pixel Setting	j	s	1 ~ 3
11. OSD Select	k	l	0 ~ 1	25. Auto Configure	j	u	1
12. Remote Control lock mode	k	m	0 ~ 1	26. Tune Command	m	a	*
13. PIP/DW	k	n	*	27. Key	m	c	Key Code
14. PIP Position	k	q	0 ~ 3	28. Input select (Main)	x	b	*
				29. Input select (PIP)	x	y	*

## Transmission / Receiving Protocol

### Transmission

**[Command1][Command2][ ][Set ID][ ][Data][Cr]**

[Command 1] : First command to control the set.(j,k,mor x)

[Command 2] : Second command to control the set.

[Set ID] : You can adjust the set ID to choose desired TV ID number in Setup menu. Adjustment range is 1 ~ 99. When selecting Set ID '0', every connected set is controlled. Set ID is indicated as decimal (1 ~ 99) on menu and as Hexa decimal (0x0 ~ 0x63) on transmission/receiving protocol.

[DATA] : To transmit command data.

Transmit 'FF' data to read status of comand.

[Cr] : Carriage Return

ASCII code '0x0D'

[ ] : ASCII code 'space (0x20)'

### OK Acknowledgement

**[Command2][ ][Set ID][ ][OK][Data][x]**

The TV transmits ACK (acknowledgement) based on this format when receiving normal data. At this time, if the data is data read mode, it indicates present status data. If the data is data write mode, it returns the data of the PC computer.

### Error Acknowledgement

**[Command2][ ][Set ID][ ][NG][Data][x]**

The TV transmits ACK (acknowledgement) based on this format when receiving abnormal data from non-viable functions or communication errors.

Data1: Illegal Code

Data2: Not supported function

Data3: Wait more time

**01. Power (Command2:a)**

To control Power On/Off of the TV.

*Transmission* [k][a][ ][Set ID][ ][Data][Cr]

Data 0 : Power Off      Data 1 : Power On

*Acknowledgement* [a][ ][Set ID][ ][OK][Data][x]

To show Power On/Off.

*Transmission* [k][a][ ][Set ID][ ][FF][Cr]

*Acknowledgement* [a][ ][Set ID][ ][OK][Data][x]

\* Similarly, if other functions transmit 'FF' data based on this format, Acknowledgement data feed back presents status about each function.

**02. Aspect Ratio (Command2:c) (Main picture size)**

To adjust the screen format. (Main picture format)

You can also adjust the screen format using the ARC (Aspect Ratio Control) button on remote control or in the PICTURE menu.

*Transmission* [k][c][ ][Set ID][ ][Data][Cr]

Date 1: Normal screen (4:3)	Date 6: Original
Date 2: Wide screen (16:9)	Date 7: Wide screen (14:9)
Date 3: Spectacle	Date 8: Full (Option)
Date 4: Full screen (Zoom1)	Date 9: 1:1 Pixel(Except 60PC4R*, 47LB9R*)
Date 5: Full screen (Zoom2)	

*Acknowledgement* [c][ ][Set ID][ ][OK][Data][x]

\* Using the PC input, you select either 16:9 or 4:3 screen aspect ratio.

\* In HDMI(1080i 50Hz/60Hz, 1080p 50Hz/60Hz)mode, 1:1 Pixel is available.

**03. Screen Mute (Command2:d)**

To select screen mute on/off.

*Transmission* [k][d][ ][Set ID][ ][Data][Cr]

Data 0 : Screen mute off (Picture on)

Data 1 : Screen mute on (Picture off)

*Acknowledgement* [d][ ][Set ID][ ][OK][Data][x]

**04. Volume Mute (Command2:e)**

To control volume mute on/off.

You can also adjust mute using the MUTE button on remote control.

*Transmission* [k][e][ ][Set ID][ ][Data][Cr]

Data 0 : Volume mute on (Volume off)

Data 1 : Volume mute off (Volume on)

*Acknowledgement* [e][ ][Set ID][ ][OK][Data][x]

**05. Volume Control (Command2:f)**

To adjust volume.

You can also adjust volume with the volume buttons on remote control.

*Transmission* [k][f][ ][Set ID][ ][Data][Cr]

Data Min : 0 ~ Max : 64

Refer to 'Real data mapping 1' : See page 99

*Acknowledgement* [f][ ][Set ID][ ][OK][Data][x]

**06. Contrast (Command2:g)**

To adjust screen contrast.

You can also adjust contrast in the PICTURE menu.

*Transmission* [k][g][ ][Set ID][ ][Data][Cr]

Data Min : 0 ~ Max : 64

Refer to 'Real data mapping 1' : See page 99

*Acknowledgement* [g][ ][Set ID][ ][OK][Data][x]

**07. Brightness (Command2:h)**

To adjust screen brightness.

You can also adjust brightness in the PICTURE menu.

*Transmission* [k][h][ ][Set ID][ ][Data][Cr]

Data Min : 0 ~ Max : 64

Refer to 'Real data mapping 1' : See page 99

*Acknowledgement* [h][ ][Set ID][ ][OK][Data][x]

**08. Colour (Command2:i)**

To adjust the screen colour.

You can also adjust colour in the PICTURE menu.

*Transmission* [k][i][ ][Set ID][ ][Data][Cr]

Data Min : 0 ~ Max : 64

Refer to 'Real data mapping 1' : See page 99

*Acknowledgement* [i][ ][Set ID][ ][OK][Data][x]

**09. Tint (Command2:j)**

To adjust the screen tint.

You can also adjust tint in the PICTURE menu.

*Transmission* [k][j][ ][Set ID][ ][Data][Cr]

Data Red : 0 ~ Green : 64

Refer to 'Real data mapping 1' : See page 99

*Acknowledgement* [j][ ][Set ID][ ][OK][Data][x]

# APPENDIX

## 10. Sharpness (Command2:k)

To adjust the screen sharpness.

You can also adjust sharpness in the PICTURE menu.

*Transmission* [k][k][ ][Set ID][ ][Data][Cr]

Data Min: 0 ~ Max: 64

Refer to 'Real data mapping 1'. See page 99

*Acknowledgement* [k][ ][Set ID][ ][OK][Data][x]

## 11. OSD Select (Command2:l)

To select OSD (On Screen Display) on/off when controlling remotely.

*Transmission* [k][l][ ][Set ID][ ][Data][Cr]

Data 0: OSD off

Data 1: OSD on

*Acknowledgement* [l][ ][Set ID][ ][OK][Data][x]

## 12. Remote Control Lock Mode (Command2:m)

To lock the remote control and the front panel controls on the set.

*Transmission* [k][m][ ][Set ID][ ][Data][Cr]

Data 0: Lock off

Data 1: Lock on

*Acknowledgement* [m][ ][Set ID][ ][OK][Data][x]

If you're not using the remote control and front panel controls on the TV, use this mode. When main power is on/off, remote control lock is released.

## 13. PIP / DW (Command2:n)

To control the PIP (Picture In picture)/DW.

You can also control the PIP/DW using the PIP button on the remote control or in the PIP/DW menu.

*Transmission* [k][n][ ][Set ID][ ][Data][Cr]

Data 0: PIP/DW off

Data 1: PIP

Data 2: DW1

Data 3: DW2

*Acknowledgement* [n][ ][Set ID][ ][OK][Data][x]

## 14. PIP Position (Command2:q)

To select sub picture position for PIP.

You can also adjust the sub picture position using POSITION button on the remote control or in the PIP/DW menu.

*Transmission* [k][q][ ][Set ID][ ][Data][Cr]

Data 0: Right down on screen

Data 1: Left down on screen

Data 2: Left up on screen

Data 3: Right up on screen

*Acknowledgement* [q][ ][Set ID][ ][OK][Data][x]

## 15. Balance (Command2:t)

To adjust balance.

You can also adjust balance in the AUDIO menu.

*Transmission* [k][t][ ][Set ID][ ][Data][Cr]

Data Min: 0 ~ Max: 64

Refer to 'Real data mapping 1'. See page 99

*Acknowledgement* [t][ ][Set ID][ ][OK][Data][x]

## 16. Colour Temperature (Command2:u)

To adjust colour temperature.

You can also adjust CSM in the PICTURE menu.

*Transmission* [k][u][ ][Set ID][ ][Data][Cr]

Data 0: Cool 1: Medium 2: Warm 3: User

*Acknowledgement* [u][ ][Set ID][ ][OK][Data][x]

## 17. Red Adjustment (Command2:v)

To adjust red in colour temperature.

*Transmission* [k][v][ ][Set ID][ ][Data][Cr]

Data Min: 0 ~ Max: 3C(or 50)

Refer to 'Real data mapping 2'. See page 99

*Acknowledgement* [v][ ][Set ID][ ][OK][Data][x]

## 18. Green Adjustment (Command2:w)

To adjust green in colour temperature.

*Transmission* [k][w][ ][Set ID][ ][Data][Cr]

Data Min: 0 ~ Max: 3C(or 50)

Refer to 'Real data mapping 2'. See page 99

*Acknowledgement* [w][ ][Set ID][ ][OK][Data][x]

## 19. Blue Adjustment (Command2:\$)

To adjust blue in colour temperature.

*Transmission* [k][\$][ ][Set ID][ ][Data][Cr]

Data Min: 0 ~ Max: 3C(or 50)

Refer to 'Real data mapping 2'. See page 99

*Acknowledgement* [\$][ ][Set ID][ ][OK][Data][x]

**20. Abnormal State (Command2:z)**

To recognize an abnormal state.

*This feature is not available for all models.*

Transmission [k][z][ ][Set ID][ ][FF][ ][Cr]

Data FF: Read

Acknowledgement [z][ ][Set ID][ ][OK][Data][x]

Data 0: Normal (Power on and signal exist)

Data 1: No signal (Power on)

Data 2: Turn the TV off by remote control

Data 3: Turn the TV off by sleep time function

Data 4: Turn the TV off by RS-232C function

Data 5: 5V down

Data 6: AC down

Data 7: Turn the TV off by Fan Alarm function (option)

Data 8: Turn the TV off by Off time function

Data 9: Turn the TV off by Auto sleep function

Data a: Turn the TV off by AV board detect

\* This function is "read only".

**21. ISM Method (Command1:j, Command2:p)(Option)**

To control the ISM method. You can also adjust ISM Method in OPTION menu.

*This feature is not available for all models.*

Transmission [j][p][ ][Set ID][ ][Data][Cr]

Data 0: Normal Mode      Data 1: White Wash

Data2: Orbiter              Data3: Inversion

Acknowledgement [p][ ][Set ID][ ][OK][Data][x]

**22. Low Power (Command1:j, Command2:q)(Option)**

To reduce the power consumption of the monitor. You can also adjust Low Power in OPTION menu.

*This feature is not available for all models.*

Transmission [j][q][ ][Set ID][ ][Data][ ][Cr]

Data 0: Off                      Data 1: On

Acknowledgement [q][ ][Set ID][ ][OK][Data][x]

**23. Orbiter Time Setting (Command1:j, Command2:r)(Option)**

To adjust orbiter operation time term.

*This feature is not available for all models.*

Transmission [j][r][ ][Set ID][ ][Data][ ][Cr]

Data Min: 1 ~ Max: FE

Refer to 'Real data mapping 1'.

Acknowledgement [r][ ][Set ID][ ][OK][Data][x]

**24. Orbiter Pixel Setting (Command1:j, Command2:s)(Option)**

To adjust pixel number in orbiter function.

*This feature is not available for all models.*

Transmission [j][s][ ][Set ID][ ][Data][Cr]

Data Min: 1 ~ Max: 3

Refer to 'Real data mapping 1'.

Acknowledgement [s][ ][Set ID][ ][OK][Data][x]

**25. Auto Configure (Command1:j, Command2:u)**

To adjust picture position and minimize image shaking automatically. It works only in RGB mode.

Transmission [j][u][ ][Set ID][ ][Data][Cr]

Data 1: To set

Acknowledgement [u][ ][Set ID][ ][OK][Data][x]

**26. Programme selection (Command1:m, Command2:a)**

To select a programme for the main picture.

Transmission [m][a][ ][Set ID][ ][Data0][ ][Data1][ ][Data2][Cr]

Data 0: Min: 0 ~ Max: 63 (0~C7, 200 Pr is on)

Refer to 'Real data mapping 1'.

Data 1: Do not care

Data 2: 0 : Main

1 : Sub

Acknowledgement [a][ ][Set ID][ ][OK][Data0][x]

**\* Real data mapping 1**

0 : Step 0  
 ⋮  
 A : Step 10 (Set ID 10)  
 ⋮  
 F : Step 15 (Set ID 15)  
 10 : Step 16 (Set ID 16)  
 ⋮  
 64 : Step 100  
 ⋮  
 6E : Step 110  
 ⋮  
 73 : Step 115  
 74 : Step 116  
 ⋮  
 C7 : Step 199  
 ⋮  
 FE : Step 254  
 FF : Step 255

**\* Real data mapping 2**

0 : -40  
 1 : -39  
 2 : -38  
 ⋮  
 28 : 0  
 ⋮  
 4E : +38  
 4F : +39  
 50 : +40

# APPENDIX

## 27. Send IR Code (Command1:m, Command2:c)

To send IR remote key code.

*Transmission* [m][c][ ][Set ID][ ][Data][Cr]

Data: Key code - Refer to page 92, 93.

*Acknowledgement* [c][ ][Set ID][ ][OK][Data][x]

## 28. Input select (Command1:x, Command2:b)

### (Main Picture Input)

To select input source for TV

*Transmission* [x][b][ ][Set ID][ ][Data][Cr]

Data: Structure

MSB				LSB			
0	0	0	0	0	0	0	0
└ External Input ┘				└ Input Number ┘			

External Input				Data
0	0	0	1	Analog
0	0	1	0	AV
0	1	0	0	Component
0	1	1	0	RGB-PC
1	0	0	1	HDMI

Input Number				Data
0	0	0	0	Input1
0	0	0	1	Input2
0	0	1	0	Input3
0	0	1	1	Input4

*Acknowledgement* [b][ ][Set ID][ ][OK][Data][x]

## 29. PIP Input select (Command1:x, Command2:y)

To adjust input source for sub picture in PIP mode

*Transmission* [x][y][ ][Set ID][ ][Data][Cr]

Data: Structure

MSB				LSB			
0	0	0	0	0	0	0	0
└ External Input ┘				└ Input Number ┘			

External Input				Data
0	0	0	1	Analog
0	0	1	0	AV
0	1	0	0	Component
0	1	1	0	RGB-PC
1	0	0	1	HDMI

Input Number				Data
0	0	0	0	Input1
0	0	0	1	Input2
0	0	1	0	Input3
0	0	1	1	Input4

*Acknowledgement* [y][ ][Set ID][ ][OK][Data][x]



**LG Electronics Inc.**