

User's Guide

M4210N

Make sure to read the **Important Precautions** before using the product.

Keep the User's Guide(CD) in an accessible place for future reference.

See the label attached on the product and give the information to your dealer when you ask for service.



Important

WARRANTY VOID
IF REMOVED

3851TAZ299F

Warranty void if removed.

Safety Precautions

WARNING -This is a class A product. In a domestic environment this product may cause radio interference in which case the user may be required to take adequate measures.

Please read these safety precautions carefully before using the product.

 **Warning** If you ignore the warning message, you may be seriously injured or there is a possibility of accident or death.

 **Caution** If you ignore the caution message, you may be slightly injured or the product may be damaged

Precautions in installing the Product

Warning

- **Keep away from heat sources like electrical heaters.**
 - Electrical shock, fire, malfunction or deformation may occur.
- **Keep the packing anti-moisture material or vinyl packing out of the reach of children.**
 - Anti-moisture material is harmful if swallowed. If swallowed by mistake, force the patient to vomit and visit the nearest hospital. Additionally, vinyl packing can cause suffocation. Keep it out of the reach of children.
- **Do not put heavy objects on the product or sit upon it.**
 - If the product collapses or is dropped, you may be injured. Children must pay particular attention.
- **Do not leave the power or signal cable unattended on the pathway.**
 - The passerby can falter, which can cause electrical shock, fire, product breakdown or injury.
- **Install the product in a neat and dry place.**
 - Dust or moisture can cause electrical shock, fire or product damage.
- **If you can smell smoke or other odors or hear a strange sound unplug the power cord and contact the service center.**
 - If you continue to use without taking proper measures, electrical shock or fire can occur.
- **If you dropped the product or the case is broken, turn off the product and unplug the power cord.**
 - If you continue to use without taking proper measures, electrical shock or fire can occur. Contact the service center.
- **Do not drop an object on or apply impact to the product. Do not throw any toys or objects on the product screen.**
 - It can cause injury to human, problem to product and damage the display.

Caution

- **Make sure the product ventilation hole is not blocked. Install the product in a suitably wide place (more than 10cm from the wall)**
 - If you install the product too close to the wall, it may be deformed or fire can break out due to internal heat.
- **Do not block the ventilation hole of the product by a tablecloth or curtain.**
 - The product can be deformed or fire can break out due to overheating inside the product.
- **Install the product on a flat and stable place that has no risk of dropping the product.**
 - If the product is dropped, you may be injured or the product may be broken.
- **Install the product where no EMI occurs.**
- **Keep the product away from direct sunlight.**
 - The product can be damaged.

Safety Precautions

Electrical Power Related Precautions

Warning

- **Make sure to connect the power cable to the grounded current.**
 - You may be electrocuted or injured.
- **Use the rated voltage only.**
 - The product can be damaged, or you may be electrocuted.
- **In the presence of thunder and lightning, never touch the power cord and signal cable because it can be very dangerous.**
 - It can cause electric shock.
- **Do not connect several extension cords, electrical appliances or electrical heaters to a single outlet. Use a power bar with a grounding terminal designed for exclusive use with the computer.**
 - A fire can break out due to overheating.
- **Do not touch the power plug with wet hands. Additionally, if the cord pin is wet or covered with dust, dry the power plug completely or wipe dust off.**
 - You may be electrocuted due to excess moisture.
- **If you don't intend to use the product for a long time, unplug the power cable from the product.**
 - Covering dust can cause a fire, or insulation deterioration can cause electric leakage, electric shock or fire.
- **Fix the power cable completely.**
 - If the power cable is not fixed completely, a fire can break out.
- **Hold the plug when pulling out the power cable. Do not bend the power cord with excessive force or put heavy objects on the power cord.**
 - The power line can be damaged, which may cause electric shock or fire.
- **Do not insert a conductor (like a metal chopstick) into one end of the power cable while the other end is connected to the input terminal on the wall. Additionally, do not touch the power cable right after plugging into the wall input terminal.**
 - You may be electrocuted.
- **The power supply cord is used as the main disconnection device. Ensure that the socket-outlet is easily accessible after installation.**
- **Main power breaker is the power cord and this breaking device must be located at a location where it is easy to operate.**

Caution

- **Do not unplug the power cord while the product is in use.**
 - Electrical shock can damage the product.

Precautions in Moving the Product

Warning

- **Make sure to turn off the product.**
 - You may be electrocuted or the product can be damaged.
- **Make sure to remove all cables before moving the product.**
 - You may be electrocuted or the product can be damaged.

Safety Precautions

Caution

- **Do not shock the product when moving it.**
 - You may be electrocuted or the product can be damaged.
 - **Do not dispose the product-packing box. Use it when you move.**
 - **Make the panel face forward and hold it with both hands to move.**
 - If you drop the product, the damaged product can cause electric shock or fire. Contact with the service center for repair.
-

Precautions in Using the Product

Warning

- **Do not disassemble, repair or modify the product at your own discretion.**
 - Fire or electric shock accident can occur.
 - Contact the service center for check, calibration or repair.
- **When cleaning the brown tube surface, unplug the power cord and scrub with soft cloth to prevent scratching. Do not clean with a wet cloth.**
- **Keep the product away from water.**
 - Fire or electric shock accident can occur.

Caution

- **Do not put or store inflammable substances near the product.**
 - There is a danger of explosion or fire due to careless handling of the inflammable substances.
 - **When cleaning the brown tube surface, unplug the power cord and scrub with soft cloth to prevent scratching. Do not clean with a wet cloth.**
 - The water can sink into the product, which can cause electric shock or serious malfunction.
 - **Take a rest from time to time to protect your vision.**
 - **Keep the product clean at all times.**
 - **Take a comfortable and natural position when working with a product to relax the muscles.**
 - **Take a regular break when working with a product for a long time.**
 - **Do not press strongly upon the panel with a hand or sharp object such as nail, pencil or pen, or make a scratch on it.**
 - **Keep the proper distance from the product.**
 - Your vision may be impaired if you look at the product too closely.
 - **Set the appropriate resolution and clock by referring to the User's Guide.**
 - Your vision can be impaired.
 - **Use authorized detergent only when cleaning the product. (Do not use benzene, thinner or alcohol.)**
 - Product can be deformed.
-

On Disposal

- **The fluorescent lamp used in this product contains a small amount of mercury.**
- **Do not dispose of this product with general household waste.**
 - Disposal of this product must be carried out in accordance to the regulations of your local authority.

Using the Remote Control

● Name of the Remote Control Buttons

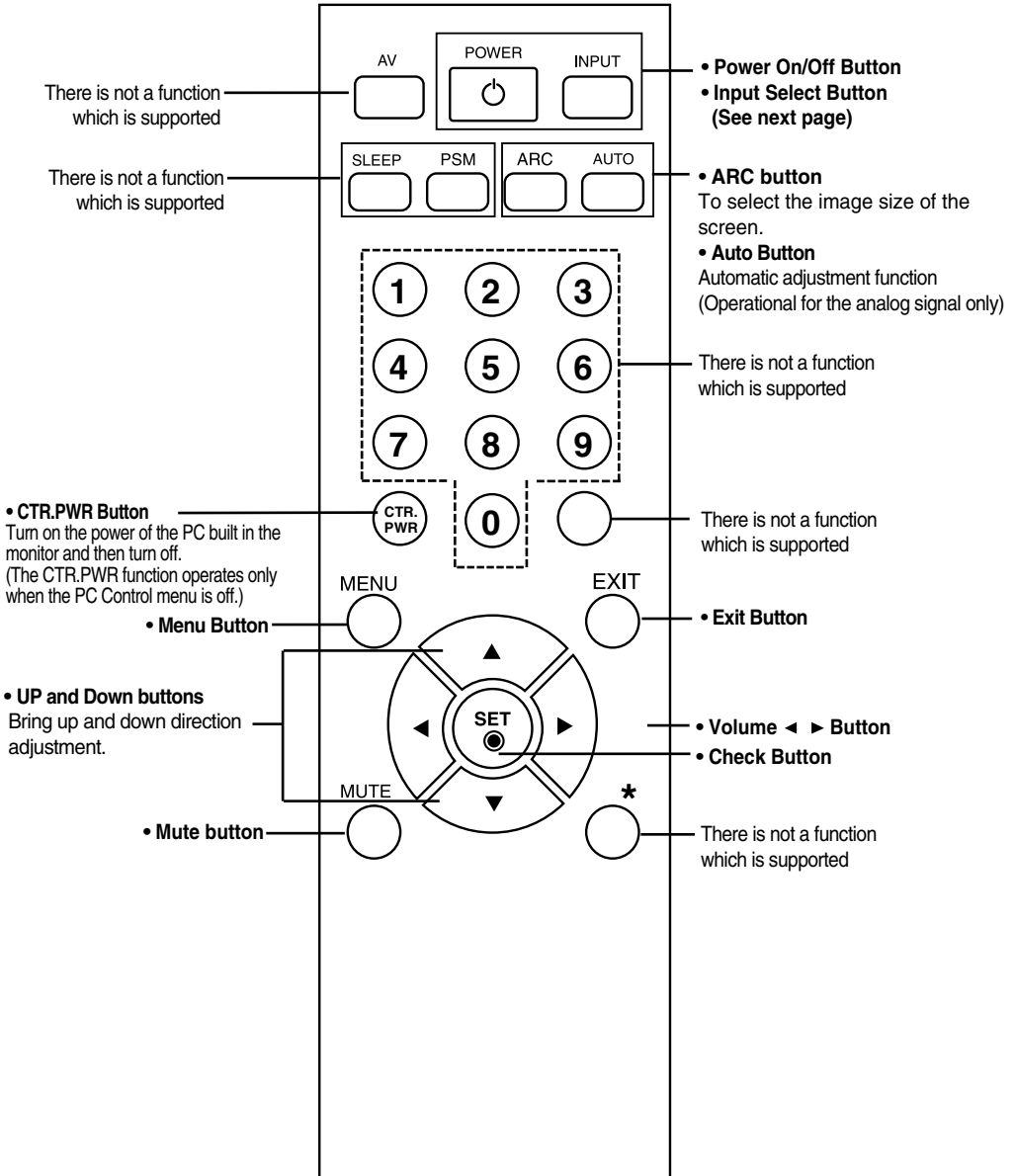

Using the Remote Control

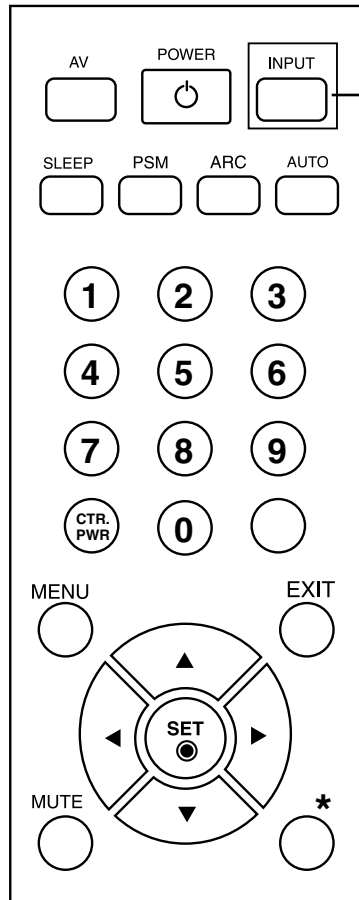

• Input Select Button

If you press the button once, the following Input Signal Window will appear. Select the signal type you want using the ▼ ▲ button.

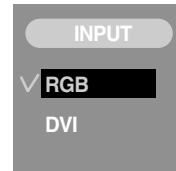

● Inserting batteries into remote control.

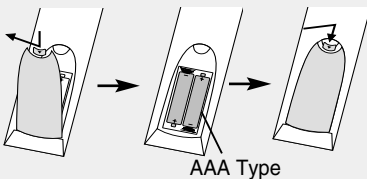

1. Take out the battery cap.

2. Insert the batteries with correct polarity (+/-).

3. Close the battery cap.

- Dispose of used batteries in the recycle bin to prevent environmental pollution.

Connecting the Speakers

* Applicable only for models that support the speakers

Mount the product onto the speaker by using a screw as following picture, and then connect the speaker cable.

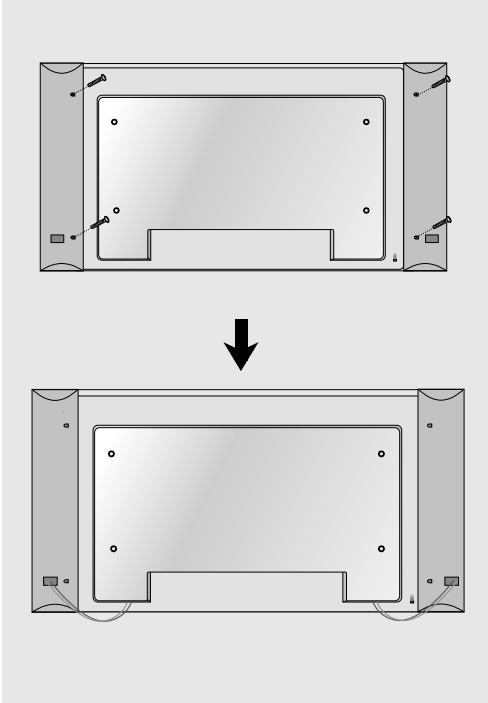

Name and Function of the Parts

* The product image in the user's guide could be different from the actual image.

Rear View

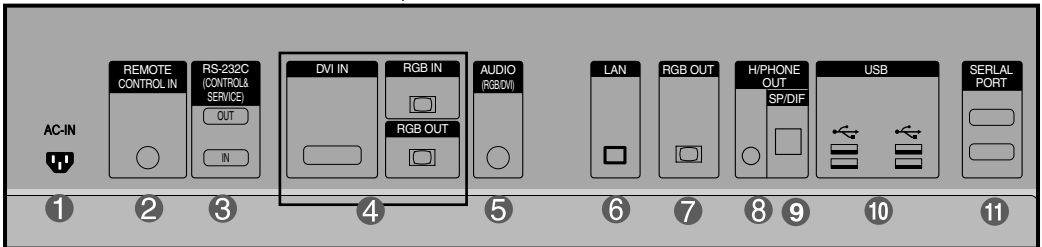
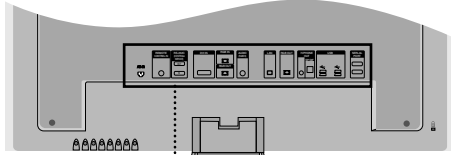

- ① **Power Connector** : Connect the power cord
- ② **Wired Remote Control Port**
- ③ **RS-232C Serial Ports**
- ④ **RGB, DVI Ports**
- ⑤ **PC Sound Jack**
: Connect the audio cable to the ***LINE OUT** jack of the PC sound card.
- ⑥ **LAN Ports**
- ⑦ **RGB out Ports**
- ⑧ **Head Phone out Port**
- ⑨ **Optical Sound out Ports**
- ⑩ **USB Ports**
- ⑪ **Serial Ports**

***LINE OUT**

A terminal used to connect to the speaker including a built-in amplifier (Amp). Make sure that the connecting terminal of the PC sound card is checked before connecting. If the Audio Out of PC sound card has only Speaker Out, reduce the PC volume.

If the Audio Out of the PC sound card supports both Speaker Out and Line Out, convert to Line Out using the card jumper of the program (Refer to the Sound Card Manual).

Connecting to External Devices

■ ■ ■ When Connecting to your Built in PC

When connecting with the DVI signal input cable.

1.

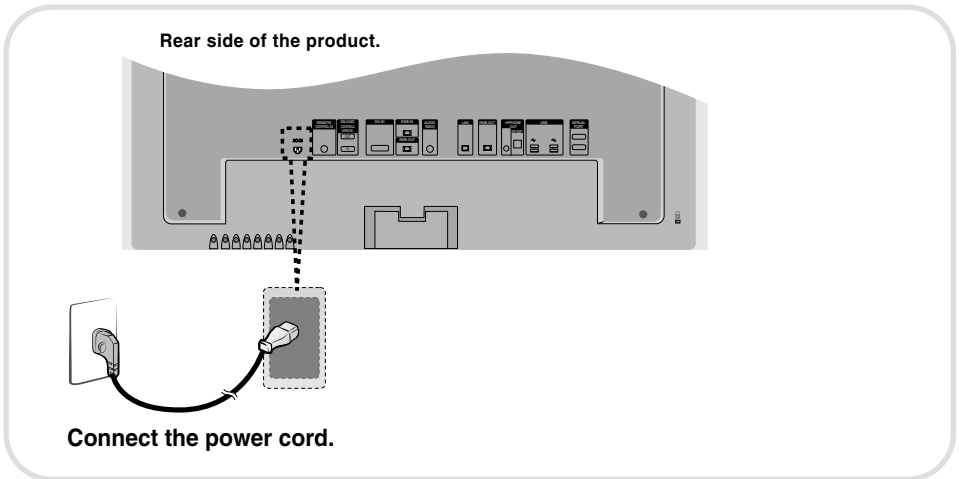

2.

Turn on power by pressing the power button on the product.

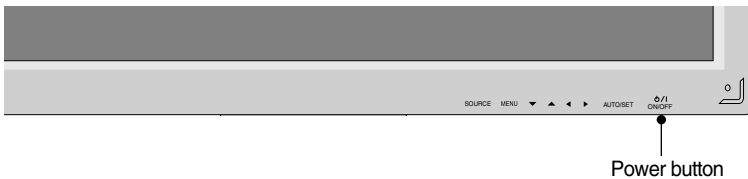

3.

Select an input signal.

Press the INPUT button on the remote control to select the input signal.

INPUT → ▼▲ → SET

Or, press the SOURCE button at the back side of the product.

SOURCE → ▼▲ → AUTO/SET

• Select DVI : DVI Digital signal.

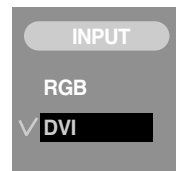

4.

Install the driver files contained at the supplied CD.

Connecting to External Devices

When connecting with the D-Sub signal input cable.

1. Install the Video driver file contained at the supplied CD.

2.

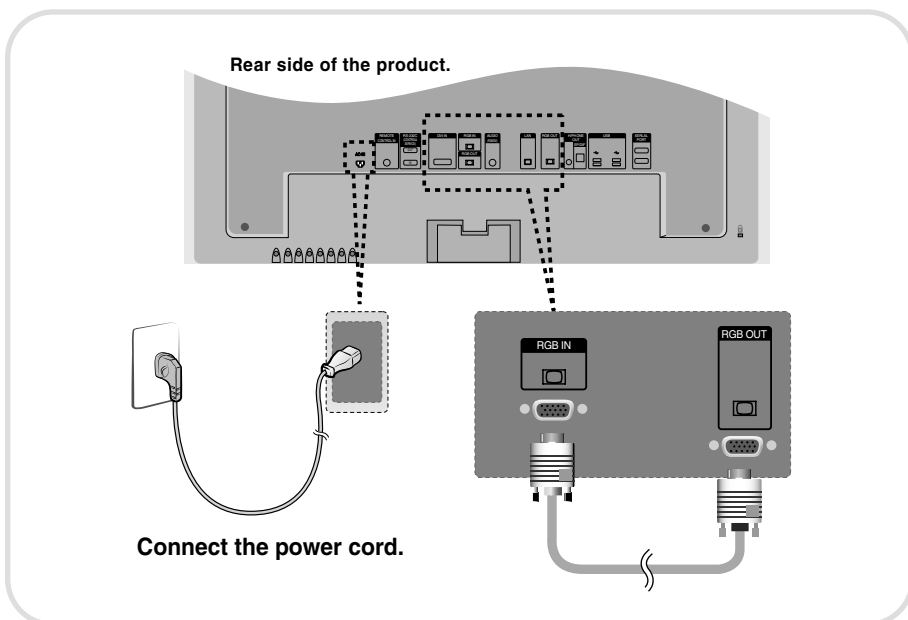

3. Turn on power by pressing the power button on the product.



Connecting to External Devices

4.

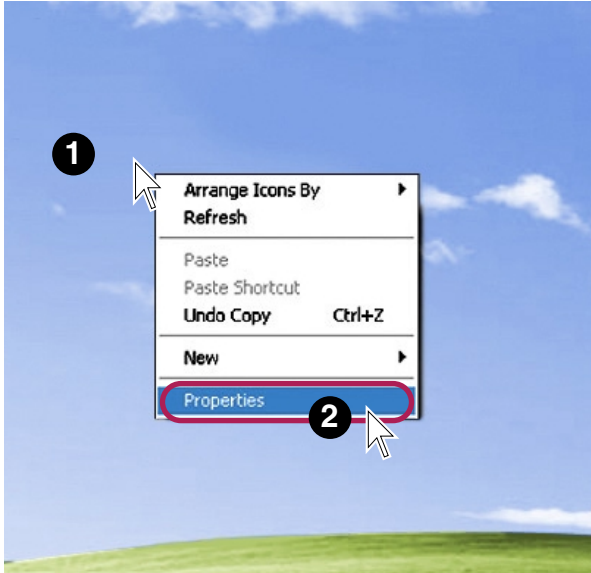

1 Move the mouse pointer to an empty area on the Windows screen (with no icons or task bars) and click the right mouse button.

2 When the pop-up menu appears, click the 'Properties' menu.

5.

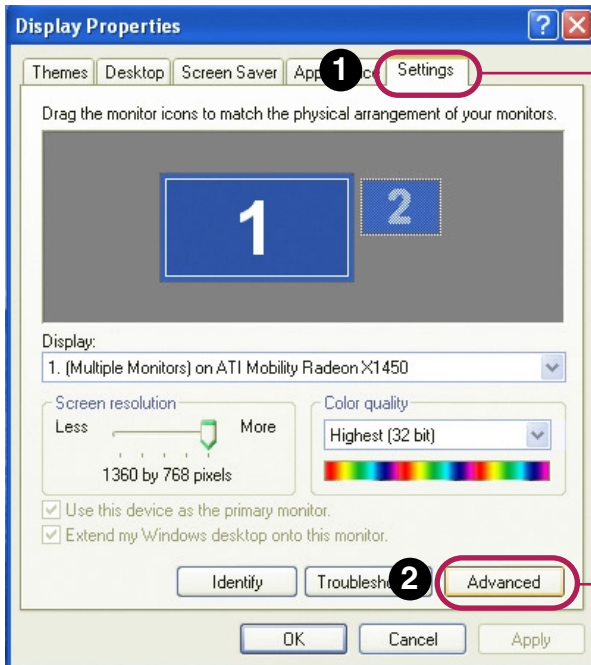

Select 'Settings' tab.

Click 'Advanced' button.

Connecting to External Devices

6.

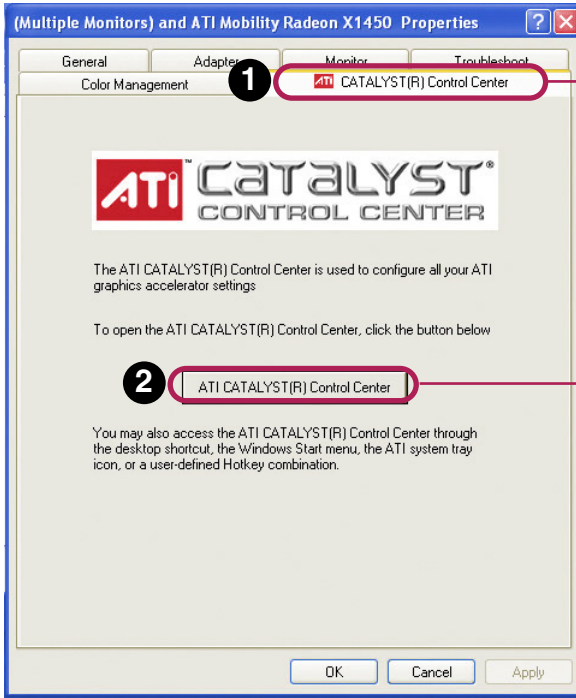

Select 'CATALYST(R)Control Center' tab.

Click 'ATI CATALYST(R)Control Center' button.

7.

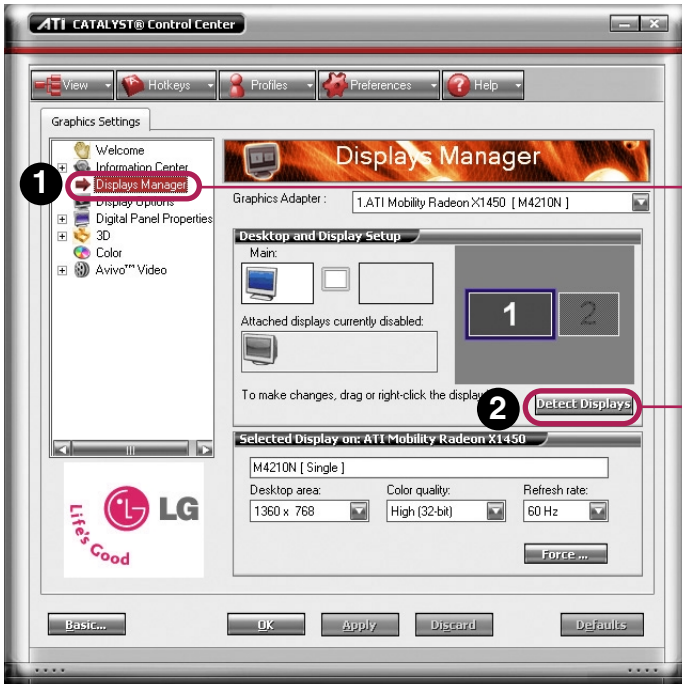

Select 'Display Manager' menu.

Select 'Detect Displays' button.

Connecting to External Devices

8.



- 1 Select **gray monitor icon** and then press the right button of the mouse.
- 2 Select 'Clone Main with monitor' menu.

9.



Click 'Yes' button.

10.

10. Select an input signal.
Press the **INPUT** button on the remote control to select the input signal.

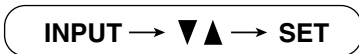

Or, press the **SOURCE** button at the back side of the product.



- Select **RGB** : 15-pin D-Sub analog signal.

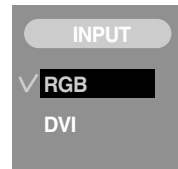

Note

- **How to connect to two computers.**
Connect the signal cables (DVI and D-Sub) to each computer.
Press the **INPUT** button in a remote control to select the computer to use.
- **Directly connect to a grounded power outlet on the wall or a power bar with a ground wire.**

Connecting to External Devices

■ ■ ■ When Connecting to your PC

1.

1 First of all, see if the computer, product and the peripherals are turned off. Then, connect the signal input cable.

A When connecting with the D-Sub signal input cable.

B When connecting with the DVI signal input cable.

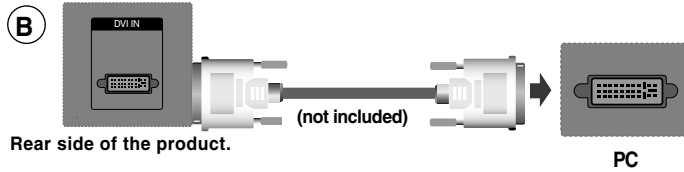

2 Connect the Audio cable.



3 Connect the power cord.

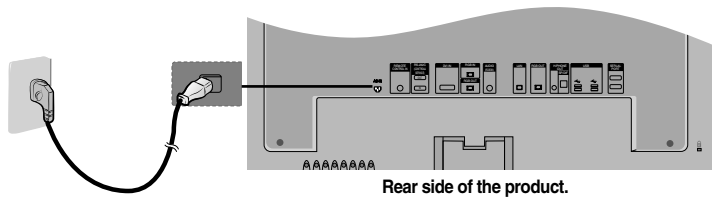

Connecting to External Devices

2. ① Turn on power by pressing the power button on the product.

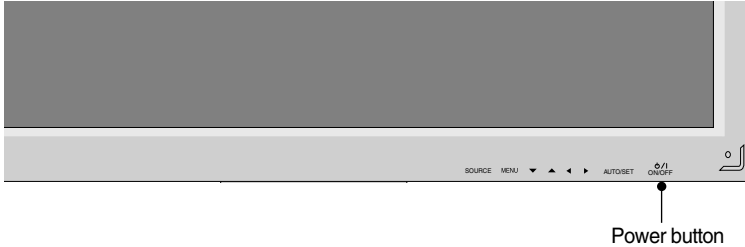

- ② Turn on the PC.

3. Select an input signal.
Press the INPUT button on the remote control to select the input signal.

INPUT → ▼▲ → SET

Or, press the SOURCE button at the back side of the product.

SOURCE → ▼▲ → AUTO/SET

- A** When connecting with a D-Sub signal input cable.
• Select **RGB** : 15-pin D-Sub analog signal.
- B** When connecting with a DVI signal input cable.
• Select **DVI** : DVI Digital signal.

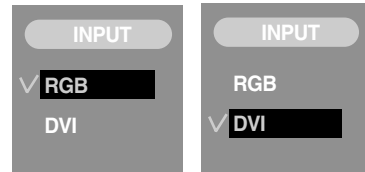

Note

- **How to connect to two computers.**
Connect the signal cables (DVI and D-Sub) to each computer.
Press the INPUT button in a remote control to select the computer to use.
- **Directly connect to a grounded power outlet on the wall or a power bar with a ground wire.**

Connecting to External Devices

■ ■ ■ Watching RGB Outputs

Use this function when displaying ANALOG RGB inputs of a PC to the other product.

- **To use different products connected to each other**

Connect one end of the signal input cable(15-pin D-Sub Signal Cable) to the **RGB OUT** connector of **product 1** and connect the other end to the RGB IN connector of other products.

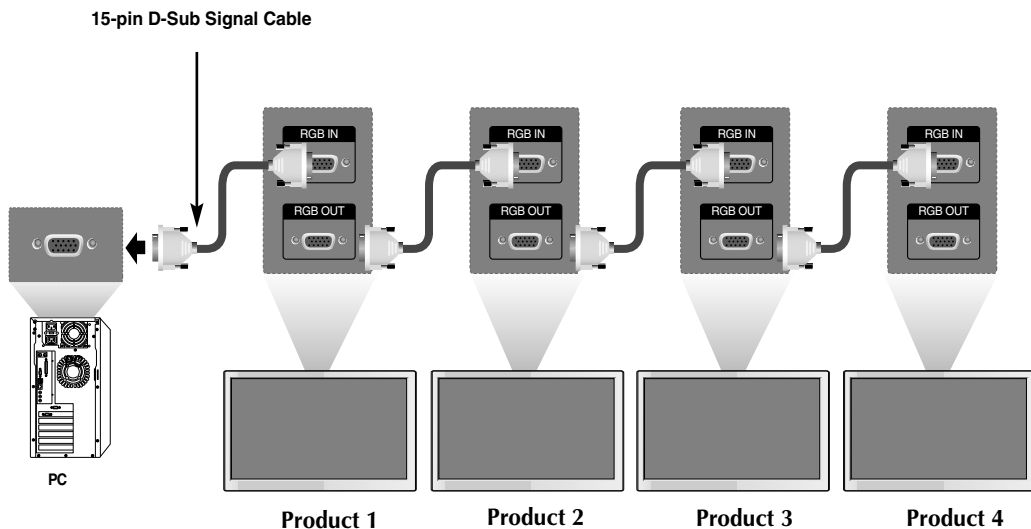

Note

- When multi-connecting in/out cascade format, cables to be less damaged are recommended. We recommend that you should use cable distributor.

To arrange cables using cable management

* Applicable only for models that support the stand.

1. Arrange the cables in the center as shown in the following picture.

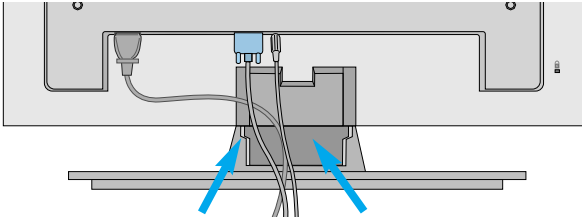

2. Fit the cable management to the Holder Groove downwards.

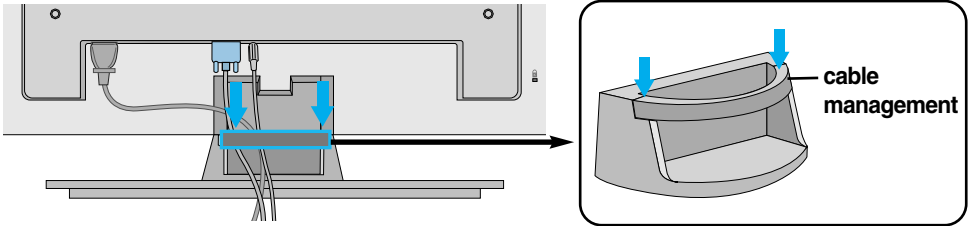

* When you want remove it.

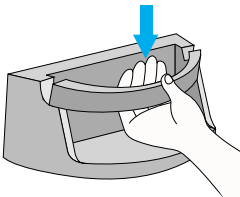

Hold the Cable management with both hands and pull it downward.

Warning

- Do not use the cable management as a handle for the Monitor.
- Do not press the cable management.

Attaching the product to a wall

* This feature is not available for all models.

- Set it up close to the wall so the product doesn't fall over when it is pushed backwards.

The instructions shown below is a safer way to set up the product, which is to fix it on the wall so the product doesn't fall over when it is pulled in the forward direction. It will prevent the product from falling forward and hurting people. It will also prevent the product from damage caused by fall. Please make sure that children don't climb on or hang from the product.

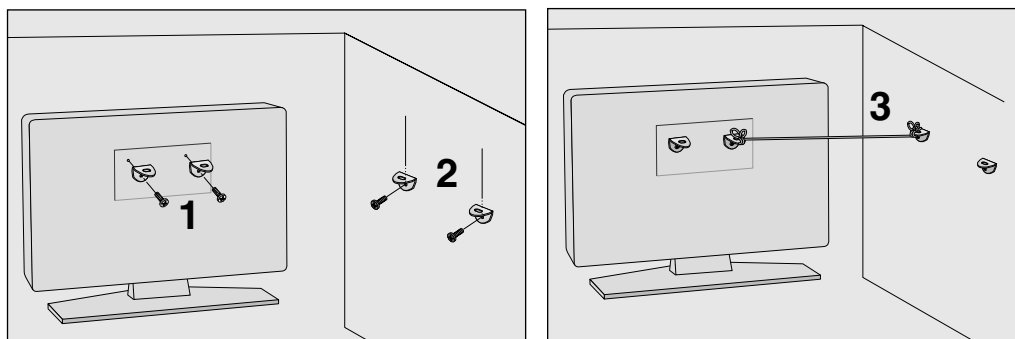

1. Use the bracket and the bolt to fix the product to the wall as shown in the picture.
2. Secure the bracket with the bolt(not provided as parts of the product, must purchase separately) on the wall.
3. Use a sturdy rope (not provided as parts of the product, must purchase separately) to tie the product. It is safer to tie the rope so it becomes horizontal between the wall and the product.



Note

- When moving the product to another place undo the ropes first.
- Use a product holder or a cabinet that is big and strong enough for the size and weight of the product.
- To use the product safely make sure that the height of the bracket that is mounted on the wall is same as that of the product.

Selecting and Adjusting the Screen

● Name of the Buttons in the Screen Adjustment Unit

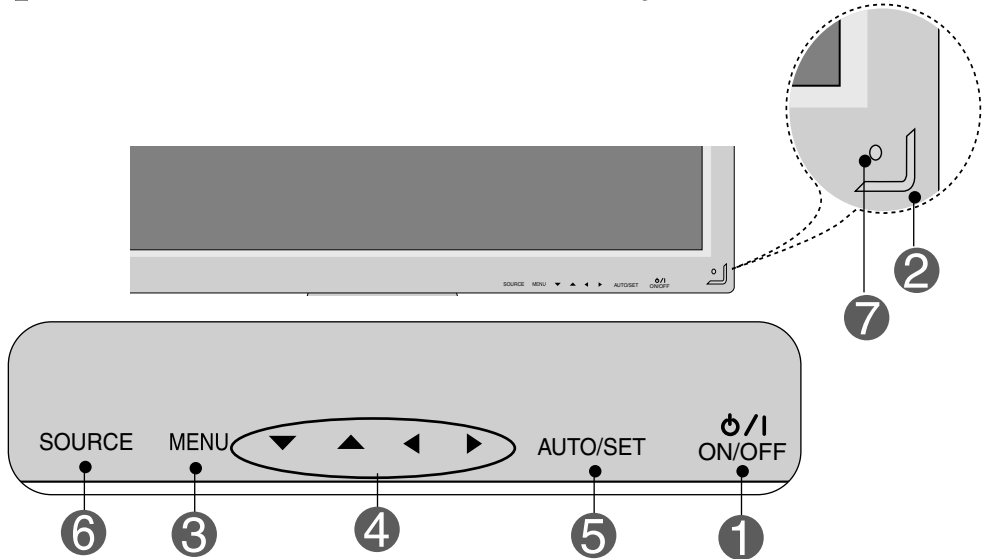

1

Power Button

- Press this button to turn on the power. Press this button again to turn it off.

2

Power Indicator

- This Indicator lights up blue when the display operates normally (on mode). If the display is in sleep (Energy Saving) mode, this indicator color changes to amber.

3

MENU Button

- Use this button to show/hide the OSD (On Screen Display) menu screen.

4

OSD Select / Adjust Button

- Use this button to select an icon or adjust the setting in the OSD screen.

Selecting and Adjusting the Screen

● Name of the Buttons in the Screen Adjustment Unit

5

AUTO/SET Button

If the resolution is 1360X768 (RGB Mode)

Auto in progress

If the resolution is not 1360X768 (RGB Mode)

Auto in progress

For optimal display

Change resolution to 1360 X 768

6

SOURCE Button

• Select the input signal

DVI (Digital signal) ↔ RGB(Analog signal)

Digital signal and Analogue signal can't be outputted at the same time so when transferring the source connect the connector and then turn on the power.





7

IR Receiver

• The unit that receives the signal from the remote control.

Selecting and Adjusting the Screen

OSD Menu

Icon	Function Description
 PICTURE	Adjusts screen brightness, contrast and color that you prefer.
 SOUND	Adjusts the audio function.
 SPECIAL	Adjusts the screen status according to the circumstances.
 SCREEN	Adjusts the screen video.



Note

OSD(On Screen Display)

The OSD function enables you to adjust the screen status conveniently since it provides graphical presentation.

Selecting and Adjusting the Screen

● How to adjust the OSD (On Screen Display) screen

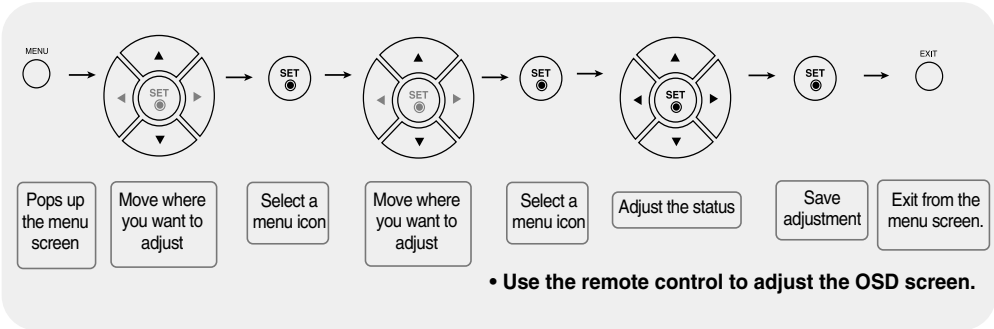

- 2 To access a control, use the ▲ ▼ Buttons.
- 3 When the icon you want becomes highlighted, press the **SET** Button.
- 4 Use the ▲ ▼ / ◀ ▶ Buttons to adjust the item to the desired level.
- 5 Accept the changes by pressing the **SET** Button.
- 6 Exit the OSD by pressing the **EXIT** Button.

● How to adjust the screen automatically

You need to adjust the screen display when connecting the product to a new computer or changing the mode. Refer to the following section to set an optimal product screen.

Press the **AUTO/SET** button (**AUTO** button in a remote Control) in the PC analog signal. Then, an optimal screen status will be selected that fits into the current mode.

If adjustment is not satisfactory, you need to adjust screen position, clock and phase in the OSD menu.

If the resolution is 1360X768

Auto in progress

If the resolution is not 1360X768

Auto in progress

For optimal display

Change resolution to 1360 X 768

Selecting and Adjusting the Screen



Adjusting Screen Color

CSM

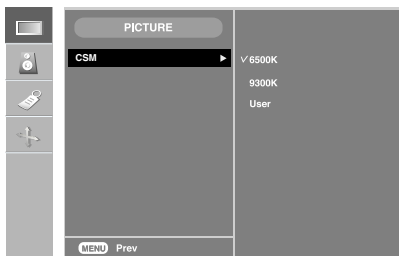

- **6500K/9300K**

Selecting a factory setting color set.

6500K: Slightly reddish white.

9300K: Slightly bluish white.

- **User** : Select this option to use the user-defined settings.

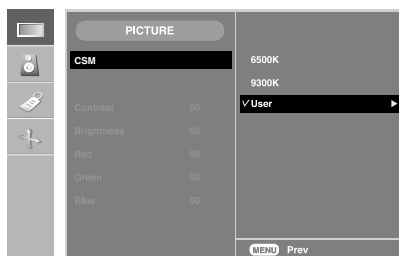

Contrast

To adjust the contrast of the screen.

Brightness

To adjust the brightness of the screen.

Red / Green / Blue

Set your own color levels.

Selecting and Adjusting the Screen



Adjusting the audio function

SSM

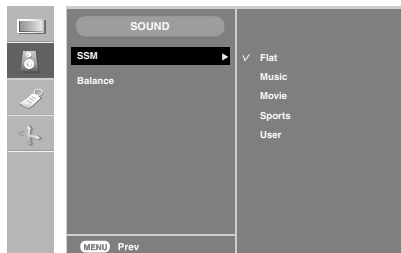

The best sound tone quality will be selected automatically depending on the video type that you're currently watching.

- **Flat** : The most commanding and natural audio.
- **Music** : Select this option to enjoy the original sound when listening to the music.
- **Movie** : Select this option to enjoy sublime sound.
- **Sports** : Select this option to watch sports broadcasting.
- **User** : Select this option to use the user-defined audio settings.

Balance

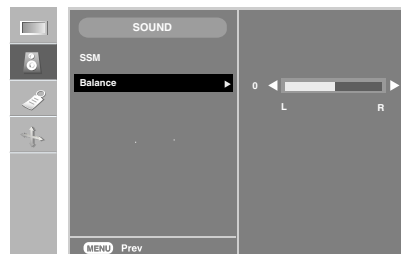

Use this function to balance sound from the left and right speakers.



Note

When connected to your computer and the '**SSM**' setting in the audio menu is one of **Flat**, **Music**, **Movie** or **Sports**, the available menus are **Balance**.

Selecting and Adjusting the Screen



Selecting the options

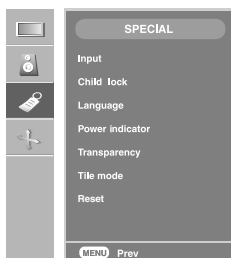

Input

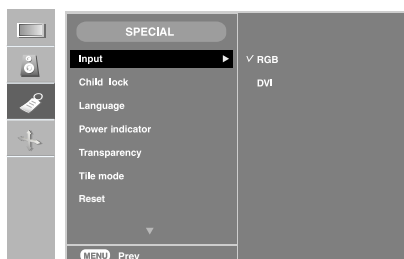

If you press the button once, the following Input Signal Window will appear. Select the signal type you want using the ▲ ▼ button.

Child lock

Use the ▲ ▼ buttons to select **On** or **Off**. The Set can be set up so that it can only be used with the remote control. This feature can prevent unauthorized viewing.

In order to lock the OSD screen adjustment, set the **Child lock** tab to the 'On' position.

In order to unlock it, do the following :

* Push the **MENU** button on the remote control and set **Child lock** to the 'Off' position.

Language

To choose the language in which the control names are displayed.

Power indicator

Use this function to set the power indicator on the front side of the product to **On** or **Off**. If you set **Off**, it will go off. If you set **On** at any time, the power indicator will automatically be turned on.

Transparency

To adjust the transparency of the OSD menu screen.

Selecting and Adjusting the Screen



Selecting the options

- **To use this function**

- You can connect the product with several other products and use the Tile mode function.

Tile mode

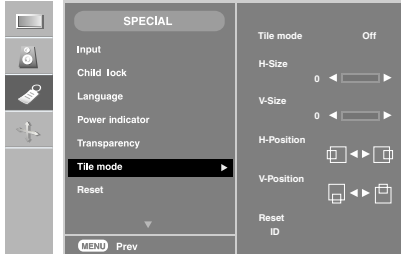

It is used to enlarge the screen and also used with several products to view screen,

- **Tile mode** Tile mode and choose Tile alignment and set the ID of the current product to set location.
- **H Size** Adjust the horizontal size of the screen taking into account the size of the bezel.
- **V Size** Adjust the vertical size of the screen taking into account the size of the bezel.
- **H-Position** Adjust the horizontal position of the screen taking into account the size of the bezel.
- **V-Position** Adjust the vertical position of the screen taking into account the size of the bezel.
- **Reset** Function to initialize and release Tile. All Tile setting are released when selecting. Tile recall and the screen returns to Full screen.
- **ID** Select the location of the Tile by setting an ID.

Selecting and Adjusting the Screen



Selecting the options

- **Tile mode**

- Tile mode : row x column (r = 1, 2, 3, 4 c = 1, 2, 3, 4)
- 4 x 4 available.
- Configuration of an integration screen is also available as well as configuration of one by one Display.



- Tile mode (product 1 ~ 4) : r(2) x c(2)

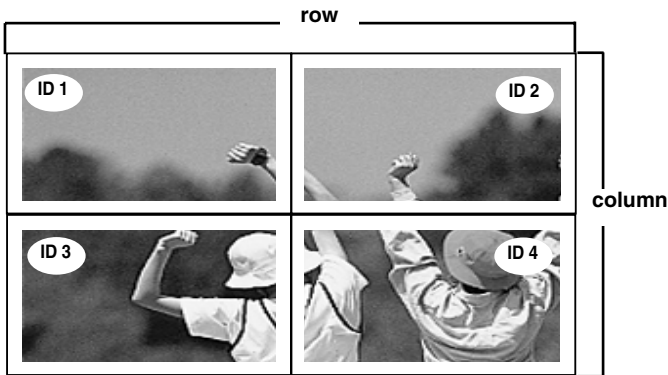

- Tile mode (product 1 ~ 9) : r(3) x c(3)

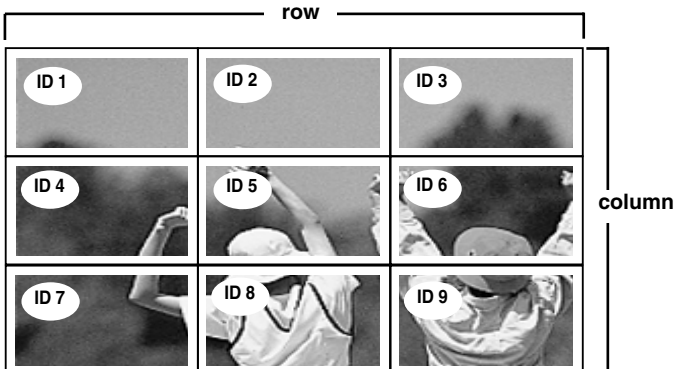

Selecting and Adjusting the Screen



Selecting the options

- Tile mode (product 1 ~ 2) : r(2) x c(1)

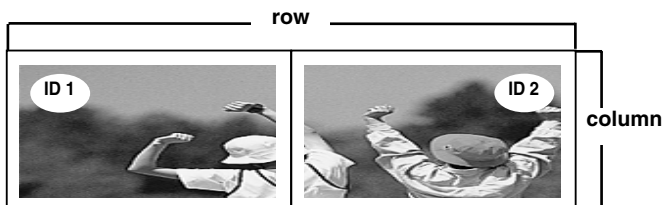

Reset

Use this function to reset the product to the factory default. However, language selection and PC Control selection will not be initialized.

Set ID

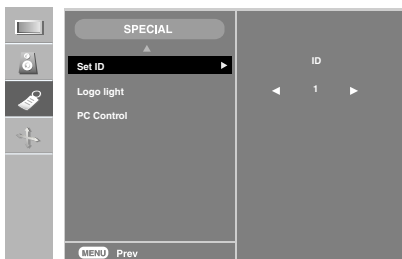

You can assign a unique **Set ID** NO (name assignment) to each product when several products are connected for display. Specify the number (1~99) using the ▲ ▼ button and exit. Use the assigned Set ID to individually control each product using the Product Control Program.

Logo Light

Use this function to set the Logo Display Lamp on the front side of the product to **On** or **Off**. If you set **On**, the lamp will automatically be turned on.

PC Control

You can change the power setting of the PC built in the monitor.

On : Turn on/off both the monitor and the built-in PC.

Off : Turn on/off the built-in PC only.

* How to turn on or off the PC built in the monitor after setting it to Off?

(a) Press the power button at the rear side of the monitor and the SOURCE button at once.

(b) Or, press the CRT.PWR button (for the B type) or the SLEEP button (for the A type) at the remote control.

Selecting and Adjusting the Screen



Adjusting Screen CLOCK/PHASE and Position

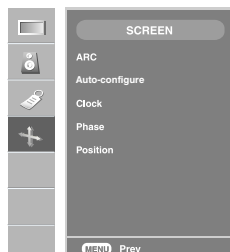

ARC

To select the image size of the screen.
(1:1 menu are not supported over 1360 X 768 resolution)



Auto-configure

This button is for the automatic adjustment of the screen position, clock and phase. This function is suitable for analoge signal input only.

Clock

To minimize any vertical bars or stripes visible on the screen background. The horizontal screen size will also change. This function is suitable for analoge signal input only.

Phase

To adjust the focus of the display. This item allows you to remove any horizontal noise and clear or sharpen the image of characters. This function is suitable for analoge signal input only.

Position

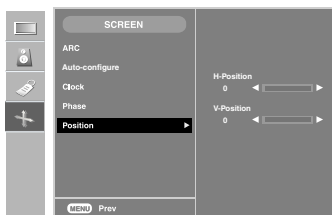

To adjust position of the screen.
This function is suitable for analoge signal input only.

Troubleshooting

No image is displayed

- Is the product power cord connected?
 - See if the power cord is properly connected to the outlet.
- Is the power indicator light on?
 - See if the power switch is turned on.
- Power is on, power indicator is green but the screen appears extremely dark.
 - Adjust brightness and contrast again.
- Is the power indicator amber?
 - If the product is in power saving mode, move the mouse or press any key.
- Does the 'Out of range' message appear?
 - The signal from the PC (video card) is out of the vertical or horizontal frequency range of the product. Adjust the frequency range by referring to the Specifications in this manual.
 - * **Maximum resolution**
RGB : 1280 X 1024 @60Hz
DVI : 1280 X 1024 @60Hz – It may not be supported depending on the OS or video card type.
- Does the 'Power saving mode DVI' message appear?
 - Connect the RGB cable, and then change the input source to 'RGB'.
And then, press the MENU button to set the PC Control value of the SPECIAL menu to 'On'.
Disconnect RGB cable, and turn off the power, and then turn power again.
- Does the 'Check signal cable' message appear?
 - The signal cable between PC and product is not connected. Check the signal cable.
 - Press the 'INPUT' menu in the remote Control to check the input signal.
- Did you check the INPUT Key?
 - Press the 'INPUT' menu in the remote Control to check the input signal.



Note

* **Vertical frequency:** To enable the user to watch the product display, screen image should be changed tens of times every second like a fluorescent lamp. The vertical frequency or refresh rate is the times of image display per second. The unit is Hz.

* **Horizontal frequency:** The horizontal interval is the time to display one vertical line. When 1 is divided by the horizontal interval, the number of horizontal lines displayed every second can be tabulated as the horizontal frequency. The unit is kHz.

Troubleshooting

The screen image looks abnormal.

- Is the screen position wrong at the RGB mode?
 - Do thin lines appear on the background screen at the RGB mode?
 - Horizontal noise appears or the characters look blurred at the RGB mode.
 - The screen is displayed abnormally at the RGB mode.
- Press the “AUTO” button in the remote control to automatically select the optimal screen status that fits into the current mode. If adjustment is not satisfactory, use the Position OSD menu.
 - See if the video card resolution and frequency are supported by the product. If the frequency is out of range, set to the recommended resolution in the Control Panel – Display – Setting menu.
 - Press the “AUTO” button in the remote control to automatically select an optimal screen status that fits into the current mode. If adjustment is not satisfactory, use the Clock OSD menu.
 - Press the “AUTO” button in the remote control to automatically select an optimal screen status that fits into the current mode. If adjustment is not satisfactory, use the Phase OSD menu.
 - The proper input signal is not connected to the signal port. Connect the signal cable that matches with the source input signal.

The audio function does not work.

- No sound?
 - Sound is too dull.
 - Sound is too low.
- See if the audio cable is connected properly.
 - Adjust the volume.
 - See if the sound is set properly.
 - Select the appropriate equalize sound.
 - Adjust the volume.

Troubleshooting

'Child lock on' message appears.

- The 'Child lock on' message appears when pressing the Menu button.

Push the **MENU** button on the remote control and set **Child lock** to the 'Off' position.

After-image appears on the product.

- After-image appears when the product is turned off.

• If you use a fixed image for a long time, the pixels may be damaged quickly. Use the screensaver function.

Screen color is abnormal.

- Screen has poor color resolution (16 colors).
- Do black spots appear on the screen?

• Set the number of colors to more than 32 bits (true color)
Select Control Panel – Display – Settings – Color Table menu in Windows.

• Several pixels (red, green, white or black color) may appear on the screen, which can be attributable to the unique characteristics of the LCD panel. It is not a malfunction of the LCD.

Specifications

The product specifications can change without prior notice for product improvement.

LCD Panel

42 inches (106.73 cm) TFT (Thin Film Transistor)
 LCD (Liquid Crystal Display) Panel
 Anti-Glare coating
 Visible diagonal size: 106.73 cm
 0.681 mm (Pixel Pitch)

Power

Rated Voltage AC 100-240V~ 50/60Hz 2.7A
Power Consumption On Mode : 270W Typ.(with PC), 240W Typ.(only Monitor)
 Sleep Mode : ≤ 20W (only Monitor), 60W(with PC),
 Off Mode : ≤ 5W

Dimensions & Weight

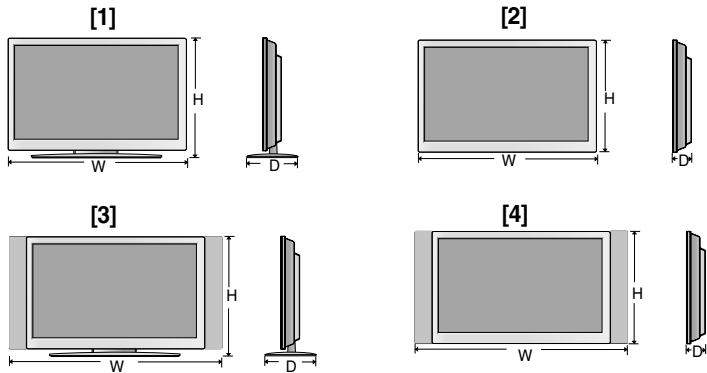

Width x Height x Depth

[1] 99.56 cm (39.19 inches) x 67.41 cm (26.54 inches) x 29.30 cm (11.54 inches)
 [2] 99.56 cm (39.19 inches) x 58.76 cm (23.13 inches) x 11.37 cm (4.47 inches)
 [3] 112.76 cm (44.39 inches) x 67.41 cm (26.54 inches) x 29.30 cm (11.54 inches)
 [4] 112.76 cm (44.39 inches) x 58.76 cm (23.13 inches) x 11.37 cm (4.47 inches)

Net

[1] 25.7 kg (56.65 lbs) [2] 22.3 kg (49.16 lbs)
 [3] 28.3 kg (62.38 lbs) [4] 24.9 kg (54.89 lbs)

NOTE

- Information in this document is subject to change without notice.

Specifications

The product specifications can change without prior notice for product improvement.

Video Signal	Max. Resolution	RGB : 1280 X 1024 @60Hz DVI : 1280 X 1024 @60Hz – It may not be supported depending on the OS or video card type.
	Recommended Resolution	RGB : WSXGA 1360 X 768 @60Hz DVI : WSXGA 1360 X 768 @60Hz
	Horizontal Frequency	RGB : 30 - 83 kHz DVI : 30 - 72 kHz
	Vertical Frequency	56 - 75 Hz (RGB / DVI)
	Synchronization Type	Separate/Composite/Digital
Input Connector		15-pin D-Sub type, DVI (digital), RS-232C
Environmental Conditions	Operational Condition	Temperature: 5°C ~ 35°C , Humidity: 10% ~ 80%
	Storage Condition	Temperature: -20°C ~ 60°C , Humidity: 5% ~ 95%

* Applicable only for models that support the speakers

Audio	RMS Audio Output	10W+10W(R+L)
	Input Sensitivity	0.7Vrms
	Speaker Impedance	8Ω

NOTE

- Information in this document is subject to change without notice.

Specifications

● PC Mode – Preset Mode

Preset mode		Horizontal Frequency (kHz)	Vertical Frequency (Hz)	Preset mode		Horizontal Frequency (kHz)	Vertical Frequency (Hz)
1	VGA 640 x 350	31.469	70	10	VESA 1280 x 720	44.772	60
2	VGA 720 x 400	31.468	70	11	VESA 1280 x 768	47	60
3	VGA 640 x 480	31.469	60	12	VESA 1360 x 768	47.72	60
4	VESA 640 x 480	37.500	75	13	VESA 1280 x 1024	63.981	60
5	VESA 800 x 600	37.879	60				
6	VESA 800 x 600	46.875	75				
7	MAC 832 x 624	49.725	75				
8	VESA 1024 x 768	48.363	60				
9	VESA 1024 x 768	60.123	75				

● Power Indicator

Mode	Product
On Mode	Blue
Sleep Mode	Amber
Off Mode	-

Specifications

● VESA wall mounting

Connected to another object (stand type and wall-mounted type.) This product accepts a VESA-compliant mounting interface pad.- **(This has to be purchased separately if required.)**

For further information, refer to the VESA Wall Mounting Instruction Guide.

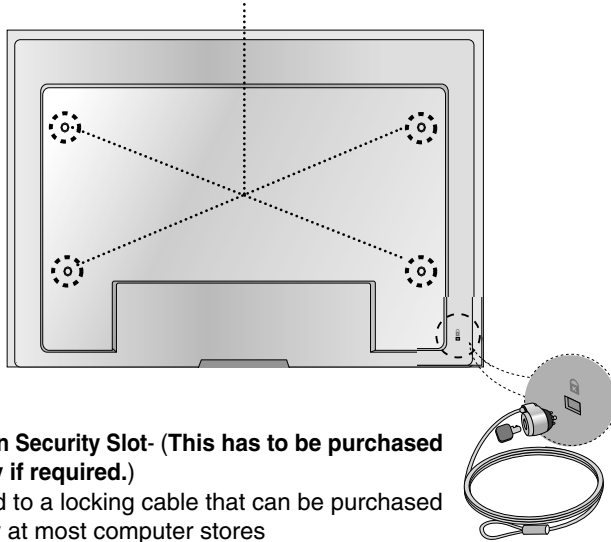

● Kensington Security Slot- **(This has to be purchased separately if required.)**

Connected to a locking cable that can be purchased separately at most computer stores

Specifications

Signal Connector Pin Assignment

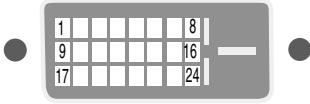

■ DVI-D Connector

Pin	Signal(DVI-D)	Pin	Signal(DVI-D)
1	T. M. D. S. Data2-	16	Hot Plug Detect
2	T. M. D. S. Data2+	17	T. M. D. S. Data0-
3	T. M. D. S. Data2/4 Shield	18	T. M. D. S. Data0+
4	T. M. D. S. Data4-	19	T. M. D. S. Data0/5 Shield
5	T. M. D. S. Data4+	20	T. M. D. S. Data5-
6	DDC Clock	21	T. M. D. S. Data5+
7	DDC Data	22	T. M. D. S. Clock Shield
8	Analog Vertical Sync.	23	T. M. D. S. Clock+
9	T. M. D. S. Data1-	24	T. M. D. S. Clock-
10	T. M. D. S. Data1+		
11	T. M. D. S. Data1/3 Shield		
12	T. M. D. S. Data3-		
13	T. M. D. S. Data3+		
14	+5V Power		
15	Ground (return for +5V, H. Sync. and V. Sync.)		

T. M. D. S. (Transition Minimized Differential Signaling)

Specifications

■ ■ ■ Connecting the USB(Universal Serial Bus) Cable

"USB (Universal Serial Bus)" is an innovation in connecting your different desktop peripherals conveniently to your computer. By using the USB, you will be able to connect your mouse, keyboard, and other peripherals to your display instead of having to connect them to your computer. This will give you greater flexibility in setting up your system. USB allows you to connect a chain of up to 120 devices on a single USB port; and you can "hot" plug (attach them while the computer is running) or unplug them while maintaining the Plug and the Plug auto detection and configuration. This display has an integrated BUS-powered USB hub, allowing up to 2 other USB devices to be attached it.

1. Connect the upstream port of the display to the downstream port of the USB compliant PC or another hub using the USB cable.
2. Connect the USB compliant peripherals to the downstream ports of the display.

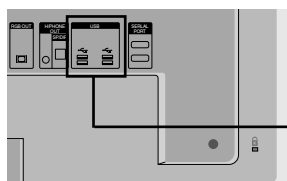

USB downstream Port
connect the cables from USB compliant peripherals-such as keyboard, mouse, etc

3. The monitor's USB terminal supports USB 2.0 and High Speed cables.

	High Speed	Full Speed	Low Speed
Data Rate	480Mbps	12Mbps	1.5Mbps
Power Consumption	2.5W (Max,each Port)	2.5W (Max,each Port)	2.5W (Max,each Port)

NOTE

- To activate the USB hub function, the display must be connected to a USB compliant PC(OS) or another hub with the USB cable(enclosed).
- When connecting the USB cable, check that the shape of the connector at the cable side matches the shape at the connecting side.
- Even if the display is in a power saving mode, USB compliant devices will function when they are connected the USB ports(both the upstream and downstream) of the display.

Controlling the Multiple Product

**Use this method to connect several products to a single PC.
You can control several products at a time by connecting them to a single PC.**

Connecting the cable

Connect the RS-232C cable as shown in the picture.

* The RS-232C protocol is used for communication between the PC and product. You can turn the product on/off, select an input source or adjust the OSD menu from your PC.

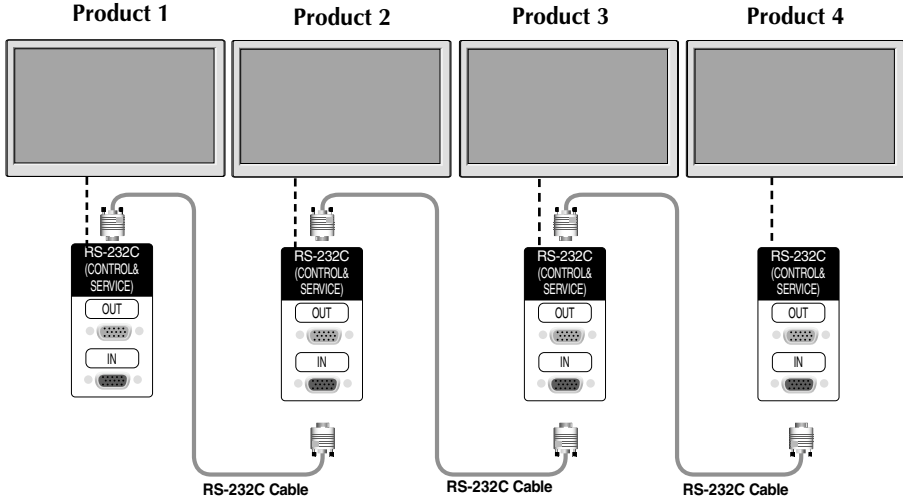

RS-232C Configurations

7-Wire Configurations (Standard RS-232C cable)

	PC	Monitor	
RXD	2	2	TXD
TXD	3	3	RXD
GND	5	5	GND
DTR	4	4	DSR
DSR	6	6	DTR
RTS	7	7	CTS
CTS	8	8	RTS
	D-Sub 9 (Female)	D-Sub 9 (Male)	

3-Wire Configurations (Not Standard)

	PC	Monitor	
RXD	2	2	TXD
TXD	3	3	RXD
GND	5	5	GND
DTR	4	4	DSR
DSR	6	6	DTR
RTS	7	7	CTS
CTS	8	8	RTS
	D-Sub 9 (Female)	D-Sub 9 (Male)	

Communication Parameter

- ▶ Baud Rate : 9600baudRate (UART)
- ▶ Data Length : 8bits
- ▶ Parity Bit : None
- ▶ Stop Bit : 1bit
- ▶ Flow Control : None
- ▶ Communication Code : ASCII code
- ▶ Use a straight cable

 Command Reference List

	COMMAND1	COMMAND2	DATA(Hexa)
01. Power	k	a	00H - 01H
02. Main Input Select	k	b	01H,07H, 09H
03. Aspect Ratio	k	c	08H, 09H
04. Screen Mute	k	d	00H - 01H
05. Volume Mute	k	e	00H - 01H
06. Volume Control	k	f	00H - 64H
07. Contrast	k	g	00H - 64H
08. Brightness	k	h	00H - 64H
09. OSD Select	k	l	00H - 01H
10. Remote On/Off	k	m	00H - 01H
11. Balance	k	t	00H - 64H
12. Select Color Temp	k	u	00H - 02H
13. Auto Configure	j	u	01H
14. Red Gain Adjust	j	w	00H - 64H
15. Green Gain Adjust	j	y	00H - 64H
16. Blue Gain Adjust	j	z	00H - 64H
17. Tiling Mode	d	d	00H - 44H
18. Tile H Position	d	e	00H - 64H
19. Tile V Position	d	f	00H - 64H
20. Tile H Size	d	g	00H - 64H
21. Tile V Size	d	h	00H - 64H
22. Tile ID Set	d	i	00H - 10H
23. Temperature Check	d	n	FFH
24. Inverter Adjust	d	r	00H - 01H
25. PC Power On/Off	d	s	00H - 01H
26. PC Control On/Off	d	t	00H - 01H
27. Input Select	x	b	01H,06H, 08H

● Transmission / Receiving Protocol

Transmission

```
[Command1][Command2][ ][Set ID][ ][Data][Cr]
```

- * [Command 1]: First command. (k)
- * [Command 2]: Second command. (a ~ u)
- * [Set ID]: You can adjust the set ID to choose desired product ID number in Special menu. Adjustment range is 1 ~99. When selecting Set ID '0', every connected set is controlled. Set ID is indicated as decimal (1~255) on menu and as Hexa decimal (0x0~0x64) on transmission/receiving protocol.
- * [DATA]: To transmit command data.
Transmit 'FF' data to read status of command.
- * [Cr]: Carriage Return
ASCII code '0x0D'
- * []: ASCII code Space (0x20)

OK Acknowledgement

```
[Command2][ ][Set ID][ ][OK][Data][x]
```

- * The Product transmits ACK (acknowledgement) based on this format when receiving normal data. At this time, if the data is data read mode, it indicates present status data. If the data is data write mode, it returns the data of the PC computer.

Error Acknowledgement

```
[Command2][ ][Set ID][ ][NG][Data][x]
```

- * The Product transmits ACK (acknowledgement) based on this format when receiving abnormal data from non-viable functions or communication errors.

Data 1: Illegal Code

- 2: Not supported function
- 3: Wait more time

Transmission / Receiving Protocol

01. Power On(Command : a)

- ▶ To control Power On/Off of the Set.

Transmission

```
[k][a][ ][Set ID][ ][Data][Cr]
```

Data 0 : Power Off 1 : Power On ff: Read Status

Acknowledgement

```
[a][ ][Set ID][ ][OK][Data][x]
```

- ▶ To show the status of Power On/Off.

Transmission

```
[k][a][ ][Set ID][ ][FF][Cr]
```

Data 0 : Power Off 1 : Power On ff: Read Status

Acknowledgement

```
[a][ ][Set ID][ ][OK][Data][x]
```

- * The Product transmits ACK (acknowledgement) based on this format when receiving normal data. At this time, if the data is data read mode, it indicates present status data. If the data is data write mode, it returns the data of the PC computer.

02. Main input Select(Command : b) (Main Picture Input)

- ▶ To select input source for the Set.
You can also select an input source using the INPUT button on the remote control.

Transmission

```
[k][b][ ][Set ID][ ][Data][Cr]
```

Data 1 : RGB
7 : RGB
9 : DVI

Acknowledgement

```
[b][ ][Set ID][ ][OK][Data][x]
```

● Transmission / Receiving Protocol

03. Aspect Ratio(Command : c) (Main picture format)

▶ To adjust the screen format.

You can also adjust the screen format using the ARC (Aspect Ratio Control) button on remote control or in the Screen menu.

Transmission

```
[k][c][ ][Set ID][ ][Data][Cr]
```

Data 8 : Full mode

9 : 1:1 (Operates only if current resolution is less than recommended resolution.)

Acknowledgement

```
[c][ ][Set ID][ ][OK][Data][x]
```

04. Screen Mute(Command : d)

▶ To select screen mute on/off.

Transmission

```
[k][d][ ][Set ID][ ][Data][Cr]
```

Data 0 : Screen mute off (Picture on)

1 : Screen mute on (Picture off)

Acknowledgement

```
[d][ ][Set ID][ ][OK][Data][x]
```

● Transmission / Receiving Protocol

05. Volume Mute(Command : e)

- ▶ To control On/Off of the Volume Mute.

Transmission

```
[k][e][ ][Set ID][ ][Data][Cr]
```

Data 0 : Volume Mute On (Volume Off)
1 : Volume Mute Off (Volume On)

Acknowledgement

```
[e][ ][Set ID][ ][OK][Data][x]
```

Data 0 : Volume Mute On (Volume Off)
1 : Volume Mute Off (Volume On)

06. Volume Control(Command : f)

- ▶ To adjust Volume .

Transmission

```
[k][f][ ][Set ID][ ][Data][Cr]
```

Data Min : 00H ~ Max : 64H
(Hexadecimal code)

Acknowledgement

```
[f][ ][Set ID][ ][OK][Data][x]
```

Data Min : 00H ~ Max : 64H

- Refer to 'Real data mapping' page 7.

● Transmission / Receiving Protocol

07. Contrast(Command : g)

- ▶ To adjust screen contrast.
You can also adjust the contrast in the Picture menu.

Transmission

```
[k][g][ ][Set ID][ ][Data][Cr]
```

Data Min : 00H ~ Max : 64H

- Refer to 'Real data mapping' as shown below.

Acknowledgement

```
[g][ ][Set ID][ ][OK][Data][x]
```

* Real data mapping

0 : Step 0
:
A : Step 10
:
F : Step 15
10 : Step 16
:
64 : Step 100

08. Brightness(Command : h)

- ▶ To adjust screen brightness.
You can also adjust the brightness in the Picture menu.

Transmission

```
[k][h][ ][Set ID][ ][Data][Cr]
```

Data Min : 00H ~ Max : 64H

- Refer to 'Real data mapping' as shown below.

Acknowledgement

```
[h][ ][Set ID][ ][OK][Data][x]
```

* Real data mapping

0 : Step
:
A : Step 10
:
F : Step 15
10 : Step 16
:
64 : Step 100

● Transmission / Receiving Protocol

09. OSD Select(Command : l)

▶ To control OSD on/off to the set.

Transmission

```
[k][l][ ][Set ID][ ][Data][Cr]
```

Data 0 : OSD Off 1 : OSD On

Acknowledgement

```
[l][ ][Set ID][ ][OK][Data][x]
```

Data 0 : OSD Off 1 : OSD On

10. Remote On/Off (Command : m)

▶ Lock the buttons at the rear side of the monitor and the button at the remote control.

Transmission

```
[k][m][ ][Set ID][ ][Data][Cr]
```

Data 0 : Off 1 : On

Acknowledgement

```
[m][ ][Set ID][ ][OK][Data][x]
```

Data 0 : Off 1 : On

11. Balance (Command : t)

▶ To adjust the sound balance.

Transmission

```
[k][t][ ][Set ID][ ][Data][Cr]
```

Data Min : 00H ~ Max : 64H

32H : Center 00H : Left 64H : Right

Acknowledgement

```
[t][ ][Set ID][ ][OK][Data][x]
```

32H : Center 00H : Left 64H : Right

● Transmission / Receiving Protocol

12. Select Color Temp (Command : u)

- ▶ To adjust the screen color temperature.

Transmission

```
[k][u][ ][Set ID][ ][Data][Cr]
```

Data 0 : User

- 1 : 9300K
- 2 : 6500K

Acknowledgement

```
[u][ ][Set ID][ ][OK][Data][x]
```

Data 0 : User

- 1 : 9300K
- 2 : 6500K

13. Auto Configure(Command: j u)

- ▶ To adjust picture position and minimize image shaking automatically. it works only in RGB(PC) mode.

Transmission

```
[j][u][ ][Set ID][ ][Data][Cr]
```

Data 1 : To set

Acknowledgement

```
[u][ ][Set ID][ ][OK][Data][x]
```

● Transmission / Receiving Protocol

14. Red Gain Adjust (Command: j w)

▶ To adjust Red color level.

Transmission

```
[j][w][ ][Set ID][ ][Data][Cr]
```

Data Min : 00H ~ Max : 64H

Acknowledgement

```
[w][ ][Set ID][ ][OK][Data][x]
```

* When it is executed with the 6500K or 9300K selected, it is automatically changed to the USER.

15. Green Gain Adjust (Command: j y)

▶ To adjust Green color level.

Transmission

```
[j][y][ ][Set ID][ ][Data][Cr]
```

Data Min : 00H ~ Max : 64H

Acknowledgement

```
[y][ ][Set ID][ ][OK][Data][x]
```

* When it is executed with the 6500K or 9300K selected, it is automatically changed to the USER.

16. Blue Gain Adjust (Command: j z)

▶ To adjust Blue color level.

Transmission

```
[j][z][ ][Set ID][ ][Data][Cr]
```

Data Min : 00H ~ Max : 64H

Acknowledgement

```
[z][ ][Set ID][ ][OK][Data][x]
```

* When it is executed with the 6500K or 9300K selected, it is automatically changed to the USER.

● Transmission / Receiving Protocol

17. Tiling Mode (Command :d d)

▶ Change a Tiling Mode.

Transmission

```
[d][d][Set ID][Data][x]
```

Data	Description
00	Tiling mode is off.
12	1 x 2 mode(column x row)
13	1 x 3 mode
14	1 x 4 mode
...	...
44	4 x 4 mode

* The data can not be set to 0X or X0 except 00.

Acknowledgement

```
[d][00][OK/NG][Data][x]
```

18. Tile H Position (Command :d e)

▶ To set the horizontal position.

Transmission

```
[d][e][Set ID][Data][x]
```

Data Min : 00H ~ Max : 64H
(Hexadecimal code)

Acknowledgement

```
[e][Set ID][OK/NG][Data][x]
```

● Transmission / Receiving Protocol

19. Tile V Position(Command : d f)

▶To set the Vertical position.

Transmission

```
[d][f][Set ID][Data][x]
```

* The data range is from 00 to 64(in Hex).

Acknowledgement

```
[f][Set ID][OK/NG][Data][x]
```

20. Tile H Size(Command : d g)

▶To set the Horizontal size.

Transmission

```
[d][g][Set ID][Data][x]
```

* The data range is from 00 to 64(in Hex).

Acknowledgement

```
[g][Set ID][OK/NG][Data][x]
```

21. Tile V Size(Command : d h)

▶To set the Vertical size.

Transmission

```
[d][h][Set ID][Data][x]
```

* The data range is from 00 to 64(in Hex).

Acknowledgement

```
[h][Set ID][OK/NG][Data][x]
```

● Transmission / Receiving Protocol

22. Tile ID Set (Command : d i)

▶ To assign the Tile ID for Tiling function.

Transmission

```
[d][i][Set ID][Data][x]
```

* The data range is from 00 to 10 tile mode. (in Hex).

Acknowledgement

```
[i][Set ID][OK/NG][Data][x]
```

23. Temperature check (Command : d n)

▶ To read the inside temperature value.

Transmission

```
[d][n][Set ID][Data][x]
```

* The data is always FF(in Hex).

Acknowledgement

```
[n][Set ID][OK/NG][Data][x]
```

Data are 1 byte long in Hex ASCII format.

24. Inverter Adjust (Command : d r)

▶ To adjust the Inverter.

Transmission

```
[d][r][Set ID][Data][x]
```

Data 0 : Inverter Off

1 : Inverter On

Acknowledgement

```
[r][Set ID][OK/NG][Data][x]
```

● Transmission / Receiving Protocol

25. PC Power On/Off (Command : d s)

- ▶ To turn On and Off the built in PC.

Transmission

```
[d][s][ ][Set ID][ ][Data][x]
```

Data 0 : PC Power Off

1 : PC Power On

Acknowledgement

```
[s][ ][Set ID][ ][OK/NG][Data][x]
```

*This operates only when 'PC Control' is 'Off'.

26. PC Control On/Off (Command : d t)

- ▶ It sets the synchronized power on/off between the built-in PC of the monitor and the monitor.

Transmission

```
[d][t][ ][Set ID][ ][Data][x]
```

Data 0 : Off

1 : On

Acknowledgement

```
[t][ ][Set ID][ ][OK/NG][Data][x]
```

27. Input Selection (Command : b) (Main Picture Input)

- ▶ To select input source for the Set.
You can also select an input source using the INPUT button on the remote control.

Transmission

```
[x][b][ ][Set ID][ ][Data][Cr]
```

Data 01 : RGB

06 : RGB

08 : DVI

Acknowledgement

```
[b][ ][Set ID][ ][OK][Data][x]
```

How to connect

- ▶ Connect your wired remote control to Remote Control port on the Product.

Remote Control IR Code

▶ Output waveform

single pulse, modulated with 37.917KHz signal at 455KHz

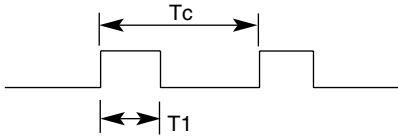

Carrier frequency

$$FCAR = 1/Tc = fosc/12$$

$$\text{Duty ratio} = T1/Tc = 1/3$$

▶ Configuration of frame

- 1st frame

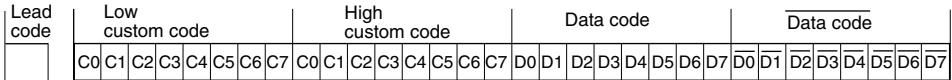

- Repeat frame

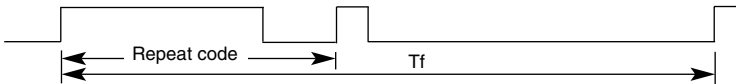

▶ Lead code

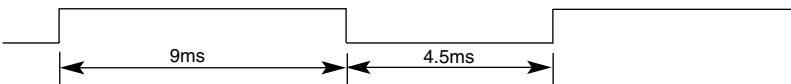

▶ Repeat code

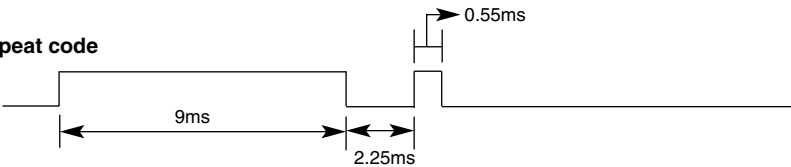

▶ Bit description

- Bit "0"

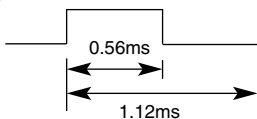

- Bit "1"

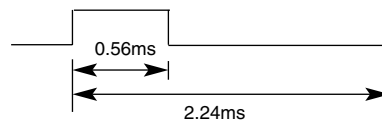

▶ Frame interval : Tf

- The waveform is transmitted as long as a key is depressed.

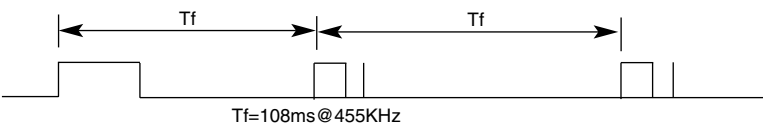

IR Codes

Code(Hexa)	Function	Note
00	▲	R/C Button
01	▼	R/C Button
02	VOL(▶)	R/C Button
03	VOL(◀)	R/C Button
08	POWER ON/OFF	R/C Button (Power On/Off)
C4	POWER ON	Discrete IR Code(Only Power On)
C5	POWER OFF	Discrete IR Code(Only Power On)
09	MUTE	R/C Button
0B	INPUT	R/C Button
43	MENU	R/C Button
5B	EXIT	R/C Button
44	SET	R/C Button
10	Number Key 0	R/C Button
11	Number Key 1	R/C Button
12	Number Key 2	R/C Button
13	Number Key 3	R/C Button
14	Number Key 4	R/C Button
15	Number Key 5	R/C Button
16	Number Key 6	R/C Button
17	Number Key 7	R/C Button
18	Number Key 8	R/C Button
19	Number Key 9	R/C Button
D5	RGB	Discrete IR Code(Input RGB PC Selection)
C6	DVI	Discrete IR Code(Input DVI Selection)
79	ARC	R/C Button
77	ARC (1:1)	Discrete IR Code(Only 1:1 mode)
AF	AUTO CONFIC	Discrete IR Code