



# Ceramic Glass HOB

## Installation and Operating Instructions

**KA60510S**

**KA60510A**

**KA60510F**

**KA60520S**

To avoid the risk of accidents or damage to the HOB,  
it is essential to read these operating instructions  
before it is installed or used for the first time.  
And please keep this manual for later reference.

# Dear Customer

---

Please read these operating instructions carefully.  
Above all, please observe the “safety” section on the first few pages.  
Please retain these operating instructions for later reference.  
Pass them on to any subsequent owners of the appliance.

**The following symbols are used in the text:**



## **Safety information**

- Warning:** Information concerning your personal safety.
- Important:** Information on how to avoid damaging the appliance.



## **Information and practical tips**



## **Environmental information**

1. These numbers indicate step by step how to use the appliance.
2. ...
3. ...

These operating instructions contain information on steps you can take yourself to rectify a possible malfunction. Refer to the section “What to do if...”.

# Contents

---

<b>Safety</b> .....	<b>4-7</b>
<b>Suitable Kitchenware</b> .....	<b>8-9</b>
<b>Description of the appliance</b> .....	<b>10</b>
Cooking zones and control .....	10
<b>The key features of your appliance</b> .....	<b>11</b>
<b>Operating Instructions</b> .....	<b>12-19</b>
Before using for the first time .....	12
Operating the hob .....	12
Cooking zone selection .....	13
Dual Selection .....	15
Child lock .....	16
Oval selection .....	16
Timer .....	17
Pause .....	19
<b>Uses, Tables and Tips</b> .....	<b>20</b>
Chart for Setting the Cooking Zones .....	20
<b>Automatic time limiter</b> .....	<b>21</b>
<b>Cleaning and Care</b> .....	<b>22-23</b>
<b>Installation Instructions</b> .....	<b>24-32</b>
Technical data .....	24
Regulations, Standards, Directives .....	25
Safety instructions for the installer .....	26
Electrical connection .....	27
Assembly .....	29
<b>Troubleshooting</b> .....	<b>33-35</b>
<b>Service</b> .....	<b>36</b>

# Safety

---

 The safety aspects of this appliance comply with accepted technical standards and IEC Standards. However, as the manufacturer we also believe it is our responsibility to familiarize you with the following safety instructions.

## Electrical Safety

- The installation and connection of the new appliance must only be carried out by qualified personnel.
- Repairs to the appliance are only to be carried out by approved service persons. Repairs carried out by inexperienced persons may cause injury or serious malfunctioning. If your appliance needs repairing, please contact your local Service Centre.
- This connection may be achieved by having the plug accessible or by incorporation a switch in the fixed wiring in accordance with the wiring rules.

 Please follow these instructions, otherwise the warranty will not cover any damage that may occur.

- Flush-mounted appliances may only be operated following installation in suitable cabinets and workplaces which conform to the relevant standards. This ensures sufficient protection against electric shock as required by certification body.

- If your appliance malfunctions or fractures:
  - switch off all cooking zones, and contact Service Center.

 If the surface is cracked, switch off the appliance to avoid the possibility of electric shock. Do not re-use your hob until the glass surface has been changed.

 When using Hob, never use aluminum foil, products wrapped in aluminum foil, or deep frozen food in aluminum cookware.

 If the supply cord is damaged, it must be replaced by the manufacturer, its service agent or similarly qualified persons in order to avoid a hazard.

---

## Child Safety

 This appliance is not intended for use by young children or infirm persons unless they have been adequately supervised by a responsible person to ensure that they can use the appliance safely.

Young children should be supervised to ensure that they do not play with the appliance.

 **WARNING:** Accessible parts may become hot during use.  
Young children should be kept away.

The cooking zones will become hot when you cook. Therefore, always keep small children away from the appliance.

Although cooktop is equipped with a control lock, surfaces may still be hot.

## Safety During Use

- This appliance may only be used for normal cooking and frying in the home. It is not designed for commercial or industrial purposes.
- Do not use the hob to heat the room.
- Take care when plugging in electric appliances near the hob. Connection leads must not come into contact with the hot surface.
- Overheated fats and oils catch fire quickly. You should supervise cooking when preparing foods in fat or oil.
- Switch off the cooking zones after use.
- Always keep the control panels clean and dry.
- Never place combustible items on the hob.
- You must not keep any combustible items aerosol cans in a drawer located under the hob.
- The service cables from electrical appliances must not touch the hot plates. This could cause damage to the hob and cable insulation.

# Safety

---

## Safety When Cleaning

- Always switch off the appliance before cleaning.
- For safety reasons do not clean the appliance with a steam jet or high pressure cleaner.
- Clean the hob in accordance with the maintenance and cleaning instructions in this manual.
- Do not use harsh abrasive cleaners or sharp metal scrapers to clean the oven door glass since they can scratch the surface, which may result in shattering of the glass.

## How to avoid damage to the appliance

- Do not use the cooking area as a worktop or storage space.
- Please be careful the edges when moving pots and pans around.
- Do not have the cooking zones on with empty pans, or with no pots or pans on them.
- Ceramic glass is very tough, and impervious to sharp temperature changes, but is not unbreakable. It can be damaged if particularly hard or sharp objects fall on to it.
- Be very cautious if using pots made of cast iron, or other pots with rough edges or burrs. Moving these can cause scratches on glass.
- If sugar or a mixture containing sugar falls onto a hot cooking zone and melts, remove immediately, while still hot. If left to cool down, it may damage the surface when removed.



**Important:** There is a risk of burning yourself when the glass scraper is used on a hot cooking zone!

- Keep objects or materials liable to melt away from the ceramic glass surface, for example, plastic utensils, aluminium foil, or cooking wraps. If any other materials or foodstuffs have melted on the ceramic glass surface, these should also be cleaned away immediately.

---

## Disposal of old appliances



**Warning:** Before disposing of old appliances please make them inoperable so that they cannot be the source of danger.

**To do this, have a qualified person disconnect the appliance from the house circuitry.**

To protect the environment, it is important that worn out appliances are disposed of in the correct manner.

- The appliance must not be disposed of with household rubbish.
- You can obtain information about collection dates or public refuse disposal sites from your local Council or Environmental Health Office.

**Note:** Moisture coming from or appearing around Hob.

The moisture could be coming from the wood and hob when the hob is operated initially or after long time of no operation.

This is not a fault with the Hob.

# Suitable Kitchenware

---

## Pots and pans

The better the pot, the better the cooking results.

- You can recognize good pots and pans by their bases. The base should be as thick and flat as possible.

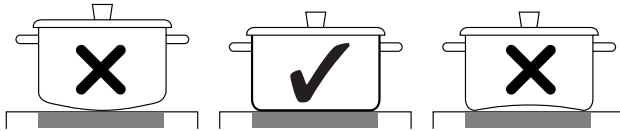

- When buying new pots and pans, pay particular attention to the diameter of the base. Manufacturers often only state the diameter of the rim.
- Pots with aluminum, or copper bases can cause metallic discolouring on the ceramic glass surface which is very difficult or impossible to remove.
- Be very careful when using cast iron pots or pots with damaged bases which are rough and or have burrs on them. Scratches can occur if they are slid across the surface.
- When cold, pot bases are normally bowed slightly inwards (concave). They should never be bowed outwards (convex).
- If you use special pots and pans (e.g., a pressure cooker, simmering pan, wok etc.) please observe the manufacturer's instructions.

## General information

- The base should always be clean and dry.
- In order to avoid ugly scratches on the ceramic glass cooking surface, do not slide pots and pans around but lift them up instead when changing positions.
- Scratches can result from grains of sand (e.g., after washing out vegetables) which are dragged with the pot across the cooking surface.
- Always use large pots for dishes with lots of liquid so that nothing can boil over.



---

## Tips on saving energy

You will save valuable energy by observing the following points:

- Always position pots and pans before you switch on the cooking zone.
- Dirty cooking zones and pot bases increase the power consumption.
- Whenever possible, always have the lid firmly placed on the pots and pans so that they are completely covered.

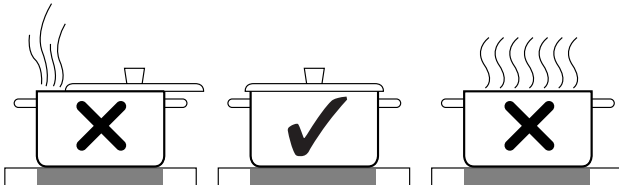

- Switch off the cooking zones before the end of the cooking time to use the residual heat for keeping food warm or for melting purposes.
- The base of the pot should have the same size as the cooking zone.

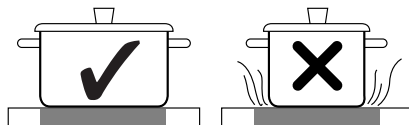

- Using a pressure cooker shortens the cooking times by up to 50%.

# Description of the Appliance

## Cooking zones and control

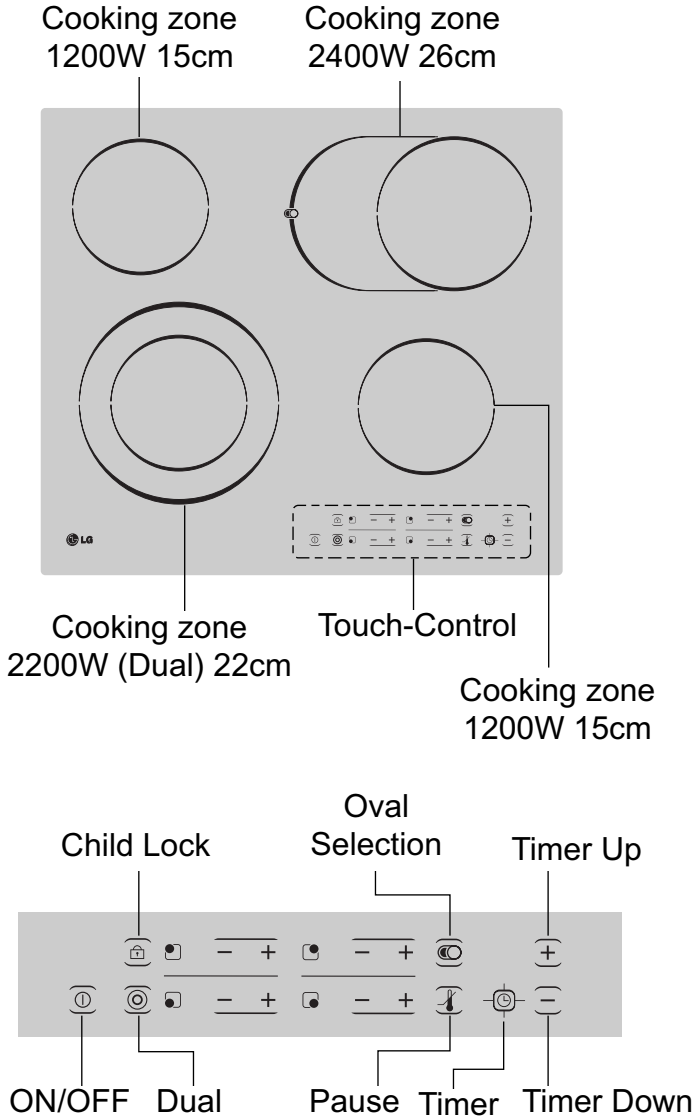

# The Key Features of Your Appliance

---

- **Cooking zones:** The appliance is fitted with ceramic glass.
- **Touch Control:** Your appliance is operated using Touch-Control.
- **Easy cleaning:** The advantage of the ceramic glass cooking surface and touch control is their accessibility for cleaning. The flat surface is easy to clean.
- **Control and function indicators:** Digital indicators provide information about settings made, functions activated, as well as any residual heat of the corresponding cooking zone.
- **Safety cut-out:** A safety cut-out ensures that all cooking zones switch off if On/Off key is pressed, but no power levels selected within 10 seconds.
- **On/Off:** Switches power on and off with one touch.
- **Child lock:** With this key the control can be locked as a safety precaution for children. When you touch this key one more time, Child Lock will be released. Key must be pressed for 3 sec. to lock.
- **Dual key:** With this key one of the other heater can be selected.
- **Pause:** switches all burners to low power level with this key.
- **Residual heat indicator:** An **H** for residual heat is shown in the display if the cooking zone becomes so hot that there is a risk of burning. As the burner cools down further, the display changes to **h**. The display remains lit until the burner cooles sufficiently.
- **Timer:** All burners can be automatically switched off using the integrated timer. When the end of the cooking time has been reached, the cooking zone switches off.
- **Up(+)** / **Down(-):** Adjusting the Heat setting and Timer setting with these keys.

# Operating Instructions

## Before using for the first time

### Initial Cleaning

Wipe the ceramic glass surface with a damp cloth and ceramic cooktop glass cleaner.

**!** **Important:** Do not use any caustic, abrasive cleaners!  
The surface could be damaged.

## Operating the hob

### Touch Control Keys

To operate a Touch Key, simply place your finger firmly on key.

### Switching on the Appliance

The entire appliance is switched on using the “On/Off” (  ) key. Touch the “On/Off” key for approx. one second.

This display will show  .

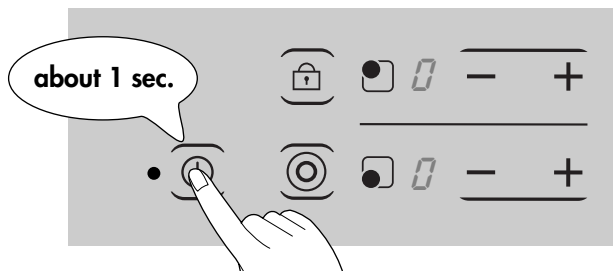

The digital display will show  and the indicator next to ON/OFF will light up.

**Tip** Once the “On/Off” key has been pressed to switch on the appliance, one of the cooking zones must be selected within approx 10 seconds using the cooking zone selection keys. Otherwise the appliance switches off again for safety.

**Tip** When an individual cooking zone or the entire hob is switched off, any residual heat is shown with an **H** or **h** in the display for the appropriate cooking zones.

## Cooking zone selection

For setting and adjusting the power level ( **1** to **9** ) for cooking, touch the relative cooking zone **+**, **-** key.

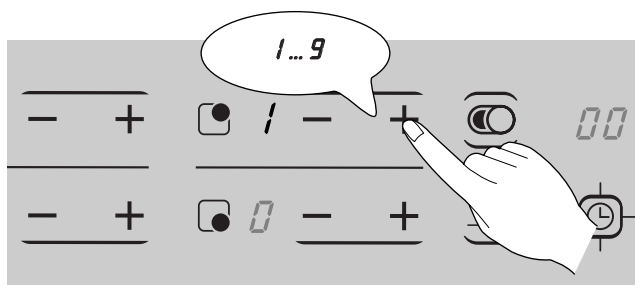

## Heat Level Setting

To select the required cooking zone and set the heat level, touch the corresponding burner's **+**, **-** key.

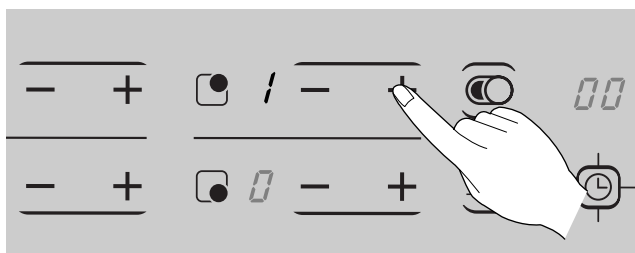

Use **+** key to increase the heat power level and **-** key to decrease.

**Tip** When you touch **-** back to zero, the burners are turned off.

# Operating Instructions

---

1. To set quickly when the power level “0” is displayed.  
Touch the **+** or **-** key.  
The first time **-** is pressed, the heat level is set to **9**.  
The first time **+** is pressed, the heat level is set to **1**.  
If power level is on **9** and it is desired to turn off burner, the **+** key can be pressed one additional time, and the heating level will be **0**.
2. For a faster adjustment, touch one of the **+** or **-** key for such time until the required value is obtained.
3. To protect the user.  
If one key is pressed for longer than 9 seconds, **EI** will show in the timer display. To eliminate **EI**, press On/Off key. This does not relate to the timer key.



## Dual Selection

Set the desired power level of the left front burner.

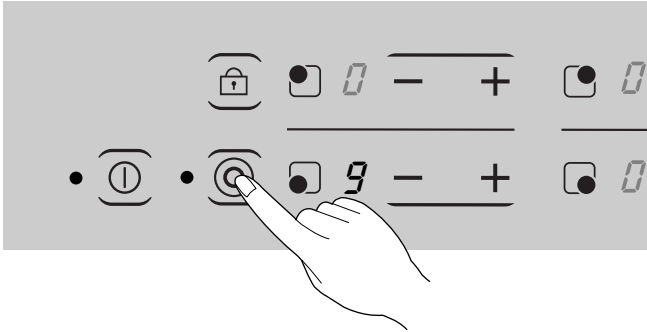
To switch on other heater of the left front(Dual) one, touch the  key.



**Tip** The last setting for the single burner will be restored automatically when you switch off the dual selection.

If both portions of the burner are on, the heat level for the entire burner is controlled by  and .

**Tip** The Dual can be switched off in the following way:

- Touching the “Dual selection” key .

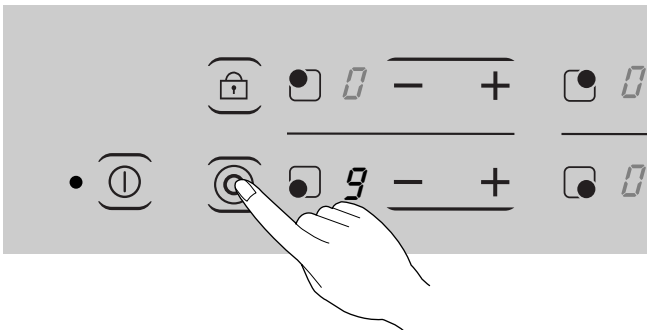

# Operating Instructions

## Child Lock

With this key the control can be locked, as a safety precaution for children. Touch this key one more time, Child Lock will be released.

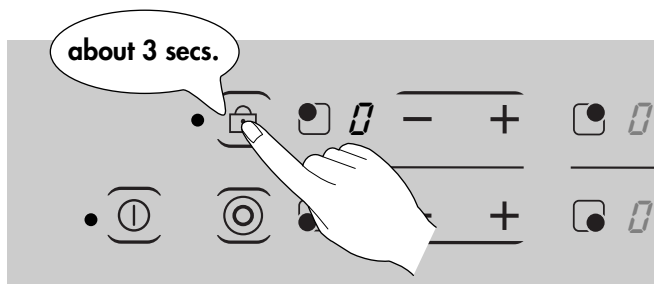

## Oval Selection

With this key the left position of the Right Rear Cooking Zone is switched on. If both portions of the burner are on, the heat level for the entire burner is controlled by **+** and **-**. The last setting for the single burner will be restored automatically when you switch off the oval selection.

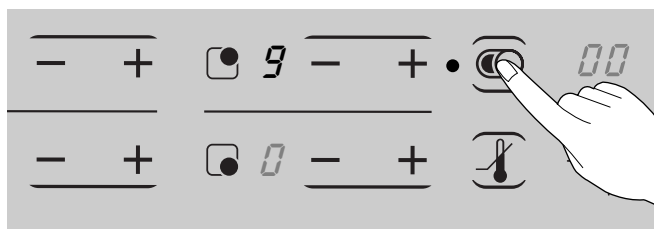





## Timer

A cooking duration can be set with the integrated timer for all cooking zones. When the end of the cooking duration is reached, the cooking zone switches off automatically.

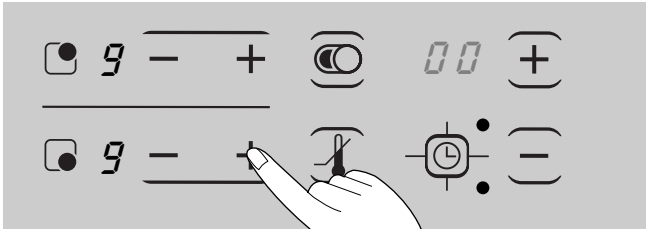
1. Using the cooking zone key, select the required cooking zone and set the required heat level.



2. Touch the  (TIMER) key to activate the timer function for this cooking zone. 00 will appear in the display.

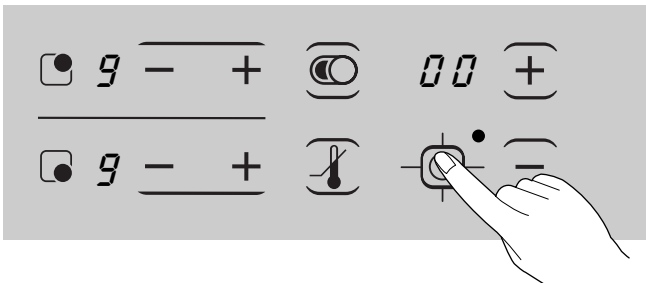

**Tip** The selected burner side LED around the timer key will be lit up and flash.

# Operating Instructions

3. Using the  $\oplus$  or  $\ominus$  key set or adjust the required period of time (eg. 30 minutes).

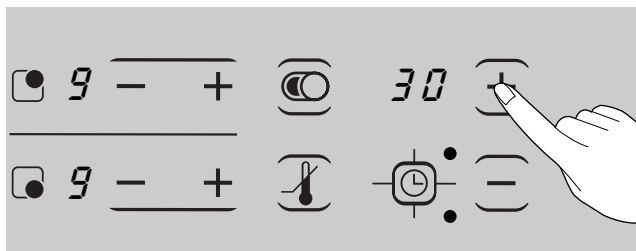

After a few seconds the timer will start automatically and will show how much time remains before it will switch off.

At the end of the set cooking time, the cooking zone will switch off automatically and a signal will sound.

- Tip** To set the timer more quickly, leave your finger on the  $\oplus$  or  $\ominus$  key until the required time is reached.  
If the  $\ominus$  key is operated at first, the time setting will begin at 99 minutes; if the  $\oplus$  key is operated at first, the time setting will begin at 30 minutes.  
If you keep touching  $\oplus$  or  $\ominus$  key, the time setting increases or decreases.

## Displaying the remaining cooking time

If you touch the timer key one more time remaining cooking time of the selected cooking zone appears in the timer display window.

# Pause

Selecting the Pause Key lowers each active burner to low setting. When pause is deactivated each burner returns to it's original setting.

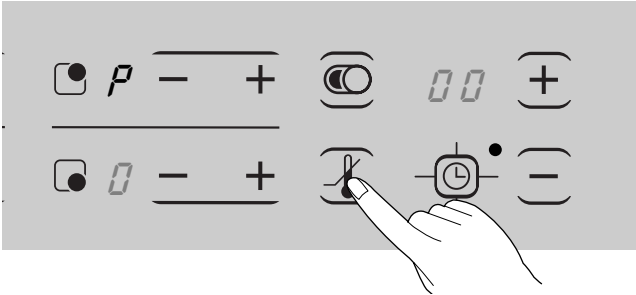

# Uses, Tables and Tips

## Chart for Setting the Cooking Zones

Heat setting		suitable for
9	Heating Up	Bringing liquid to a boil.
7-9	Heavy Browning Deep fat frying	Browning meat, heat oil for deep fat frying or sauteing. Maintaining fast boil for large amounts of liquids.
6-7	Baking Frying	Frying meat, schnitzel, cordon bleu, chops, pancakes, rissoles, roux, mild roasting, fried sausages, liver, eggs.
4-5	Boil	Cooking larger quantities of food, stews and soups, steaming potatoes, cooking meat stock or bouillon
3-4	Steaming	Steaming vegetables or braising meat, cooking rice pudding
2-3	Simmering	Simmering rice or milk-based dishes, steaming smaller quantities of potatoes or vegetables, heating up ready-to-serve meals.
1-2	Melting	Fluffy omelettes, egg royale, Sauce hollandaise, keeping dishes warm, melting butter, chocolate, honey gelatin
0		Off setting

### Note:

The heat setting indicated in the table above is only guidelines for your reference. You need to adjust the heat settings to the pan and food conditions.

# Automatic time limiter

---

If a element is in constant use for a long time without the setting being changed, the automatic time limiter is activated.

Then, power level is set **0** automatically.

Touching **+** or **-** will reset the burner. The following table shows the automatic limiter activation times.

## \* Radiant (Hi Light Heater)

Heat setting	1	2	3	4	5	6	7	8	9
max	6h		5h		4h	1.5h			

## \* Automatic power level control

The power level displayed can be different from the actual power level at the high temperature range.

To prevent the Hob over heating, the power level is controlled automatically.

# Cleaning and care

---

## Light Soiling

1. Wipe the ceramic glass surface with a damp cloth and a little cooktop cleaner.
2. Then rub dry with a clean cloth. Remnants of cleaner must not be left on the surface.
3. Thoroughly clean the entire ceramic glass cooking surface once a week with a commercially available ceramic glass or stainless steel cleaner.
4. Then wipe the ceramic glass surface using plenty of clean water and rub dry with a clean fluff-free cloth.

## Stubborn Soiling

1. To remove food that has boiled over or stubborn splashes, use a glass scraper.
2. Place the glass scraper at an angle to the ceramic glass surface.
3. Remove soiling by sliding the blade across the area.

**Tip** You can obtain glass scrapers and ceramic glass cleaners which are suitable for glass ceramic, e.g. CERA CLEAN, cerafix, sidol for ceran+steel, from your local Hardware Centre.

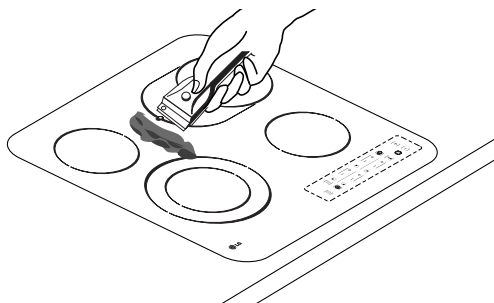

## **Problem Soils**

1. Remove sugar, melted plastic, aluminium foil or other meltable materials with a glass scraper immediately and while still hot.

 **Important:** There is a risk of burning yourself when the glass scraper is used on a hot cooking zone!

2. Then clean the hob normally when it has cooled down.

 **Tip** If the cooking zone on which something has melted has already cooled down, warm it up again for cleaning.

Scratches or dark marks on the ceramic glass surface, caused by a pan base with sharp edges, cannot be removed. However, they do not impair the function of the hob.

 Since the heat is generated in the pan, food or foodstuffs possibly on the glass ceramic surface are not burned in as badly.

 **Important:** Cleaning agents must not come into contact with the hot ceramic glass surface! All cleaning agents must be removed with plenty of clean water after cleaning because they can have a caustic effect when the rings are next heated! Do not use any aggressive cleaners such as grill or oven sprays, coarse scourers or abrasive pan cleaners.

 **Tip** Clean the ceramic glass surface after each use when it is warm to the touch or cold. This will avoid spillages becoming burned on. **Remove scale and water marks, fat spots and discolouration with a metallic shimmer** using a commercially available ceramic glass or stainless steel cleaner.

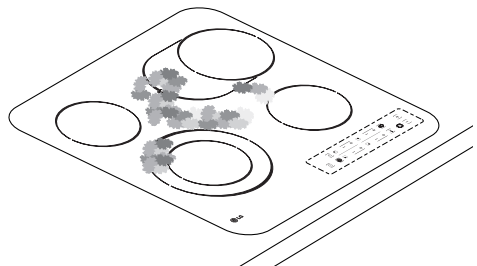

# Installation Instructions

---

## Technical Data

 **Important!** The new appliance may only be installed and connected by a **registered specialist**.

Please observe these instructions, otherwise the warranty will not cover any damage that may occur.

### Appliance dimensions

Width	575mm
Depth	515mm
Height	40mm

### Worktop cut-out dimensions

Width	560mm
Depth	500mm
Corner radius	5mm

### Cooking rings

Position	Diameter	Power
Front left	220mm	2200W
Rear left	150mm	1200W
Rear right	260mm	2400W
Front right	150mm	1200W

**Connection voltage** 220~240V 1AC/2NAC  
50Hz/60Hz

**Maximum connected load power** 7.0kW



---

## Regulations, Standards, Directives

This appliance meets the following standards:

- EN 60335-1 and EN 60335-2-6  
relating to the safety of electrical appliances for household use and similar purposes and
- EN 60350  
Methods for measuring performance.
- EN 55014-2
- EN 55014-1
- EN 61000-3-2
- EN 61000-3-3  
relating to basic requirements for electro-magnetic compatibility protection (EMC)

This appliance complies with the following EU Directives:

-  73/23/EEG dated 19.02.1973 (Low Voltage Directive)
- 89/336/EEG dated 03.05.1989 (EMC Directive including Amending Directive 92/31/EEG).
- 93/68/EEG CE Labelling Directive

# ***Installation Instructions***

---

## **Safety Instructions for the Installer**

- A device must be provided in the electrical installation which allows the appliance to be disconnected from the mains at all poles with a contact opening width of at least 3 mm Suitable isolation devices include line protecting cut-outs, fuses (screw type fuses are to be removed from the holder), earth leakage trips and contactors.



- In respect of fire protection, this appliance corresponds to type Y (EN 60335-2-6). Only this type of appliance may be installed with a high cupboard or wall on one side.
- Drawers may not be fitted underneath the hob.
- The installation must guarantee shock protection.
- The kitchen unit in which the appliance is fitted must satisfy the stability requirements of DIN 68930.
- For protection against moisture, all cut surfaces are to be sealed with a suitable sealant.
- On tiled work surfaces, the joints in the area where the hob sits must be completely filled with grout.
- On natural, artificial stone, or ceramic tops, the snap action springs must be bonded in place with a suitable artificial resin or mixed adhesive.
- Ensure that the seal is correctly seated against the work surface without any gaps. Additional silicon sealant must not be applied; this would make removal more difficult when servicing.
- The hob must be pressed out from below when removed.
- Clean the work surface in the area of the cut-out.
- Sealing tape is mounted on the ceramic Glass initially.

---

## Electrical Connection

Before connecting, check that the nominal voltage of the appliance, that is the voltage stated on the rating plate, corresponds to the available supply voltage. The rating plate is located on the lower casing of the hob.

 Shut off power to circuit before connecting hob wires to circuit.

The heating element voltage is AC230V~. The appliance also works perfectly with AC220V~ and AC 240V~.

The hob is to be connected to the mains using a device that allows the appliance to be disconnected from the mains at all poles with a contact opening width of at least 3 mm, eg. automatic line protecting cut-out, earth leakage E.L.C.B..

A type H05SS-F (180°C) cable or one with a higher grade must be used as the mains connecting cable.

The connection must be carried out as shown in the diagram. The connecting links should be fitted according to the appropriate connection diagram. The earth lead is connected to terminal . The earth lead must be longer than leads carrying electric current.

**The cable connections must be made in accordance with regulations and the terminal screws tightened securely.**

Finally, the connecting cable is to be secured with the mains cable cleat and the covering closed by pressing firmly (lock into place).

Before switching on for the first time, any protective foil or stickers must be removed from the glass ceramic surface.

 Once connected to the mains supply check that all cooking zones are ready for use by briefly switching each on in turn at the maximum setting.

 When hob is initially powered, the displays will show flashing H. This will also occur upon power outage.

# Installation Instructions

- For three phase (Using two phase)

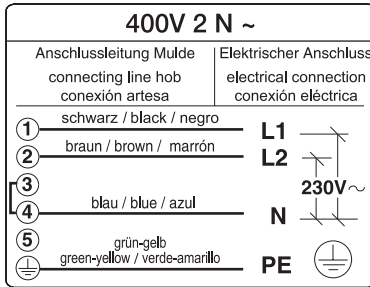

- For single phase

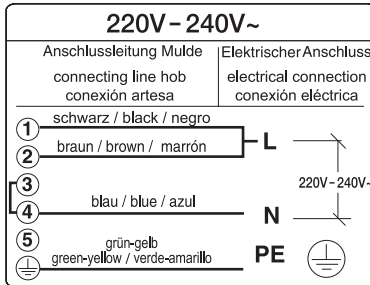

<Fig. 1>

**Warning:** Pay attention (conformity) to phase and neutral allocation of house connection and appliance (connection scheme), otherwise components can be damaged.

No guarantee claims for disfunctional unit through improper installation will be accepted.

**Warning:** The junction box should comply with the electrical spec and endurance temp for HOB.

Furthermore, it should be certified.

# Assembly

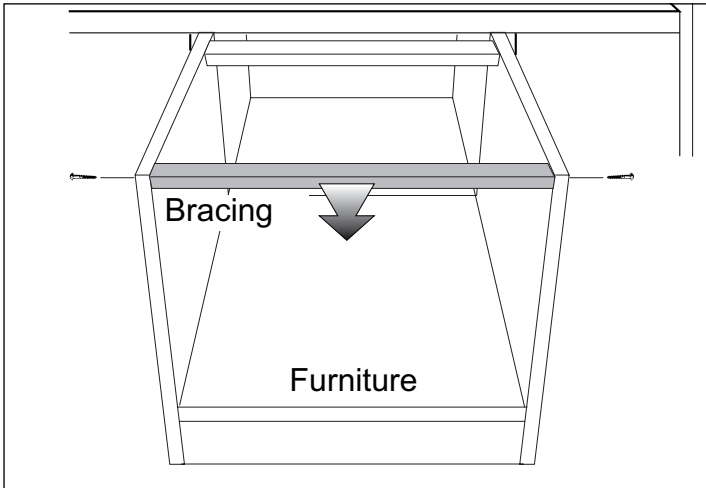

<Fig. 2>

Remove the bracing from the furniture for hob airflow.

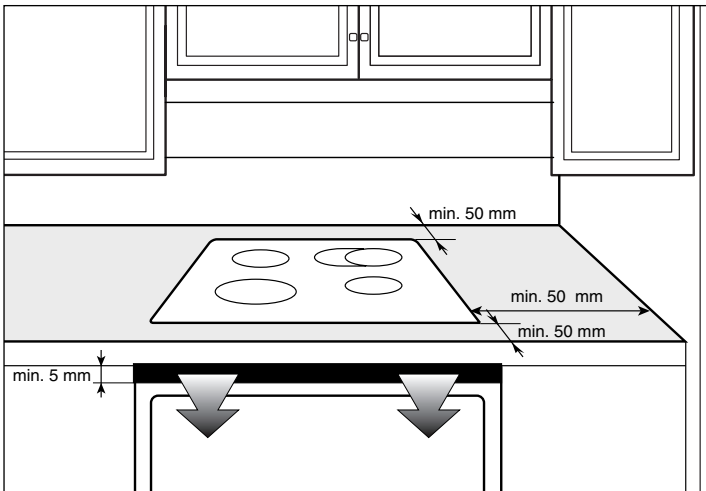

<Fig. 3>

Follow Fig.3 for minimum required surface clearances.

# Installation Instructions

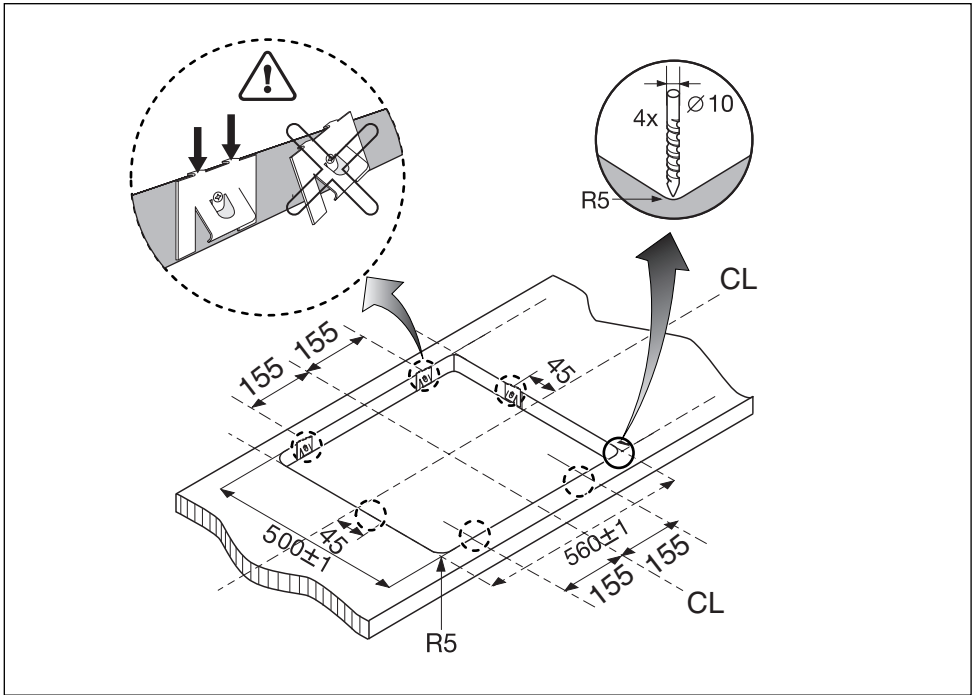

<Fig. 4>

Cabinet cutout and mounting clip locations.

The board is to be installed underneath the hob.

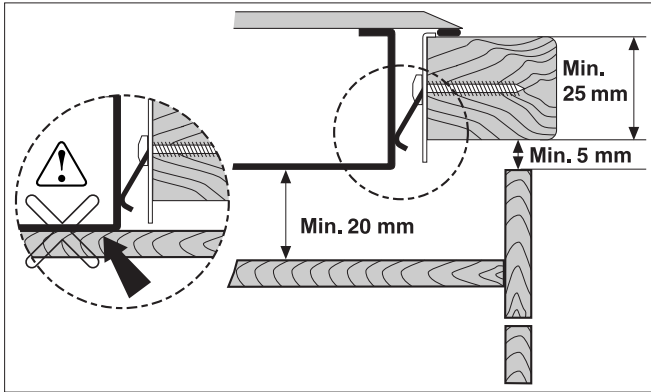

<Fig. 5>

Hob into cutout as shown in Fig. 5.

**Caution:** It is very important to keep 20 mm distance between hob case and combustable surface.

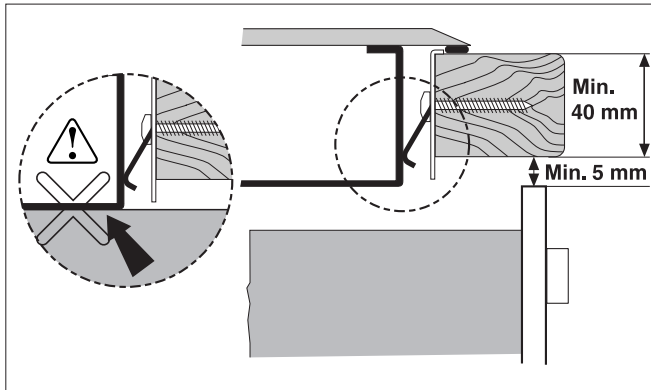

<Fig. 6>

Make sure hob is fully seated, with foam tape compressed against countertop.

# Installation Instructions

---

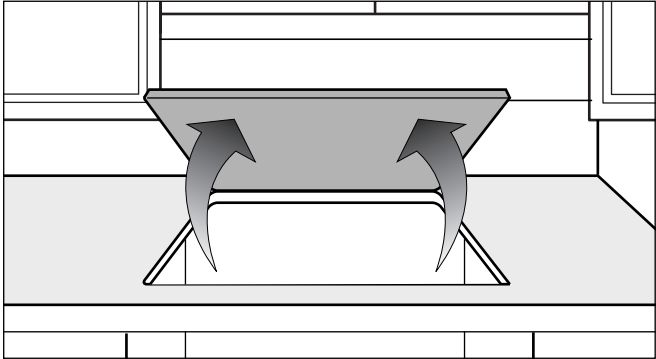

<Fig. 7>

To remove the hob, it must be pressed out from below.



# Troubleshooting

---

Malfunctions often have simple explanations. Please read the following instructions before calling the after-sales service:

Problem description	Possible cause or Remedies
Hob does not work.	<ul style="list-style-type: none"><li>– Connection and Main Switch.</li><li>– The corresponding cooking zone is selected.</li><li>– The desired heat setting is selected.</li></ul>
The cooking zone cannot be switched on.	<ul style="list-style-type: none"><li>• Check below.<ul style="list-style-type: none"><li>– Unlocking state</li><li>– The touch keys are partially covered by a damp cloth or liquid.</li><li>– <b>EI</b> display</li></ul></li><li>See the <b>EI</b> display menu.</li></ul>
Hob does not work properly in Induction.	<ul style="list-style-type: none"><li>• If your hob is placed above your oven thermal protectors prevent it being used when the oven is being pyro-cleaned.</li></ul>
Improper working of control	<ul style="list-style-type: none"><li>• Please check unwanted things is on the control part.</li></ul>

# Troubleshooting

Problem description	Possible cause or Remedies								
Indicator shows <b>E</b>	<ul style="list-style-type: none"> <li>• Check that the household fuses for the appliance are OK. Check if there has been a power outage.</li> </ul> <p>The control panel is very dirty, food has spilled over or there is an object on the control panel. Wipe the control panels thoroughly or remove the object. Touch the appropriate control panel. The flashing stops.</p> <table border="1" data-bbox="417 595 1042 1345"> <thead> <tr> <th data-bbox="417 595 549 638">Display</th> <th data-bbox="549 595 706 638">Fault</th> <th data-bbox="706 595 1042 638">Action</th> </tr> </thead> <tbody> <tr> <td data-bbox="417 638 549 1345"><i>E1</i></td> <td data-bbox="549 638 706 1345">Touch time is too long.</td> <td data-bbox="706 638 1042 1345">If any one of the keys (except relating to the timer) is touched for more than 9 seconds continuously this message will be displayed. And if water or a metal substance is placed on the key, it will also be displayed. This prevents unwanted operation by the water, etc. To eliminate <b>E1</b>, press on/off key and remove water, metal substance and etc.</td> </tr> </tbody> </table>			Display	Fault	Action	<i>E1</i>	Touch time is too long.	If any one of the keys (except relating to the timer) is touched for more than 9 seconds continuously this message will be displayed. And if water or a metal substance is placed on the key, it will also be displayed. This prevents unwanted operation by the water, etc. To eliminate <b>E1</b> , press on/off key and remove water, metal substance and etc.
Display	Fault	Action							
<i>E1</i>	Touch time is too long.	If any one of the keys (except relating to the timer) is touched for more than 9 seconds continuously this message will be displayed. And if water or a metal substance is placed on the key, it will also be displayed. This prevents unwanted operation by the water, etc. To eliminate <b>E1</b> , press on/off key and remove water, metal substance and etc.							

Problem description	Possible cause or Remedies
Indicator shows <b>F</b>	<ul style="list-style-type: none"> <li>• <b>F</b> display and numbers If an <b>F</b> and numbers appear in the display panels, there is a fault with the electronics. Switch the Hob off and back on again using the household fuse or the circuit breaker in the fuse box. Call the after-sales service if the display appears again.</li> </ul>
Flashing <b>H</b>	<ul style="list-style-type: none"> <li>• When initially powered up or after power outage. Touch the on/off key to fix. <b>H</b> will flash for 90 minutes.</li> </ul>
Burner not glowing red	<ul style="list-style-type: none"> <li>• The hotplate temperature is controlled by switching the heat on and off, this means that it is not always possible to see the red, glowing heat. If you select a low heat setting, the heat will switch off more often than at higher heat settings. The heat also switches on and off at the highest setting.</li> </ul>

### Repairs

Repairs may only be carried out by service technicians.

# Service

---

## Packaging and old appliances

Your new appliance was protected by suitable packaging while it was on its way to you. All materials used for this purpose are environmentally friendly and can be recycled. Please make a contribution to protecting the environment by disposing of the packaging appropriately.

Old appliances are not worthless rubbish.

Environmentally conscious recycling can reclaim valuable raw materials.

Before disposing of your old appliance, please make sure that it is unusable, or label it with a sticker stating "Caution, scrap".

Up-to-date information on how to dispose of your old appliance and the packaging from the new one can be obtained from your retailer or local authority.

### Contact Service center

Please quote the model name of your appliance when contacting the service center. The name plate can be found under the appliance. When you contact us we need to know.

- Your name
- Address and post code
- Telephone number
- Clear and concise details of the fault
- Model No. and serial No.

# ***Memo***

---

# **Memo**

---



FOR WARRANTY SERVICE PLEASE CONTACT THE RETAILER FROM WHOM  
YOU PURCHASED YOUR UNIT OR CONTACT LG SERVICE



LG ELECTRONICS S.A.(Pty) Ltd.  
P.O.BOX 473  
ISANDO  
1600

LG Service center  
Phone: 0800-LGLGLG (0800-545454)

<http://www.lge.co.za>



 **LG Electronics Inc.**

**220V-240V 1AC/2NAC 50/60Hz**  
**Model : KA60510 / KA60520**  
**Made In Korea**

**Max. 7.0kW**

**P/no.:3828W5A8195**