



MICROWAVE/GRILL/COMBINATION OVEN

OWNER'S MANUAL

PLEASE READ THIS OWNER'S MANUAL THOROUGHLY BEFORE OPERATING.

MH7046S

Precautions

Precautions to avoid possible exposure to excessive microwave energy.

You cannot operate your oven with the door open due to the safety interlocks built into the door mechanism. These safety interlocks automatically switch off any cooking activity when the door is opened; which in the case of a microwave oven could result in harmful exposure to microwave energy. **It is important not to tamper with the safety interlocks.**

Do not place any object between the oven front face and the door or allow food or cleaner residue to accumulate on sealing surfaces.

Do not operate your oven if it is damaged. It is particularly important that the oven door closes properly and that there is no damage to the: (1) door(bent), (2) hinges and latches (broken or loosened), (3) door seals and sealing surfaces.

Your oven should not be adjusted or repaired by anyone except qualified service personnel.

Warning

Please ensure cooking times are correctly set as over cooking may result in the FOOD catching fire and subsequent damage to your oven.

When heating liquids, e.g. soups, sauces and beverages in your microwave oven, overheating the liquid beyond boiling point can occur without evidence of bubbling. This could result in a sudden boil over of the hot liquid. To prevent this possibility the following steps should be taken:

- 1 Avoid using straight sided containers with narrow necks.
- 2 Do not overheat.
- 3 Stir the liquid before placing the container in the oven and again halfway through the heating time.
- 4 After heating, allow to stand in the oven for a short time, stir or shake them again carefully and check the temperature of them before consumption to avoid burns (especially, contents of feeding bottles and baby food jars).
Be careful when handling the container.

Warning

Always allow food to stand after being cooked by microwaves and check the temperature of them before consumption. Especially contents of feeding bottles and baby food jars.

How the Microwave Oven Works

Microwaves are a form of energy similar to radio and television waves and ordinary daylight. Normally, microwaves spread outwards as they travel through the atmosphere and disappear without effect. Microwave ovens, however, have a magnetron which is designed to make use of the energy in microwaves. Electricity, supplied to the magnetron tube, is used to create microwave energy.

These microwaves enter the cooking area through openings inside the oven. A turntable or tray is located at the bottom of the oven. Microwaves cannot pass through metal walls of the oven, but they can penetrate such materials as glass, porcelain and paper, the materials out of which microwave-safe cooking dishes are constructed.

Microwaves do not heat cookware, though cooking vessels will eventually get hot from the heat generated by the food.

A very safe appliance

Your microwave oven is one of the safest of all home appliances. When the door is opened, the oven automatically stops producing microwaves. Microwave energy is converted completely to heat when it enters food, leaving no "left over" energy to harm you when you eat your food.

Precautions	2
Contents	3
Unpacking & Installing	4 ~ 5
Setting the Clock	6
Child Lock	7
Micro Power Cooking	8
Micro Power Level	9
Two Stage Cooking	10
Quick Start	11
Grill Cooking	12
Combination Cooking	13
Auto Cook	14 ~ 15
Auto Defrost	16 ~ 17
Quick Defrost	18 ~ 19
Timer	20
More or Less Cooking	21
Heating or Reheating Guide	22
Fresh Vegetable Guide	23
Grill Cooking Guide	24
Important Safety Instructions	25
Microwave - safe Utensils	26
Food characteristics & Microwave cooking	27 ~ 28
Questions & Answers	29
Plug Wiring Information/Technical Specifications	30

Unpacking & Installing

By following the basic steps on these two pages you will be able to quickly check that your oven is operating correctly. Please pay particular attention to the guidance on where to install your oven. When unpacking your oven make sure you remove all accessories and packing. Check to make sure that your oven has not been damaged during delivery.

- 1** Unpack your oven and place it on a flat level surface.

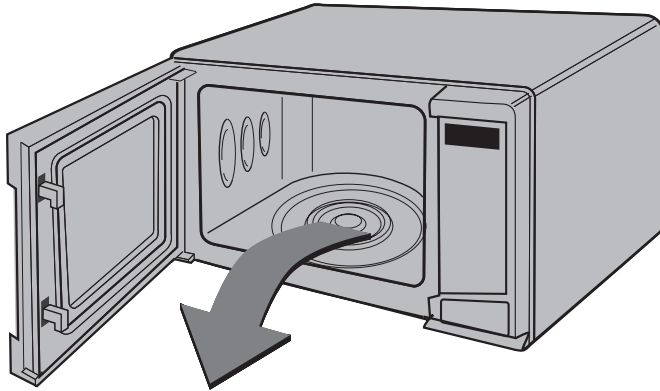

GLASS TRAY

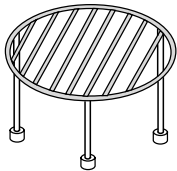

HIGH RACK

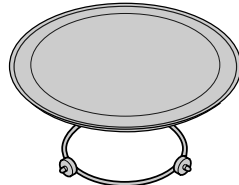

ROTATING RING

- 2** Place the oven in the level location of your choice with more than 85cm height but make sure there is at least 20cm of space on the top and 10cm at the rear for proper ventilation. The front of the oven should be at least 8cm from the edge of the surface to prevent tipping. An exhaust outlet is located on top or side of the oven. Blocking the outlet can damage the oven.

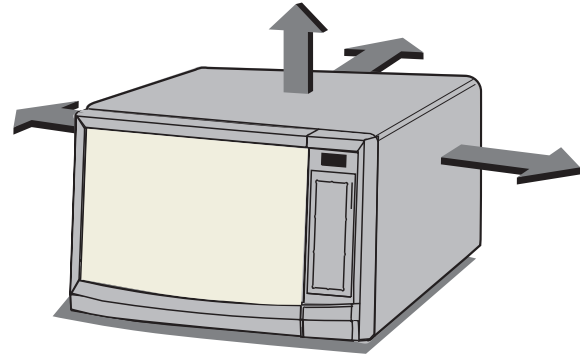

THIS OVEN SHOULD NOT BE USED FOR COMMERCIAL CATERING PURPOSES

3 Plug your oven into a standard household socket. Make sure your oven is the only appliance connected to the socket. If your oven does not operate properly, unplug it from the electrical socket and then plug it back in.

4 Open your oven door by pushing the Release Button. Place the ROTATING RING inside the oven and place the GLASS TRAY on top.

5 Fill a microwave safe container with 300 ml (1/2 pint) of water. Place on the GLASS TRAY and close the oven door. If you have any doubts about what type of container to use please refer to page 26.

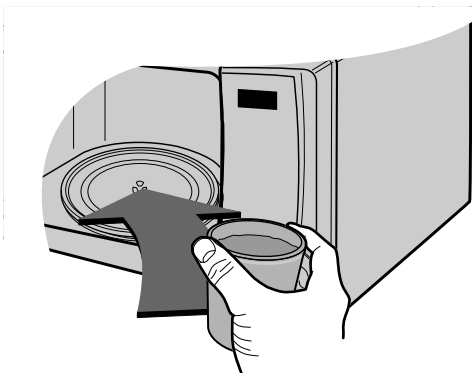

6 Press the START button once to set 30 seconds of cooking time. You will hear a BEEP each time you press the button.



7 The DISPLAY will count down from 30 seconds. When it reaches 0 it will sound BEEPS. Open the oven door and test the temperature of the water. If your oven is operating the water should be warm. Be careful when removing the container it may be hot.



YOUR OVEN IS NOW INSTALLED

Setting the Clock

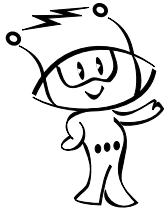

When your oven is plugged in for the first time or when power resumes after a power cut, a '0' will be shown in the display; you will have to reset the clock.

If the clock (or display) shows any strange looking symbols, unplug your oven from the electrical socket and plug it back in and reset the clock.

You can set either 12 hour clock or 24 hour clock.
In the following example I will show you how to set the time for 14:35 when using the 24 clock.
Make sure that you have removed all packaging from your oven.

Make sure that you have correctly installed your oven as described earlier in this book.

Press **STOP/CLEAR**.



Press **SET CLOCK** once.

(If you want to use a 12 hour clock, Press **SET CLOCK** once more.
If you want to change different option after setting clock, you have to unplug and plug it back in.)

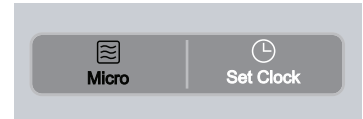

Press **10 MIN** fifteen times.
Press **1 MIN** three times.
Press **10 SEC** five times.

If the key (10 MIN / 1 MIN / 10 SEC) is pressed and held, the time will increase rapidly.



Press **SET CLOCK** to set the time.

The clock starts counting.



Child Lock



Your oven has a safety feature that prevents accidental running of the oven. Once the child lock is set, you will be unable to use any functions and no cooking can take place. However your child can still open the oven door!

Press STOP/CLEAR.



Press and hold STOP/CLEAR until "L" appears on the display and BEEP sounds.

The CHILD LOCK is now set.

The time will disappear on the display if you have set the clock.

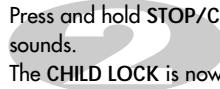

"L" remains on the display to let you know that CHILD LOCK is set.



To cancel CHILD LOCK press and hold STOP/CLEAR until "L" disappears. You will hear BEEP when it's released.

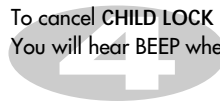

Micro Power Cooking

In the following example I will show you how to cook some food on 80% power for 5 minutes and 30 seconds.



Your oven has five microwave Power settings. High power is automatically selected but repeated presses of the MICRO key will select a different power level.

POWER	Press MICRO	%	Power Output
HIGH MAX	1 time	100%	900W
MEDIUM HIGH	2 times	80%	720W
MEDIUM	3 times	60%	540W
DEFROST MEDIUM LOW	4 times	40%	360W
LOW	5 times	20%	180W

Make sure that you have correctly installed your oven as described earlier in this book.

Press **STOP/CLEAR**.



Press **MICRO** twice to select 80%(720W) power.



Press **1 MIN** five times.
Press **10 SEC** three times.



Press **START**.



Micro Power Level

Your microwave oven is equipped with 5 power levels to give you maximum flexibility and control over cooking. The table below shows the examples of food and their recommended cooking power levels for use with this microwave oven.

POWER LEVEL	USE	POWER LEVEL (%)	POWER OUTPUT
HIGH	<ul style="list-style-type: none"> * Boil Water * Brown minced beef * Cook poultry pieces, fish, vegetables * Cook tender cuts of meat 	100%	900W
MEDIUM HIGH	<ul style="list-style-type: none"> * All reheating * Roast meat and poultry * Cook mushrooms and shellfish * Cook foods containing cheese and eggs 	80%	720W
MEDIUM	<ul style="list-style-type: none"> * Bake cakes and scones * Prepare eggs * Cook custard * Prepare rice, soup 	60%	540W
DEFROST/ MEDIUM LOW	<ul style="list-style-type: none"> * All thawing * Melt butter and chocolate * Cook less tender cuts of meat 	40%	360W
LOW	<ul style="list-style-type: none"> * Soften butter & cheese * Soften ice cream * Raise yeast dough 	20%	180W



Two stage Cooking



During two stage cooking the oven door can be opened and food checked. Close the oven door and press **START** and the cooking stage will continue.

At the end of stage 1, **BEEP** sounds and stage 2 commences.

Should you wish to clear the programme press **STOP/CLEAR** twice.

In the following example I will show you how to cook some food in two stages. The first stages will cook your food for 11 minutes on HIGH; the second will cook for 35 minutes on 360W.

Press **STOP/CLEAR**.



Set the power and the cooking time for stage 1.
(You can omit this process for HIGH power.)
Press **MICRO** once to select HIGH power.

Press **10 MIN** once.

Press **1 MIN** once.



Set the power and the cooking time for stage 2.
Press **MICRO** four times to select 360W power.

Press **10 MIN** three times.

Press **1 MIN** five times.

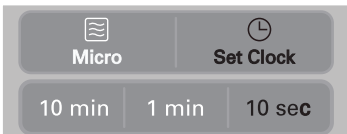

Press **START**.



Quick Start

In the following example I will show you how to set 2 minutes of cooking on high power.



The QUICK START feature allows you to set 30 seconds intervals of HIGH power cooking with a touch of the START key.

Press STOP/CLEAR.



Press START four times to select 2 minutes on HIGH power.
Your oven will start before you have finished the fourth press.



During QUICK START cooking, you can extend the cooking time up to 10 minutes by repeatedly pressing the START key.

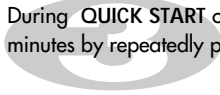

Grill Cooking

In the following example I will show you how to use the grill to cook some food for 12 minutes and 30 seconds.



This model is fitted with a **QUARTZ GRILL**, so preheating is not needed.

This feature will allow you to brown and crisp food quickly.

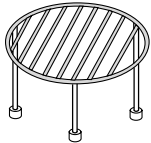

HIGH RACK

Press **STOP/CLEAR**.



Press **GRILL**.

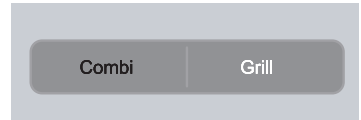

Set the cooking time.



Press **10 MIN** once.
Press **1 MIN** twice.
Press **10 SEC** three times.



Press **START**.



Combination Cooking

In the following example I will show you how to programme your oven with combi mode Co-3 for a cooking time of 25 minutes.



Your oven has a combination cooking feature which allows you to cook food with heater and microwave at the same time or alternately. This generally means it takes less time to cook your food.

The quartz heater grills the surface of the food while microwave heats inside. Moreover, preheating your oven is not necessary.

Press **STOP/CLEAR**.



Press **COMBI** three times.
"Co-3" appears on the display.



Set the cooking time.
Press **10 MIN** two times.
Press **1 MIN** five times.

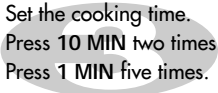

Press **START**.

When cooking you can use **MORE/LESS** key to increase/decrease cooking time.

Be careful when removing your food because the container will be hot!

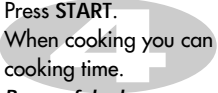

Auto Cook

In the following example I will show you how to cook 0.6kg of fresh vegetable.



AUTO COOK allows you to cook most of your favorite food easily by selecting the food type and entering the weight of the food.

Press STOP/CLEAR .



Press Fresh Vegetable .

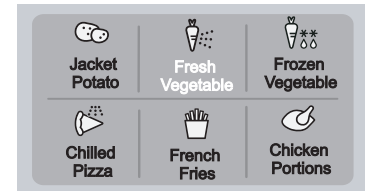

Press MORE four times to enter 0.6 kg.

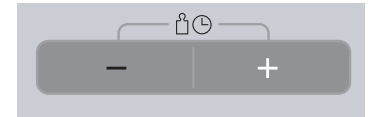

Press START.



FOOD CATEGORY	FOOD TEMP.	UTENSILS	WEIGHT LIMIT	INSTRUCTIONS
1. JACKET POTATO	Room temp.	Glass tray	0.1 kg ~ 1.0 kg	Wash, dry and prick potato with a fork several times. Place the potato with three pieces of paper towel in the centre of the glass tray. After Cooking, stand covered with foil 5 minutes.
2. FRESH VEGETABLE	Room temp.	Microwave-safe bowl	0.2 kg ~ 0.8 kg	Place vegetables in a microwave-safe bowl. Add water. Cover with wrap. After cooking, stir and allow to stand for 2 minutes. Add amount of water according to the quantity. ** 0.2kg - 0.4kg : 2 Tablespoon ** 0.5kg - 0.8kg : 4 Tablespoon
3. FROZEN VEGETABLE	Frozen	Microwave-safe bowl	0.2 kg ~ 0.8 kg	Place vegetables in a microwave-safe bowl. Add water. Cover with wrap. After cooking, stir and allow to stand for 2 minutes. Add amount of water according to the quantity. ** 0.2kg - 0.4kg : 2 Tablespoon ** 0.5kg - 0.8kg : 4 Tablespoon
4. CHILLED PIZZA	Refrigerated	High rack	0.2 kg ~ 0.4 kg	This function is for reheating leftover chilled pizza. Place chilled pizza on the high rack over the glass tray. After cooking, take food out immediately. Stand for 2~3 minutes.
5. FRENCH FRIES	Frozen	High rack	0.2 kg ~ 0.4 kg	Spread frozen potato products out on the heat-proof plate on the high rack over the glass tray. For the best results, cook in a single layer. After cooking, remove from the oven and stand for 1~2 minutes.
6. CHICKEN PORTIONS	Refrigerated	High rack	0.2 kg ~ 0.8 kg	Wash and dry skin. Brush the chicken legs with melted margarine or butter. Place on the high rack over the glass tray. And then put a suitable sized dish to catch the drips under the high rack. When BEEP, turn food over. And then press start to continue cooking. After cooking, stand covered with foil for 2-5 minutes.

Auto Defrost



Your oven has four microwave defrost settings:- **MEAT, POULTRY, FISH and BREAD**; each defrost category has different power settings. Repeated presses of the **AUTO DEFROST** key will select a different setting.

Category	Press	
	AUTO DEFROST	
MEAT	1	time
POULTRY	2	times
FISH	3	times
BREAD	4	times

The temperature and density of food varies, I would recommend that the food is checked before cooking commences. Pay particular attention to large joints of meat and chicken, some foods should not be completely thawed before cooking. For example fish cooks so quickly that it is sometimes better to begin cooking while still slightly frozen. The **BREAD** programme is suitable for defrosting small items such as rolls or a small loaf. These will require a standing time to allow the centre to thaw. In the following example I will show you how to defrost 1.4Kg of frozen poultry.

Press **STOP/CLEAR**.

Weigh the food that you are about to defrost. Be certain to remove any metallic ties or wraps; then place the food in your oven and close the oven door.



Press **AUTO DEFROST** twice to select the **POULTRY** defrosting programme. "dEF2" appears on the display window.

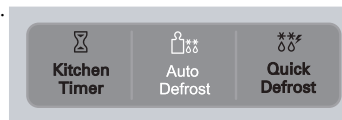

Enter the weight of the frozen food that you are about to defrost.

Press **MORE** fourteen times to enter 1.4 Kg.

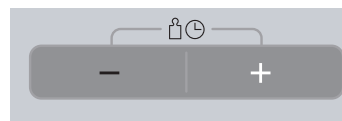

Press **START**.



During defrosting your oven will "BEEP", at which point open the oven door, turn food over and separate to ensure even thawing. Remove any portions that have thawed or shield them to help slow down thawing. After checking close the oven door and press **START** to resume defrosting. Your oven will not stop defrosting (even when the beep sounds) unless the door is opened.

AUTO WEIGHT DEFROST GUIDE

* Food to be defrosted should be in a suitable microwave proof container and place uncovered on the glass turntable.

* If necessary, shield small areas of meat or poultry with flat pieces of aluminum foil. This will prevent thin areas becoming warm during defrosting. Ensure the foil does not touch the oven walls.

* Separate items like minced meat, chops and bacon as soon as possible.

When BEEP, turn food over. Remove defrosted portions. Continue to defrost remaining pieces.

After defrosting, allow to stand until completely thawed.

* For example joints of meat and whole chickens should STAND for a minimum of 1 hour before cooking.

<i>Category</i>	<i>Weight Limit</i>	<i>Utensil</i>	<i>Food</i>
Meat Poultry Fish	0.1 ~ 4.0 kg	Microwave ware (Flat plate)	<p>Meat Minced beef, Fillet steak, Cubes for stew, Sirloin steak, Pot roast, Rump roast, Beef burger Lamp chops, Rolled roast, Cutlets(.2cm)</p> <p>Turn food over at beep. After defrosting, let stand for 5-15 minutes.</p> <p>Poultry Whole chicken, Legs, Breasts, Turkey breasts(under 2.0kg)</p> <p>Turn food over at beep. After defrosting, let stand for 20-30 minutes.</p> <p>Fish Fillets, Steaks, Whole fish, Sea foods</p> <p>Turn food over at beep. After defrosting, let stand for 10-20 minutes.</p>
Bread	0.1 ~ 0.5 kg	Paper towel or flat plate	Sliced bread, Buns, Baguette, etc.

Quick Defrost

Use this function to thaw only 0.5kg of Minced meat very quickly. This will require a standing time to allow the center to thaw. In the following example will show you how to defrost 0.5kg of frozen minced meat.



Your oven has a microwave quick defrost setting (MEAT).

Press **STOP/CLEAR**.

Weight the food that you are about to defrost. Be certain to remove any metallic ties or wraps; then place the food in your oven and close the oven door.



Press **QUICK DEFROST**.

The oven will start automatically.

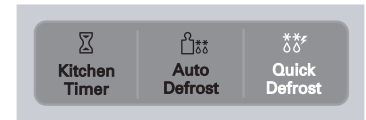

During defrosting your oven will "BEEP", at which point open the oven door, turn food over and separate to ensure even thawing. Remove any portions that have thawed or shield them to help slow down thawing. After checking close the oven door and press **START** to resume defrosting.

Your oven will not stop defrosting (even when the beep sounded) unless the door is opened.

QUICK DEFROST GUIDE

Use this function to defrost quickly for minced meat.

Remove the meat completely from its wrapping. Place the mince onto a microwave-safe plate. When beeps, at this point remove the mince from the microwave oven, turn the mince over and return to the microwave oven. Press start to continue. At the end of the program remove the mince from the microwave oven, cover with foil and allow to stand 5-15 minutes or until completely thawed.

Category	Weight	Utensil	Instructions
Minced Meat	0.5kg	Microwave ware (Flat plate)	Minced meat Turn food over at beep. After defrosting, let stand for 5-15 minutes.

Timer

In the following example I will show you how to set the timer for 15 minutes.



Your oven also has a Timer that can be used for noncooking functions. When used as an independent timer, the oven is not running. The Timer is simply counting down in seconds.

Press **STOP/CLEAR**.

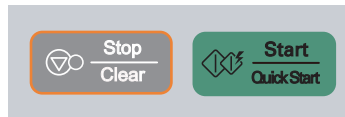

Press **KITCHEN TIMER**.

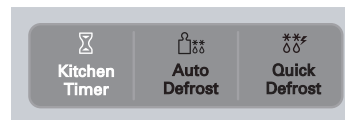

To enter amount of time you want to count down.

Press **10 MIN** once.

Press **1 MIN** five times.



Press **START**.

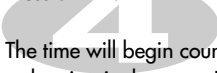

The time will begin counting down in the display window with no cooking or heating in the oven. BEEP will sound and the word "End" will show in the display window at the end of the countdown period.



More or Less Cooking

In the following example I will show you how to change the preset AUTO COOK programmes for a longer or shorter cooking time.



If you find that your food is over or undercooked when using the AUTO COOK programme, you can increase or decrease cooking time by pressing the MORE/LESS key.

When cooking without Auto function you can extend the cooking time at any point by pressing MORE/LESS key. There is no need to stop the cooking process.

Press STOP/CLEAR.



Set the required AUTO COOK programme.
(Select weight of food.)



Press START.



Press MORE.

The cooking time will increase by 10 seconds for each press of the key.

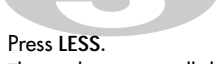

Press LESS.

The cooking time will decrease by 10 seconds for each press of the key.

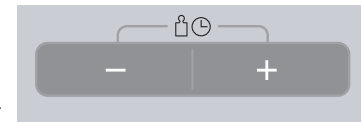

Heating or Reheating Guide

To heat or reheat successfully in the microwave, it is important to follow several guidelines. Measure the amount of food in order to determine the time needed to reheat. Arrange the food in a circular pattern for best results. Room temperature food will heat faster than refrigerated food. Canned foods should be taken out of the can and placed in a microwavable container. The food will be heated more evenly if covered with a microwavable lid or vented plastic wrap. Remove cover carefully to prevent steam burns. Use the following chart as a guide for reheating cooked food.

Item	Cook time (at HIGH)	Special Instructions
Sliced meat 3 slices (0.5cm thick)	1~2 minutes	Place sliced meat on microwavable plate. Cover with plastic wrap and vent. • Note: Gravy or sauce helps to keep meat juicy.
Chicken pieces 1 breast 1 leg and thigh	2~3 minutes 3~3 1/2 minutes	Place chicken pieces on microwavable plate. Cover with plastic wrap and vent.
Fish fillet (170-230g)	1~2 minutes	Place fish on microwavable plate. Cover with plastic wrap and vent.
Lasagne 1 serving(300g)	4~6 minutes	Place lasagne on microwavable plate. Cover with plastic wrap and vent.
Casserole 1 cup 4 cups	1 1/2~3 minutes 4 1/2~7 minutes	COOK covered in microwavable casserole dish. Stir once halfway through cooking.
Casserole cream or cheese 1 cup 4 cups	1~2 1/2 minutes 3 1/2~6 minutes	COOK covered in microwavable casserole dish. Stir once halfway through cooking.
Sloppy Joe or Barbecued beef 1 sandwich (1/2 cup meat filling) without bun	1~2 1/2 minutes	Reheat filling and bun separately. COOK covered in microwavable casserole dish. Stir once. Heat bun as directed in chart below.

Item	Cook time (at HIGH)	Special Instructions
Mashed potatoes 1 cup 4 cups	2 1/2~3 1/2 minutes 6~9 minutes	COOK covered in microwavable casserole dish. Stir once halfway through cooking.
Baked beans 1 cup	1 1/2~3 minutes	COOK covered in microwavable casserole dish. Stir once halfway through cooking.
Ravioli or pasta in sauce 1 cup 4 cups	2 1/2~4 minutes 7 1/2~11 minutes	COOK covered in microwavable casserole dish. Stir once halfway through cooking.
Rice 1 cup 4 cups	1~1 1/2 minutes 3 1/2~5 minutes	COOK covered in microwavable casserole dish. Stir once halfway through cooking.
Sandwich roll or bun 1 roll	15~30 seconds	Wrap in paper towel and place on glass tray.
Vegetables 1 cup 4 cups	1 1/2~2 1/2 minutes 3 1/2~5 1/2 minutes	COOK covered in microwavable casserole dish. Stir once halfway through cooking.
Soup 1 serving (8 oz.)	1 1/2~2 minutes	COOK covered in microwavable casserole dish. Stir once halfway through cooking.

Fresh Vegetable Guide

Vegetable	Amount	Cook time (at HIGH)	Instructions	Standing Time
Artichokes (230g each)	2 medium 4 medium	4 ¹ / ₂ ~ 7 10 ~ 12	Trim. Add 2 tsp water and 2 tsp juice. Cover.	2~3 minutes
Asparagus, Fresh, Spears	450g	2 ¹ / ₂ ~ 6	Add 1 cup water. Cover.	2~3 minutes
Green Beans	450g	7 ~ 11	Add ¹ / ₂ cup water in 1.5 litre casserole dish. Stir halfway through cooking.	2~3 minutes
Beets, Fresh	450g	11 ~ 16	Add ¹ / ₂ cup water in 1.5 litre covered casserole dish. Rearrange halfway through cooking.	2~3 minutes
Broccoli, Fresh, Spears	450g	5 ~ 8	Place broccoli in baking dish. Add ¹ / ₂ cup water.	2~3 minutes
Cabbage, Fresh, Chopped	450g	5 ¹ / ₂ ~7 ¹ / ₂	Add ¹ / ₂ cup water in 1.5 litre covered casserole dish. Stir halfway through cooking.	2~3 minutes
Carrots, Fresh, Sliced	200g	2 ~ 3	Add ¹ / ₄ cup water in 1.5 litre covered casserole dish. Stir halfway through cooking.	2~3 minutes
Cauliflower, Fresh, Whole	450g	5 ~ 7	Trim. Add ¹ / ₄ cup water in 1.5 litre covered casserole dish. Stir halfway through cooking.	2~3 minutes
Fresh, Flowerettes Celery, Fresh, Sliced	2 cups 4 cups	11 ~ 16	Slice. Add ¹ / ₂ cup water in 1.5 litre covered casserole dish. Stir halfway through cooking.	2~3 minutes

Vegetable	Amount	Cook time (at HIGH)	Instructions	Standing Time
Corn, Fresh	2 ears	4 ~ 8	Husk. Add 2 tbsp water in 1.5 litre baking dish. Cover.	2~3 minutes
Mushrooms, Fresh, Sliced	230g	1 ¹ / ₂ ~ 2 ¹ / ₂	Place mushrooms in 1.5 litre covered casserole dish. Stir halfway through cooking.	2~3 minutes
Parsnips, Fresh, Sliced	450g	4 ~ 7	Add ¹ / ₂ cup water in 1.5 litre covered casserole dish. Stir halfway through cooking.	2~3 minutes
Peas, Green, Fresh	4 cups	6 ~ 9	Add ¹ / ₂ cup water in 1.5 litre covered casserole dish. Stir halfway through cooking.	2~3 minutes
Sweet Potatoes Whole Baking (170~230g each)	2 medium 4 medium	4 ~ 9 6~ 12	Pierce potatoes several times with fork. Place on 2 paper towels. Turn over halfway through cooking.	2~3 minutes
White potatoes, Whole Baking (170~230g each)	2 potatoes 4 potatoes	5 ¹ / ₂ ~ 7 ¹ / ₂ 9 ¹ / ₂ ~ 14	Pierce potatoes several times with fork. Place on 2 paper towels. Turn over halfway through cooking.	2~3 minutes
Spinach, Fresh, Leaf	450g	4 ¹ / ₂ ~ 7 ¹ / ₂	Add ¹ / ₂ cup water in 2 litre covered casserole dish.	2~3 minutes
Courgette, Fresh, Sliced	450g	4 ¹ / ₂ ~ 7 ¹ / ₂	Add ¹ / ₂ cup water in 1.5 litre covered casserole dish. Stir halfway through cooking.	2~3 minutes
Courgette, Fresh, Whole	450g	6 ~ 9	Pierce. Place on 2 paper towels. Turn courgette over and rearrange halfway through cooking.	2~3 minutes

Grill Cooking Guide

Directions for grilling meat on grill

- Trim excess fat from meat. Cut fat, making sure you do not cut into the lean. (This will stop the fat curling.)
- Arrange on the rack. Brush with melted butter or oil.
- Halfway through, turn the meat over.

Item	Weight	Approx. cooking time (in minutes)	Hints
Beefburgers	50g x 2 100g x 2	13-16 19-23	Baste with oil or melted butter. Thin items should be placed on the grill rack. Thick items can be placed on to a drip tray. Turn food over after half the cooking time.
Beefsteaks (2.5cm (1") thick)			
Rare	230g x 2	18-20	
Medium	230g x 2	22-24	
Well	230g x 2	26-28	
Lamb chops (2.5cm (1") thick)	230g x 2	25-32	

Directions for grilling fish and seafood

Place fish and seafood on the rack. Whole fish should be scored diagonally on both sides before grilling. Brush fish and seafood with melted butter, margarine or oil before and during cooking. This helps stop the fish drying out. Grill for times recommended in the chart. Whole fish and fish steaks should be carefully turned over halfway through grilling time. If desired thick fillets can also be turned halfway.

Item	Weight	Approx. cooking time (in minutes)	Hints
Fish fillets			Brush with melted butter and turn over halfway through cooking.
1 cm (1/2") thick	230g	17-21	
1.5cm (1/2") thick	230g	20-24	
Fish steaks			
2.5 cm (1") thick	230g	24-28	
Whole fish	225-350g each	16-20 24-28	Allow extra time for thick and oily fish.
Scallops	450g	16-20	Baste well during cooking.
Prawns uncooked	450g	16-20	

WARNING

Please ensure cooking times are correctly set as over cooking may result in FIRE and subsequent DAMAGE to the OVEN.

Important safety instructions

Read carefully and keep for future reference

- 1 Do not attempt to tamper with, or make any adjustments or repairs to the door, control panel, safety interlock switches or any other part of the oven. It is hazardous for anyone to carry out any service or repair operation which involves the removal of any cover which gives protection against exposure to microwave energy. Repairs should only be undertaken by a qualified service technician.
- 2 Do not operate the oven when empty. It is best to leave a glass of water in the oven when not in use. The water will safely absorb all microwave energy, if the oven is accidentally started.
- 3 Do not use the oven for the purpose of dehumidification. It can be the cause of serious damage of safety. (ex. Operating the microwave oven with the wet newspapers, clothes, toys, pet or portable electric devices, etc.)
- 4 Do not cook food wrapped in paper towels, unless your cook book contains instructions, for the food you are cooking.
- 5 Do not use newspaper in place of paper towels for cooking.
- 6 Do not use wooden containers. They may heat-up and char. Do not use ceramic containers which have metallic (e.g. gold or silver) inlays. Always remove metal twist ties. Metal objects in the oven may arc, which can cause serious damage.
- 7 Do not operate the oven with a kitchen towel, a napkin or any other obstruction between the door and the front edges of the oven, which may cause microwave energy leakage.
- 8 Do not use recycled paper products since they may contain impurities which may cause sparks and/or fires when used in cooking.
- 9 Do not rinse the turntable by placing it in water just after cooking. This may cause breakage or damage.
- 10 Small amounts of food require shorter cooking or heating time. If normal times are allowed they may overheat and burn.
- 11 Be certain to place the oven so the front of the door is 8 cm or more behind the edge of the surface on which it is placed, to avoid accidental tipping of the appliance.
- 12 Before cooking, pierce the skin of potatoes, apples or any such fruit or vegetable.
- 13 Do not cook eggs in their shell. Pressure will build up inside the egg which will burst.
- 14 Do not attempt deep fat frying in your oven.
- 15 Remove the plastic wrapping from food before cooking or defrosting. Note though that in some cases food should be covered with plastic film, for heating or cooking.
- 16 If the oven door or door seals are damaged, the oven must not be operated until it has been repaired by a qualified service technician.
- 17 If smoke is observed, switch off or disconnect the oven from the power supply and keep the oven door closed in order to stifle any flames.
- 18 When food is heated or cooked in disposable containers of plastic, paper or other combustible materials, check the oven frequently due to the possibility of the food container is deteriorating.
- 19 Only allow children to use the oven without supervision when adequate instructions have been given so that the child is able to use the oven in a safe way and understands the hazards of improper use.
- 20 Liquids or other foods must not be heated in sealed containers since they are liable to explode.
- 21 Do not operate the oven, if the door seals and adjacent parts of the microwave oven are faulty, until the oven has been repaired by a qualified service technician.
- 22 Check the utensils are suitable for use in microwave ovens before use.
- 23 Do not touch the oven door, outer cabinet, rear cabinet, oven cavity, accessories and dishes during grill mode, convection mode and auto cook operations, unless wearing thick oven gloves, as they will become hot. Before clearing make sure they are not hot.

Microwave-safe Utensils

Never use metal or metal trimmed utensils in your microwave oven

Microwaves cannot penetrate metal. They will bounce off any metal object in the oven and cause arcing, an alarming phenomenon that resembles lightning.

Most heat resistant non metallic cooking utensils are safe for use in your microwave oven. However, some may contain materials that render them unsuitable as microwave cookware. If you have any doubts about a particular utensil, there's a simple way to find out if it can be used in your microwave oven.

Place the utensil in question next to a glass bowl filled with water in the microwave oven. Microwave at power HIGH for 1 minute. If the water heats up but the utensil remains cool to the touch, the utensil is microwave-safe. However, if the water does not change temperature but the utensil becomes warm, microwaves are being absorbed by the utensil and it is not safe for use in the microwave oven. You probably have many items on hand in your kitchen right now that can be used as cooking equipment in your microwave oven. Just read through the following checklist.

Dinner plates

Many kinds of dinner-ware are microwave-safe. If in doubt consult the manufacturer's literature or perform the microwave test.

Glassware

Glassware that is heat-resistant is microwave-safe. This would include all brands of oven tempered glass cookware. However, do not use delicate glassware, such as tumblers or wine glasses, as these might shatter as the food warms.

Plastic storage containers

These can be used to hold foods that are to be quickly reheated. However, they should not be used to hold foods that will need considerable time in the oven as hot foods will eventually warp or melt plastic containers.

Paper

Paper plates and containers are convenient and safe to use in your microwave oven, provided that the cooking time is short and foods to be cooked are low in fat and moisture. Paper towels are also very useful for wrapping foods and for lining baking trays in which greasy foods such as bacon are cooked. In general, avoid coloured paper products as the colour may run. Some recycled paper products may contain impurities which could cause arcing or fires when used in the microwave oven.

Plastic cooking bags

Provided they are made specially for cooking, cooking bags are microwave safe. However, be sure to make a slit in the bag so that steam can escape. Never use ordinary plastic bags for cooking in your microwave oven, as they will melt and rupture.

Plastic microwave cookware

A variety of shapes and sizes of microwave cookware are available. For the most part, you can probably use items you already have on hand rather than investing in new kitchen equipment.

Pottery, stoneware and ceramic

Containers made of these materials are usually fine for use in your microwave oven, but they should be tested to be sure.

CAUTION

Some items with high lead or iron content are not suitable for cooking utensils.

Utensils should be checked to ensure that they are suitable for use in microwave ovens.

Food characteristics & Microwave cooking

Keeping an eye on things

The recipes in the book have been formulated with great care, but your success in preparing them depends on how much attention you pay to the food as it cooks. Always watch your food while it cooks. Your microwave oven is equipped with a light that turns on automatically when the oven is in operation so that you can see inside and check the progress of your food. Directions given in recipes to elevate, stir, and the like should be thought of as the minimum steps recommended. If the food seems to be cooking unevenly, simply make the necessary adjustments you think appropriate to correct the problem.

Factors affecting microwave cooking times

Many factors affect cooking times. The temperature of ingredients used in a recipe makes a big difference in cooking times. For example, a cake made with ice-cold butter, milk, and eggs will take considerably longer to bake than one made with ingredients that are at room temperature. All of the recipes in this book give a range of cooking times. In general, you will find that the food remains under-cooked at the lower end of the time range, and you may sometimes want to cook your food beyond the maximum time given, according to personal preference. The governing philosophy of this book is that it is best for a recipe to be conservative in giving cooking times. While overcooked food is ruined for good. Some of the recipes, particularly those for bread, cake, and custards, recommend that food be removed from the oven when they are slightly undercooked. This is not a mistake. When allowed to stand, usually covered, these foods will continue to cook outside of the oven as the heat trapped within the outer portions of the food gradually travels inward. If the food is left in the oven until it is cooked all the way through, the outer portions will become overcooked or even burnt. You will become increasingly skilful in estimating both cooking and standing times for various foods.

Density of food

Light, porous food such as cakes and breads cook more quickly than heavy, dense foods such as roasts and casseroles. You must take care when microwaving porous food that the outer edges do not become dry and brittle.

Height of food

The upper portion of tall food, particularly roasts, will cook more quickly than the lower portion. Therefore, it is wise to turn tall food during cooking, sometimes several times.

Moisture content of food

Since the heat generated from microwaves tends to evaporate moisture, relatively dry food such as roasts and some vegetables should either be sprinkled with water prior to cooking or covered to retain moisture.

Bone and fat content of food

Bones conduct heat and fat cooks more quickly than meat. Care must be taken when cooking bony or fatty cuts of meat that they do not cook unevenly and do not become overcooked.

Quantity of food

The number of microwaves in your oven remains constant regardless of how much food is being cooked. Therefore, the more food you place in the oven, the longer the cooking time. Remember to decrease cooking times by at least one third when halving a recipe.

Shape of food

Microwaves penetrate only about 2 cm into food, the interior portion of thick foods are cooked as the heat generated on the outside travels inward. Only the outer edge of food is cooked by microwave energy; the rest is cooked by conduction. The worst possible shape for a food that is to be microwaved is a thick square. The corners will burn long before the centre is even warm. Round thin foods and ring shaped foods cook successfully in the microwave.

Covering

A cover traps heat and steam which causes food to cook more quickly. Use a lid or microwave cling film with a corner folded back to prevent splitting.

Browning

Meats and poultry that are cooked fifteen minutes or longer will brown lightly in their own fat. Food that are cooked for a shorter period of time may be brushed with a browning sauce such as worcestershire sauce, soy sauce or barbecue sauce to achieve an appetizing colour. Since relatively small amounts of browning sauces are added to food the original flavour of the recipe is not altered.

Covering with greaseproof paper

Greaseproofing effectively prevents spattering and helps food retain some heat. But because it makes a looser cover than a lid or clingfilm, it allows the food to dry out slightly.

Arranging and spacing

Individual foods such as baked potatoes, small cakes and hors d'oeuvres will heat more evenly if placed in the oven an equal distance apart, preferably in a circular pattern. Never stack foods on top of one another.

Food characteristics & Microwave cooking.

Stirring

Stirring is one of the most important of all microwaving techniques. In conventional cooking, food is stirred for the purpose of blending. Microwaved food, however, is stirred in order to spread and redistribute heat. Always stir from the outside towards the centre as the outside of the food heats first.

Turning over

Large, tall foods such as roasts and whole chickens should be turned so that the top and bottom will cook evenly. It is also a good idea to turn cut up chicken and chops.

Placing thicker portions facing outwards

Since microwaves are attracted to the outside portion of food, it makes sense to place thicker portions of meat, poultry and fish to the outer edge of the baking dish. This way, thicker portions will receive the most microwave energy and the food will cook evenly.

Shielding

Strips of aluminium foil (which block microwaves) can be placed over the corners or edges of square and rectangular foods to prevent those portions from overcooking. Never use too much foil and make sure the foil is secured to the dish or it may cause 'arcing' in the oven.

Elevating

Thick or dense foods can be elevated so that microwaves can be absorbed by the underside and centre of the foods.

Piercing

Foods enclosed in a shell, skin or membrane are likely to burst in the oven unless they are pierced prior to cooking. Such foods include yolks and whites of eggs, clams and oysters and whole vegetables and fruits.

Testing if cooked

Food cooks so quickly in a microwave oven, it is necessary to test it frequently. Some foods are left in the microwave until completely cooked, but most foods, including meats and poultry, are removed from the oven while still slightly undercooked and allowed to finish cooking during standing time. The internal temperature of foods will rise between 5°F (3°C) and 15°F (8°C) during standing time.

Standing time

Foods are often allowed to stand for 3 to 10 minutes after being removed from the microwave oven. Usually the foods are covered during standing time to retain heat unless they are supposed to be dry in texture (some cakes and biscuits, for example). Standing allows foods to finish cooking and also helps flavour blend and develop.

To Clean Your Oven

1 Keep the inside of the oven clean

Food spatters or spilled liquids stick to oven walls and between seal and door surface. It is best to wipe up spillovers with a damp cloth right away. Crumbs and spillovers will absorb microwave energy and lengthen cooking times. Use a damp cloth to wipe out crumbs that fall between the door and the frame. It is important to keep this area clean to assure a tight seal. Remove greasy spatters with a soapy cloth then rinse and dry. Do not use harsh detergent or abrasive cleaners. The glass tray can be washed by hand or in the dishwasher.

2 Keep the outside of the oven clean

Clean the outside of your oven with soap and water then with clean water and dry with a soft cloth or paper towel. To prevent damage to the operating parts inside the oven, the water should not be allowed to seep into the ventilation openings. To clean control panel, open the door to prevent oven from accidentally starting, and wipe a damp cloth followed immediately by a dry cloth. Press STOP/CLEAR after cleaning.

3 If steam accumulates inside or around the outside of the oven door, wipe the panels with a soft cloth. This may occur when the microwave oven is operated under high humidity conditions and in no way indicates a malfunction of the unit.

4 The door and door seals should be kept clean. Use only warm, soapy water, rinse then dry thoroughly.

DO NOT USE ABRASIVE MATERIALS, SUCH AS CLEANING POWDERS OR STEEL AND PLASTIC PADS.

Metal parts will be easier to maintain if wiped frequently with a damp cloth.

Questions & Answers

Q What's wrong when the oven light will not glow?

A There may be several reasons why the oven light will not glow.
Light bulb has blown
Door is not closed

Q Does microwave energy pass through the viewing screen in the door?

A No. The holes, or ports, are made to allow light to pass; they do not let microwave energy through.

Q Why does the beep tone sound when a pad on the Control Panel is touched?

A The beep tone sounds to assure that the setting is being properly entered.

Q Will the microwave oven be damaged if it operates empty?

A Yes Never run it empty or without the glass tray.

Q Why do eggs sometimes pop?

A When baking, frying, or poaching eggs, the yolk may pop due to steam build up inside the yolk membrane. To prevent this, simply pierce the yolk before cooking. Never microwave eggs in the shell.

Q Why is standing time recommended after microwave cooking is over?

A After microwave cooking is finished, food keeps on cooking during standing time. This standing time finishes cooking evenly throughout the food. The amount of standing time depends on the density of the food.

Q Is it possible to pop corn in a microwave oven?

A Yes, if using one of the two methods described below

- 1 Popcorn-popping utensils designed specifically for microwave cooking.
- 2 Prepackaged commercial microwave popcorn that contains specific times and power outputs needed for an acceptable final product.

FOLLOW EXACT DIRECTIONS GIVEN BY EACH MANUFACTURER FOR THEIR POPCORN PRODUCT. DO NOT LEAVE THE OVEN UNATTENDED WHILE THE CORN IS BEING POPPED. IF CORN FAILS TO POP AFTER THE SUGGESTED TIMES, DISCONTINUE COOKING. OVERCOOKING COULD RESULT IN THE CORN CATCHING FIRE.

CAUTION

NEVER USE A BROWN PAPER BAG FOR POPPING CORN. NEVER ATTEMPT TO POP LEFTOVER KERNELS.

Q Why doesn't my oven always cook as fast as the cooking guide says?

A Check your cooking guide again to make sure you've followed directions correctly, and to see what might cause variations in cooking time. Cooking guide times and heat settings are suggestions, chosen to help prevent overcooking, the most common problem in getting used to a microwave oven. Variations in the size, shape, weight and dimensions of the food require longer cooking time. Use your own judgement along with the cooking guide suggestions to test food condition, just as you would do with a conventional cooker.

Plug wiring information/ Technical Specifications

Warning

This appliance must be earthed

The wires in this mains lead are colored in accordance with the following codes
BLUE ~ Neutral
BROWN ~ Live
GREEN & YELLOW ~ Earth

As the colours of the wires in the mains lead of this appliance may not correspond with the coloured markings identifying the terminals in your plug proceed as follows:

The wire which is colored BLUE must be connected to the terminal which is marked with the letter N or Colored BLACK.

The wire which is colored BROWN must be connected to the terminal which is marked with the letter L or colored RED.

The wire which is colored GREEN & YELLOW or GREEN must be connected to the terminal which is marked with the letter E or .

If the supply cord is damaged, it must be replaced by the manufacturer or its service agent or a similarly qualified person in order to avoid a hazard;

For Singapore If the supply cord is damaged, it must be replaced by a special cord or assembly available from the manufacturer or its service agent.

Technical Specification

	MH7046S
Power Input	220 V AC / 50Hz
Output	900 W (IEC60705 rating standard)
Microwave Frequency	2,450 MHz
Outside Dimension	510 mm(W) X 310 mm(H) X 404 mm(D)
Power Consumption	
Microwave	1300 Watts
Grill	1000 Watts
Combination	2250 Watts

