



OWNER'S MANUAL

# MICROWAVE OVEN

Please read this owner's manual thoroughly before operating.

MS2548GR  
MS2548XR



MFL40257808

[www.lg.com](http://www.lg.com)

# PRECAUTIONS

## Precautions to avoid possible exposure to excessive microwave energy.

You cannot operate your oven with the door open due to the safety interlocks built into the door mechanism. These safety interlocks automatically switch off any cooking activity when the door is opened; which in the case of a microwave oven could result in harmful exposure to microwave energy.

**It is important not to tamper with the safety interlocks.**

Do not place any object between the oven front face and the door or allow food or cleaner residue to accumulate on sealing surfaces.

Do not operate your oven if it is damaged. It is particularly important that the oven door closes properly and that there is no damage to the: (1) door(bent), (2) hinges and latches (broken or loosened), (3) door seals and sealing surfaces.

Your oven should not be adjusted or repaired by anyone except qualified service personnel.

## **Warning**

**Please ensure cooking times are correctly set as over cooking may result in the FOOD catching fire and subsequent damage to your oven.**

When heating liquids, e.g. soups, sauces and beverages in your microwave oven, overheating the liquid beyond boiling point can occur without evidence of bubbling. This could result in a sudden boil over of the hot liquid. To prevent this possibility the following steps should be taken:

1. Avoid using straight sided containers with narrow necks.
2. Do not overheat.
3. Stir the liquid before placing the container in the oven and again halfway through the heating time.
4. After heating, allow to stand in the oven for a short time, stir or shake them again carefully and check the temperature of them before consumption to avoid burns (especially, contents of feeding bottles and baby food jars).

## **Warning**

**Always allow food to stand after being cooked by microwaves and check the temperature of them before consumption. Especially contents of feeding bottles and baby food jars.**

## How the Microwave Oven Works

Microwaves are a form of energy similar to radio and television waves and ordinary daylight. Normally, microwaves spread outwards as they travel through the atmosphere and disappear without effect. Microwave ovens, however, have a magnetron which is designed to make use of the energy in microwaves. Electricity, supplied to the magnetron tube, is used to create microwave energy.

These microwaves enter the cooking area through openings inside the oven. A turntable or tray is located at the bottom of the oven. Microwaves cannot pass through metal walls of the oven, but they can penetrate such materials as glass, porcelain and paper, the materials out of which microwave-safe cooking dishes are constructed.

Microwaves do not heat cookware, though cooking vessels will eventually get hot from the heat generated by the food.

## **A very safe appliance**

**Your microwave oven is one of the safest of all home appliances. When the door is opened, the oven automatically stops producing microwaves. Microwave energy is converted completely to heat when it enters food, leaving no “left over” energy to harm you when you eat your food.**

# CONTENTS

<b>PRECAUTIONS</b>	<b>2</b>
<b>CONTENTS</b>	<b>3</b>
<b>UNPACKING &amp; INSTALLING</b>	<b>4</b>
<b>FEATURE DIAGRAM</b>	<b>6</b>
<b>CONTROL PANEL</b>	<b>6</b>
<b>OPERATING INSTRUCTIONS</b>	<b>7</b>
SETTING CLOCK	7
CHILD LOCK	7
ADD MINUTE	7
QUICK TOUCH COOKING	8
QUICK TOUCH COOKING TABLE	8
MICROWAVE COOKING	9
2 STAGE TIMED COOKING	9
QUICK START	9
MICROWAVE POWER LEVELS	9
COOKING TIPS	10
MELT	12
MELT TABLE	12
SOFTEN	12
SOFTEN TABLE	12
AUTO DEFROST	13
EXPRESS DEFROST	14
BREAD DEFROST	14
AUTO DEFROST TABLE	14
HEATING OR REHEATING GUIDE	15
FRESH VEGETABLE GUIDE	16
<b>MICROWAVE-SAFE UTENSILS</b>	<b>17</b>
<b>FOOD CHARACTERISTICS &amp; MICROWAVE COOKING</b>	<b>18</b>
<b>SAFETY PRECAUTIONS</b>	<b>20</b>
<b>QUESTION &amp; ANSWERS</b>	<b>21</b>
<b>PLUG WIRING INFORMATION/TECHNICAL SPECIFICATIONS</b>	<b>22</b>

# UNPACKING & INSTALLING

By following the basic steps on these two pages you will be able to quickly check that your oven is operating correctly. Please pay particular attention to the guidance on where to install your oven. When unpacking your oven make sure you remove all accessories and packing. Check to make sure that your oven has not been damaged during delivery.

- 1** Unpack your oven and place it on a flat level surface.

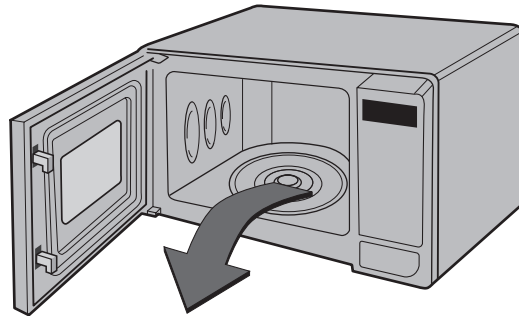

- 2** Place your oven on a flat, level surface but make sure there is at least **20 cm** of space on the top, rear and sides so there is air flow for ventilation. Exhaust outlets are located in the back and side of your oven. Blocking the outlets can damage your oven. The microwave oven shall not be placed in a cabinet.

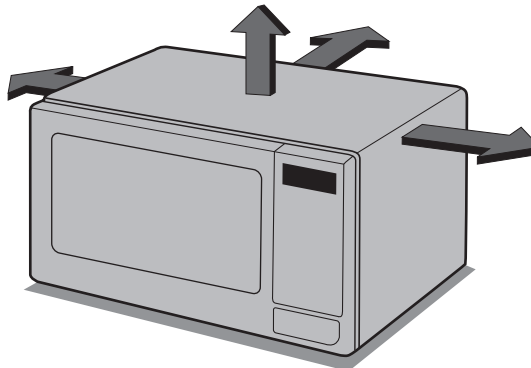

**THIS OVEN SHOULD NOT BE USED FOR COMMERCIAL CATERING PURPOSES**

# UNPACKING & INSTALLING

- 3** Plug your oven into a standard household socket. Make sure your oven is the only appliance connected to the socket. **If your oven does not operate properly, unplug it from the electrical socket and then plug it back in.**

- 4** Open your oven door by pressing the **DOOR OPEN** button.  
Place the **ROTATING RING** inside the oven and place the **GLASS TRAY** on top.

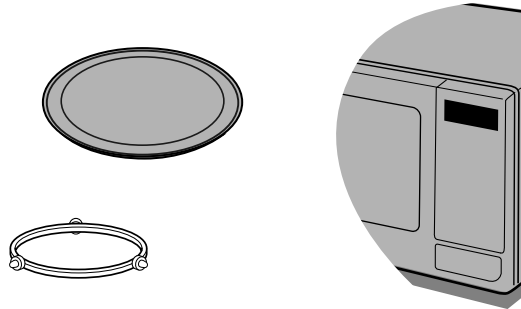

- 5** Fill a **microwave safe container** with 300 ml (1/2 pint) of water. Place on the **GLASS TRAY** and close the oven door. If you have any doubts about what type of container to use please refer to page 17.



- 6** Enter the time by touching [3] and [0].  
And touch **START**.



- 7** The **DISPLAY** will count down from 30 seconds. When it reaches 0 it will sound BEEPS.  
Open the oven door and test the temperature of the water. If your oven is operating the water should be **HOT**. **Be careful when removing the container it may be hot.**



**YOUR OVEN IS NOW INSTALLED**

# FEATURE DIAGRAM

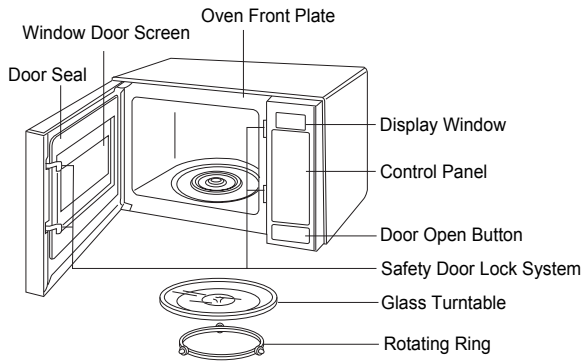

Remove your Microwave Oven and all material from the shipping carton. Your oven will be packed with the following materials:

- Glass Turntable ..... 1 each
- Owner's Manual & Cooking Guide..... 1 each
- Rotating Ring..... 1 each

This microwave oven is designed for household use only. It is not recommended for commercial purposes.

# CONTROL PANEL

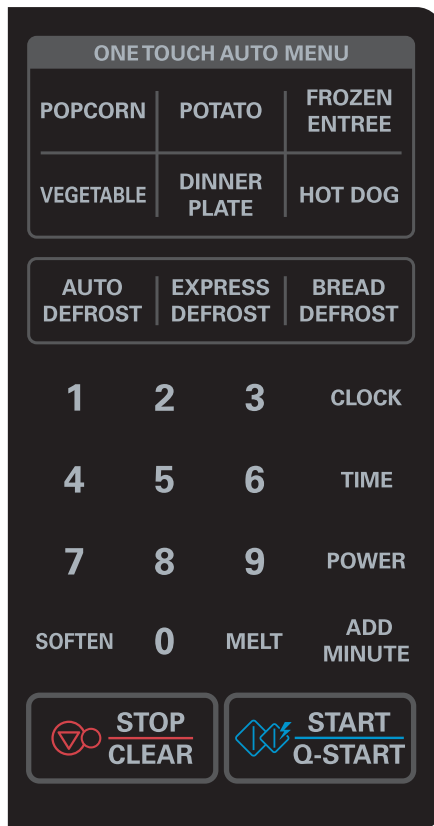

**NOTE:** A beep sounds when a pad on the control panel is touched to indicate setting has been entered.



# OPERATING INSTRUCTIONS

## QUICK TOUCH COOKING

Use this function to cook food without entering a cook time or power. Refer to the Quick Touch Cooking Table below for more information.

**Example: To cook a 100 g. bag of microwave popcorn.**

**Touch:** **Display Shows:**

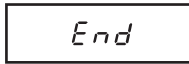
- POPCORN** Once 
- The oven will start automatically. Time counting down.
- At the end of cooking time, 4 short tones will sound. 

**Example: To cook 1 potato**

**Touch:** **Display Shows:**

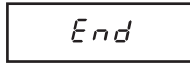
- POTATO** Once 
- The oven will start automatically. Time counting down.
- At the end of cooking time, 4 short tones will sound. 

## QUICK TOUCH COOKING TABLE

Category	Touch	Serving size	Directions
Popcorn	1 time 2 times	100 g 85 g	<ul style="list-style-type: none"> <li>Follow package instructions.</li> <li>Do not try to pop unpopped kernels.</li> <li>Heat only 1 package at a time.</li> </ul>
Potato	1 time 2 times 3 times 4 times	1 ea ( 227 g ) 2 ea ( 454 g ) 3 ea ( 681 g ) 4 ea ( 908 g )	<ul style="list-style-type: none"> <li>227-284 g per potato.</li> <li>Pierce potato several times with fork.</li> <li>Place in center of the turntable tray on paper towel.</li> <li>After cooking, let stand for 5 minutes.</li> </ul>
Frozen Entree	1 time	284 g	<ul style="list-style-type: none"> <li>Remove from outer display package.</li> <li>If not in microwave-safe container, place on plate and cover with plastic wrap and vent.</li> </ul>
Vegetable	1 time 2 times 3 times 4 times	1 cup 2 cups 3 cups 4 cups	<ul style="list-style-type: none"> <li>Prepare as desired, wash, and leave residual water on the vegetables.</li> <li>Place the appropriately-sized microwave container.</li> <li>Cover with plastic wrap and vent.</li> </ul>
Dinner Plate	1 time 2 times	300 g 454 g	<ul style="list-style-type: none"> <li>Arrange food on the microwave plate.</li> <li>Place meaty portions and bulky vegetables to the outside of the plate.</li> <li>Cover with plastic wrap and vent.</li> <li>After cooking , let stand for 2 minutes.</li> </ul>
Hot Dog	1 time 2 times 3 times 4 times 5 times 6 times	1 ea 2 ea 3 ea 4 ea 5 ea 6 ea	<ul style="list-style-type: none"> <li>Pierce the skin and place hot dogs in microwave-safe bowl.</li> <li>Cover with water.</li> <li>Heat uncovered.</li> <li>After heating, stir well.</li> <li>Drain and serve.</li> </ul>



# OPERATING INSTRUCTIONS

## MICROWAVE COOKING











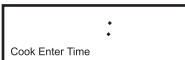

This feature lets you program a specific cook time and power. For best results, there are 10 power level settings in addition to HIGH power (100%). Refer to the "Microwave Power Level Table" on page 9 for more information.

**NOTE:** If you do not select a power level, the oven will automatically cook at HIGH (100%) power.

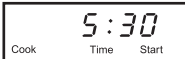
**Example: To cook for 5 minutes, 30 seconds at 80% power.**

**Touch:**

**Display Shows:**

1.  :
2.  
3.    
4.  
5.  
6.  Time counting down and POWER 80.

## 2 STAGE TIMED COOKING

For Two Stage cooking, repeat timed cooking steps 2 through 5 on the previous page before touching the START pad for additional Time and Power program you want to add. Auto Weight Defrost can be programmed before the first stage to defrost first and then cook.

## MICROWAVE POWER LEVELS

Your microwave oven has 10 cook power levels to let you cook or heat a wide variety of foods. Refer to the table below for suggestions:



### Microwave Power Level Table

Power Level	Use
10 (High)	<ul style="list-style-type: none"> <li>Boiling water</li> <li>Making candy</li> <li>Cooking poultry pieces, fish, &amp; vegetables.</li> <li>Cooking tender cuts of meat.</li> <li>Whole poultry.</li> </ul>
9	<ul style="list-style-type: none"> <li>Reheating rice, pasta, &amp; vegetables.</li> </ul>
8	<ul style="list-style-type: none"> <li>Reheating prepared foods quickly.</li> <li>Reheating sandwiches.</li> </ul>
7	<ul style="list-style-type: none"> <li>Cooking egg, milk, &amp; cheese dishes.</li> <li>Cooking cakes, breads.</li> <li>Melting chocolate.</li> </ul>
6	<ul style="list-style-type: none"> <li>Cooking veal.</li> <li>Cooking whole fish.</li> <li>Cooking puddings &amp; custard.</li> </ul>
5	<ul style="list-style-type: none"> <li>Cooking ham, whole poultry, &amp; lamb.</li> <li>Cooking rib roast, sirloin tip.</li> </ul>
4	<ul style="list-style-type: none"> <li>Thawing meat, poultry, &amp; seafood.</li> </ul>
3	<ul style="list-style-type: none"> <li>Cooking less tender cuts of meat.</li> <li>Cooking pork chops, roast.</li> </ul>
2	<ul style="list-style-type: none"> <li>Taking chill out of fruit.</li> <li>Softening butter.</li> </ul>
1	<ul style="list-style-type: none"> <li>Keeping casseroles &amp; main dishes warm.</li> <li>Softening butter &amp; cream cheese.</li> </ul>
0	<ul style="list-style-type: none"> <li>Standing time.</li> </ul>

## QUICK START

The QUICK START feature allows you to set 30 seconds intervals of HIGH power cooking with a touch of the START/Q-START.

**Example: Set 2 minutes of cooking on high power.**

1.  Time of day.
2.  Four times Select 2minutes on high power.  
You oven will start before you have finished the fourth press.

During QUICK START cooking, you can extend the cooking time up to 10 minutes by repeatedly pressing the START/Q-START key.

# OPERATING INSTRUCTIONS

**WARNING:** Do not use large sheets of aluminum foil because they hinder cooking and may cause arcing. You may use small pieces of foil to shield poultry legs and wings. Keep all aluminum foil at least 1 inch from the walls and door of the oven.

## COOKING TIPS

### Meat

1. No special techniques are required. Meat should be prepared as with conventional cooking. Season if desired. Always thoroughly defrost meat before cooking.
2. Place the meat on a microwave roasting rack or microwave-proof plate and place on the turntable.
3. Cook according to the Meat Cooking Table (below). Use the longer time for large cuts of meats and the shorter time for small cuts of meats. For thicker chops, use the longer time.
4. Turn the meat once halfway through the cooking time.
5. **Let stand** for 5-10 minutes wrapped in foil after cooking. The standing time is very important as it completes the cooking process.
6. Make sure meat, especially pork, is thoroughly cooked before eating.

### Meat Cooking Table

Meat	Microwave Power	Cooking Time Per Pound
<b>BEEF</b>		
Standing/Rolled Rib		
– Medium	8	9½ to 11½ minutes
– Well-done	8	11½ to 14 minutes
Ground Beef (to brown for casserole)	HIGH(100%)	6½ to 9½ minutes
Hamburgers, Fresh or defrosted (4 oz. each)		
– 2 patties	HIGH(100%)	2½ to 4½ minutes
– 4 patties	HIGH(100%)	3½ to 5½ minutes
<b>PORK</b>		
Loin, Leg	8	12½ to 16½ minutes
Bacon		
– 4 slices	HIGH(100%)	2½ to 3½ minutes
– 6 slices	HIGH(100%)	3½ to 4½ minutes

**NOTE:** The times listed above are only a guide. Allow for difference in individual tastes and preferences. The times may also vary due to the shape, cut, and composition of the food.

### Poultry

1. No special techniques are required. Poultry should be prepared as with conventional cooking. Season if desired.
2. Poultry should be thoroughly defrosted. Remove giblets and any metal clamps.
3. Prick the skin and brush lightly with vegetable oil unless the poultry is self-basting.
4. All poultry should be placed on a microwave roasting rack or a microwave-proof plate and placed on the turntable.
5. Cook according to the instructions in the Poultry Cooking Table below. Turn over halfway through the cooking time. Because of its shape, poultry has a tendency to cook unevenly, especially in very bony parts. Turning food over helps to cook these areas evenly.
6. Remove from oven, wrap in foil and let stand for 5 -10 minutes before carving. The standing time is very important, since it completes the cooking process.
7. Make sure poultry is thoroughly cooked before eating. Whole poultry is completely cooked when the juices run clear from the inside thigh when it is pierced with a sharp knife. Poultry pieces should be pierced with a sharp knife through the thickest part to ensure that the juices are clear and the flesh is firm.

### Poultry Cooking Table

Poultry	Microwave Power	Cooking Time Per Pound
<b>CHICKEN</b>		
Whole	8	11 to 15 minutes
Breast (boned)	8	10 to 14 minutes
Portions	8	11 to 17 minutes
<b>TURKEY</b>		
Whole	8	11 to 15 minutes

#### NOTES:

- The times listed above are only a guide. Allow for difference in individual tastes and preferences. The times may also vary due to the shape, cut, and composition of the food.
- If whole poultry is stuffed, the weight of the stuffed bird should be used when calculating the cooking time.

# OPERATING INSTRUCTIONS

## COOKING TIPS (continued)

### Fish

1. Arrange fish in a large shallow non-metallic dish or casserole dish.
2. Cover with pierced microwave plastic wrap or casserole lid.
3. Place the dish on the turntable.
4. Cook according to the instructions in the Fresh Fish Cooking Table. A few Flakes of butter can be added to the fish if desired.
5. Let stand as directed in the Cooking Table before serving.
6. After standing time, check to see that the fish is thoroughly cooked. The fish should be opaque and flake easily.

### Fresh Fish Cooking Table

Fish	Microwave Power	Cooking Time Per Pound	Butter	Standing Time
Fish Fillets	HIGH	4½ to 8 minutes	Add 1 to 2 tbsp (15 to 30 ml) of lemon juice.	2 to 3 minutes
Whole Mackerel, Cleaned and Prepared	HIGH	4½ to 8 minutes	–	3 to 4 minutes
Whole Trout, Cleaned and Prepared	HIGH	5½ to 9 minutes	–	3 to 4 minutes
Salmon Steaks	HIGH	5½ to 8 minutes	Add 1 to 2 tbsp (15 to 30 ml) of lemon juice.	3 to 4 minutes



# OPERATING INSTRUCTIONS

## AUTO DEFROST







Three defrost sequences are preset in the oven. The auto defrost feature provides you with the best defrosting method for frozen foods. The cooking guide will show you which defrost sequence is recommended for the food you are defrosting.

For added convenience, the Auto Defrost includes a built-in beep mechanism that reminds you to check, turn over, separate, or rearrange to get the best defrost results. Three different defrosting levels are provided.

- 1 MEAT
- 2 POULTRY
- 3 FISH

\*Available weight is 0.1~4.0 kg.

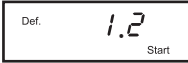
**Example: To defrost 1.2 kg of ground beef.**

<b>Touch:</b>	<b>Display Shows:</b>
1.  Once	
2.  and  to enter the weight	
3. 	Time counting down

**NOTE:** 4 tones can be heard in middle of cycle.

### NOTE:

When you touch the START pad, the display changes to defrost time count down. The oven will beep during the DEFROST cycle. At this time, open the door and turn, separate, or rearrange the food. Remove any portions that have thawed. Return frozen portions to the oven and touch START to resume the defrost cycle.

### OPERATING TIPS

- For best results, remove fish, shellfish, meat, and poultry from its original closed paper or plastic package (wrapper). Otherwise, the wrap will hold steam and juice close to the foods, which can cause the outer surface of the foods to cook.
- For best results, shape your ground meat into the form of a doughnut before freezing. When defrosting, scrape off thawed meat when the beep sounds and continue defrosting.
- Place foods in a shallow container or on a microwave roasting rack to catch drippings.
- Food should still be somewhat icy in the center when removed from the oven.



# OPERATING INSTRUCTIONS

## EXPRESS DEFROST

This feature should be used only when you defrost 0.5 kg of frozen ground beef.

**Example: To defrost 0.5 kg Ground beef.**

**Touch:** **Display Shows:**

1.  Time of day.
2.  Time counting down .

**NOTE:** 4 tones can be heard in middle of cycle.





## BREAD DEFROST

The bread defrost feature provides you with the best defrosting method for frozen bread.

\*Available weight is 0.1~0.5 kg.

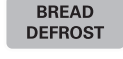
**Example: To defrost 0.1 kg of bread.**

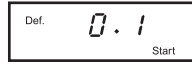
**Touch:** **Display Shows:**

1.  
2.    
to enter the weight
3.  Time counting down.

**NOTE:** 4 tones can be heard in middle of cycle.

## AUTO DEFROST TABLE

Category	Food to be Defrosted
<i>DEF 1</i> <b>MEAT</b>	<b>Beef</b> Ground beef, Round steak, Cubes for stew, Tenderloin steak, Pot roast, Rib roast, Rump roast, Chuck roast, Hamburger patty <b>Lamb</b> Chops (25.4 mm thick), Rolled roast <b>Pork</b> Chops (12.7 mm thick), Hot dogs, Spareribs, Country-style ribs. Rolled roast, Sausage <b>Veal</b> Cutlets (0.5 kg, 12.7 mm thick)
<i>DEF 2</i> <b>POULTRY</b>	<b>Poultry</b> Whole (under 4.0 kg.), Cut-up, Breast (boneless) <b>Cornish Hens</b> Whole <b>Turkey</b> Breast
<i>DEF 3</i> <b>FISH</b>	<b>Steaks/Chops</b> Round beef steak, Tenderloin steak Lamb chops (25.4 mm thick) Pork chops (12.7 mm thick) Veal cutlets (0.5 kg, 1/2 inch thick) <b>Fish</b> Fillets, Whole Steaks <b>Shellfish</b> Crab meat, Lobster tails, Shrimp, Scallops

# OPERATING INSTRUCTIONS

## HEATING OR REHEATING GUIDE

To heat or reheat successfully in the microwave, it is important to follow several guidelines. Measure the amount of food in order to determine the time needed to reheat. Arrange the food in a circular pattern for best results. Room temperature food will heat faster than refrigerated food. Canned foods should be taken out of the can and placed in a microwavable container. The food will be heated more evenly if covered with a microwavable lid or plastic wrap and vented. Remove cover carefully to prevent steam burns. Use the following chart as a guide for reheating cooked food.

Items	Cook time (at HIGH)	Special Instructions
Sliced meat 3 slices (0.5 cm thick)	1-2 minutes	Place sliced meat on microwavable plate. Cover with plastic wrap and vent. *Note: Gravy or sauce helps to keep meat juicy.
Chicken pieces 1 breast 1 leg and thigh	2-3 minutes 3-3½ minutes	Place chicken pieces on microwavable plate. Cover with plastic wrap and vent.
Fish fillet (230 g)	1-2 minutes	Place fish on microwavable plate. Cover with plastic wrap and vent.
Lasagna 1 serving (300 g)	4-6 minutes	Place lasagna on microwavable plate. Cover with plastic wrap and vent.
Casserole 1 cup 4 cups	1½ -3 minutes 4½ -7 minutes	COOK covered in microwavable casserole. Stir once halfway through cooking.
Casserole – cream or cheese 1 cup 4 cups	1-2½ minutes 3½-6 minutes	COOK covered in microwavable casserole. Stir once halfway through cooking.
Sloppy Joe or Barbecued beef 1 sandwich (½ cup meat filling) without bun	1 -2½ minutes	Reheat filling and bun separately. Cook filling covered in microwavable casserole. Stir once. Heat bun as directed in chart below.
Mashed potatoes 1 cup 4 cups	1½ -3½ minutes 6-9 minutes	COOK covered in microwavable casserole. Stir once halfway through cooking.
Baked beans 1 cup	1½-3 minutes	COOK covered in microwavable casserole. Stir once halfway through cooking.
Ravioli or pasta in sauce 1 cup 4 cups	2½-4 minutes 7½-11 minutes	COOK covered in microwavable casserole. Stir once halfway through cooking.
Rice 1 cup 4 cups	1 -1½ minutes 3½-5 minutes	COOK covered in microwavable casserole. Stir once halfway through cooking.
Sandwich roll or bun 1 roll	15-30 seconds	Wrap in paper towel and place on glass microwavable rack
Vegetables 1 cup 4 cups	1½-2½ minutes 4-6 minutes	COOK covered in microwavable casserole. Stir once halfway through cooking.
Soup 1 serving (230 g)	1½-2 minutes	COOK covered in microwavable casserole. Stir once halfway through cooking.

# OPERATING INSTRUCTIONS

## FRESH VEGETABLE GUIDE

Vegetable	Amount	Cook time at HIGH	Instructions	Standing Time
Artichokes (230 g each)	2 medium 4 medium	4½~7 10~12	Trim. Add 2 tsp water and 2 tsp juice. Cover.	2-3 minutes
Asparagus, Fresh, Spears	450 g	2½~6	Add 1 cup water. Cover.	2-3 minutes
Beans, Green & Wax	450 g	7~11	Add ½ cup water in 1½ qt. casserole. Stir halfway through cooking.	2-3 minutes
Beets, Fresh	450 g	11~16	Add ½ cup water in 1½ qt. covered casserole. Rearrange halfway through cooking.	2-3 minutes
Broccoli, Fresh, Spears	450 g	5~8	Place broccoli in baking dish. Add ½ cup water.	2-3 minutes
Cabbage, Fresh, Chopped	450 g	4~7	Add ½ cup water in 1½ qt. covered casserole. Stir halfway through cooking.	2-3 minutes
Carrots, Fresh, Sliced	2 cups	2~3	Add ¼ cup water in 1 qt. covered casserole. Stir halfway through cooking.	2-3 minutes
Cauliflower, Fresh, Whole	450 g	5~7	Trim. Add ¼ cup water in 1 qt. covered casserole. Stir halfway through cooking.	2-3 minutes
Flowerettes, Fresh	2 cups	2½~4½	Slice. Add ½ cup water in 1½ qt. covered casserole.	2-3 minutes
Celery, Fresh, Sliced	4 cups	6~8	Stir halfway through cooking.	
Corn, Fresh	2 ears	4~8	Husk. Add 2 tbsp water in 1½ qt. baking dish. Cover.	2-3 minutes
Mushrooms, Fresh, Sliced	230 g	2½~3½	Place mushrooms in 1½ qt. covered casserole. Stir halfway through cooking.	2-3 minutes
Parsnips, Fresh, Sliced	450 g	4~7	Add ½ cup water in 1½ qt. covered casserole. Stir halfway through cooking.	2-3 minutes
Peas, Green, Fresh	4 cups	6~9	Add ½ cup water in 1½ qt. covered casserole. Stir halfway through cooking.	2-3 minutes
Sweet Potatoes Whole Baking (170~230 g each)	2 medium 4 medium	4~9 6~12	Pierce potatoes several times with fork. Place on 2 paper towels. Turn over halfway through cooking.	2-3 minutes 2-3 minutes
White Potatoes, Whole Baking (170~230 g each)	2 potatoes 4 potatoes	5~8 10~14	Pierce potatoes several times with fork. Place on 2 paper towels. Turn over halfway through cooking.	2-3 minutes 2-3 minutes
Spinach, Fresh, Leaf	450 g	4~7	Add ½ cup water in 2 qt. covered casserole.	2-3 minutes
Squash, Acorn or Butternut, Fresh	1 medium	6~8	Cut squash in half. Remove seeds. Place in 8 x 8-inch baking dish. Cover.	2-3 minutes
Zucchini, Fresh, Sliced	450 g	4½~7½	Add ½ cup water in 1½ qt. covered casserole. Stir halfway through cooking.	2-3 minutes
Zucchini, Fresh, Whole	450 g	6~9	Pierce. Place on 2 paper towels. Turn zucchini over and rearrange halfway through cooking.	2-3 minutes



# MICROWAVE-SAFE UTENSILS

## **Never use metal or metal trimmed utensils in your microwave oven**

Microwaves cannot penetrate metal. They will bounce off any metal object in the oven and cause arcing, an alarming phenomenon that resembles lightning.

Most heat resistant non metallic cooking utensils are safe for use in your microwave oven.

However, some may contain materials that render them unsuitable as microwave cookware. If you have any doubts about a particular utensil, there's a simple way to find out if it can be used in your microwave oven.

Place the utensil in question next to a glass bowl filled with water in the microwave oven.

Microwave at power HIGH for 1 minute. If the water heats up but the utensil remains cool to the touch, the utensil is microwave-safe. However, if the water does not change temperature but the utensil becomes warm, microwaves are being absorbed by the utensil and it is not safe for use in the microwave oven. You probably have many items on hand in your kitchen right now that can be used as cooking equipment in your microwave oven. Just read through the following checklist.

### **Dinner plates**

Many kinds of dinner-ware are microwave-safe. If in doubt consult the manufacturer's literature or perform the microwave test.

### **Glassware**

Glassware that is heat-resistant is microwave-safe. This would include all brands of oven tempered glass cookware. However, do not use delicate glassware, such as tumblers or wine glasses, as these might shatter as the food warms.

### **Plastic storage containers**

These can be used to hold foods that are to be quickly reheated. However, they should not be used to hold foods that will need considerable time in the oven as hot foods will eventually warp or melt plastic containers.

### **Paper**

Paper plates and containers are convenient and safe to use in your microwave oven, provided that the cooking time is short and foods to be cooked are low in fat and moisture. Paper towels are also very useful for wrapping foods and for lining baking trays in which greasy foods such as bacon are cooked. In general, avoid colored paper products as the colour may run. Some recycled paper products may contain impurities which could cause arcing or fires when used in the microwave oven.

### **Plastic cooking bags**

Provided they are made specially for cooking, cooking bags are microwave safe. However, be sure to make a slit in the bag so that steam can escape. Never use ordinary plastic bags for cooking in your microwave oven, as they will melt and rupture.

### **Plastic microwave cookware**

A variety of shapes and sizes of microwave cookware are available. For the most part, you can probably use items you already have on hand rather than investing in new kitchen equipment.

### **Pottery, stoneware and ceramic**

Containers made of these materials are usually fine for use in your microwave oven, but they should be tested to be sure.

## **CAUTION**

**Some items with high lead or iron content are not suitable for cooking utensils.**

**Dinner plates or cups that have painted finishes should not be used in the microwave as the decorative paint will cause arching and damage to the paint's finish if the paint is metallic based.**

# FOOD CHARACTERISTICS & MICROWAVE COOKING

## Keeping an eye on things

The recipes in this book have been formulated with great care, but your success in preparing them depends on how much attention you pay to the food as it cooks. Always watch your food while it cooks. Your microwave oven is equipped with a light that turns on automatically when the oven is in operation so that you can see inside and check the progress of your food. Directions given in recipes to elevate, stir, and the like should be thought of as the minimum steps recommended. If the food seems to be cooking unevenly, simply make the necessary adjustments you think appropriate to correct the problem.

## Factors affecting microwave cooking times

Many factors affect cooking times. The temperature of ingredients used in a recipe makes a big difference in cooking times. For example, a cake made with ice-cold butter, milk, and eggs will take considerably longer to bake than one made with ingredients that are at room temperature. All of the recipes in this book give a range of cooking times. In general, you will find that the food remains under-cooked at the lower end of the time range, and you may sometimes want to cook your food beyond the maximum time given, according to personal preference. The governing philosophy of this book is that it is best for a recipe to be conservative in giving cooking times. While overcooked food is ruined for good. Some of the recipes, particularly those for bread, cake, and custards, recommend that food be removed from the oven when they are slightly undercooked. This is not a mistake. When allowed to stand, usually covered, these foods will continue to cook outside of the oven as the heat trapped within the outer portions of the food gradually travels inward. If the food is left in the oven until it is cooked all the way through, the outer portions will become overcooked or even burnt. You will become increasingly skilful in estimating both cooking and standing times for various foods.

## Density of food

Light, porous food such as cakes and bread cook more quickly than heavy, dense foods such as roasts and casseroles. You must take care when microwaving porous food that the outer edges do not become dry and brittle.

## Height of food

The upper portion of tall food, particularly roasts, will cook more quickly than the lower portion. Therefore, it is wise to turn tall food during cooking, sometimes several times.

## Moisture content of food

Since the heat generated from microwaves tends to evaporate moisture, relatively dry food such as roasts and some vegetables should either be sprinkled with water prior to cooking or covered to retain moisture.

## Bone and fat content of food

Bones conduct heat and fat cooks more quickly than meat. Care must be taken when cooking bony or fatty cuts of meat that they do not cook unevenly and do not become overcooked.

## Quantity of food

The number of microwaves in your oven remains constant regardless of how much food is being cooked. Therefore, the more food you place in the oven, the longer the cooking time. Remember to decrease cooking times by at least one third when halving a recipe.

## Shape of food

Microwaves penetrate only about 2.5 cm into food, the interior portion of thick foods are cooked as the heat generated on the outside travels inward. Only the outer edge of food is cooked by microwave energy; the rest is cooked by conduction. The worst possible shape for a food that is to be microwaved is a thick square. The corners will burn long before the centre is even warm. Round thin foods and ring shaped foods cook successfully in the microwave.

## Covering

A cover traps heat and steam which causes food to cook more quickly. Use a lid or microwave cling film with a corner folded back to prevent splitting.

## Browning

Meats and poultry that are cooked fifteen minutes or longer will brown lightly in their own fat. Food that is cooked for a shorter period of time may be brushed with a browning sauce such as Worcestershire sauce, soy sauce or barbecue sauce to achieve an appetizing colour. Since relatively small amounts of browning sauce is added to food, the original flavour of the recipe is not altered.

## Covering with greaseproof paper

Greaseproofing effectively prevents spattering and helps food retain some heat. But because it makes a looser cover than a lid or clingfilm, it allows the food to dry out slightly.

## Arranging and spacing

Individual foods such as baked potatoes, small cakes and hors d'oeuvres will heat more evenly if placed in the oven an equal distance apart, preferably in a circular pattern. Never stack foods on top of one another.

# FOOD CHARACTERISTICS & MICROWAVE COOKING

## Stirring

Stirring is one of the most important of all microwaving techniques. In conventional cooking, food is stirred for the purpose of blending.

Microwaved food, however, is stirred in order to spread and redistribute heat. Always stir from the outside towards the centre as the outside of the food heats first.

## Turning over

Large, tall foods such as roasts and whole chickens should be turned so that the top and bottom will cook evenly. It is also a good idea to turn cut up chicken and chops.

## Placing thicker portions facing outwards

Since microwaves are attracted to the outside portion of food, it makes sense to place thicker portions of meat, poultry and fish to the outer edge of the baking dish. This way, thicker portions will receive the most microwave energy and the food will cook evenly.

## Shielding

Strips of aluminium foil (which block microwaves) can be placed over the corners or edges of square and rectangular food to prevent those portions from overcooking. Never use too much foil and make sure the foil is secured to the dish or it may cause 'arcing' in the oven.

## Elevating

Thick or dense foods can be elevated so that microwaves can be absorbed by the underside and centre of the foods.

## Piercing

Foods enclosed in a shell, skin or membrane are likely to burst in the oven unless they are pierced prior to cooking. Such foods include yolks and whites of eggs, clams and oysters and whole vegetables and fruits.

## Testing if cooked

Food cooks so quickly in a microwave oven, it is necessary to test it frequently. Some foods are left in the microwave until completely cooked, but most foods, including meats and poultry, are removed from the oven while still slightly undercooked and allowed to finish cooking during standing time. The internal temperature of foods will rise between 3°C and 8°C during standing time.

## Standing time

Foods are often allowed to stand for 3 to 10 minutes after being removed from the microwave oven. Usually the foods are covered during standing time to retain heat unless they are supposed to be dry in texture (some cakes and biscuits, for example). Standing allows foods to finish cooking and also helps flavour blend and develop.

## To Clean Your Oven

### 1 Keep the inside of the oven clean

Food spatters or spilled liquids stick to oven walls and between seal and door surface. It is best to wipe up spillovers with a damp cloth right away. Crumbs and spillovers will absorb microwave energy and lengthen cooking times. Use a damp cloth to wipe out crumbs that fall between the door and the frame. It is important to keep this area clean to assure a tight seal. Remove greasy spatters with a soapy cloth then rinse and dry. Do not use harsh detergent or abrasive cleaners. The glass tray can be washed by hand or in the dishwasher.

### 2 Keep the outside of the oven clean

Clean the outside of your oven with soap and water then with clean water and dry with a soft cloth or paper towel. To prevent damage to the operating parts inside the oven, the water should not be allowed to seep into the ventilation openings. To clean control panel, open the door to prevent oven from accidentally starting, and then wipe the control panel with a damp cloth, followed immediately by a dry, Press STOP after cleaning.

3 If steam accumulates inside or around the outside of the oven door, wipe the panels with a soft cloth. This may occur when the microwave oven is operated under high humidity conditions and in no way indicates a malfunction of the unit.

4 The door and door seals should be kept clean. Use only warm, soapy water, rinse then dry thoroughly.

**DO NOT USE ABRASIVE MATERIALS, SUCH AS CLEANING POWDERS OR STEEL AND PLASTIC PADS.**

Metal parts will be easier to maintain if wiped frequently with a damp cloth.

# SAFETY PRECAUTIONS<sup>19</sup>

## WARNING

*Please ensure cooking times are correctly set as over cooking may result in FIRE and subsequent DAMAGE to the OVEN.*

- 1 Do not attempt to tamper with, or make any adjustments or repairs to the door, control panel, safety interlock switches or any other part of the oven. Repairs should only be undertaken by a qualified service technician.
- 2 Do not operate the oven when empty. It is best to leave a glass of water in the oven when not in use. The water will safely absorb all microwave energy, if the oven is accidentally started.
- 3 Do not use the oven for the purpose of dehumidification. It can be the cause of serious damage of safety. (ex. Operating the microwave oven with the wet newspapers, clothes, toys, pet or portable electric devices, etc.)
- 4 Do not cook food wrapped in paper towels, unless your cook book contains instructions, for the food you are cooking.
- 5 Do not use newspaper in place of paper towels for cooking.
- 6 Do not use wooden containers. They may heat-up and char. Do not use ceramic containers which have metallic (e.g. gold or silver) inlays. Always remove metal twist ties. Metal objects in the oven may arc, which can cause serious damage.
- 7 Do not operate the oven with a kitchen towel, a napkin or any other obstruction between the door and the front edges of the oven, which may cause microwave energy leakage.
- 8 Do not use recycled paper products since they may contain impurities which may cause sparks and/or fires when used in cooking.
- 9 Do not rinse the turntable by placing it in water just after cooking. This may cause breakage or damage.
- 10 Small amounts of food require shorter cooking or heating time. If normal times are allowed they may overheat and burn.
- 11 Be certain to place the oven so the front of the door is 8 cm or more behind the edge of the surface on which it is placed, to avoid accidental tipping of the appliance.
- 12 Before cooking, pierce the skin of potatoes, apples or any such fruit or vegetable.
- 13 Do not cook eggs in their shell. Pressure will build up inside the egg which will burst.
- 14 Do not attempt deep fat frying in your oven.
- 15 Remove the plastic wrapping from food before cooking or defrosting. Note though that in some cases food should be covered with plastic film, for heating or cooking.
- 16 If the oven door is damaged, the oven must not be operated until it has been repaired by a qualified service technician.
- 17 If smoke is observed, keep the oven door closed and switch off or disconnect the oven from the power supply.
- 18 When food is heated or cooked in disposable containers of plastic, paper or other combustible materials look at the oven frequently to check if the food container is deteriorating.
- 19 The appliance is not intended for use by young children or infirm persons without supervision; Young Children should be supervised to ensure that they do not play with appliance.
- 20 Liquids or other foods must not be heated in sealed containers since they are liable to explode.
- 21 If the appliance is supplied from a cord extension set or an electrical portable outlet device, the cord extension set on electrical portable outlet device must be positioned so that it is not subject to splashing or ingress of moisture.
- 22 It is hazardous for anyone other than a competent person to carry out any service or repair operation that involves the removal of a cover which gives protection against exposure to microwave energy.
- 23 Only allow children to use the oven without supervision when adequate instructions have been given so that the child is able to use the oven in a safe way and understands the hazards of improper use.
- 24 The oven should be cleaned regularly and any food deposits removed.

# SAFETY PRECAUTIONS

## WARNING

*Please ensure cooking times are correctly set as over cooking may result in FIRE and subsequent DAMAGE to the OVEN.*

- 25 Failure to maintain the oven in a clean condition could lead to deterioration of the surface that could adversely affect the life of the appliance and possibly result in a hazardous situation.
- 26 If the supply cord is damaged, it must be replaced by the manufacturer, its service agent or similarly qualified persons in order to avoid a hazard.
- 27 This appliance is not intended for use by persons (including children) with reduced physical, sensory or mental capabilities, or lack of experience and knowledge, unless they have been given supervision or instruction concerning use of the appliance by a person responsible for their safety.
- 28 only use utensils that are suitable for use in microwave ovens
- 2J The microwave oven shall be used freestanding.
- HE **WARNING:** Accessible parts may become hot during use. To avoid burns young children should be kept away.

## QUESTION & ANSWERS

### Q What's wrong when the oven light will not glow?

- A There may be several reasons why the oven light will not glow.  
Light bulb has blown.  
Door is not closed.

### Q Does microwave energy pass through the viewing screen in the door?

- A No. The holes, or ports, are made to allow light to pass; they do not let microwave energy through.

### Q Why does the beep tone sound when a pad on the Control Panel is touched?

- A The beep tone sounds to assure that the setting is being properly entered.

### Q Will the microwave oven be damaged if it operates empty?

- A Yes. Never run it empty or without the glass tray.

### Q Why do eggs sometimes pop?

- A When baking, frying, or poaching eggs, the yolk may pop due to steam build up inside the yolk membrane. To prevent this, simply pierce the yolk before cooking. Never microwave eggs in the shell.

### Q Why is standing time recommended after microwave cooking is over?

- A After microwave cooking is finished, food keeps on cooking during standing time. This standing time finishes cooking evenly throughout the food. The amount of standing time depends on the density of the food.

### Q Is it possible to pop corn in a microwave oven?

- A Yes, if using one of the two methods described below:

- 1 Popcorn-popping utensils designed specifically for microwave cooking.
- 2 Prepackaged microwave popcorn that contains specific times and power outputs needed for an acceptable final product.

FOLLOW EXACT DIRECTIONS GIVEN BY EACH MANUFACTURER FOR THEIR POPCORN PRODUCT. DO NOT LEAVE THE OVEN UNATTENDED WHILE THE CORN IS BEING POPPED. IF CORN FAILS TO POP AFTER THE SUGGESTED TIMES, DISCONTINUE COOKING. OVERCOOKING COULD RESULT IN THE CORN CATCHING FIRE.

## CAUTION

NEVER USE A BROWN PAPER BAG FOR POPPING CORN. NEVER ATTEMPT TO POP LEFTOVER KERNELS.

### Q Why doesn't my oven always cook as fast as the cooking guide says?

- A Check your cooking guide again to make sure you've followed directions correctly, and to see what might cause variations in cooking time. Cooking guide times and heat settings are suggestions, chosen to help prevent overcooking, the most common problem in getting used to a microwave oven. Variations in the size, shape, weight and dimensions of the food require longer cooking time. Use your own judgement along with the cooking guide suggestions to test food condition, just as you would do with a conventional cooker.

## PLUG WIRING INFORMATION

### Warning

This appliance must be earthed

The wires in this mains lead are colored in accordance with the following codes  
BLUE ~ Neutral  
BROWN ~ Live  
GREEN & YELLOW ~ Earth

## TECHNICAL SPECIFICATIONS

MODEL	MS2548GR / MS2548XR
Power Supply	230 / 240 V~ 50 Hz
Rated Power Consumption	1250 W
Microwave Output	*850 W
Frequency	2450 MHz
Overall Dimensions(WXHXD)	510 X 302X 408(mm)
Oven Cavity Dimensions(WXHXD)	330 X 205X 340(mm)
NET WEIGHT	14 Kg
SHIPPING WEIGHT	16 Kg

\*IEC 60705 RATING STANDARD

Specifications subject to change without prior notice.





## LGEAP

FOR **CUSTOMER SERVICE** PLEASE CONTACT  
LG SERVICE ON 1300 LG CARE (1300 54 2273) AUSTRALIA,  
OR 0800 LG CARE (0800 54 2273) NEW ZEALAND.

LG Electronics Australia  
2 Wonderland Drive  
Eastern Creek NSW 2766  
(ABN: 98 064 531 264)

### LG Customer Information Centre

All Product related queries or questions  
Please contact

Toll free number  
AUSTRALIA **1300 54 2273**  
NEW ZEALAND **0800 54 2273**

Customer Service Website:  
<http://au.lgservice.com>

Please refer to the owner's manual for  
connection and operation related issues,  
prior to contacting customer  
information centre.