

LCD TV | PLASMA TV OWNER'S MANUAL

LCD TV MODELS

19LS4D* 32LG30**
 22LS4D* 32LG32**
 32LG20** 37LG30**
 37LG20** 42LG30**
 42LG20** 42LG32**
 19LG30** 32LG5***
 22LG30** 37LG50**
 26LG30** 42LG50**
 47LG50**
 52LG50**

PLASMA TV MODELS

42PG10**
 50PG10**
 42PG20**
 50PG20**
 42PG30**
 50PG30**
 60PG30**



Trade Mark of the DVB Digital Video Broadcasting Project (1991 to 1996)

- | | |
|--------------------------------------|-------------------|
| ID Number(s): 5499: 22LS4D-ZD | 5507: 19LS4D-ZD |
| 5107: 42PG1000-ZA | 5106: 50PG1000-ZA |
| 5568: 42PG2000-ZA | 5569: 50PG2000-ZA |
| 5109: 42PG3000-ZA | 5108: 50PG3000-ZA |
| 5498: 60PG3000-ZA | 5629: 32LG2000-ZA |
| 5630: 37LG2000-ZA | 5631: 42LG2000-ZA |
| 5088: 19LG3000-ZA | 5090: 22LG3000-ZA |
| 5080: 26LG3000-ZA | 5089: 32LG3000-ZA |
| 5087: 37LG3000-ZA | 5086: 42LG3000-ZA |
| 5085: 32LG5000-ZA | 5084: 37LG5000-ZA |
| 5083: 42LG5000-ZA | 5082: 47LG5000-ZA |
| 5081: 52LG5000-ZA | 5385: 52LG5010-ZD |
| 5386: 47LG5010-ZD | 5387: 42LG5010-ZD |
| 5388: 37LG5010-ZD | 5389: 32LG5010-ZD |
| 5390: 52LG5020-ZB | 5391: 47LG5020-ZB |
| 5392: 42LG5020-ZB | 5393: 37LG5020-ZB |
| 5394: 32LG5020-ZB | 5395: 52LG5030-ZE |
| 5396: 47LG5030-ZE | 5397: 42LG5030-ZE |
| 5398: 37LG5030-ZE | 5399: 32LG5030-ZE |
| 5671: 32LG5700-ZF | 5721: 26LG3050-ZA |
| 5820: 19LG3050-ZA | 5818: 22LG3050-ZA |
| 5879: 19LG3060-ZB | 5880: 22LG3060-ZB |
| 5878: 32LG5600-ZB | 6507: 32LG3200-ZA |
| 6511: 42LG3200-ZA | |

Please read this manual carefully before operating your TV.

Retain it for future reference.

Record model number and serial number of the TV. Refer to the label on the back cover and quote this information.

To your dealer when requiring service.



This product qualifies for ENERGY STAR in the "factory default (Home mode)" setting and this is the setting in which power savings will be achieved.

Changing the factory default picture setting or enabling other features will increase power consumption that could exceed the limits necessary to qualify for Energy Star rating. (Plasma TV only)

ACCESSORIES

Ensure that the following accessories are included with your TV. If an accessory is missing, please contact the dealer where you purchased the TV.

■ Image shown may differ from your TV.

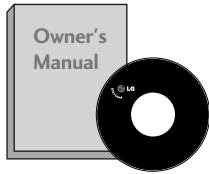

Owner's Manual



Batteries

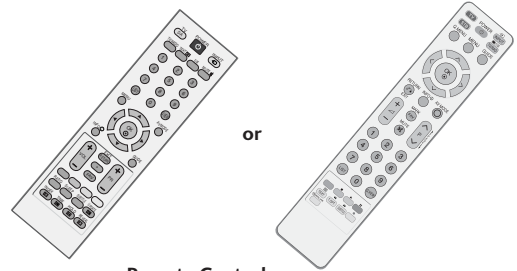

Remote Control

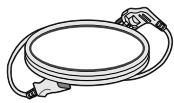

Power Cord

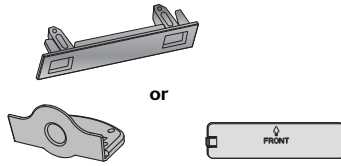

Protection Cover
(Except for 19/22LS4D*)

This feature is not available for all models.



Polishing Cloth

Polishing cloth for use on the screen.

Lightly wipe any stains or fingerprints on the surface of the TV with the polishing cloth.

Do not use excessive force. This may cause scratching or discolouration.

PLASMA TV models

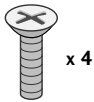

x 4

Bolts for stand assembly
(Refer to p.11)
(Only 42PG10**, 42PG20**, 42PG30**)



Cable Holder
(42PG10**, 42PG20**, 42PG30**): 1EA, 50PG10**, 50PG20**, 50/60PG30**): 2EA)

(Only 42/50PG10**)



Cable management clip

(Only 42/50PG20**, 42/50/60PG30**)

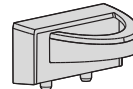

Ferrite Core
(This feature is not available for all models.)

LCD TV models

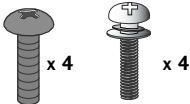

x 4

Bolts for stand assembly
(Refer to p.10)
(Only 32/37/42LG5***, 32/37/42LG20**, 32/42LG32**, 26/32/37/42LG30**)



1-screw for stand fixing
(Refer to p.5)
(Only 32/37/42LG20**, 32/42LG32**, 26/32/37/42LG30**, 32/37/42LG5***)



Cable management clip
(Only 19/22LS4D*)



Cable management clip
(Only 19/22LG30**)

Use of ferrite core (This feature is not available for all models.)

Ferrite core can be used to reduce the electromagnetic wave when connecting the power cord. The closer the location of the ferrite core to the power plug, the better it is.

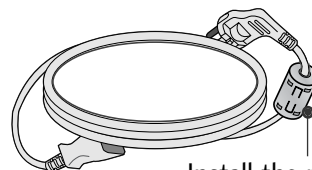

Install the power plug closely.

CONTENTS

ACCESSORIES 1

PREPARATION

Front Panel Controls	4
Back Panel Information	7
Stand Installation	10
Detaching Stand	13
Please set it up carefully so the product does not fall over	14
Back Cover for Wire Arrangement	15
Positioning Your Display	18
Location	18
Kensington Security System	18
Desktop Pedestal Installation	19
Wall Mount: Horizontal Installation	19
Antenna Connection	20

EXTERNAL EQUIPMENT SETUP

HD Receiver Setup	21
Digital Audio out Setup	22
DVD Setup	23
VCR Setup	25
Other A/V Source Setup	27
Insertion of CI Module	28
PC Setup	28
- Screen Setup for PC Mode	32

WATCHING TV / PROGRAMME CONTROL

Remote Control Key Functions	36
Turning on the TV	42
Programme Selection	42
Volume Adjustment	42
On-Screen Menus Selection and Adjustment	43
Auto Programme Tuning	44
Manual Programme Tuning (In Digital Mode)	45
Manual Programme Tuning (In Analogue Mode) ..	46
Programme Edit	48
Booster	51

Software Update	52
Diagnostics	53
CI Information	54
Selecting the Programme Table	55
SIMPLINK	56
Input Label	58
AV Mode	59

EPG (ELECTRONIC PROGRAMME GUIDE) (IN DIGITAL MODE)

Switch On/ Off EPG	60
Select Programme	60
Button Function in NOW/NEXT Guide Mode	61
Button Function in 8 Day Guide Mode	61
Button Function in Date Change Mode	61
Button Function in Extended Description Box	62
Button Function in Record/Remind Setting Mode ..	62
Button Function in Schedule List Mode	62

PICTURE CONTROL

Picture Size (Aspect Ratio) Control	63
Preset Picture Settings	
- Picture Mode-Preset	65
- Auto Colour Tone Control (Warm/Medium/Cool) ...	66
Manual Picture Adjustment	
- Picture Mode-User option	67
- Picture Mode-Expert Control	68
Picture Improvement Technology	69
Advanced - Film Mode	70
Advanced - Black(Darkness) Level	71
Eye Care	72
Picture Reset	73
Image Sticking Minimization (ISM) Method	74
Power Saving Picture Mode	75

SOUND & LANGUAGE CONTROL

Auto Volume Leveler	76
Preset Sound Settings - Sound Mode	77
Sound Setting Adjustment - User Mode	78
Balance	79
TV Speakers On/ Off Setup	80
Selecting Digital Audio Out	81
Audio Reset	82
I/II	
- Stereo/Dual Reception (In Analogue Mode Only)	83
- NICAM Reception (In Analogue Mode Only)	84
- Speaker Sound Output Selection	84
On-Screen Menu Language/Country Selection	85
Language selection (In Digital Mode only)	86

TIME SETTING

Clock Setup	87
Auto On/ Off Timer Setting	88
Auto Shut-off Setting	89
Time Zone Setup	90
Sleep Timer Setting	90

PARENTAL CONTROL / RATINGS

Set Password & Lock System	91
Block Programme	92
Parental Control	93
Key Lock	94

TELETEXT

Switch On/ Off	95
SIMPLE Text	95
TOP Text	95
FASTEXT	96
Special Teletext Functions	96

DIGITAL TELETEXT

Teletext within Digital Service	97
Teletext in Digital Service	97

APPENDIX

Initializing (Reset to original factory setting)	98
Troubleshooting	99
Maintenance	101
Product Specifications	102
Programming the Remote Control	105
IR Codes	107
External Control Device Setup	109

PREPARATION

FRONT PANEL CONTROLS

- Image shown may differ from your TV.
- If your TV has a protection film attached, remove the film and then wipe the TV with a polishing cloth.

PREPARATION

PLASMA TV Models : 42/50PG20**, 42/50/60PG30**

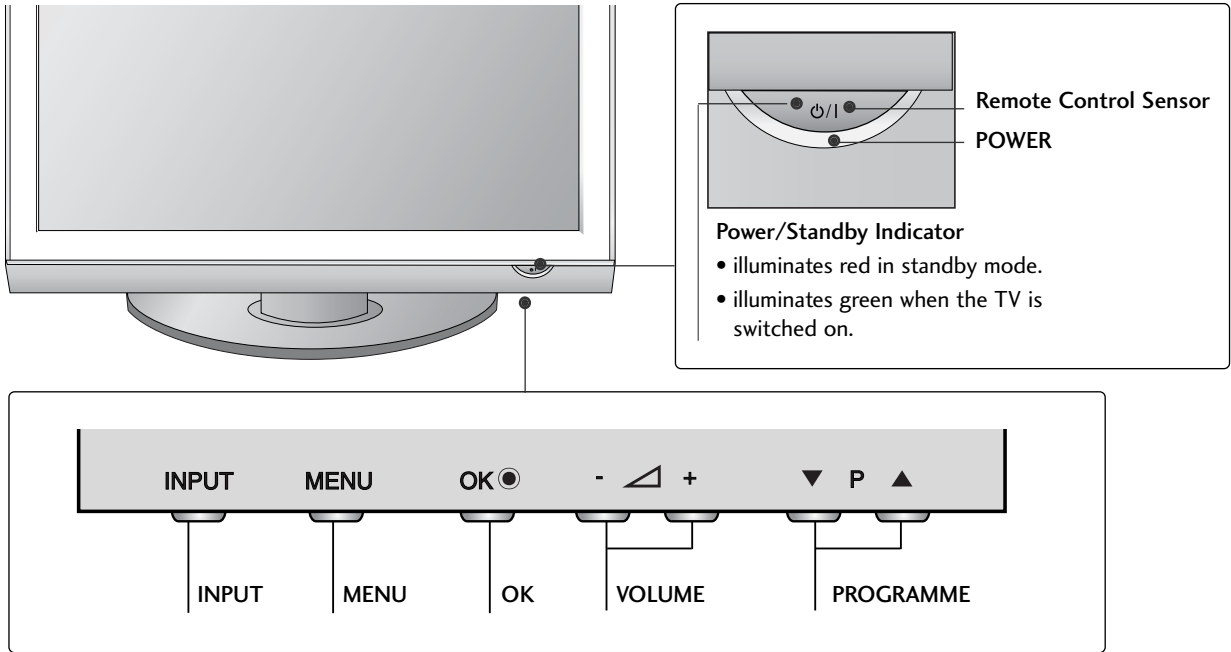

PLASMA TV Models : 42/50PG10**

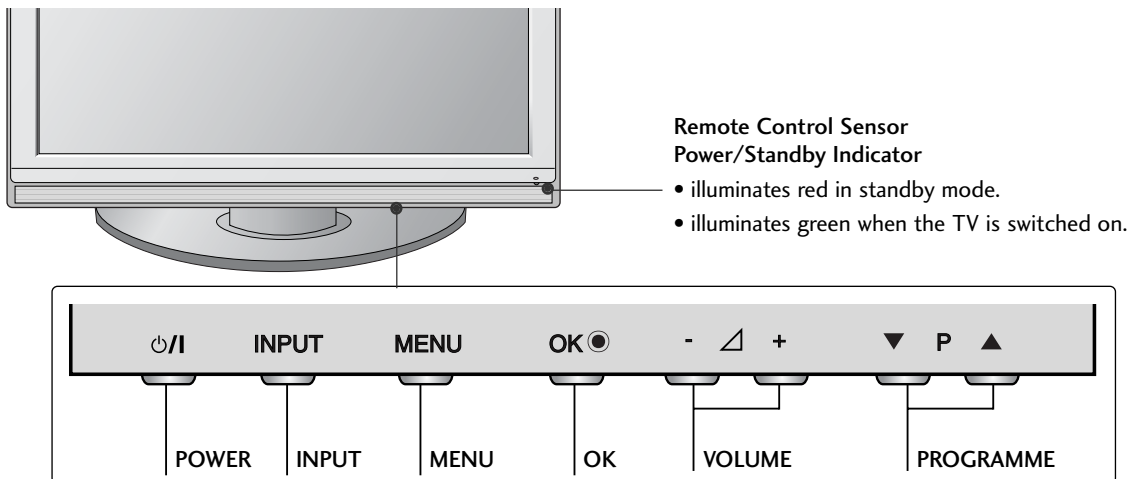

LCD TV Models :

32/37/42LG20, 26/32/37/42LG30**, 32/42LG32**, 32/37/42/47/52LG5*****

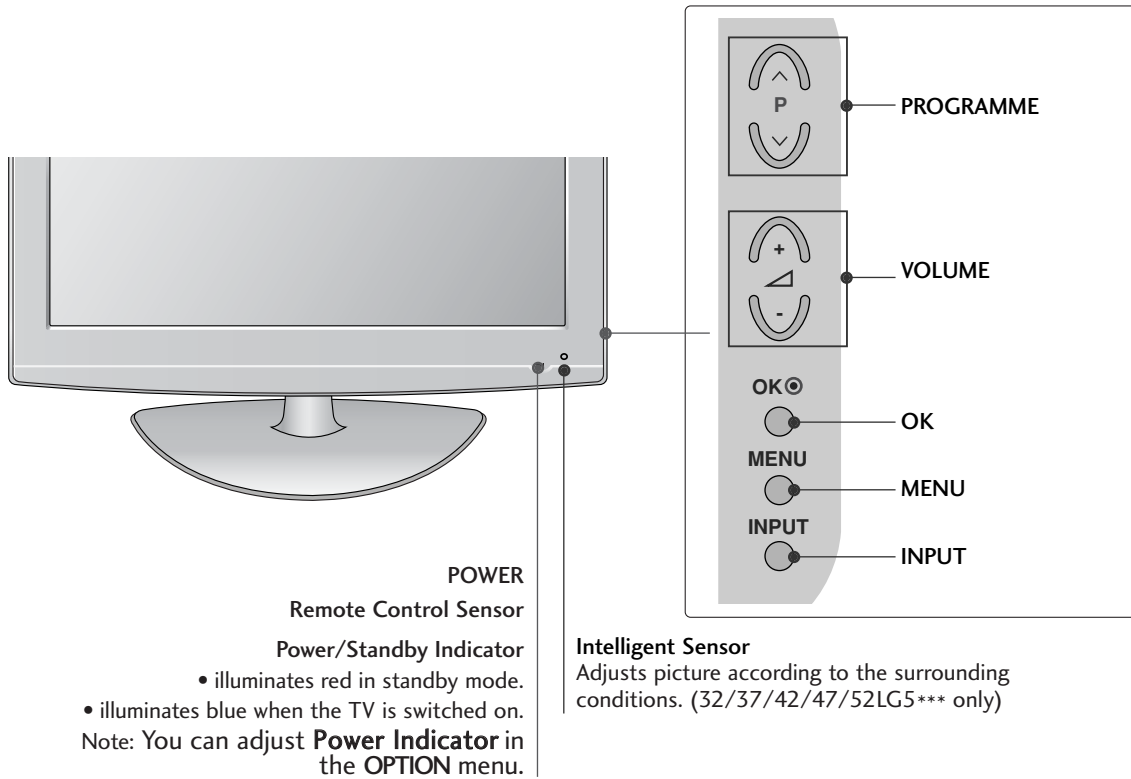

Attaching the TV to a desk (Only 32/37/42LG20, 26/32/37/42LG30**, 32/42LG32**, 32/37/42LG5***)**

The TV must be attached to desk so it cannot be pulled in a forward/backward direction, potentially causing injury or damaging the product. Use only an attached screw.

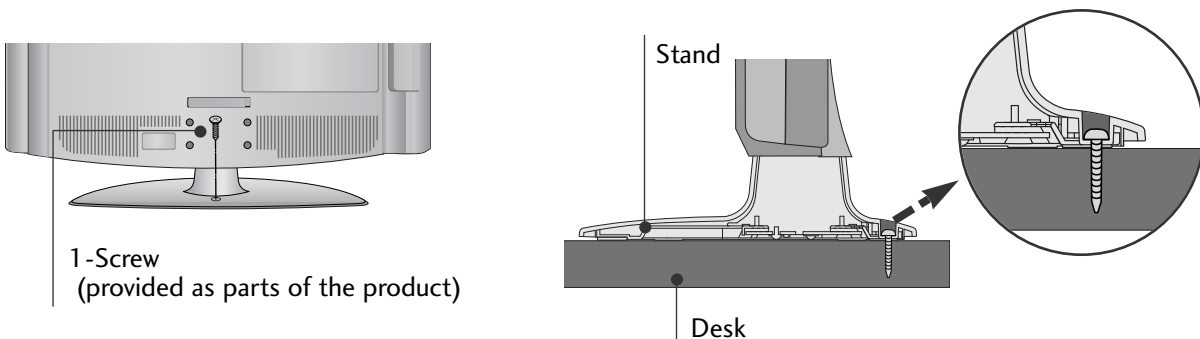

! WARNING

► To prevent TV from falling over, the TV should be securely attached to the floor/wall per installation instructions. Tipping, shaking, or rocking the machine may cause injury.

PREPARATION

LCD TV Models : 19/22LG30**

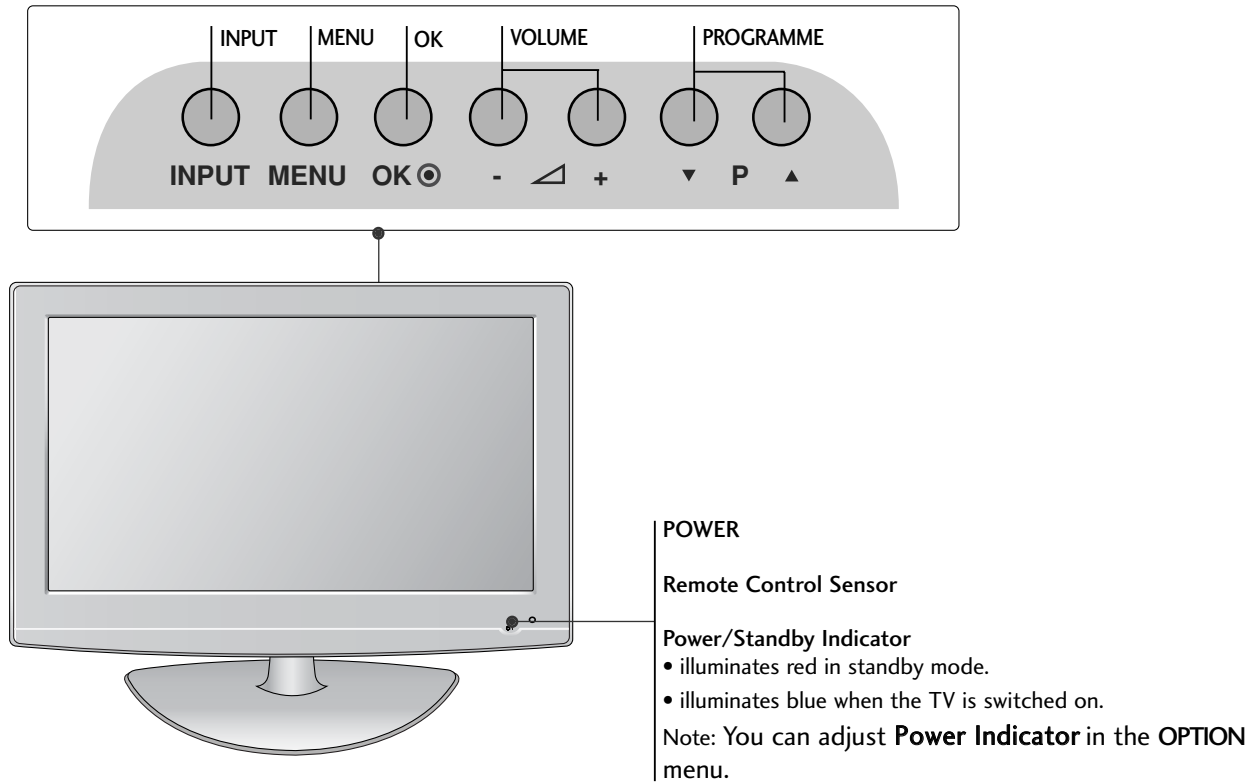

LCD TV Models : 19/22LS4D*

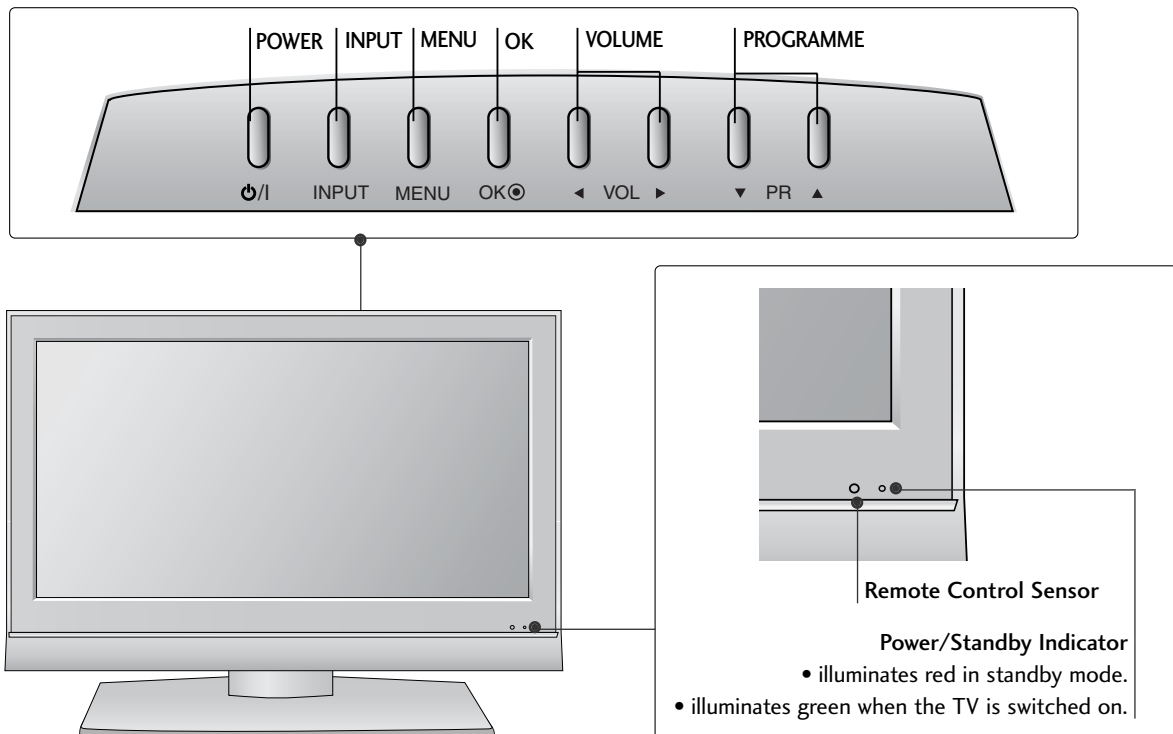

BACK PANEL INFORMATION

■ Image shown may differ from your TV.

PLASMA TV Models :

42/50PG10**, 42/50PG20**, 42/50/60PG30**

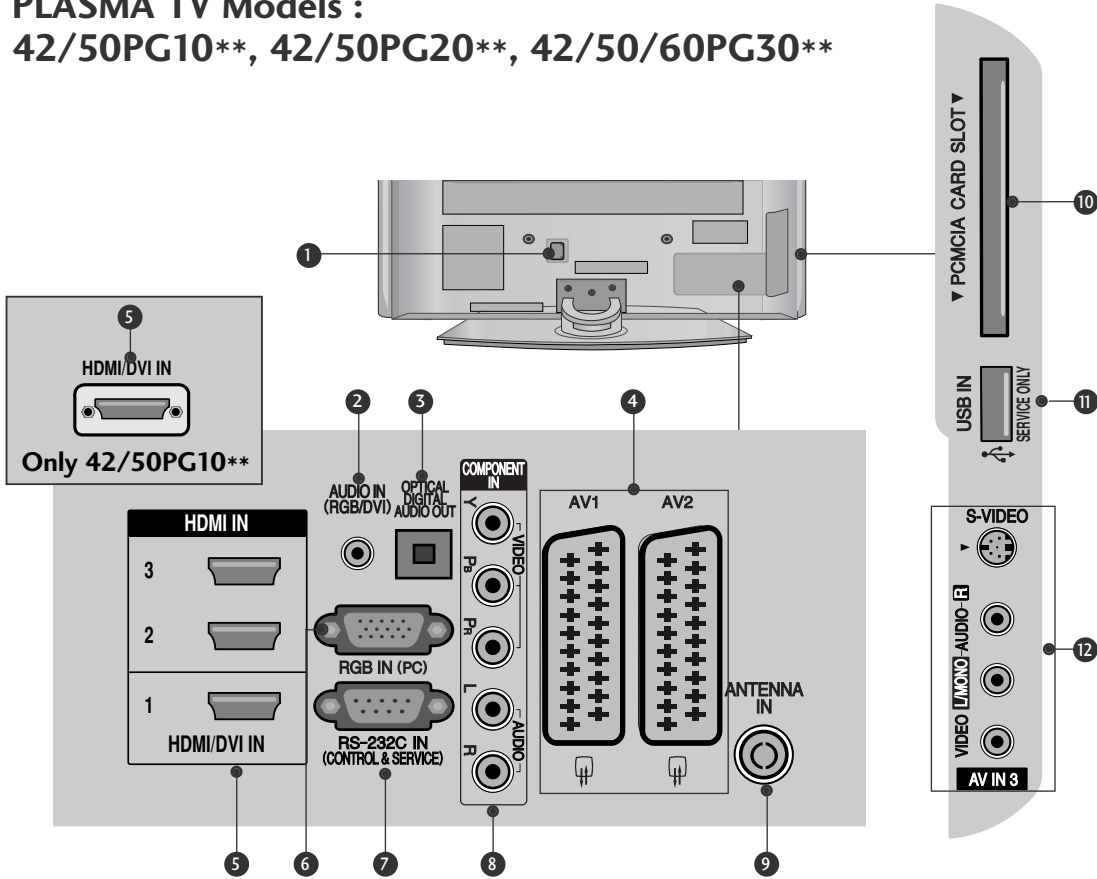

1 Power Cord Socket

This TV operates on an AC power. The voltage is indicated on the Specifications page. Never attempt to operate the TV on DC power.

2 RGB/DVI Audio Input

Connect the audio from a PC or DTV.

3 OPTICAL DIGITAL AUDIO OUT

Connect digital audio from various types of equipment. Note: In standby mode, these ports do not work.

4 Euro Scart Socket (AV1/AV2)

Connect scart socket input or output from an external device to these jacks.

5 HDMI Input

Connect a HDMI signal to HDMI IN. Or DVI (VIDEO) signal to HDMI/DVI port with DVI to HDMI cable.

6 RGB Input

Connect the output from a PC.

7 RS-232C IN (CONTROL & SERVICE) PORT

Connect to the RS-232C port on a PC.

8 Component Input

Connect a component video/audio device to these jacks.

9 Antenna Input

Connect RF antenna to this jack.

10 PCMCIA (Personal Computer Memory Card International Association) Card Slot

(This feature is not available in all countries.)

11 SERVICE ONLY PORT

12 Audio/Video Input (Except for 42/50PG10)**

Connect audio/video output from an external device to these jacks.

S-Video Input (Except for 42/50PG10**)

Connect S-Video out from an S-VIDEO device.

PREPARATION

LCD TV Models:

32/37/42LG20**, 19/22/26/32/37/42LG30**,
32/42LG32**, 32/37/42/47/52LG5***

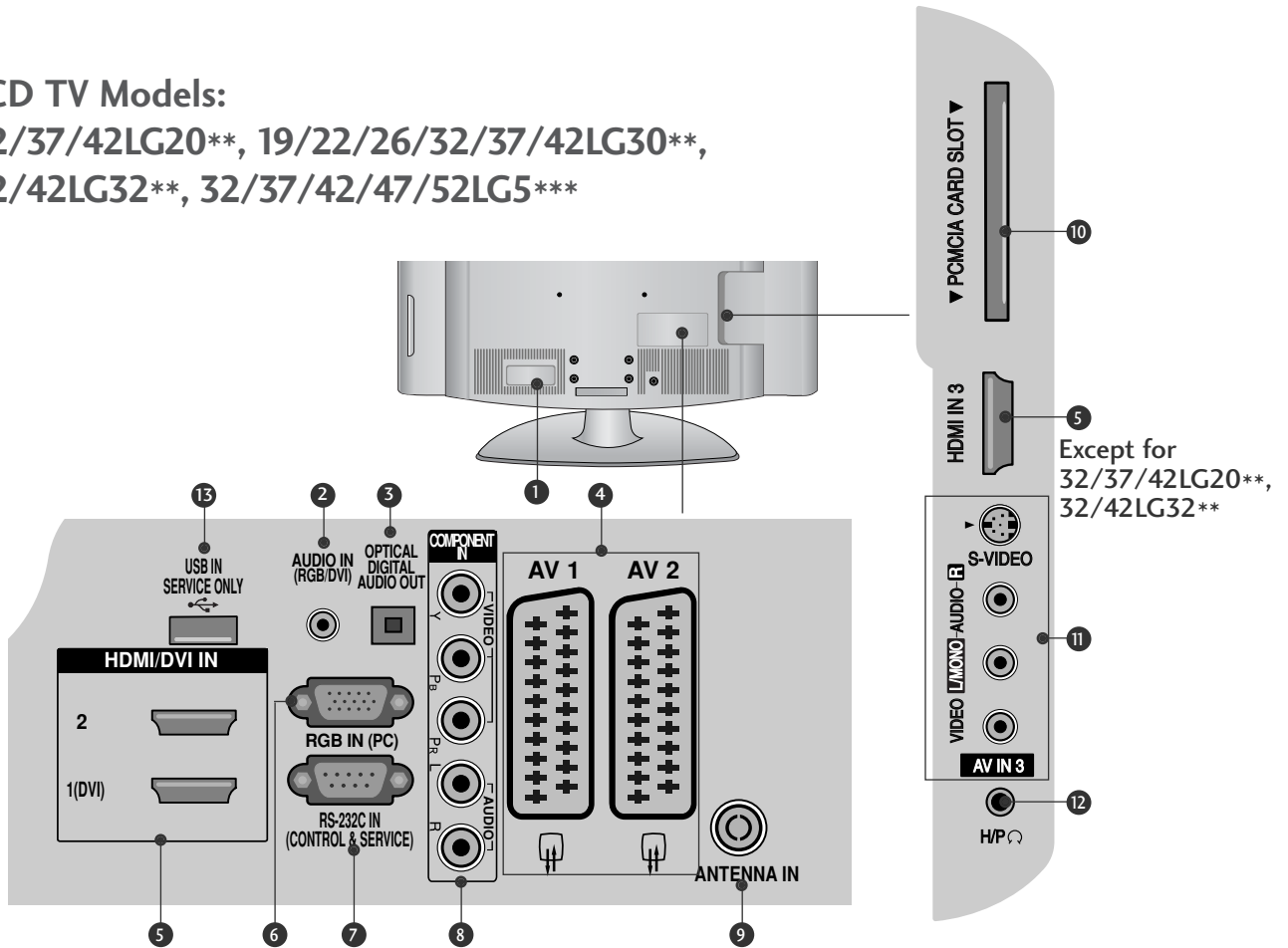

- 1 Power Cord Socket**
This TV operates on an AC power. The voltage is indicated on the Specifications page. Never attempt to operate the TV on DC power.
- 2 RGB/DVI Audio Input**
Connect the audio from a PC or DTV.
- 3 DIGITAL AUDIO OUT OPTICAL**
Connect digital audio from various types of equipment.
Note: In standby mode, these ports do not work.
- 4 Euro Scart Socket (AV1/AV2)**
Connect scart socket input or output from an external device to these jacks.
- 5 HDMI Input**
Connect a HDMI signal to HDMI IN. Or DVI (VIDEO) signal to HDMI/DVI port with DVI to HDMI cable.
- 6 RGB Input**
Connect the output from a PC.
- 7 RS-232C IN (CONTROL & SERVICE) PORT**
Connect to the RS-232C port on a PC.
- 8 Component Input**
Connect a component video/audio device to these jacks.
- 9 Antenna Input**
Connect RF antenna to this jack.
- 10 PCMCIA (Personal Computer Memory Card International Association) Card Slot**
(This feature is not available in all countries.)
- 11 Audio/Video Input**
Connect audio/video output from an external device to these jacks.
S-Video Input (Except for 32/37/42LG20**, 32/42LG32**)
Connect S-Video out from an S-VIDEO device.
- 12 Headphone Socket (Except for 32/37/42LG20**, 32/42LG32**)**
Connect the headphone plug to this socket.
- 13 SERVICE ONLY PORT**

LCD TV Models : 19/22LS4D*

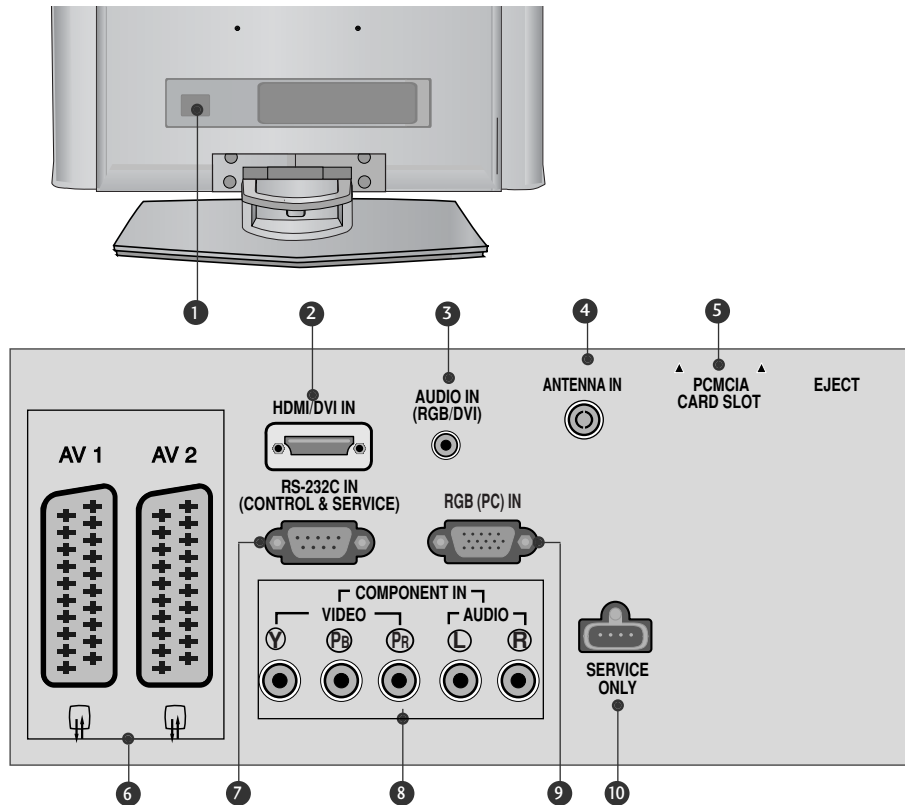

- 1 Power Cord Socket**
This TV operates on an AC power. The voltage is indicated on the Specifications page. Never attempt to operate the TV on DC power.
- 2 HDMI Input**
Connect a HDMI signal to HDMI IN.
Or DVI(VIDEO)signal to HDMI/DVI port with DVI to HDMI cable.
- 3 RGB/DVI Audio Input**
Connect the audio from a PC or DTV.
- 4 Antenna Input**
Connect RF antenna to this jack.
- 5 PCMCIA (Personal Computer Memory Card International Association) Card Slot**
(This feature is not available in all countries.)
- 6 Euro Scart Socket (AV1/AV2)**
Connect scart socket input or output from an external device to these jacks.
- 7 RS-232C IN (CONTROL & SERVICE) PORT**
Connect to the RS-232C port on a PC.
- 8 Component Input**
Connect a component video/audio device to these jacks.
- 9 RGB Input**
Connect the output from a PC.
- 10 SERVICE ONLY PORT**

PREPARATION

STAND INSTALLATION

(LCD TV Models: 32/37/42LG20**, 26/32/37/42LG30**, 32/42LG32**, 32/37/42LG5***)

- When assembling the desk type stand, check whether the bolt is fully tightened. (If not tightened fully, the product can tilt forward after the product installation.) If you tighten the bolt with excessive force, the bolt can deviate from abrasion of the tightening part of the bolt.

- 1 Carefully place the TV screen side down on a cushioned surface to protect the screen from damage.

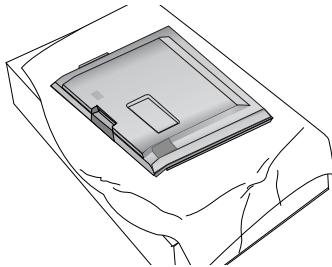

- 2 Assemble the parts of the **Stand Body** with the **Cover Base** of the TV.

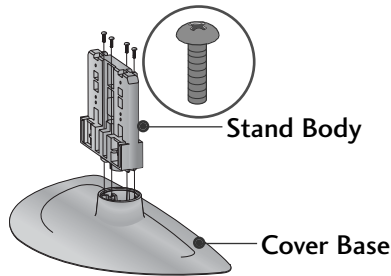

- 3 Assemble the TV as shown.

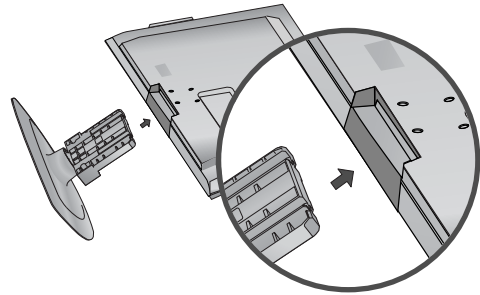

- 4 Fix the 4 bolts securely using the holes in the back of the TV.

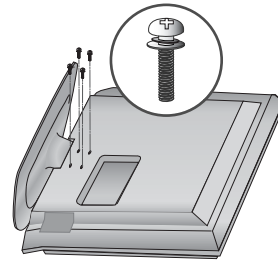

(Only 19/22LG30**)

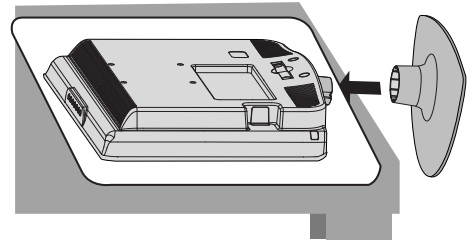
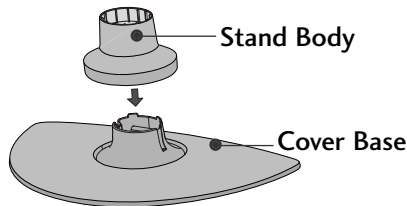
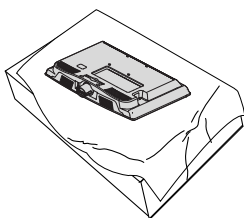

- 1 Carefully place the TV screen side down on a cushioned surface to protect the screen from damage.
- 2 Assemble the parts of the **STAND BODY** with **COVER BASE** of the TV. Insert the **STAND BODY** into a **COVER BASE** until clicking sound.
- 3 Assemble the TV as shown.

(Only 42PG10**, 42PG20**, 42PG30**)

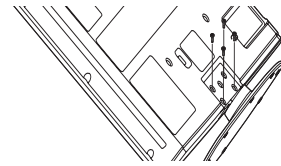
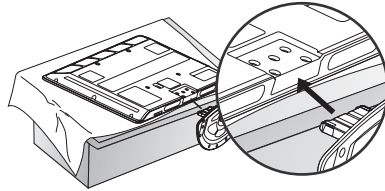
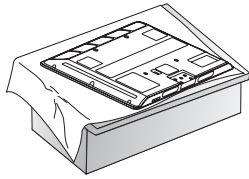

- 1 Carefully place the TV screen side down on a cushioned surface to protect the screen from damage.

- 2 Assemble the TV as shown.

- 3 Fix the 4 bolts securely using the holes in the back of the TV.

PREPARATION

STAND INSTALLATION (Only 19/22LS4D*)

▪ Image shown may differ from your TV.

- 1 Carefully place the TV screen side down on a cushioned surface to protect the screen from damage.

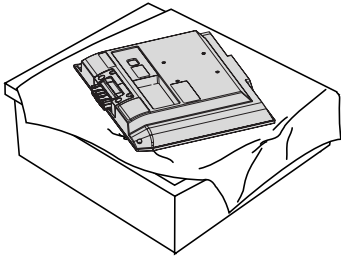

- 2 Hold the **Hinge Body** and bend it upward.

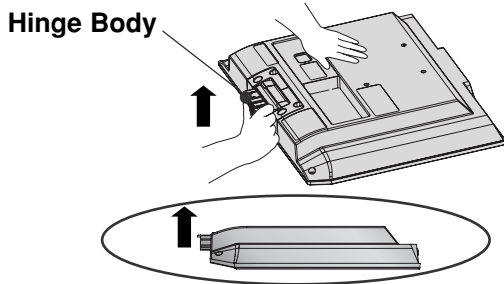

- 3 Insert the **Stand Body** into the TV until clicking sound.

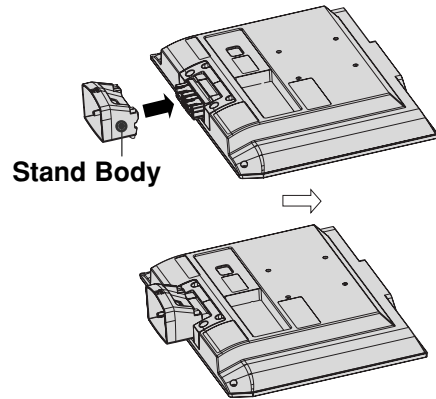

- 4 Assemble the parts of the **Stand Body** with the **Cover Base** of the TV.

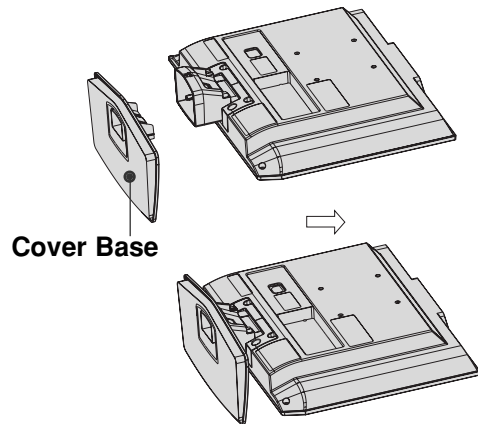

Swivel Stand

(Except for 19/22LS4D*, 50PG10**)

After installing the TV, you can adjust the TV manually to the left or right direction by 20 degrees to suit your viewing position.

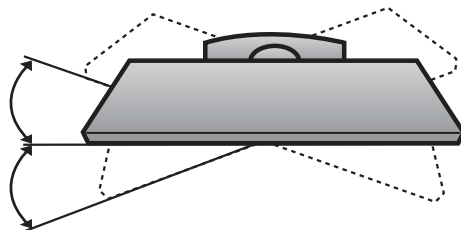

DETACHING STAND (Only 19/22LS4D*)

▪ Image shown may differ from your TV.

- 1** Place the tv with its front facing downward on a cushion or soft cloth.

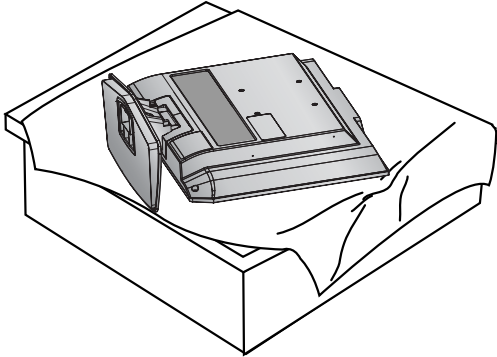

- 2** Pull the **Cover Base** backward during pressing a button on the **Stand Body**.

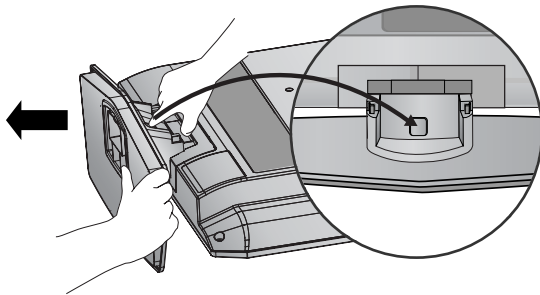

- 3** Hold the **Cover Base** and pull with shake it backward to separate from the **Stand Body**.

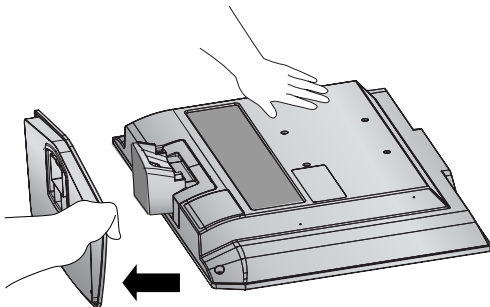

- 4** Hold the **Stand Body** and bend it upward.

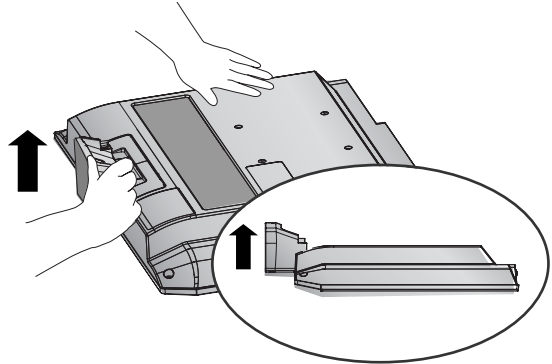

- 5** Pull stand body to separate from the TV during pressing 2 latches.

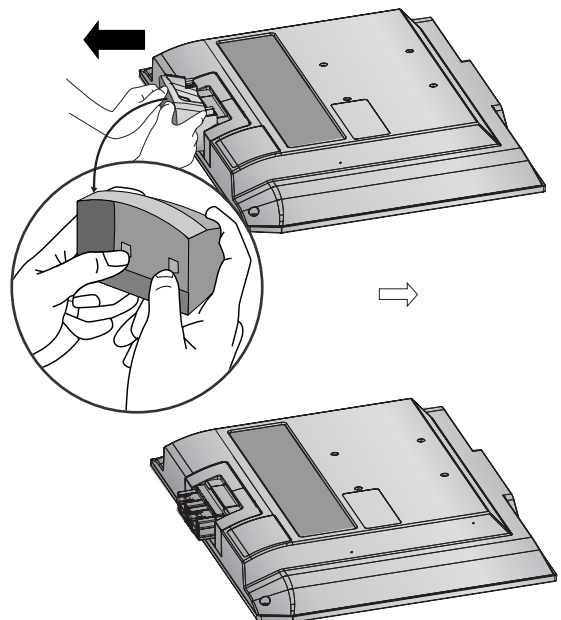

PREPARATION

PLEASE SET IT UP CAREFULLY SO THE PRODUCT DOES NOT FALL OVER.

PREPARATION

- You should purchase necessary components to fix the TV to the wall on the market.
- Position the TV close to the wall to avoid the possibility of it falling when pushed.
- The instructions shown below are a safer way to set up the TV, which is to fix it to the wall, avoiding the possibility of it falling forwards if pulled. This will prevent the TV from falling forward and causing injury. This will also prevent the TV from damage. Ensure that children do not climb or hang from the TV.

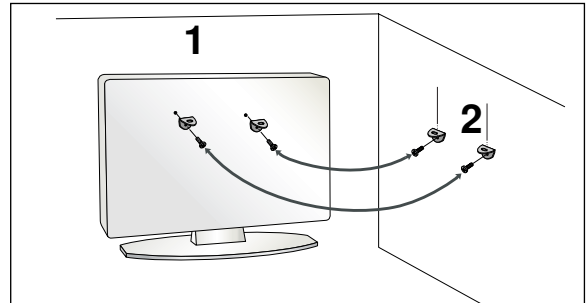
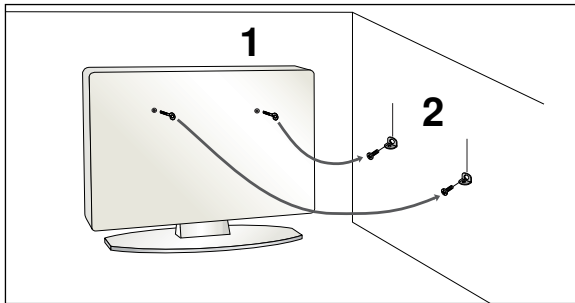

- 1 Use the eye-bolts or TV brackets/bolts to fix the TV to the wall as shown in the picture.
(If your TV has bolts in the eye-bolts, loosen these bolts.)
* Insert the eye-bolts or TV brackets/bolts and tighten them securely in the upper holes.
- 2 Secure the wall brackets with the bolts on the wall. Match the height of the bracket that is mounted on the wall.

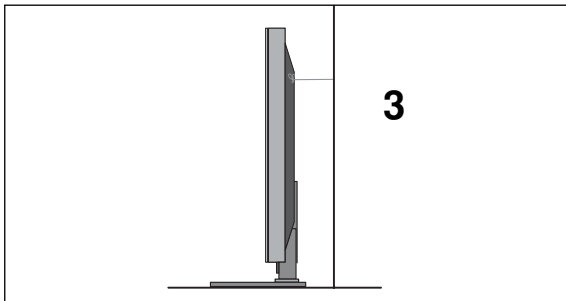

- 3 Use a sturdy rope to tie the TV. It is safer to tie the rope so it becomes horizontal between the wall and the TV.

! NOTE

- ▶ When moving the TV undo the cords first.
- ▶ Use a platform or cabinet strong and large enough to support the size and weight of the TV.
- ▶ To use the TV safely make sure that the height of the bracket on the wall and on the TV is the same.

BACK COVER FOR WIRE ARRANGEMENT

PLASMA TV Models

- 1 Connect the cables as necessary.

To connect additional equipment, see the **External Equipment Setup** section.

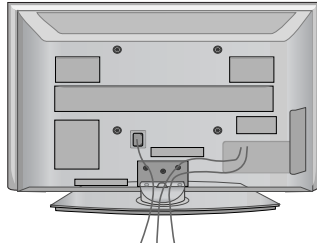

- 2 Install the **CABLE MANAGEMENT CLIP** as shown.

If your TV has the **CABLE HOLDER**, install it as shown and bundle the cables.

(Only 42/50PG10**)

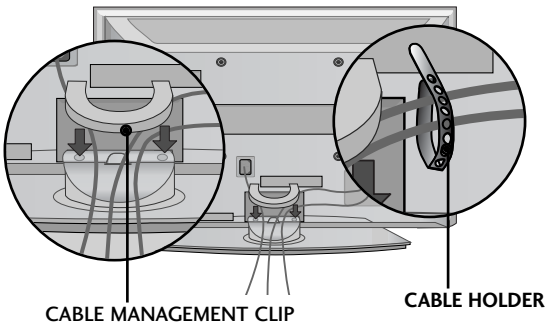

(Only 42/50PG20**, 42/50/60PG30**)

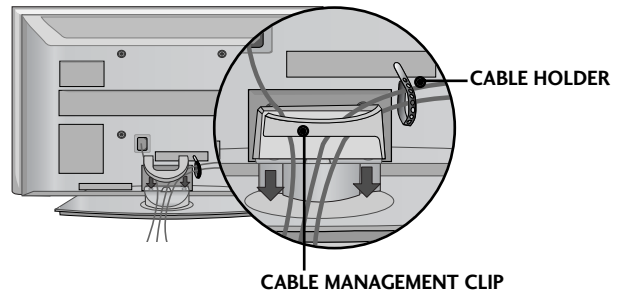

How to remove the cable management clip

Hold the **CABLE MANAGEMENT CLIP** with both hands and pull it upward.

* For the 42PG10** model, press the center of the **CABLE MANAGEMENT CLIP** and then lift up it.

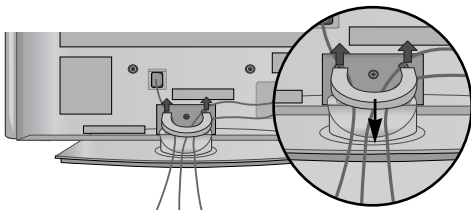

(Only 42/50PG10**)

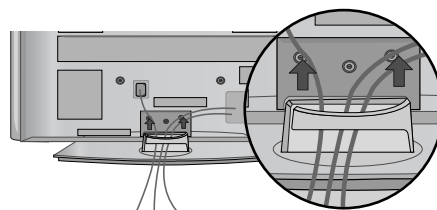

(Only 42/50PG20**, 42/50/60PG30**)

PREPARATION

LCD TV Models:

32/37/42LG20**, 26/32/37/ 42LG30**,
32/42LG32**, 32/37/42/47/52LG5***

- 1 Connect the cables as necessary.
To connect additional equipment, see the **External Equipment Setup** section of the manual.

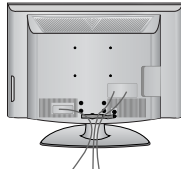

- 2 Open the **CABLE MANAGEMENT CLIP** as shown and manage the cables.

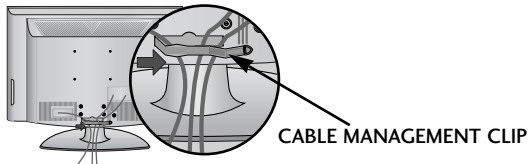

- 3 Fit the **CABLE MANAGEMENT CLIP** as shown.

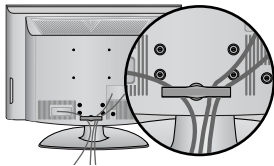

LCD TV Models : 19/22LS4D*

- 1 Connect the cables as necessary.
To connect additional equipment, see the **External Equipment Setup** section.

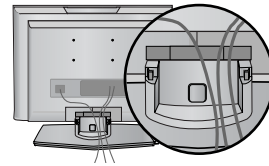

- 2 Install the **CABLE MANAGEMENT CLIP** as shown.

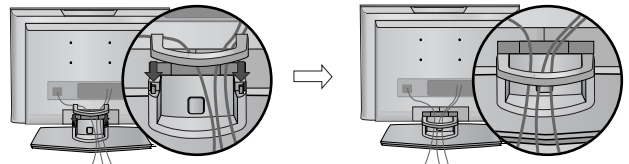

How to remove the cable management clip (LCD TV Models : 19/22LS4D*)

First, press the cable management. Hold the **CABLE MANAGEMENT CLIP** with both hands and pull it upward.

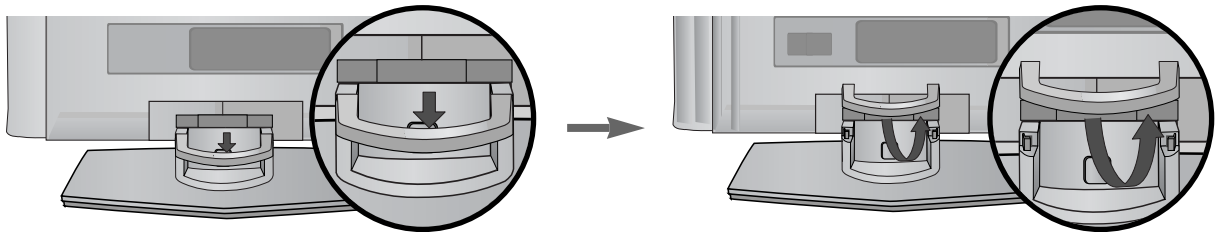

NOTE

- ▶ Do not use the **CABLE MANAGEMENT CLIP** to lift the TV.
- If the TV is dropped, you may be injured or the TV may be damaged.

LCD TV Models : 19/22LG30**

- 1 Connect the cables as necessary.

To connect additional equipment, see the **External Equipment Setup** section of the manual.

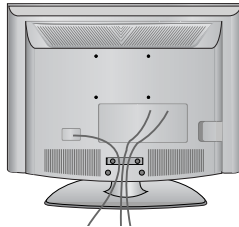

- 2 Install the CABLE MANAGEMENT CLIP as shown.

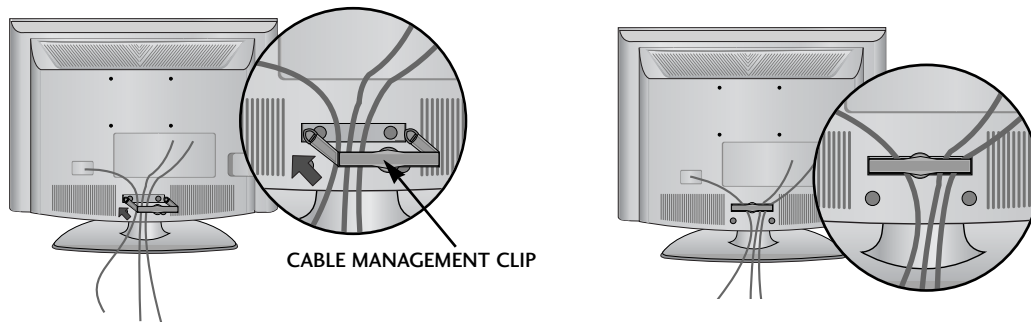

How to remove the cable management clip

- ▶ Hold the **CABLE MANAGEMENT CLIP** with both hands and pull it backward.

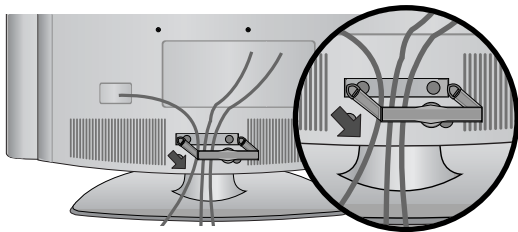

! NOTE

- ▶ Do not use the **CABLE MANAGEMENT CLIP** to lift the TV.
- If the TV is dropped, you may be injured or the TV may be damaged.

PREPARATION

POSITIONING YOUR DISPLAY (Only 19/22LG30**, 19/22LS4D*)

- Image shown may differ from your TV.
- Adjust the position of the panel in various ways for maximum comfort.

• Tilt range

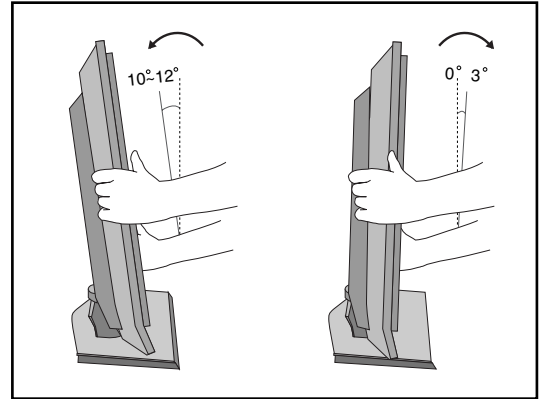

LOCATION (Only 19/22LG30**, 19/22LS4D*)

Position your TV so that no bright light or sunlight falls directly onto the screen. Care should be taken not to expose the tv to any unnecessary vibration, moisture, dust or heat. Also ensure that the TV is placed in a position to allow a free flow of air. Do not cover the ventilation openings on the back cover.

If you intend to mount the TV to a wall, attach VESA standard mounting interface (optional parts) to the back of the TV.

When you install the TV to use the wall mounting bracket (optional parts), fix it carefully so as not to drop.

KENSINGTON SECURITY SYSTEM (Only 19/22LG30**, 19/22LS4D*)

The TV is equipped with a Kensington Security System connector on the back panel. Connect the Kensington Security System cable as shown below.

For the detailed installation and use of the Kensington Security System, refer to the user's guide provided with the Kensington Security System.

For further information, contact <http://www.kensington.com>, the internet homepage of the Kensington company. Kensington sells security systems for expensive electronic equipment such as notebook PCs and LCD projectors.

NOTE

- The Kensington Security System is an optional accessory.

NOTES

- If the TV feels cold to the touch, there may be a small "flicker" when when it is turned on.
This is normal, there is nothing wrong with TV.
- Some minute dot defects may be visible on the screen, appearing as tiny red, green, or blue spots. However, they have no adverse effect on the monitor's performance.
- Avoid touching the LCD screen or holding your finger(s) against it for long periods of time.
Doing so may produce some temporary distortion effects on the screen.

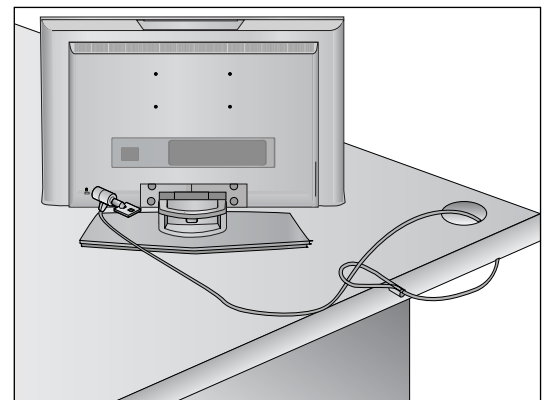

- The TV can be installed in various ways such as on a wall, or on a desktop etc.
- The TV is designed to be mounted horizontally.

EARTHING

Ensure that you connect the earth wire to prevent possible electric shock. If grounding methods are not possible, have a qualified electrician install a separate circuit breaker.

Do not try to earth the TV by connecting it to telephone wires, lightening rods or gas pipes.

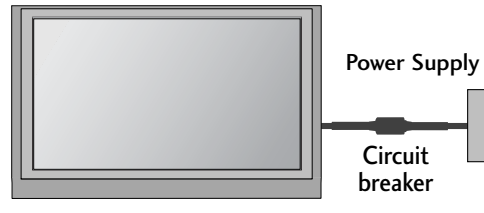

DESKTOP PEDESTAL INSTALLATION

For adequate ventilation allow a clearance of 4" (10cm) all around the TV.

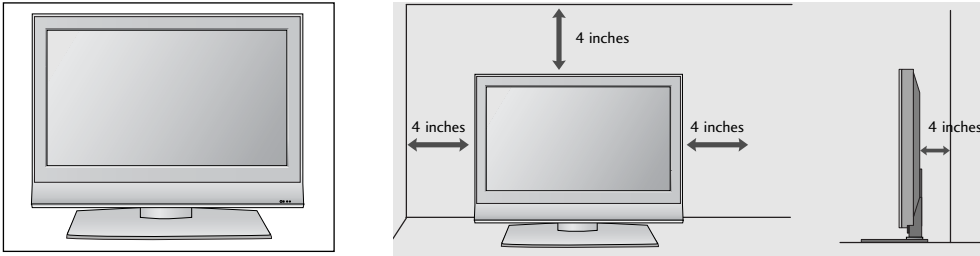

WALL MOUNT: HORIZONTAL INSTALLATION

For adequate ventilation allow a clearance of 4" (10cm) all around the TV. We recommend that you use a wall mounting bracket of LG brand when mounting the TV to a wall.

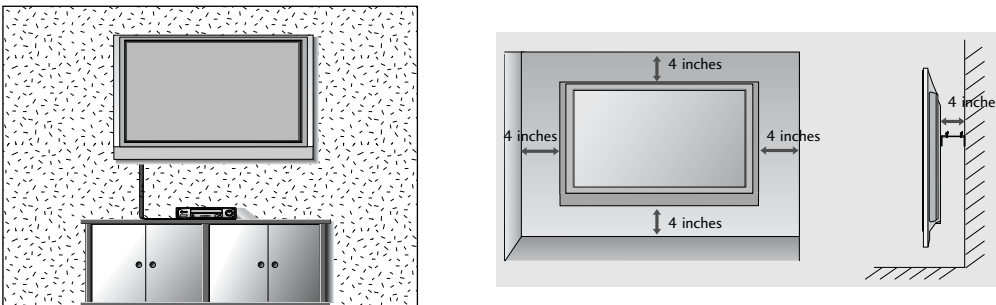

Not using the desk-type stand (Except for 19/22LS4D*)

- Image shown may differ from your TV.

When installing the wall-mounted unit, use the protection cover for desk-type stand installation. Insert the **PROTECTION COVER** into the TV until clicking sound.

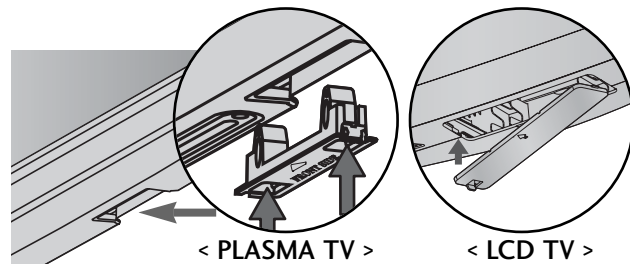

PREPARATION

- To prevent damage do not connect to the mains outlet until all connections are made between the devices.

ANTENNA CONNECTION

- For optimum picture quality, adjust antenna direction.
- An antenna cable and converter are not supplied.

PREPARATION

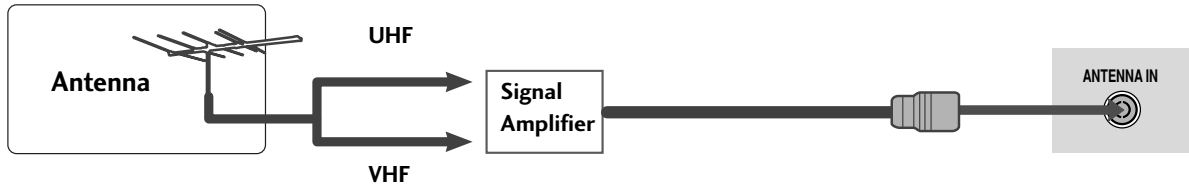
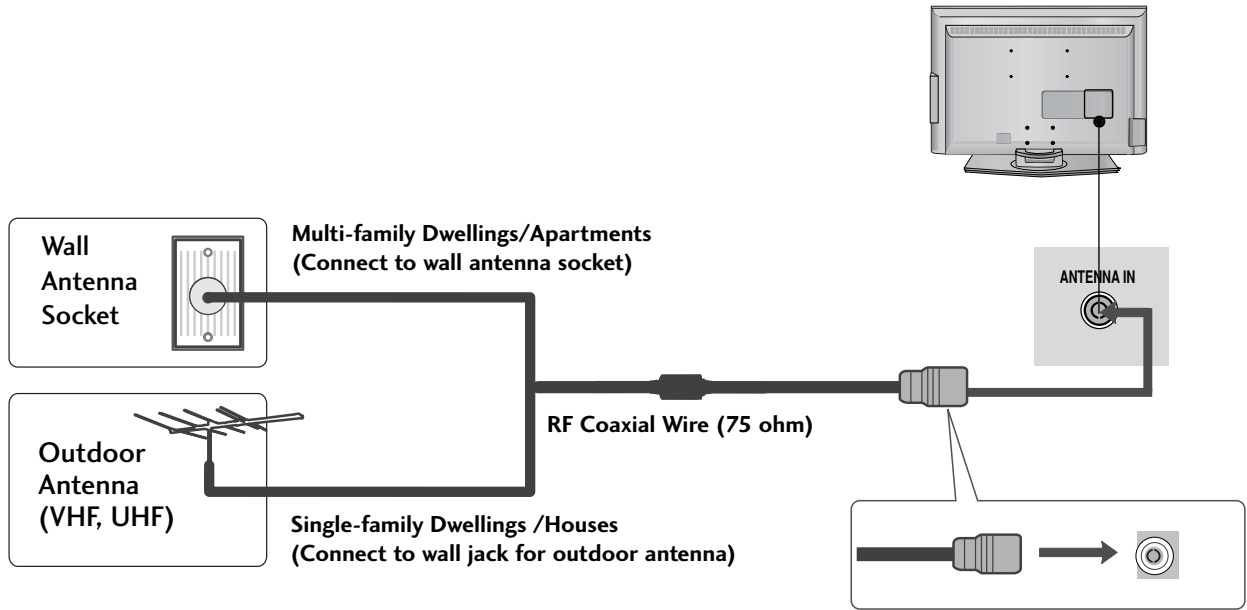

- In poor signal areas, to achieve better picture quality it may be necessary to install a signal amplifier to the antenna as shown above.
- If signal needs to be split for two TVs, use an antenna signal splitter for connection.

EXTERNAL EQUIPMENT SETUP

- To avoid damaging any equipment, never plug in any power cords until you have finished connecting all equipment.
- This section on EXTERNAL EQUIPMENT SETUP mainly uses diagrams for the 22LS4D* models.

HD RECEIVER SETUP

- This TV can receive Digital RF/Cable signals without an external digital set-top box. However, if you do receive Digital signals from a digital set-top box or other digital external device, refer to the diagram as shown below.

Connecting with a component cable

- 1 Connect the video outputs (Y, PB, PR) of the digital set top box to the **COMPONENT IN VIDEO** jacks on the TV.
- 2 Connect the audio output of the digital set-top box to the **COMPONENT IN AUDIO** jacks on the TV.
- 3 Turn on the digital set-top box.
(Refer to the owner's manual for the digital set-top box.)
- 4 Select **Component** input source using the **INPUT** button on the remote control.

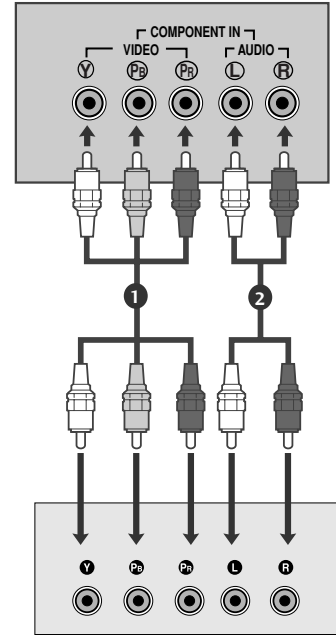

Signal	Component	HDMI
480i/576i	Yes	No
480p/576p	Yes	Yes
720p/1080i	Yes	Yes
1080p	Yes (50/60Hz)	Yes

Connecting a set-top box with an HDMI cable

- 1 Connect the HDMI output of the digital set-top box to the **HDMI/DVI IN**, **HDMI/DVI IN 1**, **HDMI IN 2** or **HDMI IN 3** jack on the TV.
- 2 Turn on the digital set-top box.
(Refer to the owner's manual for the digital set-top box.)
- 3 Select **HDMI/DVI**, **HDMI1**, **HDMI2** or **HDMI3** input source using the **INPUT** button on the remote control.

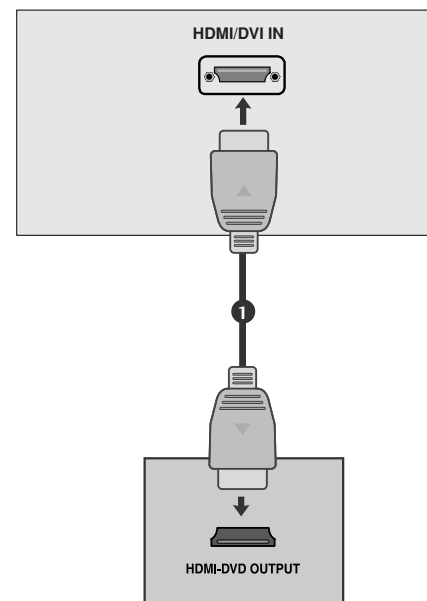

EXTERNAL EQUIPMENT SETUP

Connecting with a HDMI to DVI cable

- 1 Connect the digital set-top box to **HDMI/DVI IN**, **HDMI/DVI IN 1 (DVI)** or **HDMI/DVI IN 1** jack on the TV.
- 2 Connect the audio output of the digital set-top box to the **AUDIO IN (RGB/DVI)** jack on the TV.
- 3 Turn on the digital set-top box. (Refer to the owner's manual for the digital set-top box.)
- 4 Select **HDMI/DVI** or **HDMI 1** input source using the **INPUT** button on the remote control.

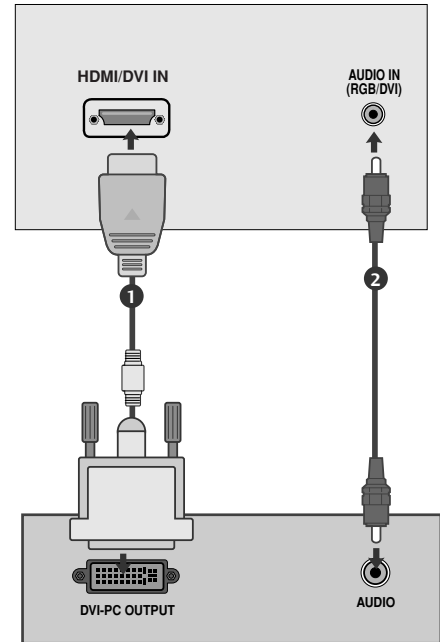

DIGITAL AUDIO OUT SETUP (Except for 19/22LS4D*)

- Sending the TV's audio signal to external audio equipment via the Digital Audio Output (Optical) port.

- 1 Connect one end of an optical cable to the TV Digital Audio (Optical) Output port.
- 2 Connect the other end of the optical cable to the digital audio (optical) input on the audio equipment.
- 3 Set the "TV Speaker option - Off" in the **AUDIO** menu. (▶ p.80) Refer to the external audio equipment instruction manual for operation.

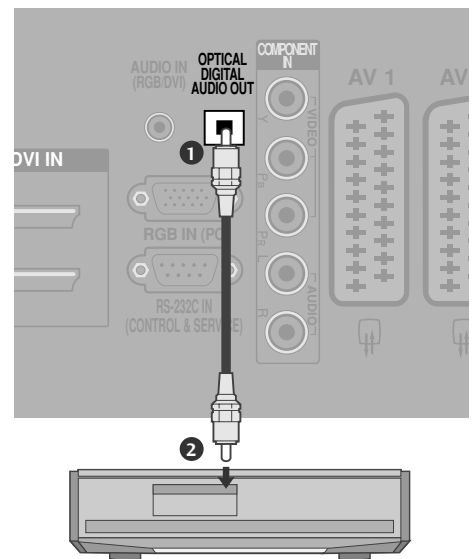

! CAUTION

- ▶ Do not look into the optical output port. Looking at the laser beam may damage your vision.

DVD SETUP

When connecting with a component cable

- 1 Connect the video outputs (Y, P_B, P_R) of the DVD to the **COMPONENT IN VIDEO** jacks on the TV.
- 2 Connect the audio outputs of the DVD to the **COMPONENT IN AUDIO** jacks on the TV.
- 3 Turn on the DVD player, insert a DVD.
- 4 Select **Component** input source using the **INPUT** button on the remote control.
- 5 Refer to the DVD player's manual for operating instructions.

Component Input ports

To achieve better picture quality, connect a DVD player to the component input ports as shown below.

Component ports on the TV	Y	P _B	P _R
Video output ports on DVD player	Y	P _B	P _R
	Y	B-Y	R-Y
	Y	C _b	C _r
	Y	P _b	P _r

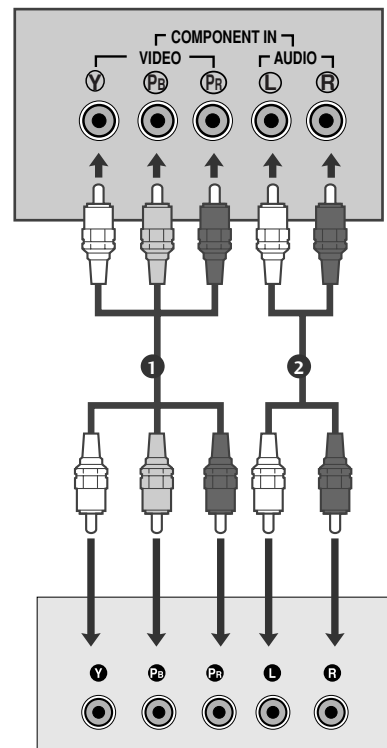

Connecting with a Euro Scart cable

- 1 Connect the Euro scart socket of the DVD to the **AV1** Euro scart socket on the TV.
- 2 Turn on the DVD player, insert a DVD.
- 3 Select **AV1** input source using the **INPUT** button on the remote control.
If connected to **AV2** Euro scart socket, select **AV2** input source.
- 4 Refer to the DVD player's manual for operating instructions.

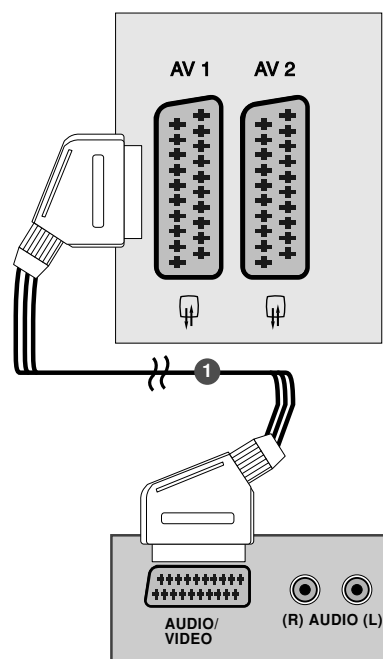

! NOTE

▶ Any Euro scart cable used must be signal shielded.

EXTERNAL EQUIPMENT SETUP

Connecting with a S-Video cable (Except for 19/22LS4D*, 32/37/42LG20**, 32/42LG32**, 42/50PG10**)

- 1 Connect the S-VIDEO output of the DVD to the **S-VIDEO** input on the TV.
- 2 Connect the audio outputs of the DVD to the **AUDIO** input jacks on the TV.
- 3 Turn on the DVD player, insert a DVD.
- 4 Select **AV3** input source using the **INPUT** button on the remote control.
- 5 Refer to the DVD player's manual for operating instructions.

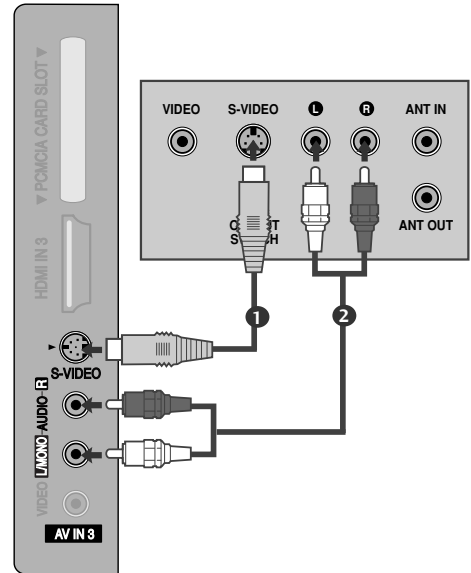

Connecting the HDMI cable

- 1 Connect the HDMI output of the DVD to the **HDMI/DVI IN**, **HDMI/DVI IN 1**, **HDMI IN 2** or **HDMI IN 3** jack on the TV.
- 2 Select **HDMI/DVI**, **HDMI1**, **HDMI2** or **HDMI3** input source using the **INPUT** button on the remote control.
- 3 Refer to the DVD player's manual for operating instructions.

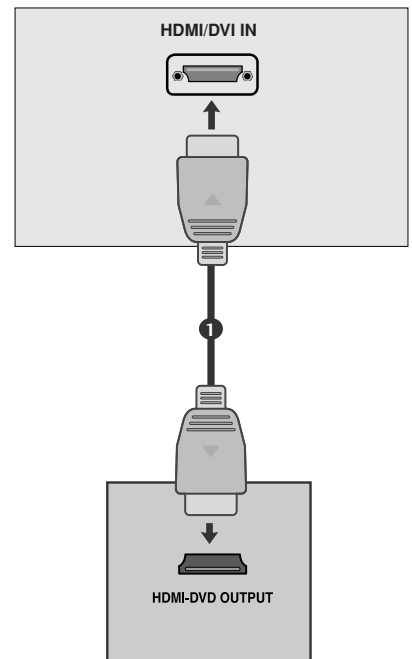

! NOTE

- ▶ The TV can receive video and audio signals simultaneously when using a HDMI cable.
- ▶ If the DVD does not support Auto HDMI, you must set the output resolution appropriately.

VCR SETUP

- To avoid picture noise (interference), allow adequate distance between the VCR and TV.
- If 4:3 picture format is used for an extended period the fixed images on the sides of the screen may remain visible.

When connecting with a RF Cable

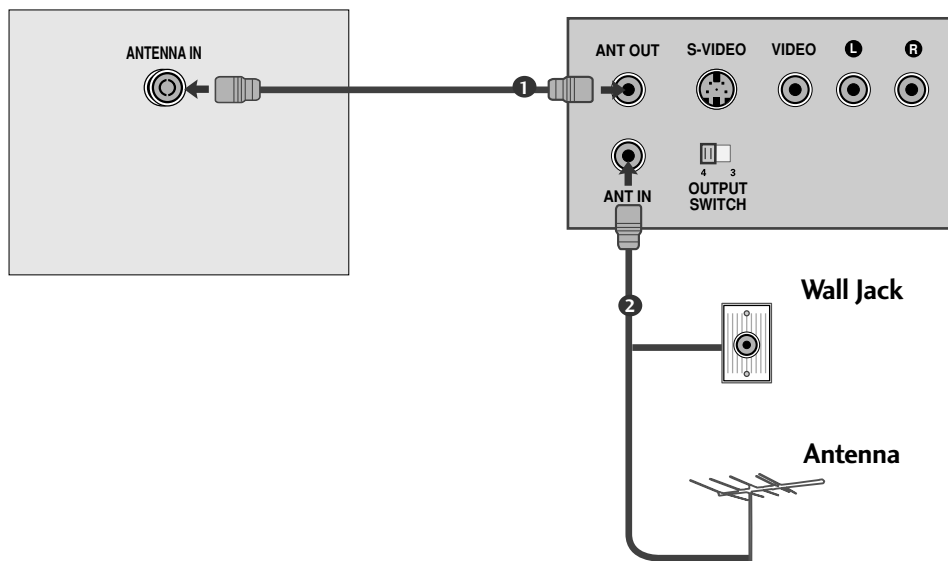

- 1 Connect the **ANT OUT** socket of the VCR to the **ANTENNA IN** socket on the TV.
- 2 Connect the antenna cable to the **ANT IN** socket of the VCR.
- 3 Press the **PLAY** button on the VCR and match the appropriate channel between the TV and VCR for viewing.

EXTERNAL EQUIPMENT SETUP

Connecting with a Euro Scart cable

- 1 Connect the Euro scart socket of the VCR to the **AV1** Euro scart socket on the TV.
- 2 Insert a video tape into the VCR and press **PLAY** on the VCR. (Refer to the VCR owner's manual.)
- 3 Select **AV1** input source using the **INPUT** button on the remote control.
- 4 If connected to **AV2** Euro scart socket, select **AV2** input source.

! NOTE

- ▶ Any Euro scart cable used must be signal shielded.

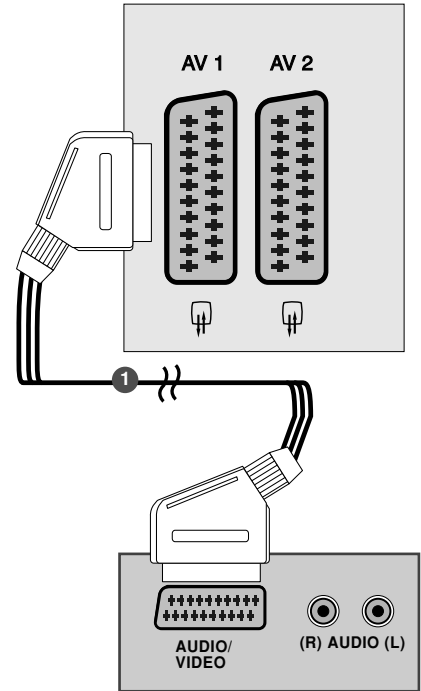

Connecting with a RCA cable (Except for 19/22LS4D*, 42/50PG10**)

- 1 Connect the **AUDIO/VIDEO** jacks between TV and VCR. Match the jack colours (Video = yellow, Audio Left = white, and Audio Right = red)
- 2 Insert a video tape into the VCR and press **PLAY** on the VCR. (Refer to the VCR owner's manual.)
- 3 Select **AV3** input source using the **INPUT** button on the remote control.

! NOTE

- ▶ If you have a mono VCR, connect the audio cable from the VCR to the **AUDIO L/MONO** jack of the TV.

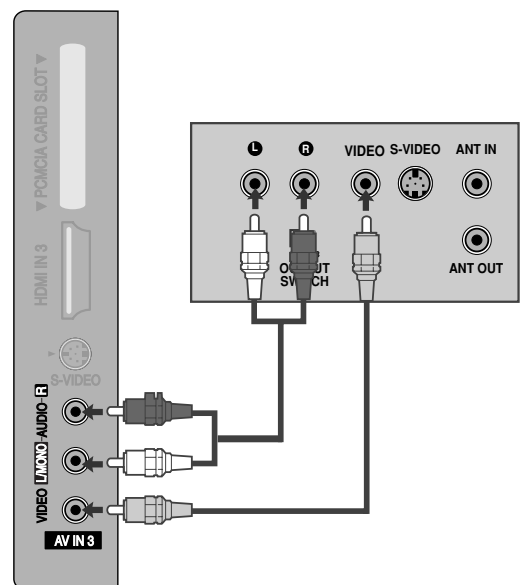

Connecting with a S-Video cable (Except for 19/22LS4D*, 32/37/42LG20**, 32/42LG32**, 42/50PG10**)

- 1 Connect the S-VIDEO output of the VCR to the S-VIDEO input on the TV. The picture quality is improved; compared to normal composite (RCA cable) input.
- 2 Connect the audio outputs of the VCR to the AUDIO input jacks on the TV.
- 3 Insert a video tape into the VCR and press PLAY on the VCR. (Refer to the VCR owner's manual.)
- 4 Select **AV3** input source using the **INPUT** button on the remote control.

! NOTE

- ▶ If both S-VIDEO and VIDEO sockets have been connected to the S-VHS VCR simultaneously, only the S-VIDEO can be received.

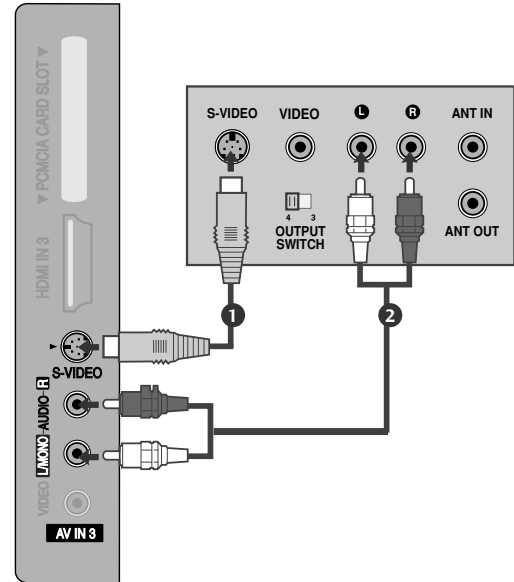

OTHER A/V SOURCE SETUP

(Except for 19/22LS4D*, 42/50PG10**)

- 1 Connect the **AUDIO/VIDEO** jacks between TV and external equipment. Match the jack colours. (Video = yellow, Audio Left = white, and Audio Right = red)
- 2 Select **AV3** input source using the **INPUT** button on the remote control.
- 3 Operate the corresponding external equipment. Refer to external equipment operating guide.

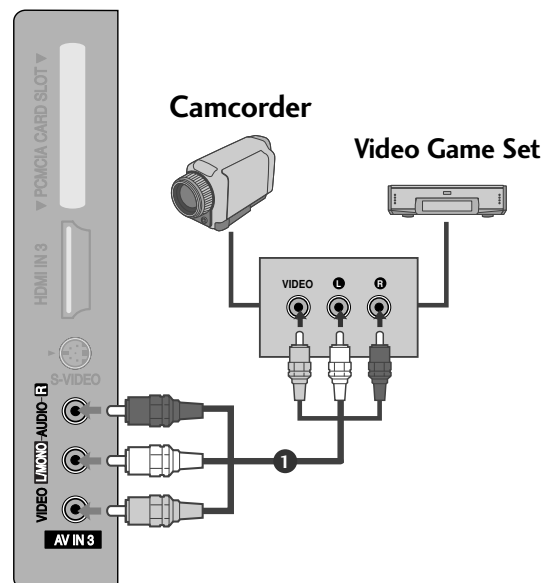

EXTERNAL EQUIPMENT SETUP

INSERTION OF CI MODULE

- To view the encrypted (pay) services in digital TV mode.
- This feature is not available in all countries.

- 1 Insert the CI Module to **PCMCIA** (Personal Computer Memory Card International Association) **CARD SLOT** of TV as shown.

For further information, see p.54.

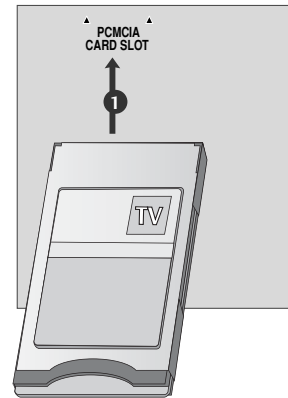

PC SETUP

This TV provides Plug and Play capability, meaning that the PC adjusts automatically to the TV's settings.

Connecting with a D-sub 15 pin cable

- 1 Connect the RGB output of the PC to the **RGB IN (PC)** jack on the TV.
- 2 Connect the PC audio output to the **AUDIO IN (RGB/DVI)** jack on the TV.
- 3 Turn on the PC and the TV
- 4 Select **RGB** input source using the INPUT button on the remote control.

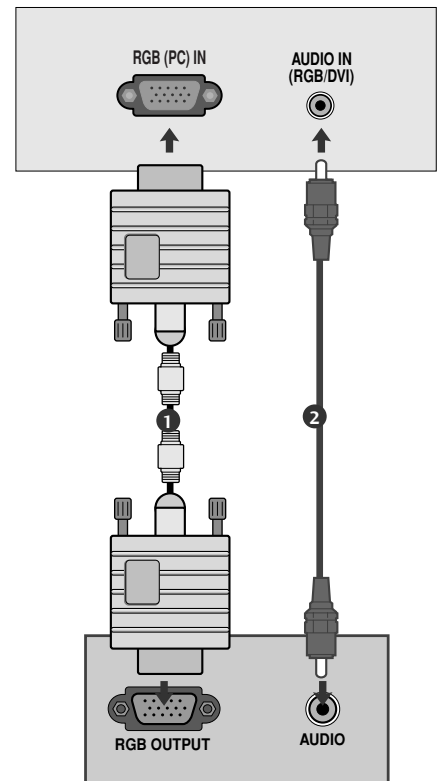

Connecting with a HDMI to DVI cable

- 1 Connect the DVI output of the PC to the **HDMI/DVI IN**, **HDMI/DVI IN 1 (DVI)** or **HDMI/DVI IN 1** jack on the TV.
- 2 Connect the PC audio output to the **AUDIO IN (RGB/DVI)** jack on the TV.
- 3 Turn on the PC and the TV.
- 4 Select **HDMI/DVI** or **HDMI 1** input source using the **INPUT** button on the remote control.

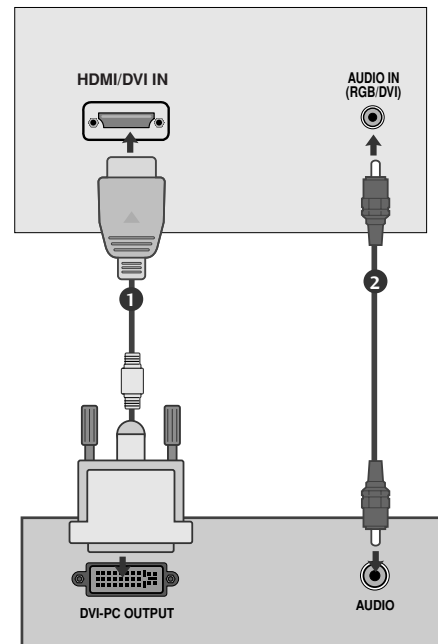

! NOTE

- ▶ To enjoy vivid picture and sound, connect a PC to the TV.
- ▶ Avoid keeping a fixed image on the TV's screen for prolonged periods of time. The fixed image may become permanently imprinted on the screen; use a screen saver when possible.
- ▶ Connect the PC to the RGB (PC) or HDMI IN (or HDMI/DVI IN) port of the TV; change the resolution.
- ▶ There may be interference relating to resolution, vertical pattern, contrast or brightness in PC mode. Change the PC mode to another resolution or change the refresh rate to another rate or adjust the brightness and contrast on the menu until the picture is clear. If the refresh rate of the PC graphic card can not be changed, change the PC graphic card or consult the manufacturer of the PC graphic card.
- ▶ The synchronization input waveform for Horizontal and Vertical frequencies are separate.
- ▶ Connect the signal cable from the monitor output port of the PC to the RGB (PC) port of the TV or the signal cable from the HDMI output port of the PC to the HDMI IN (or HDMI/DVI IN) port on the TV.
- ▶ Connect the audio cable from the PC to the Audio input on the TV. (Audio cables are not included with the TV).
- ▶ If using a sound card, adjust PC sound as required.
- ▶ This TV uses a VESA Plug and Play Solution. The TV provides EDID data to the PC system with a DDC protocol. The PC adjusts automatically when using this TV.
- ▶ DDC protocol is preset for RGB (Analog RGB), HDMI (Digital RGB) mode.
- ▶ If required, adjust the settings for Plug and Play functionality.
- ▶ If the graphic card on the PC does not output analogue and digital RGB simultaneously, connect only one of either RGB or HDMI IN (or HDMI/DVI IN) to display the PC output on the TV.
- ▶ If the graphic card on the PC does output analogue and digital RGB simultaneously, switch the TV to either RGB or HDMI; (the other mode is set to Plug and Play automatically by the TV.)
- ▶ DOS mode may not work depending on the video card if you use a HDMI to DVI cable.
- ▶ If you use too long an RGB-PC cable, there may be interference on the screen. We recommend using under 5m of cable. This provides the best picture quality.

EXTERNAL EQUIPMENT SETUP

Supported Display Resolution (Only 19/22LS4D*)

RGB[PC], HDMI[PC] mode

Resolution	Horizontal Frequency(kHz)	Vertical Frequency(Hz)
720x400	31.468	70.08
640x480	31.469	59.94
	37.684	75.00
800x600	37.879	60.31
	46.875	75.00
832x624	49.725	74.55
	48.363	60.00
1024x768	56.470	70.00
	60.123	75.029
	60.123	75.029
1280x768	47.78	59.87
1360x768	47.72	59.8
1366x768	47.56	59.6
1280x1024	63.595	60.0
1440x900	55.5	59.90
1400x1050	64.744	59.948
1680x1050	65.16	59.94

● Only 19LS4D+

● Only 22LS4D+

HDMI[DTV] mode

Resolution	Horizontal Frequency(kHz)	Vertical Frequency(Hz)
720x480	31.469	59.94
	31.5	60
720x576	31.25	50
	37.500	50
1280x720	44.96	59.94
	45	60
1920x1080	33.72	59.94
	33.75	60
	28.125	50.00
	26.97	23.97
	27	24
	33.716	29.976
	33.75	30.00
	56.250	50
	67.43	59.94
	67.5	60

Supported Display Resolution

(Only 19/22/26/32/37/42LG30**, 32/37/42LG20**, 32/42LG32**, 32/37/42/47/52LG5***)

RGB[PC], HDMI[PC] mode

Resolution	Horizontal Frequency(kHz)	Vertical Frequency(Hz)
720x400	31.468	70.08
640x480	31.469	59.94
	37.684	75.00
800x600	37.879	60.31
	46.875	75.00
832x624	49.725	74.55
	48.363	60.00
1024x768	56.470	70.00
	60.123	75.029
1280x768	47.78	59.87
1360x768	47.72	59.8
1366x768	47.56	59.6
1440x900	55.5	59.90
1400x1050	64.744	59.948
1680x1050	65.16	59.94
1280x1024	63.595	60.0
1920x1080	66.647	59.988

● Only 19LG30**

● Only 22LG30**

● Only 19LG30**, 37/42/47/52LG5***

● Only 37/42/47/52LG5***

HDMI[DTV] mode

Resolution	Horizontal Frequency(kHz)	Vertical Frequency(Hz)
720x480	31.469 / 31.5	59.94 / 60
720x576	31.25	50
1280x720	37.500	50
	44.96 / 45	59.94 / 60
1920x1080	33.72 / 33.75	59.94 / 60
	28.125	50.00
	26.97 / 27	23.97 / 24
	33.716 / 33.75	26.976 / 30.00
	56.250	50
	67.43 / 67.5	59.94 / 60

Supported Display Resolution (Only 42/50PG10**, 42/50PG20**, 42/50/60PG30**)

RGB[PC], HDMI[PC] mode

Resolution	Horizontal Frequency(kHz)	Vertical Frequency(Hz)
720x400	31.468	70.08
640x480	31.469	59.94
800x600	37.879	60.31
1024x768	48.363	60.00
1280x768	47.78	59.87
1360x768	47.72	59.80
1920x1080	66.647	59.988

HDMI[DTV] mode

Resolution	Horizontal Frequency(kHz)	Vertical Frequency(Hz)
640x480	31.469	59.94
	31.469	60.00
720x480	31.47	59.94
	31.50	60.00
720x576	31.25	50.00
1280x720	37.50	50.00
	44.96	59.94
1920x1080	45.00	60.00
	28.125	50.00
	33.72	59.94
	33.75	60.00
	27.000	24.00
	33.75	30
	56.25	50.00
	67.433	59.94
	67.50	60

EXTERNAL EQUIPMENT SETUP



Screen Setup for PC mode

Screen Reset

Returns to the default settings Position, Size and Phase at the factory.

This function works in the following mode : RGB[PC].

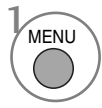

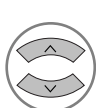
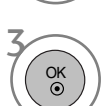
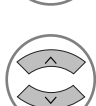
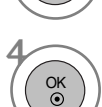
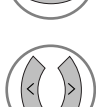
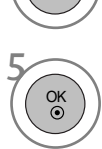
- 1 MENU   Select PICTURE.
- 2   Select SCREEN.
- 3   Select Reset.
- 4   Select Yes.
- 5  Run Reset.

- Press the **MENU** button to return to normal TV viewing.
- Press the **RETURN** button to move to the previous menu screen.

Adjustment for screen Position, Size, Phase

If the picture is not clear after auto adjustment and especially if characters are still trembling, adjust the picture phase manually.

This function works in the following mode : RGB[PC].

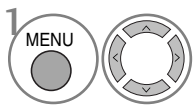

Select **PICTURE**.

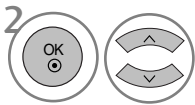

Select **SCREEN**.

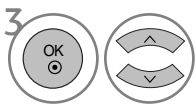

Select **Position, Size or Phase**.

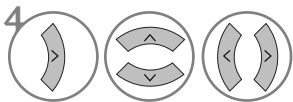

Make appropriate adjustments.

- Press the **MENU** button to return to normal TV viewing.
- Press the **RETURN** button to move to the previous menu screen.





EXTERNAL EQUIPMENT SETUP

Selecting Resolution

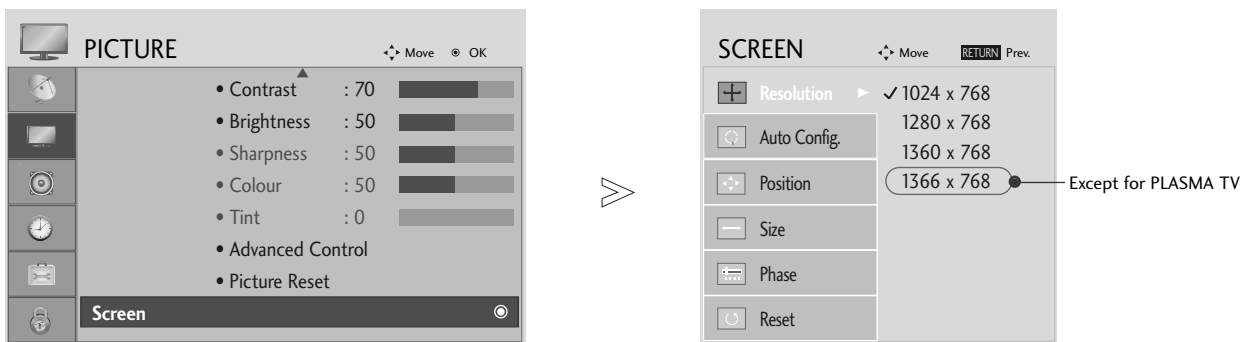
To view a normal picture, match the resolution of RGB mode and selection of PC mode.

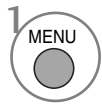
This function works in the following mode: RGB[PC] mode.

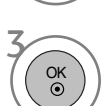
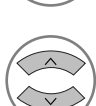
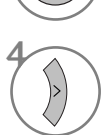
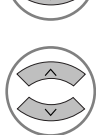

-   Select **PICTURE**.
-   Select **SCREEN**.
-   Select **Resolution**.
-   Select the desired resolution.

- Press the **MENU** button to return to normal TV viewing.
- Press the **RETURN** button to move to the previous menu screen.

Auto Configure (RGB [PC] mode only)

Automatically adjusts picture position and minimizes image instability. After adjustment, if the image is still not correct, your TV is functioning properly but needs further adjustment.

Auto configure

This function is for automatic adjustment of the screen position, clock, and phase. The displayed image will be unstable for a few seconds while the auto configuration is in progress.

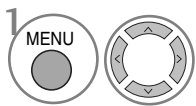
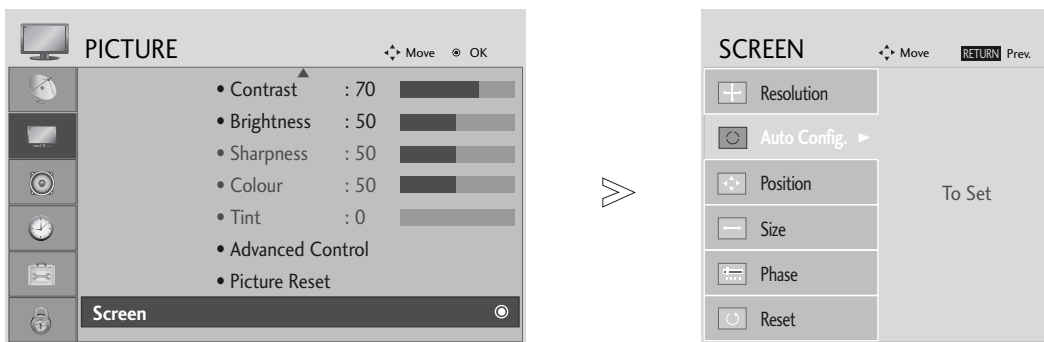

Select PICTURE.

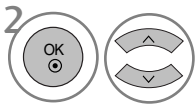

Select SCREEN.

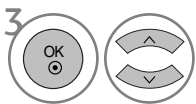

Select Auto Config..

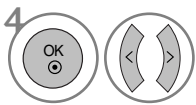

Select Yes.



Run Auto Config..

- If the position of the image is still not correct, try Auto adjustment again.
- If picture needs to be adjusted again after Auto adjustment in RGB (PC), you can adjust the **Position, Size or Phase**.

- Press the MENU button to return to normal TV viewing.
- Press the RETURN button to move to the previous menu screen.

WATCHING TV / PROGRAMME CONTROL

REMOTE CONTROL KEY FUNCTIONS (Only 19/22LS4D*)

When using the remote control, aim it at the remote control sensor on the TV.



POWER Switches the TV on from standby or off to standby.

D/A INPUT Selects digital or analogue mode. Switches the TV on from standby.

INPUT External input mode rotate in regular sequence. Switches the TV on from standby.

TV/RADIO Selects Radio or TV channel in digital mode.

I/II Selects the sound output.

MUTE Switches the sound on or off.

0~9 number button Selects a programme. Selects numbered items in a menu.

LIST Displays the programme table.

Q.VIEW Returns to the previously viewed programme.

MENU Selects a menu.

AV MODE It helps you select and set images and sounds when connecting AV devices.

INFO Shows the present screen information.

GUIDE Shows programme schedule.

THUMBSTICK (Up/Down/Left Right) Allows you to navigate the on-screen menus and adjust the system settings to your preference.

OK Accepts your selection or displays the current mode.

VOLUME UP /DOWN Adjusts the volume.

RETURN(EXIT) Allows the user to move back one step in an interactive application, EPG or other user interaction function.

***** No function

FAV Displays the selected favourite programme.

Programme UP/DOWN Selects a programme.

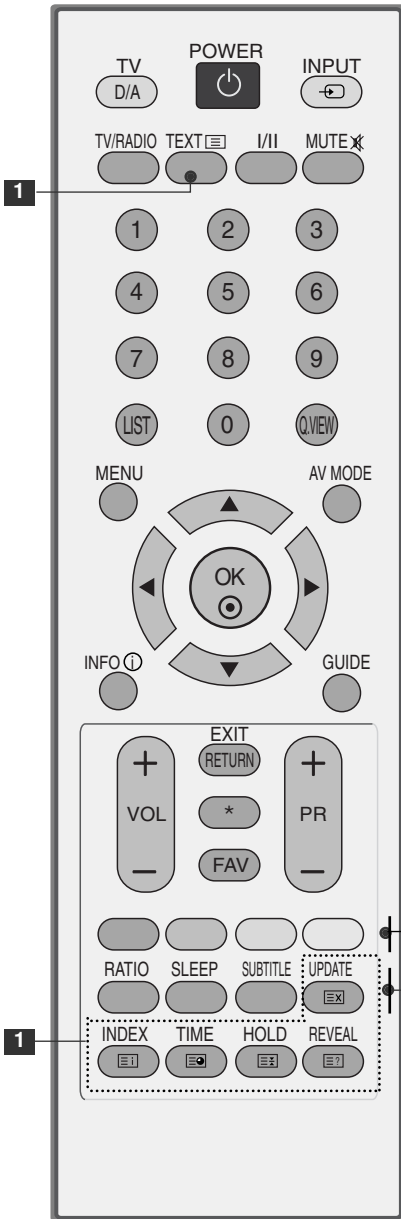

1 **TELETEXT BUTTONS** These buttons are used for teletext. For further details, see the 'Teletext' section.

Coloured buttons These buttons are used for teletext (on **TELETEXT** models only) or **Programme edit**.

RATIO Selects your desired picture format.
SLEEP Sets the sleep timer.
SUBTITLE Recalls your preferred subtitle in digital mode.

Installing Batteries

- Open the battery compartment cover on the back and install the batteries matching correct polarity (+with +,-with -).
- Install two 1.5V AAA batteries. Do not mix old or used batteries with new ones.
- Close cover.

WATCHING TV / PROGRAMME CONTROL

(Only 42/50PG10**)

WATCHING TV / PROGRAMME CONTROL

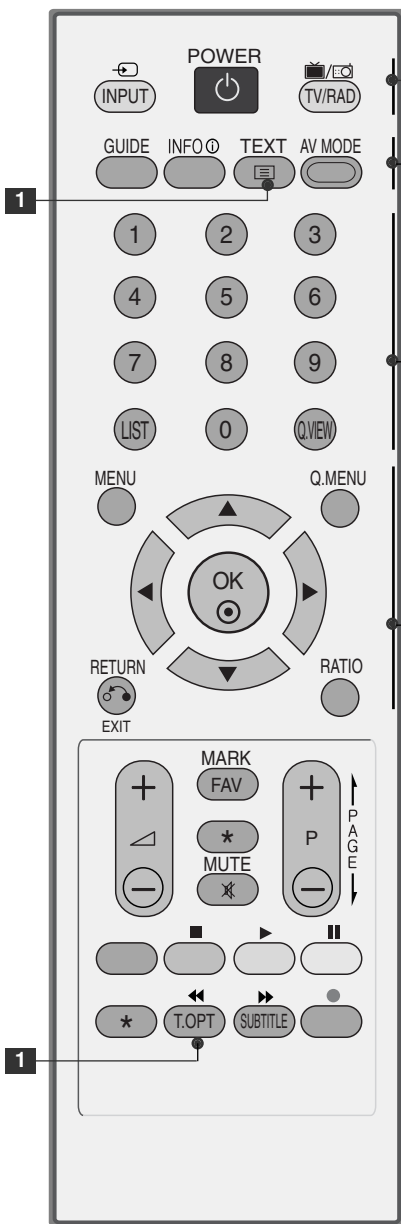

POWER Switches the TV on from standby or off to standby.

INPUT External input mode rotate in regular sequence. Switches the TV on from standby.

TV/RAD Selects Radio or TV channel in digital mode.

GUIDE Shows programme schedule.

INFO ⓘ Shows the present screen information.

1 **TELETEXT** These buttons are used for teletext. **BUTTONS** For further details, see the 'Teletext' section.

AV MODE It helps you select and set images and sounds when connecting AV devices.

0~9 number button Selects a programme. Selects numbered items in a menu.

LIST Displays the programme table.

Q.VIEW Returns to the previously viewed programme.

MENU Selects a menu. Clears all on-screen displays and returns to TV viewing from any menu.

Q.MENU Select the desired quick menu source.

THUMBSTICK Allows you to navigate the on-screen menus and adjust the system settings to your preference. (Up/Down/Left Right)

OK Accepts your selection or displays the current mode.

RETURN(EXIT) Allows the user to move back one step in an interactive application, EPG or other user interaction function.

RATIO Selects your desired picture format.

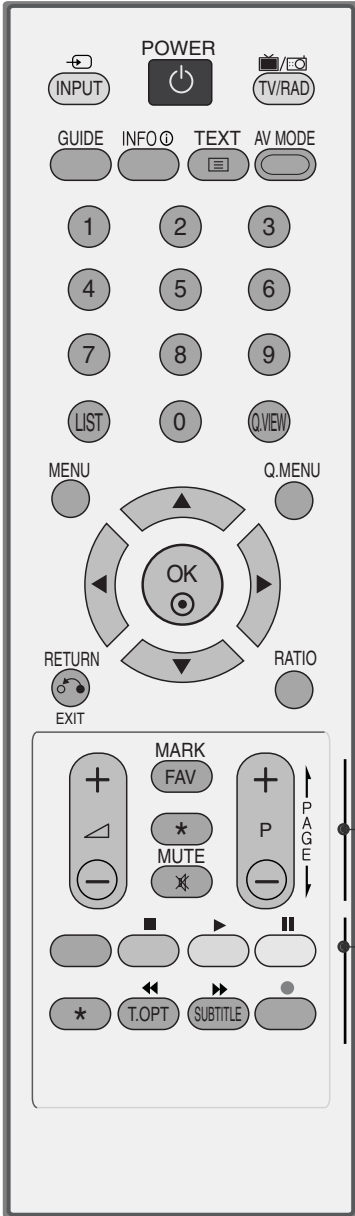

VOLUME UP /DOWN Adjusts the volume.

FAV Displays the selected favourite programme.

* No function

MUTE Switches the sound on or off.

Programme UP/DOWN Selects a programme.

Coloured buttons These buttons are used for teletext (on **TELETEXT** models only) or **Programme edit**.

SUBTITLE Recalls your preferred subtitle in digital mode.

SIMPLINK control buttons Controls simplink.

Installing Batteries

- Open the battery compartment cover on the back and install the batteries matching correct polarity (+with +,-with -).
- Install two 1.5V AAA batteries. Do not mix old or used batteries with new ones.
- Close cover.

WATCHING TV / PROGRAMME CONTROL

(Except for 19/22LS4D*, 42/50PG10**)

WATCHING TV / PROGRAMME CONTROL



1 **MODE** Selects the remote operating modes.

POWER Switches the TV on from standby or off to standby.

INPUT External input mode rotate in regular sequence. Switches the TV on from standby.

TV/RAD Selects Radio, TV, DTV channel.

RATIO Selects your desired picture format.

Q. MENU Select the desired quick menu source.

MENU Selects a menu. Clears all on-screen displays and returns to TV viewing from any menu.

GUIDE Shows programme schedule.

THUMBSTICK (Up/Down/Left/Right) Allows you to navigate the on-screen menus and adjust the system settings to your preference.

OK Accepts your selection or displays the current mode.

RETURN(EXIT) Allows the user to move back one step in an interactive application, EPG or other user interaction function.

INFO ⓘ Shows the present screen information.

AV MODE It helps you select and set images and sounds when connecting AV devices.

Coloured Buttons These buttons are used for teletext (on **TELETEXT** models only) , **Programme edit**.

2 **TELETEXT BUTTONS** These buttons are used for teletext. For further details, see the 'Teletext' section.

SUBTITLE Recalls your preferred subtitle in digital mode.

3 **SIMPLINK** See a list of AV devices connected to TV. When you toggle this button, the Simplink menu appears at the screen.



VOLUME UP /DOWN Adjusts the volume.

FAV Displays the selected favourite programme.

MUTE Switches the sound on or off.

Programme UP/DOWN Selects a programme.

PAGE UP/DOWN Move from one full set of screen information to the next one.

0~9 number button Selects a programme.
Selects numbered items in a menu.

LIST Displays the programme table.

Q.VIEW Returns to the previously viewed programme.

SIMPLINK control buttons Controls simplink.

Installing Batteries

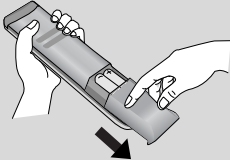

- Open the battery compartment cover on the back and install the batteries matching correct polarity (+with +,-with -).
- Install two 1.5V AAA batteries. Do not mix old or used batteries with new ones.
- Close cover.

WATCHING TV / PROGRAMME CONTROL

TURNING ON THE TV

- When your TV is turned on, you will be able to use its features.

- 1 Firstly, connect the power cord correctly.
At this stage, the TV switches to standby mode.
- 2 In standby mode to turn TV on, press the ϕ / I, INPUT or P \wedge \vee (or PR \blacktriangle \blacktriangledown) button on the TV or press the POWER, INPUT, D/A, P \wedge \vee (or (PR + - or P + -)) or NUMBER button on the remote control and the TV will switch on.

Initializing setup

If the OSD (On Screen Display) is displayed on the screen after turning on the TV, you can adjust the Language, Select Mode, Country, Time Zone, Auto programme tuning.

Note:

- a. It will automatically disappear after approx. 40 seconds unless a button is pressed.
- b. Press the RETURN button to change the current OSD to the previous OSD.
- c. For those countries without confirmed DTV broadcasting standards, some DTV features might not work, depending on the DTV broadcasting environment.
- d. "Home" mode is the optimal setting for home environments, and is the TV's default mode.
- e. "In Store" mode is the optimal setting for store environments." If a user modifies image quality data, "In Store" mode initializes the product to the image quality set by us after a certain period of time.
- f. The mode (Home, In Store) can be changed by executing Factory Reset in the OPTION menu.

PROGRAMME SELECTION

- 1 Press the P \wedge \vee (or (PR + - or P + -)) or NUMBER buttons to select a programme number.

VOLUME ADJUSTMENT

- 1 Press the VOL + - (or \blacktriangle + -) button to adjust the volume.





If you wish to switch the sound off, press the MUTE button.

You can cancel this function by pressing the MUTE, VOL + - (or \blacktriangle + -), or I/II button.

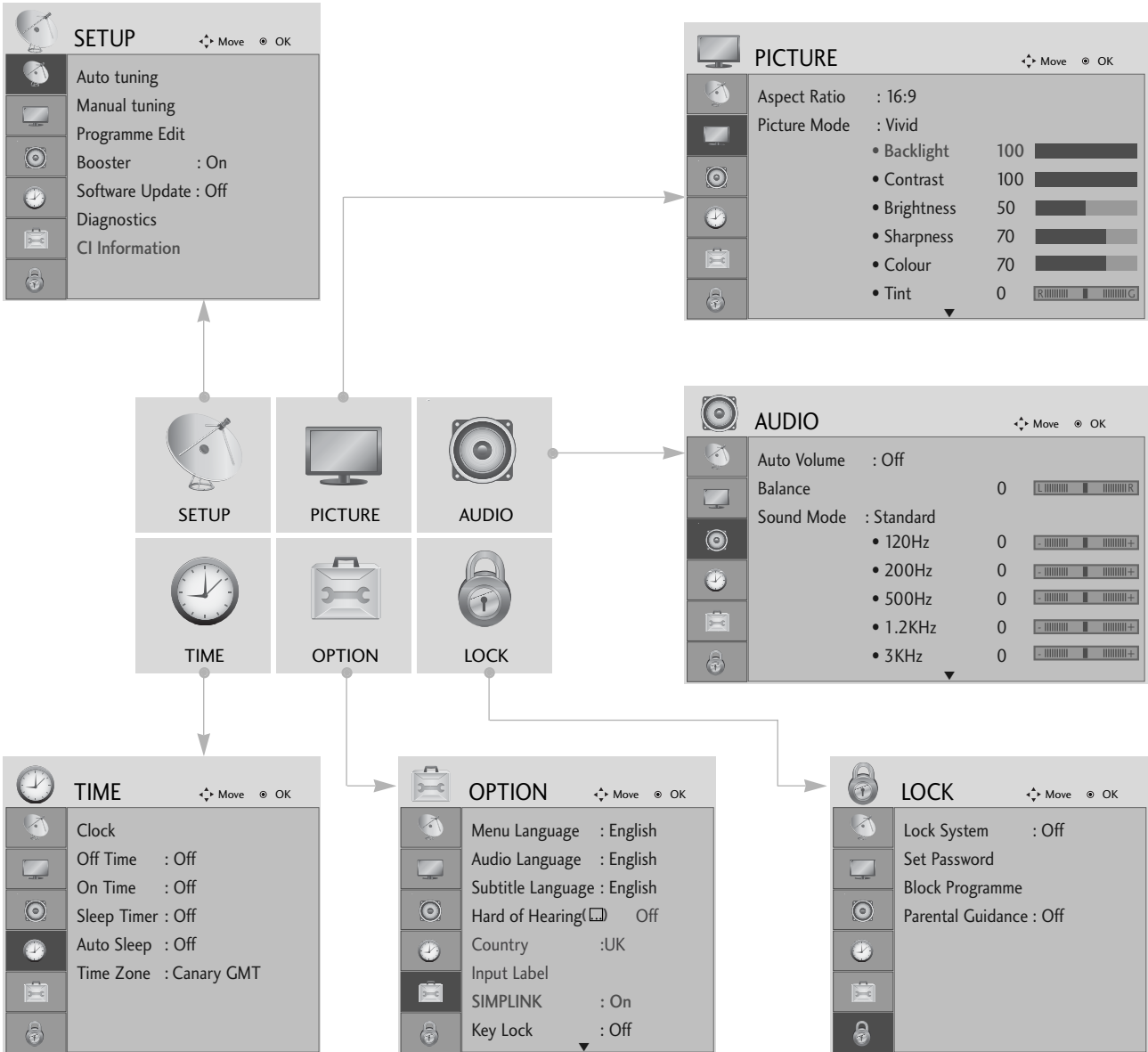
ON SCREEN MENUS SELECTION AND ADJUSTMENT

Your TV's OSD (On Screen Display) may differ slightly from what is shown in this manual.



- 1   Display each menu.
- 2   Select a menu item.
- 3  Move to the pop up menu.

- Press the **MENU** button to return to normal TV viewing.
- Press the **RETURN** button to move to the previous menu screen.

WATCHING TV / PROGRAMME CONTROL

AUTO PROGRAMME TUNING

Use this to automatically find and store all available programmes.

When you start auto programming in digital mode, all previously stored service information will be deleted.

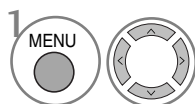
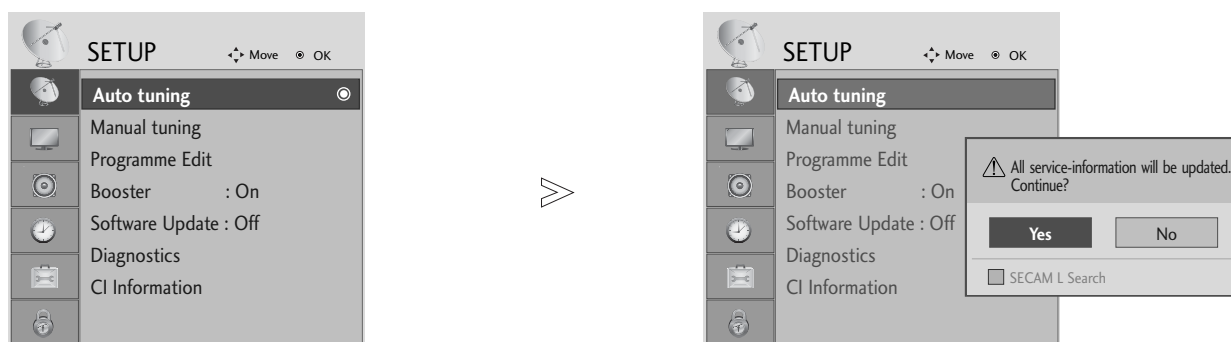

Select **SETUP**.

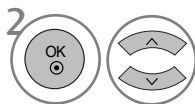

Select **Auto Tuning**.

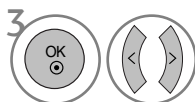

Select **Yes**.



Run **Auto tuning**.

- Use **NUMBER** buttons to input a 4-digit password in **Lock System 'On'**.
- If you wish to keep on auto tuning select **YES** using the < > button. Then, press the **OK** button. Otherwise select **NO**.

- Press the **MENU** button to return to normal TV viewing.
- Press the **RETURN** button to move to the previous menu screen.

MANUAL PROGRAMME TUNING (IN DIGITAL MODE)

Manual Tuning lets you manually add a programme to your programme list.

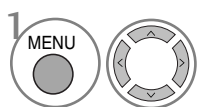
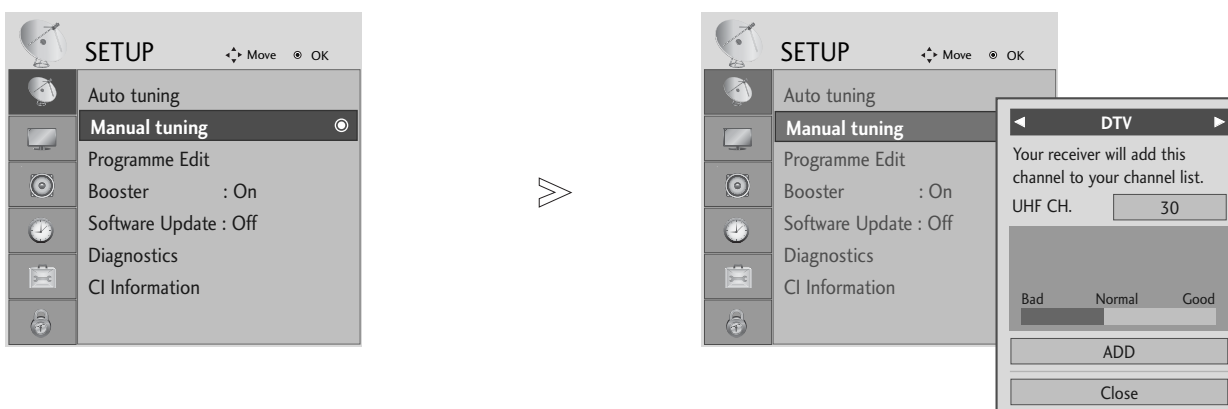

1 Select **SETUP**.

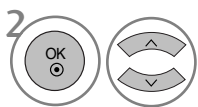

2 Select **Manual Tuning**.

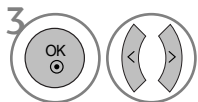

3 Select **DTV**.

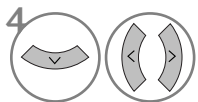

4 Select the desired channel number.

- Use **NUMBER** buttons to input a 4-digit password in Lock System 'On'.

- Press the **MENU** button to return to normal TV viewing.
- Press the **RETURN** button to move to the previous menu screen.

WATCHING TV / PROGRAMME CONTROL

MANUAL PROGRAMME TUNING (IN ANALOGUE MODE)

Manual Tuning lets you manually tune and arrange the stations in whatever order you desire.

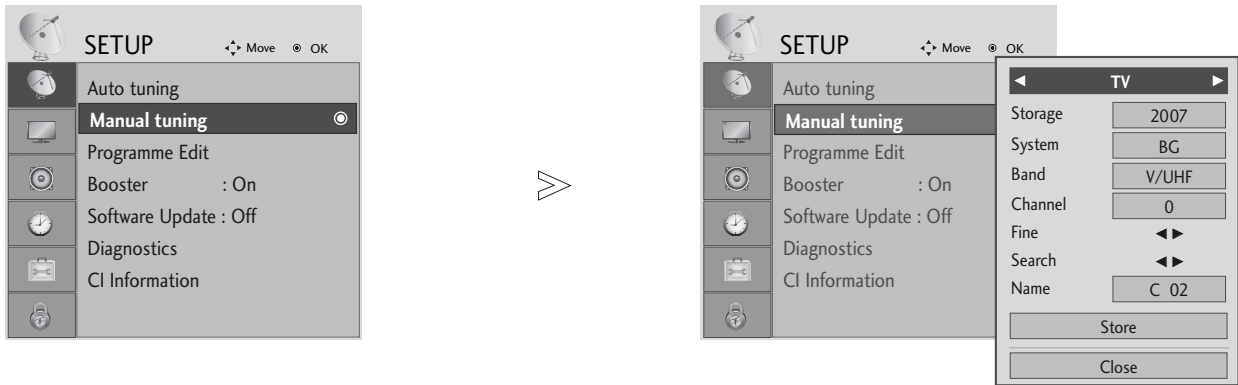

- 1 Select **SETUP**.
- 2 Select **Manual Tuning**.
- 3 Select **TV**.
- 4 or Select the desired programme number on.
- 5 Select a TV system.
- 6 Select **V/UHF or Cable**.
- 7 or Select the desired channel number.
- 8 Commence searching.
- 9 Select **Store**.

- Press the **MENU** button to return to normal TV viewing.
- Press the **RETURN** button to move to the previous menu screen.

- Use **NUMBER** buttons to input a 4-digit password in Lock System 'On'.
- **L** : SECAM L/L' (France)
- **BG** : PAL B/G, SECAM B/G (Europe / East Europe / Asia / New Zealand / M.East / Africa / Australia)
- **I** : PAL I/II (U.K. / Ireland / Hong Kong / South Africa)
- **DK** : PAL D/K, SECAM D/K (East Europe / China / Africa / CIS)
- To store another channel, repeat steps 4 to 9.

■ Assigning a station name

You can assign a station name with five characters to each programme number.

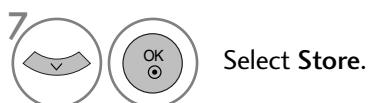
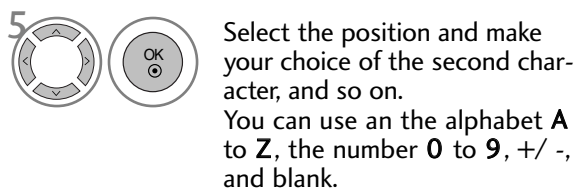
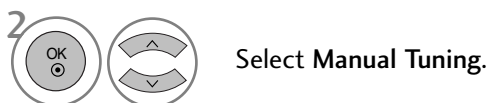

■ Fine Tuning

Normally fine tuning is only necessary if reception is poor.

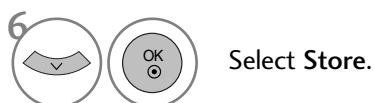
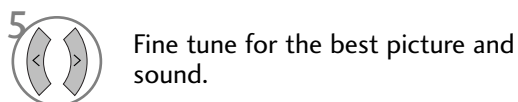
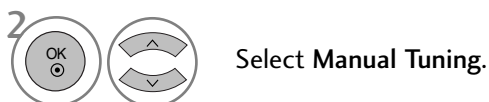

- Press the **MENU** button to return to normal TV viewing.
- Press the **RETURN** button to move to the previous menu screen.

WATCHING TV / PROGRAMME CONTROL

PROGRAMME EDIT

When a programme number is skipped, it means that you will be unable to select it using **P** ^ v (or **PR** + / -) button during TV viewing.

If you wish to select the skipped programme, directly enter the programme number with the **NUMBER** buttons or select it in the Programme edit menu

This function enables you to skip the stored programmes.

In some countries it is possible to move a programme number by using the **YELLOW** button only.

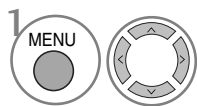
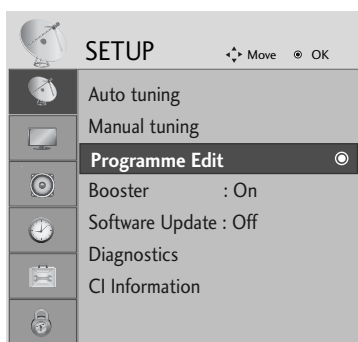

Select **SETUP**.

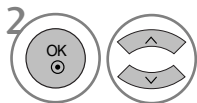

Select **Programme Edit**.



Enter the **Programme Edit**.



Select a programme to be stored or skipped.

- Use **NUMBER** buttons to input a 4-digit password in **Lock System 'On'**.

- Press the **MENU** button to return to normal TV viewing.
- Press the **RETURN** button to move to the previous menu screen.

(IN DTV/RADIO MODE)

■ Skipping a programme number



Select a programme number to be skipped.



Turn the skipped programme number to blue.



Release the skipped programme.

- When a programme number is skipped it means that you will be unable to select it using the P ^ v (or PR + / -) button during normal TV viewing.
- If you wish to select a skipped programme, directly enter the programme number with the NUMBER buttons or select it in the programme edit or EPG.

■ Selecting favourite programme



Select your favourite programme number.

- It will automatically include the selected programme into your favourite programme list.

WATCHING TV / PROGRAMME CONTROL

IN TV MODE



This function enables you to delete or skip the stored programmes.
You can also move some channels to other programme numbers.

■ Auto Sort

- 1  **GREEN** Start Auto Sort.





• After activating Auto Sort once, you can no longer edit programmes.

■ Deleting a programme



- 1  Select a programme number to be deleted.
- 2  **RED** Turn the deleted programme number to red.
- 3  **RED** Release the deleted programme.

• The selected programme is deleted, all the following programmes are shifted up one

■ Moving a programme



- 1  Select a programme number to be moved.
- 2   **YELLOW** Turn the moved programme number to YELLOW.
- 3  **YELLOW** Release the moved programme.

■ Skipping a programme number

- 1  Select a programme number to be skipped.
- 2  **BLUE** Turn the skipped programme number to blue.
- 3  **BLUE** Release the skipped programme.

• When a programme number is skipped it means that you will be unable to select it using the P ^ v (or PR + / -) button during normal TV viewing.
• If you wish to select a skipped programme, directly enter the programme number with the NUMBER buttons or select it in the programme edit or EPG.

■ Selecting a Favourite Programme





- 1   **FAV** Select your favourite programme number.

• The selected programme will be added to the favourite programme list.

BOOSTER (IN DIGITAL MODE ONLY)

If reception is poor, select **Booster** to **On**.
When the signal is strong, select "Off".

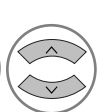

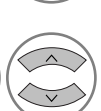
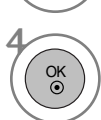
-   Select **SETUP**.
-   Select **Booster**.
-   Select **On** or **Off**.
-  Save.

- Press the **MENU** button to return to normal TV viewing.
- Press the **RETURN** button to move to the previous menu screen.

WATCHING TV / PROGRAMME CONTROL

SOFTWARE UPDATE

Software Update means software can be downloaded through the digital terrestrial broadcasting system.

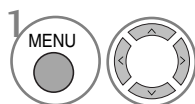
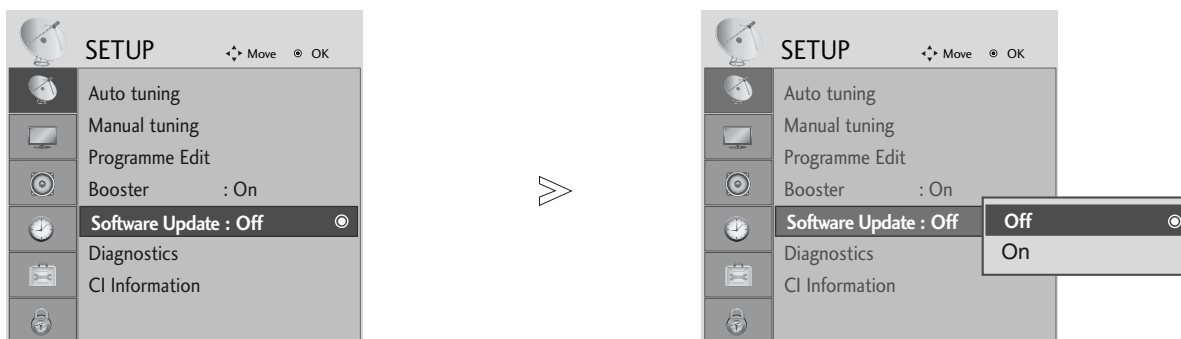

Select SETUP.

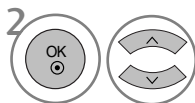

Select Software Update.

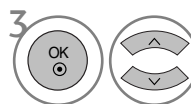

Select On or Off.

• If you select On, a user confirm message box will be displayed to notify that new software is found.

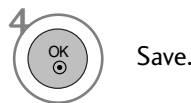

Save.

* When setting “Software Update”

Occasionally, a transmission of updated digital software information will result in the following menu on the TV screen.

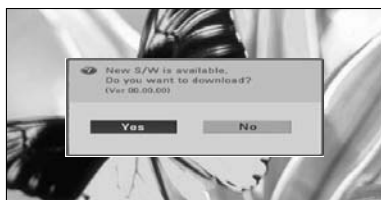

When the Software Update menu is “Off”, the message to change it to “On” appears.

Select the **YES** using the < > button and you will see the following picture.

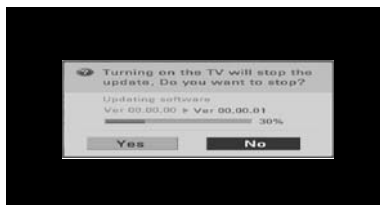

When the power is turned off, downloading starts.

When the power is turned on while updating, the progress status is displayed.

After the Software Update is complete, the System restarts.

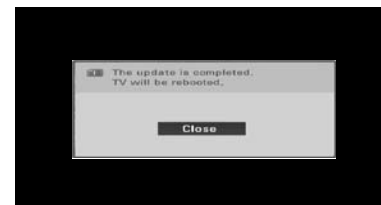

- During Progress of a Software Update, please note the following:

- Power to the TV must not be interrupted.
- The TV must not be switched off.
- The antenna must not be disconnected.
- After Software Update, you can confirm the updated software version in Diagnostics menu.





DIAGNOSTICS (IN DIGITAL MODE ONLY)

This function enables you to view information on the Manufacturer, Model/Type, Serial Number and Software Version.

This displays the information and signal strength of the tuned MUX.

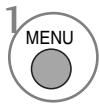
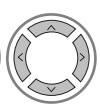
This displays the signal information and service name of the selected MUX.

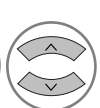

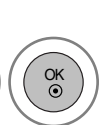
-   Select **SETUP**.
-   Select **Diagnostics**.
-  Display Manufacturer, Model/Type, Serial Number and Software Version.
-   Display the information of Channel.

- Press the **MENU** button to return to normal TV viewing.
- Press the **RETURN** button to move to the previous menu screen.

WATCHING TV / PROGRAMME CONTROL

CI [COMMON INTERFACE] INFORMATION

This function enables you to watch some encrypted services (pay services). If you remove the CI Module, you cannot watch pay services.

When the module is inserted into the CI slot, you can access the module menu.

To purchase a module and smart card, contact your dealer. Do not repeatedly insert or remove a CAM module from the TV. This may cause a malfunction. When the TV is turned on after inserting a CI Module, you may not have any sound output.

This may be incompatible with the CI module and smart card.

CI (Common Interface) functions may not be possible depending upon the country broadcasting circumstances.

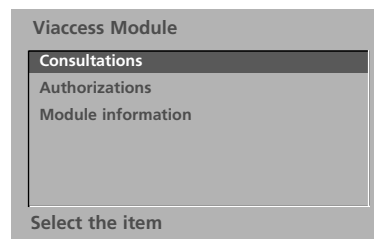
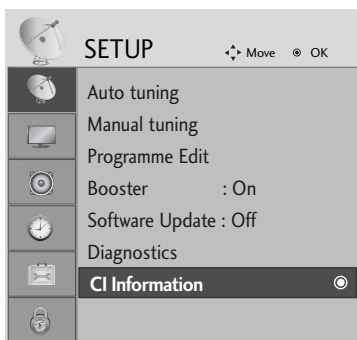

- This OSD is only for illustration and the menu options and screen format will vary according to the Digital pay services provider.
- It is possible for you to change CI (Common Interface) menu screen and service by consulting your dealer.



1 Select **SETUP**.

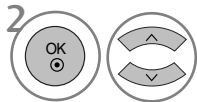

2 Select **CI Information**.

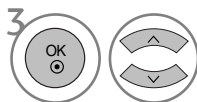

3 Select the desired item: Module information, smart card information, language, or software download etc.



4 Save.

- Press the **MENU** button to return to normal TV viewing.
- Press the **RETURN** button to move to the previous menu screen.

SELECTING THE PROGRAMME TABLE

You can check which programmes are stored in the memory by displaying the programme table.

 Displayed when the Locked Programme.

■ Displaying programme LIST



1  display the PROGRAMME LIST.

- You may find some blue programmes. These have been set up to be skipped by auto programming or in the programme edit mode.
- Some programmes with the channel number shown in the programme LIST indicate there is no station name assigned.

■ Selecting a programme in the programme list

1  Select a programme.

2  Switch to the chosen programme number.

 or  From the programme you are currently watching, the mode will change from TV to DTV to Radio.

■ Paging through a programme list

1  Turns the pages.

2  Return to normal TV viewing.

■ Displaying the favourite programme table

1  Display the Favourite Programme table.

WATCHING TV / PROGRAMME CONTROL

(Except for 19/22LS4D*, 42/50PG10**)

This function operates only with devices with the SIMPLINK logo.
Please check the SIMPLINK logo.





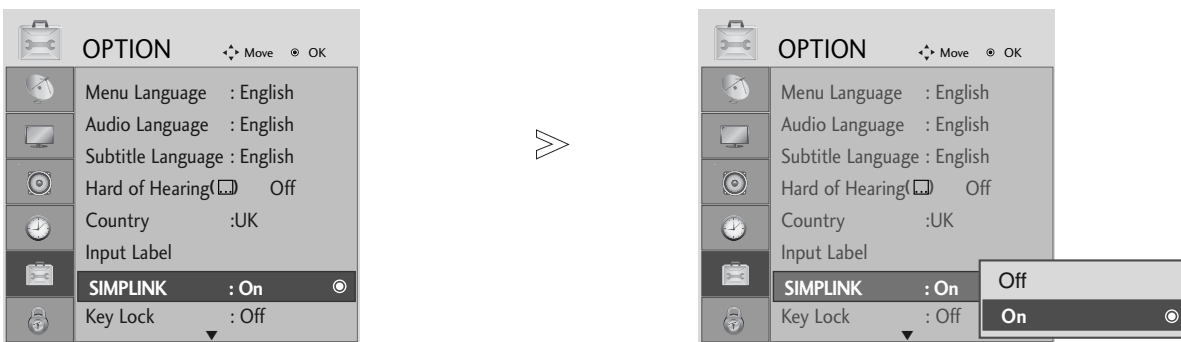

This TV might not function properly when using it with other products with HDMI-CEC function.

This allows you to control and play other AV devices connected to the display through HDMI cable without additional cables and settings.

If you do not want SIMPLINK menu, select “Off”.

SIMPLINK function is not supported by HDMI IN 3 input.



-   Select **OPTION**.
-   Select **SIMPLINK**.
-   Select **On** or **Off**.
-  Save.

- Press the **MENU** button to return to normal TV viewing.
- Press the **RETURN** button to move to the previous menu screen.

NOTE

- ▶ Connect the HDMI/DVI IN or HDMI IN terminal of the TV to the rear terminal (HDMI terminal) of the SIMPLINK device with the HDMI cable.
- ▶ After connecting the HDMI terminal for the home theatre with the SIMPLINK function using the above method, connect the DIGITAL AUDIO OUT terminal on the back of the TV to the DIGITAL AUDIO IN terminal on the back of the SIMPLINK device with the OPTICAL cable.
- ▶ When operating an external device with SIMPLINK, press the TV button from the MODE buttons on the remote control.
- ▶ When you switch the Input source using the INPUT button on the remote control, you can stop the operation of a device controlled by SIMPLINK
- ▶ When you select or operate a media device with home theater function, the speaker automatically switches to home theater speaker (HT speaker).

SIMPLINK Functions

Disc playback

Control connected AV devices by pressing the \wedge \vee \lt \gt , OK, \blacktriangleright , \blacksquare , \parallel , \ll and \gg buttons. (The \bullet button does not provide such functions.)

Direct Play

After connecting AV devices to the TV, you can directly control the devices and play media without additional settings.

Select AV device

Enables you to select one of the AV devices connected to the TV and operate it.

Power off all devices

When you switch off the TV, all connected devices are turned off.

Switch audio-out

Offers an easy way to switch audio-out.

Sync Power on

The TV will change automatically to turn on mode, after the Player with Simplink function start to reproduce through connection HDMI.

* A device, which is connected to the TV through a HDMI cable but does not support SIMPLINK, does not provide this function.

SIMPLINK Menu

Press the \wedge \vee \lt \gt button and then OK button to select the desired SIMPLINK source.

- ① **TV viewing** : Switch to the previous TV programme regardless of the current mode.
- ② **DISC playback** : Select and play connected discs. When multiple discs are available, the titles of discs are conveniently displayed at the bottom of the screen.
- ③ **VCR playback** : Play and control the connected VCR.
- ④ **HDD Recordings playback** : Play and control recordings stored in HDD.
- ⑤ **Audio Out to Home theater/Audio Out to TV:** Select Home theater or TV speaker for Audio Out.

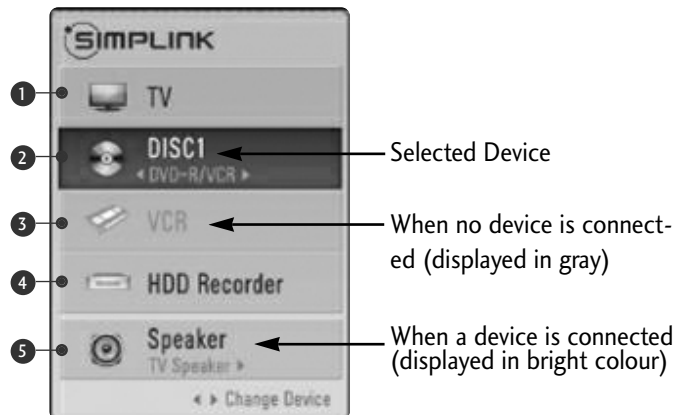





- Home theater: Only one supported at once
- DVD, Recorder: Up to three supported at once
- VCR: Only one supported at once

WATCHING TV / PROGRAMME CONTROL

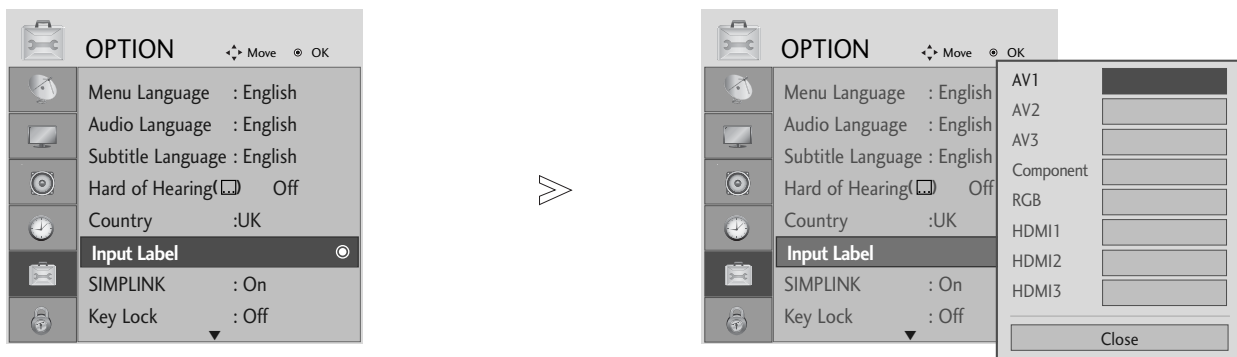
INPUT LABEL

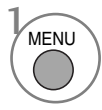
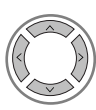
Selects a label for each input source.

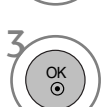
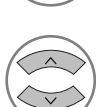
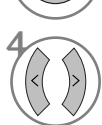

-   Select **OPTION**.
-    Select **Input Label**.
-   Select the source.
-  Select the label.

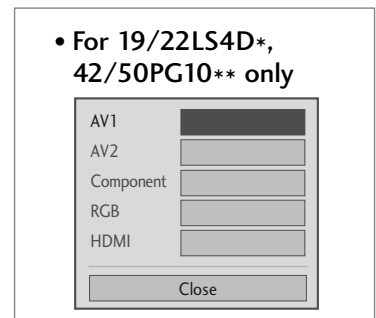

- Press the **MENU** button to return to normal TV viewing.
- Press the **RETURN** button to move to the previous menu screen.

AV MODE

You can select the optimal images and sounds when connecting AV devices to external input.

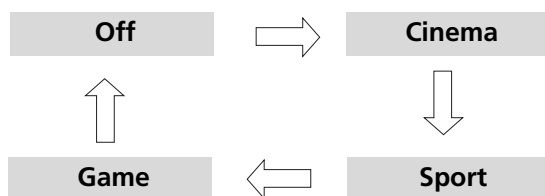

Select the desired source.



- If you select Cinema Mode in AV mode, Cinema mode will be selected both for Picture Mode and Sound Mode in PICTURE menu and AUDIO menu respectively.
- If you select "Off" in AV mode, the picture and image which you initially set will be selected.

EPG (ELECTRONIC PROGRAMME GUIDE) (IN DIGITAL MODE)

This system has an Electronic Programme Guide (EPG) to help your navigation through all the possible viewing options.

The EPG supplies information such as programme listings, start and end times for all available services. In addition, detailed information about the programme is often available in the EPG (the availability and amount of these programme details will vary, depending on the particular broadcaster).

This function can be used only when the EPG information is broadcasted by broadcasting companies.

The EPG displays the programme description for next 8 days.

Switch on/off EPG



Switch on or off EPG.

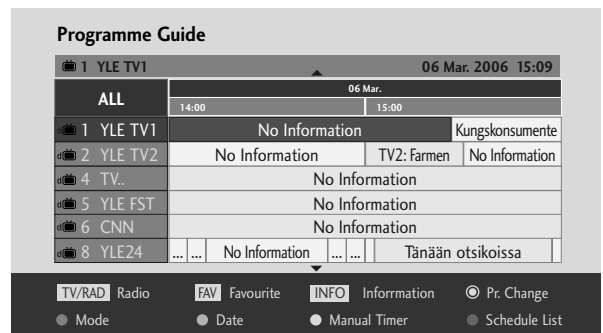

Select a programme



or



or















Select desired programme.

















Display the selected programme.







Button Function in NOW/NEXT Guide Mode

- | | |
|--|---|
| <ul style="list-style-type: none">  RED Change EPG mode.  YELLOW Enter Timer Record/Remind setting mode.  BLUE Enter Timer Record/Remind list mode.  OK Change to the selected programme.  Select NOW or NEXT Programme. | <ul style="list-style-type: none">  Select the Broadcast Programme.  or  Page Up/Down.  or  Switch off EPG.  or  Select TV or RADIO Programme.  The detail information on or off. |
|--|---|

Button Function in 8 Day Guide Mode

- | | |
|--|--|
| <ul style="list-style-type: none">  RED Change EPG mode.  GREEN Enter Date setting mode.  YELLOW Enter Timer Record/Remind setting mode.  BLUE Enter Timer Record/Remind list mode.  OK Change to the selected programme.  Select NOW or NEXT Programme. | <ul style="list-style-type: none">  Select the Broadcast Programme.  or  Page Up/Down.  or  Switch off EPG.  or  Select TV or RADIO Programme.  The detail information on or off. |
|--|--|

Button Function in Date Change Mode

- | | |
|--|--|
| <ul style="list-style-type: none">  GREEN Switch off Date setting mode.  OK Change to the selected date.  Select a date. | <ul style="list-style-type: none">  Switch off Date setting mode.  or  Switch off EPG. |
|--|--|

EPG (ELECTRONIC PROGRAMME GUIDE) (IN DIGITAL MODE)

Button Function in Extended Description Box



Text Up/Down.



Enter Timer Record/Remind setting mode.



The detail information on or off.



or



Switch off EPG.

Button Function in Record/Remind Setting Mode

- This function is available only when recording equipment that use pin8 recording signalling has been connected to the DTV-OUT terminal, using a SCART cable.
- Two hours after the TV is switched on by the Remind function it will automatically switch back to standby mode unless a button has been pressed.



Change to Guide or Timer list mode.



Save Timer Record/Remind.



Select Type, Service, Date or Start/End time.



Function setting.

Button Function in Schedule List Mode



Add new Manual Timer setting mode.



Enter Schedule list editing mode.



Delete the selected item.



Change to Guide mode.



Select Schedule list.

PICTURE CONTROL

PICTURE SIZE (ASPECT RATIO) CONTROL

You can watch the screen in various picture formats; 16:9, Just Scan, Original, 4:3, 14:9 and Zoom1/2.

If a fixed image is displayed on the screen for a long time, that fixed image may become imprinted on the screen and remain visible.

You can adjust the enlarge proportion using $\wedge \vee$ button.

This function works in the following signal.

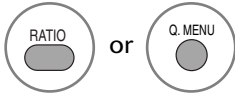

Select the desired picture format.

- You can also adjust **Aspect Ratio** in the **PICTURE** or **Q.MENU** menu.
- For Zoom Setting, select **14:9**, **Zoom1** and **Zoom2** in Ratio Menu. After completing Zoom Setting, the display goes back to **Q.MENU**.

• 16:9

The following selection will allow you to adjust the picture horizontally, in linear proportion, to fill the entire screen (useful for viewing 4:3 formatted DVDs).



• 4:3

The following selection will allow you to view a picture with an original 4:3 aspect ratio, grey bars will appear on both the left and right of the screen.



PICTURE CONTROL

- **Original**

When your TV receives a wide screen signal it will automatically change to the picture format broadcast.

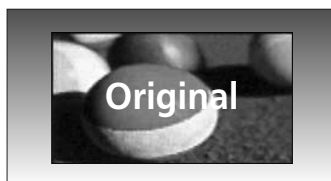

- **14:9**

You can view a picture format of 14:9 or a general TV programme in the 14:9 mode. The 14:9 screen is viewed in the same way as in 4:3, but is magnified to the left and right.



- **Zoom 1**

The following selection will allow you to view the picture without any alteration, while filling the entire screen. However, the top and bottom of the picture will be cropped.

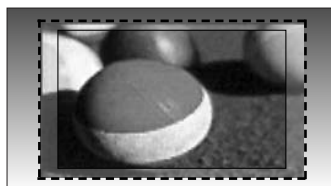

- **Zoom 2**

Choose Zoom 2 when you wish the picture to be altered, both horizontally extended and vertically cropped. The picture adopting a compromise between alteration and screen coverage.



- **Just Scan**

Following Selection will lead to you view the picture of best quality without loss of original picture in high resolution image.

Note: If there are interference in original picture, you can view interference at the edge.



! NOTE





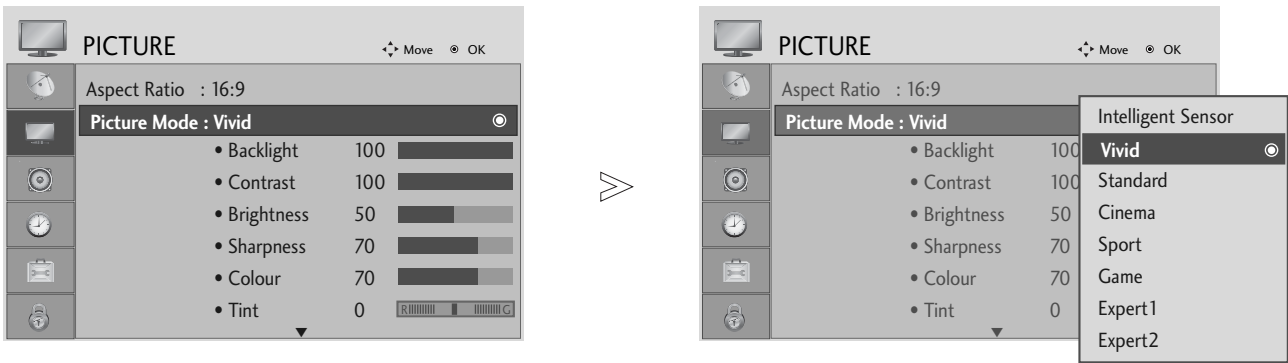

- ▶ You can only select 16:9 (Wide), 4:3, 14:9, Zoom 1/2 in Component (under 720p) mode.
- ▶ You can only select 4:3, 16:9 (Wide) in RGB/HDMI[PC] mode only.
- ▶ In HDMI/Component (over 720p) mode, Just Scan is available.
- ▶ You can only select Original in UK digital teletext (MHEG-5).

PRESET PICTURE SETTINGS

Picture Mode-Preset

- ▶ It is possible to use **Intelligent Sensor** in 32/37/42/47/52LG5*** models only.
- ▶ In PLASMA TV models, **Backlight** will not be displayed.



- 

 Select **PICTURE**.
- 

 Select **Picture Mode**.
- 

 Select desired picture value.

- **Picture Mode** adjusts the TV for the best picture appearance. Select the preset value in the **Picture Mode** menu based on the programme category.
- When the **Intelligent sensor** function is on, the most suitable picture is automatically adjusted according to the surrounding conditions. (32/37/42/47/52LG5*** only)
- You can also adjust **Picture Mode** in the **Q. Menu**.
- **Intelligent Sensor** : Adjusts picture according to the surrounding conditions. (32/37/42/47/52LG5*** only)





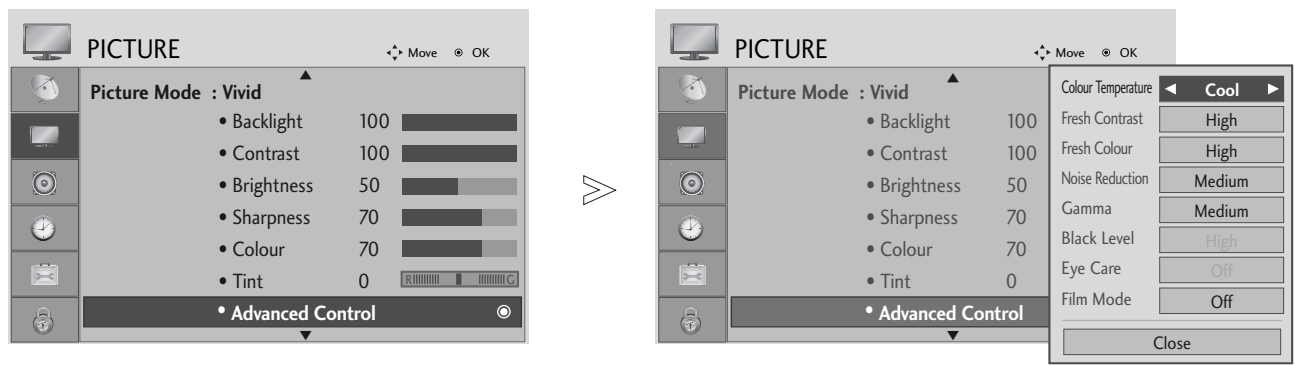

- Press the **MENU** button to return to normal TV viewing.
- Press the **RETURN** button to move to the previous menu screen.

PICTURE CONTROL

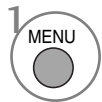
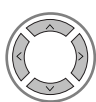
Auto Colour Tone Control (Warm/Medium/Cool)

Choose one of three automatic colour adjustments. Set to warm to enhance hotter colours such as red, or set to cool to see less intense colours with more blue.



-   Select **PICTURE**.
-   Select **Advanced Control**.
-   Select **Colour Temperature**.
-  Select either **Cool, Medium or Warm**.



- Press the **MENU** button to return to normal TV viewing.
- Press the **RETURN** button to move to the previous menu screen.

MANUAL PICTURE ADJUSTMENT

Picture Mode-User option

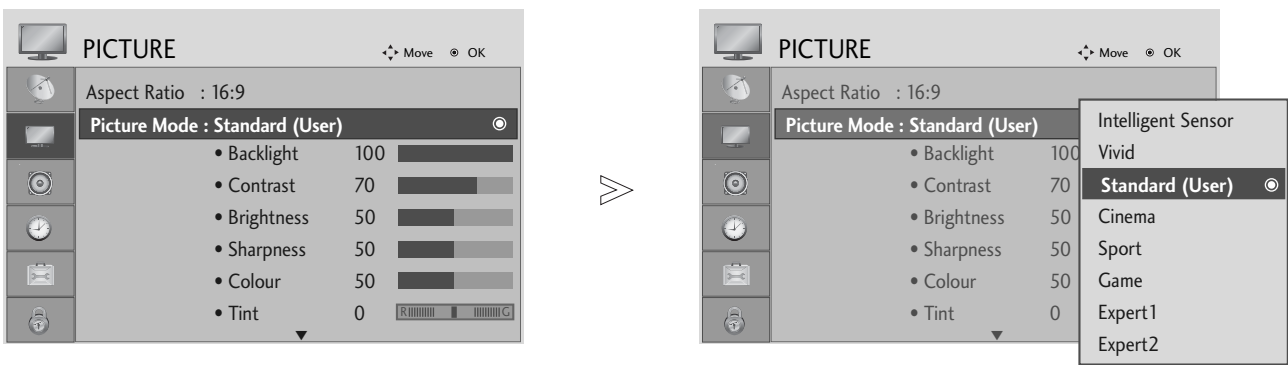
- ▶ It is possible to use Intelligent Sensor in 32/37/42/47/52LG5*** models only.
- ▶ In PLASMA TV models, Backlight will not be displayed.

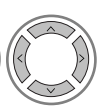

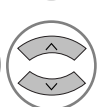
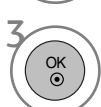
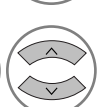
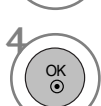
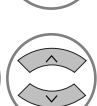
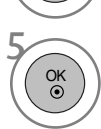
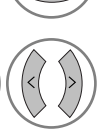
-   Select **PICTURE**.
-   Select **Picture Mode**.
-   Select desired picture value.
-   Select **Backlight (LCD TV Only), Contrast, Brightness, Sharpness, Clour or Tint**.
-   Make appropriate adjustments.

- Press the **MENU** button to return to normal TV viewing.
- Press the **RETURN** button to move to the previous menu screen.

! NOTE









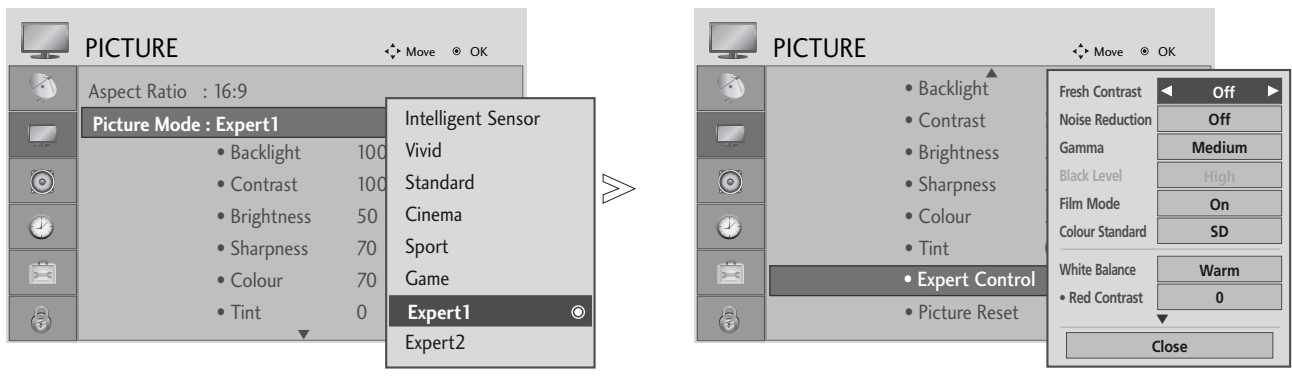

- ▶ You can not adjust colour, sharpness and tint in the RGB-PC mode.

PICTURE CONTROL

Picture Mode-Expert Control

By segmenting categories, Expert1 and Expert2 provide more categories which users can set as they see fit, offering the optimal picture quality for users.



- 1   Select PICTURE.
- 2   Select Picture Mode.
- 3   Select Expert1 or Expert2.
- 4   Select Expert Control.
- 4   Select your desired Source.
- 5  Make appropriate adjustments.

- Press the MENU button to return to normal TV viewing.
- Press the RETURN button to move to the previous menu screen.

PICTURE IMPROVEMENT TECHNOLOGY

Fresh Contrast

Optimizes the contrast automatically according to the brightness of the reflection.

Fresh Colour

Adjusts the colour of the reflection automatically to reproduce as close as possible natural colours.





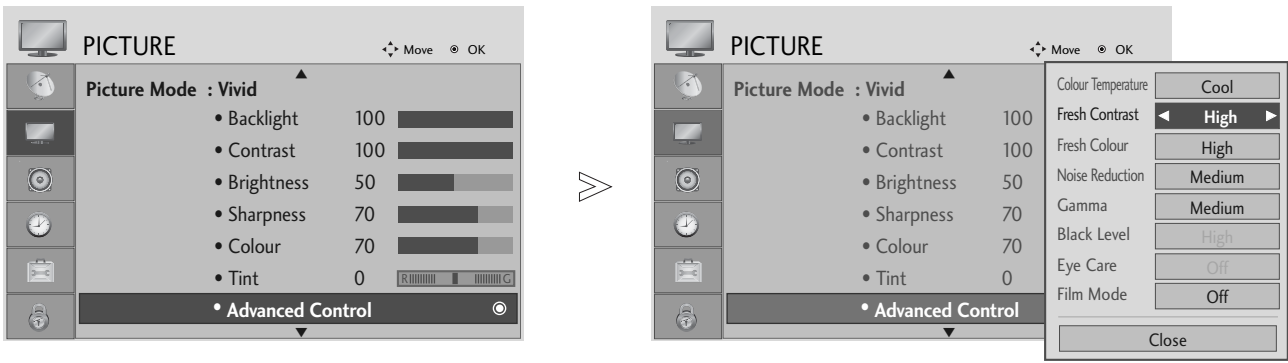

Noise Reduction

Removes interference up to the point where it does not damage the original picture.

Gamma

High gamma values display whitish images and low gamma values display high contrast images.



- 1   Select PICTURE.
- 2   Select Advanced Control.
- 3   Select Fresh Contrast, Fresh Colour, Noise Reduction or Gamma.
- 4  Select your desired Source.

- Press the MENU button to return to normal TV viewing.
- Press the RETURN button to move to the previous menu screen.





PICTURE CONTROL

ADVANCED - FILM MODE

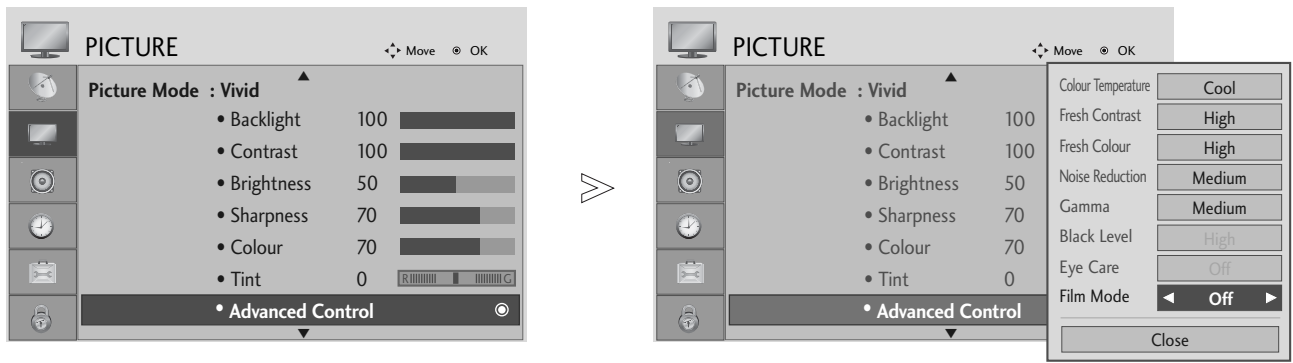
To set the TV up for the best picture quality for viewing films.

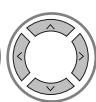
This feature operates only in TV, AV and Component 480i/576i/1080i mode.

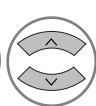

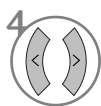
-   Select **PICTURE**.
-   Select **Advanced Control**.
-   Select **Film Mode**.
-  Select **On or Off**.





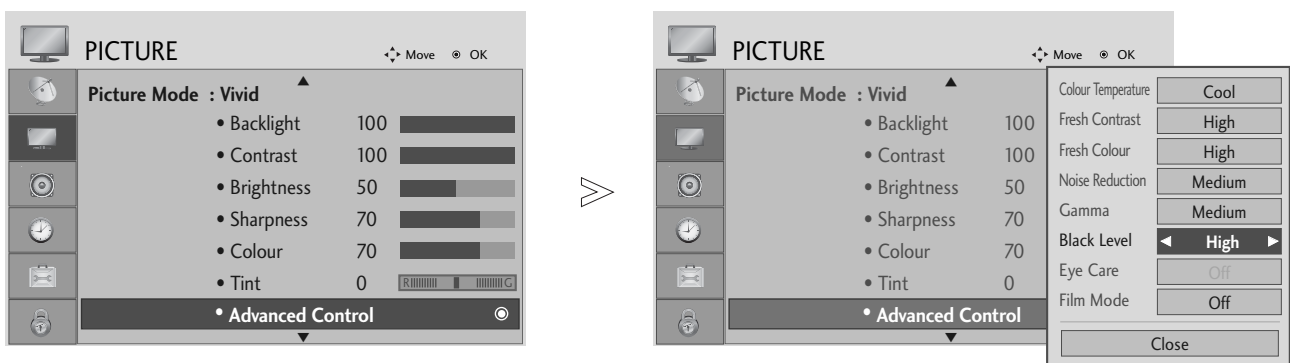

- Press the **MENU** button to return to normal TV viewing.
- Press the **RETURN** button to move to the previous menu screen.

ADVANCED - BLACK(DARKNESS) LEVEL

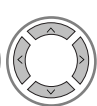
When you view a film this function adjusts the TV to best picture quality.

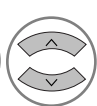
This function works in the following mode: AV (NTSC-M), HDMI or Component.

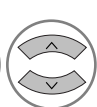
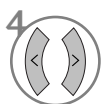

- 1   Select **PICTURE**.
- 2   Select **Advanced Control**.
- 3   Select **Black Level**.
- 4   Select **Low or High**.

- **Low** : The reflection of the screen gets darker.
- **High** : The reflection of the screen gets brighter.
- **Auto** : Realizing the black level of the screen and set it to High or Low automatically.





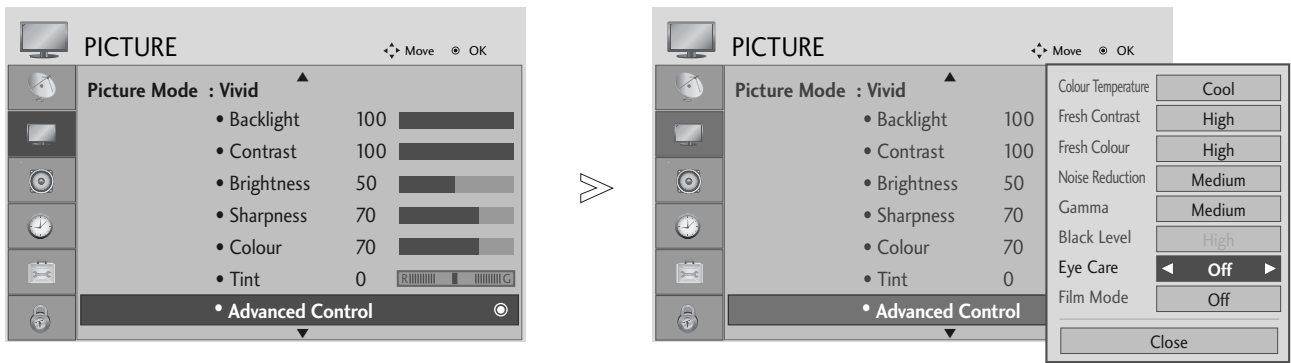

- Press the **MENU** button to return to normal TV viewing.
- Press the **RETURN** button to move to the previous menu screen.

PICTURE CONTROL

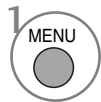
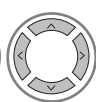
EYE CARE (LCD TV ONLY)

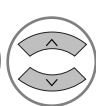
It helps you adjust brightness when the screen is too bright to prevent dazzling.







-   Select **PICTURE**.
-   Select **Advanced Control**.
-   Select **Eye Care**.
-  Select **On or Off**.

- Press the **MENU** button to return to normal TV viewing.
- Press the **RETURN** button to move to the previous menu screen.

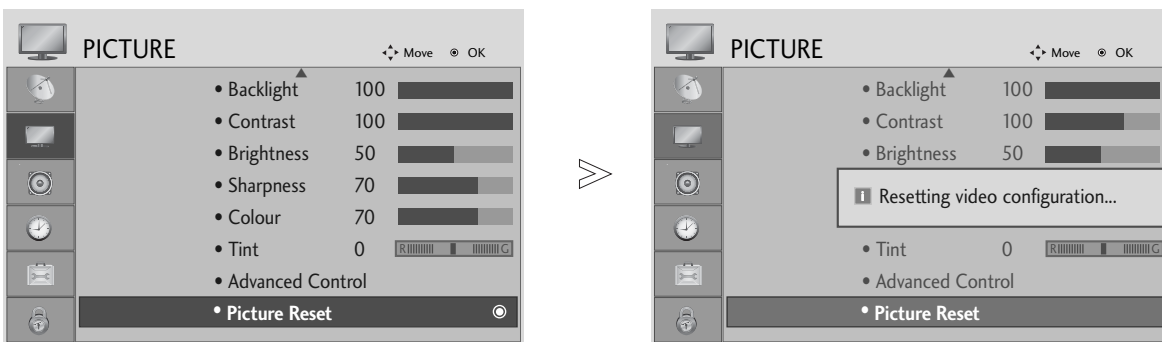
PICTURE RESET

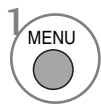
Settings of the selected picture modes return to the default factory settings.

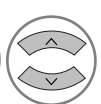

-   Select **PICTURE**.
-   Select **Picture Reset**.
-  Initialize the adjusted value.

- Press the **MENU** button to return to normal TV viewing.
- Press the **RETURN** button to move to the previous menu screen.

PICTURE CONTROL

IMAGE STICKING MINIMIZATION (ISM) METHOD

(PLASMA TV ONLY)

A frozen or still picture from a PC/Video game displayed on the screen for prolonged periods will result in a ghost image remaining even when you change the image. Avoid allowing a fixed image to remain on the screen for prolonged periods.

White wash

White wash removes permanent images from the screen.

Note: An excessive permanent image may be impossible to clear entirely with White Wash.





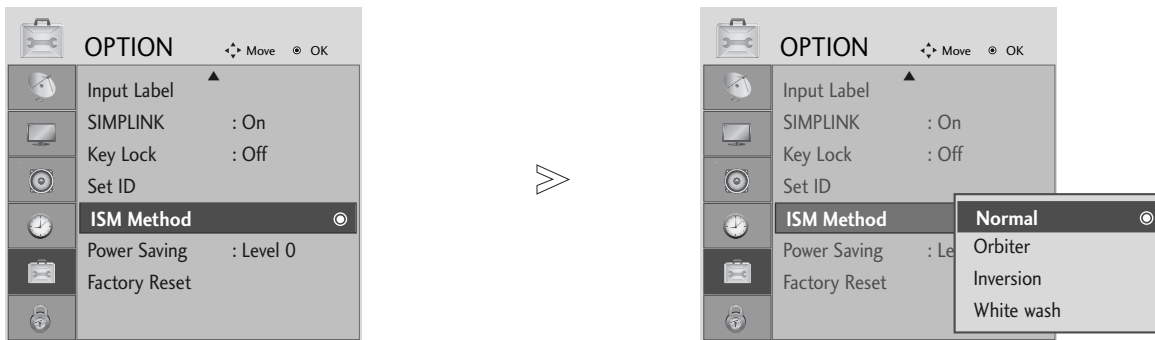

Orbiter

Orbiter may help prevent ghost images. However, it is best not to allow any fixed image to remain on the screen. To avoid a permanent image on the screen, the screen will move every 2 minutes.

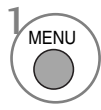
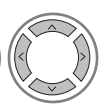
Inversion

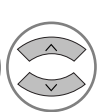
This function inverts the panel colour of the screen. The panel colour is automatically inverted every 30 minutes.

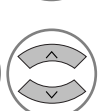

-   Select **OPTION**.
-   Select **ISM Method**.
-   Select **Normal, Orbiter, Inversion or White wash**.
-  Save.

• If you do not need this function, set **Normal**.

- Press the **MENU** button to return to normal TV viewing.
- Press the **RETURN** button to move to the previous menu screen.

POWER SAVING PICTURE MODE (PLASMA TV ONLY)

This function allows you to reduce the power consumption of the TV.

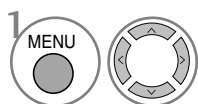
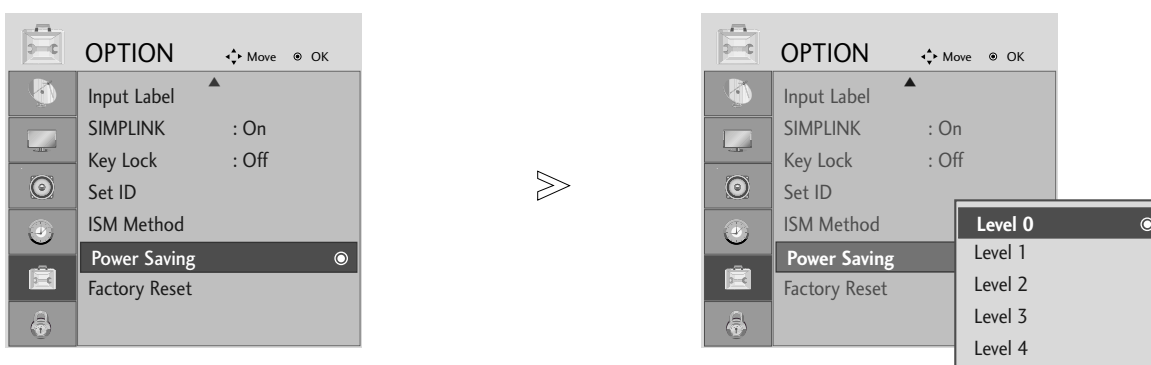

Select **OPTION**.

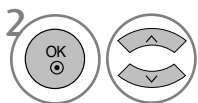

Select **Power Saving**.

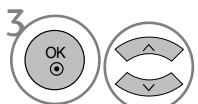

Select **Level 0, Level 1, Level 2, Level 3 or Level 4**.

• Level 0 is the brightest.



Save.

! NOTE

- ▶ The default factory setting complies with the **Energy star** requirements and is adjusted to the comfortable level to be viewed at home.
You can increase the brightness of your screen by adjusting the **Power Saving Level** or by setting the **Picture Mode**.

- Press the **MENU** button to return to normal TV viewing.
- Press the **RETURN** button to move to the previous menu screen.







SOUND & LANGUAGE CONTROL

► In 19/22LS4D* Models, TV Speaker will not be displayed.

AUTO VOLUME LEVELER

AVL automatically remains on the same level of volume if you change programmes.



- 1   Select **AUDIO**.
- 2   Select **Auto Volume**.
- 3   Select **On or Off**.

- Press the **MENU** button to return to normal TV viewing.
- Press the **RETURN** button to move to the previous menu screen.

PRESET SOUND SETTINGS-SOUND MODE

You can select your preferred sound setting; SRS TruSurround XT or (SRS TruSurround HD (32/37/42/47/52LG5010 Only)), Clear Voice, Standard, Music, Cinema, Sport or Game and you can also adjust the frequency of the equalizer.

Sound Mode lets you enjoy the best sound without any Special adjustment as the TV sets the appropriate sound options based on the programme content.

SRS TruSurround XT or (SRS TruSurround HD (32/37/42/47/52LG5010 Only)), Clear Voice, Standard, Music, Cinema, Sport and Game are preset for optimum sound quality at the factory.

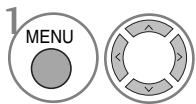
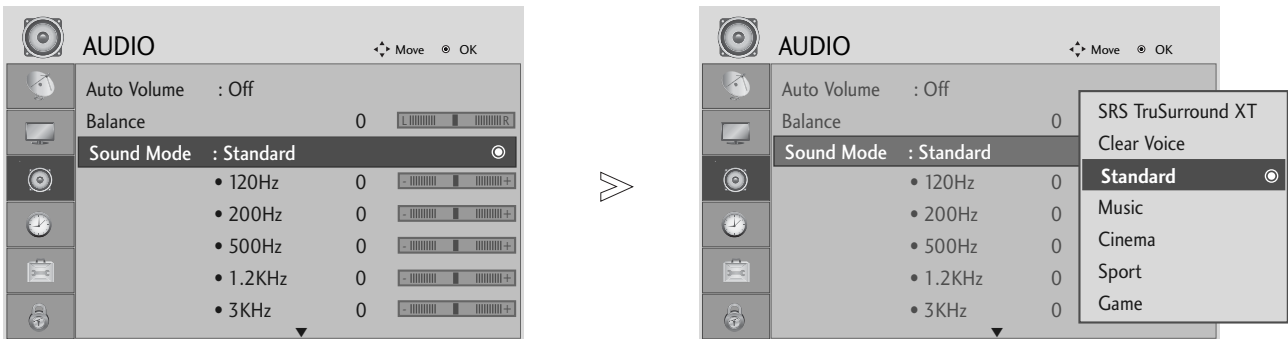

Select **AUDIO**.

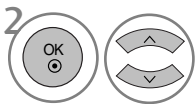

Select **Sound Mode**.

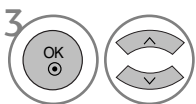

Select **SRS TruSurround XT** or (**SRS TruSurround HD (32/37/42/47/52LG5010 Only)**), **Clear Voice**, **Standard**, **Music**, **Cinema**, **Sport** or **Game**.

• If you select **Clear Voice**, **SRS TruSurround XT** feature will not work.

- Press the **MENU** button to return to normal TV viewing.
- Press the **RETURN** button to move to the previous menu screen.

▶ **SRS TruSurround XT** and **SRS TruSurround HD** are a trademark of SRS Labs, Inc.
 ▶ **TruSurround XT** and **TruSurround HD** technology is incorporated under license from SRS Labs, Inc.

SOUND & LANGUAGE CONTROL

SOUND SETTING ADJUSTMENT -USER MODE

Adjusting the audio equalizer.

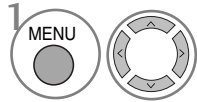
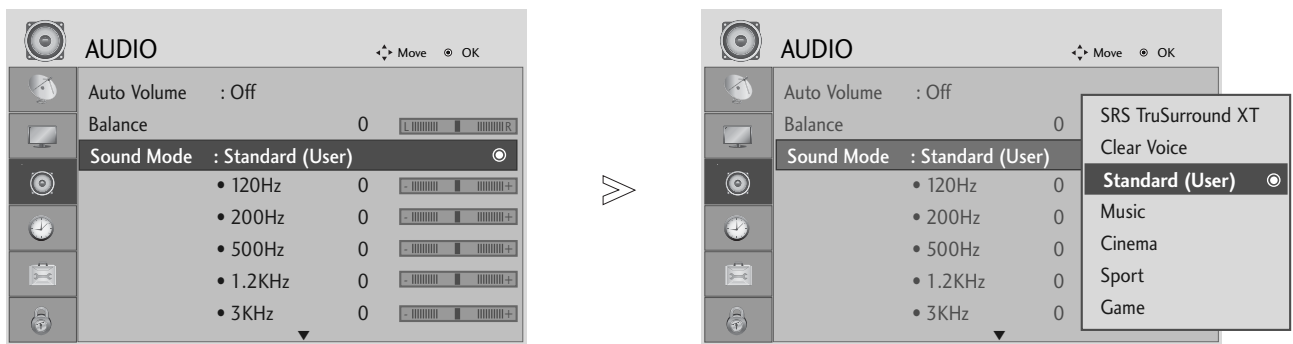

1 Select **AUDIO**.

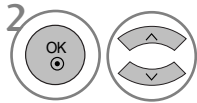

2 Select **Sound Mode**.

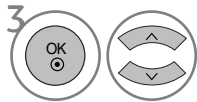

3 Select **SRS TruSurround XT** or (**SRS TruSurround HD (32/37/42/47/52LG5010 Only)**), **Clear Voice**, **Standard**, **Music**, **Cinema**, **Sport** or **Game**.

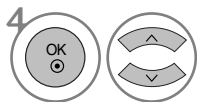

4 Select a frequency band.

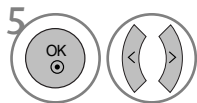

5 Set the desired sound level.

- Press the **MENU** button to return to normal TV viewing.
- Press the **RETURN** button to move to the previous menu screen.

BALANCE

You can adjust the sound balance of the speakers to preferred levels.

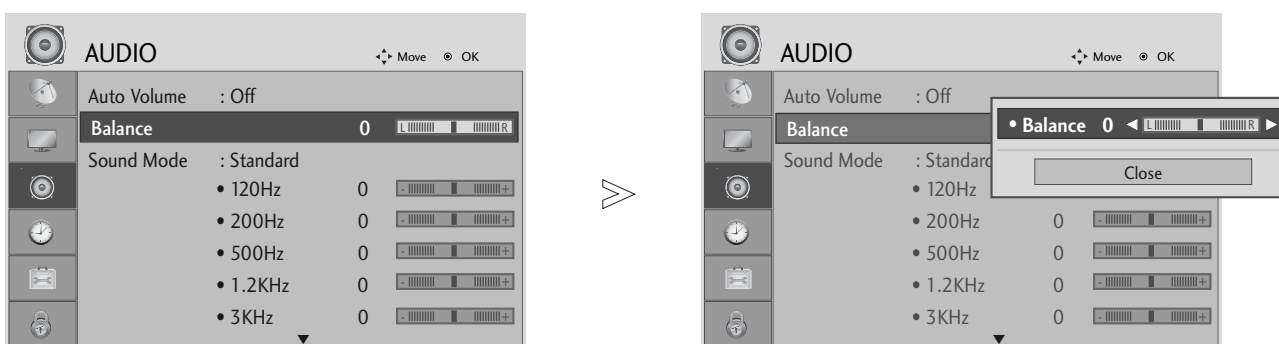

- 1   Select **AUDIO**.
- 2   Select **Balance**.
- 3   Make desired adjustment.

- Press the **MENU** button to return to normal TV viewing.
- Press the **RETURN** button to move to the previous menu screen.

SOUND & LANGUAGE CONTROL

TV SPEAKERS ON/ OFF SETUP

(Except for 19/22LS4D*)

You can adjust the internal speaker status.

In AV, COMPONENT, RGB and HDMI1 with HDMI to DVI cable, the TV speaker can be operational even when there is no video signal.

If you wish to use an external Hi-Fi system, turn off the TV internal speakers.

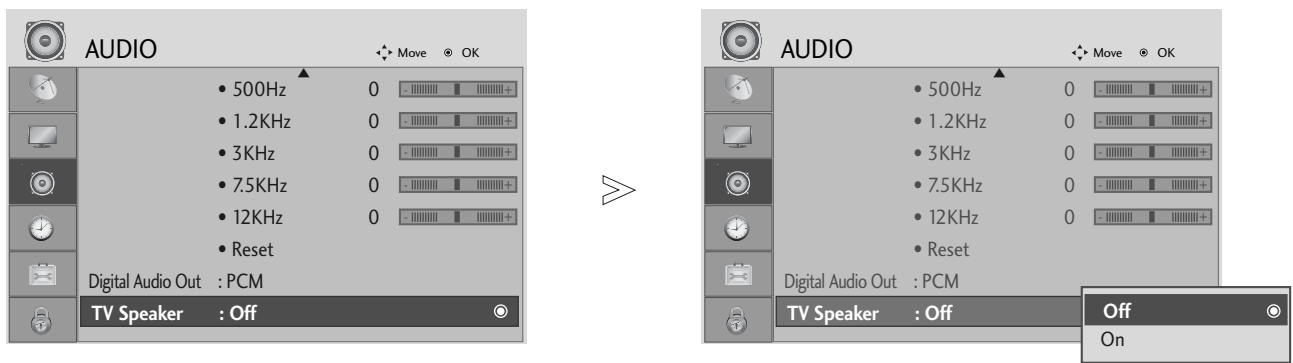

- Press the **MENU** button to return to normal TV viewing.
- Press the **RETURN** button to move to the previous menu screen.

SELECTING DIGITAL AUDIO OUT

(Except for 19/22LS4D*)

This function allows you to select your preferred Digital Audio Output.

The TV can only output DOLBY Digital if a channel is broadcast with Dolby Digital audio.

When Dolby digital is available, selecting Dolby Digital in the Digital Audio Out menu will set SPDIF output to Dolby Digital

If Dolby Digital is selected in the digital audio out menu when dolby digital is not available, SPDIF output will be PCM.

Even if both Dolby Digital and Audio language have been set in a channel which broadcast Dolby Digital Audio, only Dolby Digital will be played.

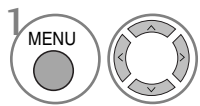
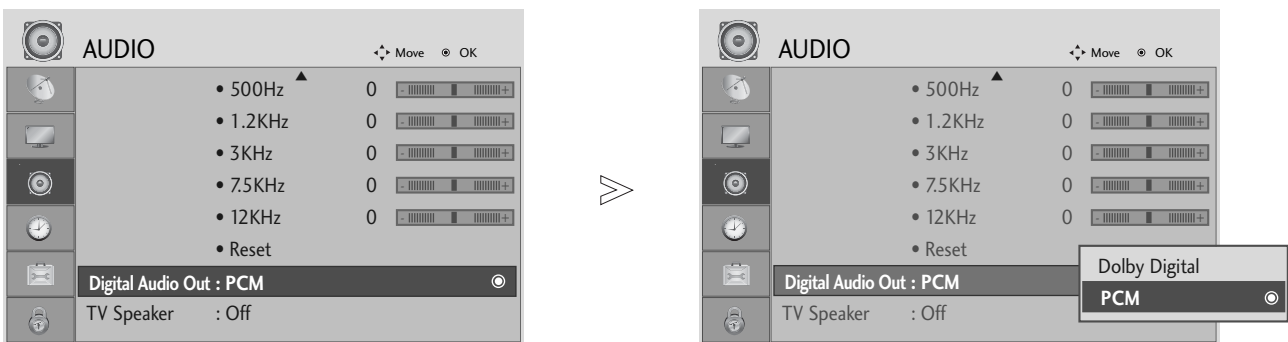

Select **AUDIO**.

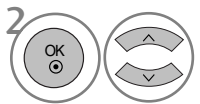

Select **Digital Audio Out**.

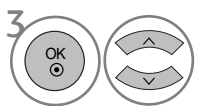

Select **Dolby Digital** or **PCM**.



Manufactured under license from Dolby Laboratories. "Dolby" and the double-D symbol are trademarks of Dolby Laboratories.

- There is a possibility that when HDMI mode, some DVD players do not make SPDIF sound. At that time, set the output of the digital audio of the DVD player to PCM.





- Press the **MENU** button to return to normal TV viewing.
- Press the **RETURN** button to move to the previous menu screen.

SOUND & LANGUAGE CONTROL

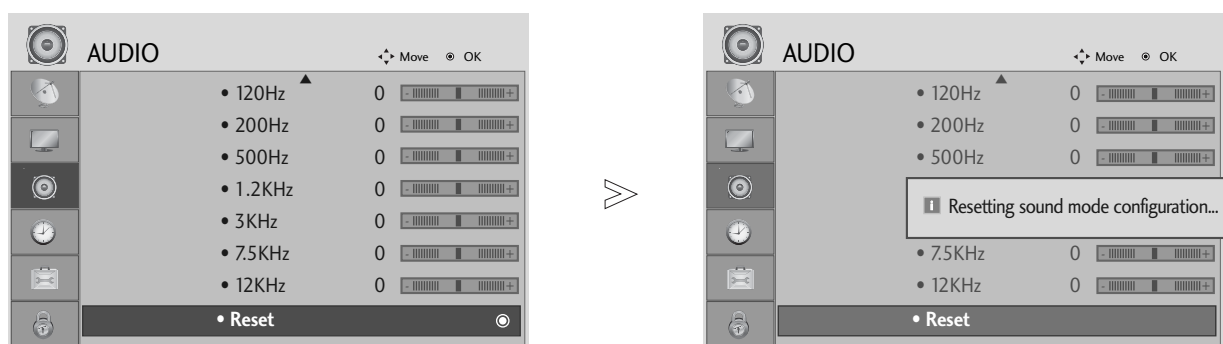
AUDIO RESET

Settings of the selected Sound Mode return to the default factory settings.

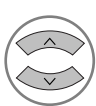

-   Select **AUDIO**.
-   Select **Reset**.
-  Initialize the adjusted value.

- Press the **MENU** button to return to normal TV viewing.
- Press the **RETURN** button to move to the previous menu screen.

I/II

Stereo/Dual Reception (In Analogue Mode Only)

When a programme is selected, the sound information for the station appears after the programme number and station name disappear.

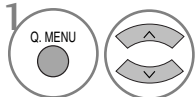

Select AUDIO.

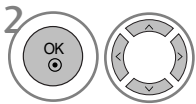

Select the sound output.

• For 19/22LS4D* only



Select the sound output.

Broadcast	On Screen Display
Mono	MONO
Stereo	STEREO
Dual	DUAL I, DUAL II, DUAL I+II

■ Mono sound selection

If the stereo signal is weak in stereo reception, you can switch to mono. In mono reception, the clarity of sound is improved.

■ Language selection for dual language broadcast

If a programme can be received in two languages (dual language), you can switch to DUAL I, DUAL II or DUAL I+II.

- DUAL I Sends the primary broadcast language to the loudspeakers.
- DUAL II Sends the secondary broadcast language to the loudspeakers.
- DUAL I+II Sends a separate language to each loudspeaker.

SOUND & LANGUAGE CONTROL

NICAM Reception (In Analogue Mode Only)

If the TV is equipped with a receiver for NICAM reception, high quality NICAM (Near Instantaneous Companding Audio Multiplex) digital sound can be received.

Sound output can be selected according to the type of broadcast received.

-
- 1 When **NICAM mono** is received, you can select **NICAM MONO** or **FM MONO**.
 - 2 When **NICAM stereo** is received, you can select **NICAM STEREO** or **FM MONO**.
If the stereo signal is weak, switch to **FM mono**.
 - 3 When **NICAM dual** is received, you can select **NICAM DUAL I**, **NICAM DUAL II** or **NICAM DUAL I+II** or **FM MONO**.
-

Speaker Sound Output Selection

In AV, Component, RGB and HDMI mode, you can select output sound for the left and right loudspeakers.

Select the sound output.

L+R: Audio signal from audio L input is sent to the left loudspeaker and audio signal from audio R input is sent to the right loudspeaker.

L+L: Audio signal from audio L input is sent to left and right loudspeakers.

R+R: Audio signal from audio R input is sent to left and right loudspeakers.

ON-SCREEN MENU LANGUAGE / COUNTRY SELECTION

The installation guide menu appears on the TV screen when it is switched on for the first time.



* If you want to change Language/ Country selection

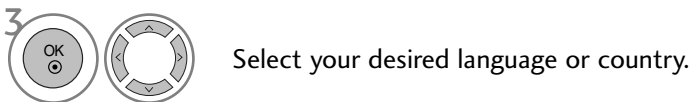

- Press the **MENU** button to return to normal TV viewing.
- Press the **RETURN** button to move to the previous menu screen.

! NOTE

- ▶ If you do not finish the set-up Installation Guide by pressing **RETURN** or if you time out on the OSD (On Screen Display) the installation menu will continuously appear until the set up is completed whenever the TV is switched on
- ▶ If you select the wrong local country, teletext may not appear correctly on the screen and some problems may occur during teletext operation.
- ▶ The CI (Common Interface) function may not be applied based on country broadcasting circumstances.
- ▶ DTV mode control buttons may not function based on country broadcasting circumstances.
- ▶ In country that Digital broadcasting regulation isn't fixed, some DTV function may not work depending on digital broadcasting circumstances.
- ▶ The Country Setting "UK" should only be activated UK.

SOUND & LANGUAGE CONTROL

LANGUAGE SELECTION (IN DIGITAL MODE ONLY)

The Audio function allows selection of a preferred language.

If audio data in a selected language is not broadcast, the default language audio will be played.

Use the Subtitle function when two or more subtitle languages are broadcast. If subtitle data in a selected language is not broadcast, the default language subtitle will be displayed.

When the languages you selected as the primary for Audio Language and Subtitle Language are not supported, you can select language in secondary category.

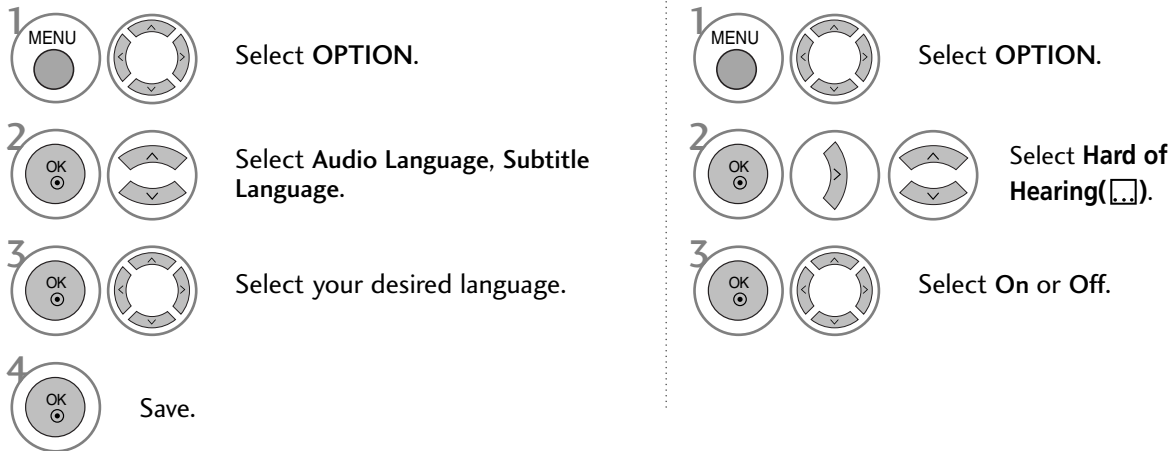

- Press the RETURN button to move to the previous menu screen.

< Audio Language Selection >

- ▶ When two or more audio languages are broadcast, you can select the audio language.

< Subtitle Language Selection >

- ▶ When two or more subtitle languages are broadcast, you can select the subtitle language with the **SUBTITLE** button on the remote control.
- ▶ Press the ^ ∨ button to select a subtitle language.

- The audio/subtitles can be displayed in a simpler form with 1 to 3 characters broadcast by the service provider.
- When you select supplementary Audio (Audio for “Visual/Hearing Impaired”) the TV may output a part of the Main audio.

Audio Language OSD Information

Display	Status
N.A	Not Available
MPEG	MPEG Audio
Dolby Digital	Dolby Digital Audio
Visual Impaired	Audio for “Visual Impaired”
Hearing Impaired	Audio for “Hearing Impaired”

Subtitle Language OSD Information

Display	Status
N.A	Not Available
Teletext	Teletext Subtitle
Hearing Impaired	Subtitle for “Hard of Hearing”





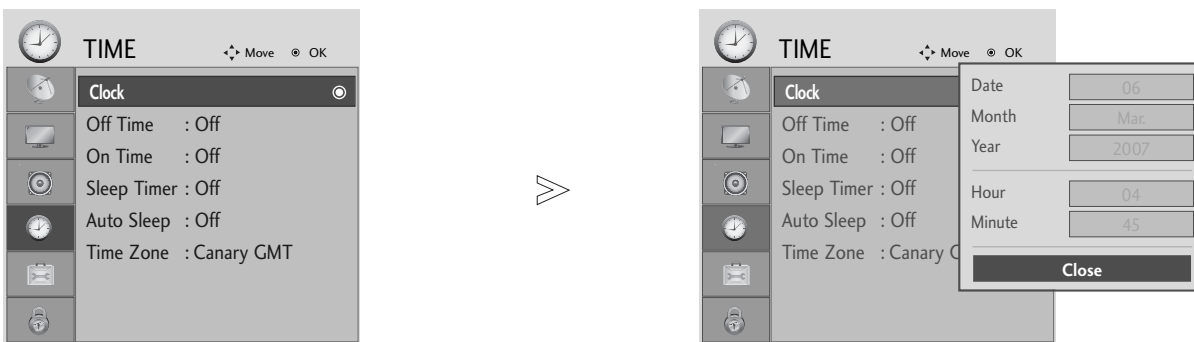

TIME SETTING

CLOCK SETUP

The clock is set automatically when receiving a digital signal. (You can set the clock manually only if the TV has no DTV signal.)

You must set the time correctly before using on/off timer function.

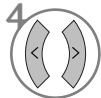

-   Select **TIME**.
-   Select **Clock**.
-   Select either the year, date, or time option.
-  Set the year, date, and time options.

- Press the **MENU** button to return to normal TV viewing.
- Press the **RETURN** button to move to the previous menu screen.

TIME SETTING

AUTO ON/OFF TIMER SETTING

The Off time function automatically switches the TV to standby at a preset time. Two hours after the TV is switched on by the on time function it will automatically switch back to standby mode unless a button has been pressed.

The Off time function overrides the On timer function if both are set to the same time. The TV must be in standby mode for the On timer to work.

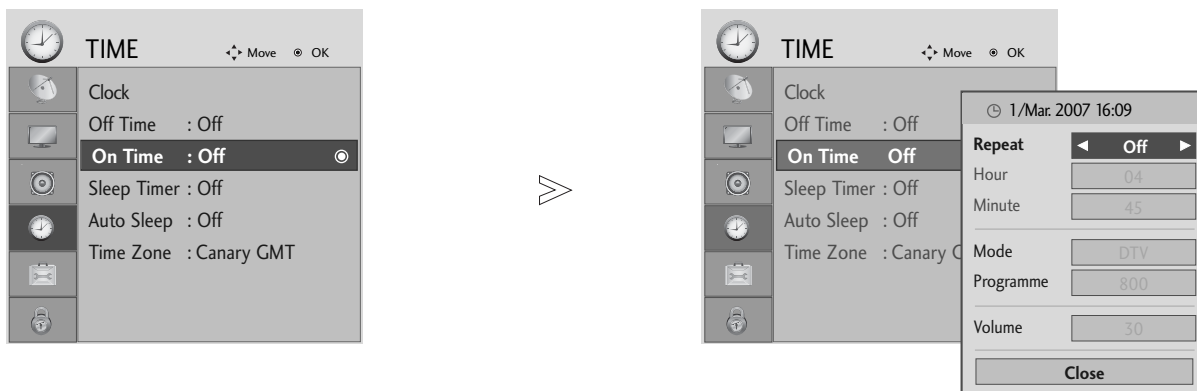

- 1 Select TIME.
- 2 Select Off time or On time.
- 3 Select Repeat.
- 4 Select Off, Once, Daily, Mon ~ Fri, Mon ~ Sat, Sat ~ Sun or Sun.
- 5 Set the hour.
- 6 Set the minutes.





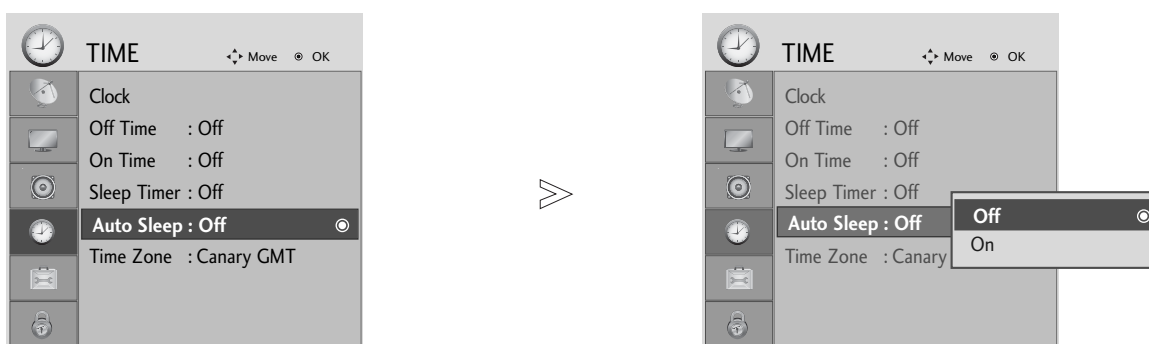

- To cancel On/Off Time function, select Off.
 - For On Time function only
- 1 Select Mode.
 - 2 Select TV, DTV or Radio.
 - 3 Set the programme.
 - 4 Adjust volume level at switch-on.

- Press the MENU button to return to normal TV viewing.
- Press the RETURN button to move to the previous menu screen.

AUTO SHUT-OFF SETTING

If the TV is switched on and there is no input signal, it will switch off automatically after 10 minutes.









- 1   Select **TIME**.
- 2   Select **Auto Sleep**.
- 3   Select **Off** or **On**.

- Press the **MENU** button to return to normal TV viewing.
- Press the **RETURN** button to move to the previous menu screen.

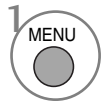
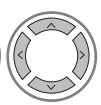
TIME SETTING

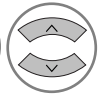

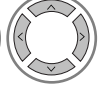
TIME ZONE SETUP

When you select a Time Zone city, the TV time is set by the time offset information based on Time Zone and GMT (Greenwich Mean Time) which is received with the broadcast signal and the time is set automatically by a digital signal.

-   Select **TIME**.
-   Select **Time Zone**.
-   Select your viewing area time zone.
-  Confirm it.

SLEEP TIMER SETTING

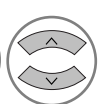
You do not have to remember to switch the TV off before you go to sleep. The sleep timer automatically switches the TV to standby after the preset time has elapsed.

-   Select **Sleep Timer**.
-   Select **Off, 10, 20, 30, 60, 90, 120, 180 or 240 Min..**

• For 19/22LS4D* only



Select the number of minutes.







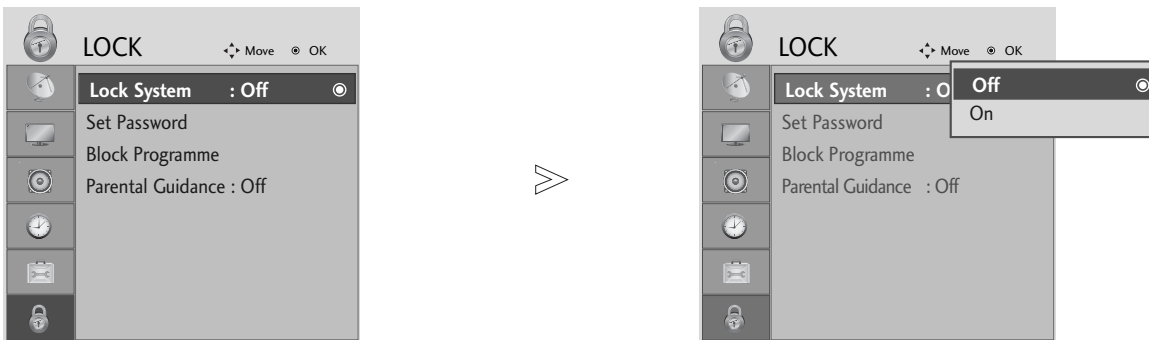

- When you switch the TV off, the preset sleep time is cancelled.
- You can also adjust Sleep Timer in the **TIME** menu.

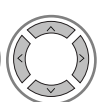
PARENTAL CONTROL / RATINGS

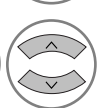
SET PASSWORD & LOCK SYSTEM

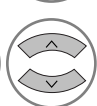
Enter the password, press '0', '0', '0', '0' on the remote control handset.

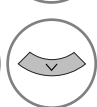
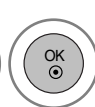

- 1   Select **LOCK**.
- 2   Select **Lock System**.
- 3   Select **On**.
- 4    Set the password.
- 5  Input a 4-digit password.
Be sure to remember this number!
Re-enter new password for confirm.

• If you forget your password, press '7', '7', '7', '7' on the remote control handset.

- Press the **MENU** button to return to normal TV viewing.
- Press the **RETURN** button to move to the previous menu screen.

PARENTAL CONTROL / RATINGS

BLOCK PROGRAMME

Blocks any programmes that you do not want to watch or that you do not want your children to watch.

It is available to use this function in Lock System "On".

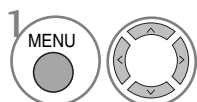
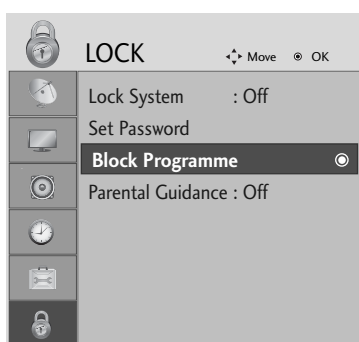

Select **LOCK**.

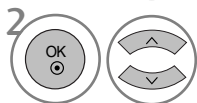

Select **Block Programme**.



Enter the **Block Programme**.

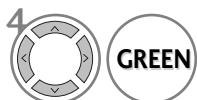

Select a programme to be locked.

- Press the **MENU** button to return to normal TV viewing.
- Press the **RETURN** button to move to the previous menu screen.

PARENTAL CONTROL (IN DIGITAL MODE ONLY)







This function operates according to information from the broadcasting station. Therefore if the signal has incorrect information, this function does not operate.

A password is required to gain access to this menu.

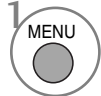
This TV is programmed to remember which option it was last set to even if you switch the TV off.

Prevents children from watching certain adult's TV programmes, according to the ratings limit set.



- 1   Select **LOCK**.
- 2   Select **Parental Guidance**.
- 3   Make appropriate adjustments.
- 4  Save.





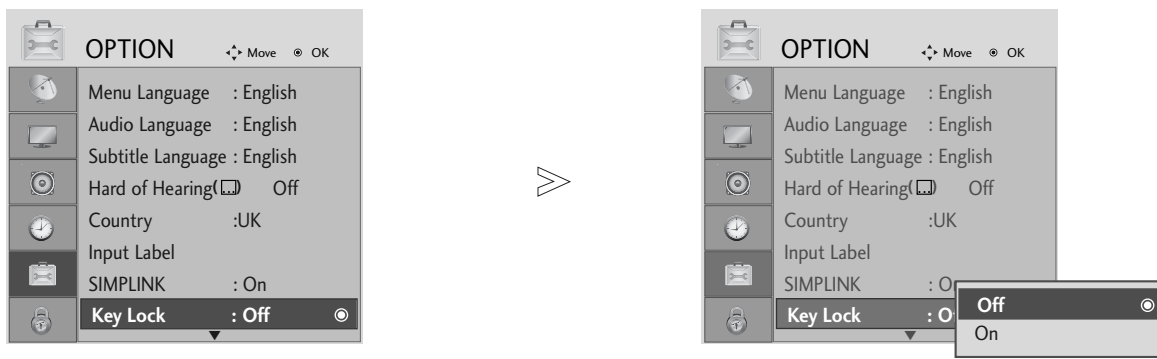

- Press the **MENU** button to return to normal TV viewing.
- Press the **RETURN** button to move to the previous menu screen.

PARENTAL CONTROL / RATINGS

KEY LOCK

The TV can be set so that the remote control is required to control it. This feature can be used to prevent unauthorized viewing.



- 1 MENU   Select **OPTION**.
- 2 OK   Select **Key Lock**.
- 3 OK   Select **On** or **Off**.
- 4 OK  Save.

- In **Key Lock 'On'**, if the TV is turned off, press the **⏻ / I**, **INPUT**, **P ^ v** (or **PR ▲ ▼**) button on the TV or **POWER**, **INPUT**, **D/A TV**, **P ^ v** (or **(PR + -** or **P + -)**) or **NUMBER** buttons on the remote control.
- With the **Key Lock On**, the display '**Key Lock On**' appears on the screen if any button on the front panel is pressed while viewing the TV.

- Press the **MENU** button to return to normal TV viewing.
- Press the **RETURN** button to move to the previous menu screen.

TELETEXT

This feature is not available in all countries.

Teletext is a free service broadcast by most TV stations which gives up-to-the-minute information on news, weather, television programmes, share prices and many other topics.

The teletext decoder of this TV can support the SIMPLE, TOP and FASTEXT systems. SIMPLE (standard teletext) consists of a number of pages which are selected by directly entering the corresponding page number. TOP and FASTEXT are more modern methods allowing quick and easy selection of teletext information.

SWITCH ON/OFF

Press the **TEXT** button to switch to teletext. The initial page or last page viewed appears on the screen.

Two page numbers, TV station name, date and time are displayed on the screen headline. The first page number indicates your selection, while the second shows the current page displayed.

Press the **TEXT** button to switch off teletext. The previous mode reappears.

SIMPLE TEXT

■ Page selection

- 1 Enter the desired page number as a three digit number with the **NUMBER** buttons. If during selection you press a wrong number, you must complete the three digit number and then re-enter the correct page number.
- 2 The **P** \wedge \vee (or (**PR** + - or **P** + -)) button can be used to select the preceding or following page.

TOP TEXT

The user guide displays four fields-red, green, yellow and blue at the bottom of the screen. The yellow field denotes the next group and the blue field indicates the next block.

■ Block / group / page selection

- 1 With the blue button you can progress from block to block.
- 2 Use the yellow button to proceed to the next group with automatic overflow to the next block.
- 3 With the green button you can proceed to the next existing page with automatic overflow to the next group. Alternatively the **P** \wedge (or **PR** +) button can be used.
- 4 The red button returns to the previous selection. Alternatively the **P** \vee (or **PR** -) button can be used.

■ Direct page selection



As with SIMPLE teletext mode, you can select a page by entering it as a three digit number using the **NUMBER** buttons in TOP mode.

TELETEXT

FASTEXT

The teletext pages are colour coded along the bottom of the screen and are selected by pressing the corresponding coloured button.

■ Page selection

- 1 Press the **T.OPT** button and then use $\wedge \vee$ button to select  menu. Display the index page.
(In 19/22LS4D*, press the  button to select the index menu.)
- 2 You can select the pages which are colour coded along the bottom line with corresponding coloured buttons.
- 3 AS with SIMPLE teletext mode, you can select a page by entering its three digit page number with the NUMBER buttons in FASTEXT mode.
- 4 The **P** $\wedge \vee$ (or (**PR** + - or **P** + -)) button can be used to select the preceding or following page.

SPECIAL TELETEXT FUNCTIONS

- Press the **T. OPT** button and then use $\wedge \vee$ button to select the **Text Option** menu.



■ REVEAL

Select this menu to display concealed information, such as solutions to riddles or puzzles.



■ UPDATE

Displays the TV picture on the screen while waiting for a new teletext page. The display will appear at the top left hand corner of the screen. When the updated page is available then display will change to the page number. Select this menu again to view the updated teletext page.



■ TIME

When viewing a TV programme, Select this menu to display the time at the top right hand corner of the screen. In the teletext mode, press this button to select a sub page number. The sub page number is displayed at the bottom of the screen. To hold or change the sub page, press the RED/GREEN, $\lt \gt$ or NUMBER buttons.



■ HOLD

Stops the automatic page change which will occur if a teletext page consists of 2 or more sub pages. The number of sub pages and the sub page displayed is, usually, shown on the screen below the time. When this menu is selected the stop symbol is displayed at the top left-hand corner of the screen and the automatic page change is inactive.

DIGITAL TELETEXT

*This function works in UK only.

The TV gives you access to digital teletext which is greatly improved in various aspects such as text, graphics etc. This digital teletext can access special digital teletext services and specific services which broadcast digital teletext.

You should select off in the subtitle language menu to display teletext by pressing the **SUBTITLE** button.

TELETEXT WITHIN DIGITAL SERVICE

- 1 Press the numeric or **P** \wedge \vee (or **(PR + - or P + -)**) button to select a digital service which broadcasts digital teletext. To know which are digital teletext services, refer to the EPG service list.
- 2 Follow the indications on digital teletext and move onto the next step by pressing **TEXT**, **OK**, \wedge \vee \langle \rangle , **RED**, **GREEN**, **YELLOW**, **BLUE** or **NUMBER** buttons and etc..
- 3 To change digital teletext service, select a different service by the numeric or **P** \wedge \vee (or **(PR + - or P + -)**) button.



TELETEXT IN DIGITAL SERVICE

- 1 Press the numeric or **P** \wedge \vee (or **(PR + - or P + -)**) button to select a certain service which broadcasts digital teletext.
- 2 Press the **TEXT** or coloured button to switch on teletext.
- 3 Follow the indications on digital teletext and move onto the next step by pressing **OK**, \wedge \vee \langle \rangle , **RED**, **GREEN**, **YELLOW**, **BLUE** or **NUMBER** buttons and so on.
- 4 Press the **TEXT** or colour button to switch off digital teletext and return to TV viewing.

Some services may allow you to access text services by pressing the **RED** button.







APPENDIX

Initializing (Reset to original factory settings)

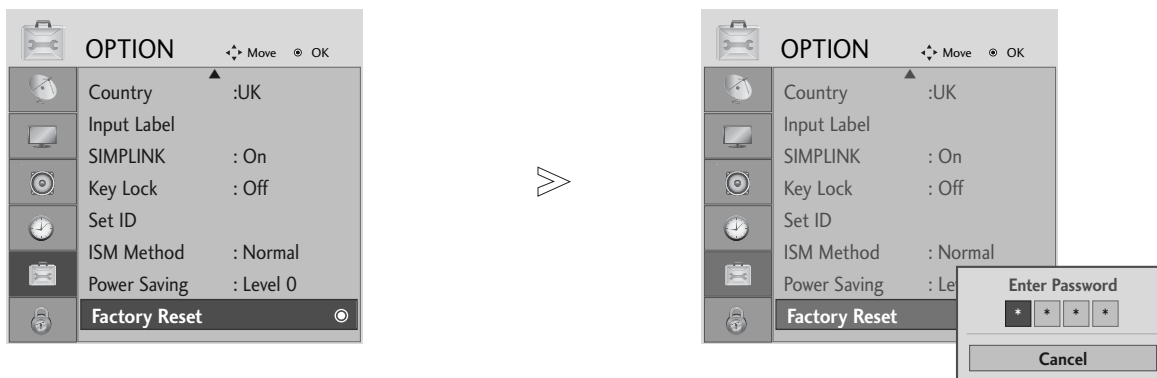
This function operates in current mode.
To initialize the adjusted value.

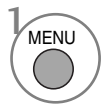
When the Lock System menu is “On”, the message to enter the password appears.



-   Select **OPTION**.
-   Select **Factory Reset**.
- 

• In Lock System “On”, if you forget your password, press ‘7’, ‘7’, ‘7’, ‘7’ on the remote control handset.

- Press the **MENU** button to return to normal TV viewing.
- Press the **RETURN** button to move to the previous menu screen.

TROUBLESHOOTING

The TV does not operate properly.

The remote control does not work	<ul style="list-style-type: none"> ■ Check to see if there is any object between the TV and the remote control causing an obstruction. Ensure you are pointing the remote control directly at the TV. ■ Ensure that the batteries are installed with correct polarity (+ to +, - to -). ■ Ensure that the correct remote operating mode is set: TV, VCR etc. ■ Install new batteries.
Power is suddenly turned off	<ul style="list-style-type: none"> ■ Is the sleep timer set? ■ Check the power control settings. Has the Power supply been interrupted. ■ Is Auto sleep activated on this station?

The video function does not work.

No picture & No sound	<ul style="list-style-type: none"> ■ Check whether the TV is switched on. ■ Try another channel. The problem may be with the broadcast. ■ Is the power cord inserted correctly into the mains? ■ Check your antenna direction and/or location. ■ Test the mains outlet by plugging another TV into the same outlet.
Picture appears slowly after switching on	<ul style="list-style-type: none"> ■ This is normal, the image is muted during the TV startup process. Please contact your service centre, if the picture has not appeared after five minutes.
No or poor colour or poor picture	<ul style="list-style-type: none"> ■ Adjust Colour in menu option. ■ Allow a sufficient distance between the TV and the VCR. ■ Try another channel. The problem may be with the broadcast. ■ Are the video cables installed properly? ■ Activate any function to restore the brightness of the picture.
Horizontal/vertical bars or picture shaking	<ul style="list-style-type: none"> ■ Check for local interference such as an electrical appliance or power tool.
Poor reception on some channels	<ul style="list-style-type: none"> ■ Station or cable channel experiencing problems, tune to another station. ■ Station signal is weak, reposition the antenna to receive weaker stations. ■ Check for sources of possible interference.
Lines or streaks in pictures	<ul style="list-style-type: none"> ■ Check antenna (Change the position of the antenna).
No picture when connecting HDMI	<ul style="list-style-type: none"> ■ Check HDMI cable over version 1.3. If the HDMI cables don't support HDMI version 1.3, it can cause flickers or no screen display. In this case use the latest cables that support HDMI version 1.3.

The audio function does not work.

Picture OK & No sound	<ul style="list-style-type: none"> ■ Press the VOLUME button. ■ Sound muted? Press MUTE button. ■ Try another channel. The problem may be with the broadcast. ■ Are the audio cables installed properly?
No output from one of the speakers	<ul style="list-style-type: none"> ■ Adjust Balance in menu option.
Unusual sound from inside the TV	<ul style="list-style-type: none"> ■ A change in ambient humidity or temperature may result in an unusual noise when the TV is switched on or off and does not indicate a fault with the TV.
No sound when connecting HDMI or USB	<ul style="list-style-type: none"> ■ Check HDMI cable over version 1.3. ■ Check USB cable over version 2.0. <p style="text-align: right;">*This feature is not available for all models.</p>

There is a problem in PC mode. (Only PC mode applied)

The signal is out of range (Invalid format)	<ul style="list-style-type: none"> ■ Adjust resolution, horizontal frequency or vertical frequency. ■ Check the input source.
Vertical bar or stripe on background & Horizontal Noise & Incorrect position	<ul style="list-style-type: none"> ■ Use Auto configure or adjust clock, phase or H/V position. (Option)
Screen colour is unstable or single colour	<ul style="list-style-type: none"> ■ Check the signal cable. ■ Reinstall the PC video card.

There is a problem with PICTURE settings.

When the user changes the picture settings, the TV automatically converts back to the initial settings after a certain period of time.	<ul style="list-style-type: none"> ■ It means that the TV is currently set to In Store mode. To switch to Home mode you should do the followings: From the TV Menu, choose OPTION -> Factory Reset -> Yes (wait for a few seconds for the TV to download again) -> OSD "WELCOME" appears -> Press OK button -> Choose Language -> Choose Home -> Select your Country and Time Zone -> Press OK button. Program search will begin automatically (You can stop the search by pressing the OK button). Now, you have completed switching to the Home mode.
--	--

MAINTENANCE

Early malfunctions can be prevented. Careful and regular cleaning can prolong the life of your new TV.

Caution: Be sure to switch the power off and unplug the power cord before you begin any cleaning.

Cleaning the Screen

- 1 A good way to keep the dust off your screen for a while is to wet a soft cloth in a mixture of lukewarm water and a little fabric softener or dish washing detergent. Wring the cloth until it is almost dry, and then use it to wipe the screen.
- 2 Ensure there is no excess water on the screen. Allow any water or dampness to evaporate before switching on.

Cleaning the Cabinet

- To remove dirt or dust, wipe the cabinet with a soft, dry, lint-free cloth.
- Do not to use a wet cloth.

Extended Absence

CAUTION

- ▶ If you expect to leave your TV dormant for prolonged periods (such as a holiday), unplug the power cord to protect against possible damage from lightning or power surges.

APPENDIX

PRODUCT SPECIFICATIONS

MODELS		42PG10**	50PG10**	42PG30**
		42PG1000-ZA	50PG1000-ZA	42PG3000-ZA
Dimensions (Width x Height x Depth)	with stand	1040.0 x 729.0 x 308.0 mm 41.0 x 28.7 x 12.2 inches	1224.7 x 849.0 x 364.0 mm 48.3 x 33.5 x 14.4 inches	1039.5 x 726.0 x 307.6 mm 41.0 x 28.6 x 12.1 inches
	without stand	1040.0 x 677.0 x 84.0 mm 41.0 x 26.7 x 3.3 inches	1224.7 x 790.0 x 83.6 mm 48.3 x 31.1 x 3.3 inches	1039.5 x 673.7 x 84.0 mm 41.0 x 26.6 x 3.3 inches
Weight	with stand	26.6 kg / 58.7 lbs	41.5 kg / 91.5 lbs	28.0 kg / 61.8 lbs
	without stand	24.6 kg / 54.3 lbs	38.1 kg / 84.0 lbs	25.0 kg / 55.1 lbs
Power requirement Power Consumption		AC100-240V~ 50/60Hz 3.1A 310W	AC100-240V~ 50/60Hz 4.2A 420W	AC100-240V~ 50/60Hz 3.1A 310W
MODELS		50PG30**	42PG20**	50PG20**
		50PG3000-ZA	42PG2000-ZA	50PG2000-ZA
Dimensions (Width x Height x Depth)	with stand	1232.0 x 850.0 x 363.6 mm 48.5 x 33.5 x 14.4 inches	1040 x 731.3 x 308 mm 40.9x 28.7 x 12.1 inches	1224.7 x 849 x 364 mm 48.2 x 33.4x 14.3inches
	without stand	1232.0 x 793.0 x 84.0 mm 48.5 x 31.2 x 3.3 inches	1040 x 677 x 86 mm 40.9 x 26.6 x 3.4 inches	1224.7 x 790 x 86 mm 48.2x 31.1 x 3.4 inches
Weight	with stand	42.3 kg / 93.3 lbs	27.3 kg / 60.1 lbs	41.8 kg / 92.2 lbs
	without stand	38.3 kg / 84.5 lbs	24.4 kg / 53.8 lbs	37.8kg / 83.3lbs
Power requirement Power Consumption		AC100-240V~ 50/60Hz 4.2A 420W	AC100-240V~ 50/60Hz 3.1A 310W	AC100-240V~ 50/60Hz 4.2A 420W
MODELS		60PG30**	19LS4D*	22LS4D*
		60PG3000-ZA	19LS4D-ZD	22LS4D-ZD
Dimensions (Width x Height x Depth)	with stand	1468 x 1009.1 x 413.9 mm 57.8 x 39.7 x 16.3 inches	456.8x 396.6x 172.0 mm 18.0 x 15.6 x 6.8 inches	525.4 x 441.7x 187.4 mm 20.7 x 17.4 x 7.3 inches
	without stand	1468 x 949.5 x 88.5 mm 57.8 x 37.4 x 3.5 inches	456.8 x 368.5 x 70.5 mm 18.0 x 14.5 x 2.8 inches	525.4 x 413x 68.6 mm 20.7 x 16.3 x 2.7 inches
Weight	with stand	80.6 kg / 177.7 lbs	5.1 kg / 11.3 lbs	6.1 kg / 13.5 lbs
	without stand	72.6 kg / 160.1 lbs	4.6 kg / 10.2 lbs	5.7 kg / 12.6 lbs
Power requirement Power Consumption		AC100-240V~ 50/60Hz 5.6A 560W	AC100-240V~ 50/60Hz 0.8A 50W	AC100-240V~ 50/60Hz 1.0A 60W
Television System Programme Coverage External Antenna Impedance		PAL/SECAM B/G/D/K, PAL I/II, SECAM L/L VHF: E2 ~ E12, UHF: E21 ~ E69, CATV: S1 ~ S20, HYPER: S21 ~ S47 75 Ω		
Environment condition	Operating Temperature Operating Humidity	0 ~ 40°C / 32 ~ 104°F Less than 80%		
	Storage Temperature Storage Humidity	-20 ~ 60°C / -4 ~ 140°F Less than 85%		

■ The specifications shown above may be changed without prior notice for quality improvement.

MODELS		19LG30**	22LG30**	26LG30**	
		19LG3000-ZA 19LG3050-ZA 19LG3060-ZB	22LG3000-ZA 22LG3050-ZA 22LG3060-ZB	26LG3000-ZA 26LG3050-ZA	
Dimensions (Width x Height x Depth)	with stand	458.8 x 391.0 x 189.2 mm 18.1 x 15.4 x 7.5 inches	522.2 x 431.5 x 189.0 mm 20.6 x 17.0 x 7.5 inches	663.3 x 508.2 x 227.3 mm 26.1 x 20.1 x 9.0 inches	
	without stand	458.8 x 344.5 x 69.0 mm 18.1 x 13.6 x 2.7 inches	522.2 x 384.2 x 69.0 mm 20.6 x 15.2 x 2.7 inches	663.3 x 449.8 x 80.0 mm 26.1 x 17.8 x 3.2 inches	
Weight	with stand	5.02 kg / 11.1 lbs	5.6 kg / 12.4 lbs	10.1 kg / 22.3 lbs	
	without stand	4.76 kg / 10.5 lbs	5.34 kg / 11.8 lbs	8.6 kg / 19.0 lbs	
Power requirement Power Consumption		AC100-240V~ 50/60Hz 0.8A 50W	AC100-240V~ 50/60Hz 0.9A 55W	AC100-240V~ 50/60Hz 1.2A 120W	
MODELS		32LG30**	37LG30**	42LG30**	32LG20**
		32LG3000-ZA 32LG3030-ZA	37LG3000-ZA 37LG3030-ZA	42LG3000-ZA 42LG3030-ZA	32LG2000-ZA
Dimensions (Width x Height x Depth)	with stand	801.8 x 604.2 x 227.3 mm 31.6 x 23.8 x 9.0 inches	919.6 x 682.3 x 293.8 mm 36.2 x 26.9 x 11.6 inches	1032.8 x 742.3 x 293.8 mm 40.7 x 29.3 x 11.6 inches	801.8 x 604.2 x 227.3 mm 31.6 x 23.8 x 9.0 inches
	without stand	801.8 x 544.1 x 79.0 mm 31.6 x 21.5 x 3.2 inches	919.6 x 610.3 x 89.0 mm 36.2 x 24.0 x 3.5 inches	1032.8 x 670.1 x 92.0 mm 40.7 x 26.4 x 3.7 inches	801.8 x 544.1 x 79.0 mm 31.6 x 21.5 x 3.2 inches
Weight	with stand	13.4 kg / 29.6 lbs	18.8 kg / 41.5 lbs	23.6 kg / 52.1 lbs	13.4 kg / 29.6 lbs
	without stand	11.9 kg / 26.3 lbs	16.2 kg / 35.7 lbs	21.0 kg / 46.3 lbs	11.9 kg / 26.3 lbs
Power requirement Power Consumption		AC100-240V~ 50/60Hz 1.5A 150W	AC100-240V~ 50/60Hz 1.8A 180W	AC100-240V~ 50/60Hz 2.3A 230W	AC100-240V~ 50/60Hz 1.5A 150W
MODELS		37LG20**	42LG20**	32LG32**	42LG32**
		37LG2000-ZA	42LG2000-ZA	32LG3200-ZA	42LG3200-ZA
Dimensions (Width x Height x Depth)	with stand	919.6 x 682.3 x 293.8 mm 36.2 x 26.9 x 11.6 inches	1032.8 x 742.3 x 293.8 mm 40.7 x 29.3 x 11.6 inches	801.8 x 604.2 x 227.3 mm 31.6 x 23.8 x 9.0 inches	1032.8 x 742.3 x 293.8 mm 40.7 x 29.3 x 11.6 inches
	without stand	919.6 x 610.3 x 89.0 mm 36.2 x 24.0 x 3.5 inches	1032.8 x 670.1 x 92.0 mm 40.7 x 26.4 x 3.7 inches	801.8 x 544.1 x 79.0 mm 31.6 x 21.5 x 3.2 inches	1032.8 x 670.1 x 92.0 mm 40.7 x 26.4 x 3.7 inches
Weight	with stand	18.8 kg / 41.5 lbs	23.6 kg / 52.1 lbs	13.4 kg / 29.6 lbs	23.6 kg / 52.1 lbs
	without stand	16.2 kg / 35.7 lbs	21.0 kg / 46.3 lbs	11.9 kg / 26.3 lbs	21.0 kg / 46.3 lbs
Power requirement Power Consumption		AC100-240V~ 50/60Hz 1.8A 180W	AC100-240V~ 50/60Hz 2.3A 230W	AC100-240V~ 50/60Hz 1.5A 150W	AC100-240V~ 50/60Hz 2.3A 230W
Television System Programme Coverage External Antenna Impedance		PAL/SECAM B/G/D/K, PAL I/II, SECAM L/L' VHF: E2 ~ E12, UHF: E21 ~ E69, CATV: S1 ~ S20, HYPER: S21 ~ S47 75 Ω			
Environment condition	Operating Temperature Operating Humidity	0 ~ 40°C / 32 ~ 104°F Less than 80%			
	Storage Temperature Storage Humidity	-20 ~ 60°C / -4 ~ 140°F Less than 85%			

■ The specifications shown above may be changed without prior notice for quality improvement.

APPENDIX

MODELS		32LG5***	37LG50**	42LG50**
		32LG5000-ZA 32LG5010-ZD 32LG5020-ZB 32LG5030-ZE 32LG5600-ZB	37LG5000-ZA 37LG5010-ZD 37LG5020-ZB 37LG5030-ZE	42LG5000-ZA 42LG5010-ZD 42LG5020-ZB 42LG5030-ZE
Dimensions (Width x Height x Depth)	with stand	813.8 x 598.8 x 231.9 mm 32.1 x 23.6 x 9.2 inches	936.4 x 685.4 x 293.4 mm 36.9 x 27.0 x 11.6 inches	1032.0 x 894.8 x 293.8 mm 40.7 x 35.3 x 11.6 inches
	without stand	813.8 x 540.4 x 95.5 mm 32.1 x 21.3 x 3.8 inches	936.4 x 612.8 x 88.0 mm 36.9 x 24.2 x 3.5 inches	1032.0 x 662.3 x 89.0 mm 40.7 x 26.1 x 3.5 inches
Weight	with stand	14.1 kg / 31.1 lbs	18.3 kg / 40.4 lbs	26.2 kg / 57.8 lbs
	without stand	12.6 kg / 27.8 lbs	15.6 kg / 34.4 lbs	23.5 kg / 51.8 lbs
Power requirement		AC100-240V~ 50/60Hz 1.5A 1.8A (32LG5600)	AC100-240V~ 50/60Hz 1.8A	AC100-240V~ 50/60Hz 2.3A
Power Consumption		150W 180W (32LG5600)	180W	230W
MODELS		32LG5***	47LG50**	52LG50**
		32LG5700-ZF	47LG5000-ZA 47LG5010-ZD 47LG5020-ZB 47LG5030-ZE	52LG5000-ZA 52LG5010-ZD 52LG5020-ZB 52LG5030-ZE
Dimensions (Width x Height x Depth)	with stand	813.8 x 599.3 x 294.0 mm 32.1 x 23.6 x 11.6 inches	1156.2 x 813.1 x 342.9 mm 45.6 x 32.0 x 13.5 inches	1291.7 x 892.17 x 342.9 mm 50.9 x 35.2 x 13.5 inches
	without stand	813.8 x 540.4 x 95.5 mm 32.1 x 21.3 x 3.8 inches	1156.2 x 739.2 x 103.0 mm 45.6 x 29.1 x 4.1 inches	1291.7 x 817.0 x 115.3 mm 50.9 x 32.2 x 4.6 inches
Weight	with stand	14.1 kg / 31.1 lbs	29.2 kg / 64.4 lbs	39.5 kg / 87.1 lbs
	without stand	12.6 kg / 27.8 lbs	24.6 kg / 54.3 lbs	34.9 kg / 77.0 lbs
Power requirement		AC100-240V~ 50/60Hz 1.8A	AC100-240V~ 50/60Hz 3.0A	AC100-240V~ 50/60Hz 3.3A
Power Consumption		180W	300W	330W
Television System		PAL/SECAM B/G/D/K, PAL I/II, SECAM L/L'		
Programme Coverage		VHF: E2 ~ E12, UHF: E21 ~ E69, CATV: S1 ~ S20, HYPER: S21 ~ S47		
External Antenna Impedance		75 Ω		
Environment condition	Operating Temperature	0 ~ 40°C / 32 ~ 104°F		
	Operating Humidity	Less than 80%		
	Storage Temperature	-20 ~ 60°C / -4 ~ 140°F		
	Storage Humidity	Less than 85%		

■ The specifications shown above may be changed without prior notice for quality improvement.

PROGRAMMING THE REMOTE CONTROL

(Only 19/22/26/32/37/42LG30**, 32/37/42LG20**,32/42LG32**, 32/37/42/47/52LG5***)

The remote control is a multi brand or universal remote. It can be programmed. to operate most remote controlled devices from other manufacturers.

Note that the remote control may not control all models from other brands.

Programming a code into a remote mode

- 1** Testing your remote control.
To find out whether your remote control can operate other components without programming, turn on a component such as a STB and press the corresponding mode button (such as a **STB**) on the remote control, while pointing at the component. Test the POWER and P \wedge \vee buttons to see if the component responds correctly. If the component does not operate correctly, the remote control requires programming to operate the device.
- 2** Switch on the component to be programmed, then press the corresponding mode button (such as **STB**) on the remote control. The remote control button of the desired device is illuminated.
- 3** Press the MENU and MUTE buttons simultaneously, the remote control is ready to be programmed with the code.
- 4** Enter a code number using the number buttons on the remote control. Programming code numbers for the corresponding component can be found on the following pages. If the code is correct, the device will turn off.
- 5** Press the **MENU** button to store the code.
- 6** Test the remote control functions to see if the component responds correctly. If not, repeat from step 2.

APPENDIX

HDSTB

Brand	Codes	Brand	Codes	Brand	Codes
ALPHASTAR DSR	123	HOUSTON TRACKER	033 037 039 051	PROSAT	072
AMPLICA	050		057 104	RCA	066 106
BIRDVIEW	051 126 129	HUGHES	068	REALISTIC	043 074
CHANNEL MASTER	013 014 015 018	JANIEL	060 147	SAMSUNG	123
	036 055	JERROLD	061	SATELLITE SERVICE CO	028 035 047 057
CHAPARRAL	008 009 012 077	KATHREIN	108		085
CITOH	054	LEGEND	057	SCIENTIFIC ATLANTA	032 138
CURTIS MATHES	050 145	LG	001	SONY	103
DRAKE	005 006 007 010	LUTRON	132	STARCAST	041
	011 052 112 116	LUXOR	062 144	SUPER GUIDE	020 124 125
	141	MACOM	010 059 063 064	TEECOM	023 026 075 087
DX ANTENNA	024 046 056 076		065		088 090 107 130
ECHOSTAR	038 040 057 058	MEMOREX	057		137
	093 094 095 096	NEXTWAVE	028 124 125	TOSHIBA	002 127
	097 098 099 100	NORSAT	069 070	UNIDEN	016 025 042 043
	122	PACE SKY SATELLITE	143		044 045 048 049
ELECTRO HOME	089	PANASONIC	060 142		078 079 080 086
EUROPLUS	114	PANSAT	121		10 135 136
FUJITSU	017 021 022 027	PERSONAL CABLE	117	VIEWSTAR	115
	133 134	PHILIPS	071	WINEGARD	128 146
GENERAL INSTRUMENT	003 004 016 029	PICO	105	ZENITH	081 082 083 084
	031 059 101	PRESIDENT	019 102		091 120
HITACHI	139 140	PRIMESTAR	030 110 111		

IR CODES

1. How to Connect

- Connect your wired remote control to the Remote Control port on the TV.

2. Remote Control IR Codes

■ Output waveform

Single pulse, modulated with 37.917KHz signal at 455KHz

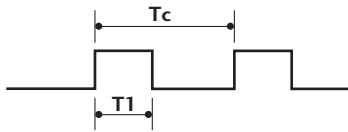

Carrier frequency
 $FCAR = 1/T_C = f_{OSC}/12$
 Duty ratio = $T_1/T_C = 1/3$

■ Configuration of frame

1st frame

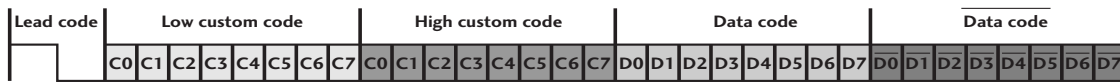

Repeat frame

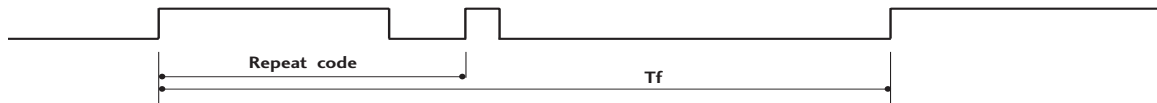

■ Lead code

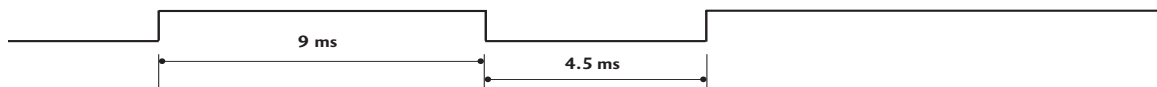

■ Repeat code

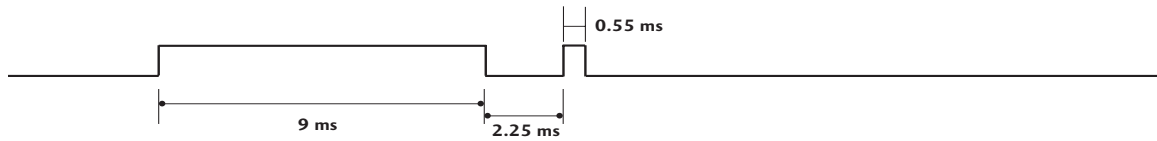

■ Bit description



■ Frame interval: Tf

The waveform is transmitted as long as a key is depressed.

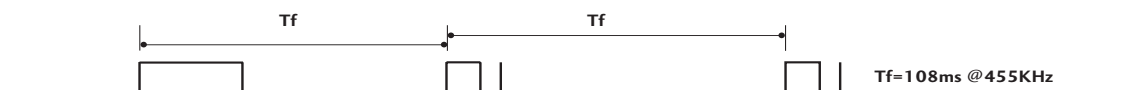

APPENDIX

Code (Hexa)	Function	Note
08	POWER	R/C BUTTON (POWER ON/OFF)
0B	INPUT	R/C BUTTON
F0	TV/RADIO	R/C BUTTON
45	Q.MENU	R/C BUTTON
43	MENU	R/C BUTTON
AB	GUIDE	R/C BUTTON
07	Left (< or ◀)	R/C BUTTON
06	Right (> or ▶)	R/C BUTTON
40	Up (^ or ▲)	R/C BUTTON
41	Down (v or ▼)	R/C BUTTON
44	OK(⊙)	R/C BUTTON
28	RETURN	R/C BUTTON
AA	INFO ⓘ	R/C BUTTON
30	AV MODE	R/C BUTTON
02	VOL + (or ◁+)	R/C BUTTON
03	VOL - (or ▷-)	R/C BUTTON
00	P ^ (or (PR + or P +))	R/C BUTTON
01	P v (or (PR - or P -))	R/C BUTTON
1E	FAV	R/C BUTTON
09	MUTE	R/C BUTTON
10 ~19	Number Key 0~9	R/C BUTTON
53	LIST	R/C BUTTON
1A	Q.VIEW	R/C BUTTON
72	RED Key	R/C BUTTON
71	GREEN Key	R/C BUTTON
63	YELLOW Key	R/C BUTTON
61	BLUE Key	R/C BUTTON
20	TEXT	R/C BUTTON
21	T.Option	R/C BUTTON
39	SUBTITLE	R/C BUTTON
BD	●(Record)	R/C BUTTON
7E	SIMPLINK	R/C BUTTON
79	RATIO	R/C BUTTON
0A	I/II	R/C BUTTON
0E	SLEEP	R/C BUTTON
26	TIME	R/C BUTTON
2A	REVEAL	R/C BUTTON
50	TV D/A	R/C BUTTON
62	UPDATE	R/C BUTTON
65	HOLD	R/C BUTTON
70	INDEX	R/C BUTTON

EXTERNAL CONTROL DEVICE SETUP

RS-232C Setup

Connect the RS-232C (serial port) input jack to an external control device (such as a computer or an A/V control system) to control the TV's functions externally.

Connect the serial port of the control device to the RS-232C jack on the TV back panel.

Note: RS-232C connection cables are not supplied with the TV.

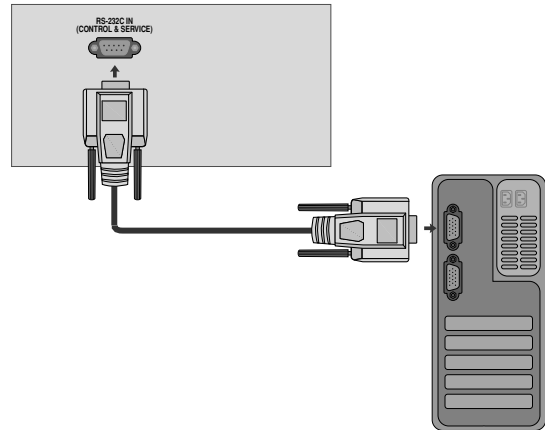

Type of Connector; D-Sub 9-Pin Male

No.	Pin Name
1	No connection
2	RXD (Receive data)
3	TXD (Transmit data)
4	DTR (DTE side ready)
5	GND
6	DSR (DCE side ready)
7	RTS (Ready to send)
8	CTS (Clear to send)
9	No Connection

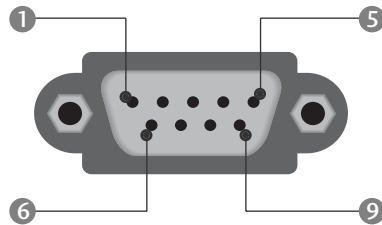

RS-232C Configurations

7-Wire Configurations (Standard RS-232C cable)

	PC	TV	
RXD	2	3	TXD
TXD	3	2	RXD
GND	5	5	GND
DTR	4	6	DSR
DSR	6	4	DTR
RTS	7	8	CTS
CTS	8	7	RTS

D-Sub 9 D-Sub 9

3-Wire Configurations (Not standard)

	PC	TV	
RXD	2	3	TXD
TXD	3	2	RXD
GND	5	5	GND
DTR	4	6	DTR
DSR	6	4	DSR
RTS	7	7	RTS
CTS	8	8	CTS

D-Sub 9 D-Sub 9

APPENDIX

Set ID

Use this function to specify a set ID number.
Refer to 'Real Data Mapping'. ► p. 114

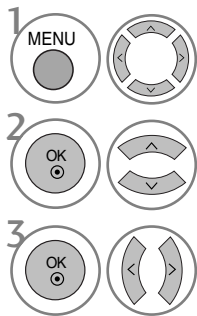
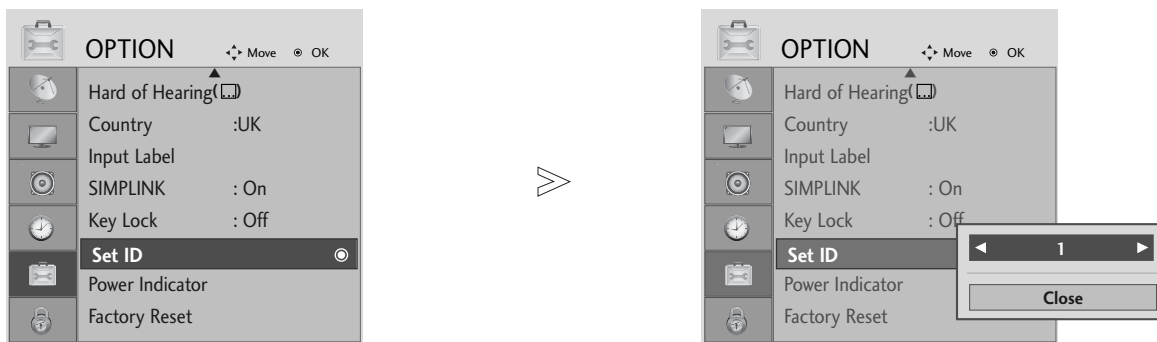

Select **OPTION**.

Select **Set ID**.

adjust **Set ID** to choose the desired TV ID number.
The adjustment range of SET ID is 1~99.

- Press the **RETURN** button to move to the previous menu screen.

Communication Parameters

- Baud rate : 9600 bps (UART)
- Data length : 8 bits
- Parity : None
- Stop bit : 1 bit
- Communication code : ASCII code
- Use a crossed (reverse) cable.

Command Reference List

	COMMAND 1	COMMAND 2	DATA (Hexadecimal)
01. Power	k	a	00 ~ 01
02. Aspect Ratio	k	c	Refer to p. 112
03. Screen Mute	k	d	00 ~ 01
04. Volume Mute	k	e	00 ~ 01
05. Volume Control	k	f	00 ~ 64
06. Contrast	k	g	00 ~ 64
07. Brightness	k	h	00 ~ 64
08. Colour	k	i	00 ~ 64
09. Tint	k	j	00 ~ 64
10. Sharpness	k	k	00 ~ 64
11. OSD Select	k	l	00 ~ 01
12. Remote control lock mode	k	m	00 ~ 01
13. Balance	k	t	00 ~ 64
14. Colour Temperature	k	u	00 ~ 02
15. Abnormal Status	k	z	00 ~ 09
16. ISM Method	j	p	Refer to p. 114
17. Power Saving	j	q	00 ~ 04
18. Auto Configure	j	u	01
19. Equalize	j	v	Refer to p. 114
20. Tune Command	m	a	Refer to p. 114
21. Channel Add/Skip	m	b	00 ~ 01
22. Key	m	c	Key Code
23. Control Back Light	m	g	00 ~ 64
24. Input select (Main)	x	b	Refer to p. 115

* When setting the 15 ~ 24, a menu does not appear on screen.

Transmission / Receiving Protocol

Transmission

[Command1][Command2][][Set ID][][Data][Cr]

- * [Command 1] : First command to control the TV.
(j, k, m or x)
- * [Command 2] : Second command to control the TV.
- * [Set ID] : You can adjust the set ID to choose desired monitor ID number in option menu. Adjustment range is 1 ~ 99. When selecting Set ID '0', every connected set is controlled. Set ID is indicated as decimal (1~99) on menu and as Hexa decimal (0x0~0x63) on transmission/receiving protocol.
- * [DATA] : To transmit command data. Transmit 'FF' data to read status of command.
- * [Cr] : Carriage Return
ASCII code '0x0D'
- * [] : ASCII code 'space (0x20)'

OK Acknowledgement

[Command2][][Set ID][][OK][Data][x]

- * The TV transmits ACK (acknowledgement) based on this format when receiving normal data. At this time, if the data is data read mode, it indicates present status data. If the data is data write mode, it returns the data of the PC computer.

Error Acknowledgement

[Command2][][Set ID][][NG][Data][x]

- * The TV transmits ACK (acknowledgement) based on this format when receiving abnormal data from nonviable functions or communication errors.

APPENDIX

01. Power (Command: k a)

- ▶ To control Power On/Off of the TV.

Transmission

[k][a][][Set ID][][Data][Cr]

Data 00 : Power Off 01 : Power On

Ack

[a][][Set ID][][OK/NG][Data][x]

- ▶ To show Power On/Off.

Transmission

[k][a][][Set ID][][FF][Cr]

Ack

[a][][Set ID][][OK/NG][Data][x]

* Similarly, if other functions transmit '0xFF' data based on this format, Acknowledgement data feed back presents status about each function.

* OK Ack. ,Error Ack. and other message maybe display on the screen when TV is power On.

02. Aspect Ratio (Command: k c) (Main Picture Size)

- ▶ To adjust the screen format. (Main picture format)
You can also adjust the screen format using the **Aspect Ratio** in the Q.MENU. or PICTURE menu.

Transmission

[k][c][][Set ID][][Data][Cr]

Data 01 : Normal screen (4:3) 06 : Original
 02 : Wide screen (16:9) 07 : 14:9
 04 : Zoom1
 05 : Zoom2 09 : Just Scan

Ack

[c][][Set ID][][OK/NG][Data][x]

- * Using the PC input, you select either 16:9 or 4:3 screen aspect ratio.
- * In **HDMI/Component** (over 720p) mode, **Just Scan** is available.
- * You can only select **Original** in UK digital teletext (MHEG-5).

03. Screen Mute (Command: k d)

- ▶ To select screen mute on/off.

Transmission

[k][d][][Set ID][][Data][Cr]

Data 00 : Screen mute off (Picture on)
 01 : Screen mute on (Picture off)

Ack

[d][][Set ID][][OK/NG][Data][x]

04. Volume Mute (Command: k e)

- ▶ To control volume mute on/off.
You can also adjust mute using the MUTE button on remote control.

Transmission

[k][e][][Set ID][][Data][Cr]

Data 00 : Volume mute on (Volume off)
 01 : Volume mute off (Volume on)

Ack

[e][][Set ID][][OK/NG][Data][x]

05. Volume Control (Command: k f)

- ▶ To adjust volume.
You can also adjust volume with the VOLUME buttons on remote control.

Transmission

[k][f][][Set ID][][Data][Cr]

Data Min : 00 ~ Max : 64

* Refer to 'Real data mapping 1'. See page 114.

Ack

[f][][Set ID][][OK/NG][Data][x]

06. Contrast (Command: k g)

- ▶ To adjust screen contrast.
You can also adjust contrast in the PICTURE menu.

Transmission

[k][g][][Set ID][][Data][Cr]

Data Min : 00 ~ Max : 64

* Refer to 'Real data mapping 1'. See page 114.

Ack

[g][][Set ID][][OK/NG][Data][x]

07. Brightness (Command: k h)

- ▶ To adjust screen brightness.
You can also adjust brightness in the PICTURE menu.

Transmission

[k][h][][Set ID][][Data][Cr]

Data Min : 00 ~ Max : 64

* Refer to 'Real data mapping 1'. See page 114.

Ack

[h][][Set ID][][OK/NG][Data][x]

08. Colour (Command: k i)

- ▶ To adjust the screen colour.
You can also adjust colour in the PICTURE menu.

Transmission

[k][i][][Set ID][][Data][Cr]

Data Min : 00 ~ Max : 64

* Refer to 'Real data mapping 1'. See page 114.

Ack

[i][][Set ID][][OK/NG][Data][x]

09. Tint (Command: k j)

- ▶ To adjust the screen tint.
You can also adjust tint in the PICTURE menu.

Transmission

```
[k][j][ ][Set ID][ ][Data][Cr]
```

Data Red : 00 ~ Green : 64
* Refer to 'Real data mapping 1'. See page 114.

Ack

```
[j][ ][Set ID][ ][OK/NG][Data][x]
```

10. Sharpness (Command: k k)

- ▶ To adjust the screen sharpness.
You can also adjust sharpness in the PICTURE menu.

Transmission

```
[k][k][ ][Set ID][ ][Data][Cr]
```

Data Min : 00 ~ Max : 64
* Refer to 'Real data mapping 1'. See page 114.

Ack

```
[k][ ][Set ID][ ][OK/NG][Data][x]
```

11. OSD Select (Command: k l)

- ▶ To select OSD (On Screen Display) on/off when controlling remotely.

Transmission

```
[k][l][ ][Set ID][ ][Data][Cr]
```

Data 00 : OSD off 01 : OSD on

Ack

```
[l][ ][Set ID][ ][OK/NG][Data][x]
```

12. Remote control lock mode (Command: k m)

- ▶ To lock the front panel controls on the monitor and remote control.

Transmission

```
[k][m][ ][Set ID][ ][Data][Cr]
```

Data 00 : Lock off 01 : Lock on

Ack

```
[m][ ][Set ID][ ][OK/NG][Data][x]
```

- * If you are not using the remote control, use this mode.
When main power is on/off, external control lock is released.

13. Balance (Command: k t)

- ▶ To adjust balance.
You can also adjust balance in the AUDIO menu.

Transmission

```
[k][t][ ][Set ID][ ][Data][Cr]
```

Data Min : 00 ~ Max : 64
* Refer to 'Real data mapping 1'. See page 114.

Ack

```
[t][ ][Set ID][ ][OK/NG][Data][x]
```

14. Colour Temperature (Command: k u)

- ▶ To adjust colour temperature. You can also adjust Colour Temperature in the PICTURE menu.

Transmission

```
[k][u][ ][Set ID][ ][Data][Cr]
```

Data 00: Medium 01: Cool 02: Warm

Ack

```
[u][ ][Set ID][ ][OK/NG][Data][x]
```

15. Abnormal State (Command: k z)

- ▶ To recognize an abnormal state.

Transmission

```
[k][z][ ][Set ID][ ][FF][ ][Cr]
```

Data FF : Read

Ack

```
[z][ ][Set ID][ ][OK/NG][Data][x]
```

Data 00: Normal (Power on and signal exist)
01: No signal (Power on)
02: Turn the monitor off by remote control
03: Turn the monitor off by sleep time function
04: Turn the monitor off by RS-232C function
05: 5V down
06: AC down
07: Turn the monitor off by Fan Alarm function
08: Turn the monitor off by Off time function
09: Turn the monitor off by Auto sleep function
a: Turn the monitor off by AV Board detect

- * This function is "read only".

APPENDIX

16. ISM Method (Plasma TV only) (Command: j p)

► To control the ISM method. You can also adjust ISM Method in OPTION menu.

Transmission

[j][p][][Set ID][][Data][Cr]

Data 01: Inversion
02: Orbiter
04: White wash
08: Normal

Ack

[p][][Set ID][][OK/NG][Data][x]

17. Power Saving (Plasma TV only) (Command: j q)

► To reduce the power consumption of the TV. You can also adjust Low Power in OPTION menu.

Transmission

[j][q][][Set ID][][Data][Cr]

Data Min :00 ~ Max :04 (*transmit by hexadecimal code)

Ack

[q][][Set ID][][OK/NG][Data][x]

18. Auto Configure (Command: j u)

► To adjust picture position and minimize image shaking automatically. It works only in RGB (PC) mode.

Transmission

[j][u][][Set ID][][Data][Cr]

Data 01: To set

Ack

[u][][Set ID][][OK/NG][Data][x]

* Real data mapping 1

00 : Step 0
⋮
A : Step 10 (Set ID 10)
⋮
F : Step 15 (Set ID 15)
10 : Step 16 (Set ID 16)
⋮
64 : Step 100
⋮
6E : Step 110
⋮
73 : Step 115
74 : Step 116
⋮
C7 : Step 199
⋮
FE : Step 254
FF : Step 255

* Real data mapping 2

00 :-40
01 :-39
02 :-38
⋮
28 : 0
⋮
4E : +38
4F : +39
50 : +40

19. Equalize (Command : j v)

► To adjust equalize.

Transmission

[j][v][][Set ID][][Data][Cr]

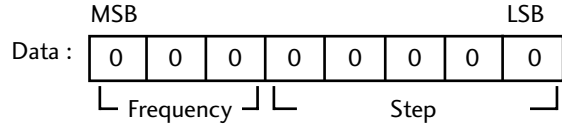

Frequency : 0 120Hz
1 200Hz
2 500Hz
3 1.2kHz
4 3kHz
5 7.5kHz
6 12kHz

Step (Frequency data):
Refer to 'Real data mapping 3'. See page 115.

Ack

[v][][Set ID][][OK/NG][Data][x]

* Euqalize command expression

7	6	5	4	3	2	1	0	Frequency
0	0	0						120Hz
0	0	1						200Hz
0	1	0						500Hz
0	1	1						1.2KHz
1	0	0						3KHz
1	0	1						7.5KHz
1	1	0						12KHz

7	6	5	Step					OSD Value
			4	3	2	1	0	
			0	0	0	0	0	-24
		
			0	1	1	1	1	0
		
			1	1	1	1	1	24

Ex) If you wish to set frequency 500Hz and -20 value on menu OSD, refer to 'Real data mapping 3' and then find Step value for -20.

010 (500Hz) 00011 (Step 3) => 01000011 => 43 (Hexadecimal) : [j][v][][Set ID][][43][Cr]

* 3 bits of Frequency and 5 bits of Step makes 8 bits (1 byte). Change 8 bits to Hexadecimal code.

20. Tune Command (Command: m a)

► Select channel to following physical number.

Transmission

[m][a][][Set ID][][Data0][][Data1][][Data2][Cr]

Data 00 : High channel data

Data 01 : Low channel data

ex. No. 47 -> 00 2F (2FH)
 No. 394 -> 01 88 (188H),
 DTV No. 0 -> Don't care

Data 02 : 0x00 : ATV, 0x10 : DTV, 0x20 : Radio

Channel data range

Analogue - Min: 00 ~ Max: 63 (0~99)

Digital - Min: 00 ~ Max: 3E7 (0~999)

Ack

[a][][Set ID][][OK/NG][Data][x]

Data Min: 00 ~ Max: 7DH

21. Channel Add/Skip (Command: m b)

► To set skip status for the current Programme.

Transmission

[m][b][][Set ID][][Data][Cr]

Data 00 : Skip

01 : Add

Ack

[b][][Set ID][][OK/NG][Data][x]

22. Key (Command : m c)

► To send IR remote key code.

Transmission

[m][c][][Set ID][][Data][Cr]

Data Key code - Refer to page 108.

Ack

[c][][Set ID][][OK/NG][Data][x]

23. Control Back Light (LCD TV only) (Command: m g)

► To Control the back light.

Transmission

[m][g][][Set ID][][Data][Cr]

Data : Min: 00 ~ Max: 64 (*transmit by hexadecimal code)

Ack

[g][][Set ID][][OK/NG][Data][x]

24. Input select (Command: x b) (Main Picture Input)

► To select input source for main picture.

Transmission

[x][b][][Set ID][][Data][Cr]

Data Structure

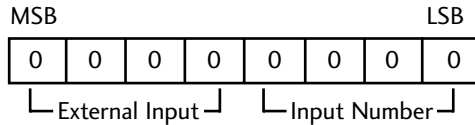

External Input				Data
0	0	0	0	DTV
0	0	0	1	Analogue
0	0	1	0	AV
0	1	0	0	Component
0	1	1	0	RGB
1	0	0	1	HDMI

Input Number				Data
0	0	0	0	Input1
0	0	0	1	Input2
0	0	1	0	Input3

Ack

[b][][Set ID][][OK/NG][Data][x]

* Real data mapping 3 (Equalize)

Step: OSD	Step: OSD
00 : -24	16 : 1
01 : -23	17 : 3
02 : -21	18 : 4
03 : -20	19 : 6
04 : -18	20 : 7
05 : -16	21 : 9
06 : -15	22 : 10
07 : -13	23 : 12
08 : -12	24 : 13
09 : -10	25 : 15
10 : -8	26 : 16
11 : -7	27 : 18
12 : -5	28 : 19
13 : -4	29 : 21
14 : -2	30 : 22
15 : 0	31 : 24

LG Electronics Inc.