



Use and Care manual

LG Condensing Dryer

RC8011A / RC8011B / RC8011C
RC8011A1 / RC8011B1 / RC8011C1

Please read this manual carefully prior to use.

Keep it for future reference.

Write down model name and serial number of your product.

Have all these details ready when you call for service.

F eatures



- **Ultra big Capacity Drum**
LG Dryer has 8.0kg capacity which is the ultra big capacity.

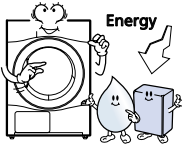

- **Lower Energy Consumption**
Energy is saved by cutting-edge engineering design of drying system and by optimized heating control. It's a real money saving.

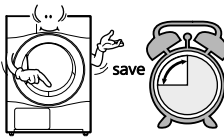

- **Reduced drying time**
Drying time is shortened by efficient air flow mechanism and optimized heater.

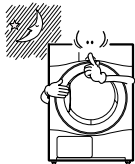

- **Innovative noise performance**
Noise gets reduced by Noise-absorption & screening technology.

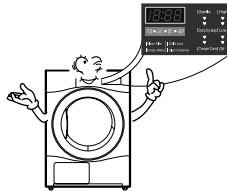

- **Easy of Use**
Wide LED display using electric control.

C ontents

| | |
|-------------------------------------|----|
| Safety Instructions | 3 |
| Installation Instructions | 6 |
| Appearance & Design | 9 |
| Operating Your Dryer | 10 |
| Additional Functions..... | 13 |
| Caring for Your Dryer | 15 |
| Additional Tips for Smart Use | 18 |
| Troubleshooting Guidelines | 20 |
| Technical Data | 22 |
| Warranty..... | 23 |

Safety Instructions

To help reduce any risk of electric shock, fire, or other personal or property injury when using your dryer, please follow basic safety instructions.

⚠ WARNING

Serious injury or death may occur when not observing the following rules.

⊘ Not allowed actions.

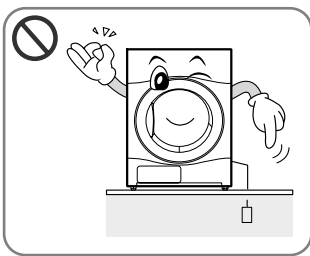

- Before plugging power cord, make sure cord is grounded and connected to circuit breaker.

.....

No grounding may cause breakdowns or an electric shock.

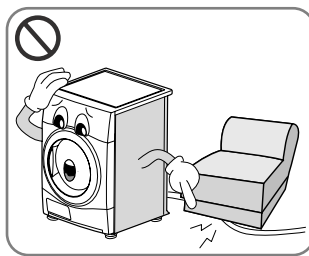

- Do not damage power cord or place heavy objects on the cord.

.....

The damaged power cord may cause a fire or an electric shock.

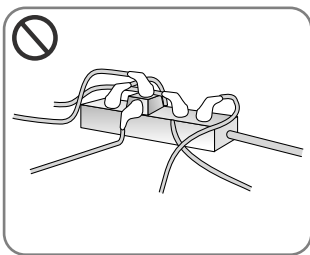

- Do not plug with several other appliances power cord. Do not use the extension power plug.

.....

Abnormal heating of outlet may cause a fire.



- Do not grasp power cord or switch with wet hands.

.....

It may cause an electric shock.

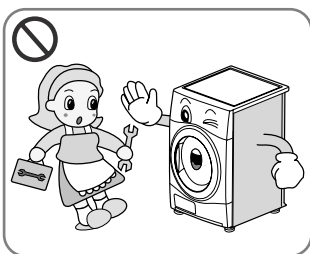

- Do not disassemble the top plate at installing the dryer.

.....

It may cause breakdowns, a fire or an electric shock.

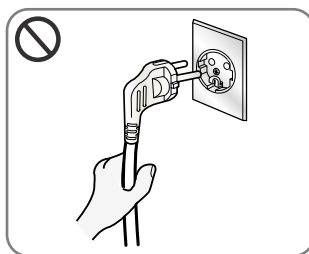

- Disconnect the power cord by grasping the plug, not the cord.

.....

It may cause cutting off wires so results in hot heat or a fire.

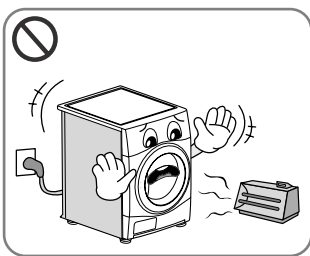

- Keep the dryer away from electric stove, candle and any inflammable objects.

.....

It may cause melting of some parts or a fire.

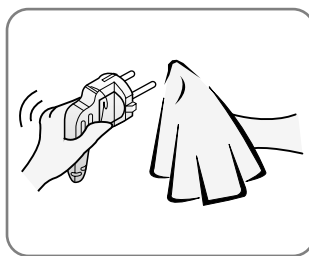

- Wipe out the dirt and stains around the power cord and insert firmly to the socket.

.....

Dirt around it and improper connection may cause a fire.

Safety Instructions

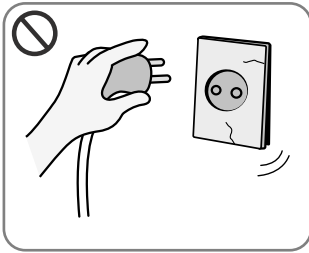

- Do not use damaged power cord, plug and socket.

It may cause a fire or an electric shock.

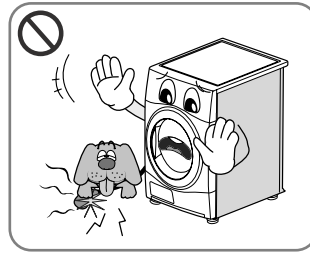

- Prevent pets biting the dryer.

Pets may die from an electric shock or appearance may be damaged.

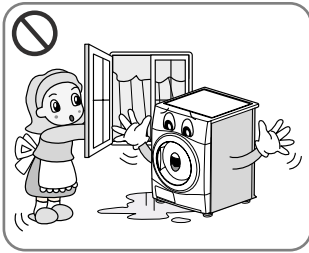

- Do not install or store the dryer where it will be exposed to the weather.

It may cause an electric shock, a fire, malfunction or deformation.

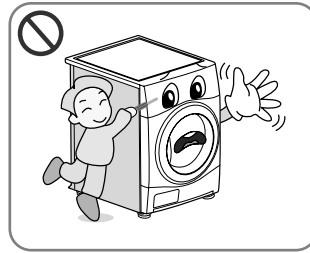

- Do not press the button with sharp edged devices like a screwdriver or a pin.

It may cause an electric shock.

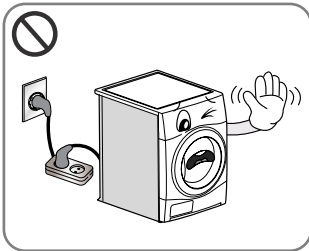

- Do not use an extension cord or an adaptor to connect the power cord.

It may cause an electric shock or a fire.

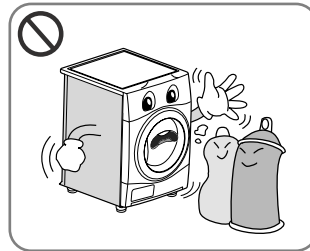

- Do not dry articles that have been cleaned in, washed in, soaked in, or spotted with combustible or explosive substances (such as wax, oil, paint, gasoline, degreasers, dry-cleaning solvents, kerosene, etc.)

It may cause an explosion or a fire.

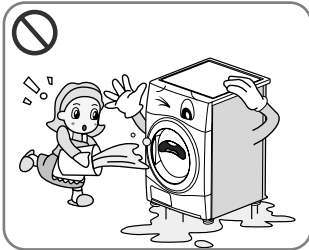

- Do not splash water on to the dryer.

It may cause a fire or an electric shock.

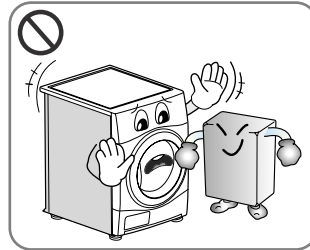

- Do not place flammable items near the dryer.

It may cause toxic gas, parts damage, an explosion or a fire.

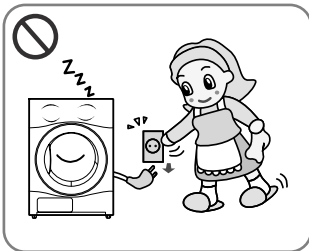

- Unplug the power cord when cleaning or not using the dryer.

Water or dirt may cause an electric shock.

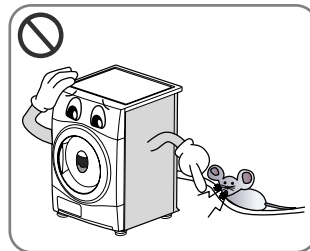

- Keep the dryer away from the reach of the cockroach and other insects.

Pets may die from an electric shock and appearance may be damaged.

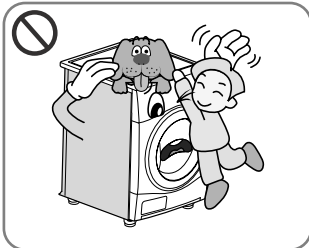

- Do not allow children or pets to play on or inside the dryer.

Children may fall off. Pets or children may be wounded by rotating parts or suffocated inside drum.

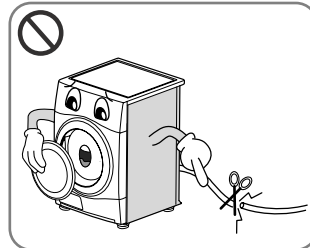

- Before the appliance is removed from service or discarded, disassemble the door and cut off the power cord to prevent the future use.

It may cause cord damage and breakdowns. Otherwise, it may cause accidents or physical injuries.

Safety Instructions

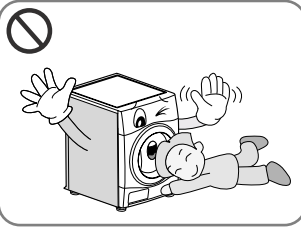

- Young children should be supervised to ensure that they do not play with the appliance.

Children may fall off. Pets or children may be wounded by rotating parts or suffocated inside drum.

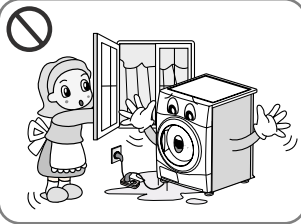

- If this appliance is supplied from a cord extension set or an electrical connector, portable outlet device must be positioned so that it is not subject to splashing or ingress of moisture.

It may cause an electric shock, a fire, malfunction and deformation.

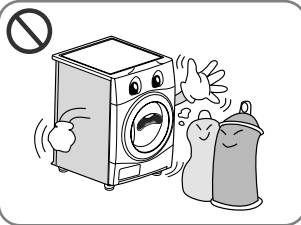

- Items that have been spotted or soaked with vegetable or cooking oil constitute a fire hazard and should not be placed in a tumble dryer.

It may cause an explosion and a fire by spontaneous combustion.

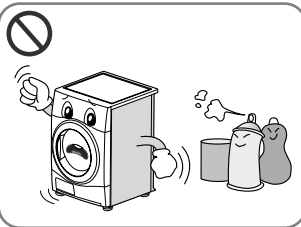

- Items that have been previously cleaned in washed in soaked in or spotted with petrol/gasoline, dry cleaning solvents or other flammable or explosive substances should not be used in a tumble dryer.

It may cause an explosion and a fire by spontaneous combustion.

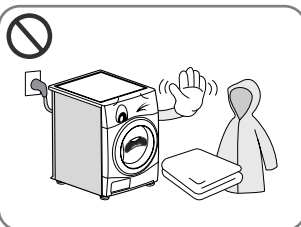

- Items made of foam, rubber, plastic, or other heat-sensitive fabrics (such as bathroom rugs, nonslip mats or raincoats) should not be dried in a tumble dryer on a heat setting.

It may cause an explosion and a fire by spontaneous combustion.



- Plastic articles such as shower caps or babies waterproof napkin covers should not be placed in a tumble dryer.

It may cause an explosion and a fire by spontaneous combustion.

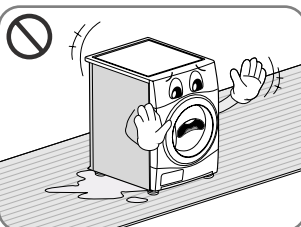

- If the dryer is installed on the carpet, it might be caused some damages by the ventilated air.

It may cause an explosion and a fire by spontaneous combustion.

Installation Instructions

The following instructions will guide you through the initial steps of setting up your dryer. Please note that every section of this manual provides important information regarding the preparation and use of your dryer, and it is important that you review this entire manual before proceeding with any installation or use. Be sure to observe all listed warnings and cautions. These installation instructions are intended for use by qualified installers. Read these installation instructions completely and carefully.

Safety Information

Risk of Injury

The dryer is very heavy so you shouldn't try to lift it alone.

Do not lift the dryer by grasping any of the protruding parts e.g. or the jog dial or the door. they may break off.

Risk of Tripping

Risk of tripping caused by hoses hanging down or cables. Ensure there are no loose hoses or cables.

Check the dryer for damage occurred during transportation.

Do not connect the dryer if it has visible signs of damage.

If you are not in confidence, contact your local agent. Always empty the dryer completely before transporting it.

Your dryer should not be located near gas hob, cooker, heater or eye level grill as flames from the burners could cause damage to your dryer. When the dryer is fitted under a work surface, allow 15 mm space from each side of the dryer for air to exit the rear grille. This airflow is critical to condense the water during drying.

If you use this dryer near or stacked on top of washing machine, separate main plugs and sockets must be used for each appliance. Do not use 2-way adaptor or extension lead.

You can stack the dryer on top of washing machine to save the space. A stacking kit is available from your local shop.

Stacking Installation Instructions

The LG Dryer can be placed on the top of a front loading washing machine. They are sure to be fixed with stacking kit (See the next page). This installation must be conducted by an experienced installer in order to secure robust installation of both washer and dryer. If this work is done very carelessly, dryer may fall off.

More importantly, a certain washer model has matching models for stacking so advice from the experienced installer is very critical.

⚠ CAUTION

CAUTION Concerning the power cord

Most appliances recommend they be placed upon a dedicated circuit; that is, a single outlet circuit which powers only that appliance and has no additional outlets or branch circuits. Check the specification page of this owner's manual to be certain.

Do not overload wall outlets. Overloaded wall outlets, loose or damaged wall outlets, extension cords, frayed power cords, or damaged or cracked wire insulation are dangerous. Any of these conditions could result in electric shock or fire. Periodically examine the cord of your appliance, and if its appearance indicates damage or deterioration, unplug it, discontinue use of the appliance, and have the cord replaced with an exact replacement part by an authorized servicer.

Protect the power cord from physical or mechanical abuse, such as being twisted, kinked, pinched, closed in a door, or walked upon. Pay particular attention to plugs, wall outlets, and the point where the cord exits the appliance.

Installation Instructions

Grounding Instruction

This appliance must be grounded. In the event of malfunction or breakdown, grounding will reduce the risk of electric shock by providing a path of least resistance for the electric current.

This appliance is equipped with a cord having an equipment grounding conductor and a grounding plug. The plug must be plugged into an appropriate outlet that is properly installed and grounded in accordance with all local codes and ordinances.

Additional Grounding Procedure

Some local codes may require a separate ground. In such cases, the required accessory ground wire, clamp and screw must be purchased separately.

Condensed Water Drain

The dryer can drain water without delivering to water container. Water is directly pumped out of the dryer.

Note

For better drying performance, Please keep the rear of product distance from wall.

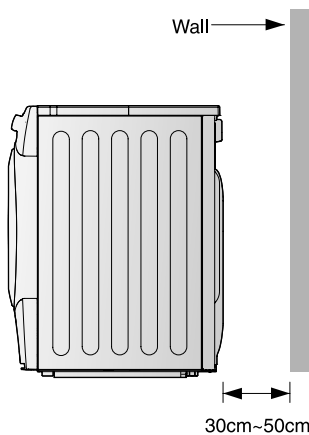

Stacking Kit

In order to stack this dryer on a LG washing machine, LG stacking kit is needed.

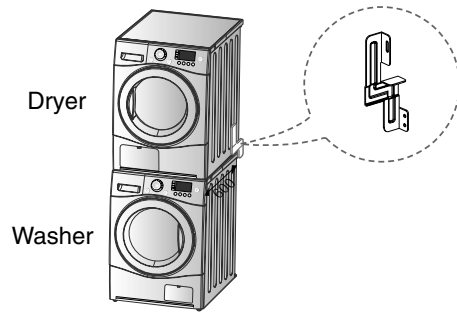
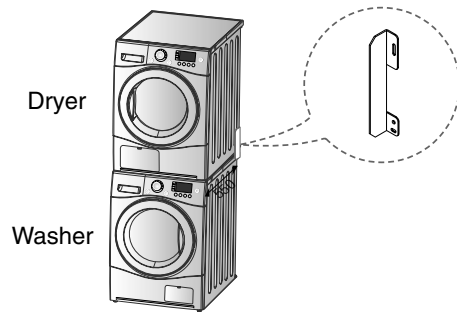

Washer top plate size

| | 550 mm | 600 mm |
|-------|--------|--------|
| Shape | | |

- You must use stacking kit according to your washer top plate size

In order to stack this dryer on LG washing machine, you must purchase the LG stacking kit that is fitted by LG washing machine top plate size.

Installation Instructions

● Level the Dryer

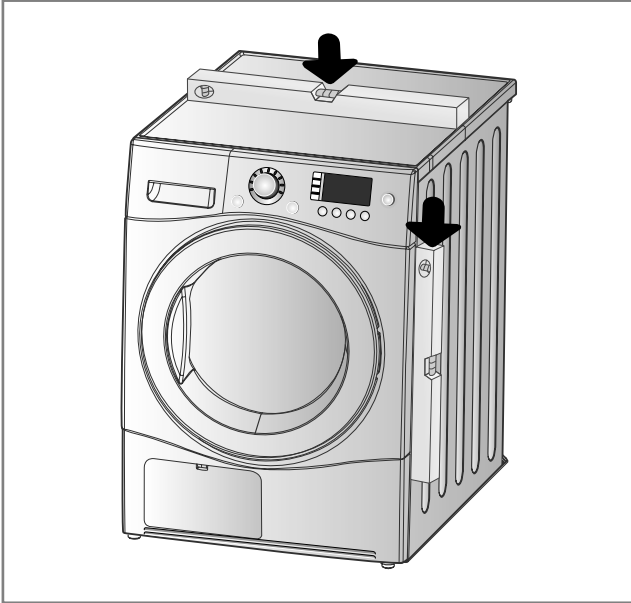

1. Leveling the dryer is to prevent undesirable noise and vibration.

When placing your dryer in an solid and level area where water is not dripping and freezing, flammable materials are not stored.

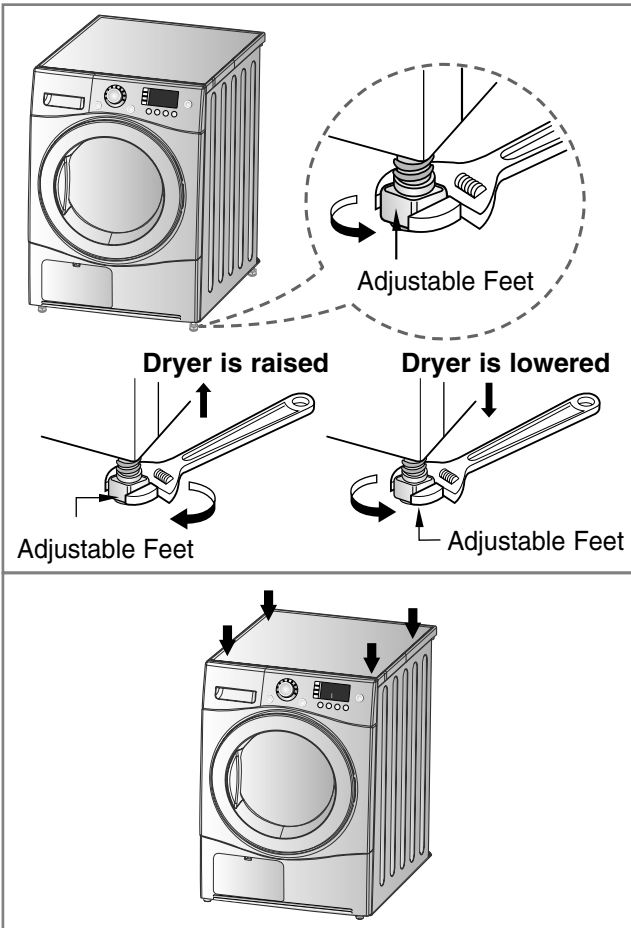

2. If the dryer is not properly level, adjust the front leveling legs up and down as necessary.

Turn them clockwise to raise and counterclockwise to lower until the dryer is not wobbling both front-to-back and side-to-side.

* *Diagonal Check*

When pushing down the edges of the machine, the machine should not move up and down at all.

(Please, check both of two directions)

If machine rocks when pushing the machine top plate diagonally, adjust the feet again.

Appearance & Design

RC8011A/B/C

RC8011A1/B1/C1

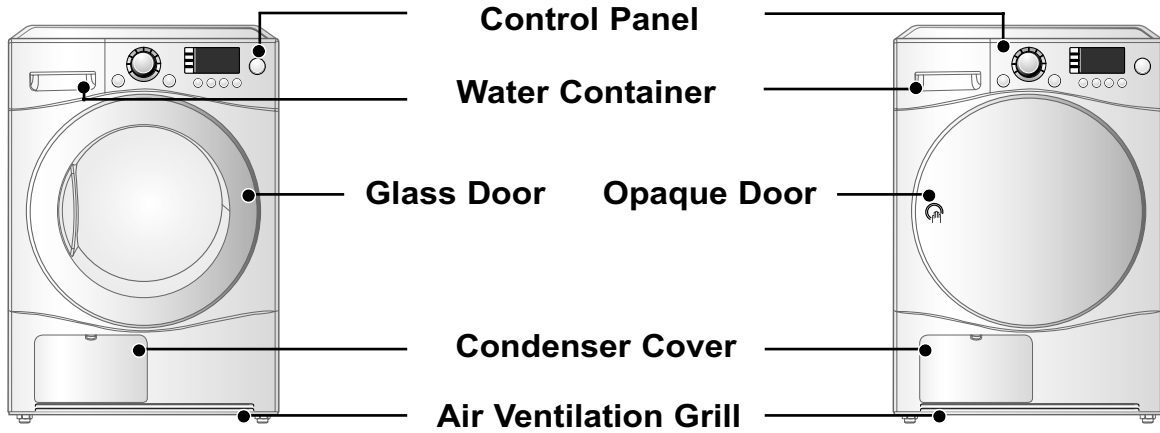

Control Panel

RC8011A/B/C

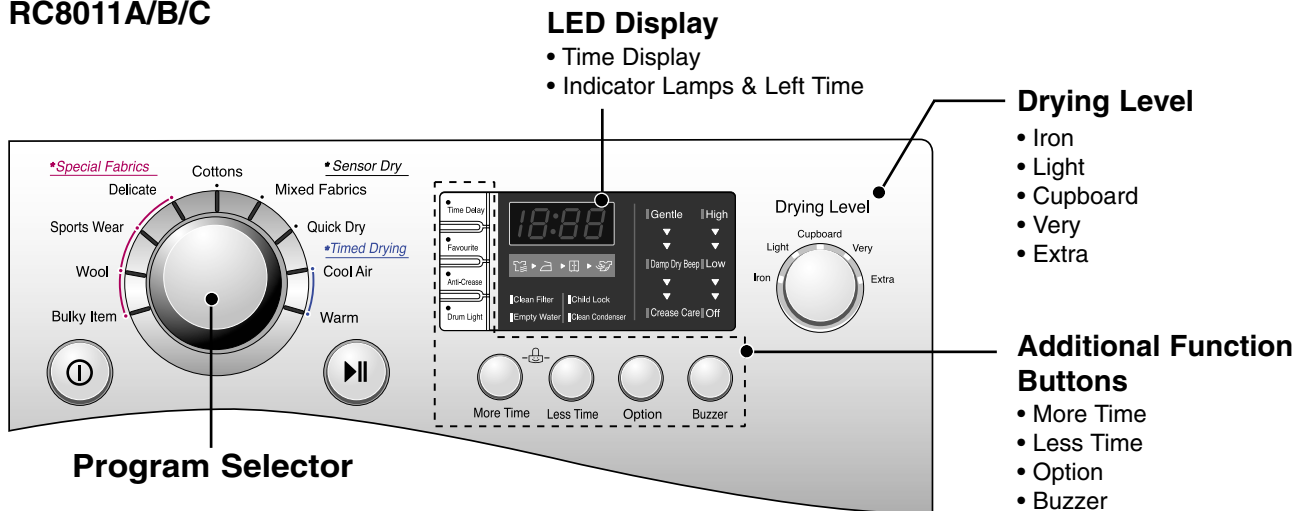

RC8011A1/B1/C1

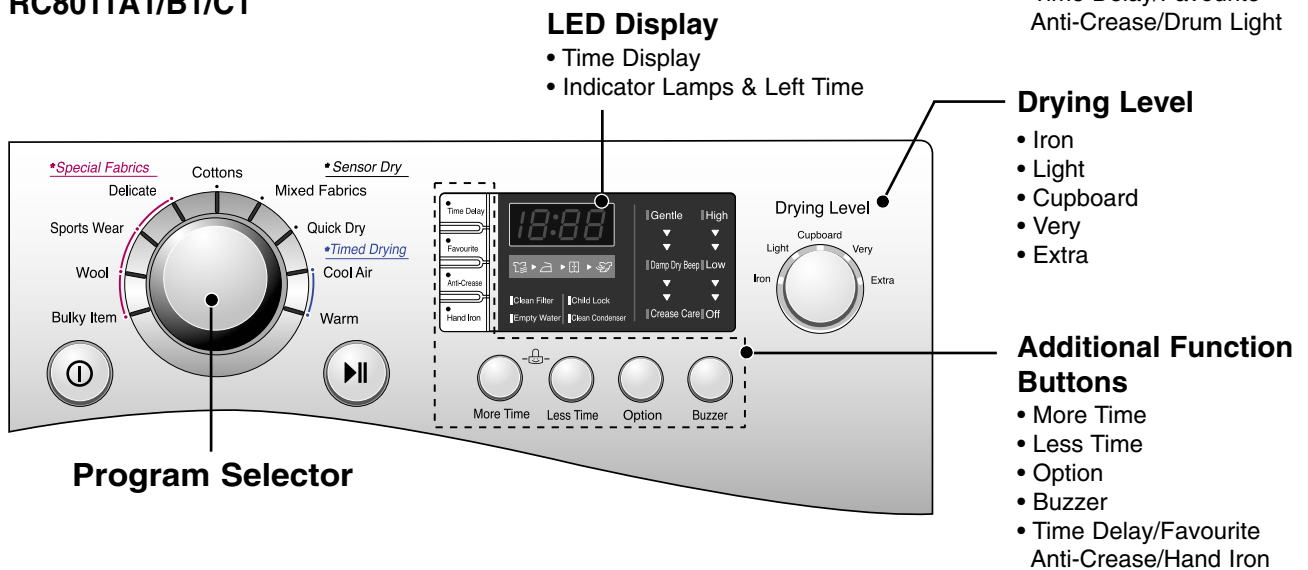

Operating Your Dryer

Cycle Selection Table

| Electronic Sensor Dry Cycles | | | Drying Level |
|--|---|--|--------------|
| Cotton Cycles (Note) Select the gentle by pressing the option button for heat-sensitive items | Towels, dressing gowns and bed linen | For thick and quilted fabrics | Extra |
| | Terry towels, tea towels, towels, bed linen | For thick and quilted fabrics which do not need to be ironed | Very |
| | Bath towels, tea towels, underwear, cotton socks | For fabrics which do not need to be ironed | Cupboard |
| | Sheets, pillowcase, towels | For fabrics which do not need to be ironed | Light |
| | Bed linen, table linen, towels, T-shirts Polo shirts and work clothes | For fabrics which do need to be ironed | Iron |
| Mixed Cycles (Note) Select the gentle by pressing the option button for heat-sensitive items | Bed linen, table linen, tracksuits, anorak, blankets | For thick and quilted fabrics which do not need to be ironed | Very |
| | Shirts, blouses | For fabrics which do not need to be ironed | Cupboard |
| | Trousers, dressers, skirts, blouses | For fabrics which do need to be ironed | Iron |
| Quick Dry | A kind of linen and towel except for the special fabrics | For the small loads of qualified fabrics with short drying times | - |
| Special Fabrics Cycles | | | |
| Delicate | Silk, Women's thin clothes, lingerie | For fabrics which are heat-sensitive like synthetic fabrics | - |
| Sports Wear | Soccer uniform, training wear | For polyester material | - |
| Wool | Wool | For wool fabrics | - |
| Bulkey Item | Bed clothes, sheets | For bulky items | - |
| Timed Drying | | | |
| Cool Air | All fabrics needing freshing, tumbles without heat | | - |
| Warm | Bath towels, bath robes, dishclothes, quilted fabrics made of acrylic | Small clothes & pre-dried laundry normal fabrics using hot temperature | - |

CAUTION

If the load is less than 1kg, please use "Warm Course in Timed Drying Course"
Your wool should be used in "Wool Program" and heat-sensitive fabrics including silk, underwears, lingerie should be used in "Delicates Courses".
And also please comply with the recommended laundry load when you use the special fabric course.
(Refer to the page 18)
Otherwise, these clothes can cause undesirable drying results.

Operating Your Dryer

● Before First Use of the Dryer

※ Before you use the dryer for the first time, there are some points that you have to check.

After removing package, you will check the product has no problem and is properly installed.

1. Check the dryer is well balanced by using a leveller. In order to check this, you can see and adjust legs which are suppose to stay put.
2. Check some major parts such as water container, condenser, control panel and drum.
3. It is needed to operate 5 minutes drying to make sure drum inside gets warm.
4. In the early use of dryer, please leave it with door opened and power unplugged after operation to get rid of probable smell inside.

1. Turn the power on.

First, press the “Power” button. The indicator light above the button will become illuminated indicating that the machine is all set to run.

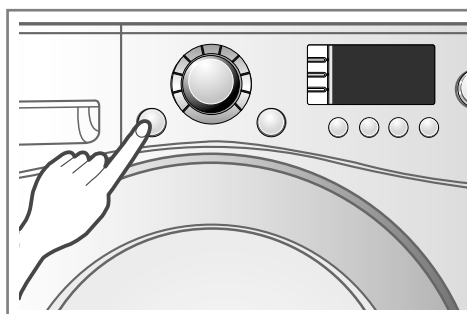

Turn the power on.

2. Open the door.

3. Check the lint filter, water container and condenser.

The lint filter near the door, should be emptied after or before drying operation.

Open the door and check if lint filter is cleaned. If not, please clean it referring to page 15. Water container and condenser are also checked to be emptied and cleaned for better drying result.

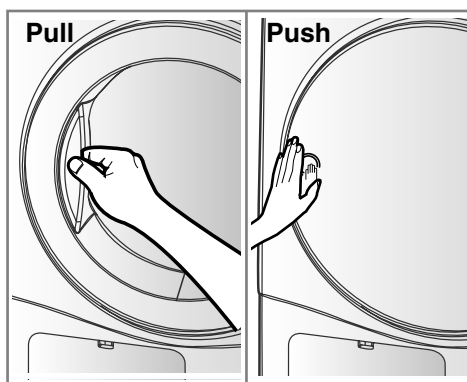

Open the Door.

4. Place laundry into the drum after sorting.

The clothes should be sorted by its fabric type and dryness level and all the strings and belts of clothes should be well tied and fixed before being put into the drum.

It is desired that you push laundry all the way back to keep it away from the door seal.

If not, door seal and clothes may be damaged.

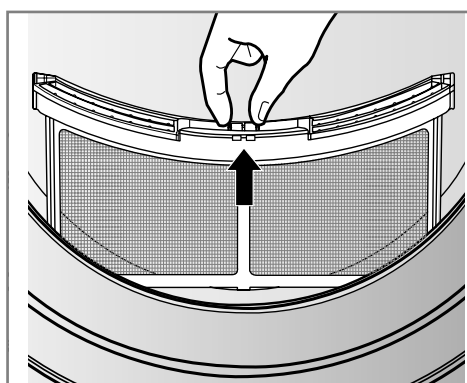

Check the lint filter.

Operating Your Dryer

5. Close the door.

Before you close the door, make sure fabrics are well placed inside and that foreign objects, especially flammable ones, are not caught around door.

⚠ CAUTION

- Be careful not to trap laundry in between the loading door and rubber seal.

6. Select the drying cycle you want.

You can choose a cycle by turning the program control knob until the required program reaches to its indicator. If you only press Start/Pause button without choosing any cycle, the dryer will proceed with the Cupboard program. [Please refer to following Cycle Selection table (page 10) for the detailed information]

7. Press the start button.

You can hear drum rotating sound.

8. After operation is completed, open the door and remove the laundry.

Careful! the drum inside could be still hot. (Operation time varies depending on your cycle selection or options.)

9. Clean the lint filters and empty water container.

The lint filter should be cleaned after each load.

10. Turn off the dryer.

Press the "Power" button.

⚠ CAUTION

- Be careful of the fact that filter should not be torn when using a vacuum cleaner. If there is a little residue buildup on filter, you can scrub lint screen with the brush to remove.
- If you want to open the door while dryer is operating, please press the Start/Pause button first, wait until drum completely stops and then open the door.

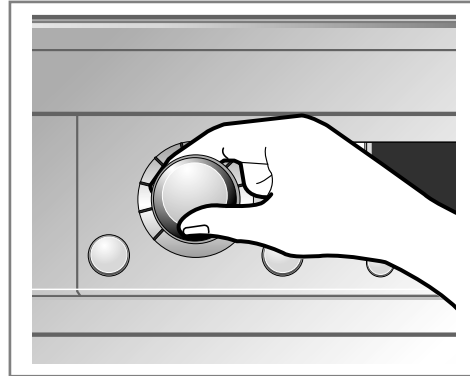

Select the desired cycle.

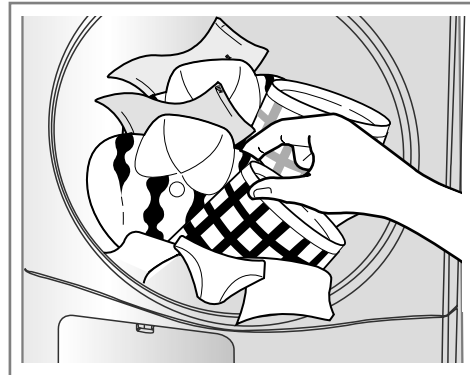

Take out the laundry.

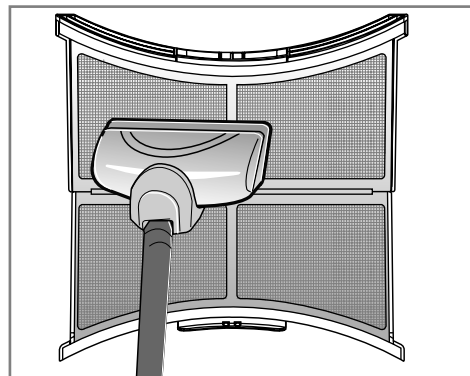

Clean the door lint filter.

Additional Functions

■ RC8011A/B/C

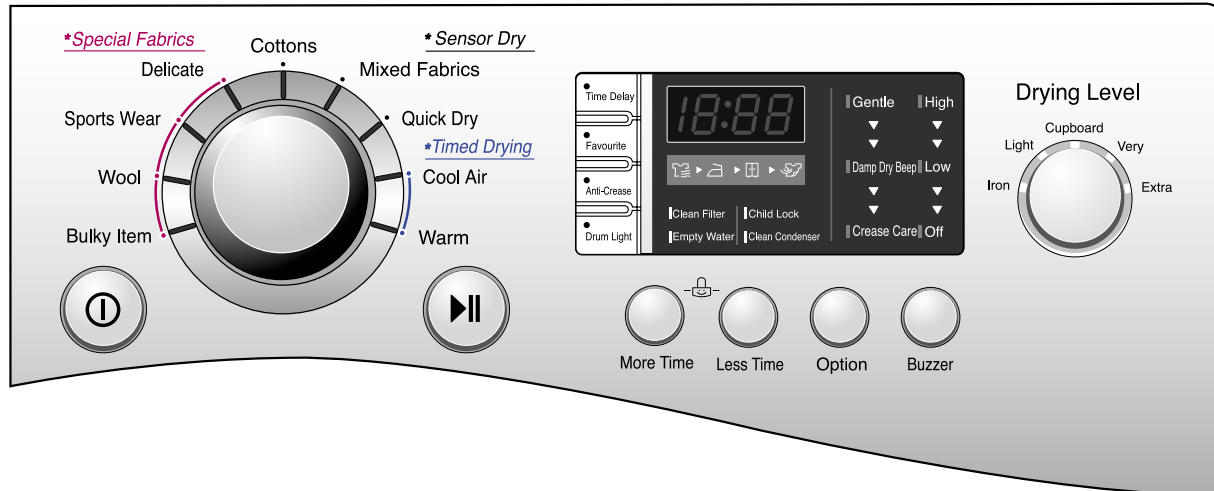

■ RC8011A1/B1/C1

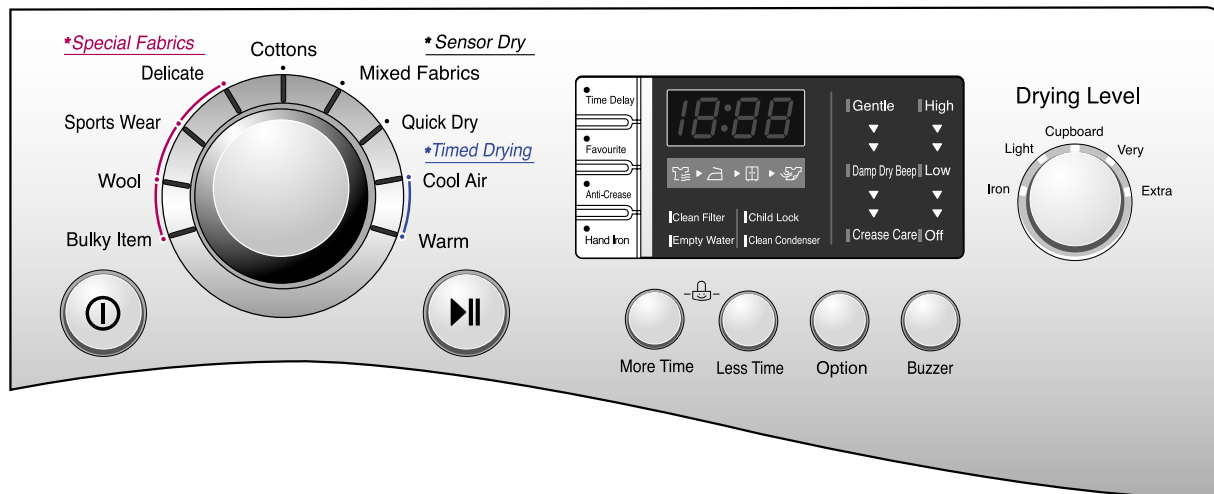

● Time Delay

You can use the Time Delay function to delay the finishing time of drying cycle.

Maximum Time Delay is 19 hours.

Minimum Time Delay is 3 hours.

1. Turn the dryer on
2. Select cycle
3. Set time delay hour
4. Press Start/Pause button

● Favourite

If there is some cycle you would like to make based on your own drying habit, use "Favourite". Once favourite cycle is stored, you can repeatedly use next time before changing the stored setting. For instance, you turn power on and select Extra Dry in Cotton Cycle and Low temp and Anti-Crease in series and then lastly press "Favourite" until the dryer beeps. It's about 3 seconds. That's all you have to do.

The next time, when turning the dryer on and pressing "Favourite" you can see the above options you select displays on the panel.

Additional Functions

● Anti-Crease

Anti-Crease is functioning to prevent creases and rumples that are formed when the laundry is not unloaded promptly at the end of drying cycle. In this function, the dryer repeatedly runs and pauses to the cycle end. If the door is open during Anti-Crease process, this function is cancelled.

● Drum Light/Hand Iron

Drum Light (Glass Door)

- During operating cycle, you can see the drum inside by choosing drum light function. It helps easy viewing the drying cycle.

Hand Iron (Opaque Door)

- This function remains more moist than the condition for ironing.

Note

This function is available only with Cotton-Iron and Mixed-Iron cycles.

● More Time/Less Time

Press More Time or Less Time until the desired drying time is set.

Note

These buttons are available only with Timed Drying, before you push Start/Pause button.

● Child Lock ([L])

For the safety of your children, press More Time and Less Time buttons at the same time for about 3 seconds. You can see "[L]" sign on LED window.

Note

For "[L]" off, press More Time and Less Time buttons at the same time for about 3 seconds.

● Option

Gentle

- These are functioning to shorten or lengthen the cycle time by increasing or decreasing temperature.
- This option only is used with the Cotton and Mixed Fabrics cycles.

Damp Dry Beep

- This is a function to inform when is the most suitable for ironing with beeper sound.
- This option only is used with the Cotton and Mixed Fabrics cycles.
- You can not use the 'Damp Dry Beep' when you select iron drying level.

Crease Care

- This is a function to reduce wrinkles.
- This is a function to set up automatically when you only select the Mixed Fabrics cycle, but cancellation is impossible.

Note

The option might be changed by the number of pressing the option button.

- Once : Gentle is selected.
- Twice : Damp Dry Beep option is selected.
- 3 Times : Gentle and Damp Dry Beep options are selected.
- 4 Times : No selected.

● Buzzer

This is a function to able to adjust volume of beeper sound.

Caring for Your Dryer

How important care and cleaning is~

It's not very difficult to care for your dryer. All you have to do is to follow the information below.

Clean Lint Filter

Clean lint filter after each use and check it before each use. It should also be cleaned if the "Clean Filter" light becomes illuminated and the buzzer sounds during operation of the dryer:

Cleaning or emptying the filter will reduce drying times and energy consumption and lengthen the dryer life.

1. Open the door.

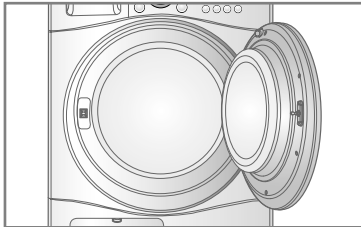

2. Pull the filter out.

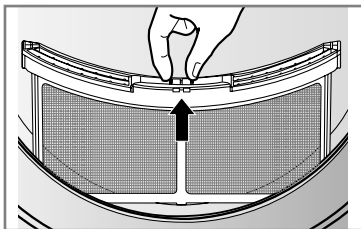

3. Clean the filter by using a vacuum cleaner or rinsing under the tap.

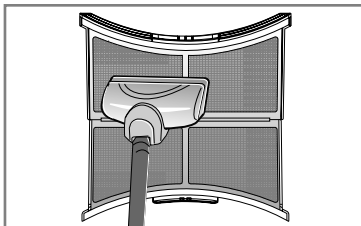

4. Replace the filter.
- Push the filter all the way down to avoid interference with the door.

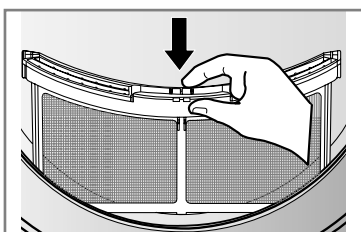

5. Close the door.

CAUTION

Wash the "Lint Filter" in warm, soapy water. Dry thoroughly and replace.

Clean lint filter during a cycle

If "Clean Filter" indicator lamp flashes during operation, clean the filter promptly.

1. Cool the dryer down and follow the mentioned steps.
2. Press the start/Pause button.

Empty Water Container

Condensed water is collected to water container. **You should empty the water container after every use.** Not doing this may result in improper drying performance.

If water container is full, "Empty Water" Lamp glows and a buzzer sounds while the dryer is operating. In this case, water container must be emptied in 1 hour

1. Draw water container out.

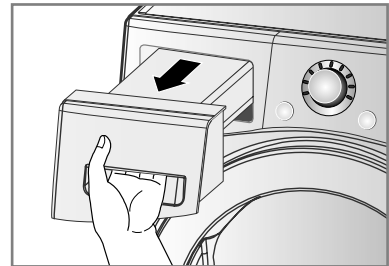

2. Empty water container to sink.

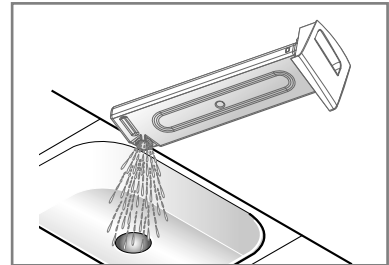

3. Push it back.

4. Press the Start/Pause button.

Note

High speed spinning, while washing, makes better energy consumption. A high surrounding temperature & a small room might increase the drying time as well as energy consumption.

WARNING

Don't drink the condensed water, absolutely.

CAUTION

If the laundry is not spun at high speed, while washing, energy consumption and the Drying time will increase. In some case, the laundry lamp flashes "Empty Water", then the dryer might stop.

Caring for Your Dryer

Condenser

Condenser is also a very important part for efficient drying performance result so it needs a special care from you. It is recommended that condenser be cleaned three or four times a year or when the condenser clean lamp blinks.

1. Open condensing cover by using a coin or flat blade screwdriver.

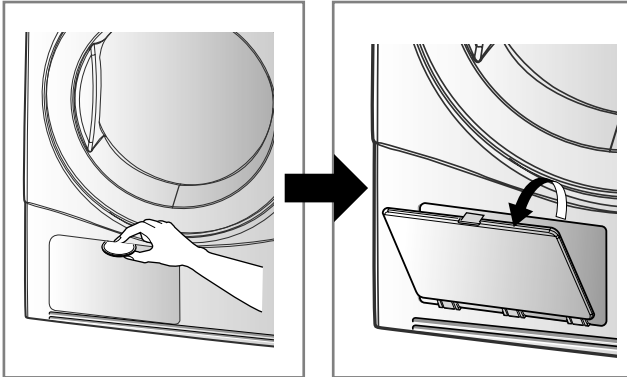

2. Open sealing cover by turning a locking lever.

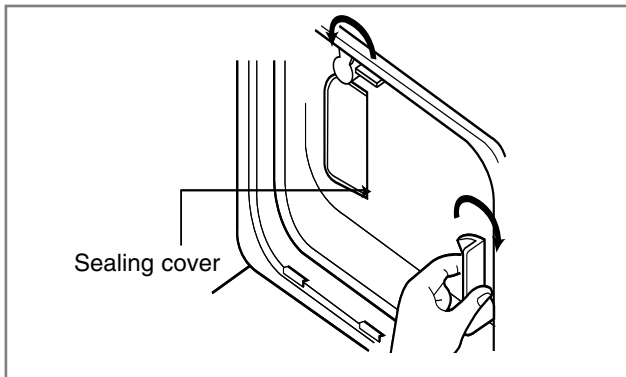

3. Draw the condenser out by inserting a finger into a hole down the front of condenser. (Don't forcefully treat condenser.)

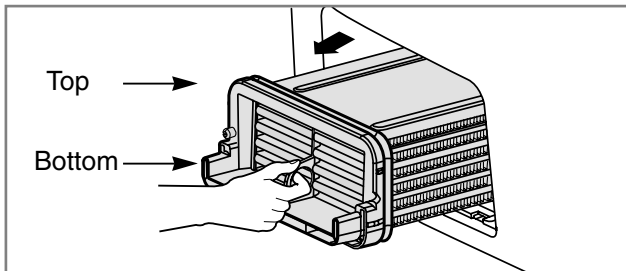

4. Clean the condenser completely under the tap letting water to flow through.

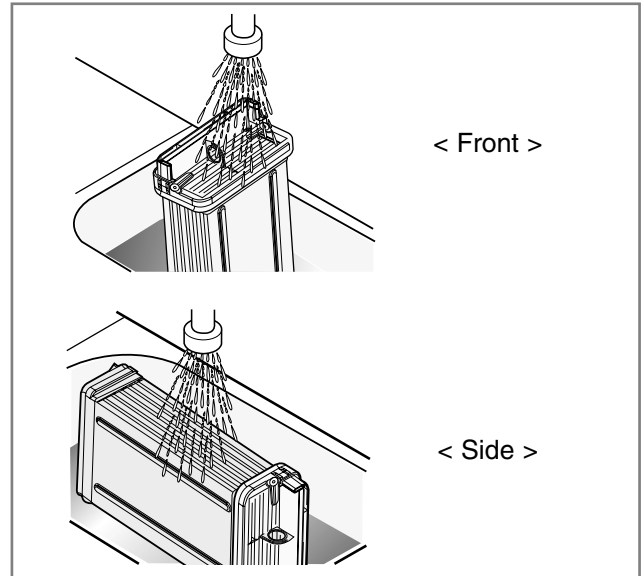

5. Close all with the reverse order of opening.

⚠ CAUTION

- Operating when the condenser is clogged with lint can damage the dryer. This also increases energy consumption.
- Do not use sharp objects to clean the heat exchanger. You could damage it and cause leaks.
- Never operate the dryer without the heat exchanger.

Caring for Your Dryer

Ventilation Grille and Cool Air Inlet Grille

Vacuum the front ventilation grill 3~4 time a year to make sure there must be no build-up of lints or dirt which cause improper intake air flow.

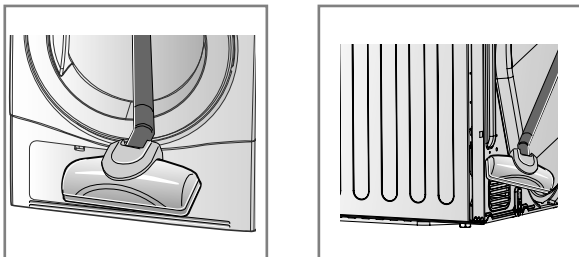

Note

The warm air is exhausted through the ventilation grill.

Condensed Water Drain-out

Normally, condensed water is pumped up to water container where water is collected until emptied. Not only using water container, but water can be drained out directly to drain hose especially when dryer is stacked on top of washing machine. With connecting kit for drain hose, you can simply change water path and water reroute to the drainage facility. Please follow the below steps.

1. Take connecting kit out.

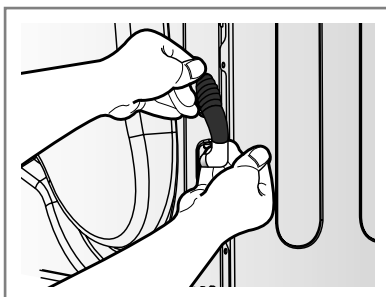

2. Separate water container hose from the kit.

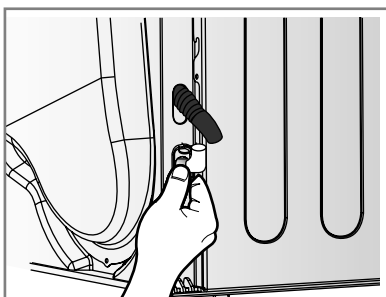

3. Connect drain hose to the kit.

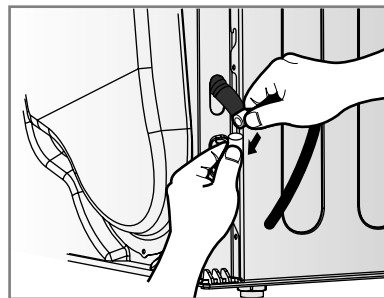

Moisture Sensor?

This device functions to sense the moisture remaining contents of the laundry during operation which means it must be cleaned all the time. The main reason of cleaning this part is to remove the build-up of lime scale on the surface of sensor. Wipe the sensors inside drum (Shown in the picture).

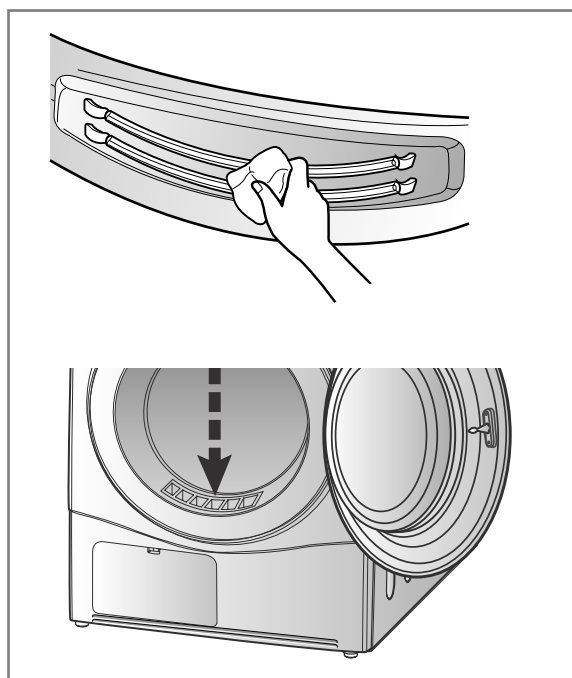

Additional Tips for Smart Use

Drying Guide & Energy consumption

| Course | | Ca. of Dryer | Display Drying Time (Including Cooling Time) | Energy Consumption |
|-----------------|-------------|--------------|---|--------------------|
| Cottons | Iron | 8kg | 97min | 3.55 kWh |
| | Light * | 8kg | 103min | 4.49 kWh |
| | Cupboard | 8kg | 115min | 4.52 kWh |
| Mixed Fabrics | Cupboard | 4kg | 48min | 1.70 kWh |
| Quick Dry | | 2kg | 50min | 1.41 kWh |
| Special Fabrics | Delicate | 1.5kg | 45min | 0.85 kWh |
| | Sports Wear | 1.5kg | 30min | 0.69 kWh |
| | Wool | 1kg | 21min | 0.45 kWh |
| | Bulkey Item | 2.5kg | 60min | 2.85 kWh |

* Tested in accordance with EN61121 : 2005 test program

- Energy consumption might not be the same as the value in the "Energy Consumption" table by spin rpm of the washing machine, installation condition and using condition.

Woolen Article

Dry woolens in "wool" cycle. Be sure to follow fabric care label "symbols", first. Wool is not completely dried from the program so don't repeat drying. Pull woolens to their original shape and dry them flat.

Woven and Loopknit Materials

Some woven and loopknit materials may shrink, depending on its quality.

Permanent Press and Synthetics

Do not overload your dryer.

Take out permanent press article as soon as the dryer stops to reduce wrinkles.

Baby Clothes and Night Gowns

Always check the manufacturer's instructions.

Rubber and Plastics

Do not dry any items made from or containing rubber or plastics such as:

- Aprons, Bibs and Chair Covers
- Curtains and Table Clothes
- Bathmats

Fiber Glass

Do not dry fiberglass articles in your dryer.















Glass particles left in the dryer could be picked up by your clothes the next time you use the dryer and irritate your skin.

Fabric Care Labels

Clothes have its own wash care labels so drying according to wash care labels is recommended. Not only that, the laundry must be sorted according to size and fabric type.

Do not overload in order to save you energy, time and best dry performance.

Below are fabric care labels.

| Symbols | Instructions |
|--|-------------------------------------|
|  | Dry |
|  | Tumble dry |
|  | Permanent Press / Wrinkle resistant |
|  | Gentle / Delicate |
|  | Do not tumble dry |
|  | Do not dry |
|  | High heating |
|  | Medium heating |
|  | Low heating |
|  | No heat / air |
|  | Line Dry / hang to dry |
|  | Drip dry |
|  | Dry flat |
|  | In the shade |

Additional Tips for Smart Use

● Spare Parts

Spare parts in your need are provided under the terms of warranty. Components covered by warranty is provided free of charge. If coverage is expired, spare parts must be purchased from service center.

● Disposal of the Dryer

It is desirable for you to dispose the dryer safely to keep your children away from the possible injury.

The door and lid and other protruded items must be taken away and power cord must be cut off to avoid future use. After that, the dryer is to be disposed safely.

● Service Contact

If there is something wrong with your dryer, first you must be through the troubleshooting table. In case that you can't find the same trouble and you can not handle by yourself, please contact the service centre.

A service person will ask you some questions like followings:

1. Your name, address and postcode.
2. Your phone number.
3. Description of trouble.
4. The model No. and the serial No. of your dryer.
5. The date of purchase.

● Accessory Parts

- Your dryer comes with accessories such as

1. Condensing Drain Hose

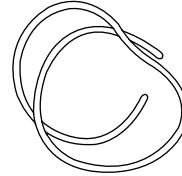

2. Hose Holder

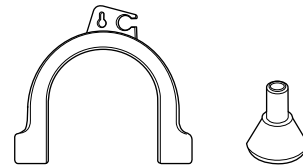

● Stacking Kit

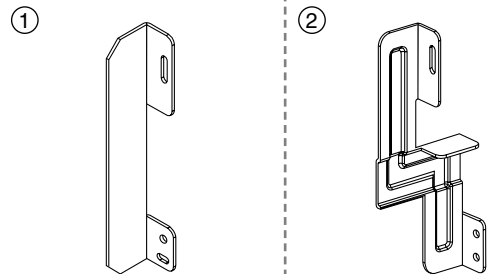

Holder : 2EA, Screw : 4EA

Holder : 2EA, Screw : 4EA

- Stacking kit Use condition
 - fig ① : Washer top plate size 550
 - fig ② : Washer top plate size 600

If stacking is needed, you must stack the dryer upon LG washing machine. In order to do this, stacking kit must be purchased separately.

Troubleshooting Guidelines

Troubleshooting Tips

To save you time and money, the following page will help answer your questions before service call.

| Questions | What to do |
|--|---|
| Dryer doesn't work | <ol style="list-style-type: none"> 1. Check dryer is plugged in. 2. Check "Start" button is pressed. 3. Check door is properly closed. 4. Check Room temperature is below 5°C. 5. Check a fuse is not blown or the circuit breaker is tripped and replace them. (Caution : electric dryers generally use two fuses or breakers) After emptying the water container and Cleaning filter during operation, you must press Start button, then the dryer operates again. |
| It takes a long time to dry | <ol style="list-style-type: none"> 1. Filter should be cleaned after each load. 2. Check water container is emptied. 3. Check cleanness of condenser. 4. Check to select correct program setting for fabric type. 5. Check air ventilation grille or rear vents of the dryer to be obstructed. 6. Check the clothes is "excessively wet". 7. Check correct program selected. 8. Check dryer is overloaded. |
| "Clean Filter" lamp flashes | <ol style="list-style-type: none"> 1. Check filter is cleaned. 2. Check condenser unit is clogged. |
| Clothes have lots of lints | <ol style="list-style-type: none"> 1. Check lint filter is empty. 2. Check dryer has only clean items. 3. Check laundry is properly sorted in the drum. 4. Check laundry is overloaded. 5. Check there is any paper, tissue, or similar item in the pockets of laundry. |
| The drying time is not consistent | The drying time for a load will vary depending on the heat setting, the size of the load, the type of fabrics, the wetness of the clothes and the condition of the lint filter. |
| Water is leaking | Check the door and sealing cover is dirty and damaged. |
| The clothes are wrinkled | Check the laundry is overloaded. Try a shorter drying time and remove items while they still retain a slight amount moisture. |
| The clothes shrank | To avoid shrinkage, please carefully follow the care and use instructions for your garment, because some fabrics will naturally shrink when washed. Other fabrics can be washed but will shrink when dried in a dryer. |

Troubleshooting Guidelines

● Error Mode

- dE : LED displays “ dE ” in case of the door open. The door must be closed and start Button must be pressed for re-operation.

- $tE1, tE2, tE3, tE4$: If display errors continues to occur, unplug the power cords and then call to the Service Center.

● Drum light does not work

- Connect customer service

T echnical Data

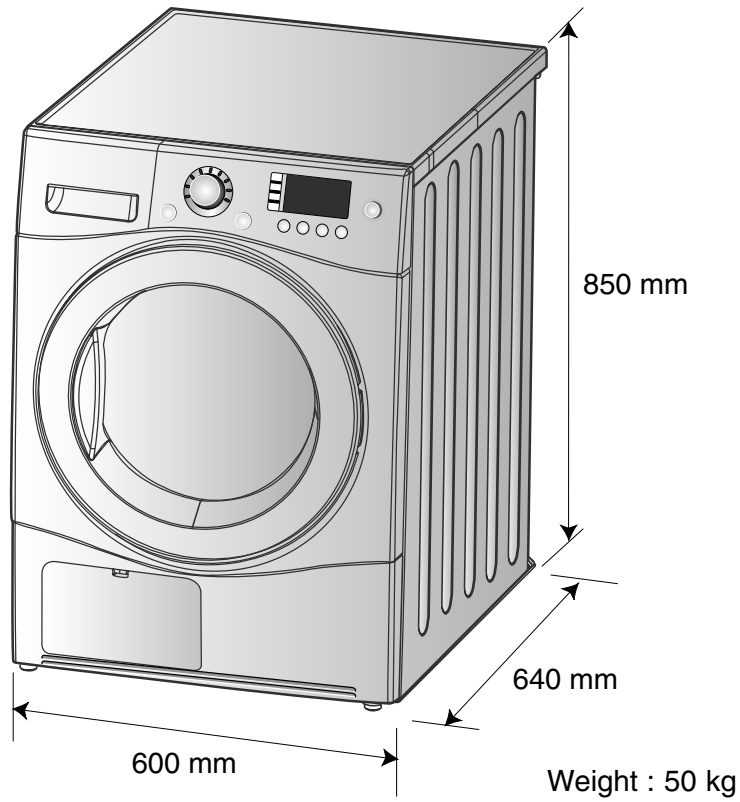

● Electrical Requirements

| Volts | Hertz | Watts |
|-------|-------|-------|
| 230 V | 50 Hz | 2600 |

You are sure to check the rating plate on the dryer to make sure the dryer has right rating.

Warranty

Disposal of your old appliance

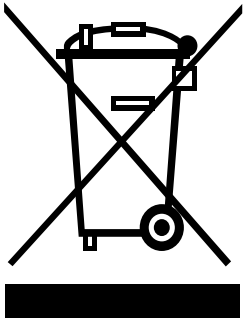

1. When this crossed-out wheeled bin symbol is attached to a product it means the product is covered by the European Directive 2002/96/EC.
2. All electrical and electronic products should be disposed of separately from the municipal waste stream via designated collection facilities appointed by the government or the local authorities.
3. The correct disposal of your old appliance will help prevent potential negative consequences for the environment and human health.
4. For more detailed information about disposal of your old appliance, please contact your city office, waste disposal service or the shop where you purchased the product.

■ What is not covered.

Service trips to your home to instruct you on the product.

If the product is connected to any voltage other than that shown on the rating plate.

If the fault is caused by accidents, neglects, misuses or Acts of God.

If the fault is caused by reasons except for normal domestic use or use in accordance with the owner's manual.

If the fault is caused by pests, for example, rats or cockroaches etc..

Noise or vibration that is considered normal, for example, water drain sound, spin sound or warning beeps.

Correcting the installation for example, leveling the product, adjustment of drain.

Normal maintenance recommended by the owner's manual.

Removal of foreign objects/substances from the machine including the pump and inlet hose filter, for example, grit, nails, bra wires and buttons etc..

Replace fuses in or correct wiring or correct house plumbing.

Correction of unauthorized repairs.

Incidental or consequential damage to personal property caused by possible defects with this appliance.

If this product is used for commercial purposes, it is not warranted.

(Example: Public places such as public bathroom, lodging house, training center, dormitory)

If the product is installed outside the normal service area, any cost of transportation involved in the repair of the products, or the replacement of a defective part, shall be borne by the owner.

