



**LG**  
Life's Good

# LCD TV OWNER'S MANUAL

## LCD TV MODELS

19LH2***	37LH5***
22LH2***	42LH5***
26LH2***	47LH5***
32LH2***	55LH5***
37LH2***	32LH6***
42LH2***	42LH6***
32LF2***	32LH7***
42LF2***	37LH7***
32LH3***	42LH7***
37LH3***	47LH7***
42LH3***	42LH9***
47LH3***	47LH9***
19LU5***	
22LU5***	
26LU5***	

Please read this manual carefully before operating your TV.

Retain it for future reference.

Record the model number and serial number of the TV.

Refer to the label on the back cover and quote this information.

To your dealer when requiring any service.

(Only 26/32/37/42LH2\*\*\*, 32/42LF2\*\*\*,  
26LU5\*\*\*, 32/37/42LH3\*\*\*, 37/42LH5\*\*\*,  
32/37LH7\*\*\*)



1-screw for stand fixing  
(Refer to p.15)

**Wall Mounting Bracket (Separate purchase)**

**RW120**

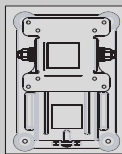

(19/22LH2\*\*\*,  
19/22LU5\*\*\*)

**RW230**

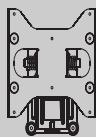

(26/32LH2\*\*\*, 26LU5\*\*\*,  
32LH3\*\*\*, 32LH7\*\*\*)

**AW-47LG30M**

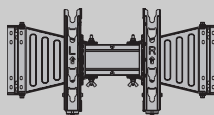

(32/37/42LH2\*\*\*, 32/42LF2\*\*\*,  
32/37/42/47LH3\*\*\*,  
37/42/47LH5\*\*\*,  
32/37/42/47LH7\*\*\*)

**AW-55LH40M**

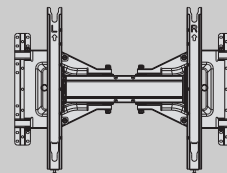

(55LH5\*\*\*)

**Use screws 12mm(+0.5/-0.5) long on the SET assembly side. (Separate purchase)**  
(Only 42/47LH7\*\*\*)

Set assembly side  
(with guide spacer)

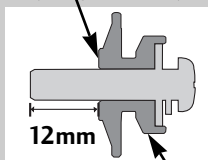

Guide spacer

Set assembly side  
(without guide spacer)

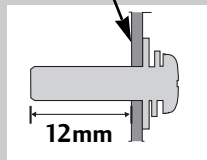

# ACCESSORIES

Ensure that the following accessories are included with your TV.

If an accessory is missing, please contact the dealer where you purchased the TV.

■ Here shown may be somewhat different from your TV.

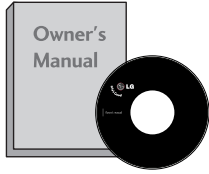

Owner's Manual

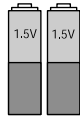

Batteries



Power Cord

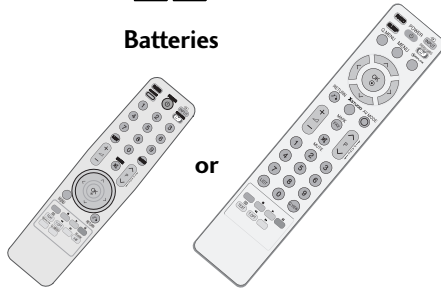

Remote Control

This item is not included for all models.

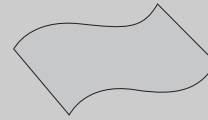

Polishing Cloth

Polishing cloth for use on the screen.

\* Lightly wipe any stains or fingerprints on the surface of the TV with the polishing cloth.

Do not use excessive force. This may cause scratching or discolouration.

## Only 32/37/42/47LH7\*\*\*



Cable management clip  
(Refer to p.17)



Protection cover  
(Refer to p.14)

(Only 37/42/47LH7\*\*\*)

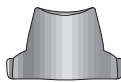

Stand rear cover  
(Refer to p.15)

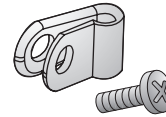

Protective Bracket and Bolt for Power Cord  
(Refer to P.18)

(32LH7\*\*\* only)



x 7

M4x20

(37LH7\*\*\* only)



x 8

M4x20

(42LH7\*\*\* only)



x 3

M4x20



x 4

M4x16

(47LH7\*\*\* only)



x 8

M4x16

bolts for stand assembly (Refer to p. 13)



USB extension cable

Make sure to use the provided USB extension cable, Which is specially designed for a slim fit.

## Only 19/22/26LU5\*\*\*

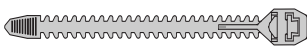

Cable Holder  
(Refer to p.16)



x 2

(Only 19/22LU5\*\*\*)



x 3

(Only 26LU5\*\*\*)

Bolts for stand assembly  
(Refer to p.12)

## Only 19/22LH2\*\*\*



Cable management clip  
(Refer to p.16)

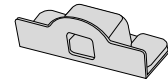

Protection cover  
(Refer to p.14)

## Only 26/32/37/42LH2\*\*\*, 32/37/42/47LH3\*\*\*, 37/42/47/55LH5\*\*\*

(Except 55LH5\*\*\*)



x 4

Bolts for stand assembly  
(Refer to p.13)



Protection cover  
(Refer to p.14)

## Only 32/42LF2\*\*\*



x 4



x 4

Bolts for stand assembly  
(Refer to p.12)

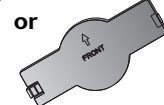
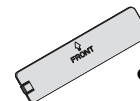

Protection Cover  
(Refer to p.14)

# CONTENTS

## ACCESSORIES ..... 1

### PREPARATION

Front Panel Controls.....	4
Back Panel Information .....	8
Stand Installation.....	12
Not Using the desk-type stand.....	14
Swivel Stand .....	14
Attaching the TV to a desk.....	15
To Use The Stand Rear Cover.....	15
Positioning your display .....	15
Back Cover for Wire Arrangement .....	16
Detaching Stand .....	17
Careful Installation Advice.....	18
How to Secure the Power Cable.....	18
Desktop Pedestal Installation .....	18
Wall Mount: Horizontal Installation .....	19
Kensington Security System.....	20
Antenna Connection .....	21

### EXTERNAL EQUIPMENT SETUP

HD Receiver Setup.....	22
DVD Setup.....	24
VCR Setup.....	26
Other A/V Source Setup .....	28
External Stereo Setup .....	29
AV Output Setup .....	29
Usb in Setup.....	30
PC Setup.....	31
- Screen Setup for PC Mode .....	34

### WATCHING TV / PROGRAMME CONTROL

Remote Control Key Functions .....	38
Turning on the TV .....	42
Programme Selection .....	42
Volume Adjustment .....	42
Quick Menu .....	43
On-Screen Menus Selection and Adjustment.....	44
Auto Programme Tuning.....	45

Manual Programme Tuning .....	46
Programme Edit .....	48
Selecting the Programme List.....	50
Favourite Programme Setup.....	51
Input List.....	52
Input Label.....	53
 .....	54
Key Lock.....	57
Initializing(Reset to original factory settings) .....	58
AV Mode .....	59

### TO USE THE BLUETOOTH

Precautions when using the Bluetooth .....	60
Setting the Bluetooth.....	61
Set TV PIN.....	62
Bluetooth headset	
- Connecting a new Bluetooth headset .....	63
- Connecting to Bluetooth headset already registered.....	63
- Disconnecting the Bluetooth headset during use...64	
- When requesting to connect to TV from the Bluetooth headset.....	64
Managing Registered Bluetooth device .....	65
My Bluetooth Information .....	66
Receiving photos from external Bluetooth device .....	67
Listening to the musics from external Bluetooth device67	

### TO USE A USB DEVICE

When connecting the USB device.....	68
Photo List .....	69
Music List.....	73
Movie List.....	76
Divx Registration Code.....	79
Deactivation.....	80

**PICTURE CONTROL**

Picture Size (Aspect Ratio) Control.....	81
Ⓛ Energy Saving.....	83
Preset Picture Settings	
- Picture Mode-Preset.....	84
Manual Picture Adjustment	
- Picture Mode-User option.....	85
Picture Improvement Technology.....	86
Expert Picture Control.....	87
Picture Reset.....	90
Power Indicator.....	91
Demo Mode.....	92
Mode Setting.....	93

**SOUND & LANGUAGE CONTROL**

Auto Volume Leveler.....	94
Preset Sound Settings - Sound Mode.....	95
Sound Setting Adjustment - User Mode.....	96
SRS TruSurround XT.....	96
Clear Voice II.....	97
Balance.....	98
TV Speakers On/ Off Setup.....	99
Selecting Audio Out.....	100
Audio Reset.....	101
I/II	
- Stereo/Dual Reception.....	102
- NICAM Reception.....	103
- Speaker Sound Output Selection.....	103
On-Screen Menu Language Selection.....	104

**TIME SETTING**

Clock Setup.....	105
Auto On/ Off Timer Setting.....	106
Sleep Timer Setting.....	106

**TELETEXT**

Switch on/off.....	107
SIMPLE Text.....	107
TOP Text.....	107
FASTEXT.....	108
Special Teletext Functions.....	108

**APPENDIX**

Troubleshooting.....	109
Maintenance.....	111
Product Specifications.....	112
IR Codes.....	115
External Control Device Setup.....	117

# PREPARATION

## FRONT PANEL CONTROLS

■ Here shown may be somewhat different from your TV.

### ⚠ CAUTION

- ▶ When the TV cannot be turned on with the remote control, press the main power button on the TV. (When the power is turned off with the main power button on the TV, it will not be turned on with the remote control.)

Only 19/22/26/32/37/42LH2\*\*\*, 32/37/42/47LH3\*\*\*

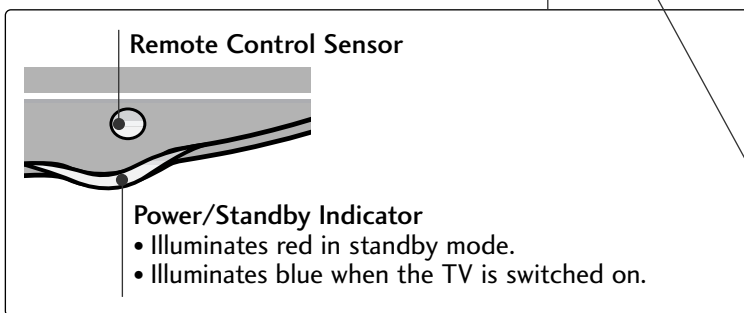
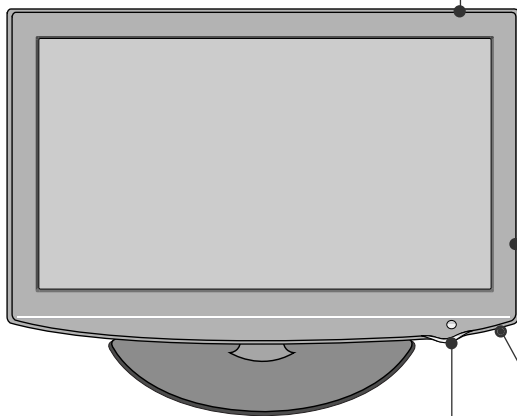
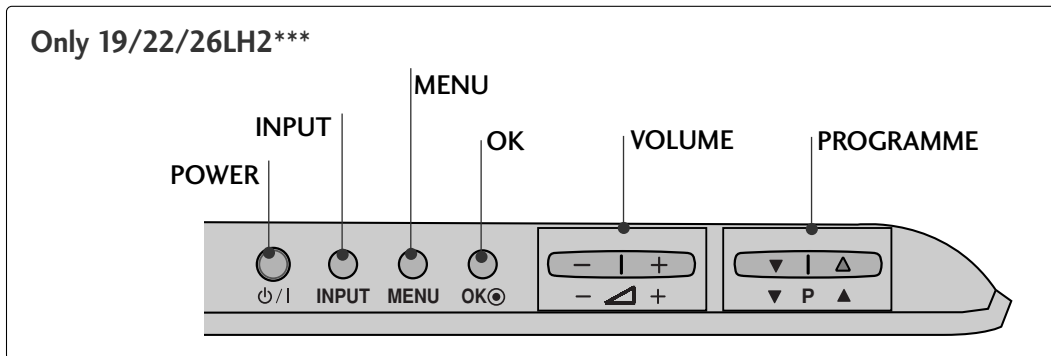

Only 32/37/42LH2\*\*\*,  
32/37/42/47LH3\*\*\*

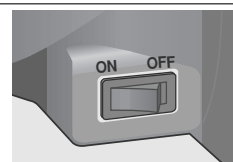
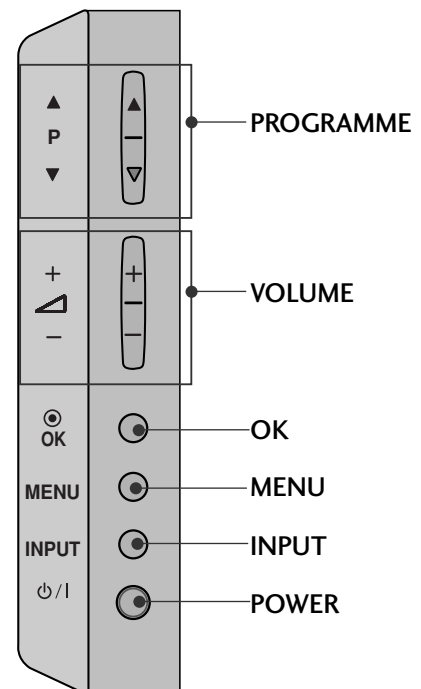

Main Power Switch

Except 19/22LH2\*\*\*

■ Here shown may be somewhat different from your TV.

### Only 19/22/26LU5\*\*\*

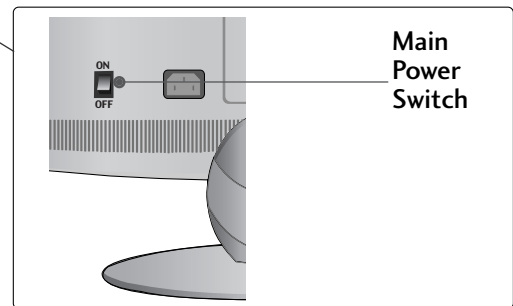
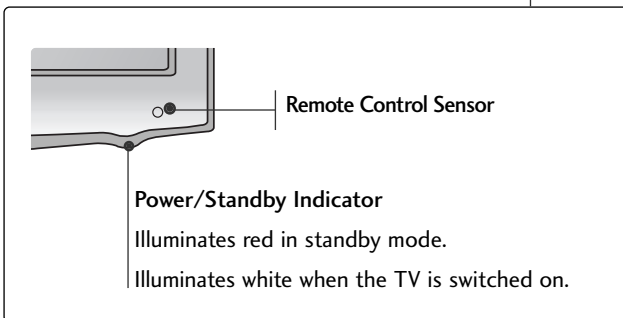
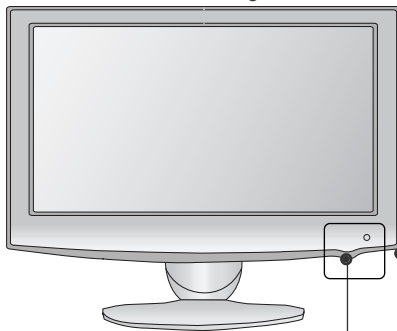
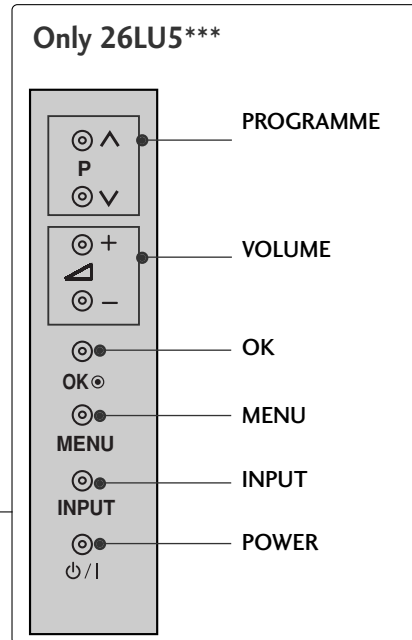
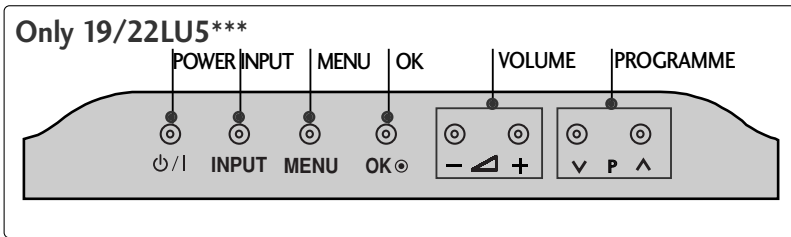

### Only 32/42LF2\*\*\*

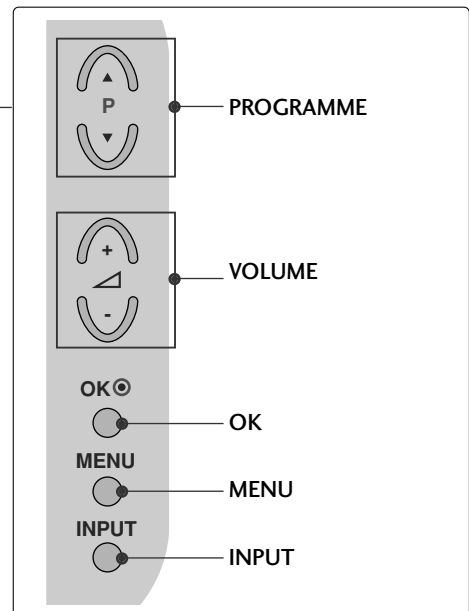
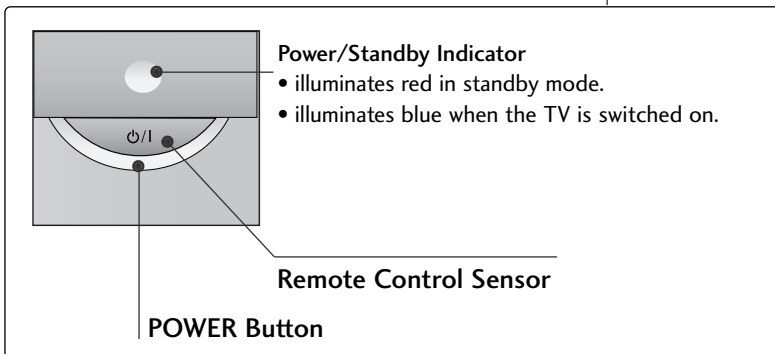
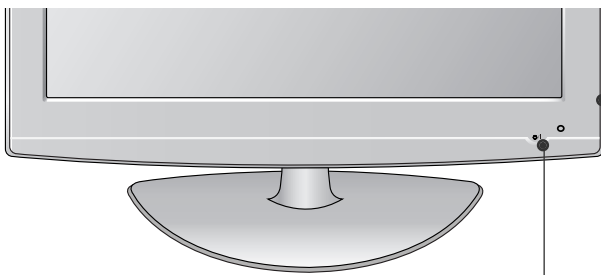

# PREPARATION

## FRONT PANEL CONTROLS

■ Here shown may be somewhat different from your TV.

Only 37/42/47/55LH5\*\*\*, 32/42LH6\*\*\*

PREPARATION

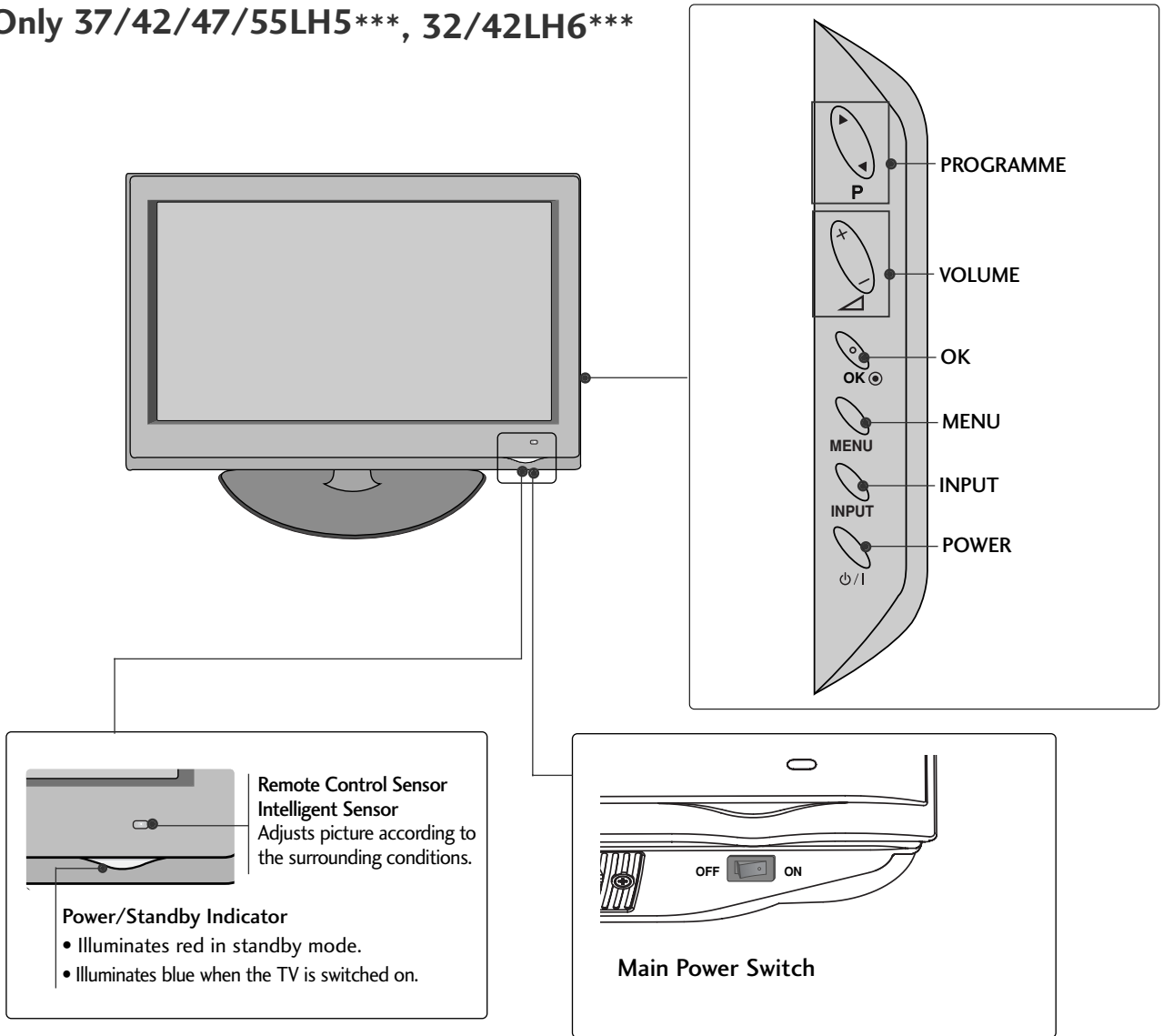



■ Here shown may be somewhat different from your TV.

Only 32/37/42/47LH7\*\*\*

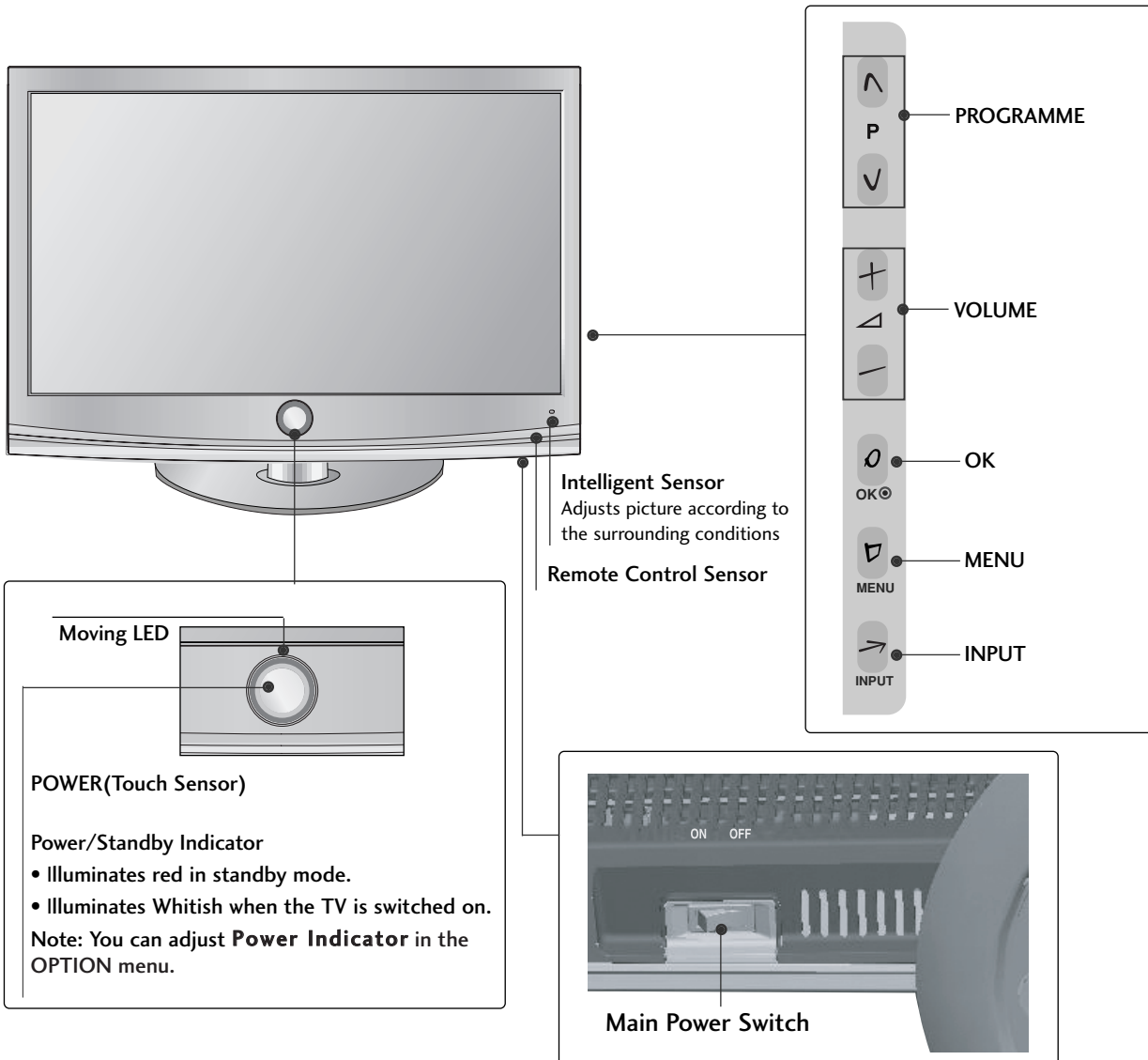

# PREPARATION

## BACK PANEL INFORMATION

■ Here shown may be somewhat different from your TV.

**Only 19/22/26/32/37/42LH2\*\*\*, 32/42LF2\*\*\*, 32/37/42/47LH3\*\*\*, 19/22/26LU5\*\*\* (Refer to p.9)**

PREPARATION

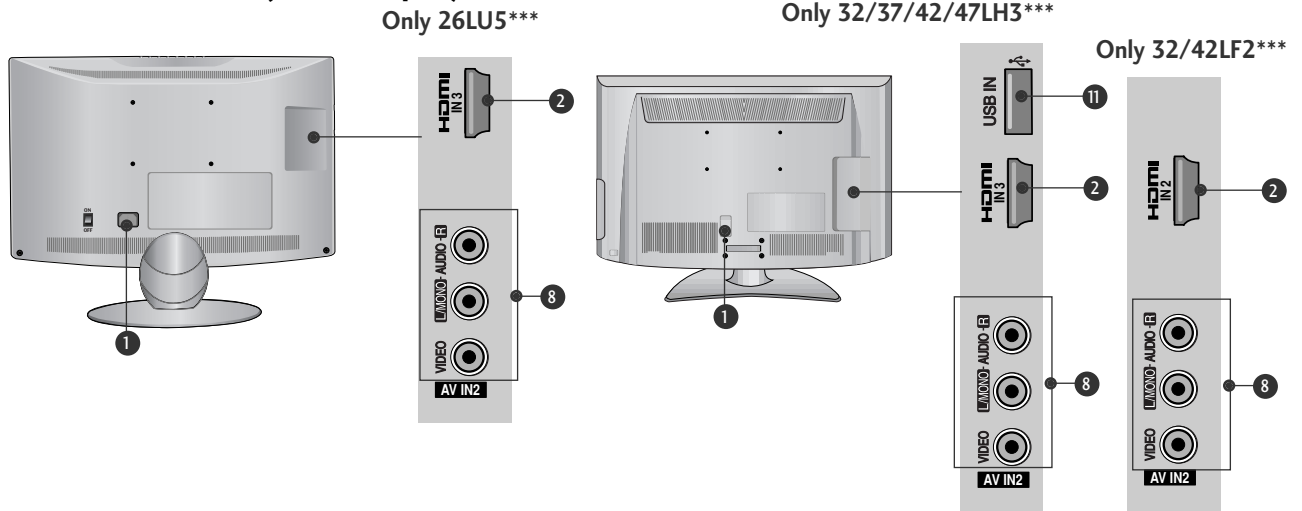

**Only 19/22LH2\*\*\***

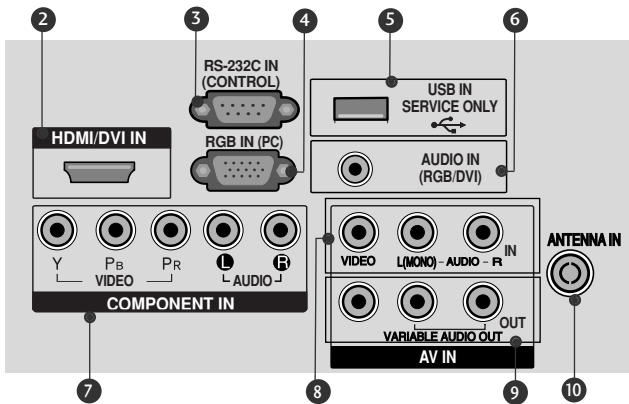

**Only 32/37/42/47LH3\*\*\***

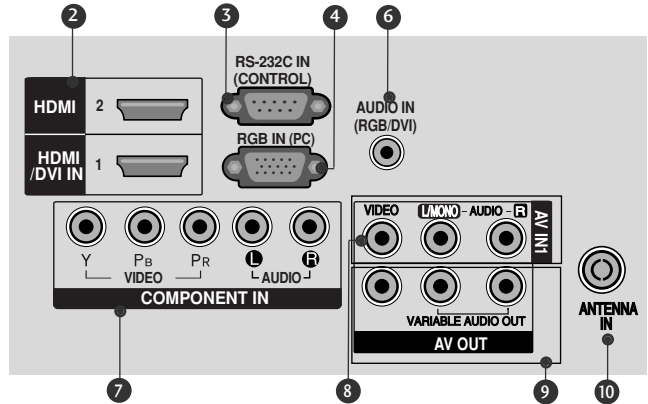

**Only 26/32/37/42LH2\*\*\*, 19/22/26LU5\*\*\***

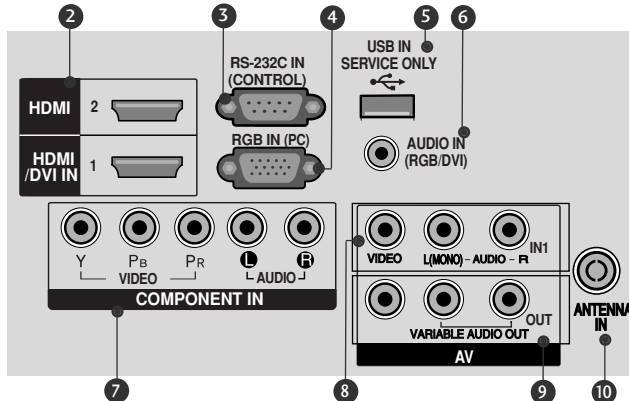

**Only 32/42LF2\*\*\***

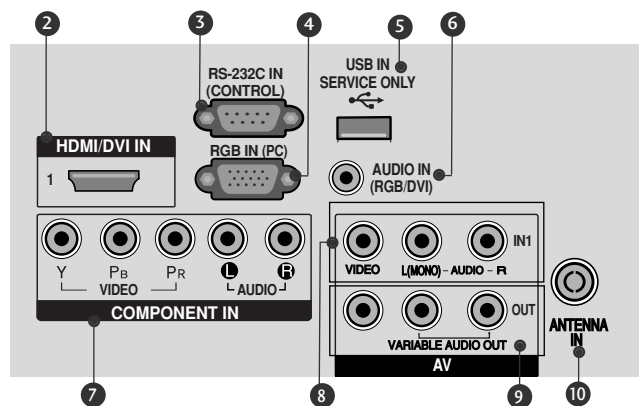

■ Here shown may be somewhat different from your TV.

**Only 37/42/47/55LH5\*\*\***

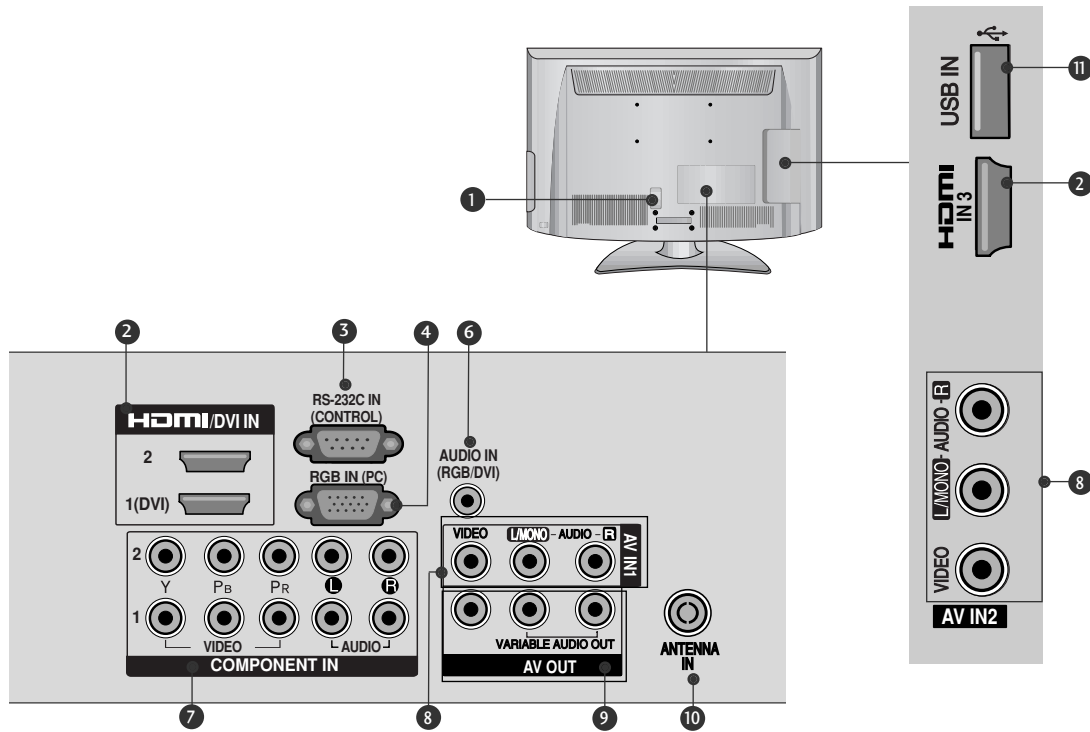

- 1 Power Cord Socket**  
This TV operates on an AC power. The voltage is indicated on the Specifications page. Never attempt to operate the TV on DC power.
- 2 HDMI Input**  
Connect a HDMI signal to HDMI IN.  
Or DVI (VIDEO) signal to HDMI/DVI port with DVI to HDMI cable.
- 3 RS-232C IN PORT**  
Connect to the RS-232C port on a PC.  
This port is used for Service or Hotel mode.
- 4 RGB IN Input**  
Connect the output from a PC.
- 5 SERVICE ONLY PORT**
- 6 RGB/DVI Audio Input**  
Connect the audio from a PC.
- 7 Component Input**  
Connect a component video/audio device to these jacks.
- 8 Audio/Video Input**  
Connect audio/video output from an external device to these jacks.
- 9 AV Output**  
Connect second TV or monitor to the AV OUT socket on the TV.  
**Variable Audio Output**  
Connect an external amplifier or add a subwoofer to your surround sound system.
- 10 Antenna Input**  
Connect RF antenna to this jack.
- 11 USB IN Input**  
Connect USB storage device to this jack.

# PREPARATION

## BACK PANEL INFORMATION

■ Here shown may be somewhat different from your TV.

Only 32/42LH6\*\*\*

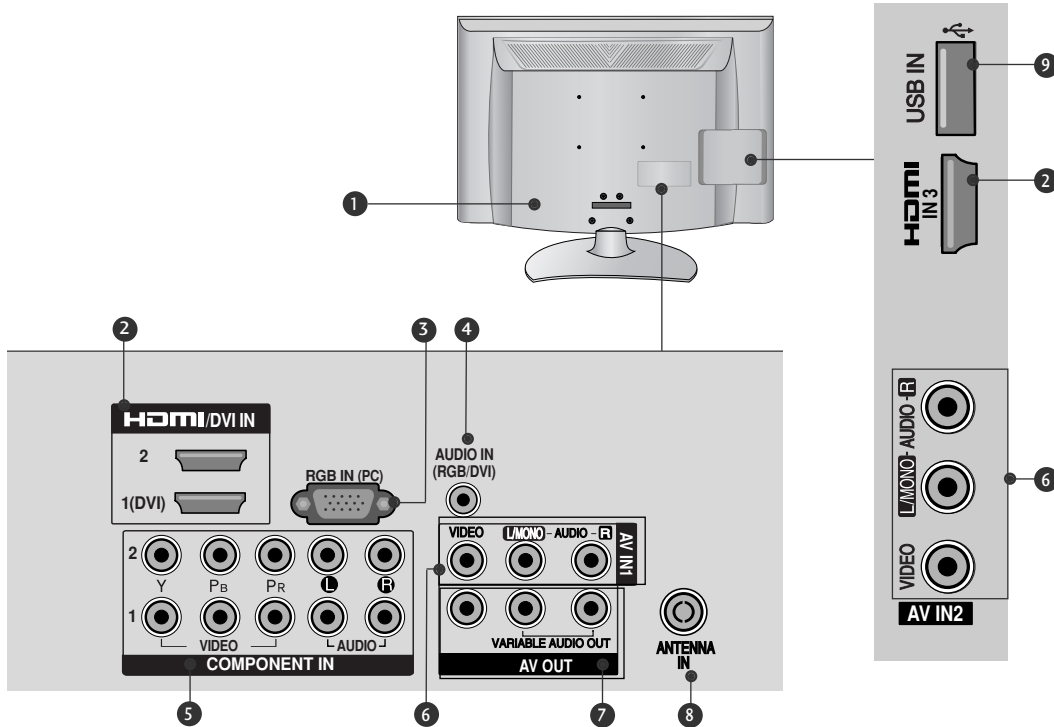

### 1 Power Cord Socket

This TV operates on an AC power. The voltage is indicated on the Specifications page. Never attempt to operate the TV on DC power.

### 2 HDMI Input

Connect a HDMI signal to HDMI IN. Or DVI(VIDEO)signal to HDMI/DVI port with DVI to HDMI cable.

### 3 RGB IN Input

Connect the output from a PC.

### 4 RGB/DVI Audio Input

Connect the audio from a PC.

### 5 Component Input

Connect a component video/audio device to these jacks.

### 6 Audio/Video Input

Connect audio/video output from an external device to these jacks.

### 7 AV Output

Connect second TV or monitor to the AV OUT socket on the TV.

#### Variable Audio Output

Connect an external amplifier or add a subwoofer to your surround sound system.

### 8 Antenna Input

Connect RF antenna to this jack.

### 9 USB IN Input

Connect USB storage device to this jack.

■ Here shown may be somewhat different from your TV.

**Only 32/37/42/47LH7\*\*\***

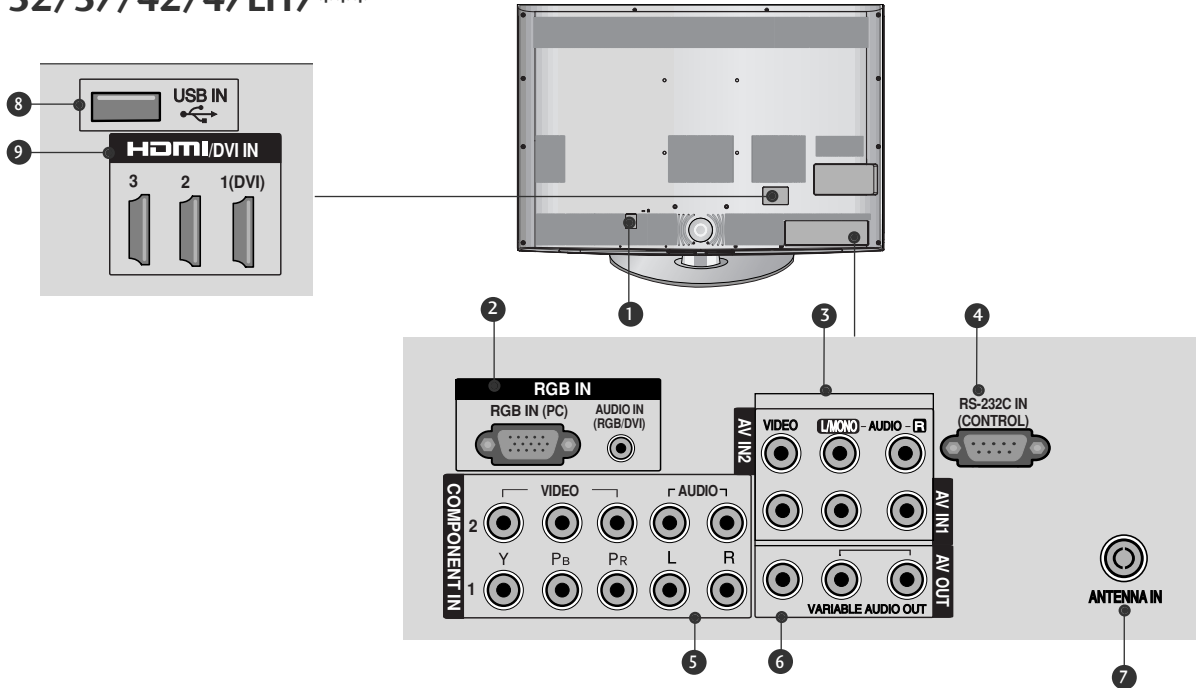

**1 Power Cord Socket**

This TV operates on an AC power. The voltage is indicated on the Specifications page. Never attempt to operate the TV on DC power.

**2 RGB IN Input**

Connect the output from a PC.  
**RGB/DVI Audio Input**  
 Connect the audio from a PC.

**3 Audio/Video Input**

Connect audio/video output from an external device to these jacks.

**4 RS-232C IN PORT**

Connect to the RS-232C port on a PC.  
 This port is used for Service or Hotel mode.

**5 Component Input**

Connect a component video/audio device to these jacks.

**6 AV Output**

Connect second TV or monitor to the AV OUT socket on the TV.

**Variable Audio Output**

Connect an external amplifier or add a subwoofer to your surround sound system.

**7 Antenna Input**

Connect RF antenna to this jack.

**8 USB IN Input**

Connect USB storage device to this jack.

**9 HDMI Input**

Connect a HDMI signal to HDMI IN.

Or DVI(VIDEO)signal to HDMI/DVI port with DVI to HDMI cable.

# PREPARATION

## STAND INSTALLATION

■ Here shown may be somewhat different from your TV.

When assembling the desk type stand, check whether the bolt is fully tightened. (If not tightened fully, the product can tilt forward after the product installation.) If you tighten the bolt with excessive force, the bolt can deviate from abrasion of the tightening part of the bolt.

### Only 19/22LH2\*\*\*

- 1 Carefully place the TV screen side down on a cushioned surface to protect the screen from damage.

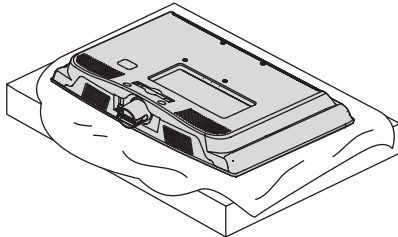

- 2 Assemble the TV as shown.

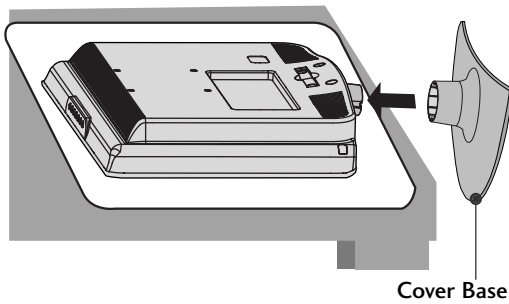

### Only 19/22/26LU5\*\*\*

- 1 Carefully place the TV screen side down on a cushioned surface to protect the screen from damage.

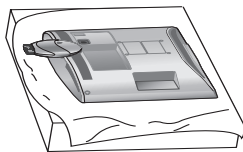

- 2 Fix the 2 or 3 bolts securely using the holes as shown.

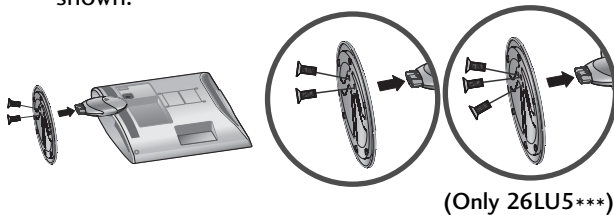

### Only 32/42LF2\*\*\*

- 1 Carefully place the TV screen side down on a cushioned surface to protect the screen from damage.

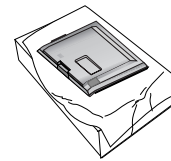

- 2 Assemble the parts of the **Stand Body** with the **Stand Base** of the TV.

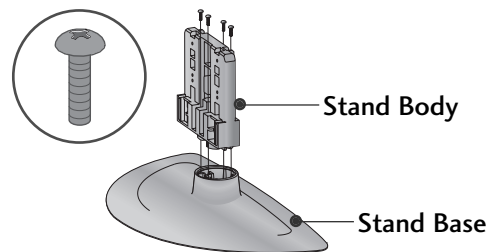

- 3 Assemble the TV as shown.

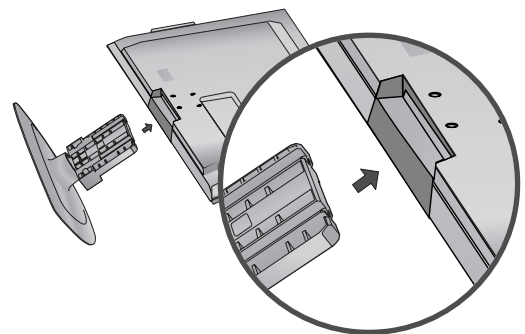

- 4 Fix the 4 bolts securely using the holes in the back of the TV.

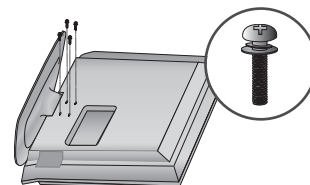

**Only 26/32/37/42LH2\*\*\*,  
32/37/42/47LH3\*\*\*,  
37/42/47LH5\*\*\***

- 1 Carefully place the TV screen side down on a cushioned surface to protect the screen from damage.

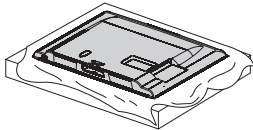

- 2 Assemble the TV as shown.

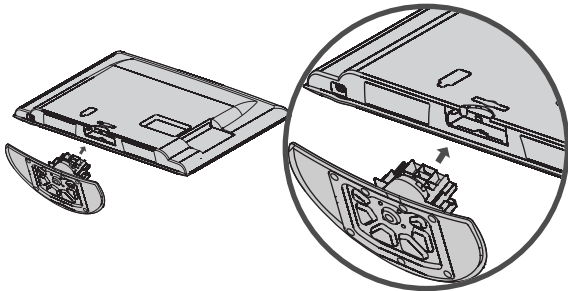

- 3 Fix the 4 bolts securely using the holes in the back of the TV.

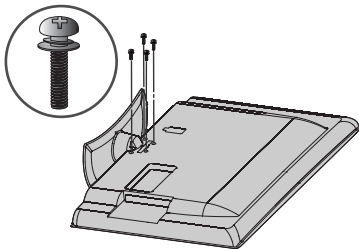

**Only 32/37/42/47LH7\*\*\***

- 1 Carefully place the TV screen side down on a cushioned surface to protect the screen from damage.

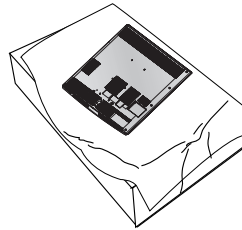

- 2 Assemble the parts of the **Stand Body** with the **Stand Base** of the TV.

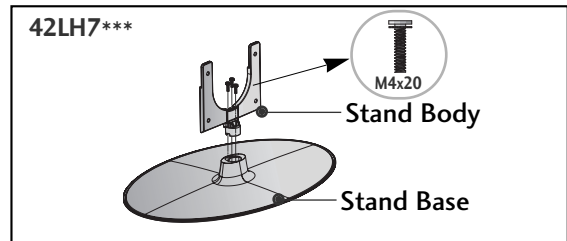
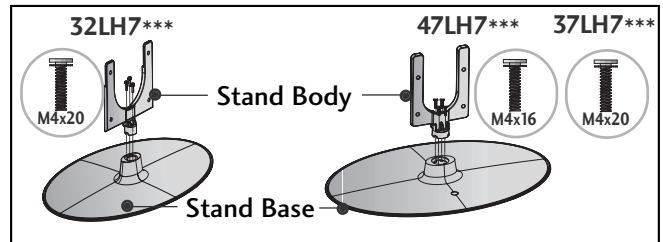

- 3 Assemble the TV as shown.

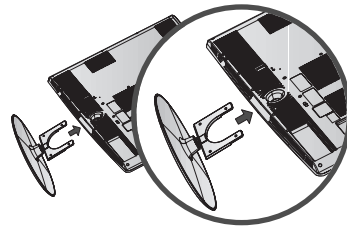

- 4 Fix the 4 bolts securely using the holes in the back of the TV.

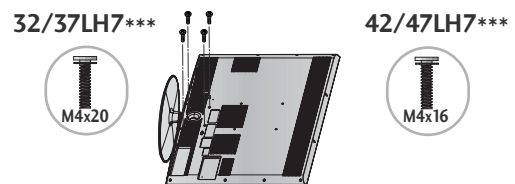

# PREPARATION

## NOT USING THE DESK-TYPE STAND

■ Here shown may be somewhat different from your TV. When installing the wall-mounted unit, use the protection cover.

Only 19/22LH2\*\*\*

- 1 Carefully place the TV screen side down on a cushioned surface to protect the screen from damage.

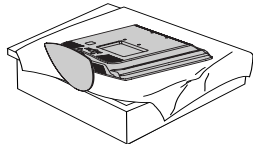

- 2 Loosen the bolts from TV.

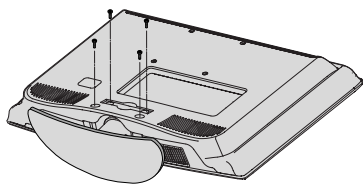

- 3 Detach the Stand Body from TV.

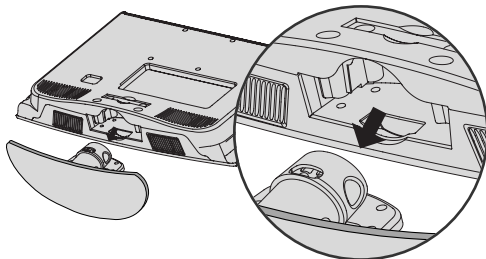

- 4 Insert the Protection Cover into the TV.

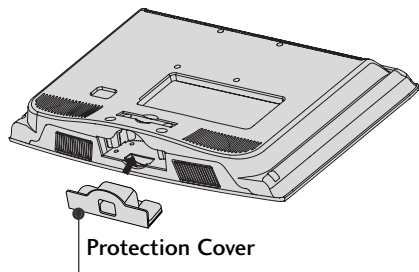

- 5 Fix the 4 bolts securely using the holes in the back of the TV.

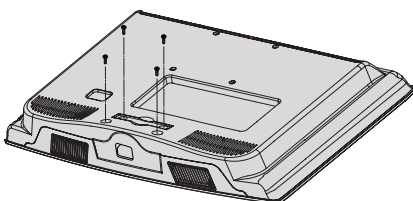

Only 32/42LF2\*\*\*

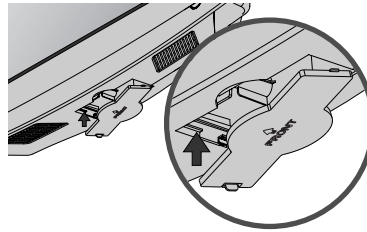

Insert the **PROTECTION COVER** into the TV until clicking sound.

Only 26/32/37/42LH2\*\*\*,  
32/37/42/47LH3\*\*\*,  
37/42/47/55LH5\*\*\*

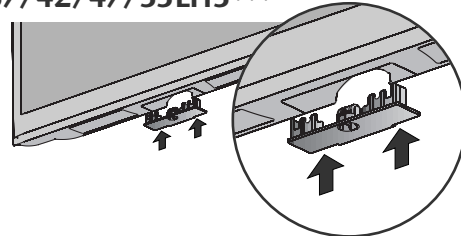

Insert the **PROTECTION COVER** into the TV until clicking sound.

Only 32/37/42/47LH7\*\*\*

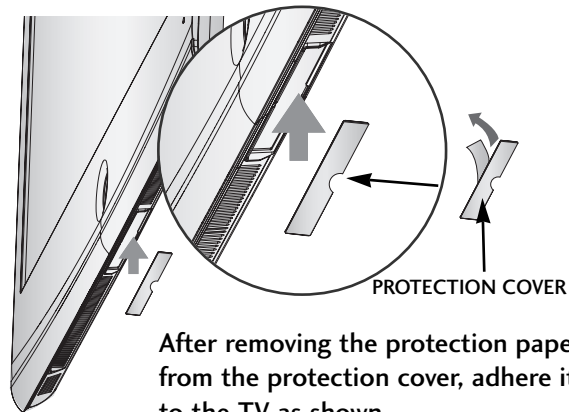

## SWIVEL STAND

(Except 19/22/26LU5\*\*\*, 19/22LH2\*\*\*)

- This feature is not available for all models.
- After installing the TV, you can adjust the TV manually to the left or right direction by 20 degrees to suit your viewing position.

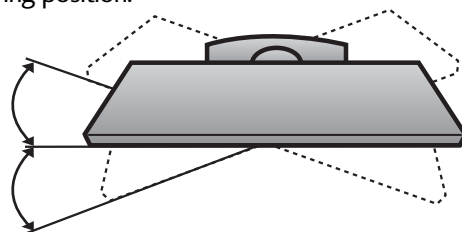



## ATTACHING THE TV TO A DESK

■ Here shown may be somewhat different from your TV. The TV must be attached to desk so it cannot be pulled in a forward/backward direction, potentially causing injury or damaging the product. Use only an attached screw.

Only 26/32/37/42LH2\*\*\*, 32/42LF2\*\*\*, 32/37/42LH3\*\*\*, 26LU5\*\*\*, 37/42LH5\*\*\*, 32/37LH7\*\*\*

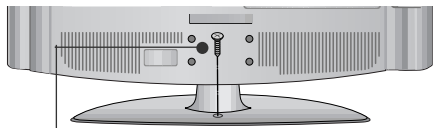

1-Screw (provided as parts of the product)

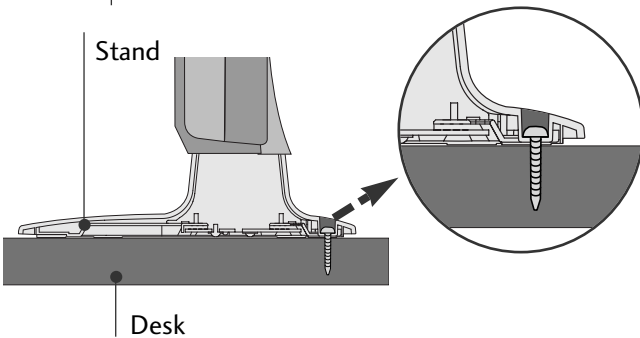

### ! WARNING

► To prevent TV from falling over, the TV should be securely attached to the floor/wall per installation instructions. Tipping, shaking, or rocking the machine may cause injury.

## TO USE THE STAND REAR COVER (37/42/47LH7\*\*\* only)

■ Here shown may be somewhat different from your TV. Install the **STAND REAR COVER** as shown.

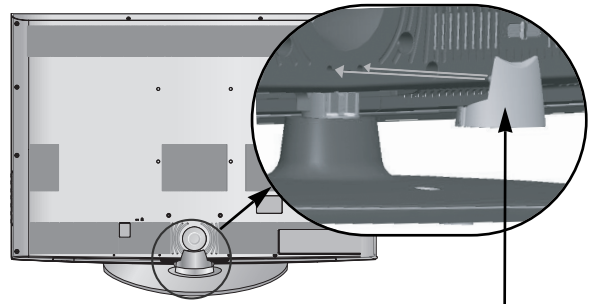

STAND REAR COVER

Grip the knob in your fingers and pull it.

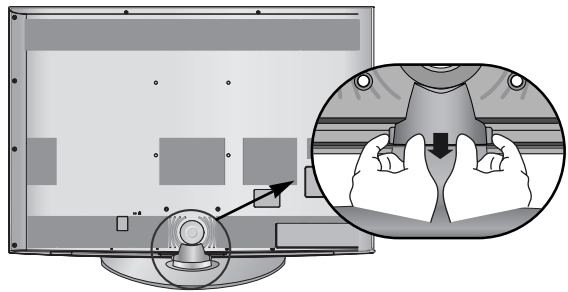

## POSITIONING YOUR DISPLAY

(Only 19/22LH2\*\*\*)

■ Here shown may be somewhat different from your TV.  
 ■ Adjust the position of the panel in various ways for maximum comfort.

• Tilt range

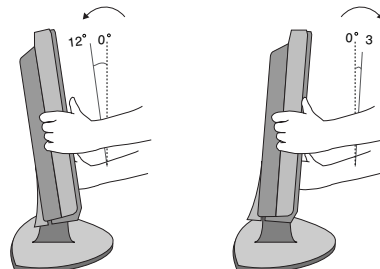

# PREPARATION

## BACK COVER FOR WIRE ARRANGEMENT

■ Here shown may be somewhat different from your TV.

### Only 19/22LH2\*\*\*

- 1 Connect the cables as necessary.  
To connect additional equipment, see the **EXTERNAL EQUIPMENT SETUP** section.

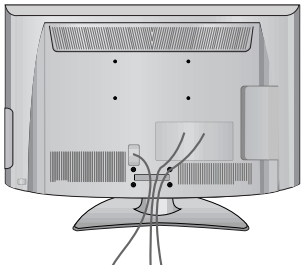

- 2 Install the **CABLE MANAGEMENT CLIP** as shown.

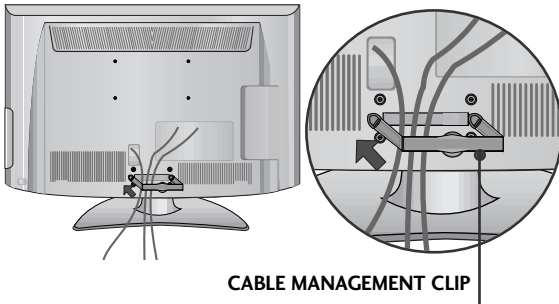

- 3 Fit the **CABLE MANAGEMENT CLIP** as shown.

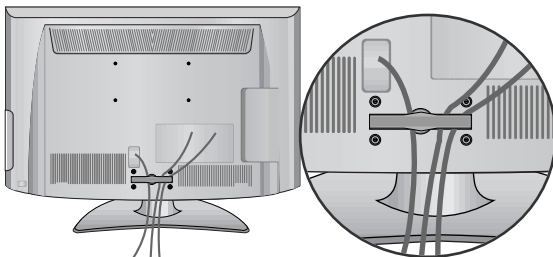

### How to remove the **CABLE MANAGEMENT CLIP**(Only 19/22LH2\*\*\*)

- ▶ Hold the **CABLE MANAGEMENT CLIP** with both hands and pull it backward.

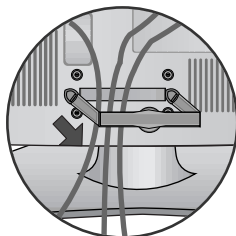

### Only 19/22/26/32/37/42LH2\*\*\*, 32/42LF2\*\*\*, 32/37/42/47LH3\*\*\*, 37/42/47/55LH5\*\*\*

- 1 Connect the cables as necessary.  
To connect additional equipment, see the **External Equipment Setup** section of the manual.

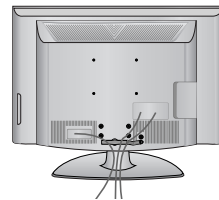

- 2 Open the **CABLE MANAGEMENT CLIP** as shown and manage the cables.

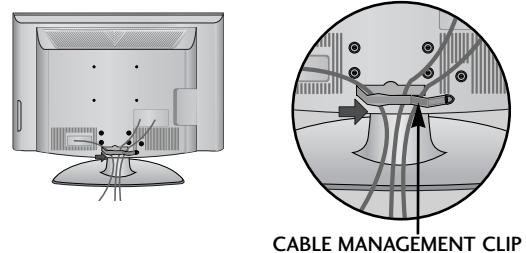

- 3 Fit the **CABLE MANAGEMENT CLIP** as shown.

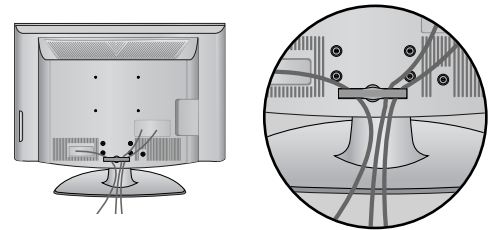

### Only 19/22/26LU5\*\*\*

After Connecting the cables as necessary, install **CABLE HOLDER** as shown and bundle the cables.

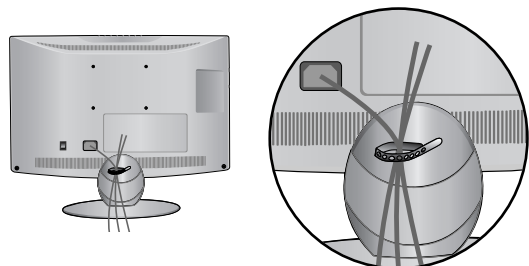

### Only 32/37/42/47LH7\*\*\*

- Align the hole with the tab on the **CABLE MANAGEMENT CLIP**.

Turn the **CABLE MANAGEMENT CLIP** as shown.

Note : that excessive force might cause damage to the product when using Cable Management clip.

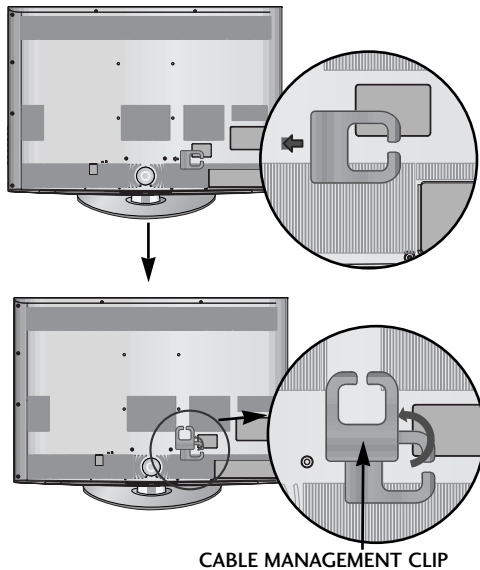

- Connect the cables as necessary.

To connect additional equipment, see the **External equipment Setup** section.

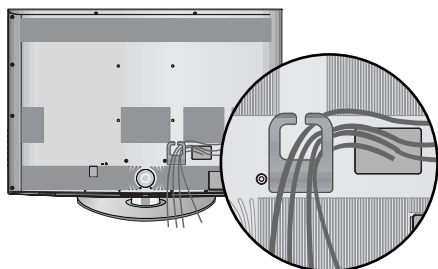

#### NOTE

- Do not hold the **CABLE MANAGEMENT CLIP** when moving the TV.
- If the TV is dropped, you may be injured or the TV may be damaged.

## DETACHING STAND

▪ Here shown may be somewhat different from your TV.

### Only 19/22/26LU5\*\*\*

- Carefully place the TV screen side down on a cushioned surface to protect the screen from damage.

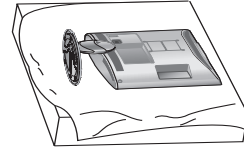

- Loose the bolts and then detach the stand from TV.

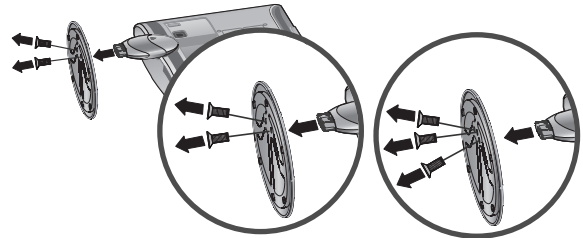

(Only 26LU5\*\*\*)

- Loose the bolts and then detach the **Cover Base** from TV.

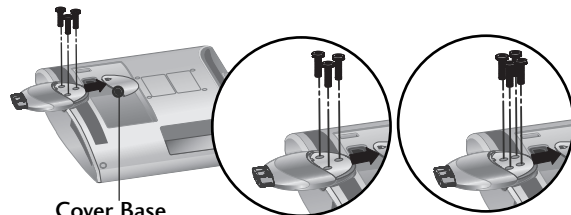

(Only 26LU5\*\*\*)

- Detach the **Stand Body** from TV.

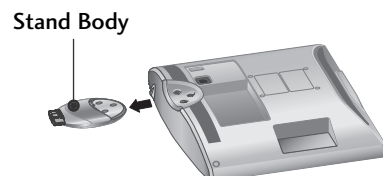

# PREPARATION

## CAREFUL INSTALLATION ADVICE

- You should purchase necessary components to fix the TV safely and secure to the wall on the market.
- Position the TV close to the wall to avoid the possibility of it falling forwards when pushed.
- The instructions shown below are a safer way to set up the TV, by fixing it to the wall, avoiding the possibility of it falling forwards if pulled. This will prevent the TV from falling forward and causing injury. This will also prevent the TV from damage. Ensure that children do not climb or hang from the TV.

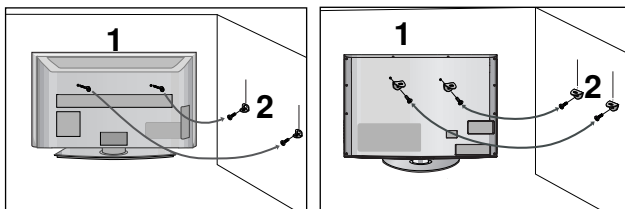

- 1 Use the eye-bolts or TV brackets/bolts to fix the product to the wall as shown in the picture. (If your TV has bolts in the eyebolts, loosen then bolts.)  
\* Insert the eye-bolts or TV brackets/bolts and tighten them securely in the upper holes.

- 2 Secure the wall brackets with the bolts on the wall. Match the height of the bracket that is mounted on the wall.

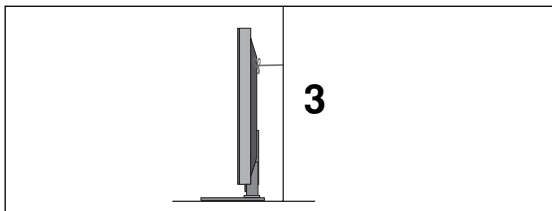

- 3 Use a sturdy rope to tie the product for alignment. It is safer to tie the rope so it becomes horizontal between the wall and the product.

### ! NOTE

- ▶ When moving the TV undo the cords first.
- ▶ Use a platform or cabinet strong and large enough to support the size and weight of the TV.
- ▶ To use the TV safely make sure that the height of the bracket on the wall and on the TV is the same.

## How to secure the power cable

(Only 32/37/42/47LH7\*\*\*)

Secure the power cable with the **PROTECTIVE BRACKET** and the bolt as shown. It will help prevent the power cable from being removed by accident.

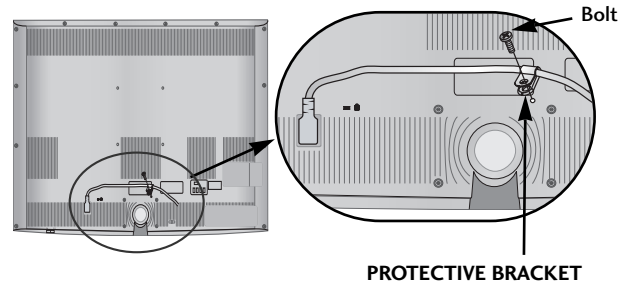

- The TV can be installed in various ways such as on a wall, or on a desktop etc.
- The TV is designed to be mounted horizontally.

## EARTHING

Ensure that you connect the earth wire to prevent possible electric shock. If grounding methods are not possible, have a qualified electrician install a separate circuit breaker.

Do not try to earth the TV by connecting it to telephone wires, lightning rods or gas pipes.

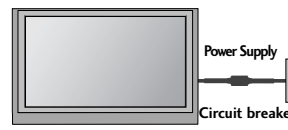

## DESKTOP PEDESTAL INSTALLATION

For adequate ventilation allow a clearance of 4" (10cm) all around the TV.

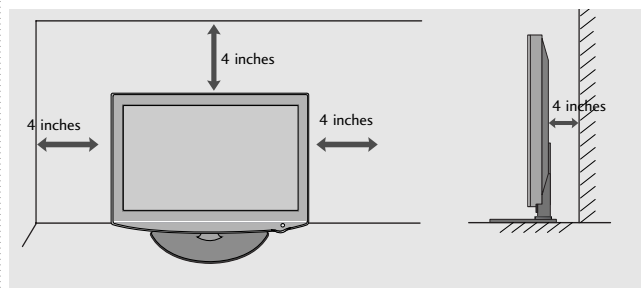

# WALL MOUNT: HORIZONTAL INSTALLATION

- We recommend the use of a LG Brand wall mounting bracket when mounting the TV to a wall.
- We recommend that you purchase a wall mounting bracket which supports VESA standard.
- LG recommends that wall mounting be performed by a qualified professional installer.
- First you connect the USB extension cable to the USB IN terminal, and then hang it on the wall.(Only 32/37/42/47LH7\*\*\*)

## NOTE

- ▶ Should install wall mount on a solid wall perpendicular to the floor.
- ▶ Should use a special wall mount, if you want to install it to ceiling or slanted wall.
- ▶ The surface that wall mount is to be mounted on should be of sufficient strength to support the weight of TV set; e.g. concrete, natural rock, brick and hollow block.
- ▶ Installing screw type and length depends on the wall mount used. Further information, refer to the instructions included with the mount.
- ▶ LG is not liable for any accidents or damage to property or TV due to incorrect installation:
  - Where a non-compliant VESA wall mount is used.
  - Incorrect fastening of screws to surface which may cause TV to fall and cause personal injury.
  - Not following the recommended Installation method.

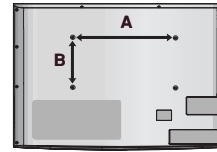
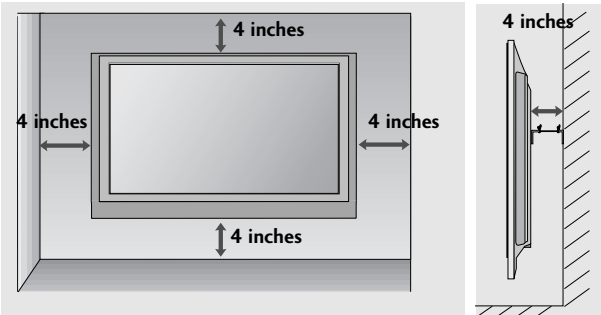

Model	VESA (A * B)	Standard Screw	Quantity
47LH9*** 42LH9***	200 * 200	M6	4
47LH7*** 42LH7*** 37LH7*** 32LH7***	200 * 200	M6	4
42LH6*** 32LH6***	200 * 200	M6	4
55LH5*** 47LH5*** 42LH5*** 37LH5***	400 * 400	M6	4
26LU5*** 22LU5*** 19LU5***	200 * 100	M4	4
47LH3*** 42LH3*** 37LH3*** 32LH3***	200 * 200	M6	4
42LH2*** 37LH2*** 32LH2*** 26LH2*** 22LH2*** 19LH2***	200 * 200	M6	4
42LF2*** 32LF2***	200 * 200	M6	4

# PREPARATION

## KENSINGTON SECURITY SYSTEM

- This feature is not available for all models.
- Here shown may be somewhat different from your TV.

The TV is equipped with a Kensington Security System connector on the back panel. Connect the Kensington Security System cable as shown below.

For the detailed installation and use of the Kensington Security System, refer to the user's guide provided with the Kensington Security System.

For further information, contact <http://www.kensington.com>, the internet homepage of the Kensington company. Kensington sells security systems for expensive electronic equipment such as notebook PCs and LCD projectors.

### NOTE

- The Kensington Security System is an optional accessory.

### NOTES

- If the TV feels cold to the touch, there may be a small "flicker" when when it is turned on. This is normal, there is nothing wrong with TV.
- Some minute dot defects may be visible on the screen, appearing as tiny red, green, or blue spots. However, they have no adverse effect on the monitor's performance.
- Avoid touching the LCD screen or holding your finger(s) against it for long periods of time. Doing so may produce some temporary distortion effects on the screen.

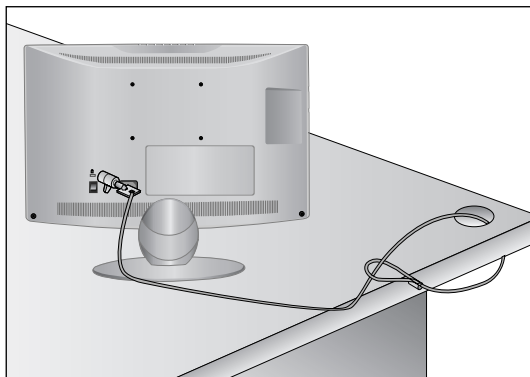

- To prevent damage do not connect to the mains outlet until all connections are made between the devices.

## ANTENNA CONNECTION

- For optimum picture quality, adjust antenna direction.
- An antenna cable and converter are not supplied.

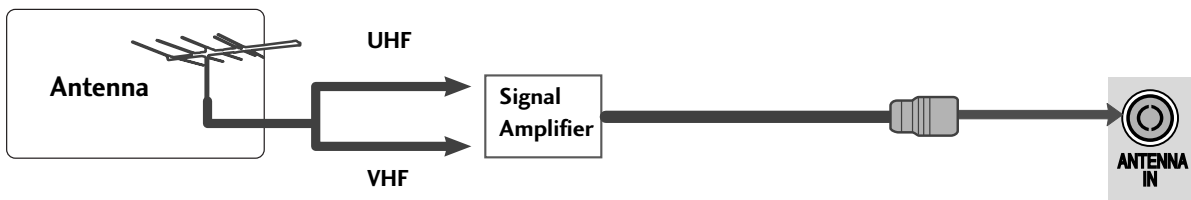
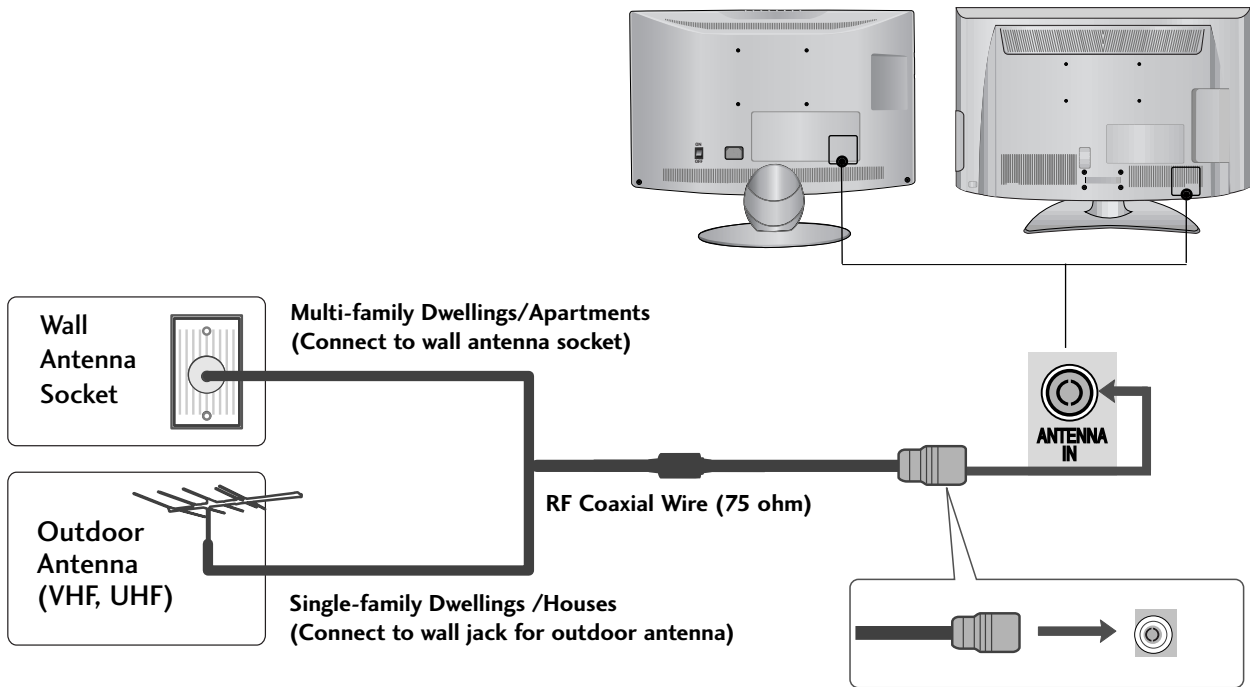

- In poor signal areas, to achieve better picture quality it may be necessary to install a signal amplifier to the antenna as shown above.
- If signal needs to be split for two TVs, use an antenna signal splitter for connection.

# EXTERNAL EQUIPMENT SETUP

- To avoid damaging any equipment, never plug in any power cords until you have finished connecting all equipment.
- This section on EXTERNAL EQUIPMENT SETUP mainly uses diagrams for the 37/42/47/55LH5\*\*\* models.
- Here shown may be somewhat different from your TV.

## HD RECEIVER SETUP

### Connecting with a component cable

- 1 Connect the video outputs (Y, PB, PR) of the digital set top box to the **COMPONENT IN VIDEO** jacks on the TV.
- 2 Connect the audio output of the digital set-top box to the **COMPONENT IN AUDIO** jacks on the TV.
- 3 Turn on the digital set-top box.  
(Refer to the owner's manual for the digital set-top box.)
- 4 Select **Component1** input source using the **INPUT** button on the remote control.  
If connected to **COMPONENT IN 2**, select **Component2** input source.

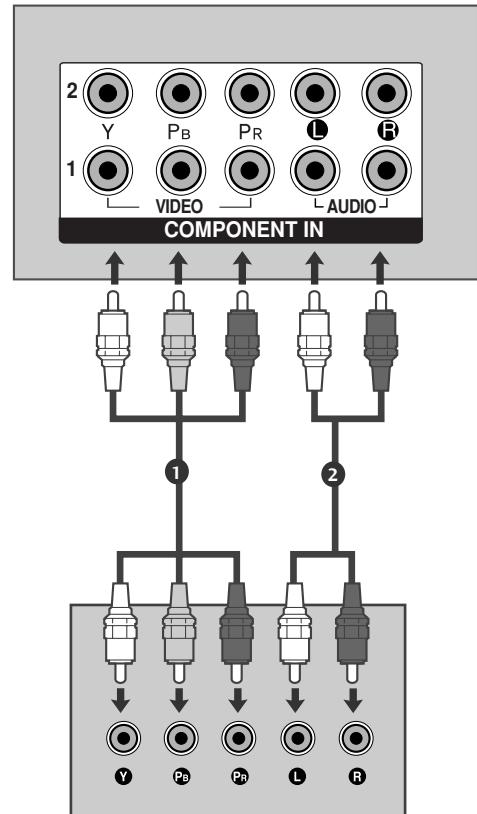

Signal	Component	HDMI
480i/576i	○	X
480p/576p	○	○
720p/1080i	○	○
1080p	○ (50/60Hz only)	○ (24Hz/30Hz/50Hz/60Hz)



## Connecting a set-top box with an HDMI cable

- 1 Connect the digital set-top box to **HDMI/DVI IN 1**, **HDMI IN 2** (Except 19/22LH2\*\*\*) or **HDMI IN 3** (Except 19/22/26/32/37/42LH2\*\*, 32/42LF2\*\*, 19/22LU5\*\*\*) jack on the TV.
- 2 Turn on the digital set-top box. (Refer to the owner's manual for the digital set-top box.)
- 3 Select **HDMI1**, **HDMI2** (Except 19/22LH2\*\*\*) or **HDMI3** (Except 19/22/26/32/37/42LH2\*\*, 32/42LF2\*\*, 19/22LU5\*\*\*) input source using the **INPUT** button on the remote control.

### ! NOTE

- ▶ Check that your HDMI cable is version 1.3 or higher. If the HDMI cables don't support HDMI version 1.3, flickering or no screen display can result. Please use the latest cables that support at least HDMI version 1.3.

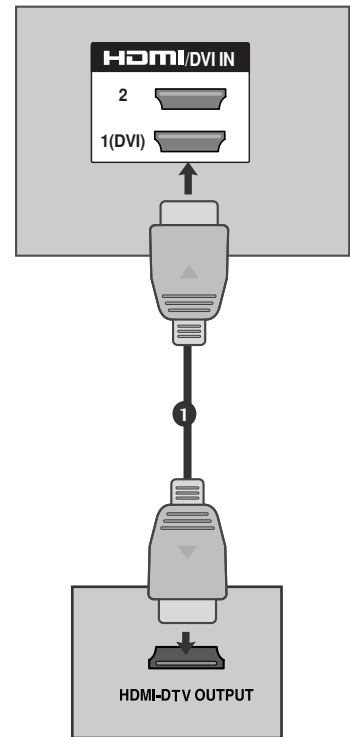

## Connecting with an HDMI to DVI cable

- 1 Connect the digital set-top box to **HDMI/DVI IN 1** jack on the TV.
- 2 Connect the audio output of the digital set-top box to the **AUDIO IN (RGB/DVI)** jack on the TV.
- 3 Turn on the digital set-top box. (Refer to the owner's manual for the digital set-top box.)
- 4 Select **HDMI1** input source using the **INPUT** button on the remote control.

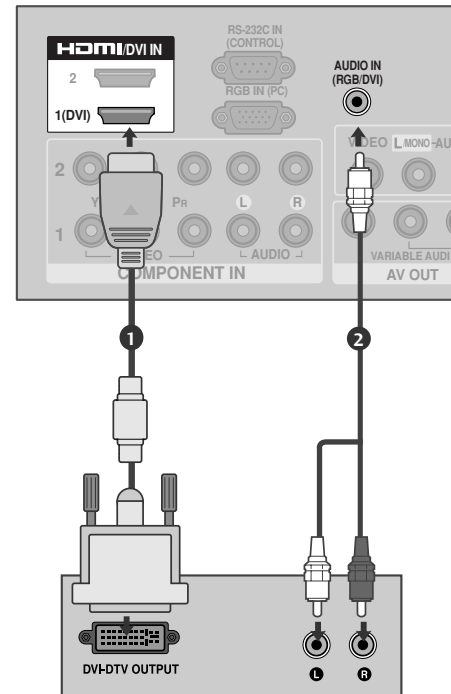

# EXTERNAL EQUIPMENT SETUP

## DVD SETUP

### Connecting with a component cable

- 1 Connect the video outputs (Y, PB, PR) of the DVD to the **COMPONENT IN VIDEO** jacks on the TV.
- 2 Connect the audio outputs of the DVD to the **COMPONENT IN AUDIO** jacks on the TV.
- 3 Turn on the DVD player, insert a DVD.
- 4 Select **Component1** input source using the **INPUT** button on the remote control.  
If connected to **COMPONENT IN 2**, select **Component2** input source.
- 5 Refer to the DVD player's manual for operating instructions.

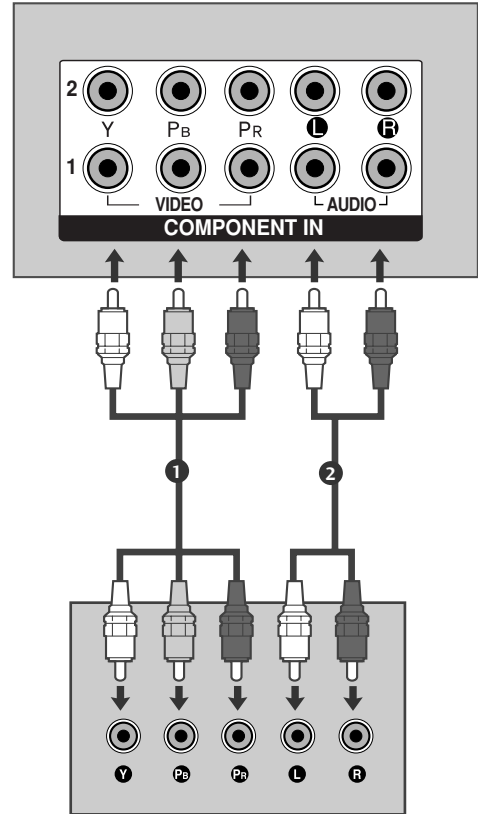

### Component Input ports

To achieve better picture quality, connect a DVD player to the component input ports as shown below.

Component ports on the TV	Y	P <sub>B</sub>	P <sub>R</sub>
Video output ports on DVD player	Y	P <sub>B</sub>	P <sub>R</sub>
	Y	B-Y	R-Y
	Y	C <sub>b</sub>	C <sub>r</sub>
	Y	P <sub>b</sub>	P <sub>r</sub>

## Connecting the HDMI cable

- 1 Connect the HDMI output of the DVD to the **HDMI/DVI IN 1**, **HDMI IN 2** (Except 19/22LH2\*\*\*) or **HDMI IN 3** (Except 19/22/26/32/37/42LH2\*\*\*, 32/42LF2\*\*\*, 19/22LU5\*\*\*) jack on the TV.
- 2 Select **HDMI1**, **HDMI2** (Except 19/22LH2\*\*\*) or **HDMI3** (Except 19/22/26/32/37/42LH2\*\*\*, 32/42LF2\*\*\*, 19/22LU5\*\*\*) input source using the **INPUT** button on the remote control.
- 3 Refer to the DVD player's manual for operating instructions.

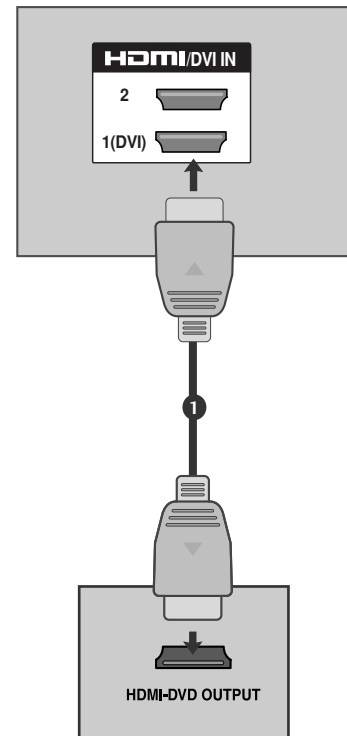

### ! NOTE

- ▶ The TV can receive video and audio signals simultaneously when using a HDMI cable.
  - ▶ If the DVD does not support Auto HDMI, you must set the output resolution appropriately.
  - ▶ Check that your HDMI cable is version 1.3 or higher.
- If the HDMI cables don't support HDMI version 1.3, flickering or no screen display can result. Please use the latest cables that support at least HDMI version 1.3.

# EXTERNAL EQUIPMENT SETUP

## VCR SETUP

- To avoid picture noise (interference), allow adequate distance between the VCR and TV.

### Connecting with a RF Cable

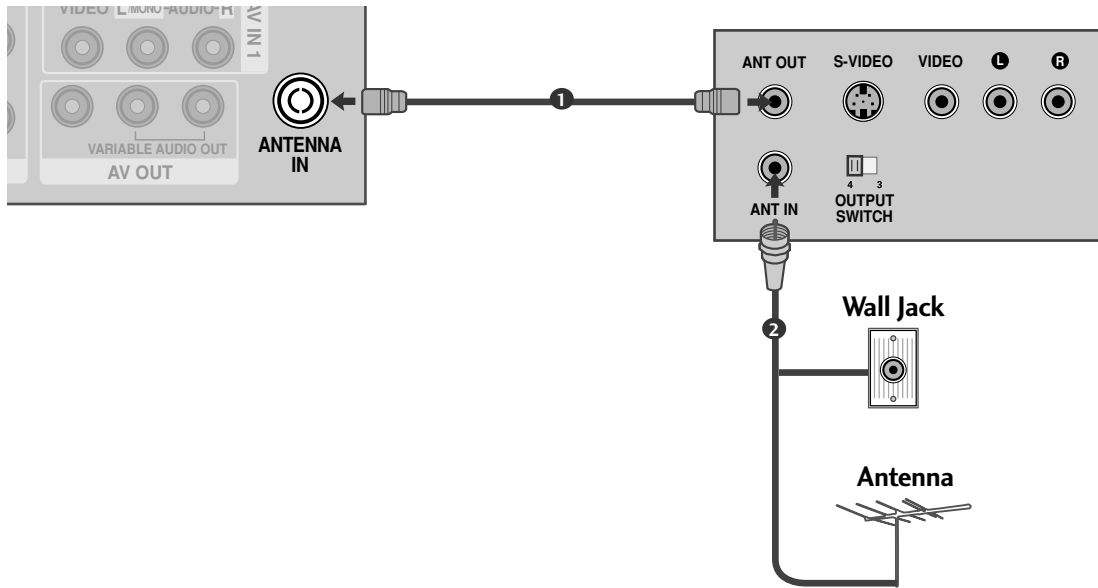

- 1 Connect the **ANT OUT** socket of the VCR to the **ANTENNA IN** socket on the TV.
- 2 Connect the antenna cable to the **ANT IN** socket of the VCR.
- 3 Press the **PLAY** button on the VCR and match the appropriate channel between the TV and VCR for viewing.

## Connecting with a RCA cable

- 1 Connect the **AUDIO/VIDEO** jacks between TV and VCR. Match the jack colours (Video = yellow, Audio Left = white, and Audio Right = red)
- 2 Insert a video tape into the VCR and press **PLAY** on the VCR. (Refer to the VCR owner's manual.)
- 3 Select **AV1** input source using the **INPUT** button on the remote control.  
If connected to **AV IN 2**, select **AV2** input source.

### ! NOTE

- ▶ If you have a mono VCR, connect the audio cable from the VCR to the **AUDIO L/MONO** jack of the TV.

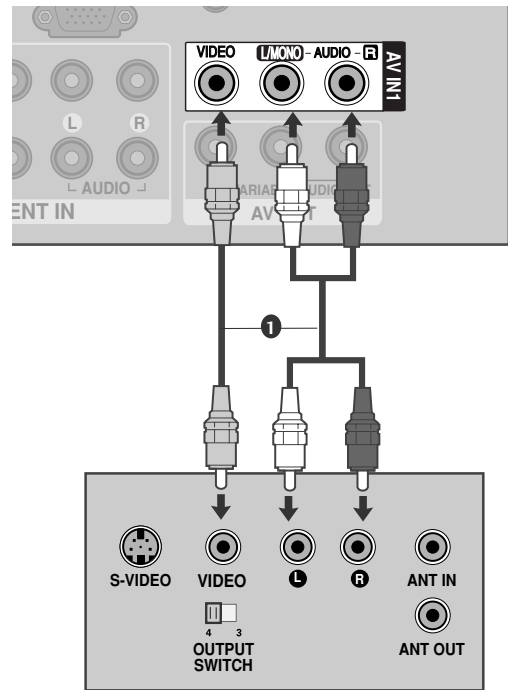

or

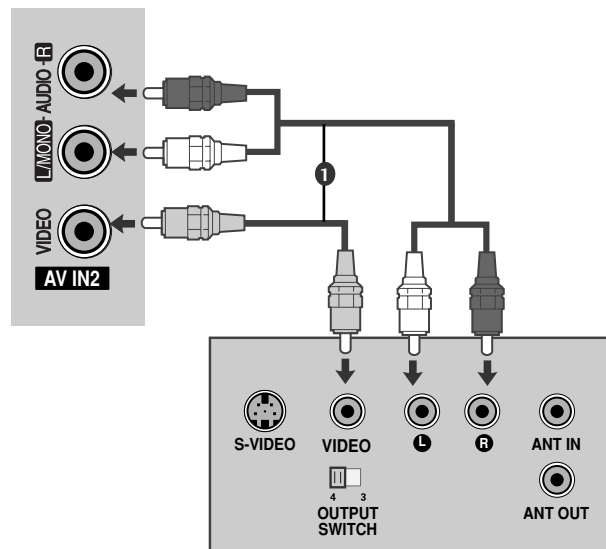

# EXTERNAL EQUIPMENT SETUP

## OTHER A/V SOURCE SETUP

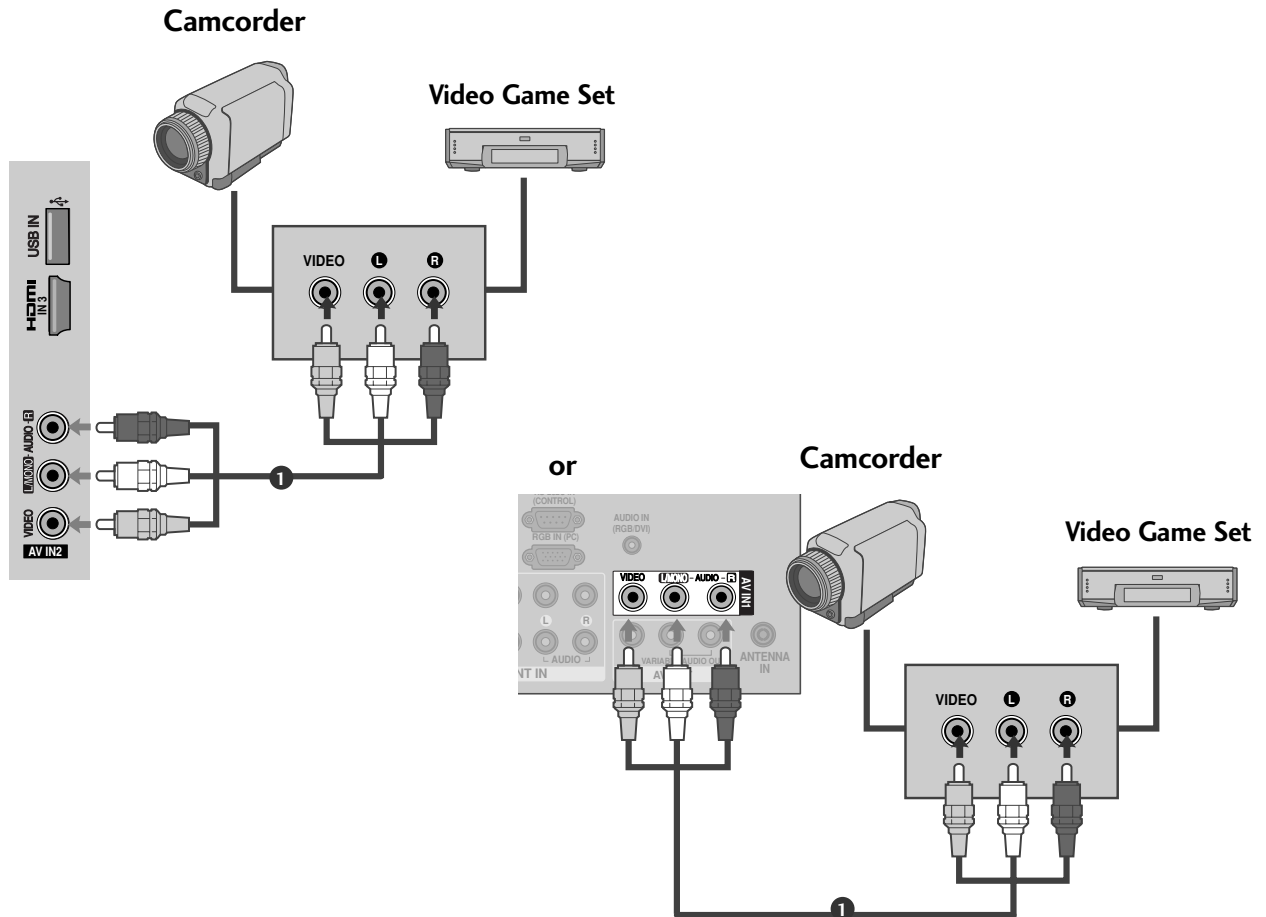

- 1 Connect the **AUDIO/VIDEO** jacks between TV and external equipment. Match the jack colours .  
(Video = yellow, Audio Left = white, and Audio Right = red)
- 2 Select **AV1** input source with using the **INPUT** button on the remote control.  
If connected to **AV IN 2**, select **AV2** input source.
- 3 Operate the corresponding external equipment.  
Refer to external equipment operating guide.

## EXTERNAL STEREO SETUP

Use to connected either an external amplifier, or add a sub-woofer to your surround sound system.

- 1 Connect the input jack of the stereo amplifier to the **VARIABLE AUDIO OUT** jacks on the TV.
- 2 Set up your speakers through your analog stereo amplifier, according to the instructions provided with the amplifier.

### ! NOTE

- ▶ When connecting with external audio equipments, such as amplifiers or speakers, please turn the TV speakers off. (▶ p.99)
- ▶ Select **Variable Out** in **AUDIO** menu to connect the **VARIABLE AUDIO OUT** jacks. (▶ p.100)

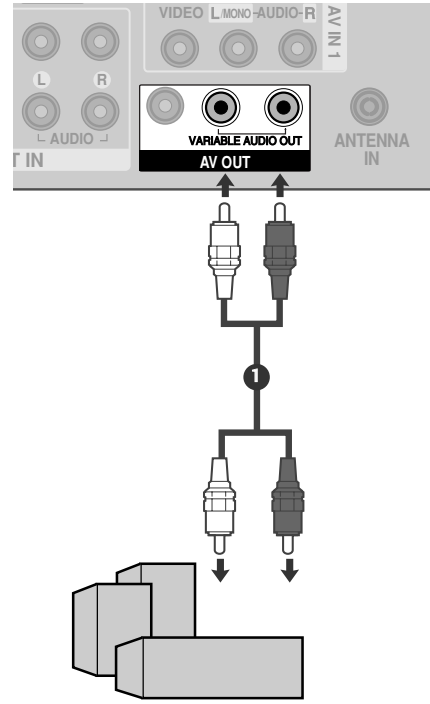

## AV OUTPUT SETUP

The TV has a special signal output capability which allows you to hook up the second TV or monitor.

- 1 Connect the second TV or monitor to the TV's **AV OUT** jacks.
- 2 See the Operating Manual of the second TV or monitor for further details regarding that device's input settings.

### ! NOTE

- ▶ Component, RGB, HDMI input sources cannot be used for AV out.
- ▶ We recommend to use the AV OUT jacks for VCR recording.

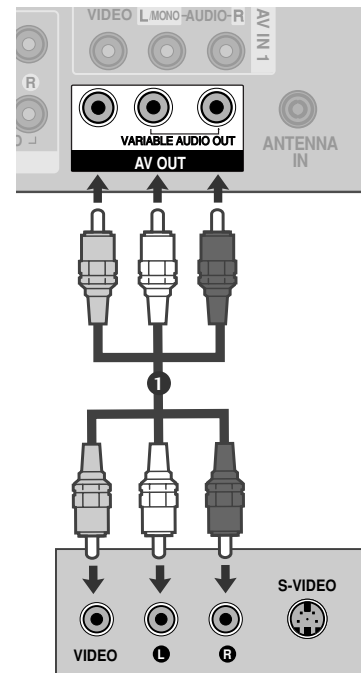

# EXTERNAL EQUIPMENT SETUP

## USB IN SETUP

(except 19/22/26/32/37/42LH2\*\*\*, 32/42LF2\*\*\*, 19/22/26LU5\*\*\*)

- Here shown may differ from your TV.

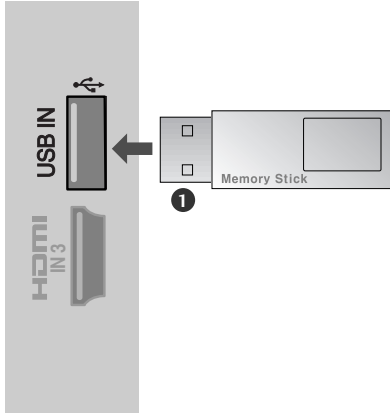

- 
- 1 Connect the USB device to the **USB IN** jack on the TV.
- .....

- 2 After connecting the **USB IN** jacks, you use the **USB** function. (► p.68)
-



# PC SETUP

This TV provides Plug and Play capability, meaning that the PC adjusts automatically to the TV's settings.

## Connecting with a D-sub 15 pin cable

- 1 Connect the RGB output of the PC to the **RGB IN (PC)** jack on the TV.
- 2 Connect the PC audio output to the **AUDIO IN (RGB/DVI)** jack on the TV.
- 3 Turn on the TV and the PC.
- 4 Select **RGB** input source using the **INPUT** button on the remote control.

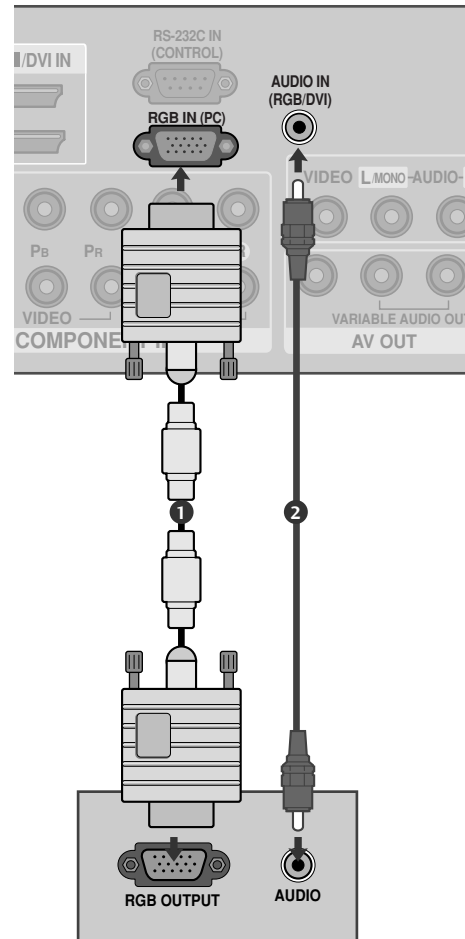

# EXTERNAL EQUIPMENT SETUP

## Supported Display Resolution

### RGB-PC mode

Resolution	Horizontal Frequency(kHz)	Vertical Frequency(Hz)
640x350	31.468	70.09
720x400	31.469	70.09
640x480	31.469	59.94
800x600	37.879	60.317
1024x768	48.363	60.004
1280x768	47.776	59.87
1360x768	47.720	59.799
1280x1024	63.668	59.895
1920x1080	66.587	59.934

Except 19LU5\*\*\*, 19/22/26/32/37/42LH2\*\*\*

### HDMI-DTV mode

Resolution	Horizontal Frequency(kHz)	Vertical Frequency(Hz)
720x480	31.47	59.94
	31.50	60.00
720x576	31.25	50.00
1280x720	44.96	59.94
	45.00	60.00
	37.50	50.00
1920x1080i	33.75	60.00
	33.72	59.94
	28.125	50.00
1920x1080p	67.432	59.94
	67.5	60
	56.250	50
	27	24
	33.75	30

**! NOTE**

- ▶ Avoid keeping a fixed image on the TV 's screen for prolonged periods of time. The fixed image may become permanently imprinted on the screen; use a screen saver when possible.
- ▶ There may be interference relating to resolution, vertical pattern, contrast or brightness in PC mode. Change the PC mode to another resolution or change the refresh rate to another rate or adjust the brightness and contrast on the menu until the picture is clear. If the refresh rate of the PC graphic card can not be changed, change the PC graphic card or consult the manufacturer of the PC graphic card.
- ▶ The synchronization input waveform for Horizontal and Vertical frequencies are separate.
- ▶ If the resolution of PC is over SXGA, there will be no picture on the TV. (only HD Models)
- ▶ Connect the audio cable from the PC to the Audio input on the TV. (Audio cables are not included with the TV).
- ▶ If you use too long an RGB-PC cable, there may be interference on the screen. We recommend using under 5m of the cable. This provides the best picture quality.
- ▶ We recommend using 1920x1080, 60Hz (19LU5\*\*\*, 19/22/26/32/37/42LH2\*\*\*; 1360x768, 60Hz) for the PC mode, these should provide the best picture quality.
- ▶ HDMI mode supports PCM audio format only.
- ▶ If the Audio setting is set to Dolby/DTS/Bitstream in some DVDP/STB, make sure to change the setting to PCM.

# EXTERNAL EQUIPMENT SETUP







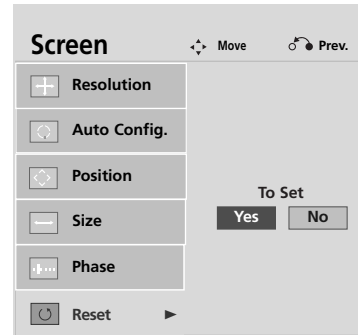
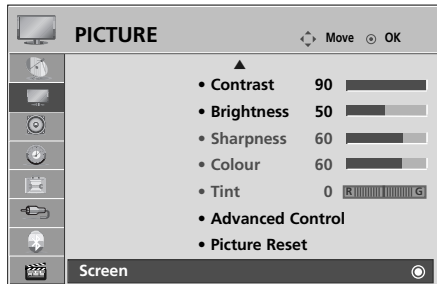

## Screen Setup for PC mode

### Screen Reset

Returns Position, Size and Phase to the factory default settings.

This function works in the following mode : RGB[PC], Component(except 480i, 576i).



- 1   Select **PICTURE**.
- 2   Select **Screen**.
- 3   Select **Reset**.
- 4   Select **Yes**.
- 5  Run **Reset**.







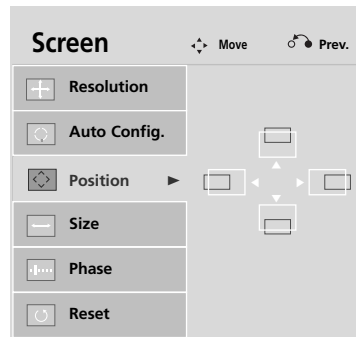
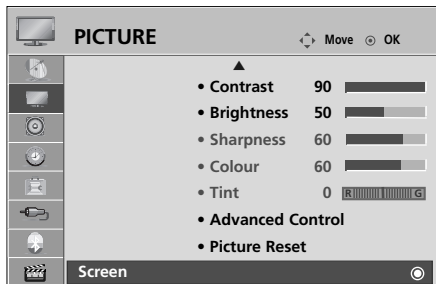

- Press the **MENU** button to return to normal TV viewing.
- Press the **RETURN** button to move to the previous menu screen.

## Adjustment for screen Position, Size, Phase

If the picture is not clear after auto adjustment and especially if characters are still trembling, adjust the picture phase manually.

**Position** operates in Component(except 480i, 576i), RGB mode.  
**Size, Phase** operate only in RGB mode.



- 1   Select **PICTURE**.
- 2   Select **Screen**.
- 3   Select **Position, Size or Phase**.
- 4    Make appropriate adjustments.

- Press the **MENU** button to return to normal TV viewing.
- Press the **RETURN** button to move to the previous menu screen.







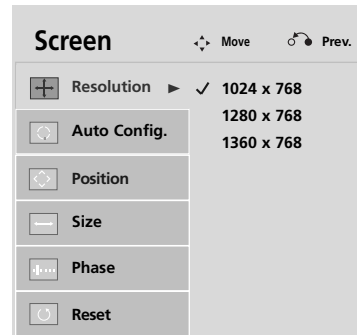
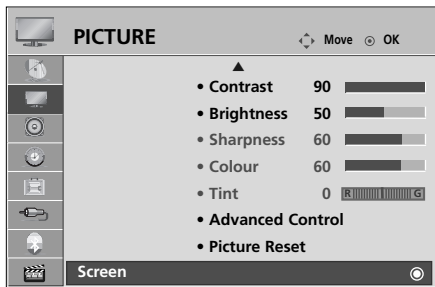

# EXTERNAL EQUIPMENT SETUP

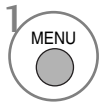
## Selecting Resolution

To view a normal picture, match the resolution of RGB mode and selection of PC mode.

This function works in the following mode: RGB[PC]



1.   Select **PICTURE**.
2.   Select **Screen**.
3.   Select **Resolution**.
4.   Select the desired resolution.

- Press the **MENU** button to return to normal TV viewing.
- Press the **RETURN** button to move to the previous menu screen.

## Auto Configure (RGB [PC] mode only)

Automatically adjusts the picture position and minimizes image instability. After adjustment, if the image is still not correct, your TV is functioning properly but needs further adjustment.

### Auto configure

This function is for automatic adjustment of the screen position, size, and phase.

The displayed image will be unstable for a few seconds while the auto configuration is in progress.

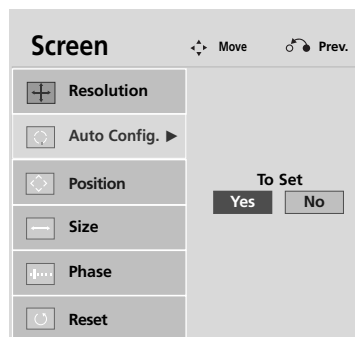
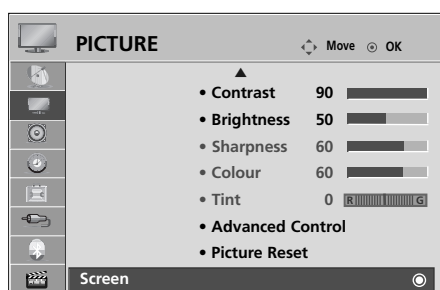

1   Select **PICTURE**.

2   Select **Screen**.

3   Select **Auto Config..**

4   Select **Yes**.

5  Run **Auto Config..**

- If the position of the image is still not correct, try Auto adjustment again.
- If picture needs to be adjusted again after Auto adjustment in RGB(PC), you can adjust the **Position, Size** or **Phase**.

- Press the **MENU** button to return to normal TV viewing.
- Press the **RETURN** button to move to the previous menu screen.

# WATCHING TV / PROGRAMME CONTROL

## REMOTE CONTROL KEY FUNCTIONS

(Except 19/22/26/32/37/42LH2\*\*\*, 32/42LF2\*\*\*, 32/37/42/47LH3\*\*\*)

When using the remote control, aim it at the remote control sensor on the TV.



**RATIO** Selects your desired picture format.

**SLEEP** Sets the sleep timer.

**POWER** Switches the TV on from standby or off to standby.

**INPUT** External input mode rotate in regular sequence.

**ENERGY SAVING** Adjust the energy saving mode of the TV.

**Q. MENU** Select the desired quick menu source. (Aspect Ratio, Clear Voice II, Picture Mode, Sound Mode, AUDIO, Sleep Timer, Favourite, USB Device) (► p.43)

**MENU** Selects a menu. Clears all on-screen displays and returns to TV viewing from any menu.

**SIMPLINK** See a list of AV devices connected to TV. When you toggle this button, the Simplink menu appears at the screen. (► p.54)

**THUMBSTICK** (Up/Down/Left/Right) Allows you to navigate the on-screen menus and adjust the system settings to your preference.

**OK** Accepts your selection or displays the current mode.

**RETURN** Allows the user to move return one step in an interactive application or other user interaction function.

**XSTUDIO** Enter to the **XSTUDIO** mode.

**AV MODE** It helps you select and set images and sounds when connecting AV devices. (► p.59)

**Coloured buttons** These buttons are used for teletext (on **TELETEXT** models only) , **Programme edit**.

**1 TELETEXT BUTTONS** These buttons are used for teletext. For further details, see the 'Teletext' section. (► p.107)





**VOLUME UP /DOWN** Adjusts the volume.

**MARK** Check and un-check programmes in the USB menu.

**FAV** Displays the selected favourite programme.

**MUTE** Switches the sound on or off.

**Programme UP/DOWN** Selects a programme.

**PAGE UP/DOWN** Move from one full set of screen information to the next one.

**0~9 number button** Selects a programme.  
Selects numbered items in a menu.

**LIST** Displays the programme table.

**Q.VIEW** Returns to the previously viewed programme.

**SIMPLINK / USB Menu control buttons** Controls SIMPLINK or USB menu.

### Installing Batteries

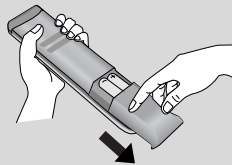

- Open the battery compartment cover on the back and install the batteries matching correct polarity (+with +,-with -).
- Install two 1.5V AAA batteries. Do not mix old or used batteries with new ones.
- Close cover.

# WATCHING TV / PROGRAMME CONTROL

## REMOTE CONTROL KEY FUNCTIONS

(Only 19/22/26/32/37/42LH2\*\*\*, 32/42LF2\*\*\*, 32/37/42/47LH3\*\*\*)

When using the remote control, aim it at the remote control sensor on the TV.

**XSTUDIO** Enter to the **XSTUDIO** mode.  
(Only 32/37/42/47LH3\*\*\*)

**RATIO** Selects your desired picture format.

**AV MODE** It helps you select and set images and sounds when connecting AV devices. (► p.59)

**POWER** Switches the TV on from standby or off to standby.

**INPUT** External input mode rotate in regular sequence.

**ENERGY SAVING** Adjust the energy saving mode of the TV.

**0~9 number button** Selects a programme.  
Selects numbered items in a menu.

**Q.VIEW** Returns to the previously viewed programme.

**LIST** Displays the programme table.

**THUMBSTICK** (Up/Down/Left/Right) Allows you to navigate the on-screen menus and adjust the system settings to your preference.

**OK** Accepts your selection or displays the current mode.

**MENU** Selects a menu.  
Clears all on-screen displays and returns to TV viewing from any menu.

**RETURN** Allows the user to move return one step in an interactive application or other user interaction function.

**Coloured buttons** These buttons are used for teletext (on **TELETEXT** models only) , **Programme edit**.

**1** **TELETEXT BUTTONS** These buttons are used for teletext.  
For further details, see the 'Teletext' section. (► p.107)

**FAV** Displays the selected favourite programme.

**MARK** Check and un-check programmes in the USB menu. (Only 32/37/42/47LH3\*\*\*)

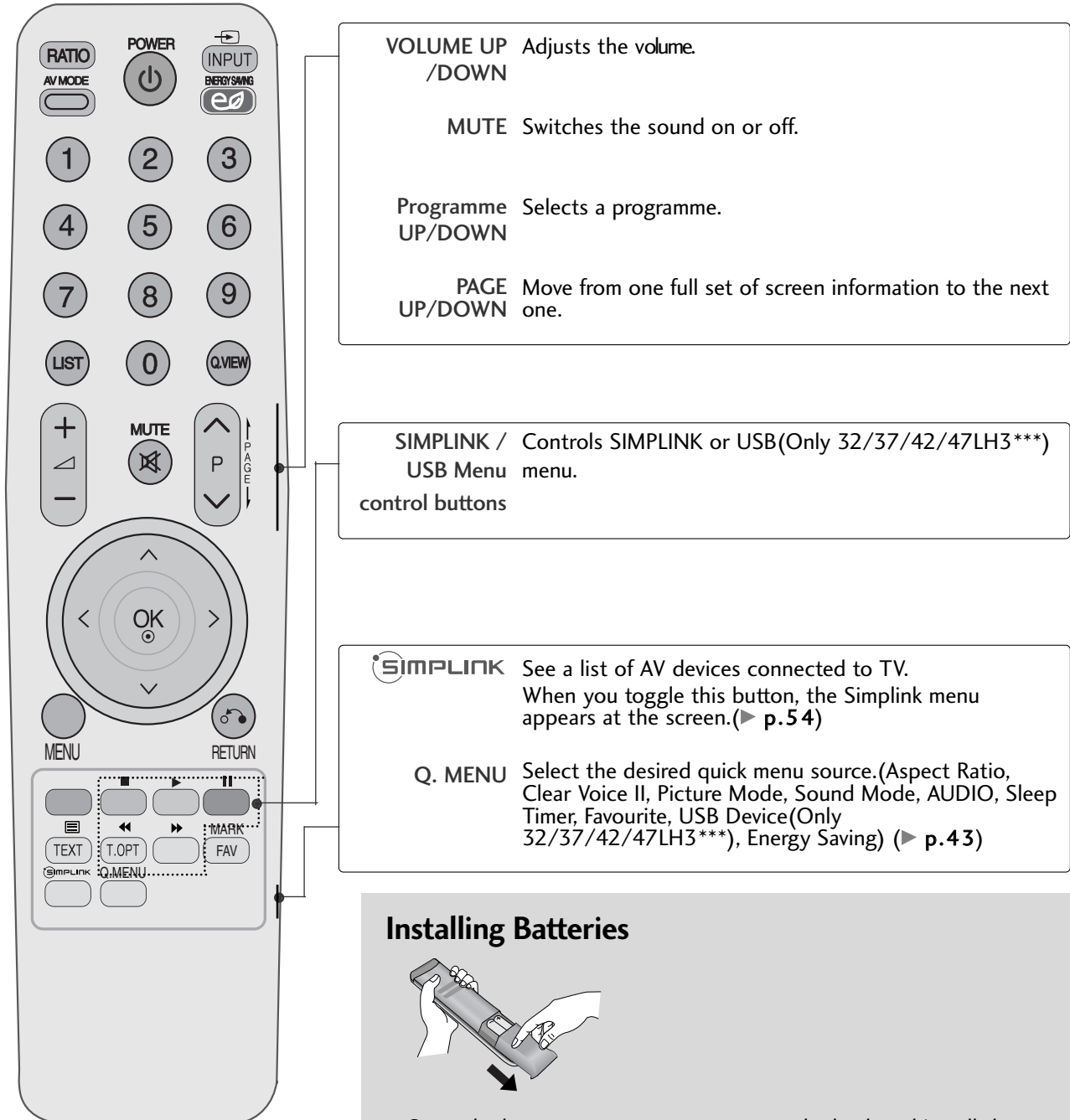

### Installing Batteries

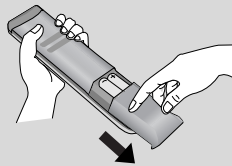

- Open the battery compartment cover on the back and install the batteries matching correct polarity (+with +,-with -).
- Install two 1.5V AAA batteries. Do not mix old or used batteries with new ones.
- Close cover.

# WATCHING TV / PROGRAMME CONTROL

## TURNING ON THE TV

- When your TV is turned on, you will be able to use its features.

- 1 Firstly, connect the power cord correctly and check the main power on the TV.  
At this stage, the TV switches to standby mode.
- 2 In standby mode to turn TV on, press the  $\phi$  / I, INPUT or P  $\blacktriangle$   $\blacktriangledown$  (or P  $\wedge$   $\vee$ ) button on the TV or press the POWER, INPUT, P  $\wedge$   $\vee$  or NUMBER button on the remote control and the TV will switch on.

### Initializing setup.

If the OSD (On Screen Display) is displayed on the screen after turning on the TV, you can adjust the **Language, Mode Setting, Auto Tuning.**

#### Note:

- a. If you close without completing the initial setting, the Initial Setting menu can be displayed again.
- b. "Store Demo" mode is only for shop display and not for general customer use.
- c. "Home Use" mode is the optimal setting for home environments, and is the TV's default mode.
- d. "Store Demo" mode is the optimal setting for store environments. If a user modifies image quality data, "Store Demo" mode initializes the product to the image quality set by us after a certain period of time.
- e. The mode (Home Use, Store Demo) can be changed by executing Mode Setting in the OPTION menu.

## PROGRAMME SELECTION

- 1 Press the P  $\wedge$   $\vee$  or NUMBER buttons to select a programme number.

## VOLUME ADJUSTMENT

- 1 Press the  $\blacktriangleleft$  + or - button to adjust the volume.

If you wish to switch the sound off, press the MUTE button.

You can cancel this function by pressing the MUTE,  $\blacktriangleleft$  + or - , AV Mode button.

# QUICK MENU

Your TV's OSD (On Screen Display) may differ slightly from that shown in this manual.

Q.Menu (Quick Menu) is a menu of features which users might use frequently.



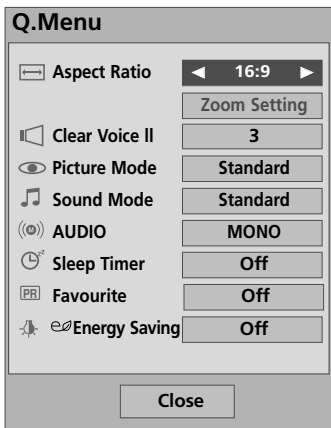

- **Aspect Ratio**: Selects your desired picture format. For Zoom Setting, select 16:9, Original, 4:3, 14:9, Zoom and Cinema Zoom in Ratio Menu. After completing Zoom Setting, the display goes back to Q.Menu.
- **Clear Voice II**: By differentiating the human sound range from others, it helps users listen to human voices better.
- **Picture Mode**: Selects your desired Picture Mode.
- **Sound Mode**: It is a feature to automatically set the sound combination which it deems the best for the images being watched. Selects your desired Sound Mode.
- **AUDIO**: Selects the sound output.
- **Sleep Timer**: Sets the sleep timer.
- **Favourite**: Selects the favourite On or Off.
- **Energy Saving**: Selects the Energy saving mode.
- **USB Device**: Selects "Eject" in order to eject USB device.

Only 19/22/26/32/37/42LH2\*\*\*,  
32/42LF2\*\*\*, 19/22/26LU5\*\*\*

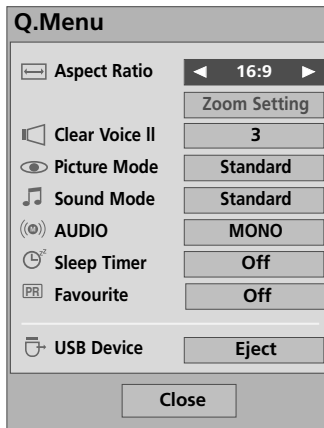

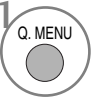
Except 19/22/26/32/37/42LH2\*\*\*,  
32/42LF2\*\*\*, 19/22/26LU5\*\*\*

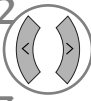

1.   Display each menu.
2.  Select your desired Source.
3. 

- Press the **Q.MENU** button to return to normal TV viewing.



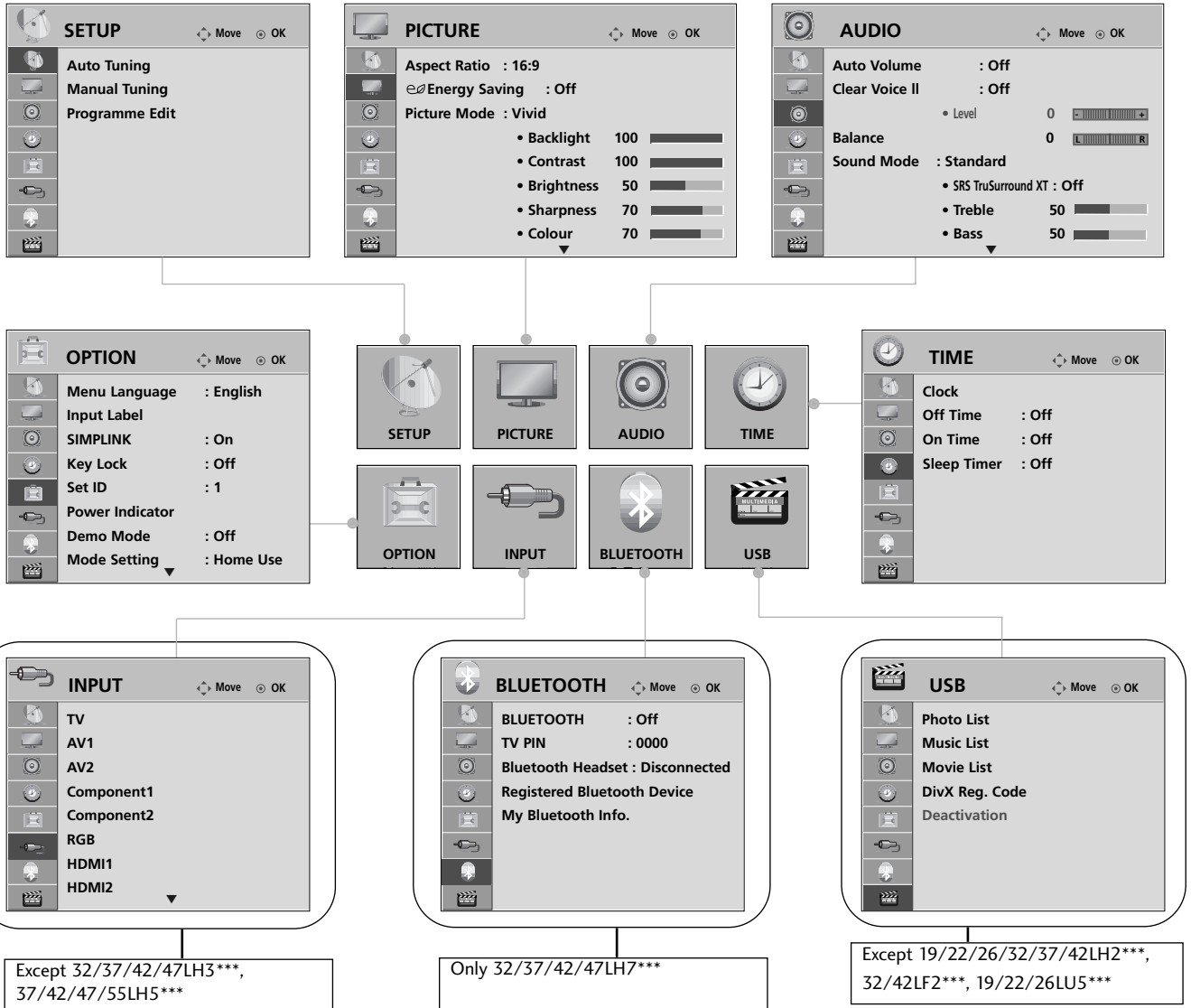

# WATCHING TV / PROGRAMME CONTROL

## ON SCREEN MENUS SELECTION AND ADJUSTMENT

■ Here shown may be somewhat different from your TV.  
Your TV's OSD (On Screen Display) may differ slightly from that shown in this manual.

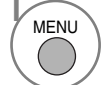

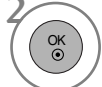
WATCHING TV / PROGRAMME CONTROL

- 1   Display each menu.
- 2   Select a menu item.
- 3  Move to the pop up menu.







- Press the **MENU** button to return to normal TV viewing.
- Press the **RETURN** button to move to the previous menu screen.

# AUTO PROGRAMME TUNING

Use this to automatically find and store all available programmes.

When you start auto programming, all previously stored service information will be deleted.



-   Select **SETUP**.
-   Select **Auto Tuning**.
-   Select **Yes**.
-  Run **Auto Tuning**.

• If you wish to keep on auto tuning select **Yes** using the < > button. Then, press the OK button. Otherwise select **No**.

- Press the **MENU** button to return to normal TV viewing.
- Press the **RETURN** button to move to the previous menu screen.

# WATCHING TV / PROGRAMME CONTROL

## MANUAL PROGRAMME TUNING

Manual Tuning lets you manually tune and arrange the stations in whatever order you desire.

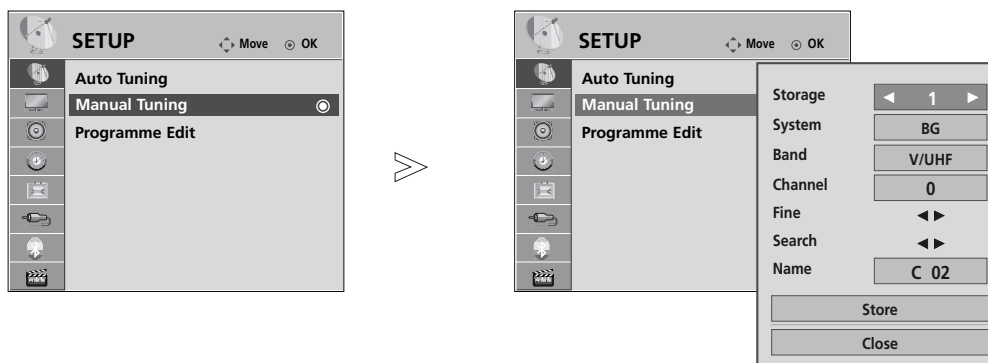

- 1 Select **SETUP**.
- 2 Select **Manual Tuning**.
- 3 or Select the desired programme number on.
- 4 Select a TV system.
- 5 Select **V/UHF** or **Cable**.
- 6 or Select the desired channel number.
- 7 Commence searching.
- 8 Select **Store**.
- 9

- Press the **MENU** button to return to normal TV viewing.
- Press the **RETURN** button to move to the previous menu screen.

- **BG** : PAL B/G, SECAM B/G (Asia / New Zealand / M.East / Africa)
- **I** : PAL I/II (Hong Kong / South Africa)
- **DK** : PAL D/K, SECAM D/K (China / Africa)
- **M** : Philippines
- To store another channel, repeat steps 3 to 9.



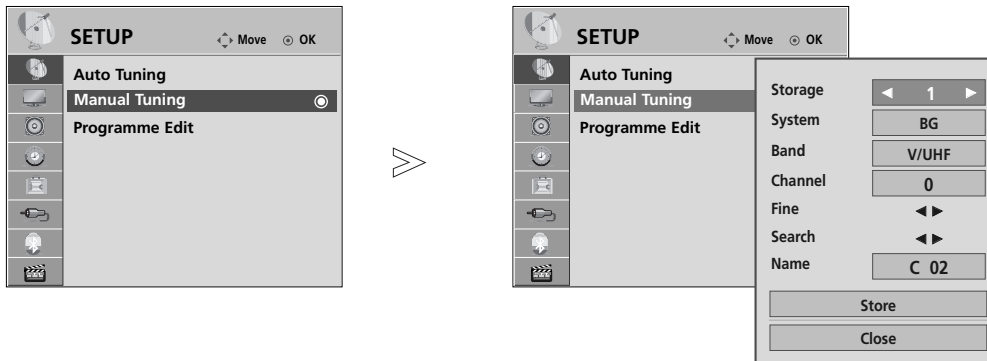

### ■ Assigning a station name

You can assign a station name with five characters to each programme number.

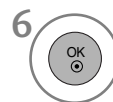
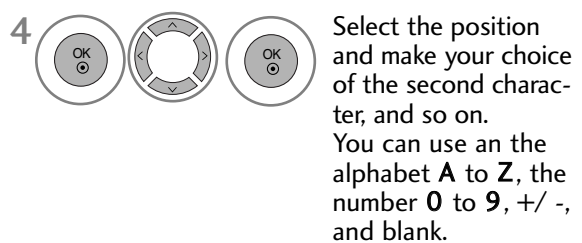

### ■ Fine Tuning

Normally fine tuning is only necessary if reception is poor.

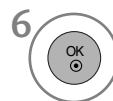
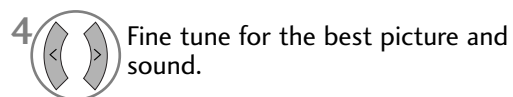

- Press the **MENU** button to return to normal TV viewing.
- Press the **RETURN** button to move to the previous menu screen.

# WATCHING TV / PROGRAMME CONTROL

## PROGRAMME EDIT

When a programme number is skipped, it means that you will be unable to select it using **P** ^ v button during TV viewing.

If you wish to select the skipped programme, directly enter the programme number with the **NUMBER** buttons or select it in the Programme edit menu.

This function enables you to skip the stored programmes.

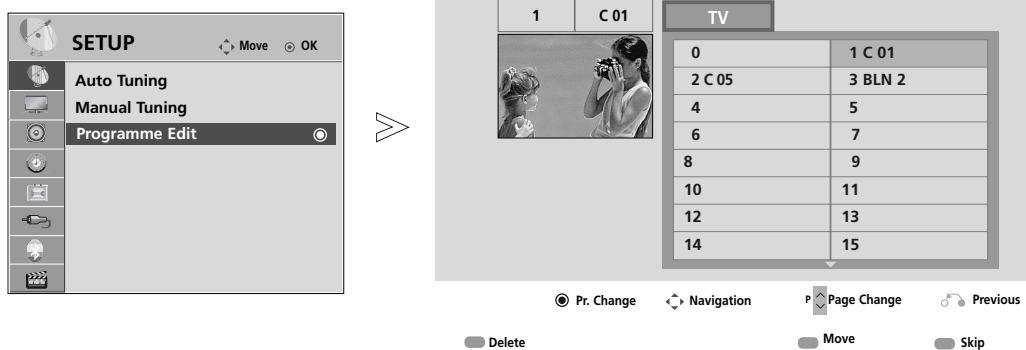

- 1 Select **SETUP**.
- 2 Select **Programme Edit**.
- 3 Enter the **Programme Edit**.
- 4 Select a programme to be stored or skipped.

- Press the **MENU** button to return to normal TV viewing.
- Press the **RETURN** button to move to the previous menu screen.

This function enables you to delete or skip the stored programmes.  
You can also move some channels and use other programme numbers.

### ■ Deleting a programme



Select a programme number to be deleted.



Turn the deleted programme number to RED.



Release the deleted programme.

- The selected programme is deleted, all the following programmes are shifted up one position.

### ■ Moving a programme

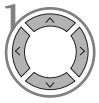

Select a programme number to be moved.

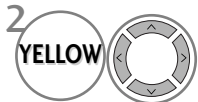

Turn the moved programme number to YELLOW.



Release the moved programme.

### ■ Skipping a programme number



Select a programme number to be skipped.



Turn the skipped programme number to BLUE.



Release the skipped programme.

- When a programme number is skipped it means that you will be unable to select it using the P ^ v button during normal TV viewing.
- If you wish to select a skipped programme, directly enter the programme number with the NUMBER buttons or select it in the programme edit.

# WATCHING TV / PROGRAMME CONTROL

## SELECTING THE PROGRAMME LIST

You can check which programmes are stored in the memory by displaying the programme list.





### ■ Displaying programme list

- 1  Display the Programme List.

- You may find some blue programmes. These have been set up to be skipped by auto programming or in the programme edit mode.
- Some programmes with the channel number shown in the programme LIST indicate there is no station name assigned.

### ■ Selecting a programme in the programme list

- 1  Select a programme.
- 2  Switch to the chosen programme number.

### ■ Paging through a programme list

- 1  Turn the pages.
- 2  Return to normal TV viewing.

# FAVOURITE PROGRAMME SETUP

## ■ Selecting favourite programme

Favorite programmes is a convenient feature that lets you quickly scan up to programmes of your choice without having to wait for the TV to scan through all the in-between programmes. To tune to a favorite programme, press the **FAV**(Favorite)button repeatedly.

Only 19/22/26/32/37/42LH2\*\*\*, 32/42LF2\*\*\*, 19/22/26LU5\*\*\*

Except 19/22/26/32/37/42LH2\*\*\*, 32/42LF2\*\*\*, 19/22/26LU5\*\*\*

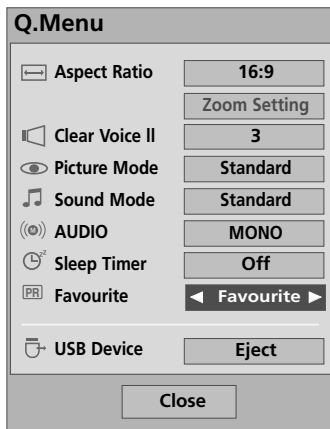
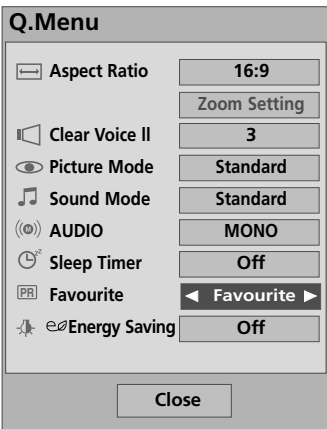

- 1 Select your desired programme.
- 2 Select **Favourite**.
- 3 Select **Favourite**.
- 4 Return to TV viewing.

- This will automatically include the selected programme into your favourite programme list.

## ■ Displaying the favourite programme list



- 1 Display the Favourite Programme List.

# WATCHING TV / PROGRAMME CONTROL

## INPUT LIST

- Here shown may be somewhat different from your TV.



Except 19/22/26/32/37/42LH2\*\*\*, 32/42LF2\*\*\*, 32/37/42/47LH3\*\*\*, 19/22/26LU5\*\*\*

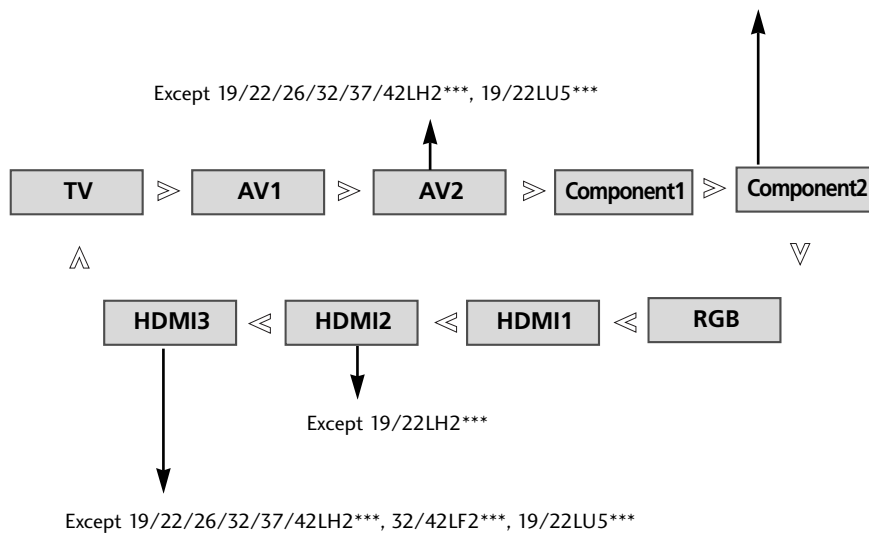





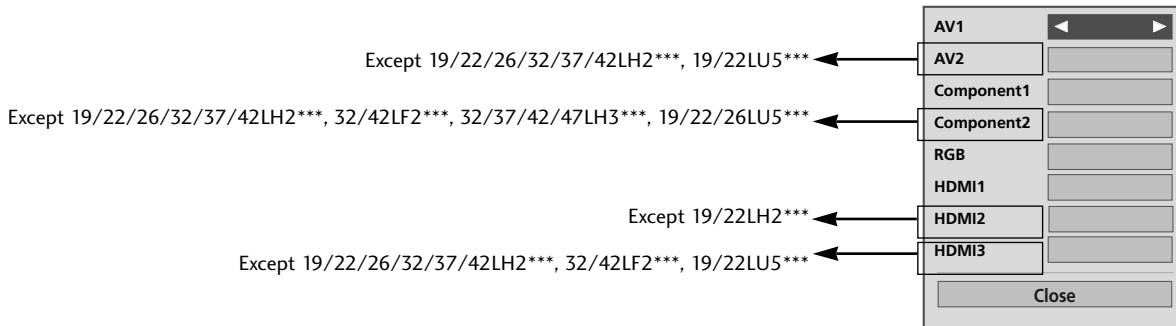
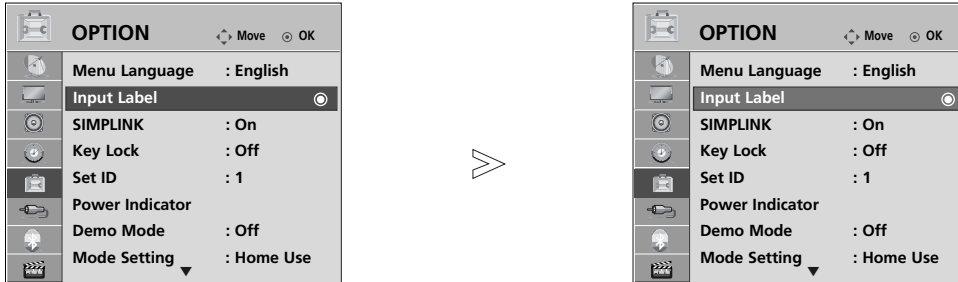

- **TV** : Select it when watching the TV.
- **AV** : Select it when watching the VCR or external equipment.
- **Component** : Select it when using DVD or Digital set-top box depends on connector.
- **RGB** : Select it when using PC depends on connector.
- **HDMI** : Select it when using DVD or Digital set-top box depend on connector.

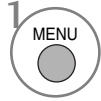
# INPUT LABEL

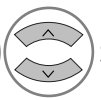
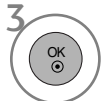
Selects a label for each input source.



- 1   Select **OPTION**.
- 2   Select **Input Label**.
- 3   Select the source.
- 4   Select the label.

- Press the **MENU** button to return to normal TV viewing.
- Press the **RETURN** button to move to the previous menu screen.

# WATCHING TV / PROGRAMME CONTROL



This function operates only with devices with the SIMPLINK logo.  
Please check the SIMPLINK logo.

This TV might not function properly when using it with other products with HDMI-CEC function.  
This allows you to control and play other AV devices connected to the display through HDMI cable without additional cables and settings.

If you do not want SIMPLINK menu, select "Off".

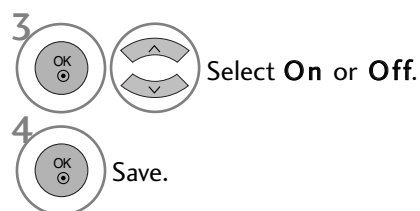
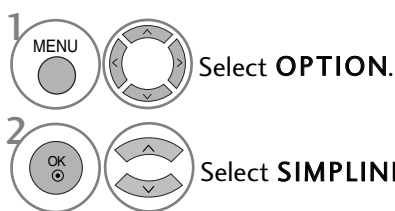
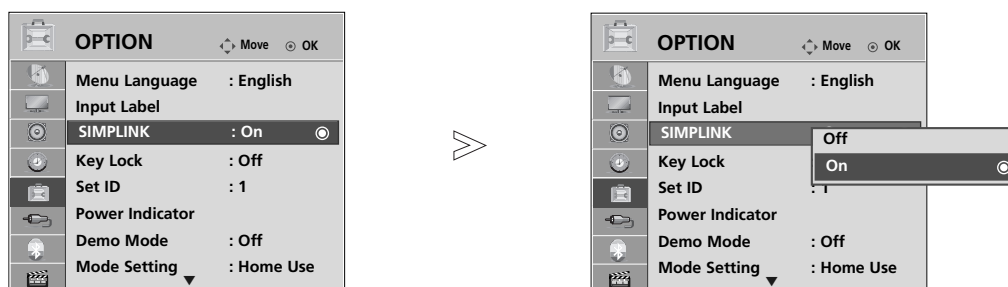

- Press the **MENU** button to return to normal TV viewing.
- Press the **RETURN** button to move to the previous menu screen.

## SIMPLINK Functions

### Disc playback

Control connected AV devices by pressing the  $\wedge$   $\vee$   $\lt$   $\gt$ , OK,  $\blacktriangleright$ ,  $\blacksquare$ ,  $\parallel$ ,  $\ll$  and  $\gg$  buttons.

### Direct Play

After connecting AV devices to the TV, you can directly control the devices and play media without additional settings.

### Select AV device

Enables you to select one of the AV devices connected to the TV and operate it.

### Power off all devices

When you switch off the TV, all connected devices are turned off.

### Switch audio-out

Offers an easy way to switch audio-out.

### Sync Power on

When the equipment with Simplink function connected HDMI terminal starts to play, The TV will change automatically to turn on mode.

\* A device, which is connected to the TV through a HDMI cable but does not support SIMPLINK, does not provide this function.

Note: To operate SIMPLINK, an HDMI cable over Version 1.3 with \*CEC function should be used. (\*CEC: Consumer Electronics Control).



## Connecting to Home Theater with the SIMPLINK logo.

- 1 Connect the **HDMI/DVI IN 1**, **HDMI IN 2** (Except 19/22LH2\*\*\*) or **HDMI IN 3** (Except 19/22/26/32/37/42LH2\*\*, 32/42LF2\*\*, 19/22LU5\*\*) terminal on the back of the TV and the HDMI output terminal of the Home Theater using HDMI cables.
- 2 Connect the Audio output terminal on the back of the TV and the Audio input terminal of the Home Theater using RCA cables.
- 3 Select Home Theater in the Speaker menu by pushing the **SIMPLINK** button.

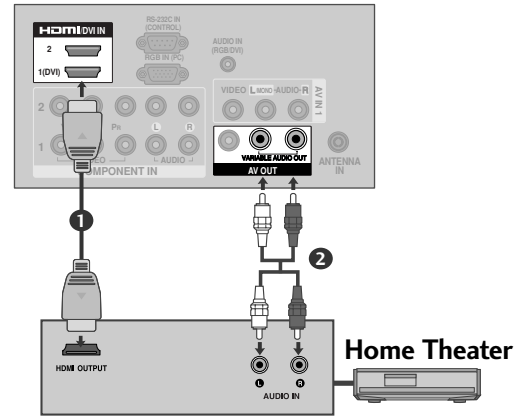

- ▶ When you select or operate a media device with home theater function, the speaker automatically switches to home theater speaker (HT speaker).

### ! NOTE

- ▶ Connect the HDMI/DVI IN or HDMI IN terminal of the TV to the rear terminal and Side terminal (HDMI terminal) of the SIMPLINK device with the HDMI cable.
- ▶ When you switch the Input source using the INPUT button on the remote control, you can stop the operation of a device controlled by SIMPLINK.
- ▶ When the unit is connected to SIMPLINK Home Theater, set to Variable Out and turn off the TV Speaker to operate the Home Theater Speaker. At this time, the maximum volume of the Home Theater Speaker is set to the TV volume.

# WATCHING TV / PROGRAMME CONTROL

## SIMPLINK Menu

Press the  $\wedge$   $\vee$   $\lt$   $\gt$  button and then **OK** button to select the desired SIMPLINK source.

- 1 **TV viewing** : Switch to the previous TV programme regardless of the current mode.
- 2 **DISC playback** : Select and play connected discs. When multiple discs are available, the titles of discs are conveniently displayed at the bottom of the screen.
- 3 **VCR playback** : Play and control the connected VCR.
- 4 **HDD Recordings playback** : Play and control recordings stored in HDD.
- 5 **Audio Out to Home theater/Audio Out to TV:** Select Home theater or TV speaker for Audio Out.

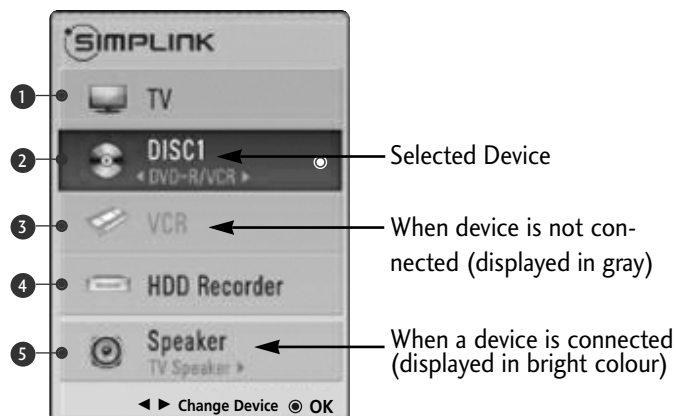







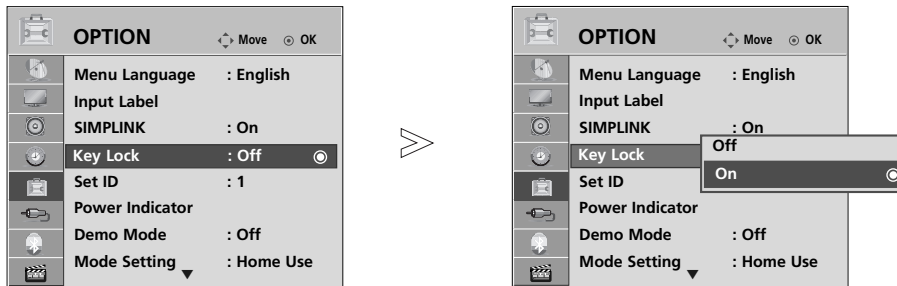

# KEY LOCK

The TV can be set so that the remote control is required to control it. This feature can be used to prevent unauthorized viewing.

This TV is programmed to remember which option it was last set to even if you turn the TV off.



- 1   Select **OPTION**.
- 2   Select **Key Lock**.
- 3   Select **On** or **Off**.
- 4  Save.

- In **Key Lock 'On'**, if the TV is turned off, press the  $\odot$  / I, **INPUT**, **P ▲** or **▼** (or **P ^ v**) button on the TV or **POWER**, **INPUT**, **P ^ v** or **NUMBER** buttons on the remote control then the set will be turned on.
- With the **Key Lock On**, the display ' **Key Lock On**' appears on the screen if any button on the front panel is pressed while viewing the TV.

- Press the **MENU** button to return to normal TV viewing.
- Press the **RETURN** button to move to the previous menu screen.





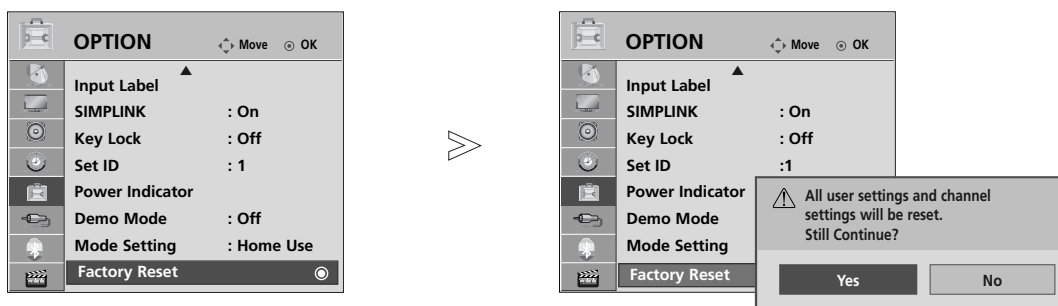

# WATCHING TV / PROGRAMME CONTROL

## INITIALIZING (RESET TO ORIGINAL FACTORY SETTINGS)

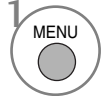
Use to quickly reset all the menu options to their original factory preset values.  
This function deletes all TV programmes.

When the **Factory Reset** is completed, you must restart the Initializing setup.



- 1   Select **OPTION**.
- 2   Select **Factory Reset**.
- 3   Select **Yes**.
- 4  Start **Factory Reset**.

- Press the **MENU** button to return to normal TV viewing.
- Press the **RETURN** button to move to the previous menu screen.

# AV MODE

You can select the optimal images and sounds when connecting AV devices to external input.

- Off** Disables the AV MODE.
- Cinema** Optimizes video and audio for watching movies.
- Sport** Optimizes video and audio for watching sports events.
- Game** Optimizes video and audio for playing games.

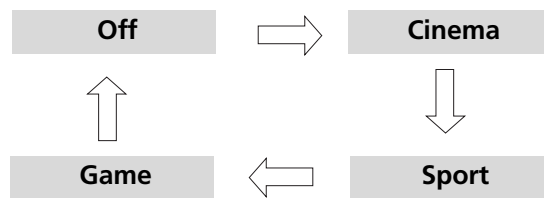

1  Press the **AV MODE** button repeatedly to select the desired source.

2 

- If you select **Cinema** in AV mode, **Cinema** will be selected both for **Picture Mode** and **Sound Mode** in **PICTURE** menu and **AUDIO** menu respectively.
- If you select “**Off**” in **AV mode**, the picture and image which you initially set will be selected.

- Press the **RETURN** button to return to normal TV viewing.

# TO USE THE BLUETOOTH(ONLY 32/37/42/47LH7\*\*\*)

## Bluetooth?

Bluetooth is a short distance networking technology using 2.4 GHz frequency to connect various types of information devices such as computers, cell phones and PDAs, as well as digital appliances through wireless connection, without having to connect any cable, to enable data exchange.

With the Bluetooth communication function, you can connect the Bluetooth enabled wireless headset or receive images(only JPEG), listen to music from the Bluetooth enabled cell phone using this TV.

- Communication Spec.: Bluetooth Specification Version 2.0 + EDR (Enhanced Data Rate)
- Output: Bluetooth Specification Power Class 2
- Maximum Communication Range: Line of open sight approx. 10m (30 ft)
- Frequency Band: 2.4 GHz band (2.4 GHz ~ 2.4835 GHz)
- Bluetooth Module: RBFS-C921A
- Compatible Bluetooth Profile: A2DP (Advanced Audio Distribution Profile)  
OPP (Object Push Profile)  
GAVDP (Generic Audio/Video Distribution Profile)  
HSP (Headset Profile)

CE0700

FCC ID: BEJRBFS-C921A

## Precautions when using the Bluetooth

- ▶ Use within 10m(-45° ~ 45°) range.  
If you use the device out of the range or within the range with obstacles, it can result in communication error.
- ▶ Communication error can occur depending on the surrounding devices.
- ▶ Products using the same frequency of 2.4 GHz (Wireless LAN, microwave oven etc.), can cause communication error by using the same frequency bandwidth.
- ▶ The device search time differs depending on the number of Bluetooth devices and the operating situation.
- ▶ The probability of search increases with less number of devices.
- ▶ Electromagnetic wave can be interfered with applicable wireless devices.
- ▶ Because applicable wireless devices have the possibility of electromagnetic wave interference, they cannot provide services related to human life.
- ▶ You can only connect one Bluetooth device at a time.
- ▶ You cannot receive photos(only JPEG) or listen to music from other Bluetooth devices while using the Bluetooth headset.
- ▶ For details of Bluetooth, refer to the user manual of the Bluetooth device.
- ▶ USB (Photo List, Music List, Movie List) and Bluetooth will not be supported at the same time.
- ▶ Operation is subject to the following two conditions : (1) This device may not cause (harmful) interference, and (2) this device must accept any interference received, including interference that may cause undesired operation (of the device).

QDID(Qualified Design Identity) : B015112

# SETTING THE BLUETOOTH





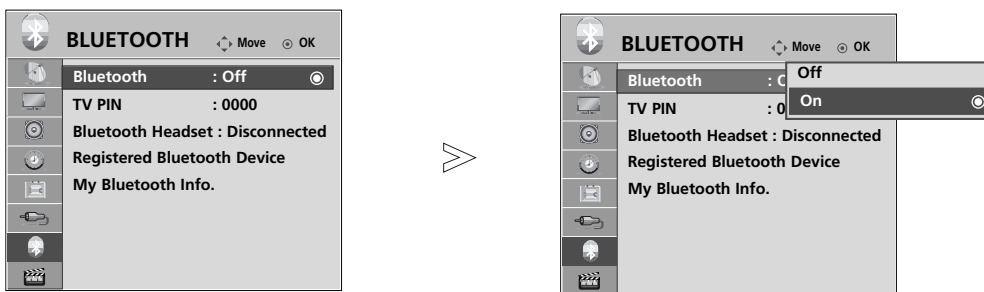

If you want to listen to the broadcasted sound using the Bluetooth headset or receive the jpeg images from an external device and view them on the TV, listen to music from cell phone(Bluetooth device), you can use the wireless communication without having to connect any cables.

You can use the BLUETOOTH menu by selecting “On”.

If you do not want to use the Bluetooth function, select “Off”.

If it is connected to the external Bluetooth device, you can select “Off” after disconnecting the device.



- 1   Select **BLUETOOTH**.
- 2   Select **Bluetooth**.
- 3   Select **On** or **Off**.
- 4  Save.

- Press the **MENU** button to return to normal TV viewing.
- Press the **RETURN** button to move to the previous menu screen.

# TO USE THE BLUETOOTH





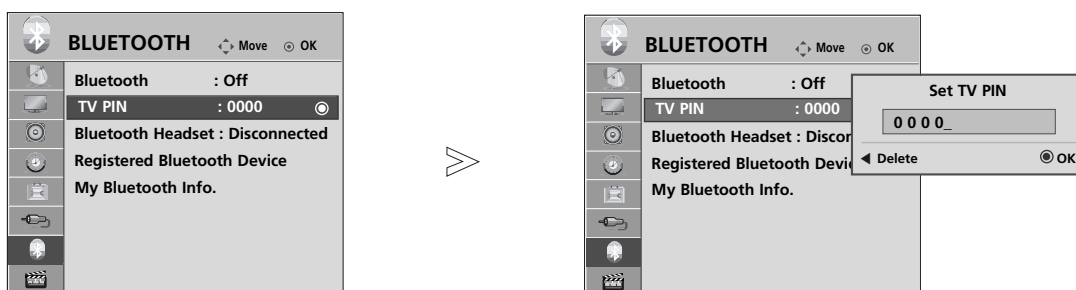

## SET TV PIN

To accept connection from an external Bluetooth device or to connect to an external Bluetooth device, the PIN needs to be entered.

For details on how to set the PIN of the external Bluetooth device, refer to the user manual of the applicable device.

The TV PIN is composed of numbers of up to 10 digits.  
The TV PIN must have more than 1 digit.



- 1   Select **BLUETOOTH**.
- 2   Select **TV PIN**.
- 3   Select the desired PIN number.
- 4 

- The default TV PIN number is '0,0,0,0', and it can be changed by the user.
- Press the < button to delete digits one by one.

- Press the **MENU** button to return to normal TV viewing.
- Press the **RETURN** button to move to the previous menu screen.



## BLUETOOTH HEADSET

When you select the Bluetooth headset, you can listen to the TV sound in the Bluetooth headset through wireless communication.

You must pair it with any new Bluetooth device before the first use. For details, refer to the user manual of the applicable device. A maximum of 12 devices can be paired.





When the unit is searching for the Bluetooth headset, other buttons except for the “Stop” (OK button) do not work.

### Connecting a new Bluetooth headset

You can only search for the new Bluetooth headset only in the **Disconnected** condition.

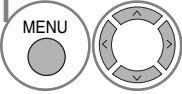
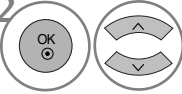
When you run the search, it will show you the list of all Bluetooth headsets responding.

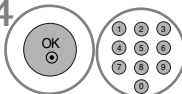

After new Bluetooth device is searched, the PIN number is validated to connect the device. For details, refer to the user manual of the applicable device.

- 1  Select **BLUETOOTH**.
- 2  Select **Bluetooth Headset**.
- 3  Search the Bluetooth headset.
- 4  Select Bluetooth headset PIN number. Refer to the user manual of the applicable device for the PIN number.
- 5  Connect the Bluetooth headset.

### Connecting to Bluetooth headset already registered

Bluetooth headsets are listed in the order most recently used with the headset currently in use listed at the top.

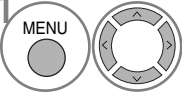
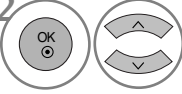
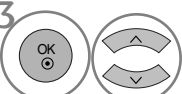
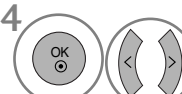
When connecting to the Bluetooth device already registered, you can select and connect directly without any PIN validation.

- 1  Select **BLUETOOTH**.
- 2  Select **Bluetooth Headset**.
- 3  Select the desired Bluetooth headset.
- 4  Message asking to connect the selected Bluetooth headset will be displayed. Select **Yes** or **No**.
- 5  Connect the Bluetooth headset.

- After connecting/using the Bluetooth headset, the headset setting will be the **Disconnected** condition automatically when you turn off the power of the TV and then turn on.
- After connecting the Bluetooth headset, the TV speaker is switched to Mute condition and the sound will only be generated from the headset.

# TO USE THE BLUETOOTH

## Disconnecting the Bluetooth headset during use

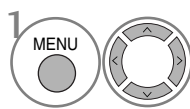
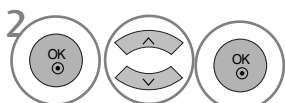
-  Select **BLUETOOTH**.
-  Select **Bluetooth Headset**.
-  Disconnect the Bluetooth headset.

## When requesting to connect to TV from the Bluetooth headset

When the Bluetooth menu is "On" and there is a connection request from the headset, this message is displayed.

Not all headsets support this feature. (Refer to the user manual of the applicable Bluetooth headset.)

Some headset types may make an attempt at connection when they are turned on/off even though they are not included in the Registered Device list.

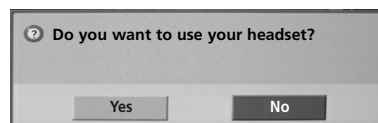

-  Select **Yes** or **No**.

### ! NOTE

- ▶ LG recommends the following headset models. (Model name : Sony Ericsson(HBH-DS980), Motorola(S9), Motorola(S605), Jabra(BT620S))
- ▶ The stereo/mono headset officially certified to be Bluetooth compatible can be searched and connected.
- ▶ The stereo/mono headset that supports the A2DP or HSP function among the Bluetooth devices can be connected.
- ▶ If the surrounding environment of the TV is as follows, the device may not be searched or connected properly.
  - If there is strong electromagnetic wave.
  - If there are many Bluetooth devices.
  - If the headset is turned off, not in place or has an error.
  - Because products such as microwave oven, wireless LAN, plasma light, gas range etc., use the same frequency range, it can cause communication error.
- ▶ Only one Bluetooth headset can be connected at once.
- ▶ Connection that is lost due to the TV being turned off etc. will not be automatically recovered. Try connecting the applicable device again.
- ▶ Some operations can be slower while operating the headset.
- ▶ Even if you choose simplink Home Theater after using the headset during Simplink operation, the unit will not automatically switch to Home Theater speakers.
- ▶ When the headset connection continuously fails, pair the device one more time.
- ▶ The audio quality of mono headsets will not be as good as that for stereo headsets.
- ▶ Mono headsets may suffer from noise as the distance from the TV increases, because they use a different transmission method compared with stereo headsets.
- ▶ When a Bluetooth headset is in use, the Volume +/- and Mute keys do not work, and the Audio menu returns to the default value and is disabled.

# MANAGING REGISTERED BLUETOOTH DEVICE

If there are no devices registered, Registered Bluetooth Device menu will be deactivated and cannot be used.

An additional device after registration of 12 devices deletes the existing list as stored order.

Bluetooth device names may be up to 14 characters long; the name will be truncated if more characters are used.

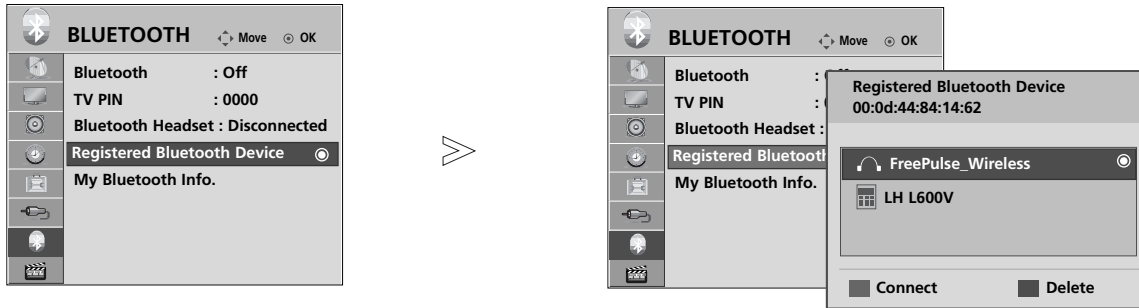

- 1 Select **BLUETOOTH**.
- 2 Select **Registered Bluetooth Device**.
- 3 Check the registered Bluetooth device.

## ■ Connecting the registered Bluetooth headset

- 1 Select the registered Bluetooth headset you want to connect.
- 2 **BLUE** Message asking to connect the selected Bluetooth headset will be displayed.
- 3 Select **Yes** or **No**.

## ■ Deleting registered Bluetooth device

"Delete" will be available when selecting the device that is not connected to the TV.

- 1 Select the Bluetooth device you want to remove.
- 2 **RED** Message asking to delete the selected Bluetooth device will be displayed.
- 3 Select **Yes** or **No**.

## ■ Disconnecting registered Bluetooth device

"Disconnect" will be available when selecting the device that is connected to the TV.

- 1 Select the Bluetooth device that is currently connected to the TV.
- 2 **BLUE** Disconnect the Bluetooth device.





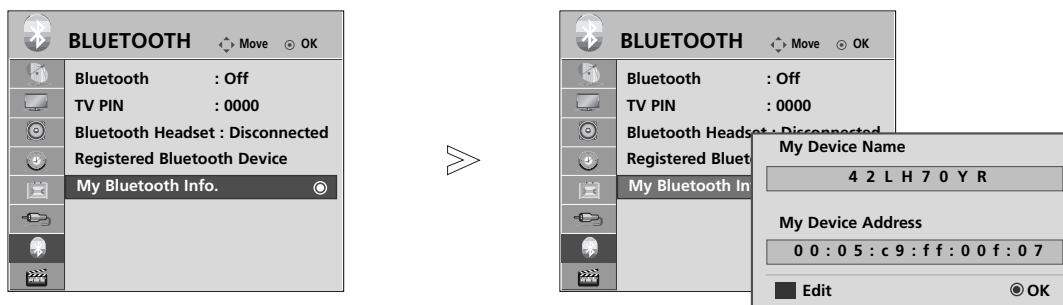

# TO USE THE BLUETOOTH

## MY BLUETOOTH INFORMATION

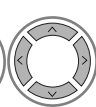
This function provides the My Bluetooth Information to the user.  
"Edit" will be available when TV is not connected with any device.

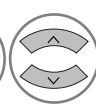
You can edit the My Device Name.  
You can check the My Device Address.

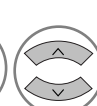

- 1   Select **BLUETOOTH**.
- 2   Select **My Bluetooth Info..**
- 3     You can use an the alphabet **A** to **Z**, the number **0** to **9**, **+/-**, and blank.
- 4  Save.

- Press the **MENU** button to return to normal TV viewing.
- Press the **RETURN** button to move to the previous menu screen.

## RECEIVING PHOTOS FROM EXTERNAL BLUETOOTH DEVICE

For details on how to send photos(only JPEG) from the external Bluetooth device to TV, refer to the user manual of the applicable device.

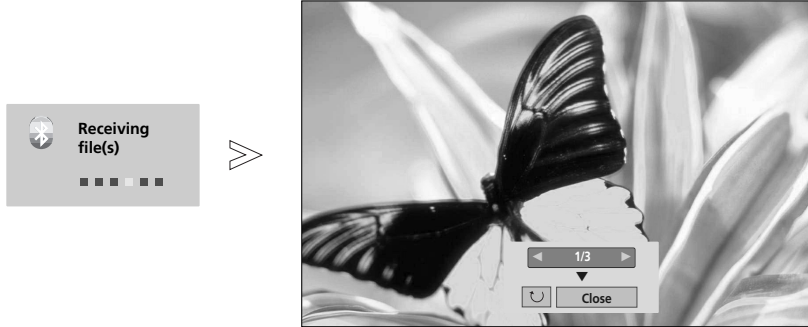

- When you select **Close** with the  $\wedge \vee < >$  button, the OSD will disappear. And when you press the OK button again, it will appear again.



Select the desired photos.

 **(Rotate)** : Rotate photos.

- Rotates the photo 90° clockwise upon **OK** button on  **(Rotate)**.

- The maximum accumulated size of the image(s) that can be received is 8MBytes.
- You cannot receive the image(s) while using the Bluetooth headset.
- You cannot receive the image(s) while listening to music from Bluetooth device.
- When the external Bluetooth device is currently sending the photo, press the **RETURN** button to stop receiving the photo. All photos already received will be deleted as a result.
- With some Bluetooth devices, you may not be able to transmit an image (JPEG) file to the TV set.
- When you send photos via Bluetooth, the memory capacity supports up to 8M and 64 photos.

## LISTENING TO THE MUSICS FROM EXTERNAL BLUETOOTH DEVICE

For details on how to listen to the musics from the external Bluetooth device to TV, refer to the user manual of the applicable device.

You should use the Bluetooth device supporting A2DP(as external device)

- With some Bluetooth devices, you may not be able to listen to music via the TV speaker system.

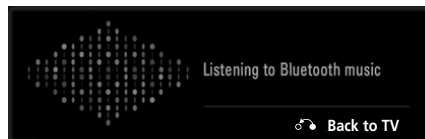

- Press the  $\triangleleft$  + or - button to adjust the volume.
- If you wish to switch the sound off, press the MUTE button.
- Press the **RETURN** button to return to normal TV viewing.

### ! NOTE

- ▶ You cannot listen to music while using the Bluetooth headset.
- ▶ You cannot listen to music while receiving image(s).
- ▶ If you use Bluetooth to listen to music, the Variable/Monitor out(the TV Audio out) does not work.

# TO USE A USB DEVICE

(EXCEPT 19/22/26/32/37/42LH2\*\*\*, 32/42LF2\*\*\*, 19/22/26LU5\*\*\*)

## When connecting the USB device

When you connect a USB device, this pop up menu is displayed, automatically.

“POP UP MENU” will not be displayed while the OSD including Menu is activated or while the Bluetooth Headset is connected.

In USB device, you can not add a new folder or delete the existing folder.

■ Here shown may be somewhat different from your TV.

- 1 Connect the USB device to the **USB IN** jack on the TV.

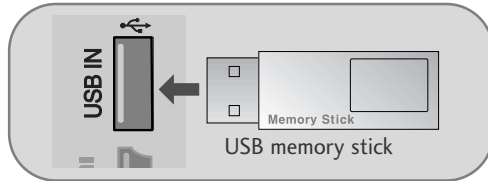

- 2 Select **PHOTO LIST**, **MUSIC LIST** or **MOVIE LIST**.



- 3

• This TV Supports on JPEG, MP3 and SD Divx.

## When removing the USB device

Select the USB device menu before removing the USB device.

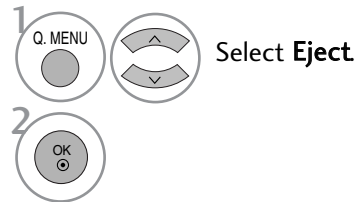

## Precautions when using the USB device

- ▶ Only a USB storage device is recognizable.
- ▶ If the USB storage device is connected through a USB hub, the device is not recognizable.
- ▶ A USB storage device using an automatic recognition programme may not be recognized.
- ▶ A USB storage device which uses its own driver may not be recognized.
- ▶ The recognition speed of a USB storage device may depend on each device.
- ▶ Please do not turn off the TV or unplug the USB device when the connected USB storage device is working. When such device is suddenly separated or unplugged, the stored files or the USB storage device may be damaged.
- ▶ Please do not connect the USB storage device which was artificially maneuvered on the PC. The device may cause the product to malfunction or fail to be played. Never forget to use only a USB storage device which has normal music files, image files or movie files.
- ▶ Please use only a USB storage device which was formatted as a FAT16, FAT32, NTFS file system provided with the Windows operating system. In case of a storage device formatted as a different utility programme which is not supported by Windows, it may not be recognized.  
Data in a USB storage device cannot be deleted in the NTFS file system.
- ▶ Please connect power to a USB storage device which requires an external power supply. If not, the device may not be recognized.
- ▶ Please connect a USB storage device with cable is offered by USB maker. If connected with cable is not offered by USB maker or an excessively long cable, the device may not be recognized.
- ▶ Some USB storage devices may not be supported or operated smoothly.
- ▶ Please back up the important file because a data of USB device may be damaged. Data management is consumer's responsibility and in consequence the manufactures does not cover the product bearing data damage.
- ▶ Maximum of 999 files and folders can be recognized.
- ▶ Data in a USB storage device cannot be aligned.
- ▶ Up to 128 English characters can be recognized as a file name.
- ▶ If the USB is connected in Standby Mode, specific hard disk will automatically be loaded when the TV is turned on.
- ▶ The recommended capacity is 1 TB or less for a USB external hard disk and 32GB or less for USB memory.
- ▶ Any device with more than the recommended capacity may not work properly.
- ▶ If a USB external hard disk with a "Energy Saving" function does not work, turn the hard disk off and on again to make it work properly.
- ▶ When using a USB HDD via the USB extension cable, connect a support electric power source.

# PHOTO LIST

The On Screen Display may be different from your TV. Images are an example to assist with the TV operation.

**PHOTO(\*.JPEG) supporting file**

Baseline: Max 4800 x no limit  
Min : 32x32

- Not support to progressive Jpeg
- You can play JPEG files only.
- Only baseline scan is supported among JPEG (SOF0, SOF1 only).
- Non-supported files are displayed in the form of bitmap.

## Screen Components

1

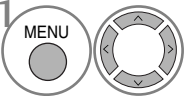

Select **USB**.

2

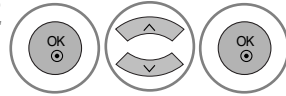

Select **PHOTO LIST**.

- ❶ Moves to upper level folder
- ❷ Current page/Total pages
- ❸ Total number of marked photos
- ❹ Corresponding buttons on the remote control



The screenshot shows a 'PHOTO LIST' interface. At the top, it says 'Page 2/3' and 'No Marked'. On the left, there's a preview of a photo labeled 'JM001' with dimensions '1366x768, 125KB' and an 'Up Folder' button. On the right, there's a list of folders and files: 'Up Folder', 'KY101-105', and 'JM001-008'. At the bottom, there's a navigation bar with buttons for 'Navigation', 'OPTION', 'Page Change', 'MARK Mark', and 'Exit'.

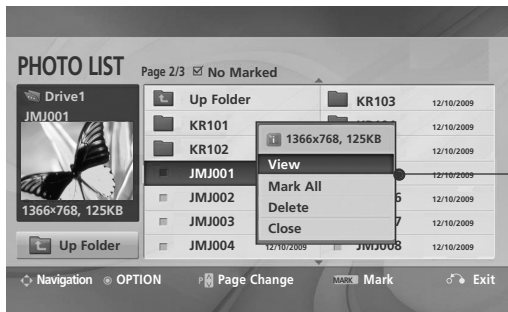
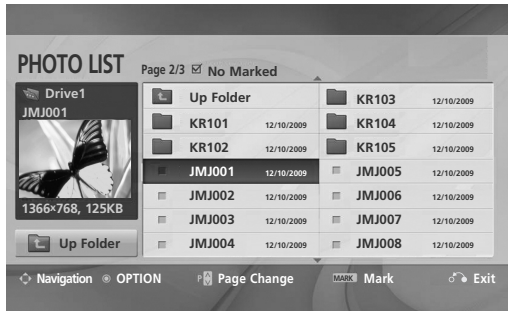

# TO USE A USB DEVICE

## Photo Selection and PopUp Menu

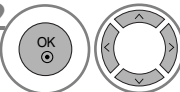

- ▶ **View** : Display the selected item.
- ▶ **Mark All** : Mark all photos on the screen.
- ▶ **Unmark All** : Deselect all marked photos.
- ▶ **Delete** : Delete the selected photo item.
- ▶ **Close** : Close the pop-up menu.

TO USE A USB DEVICE

- 1  Select the target folder or drive.
- 2  Select the desired photos.
- 3  Show the PopUp menu.
- 4  Select the desired PopUp menu.

- Use the **P** ^ v button to navigation in the photo page.
- Use the **MARK** button to mark or unmark a photo. When one or more photos are marked, you can view individual photos or a slide show of the marked photos. If no photos are marked, you can view all photos individually or all photos in the folder in a slide show.







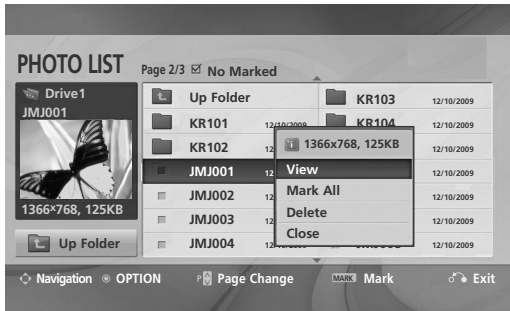
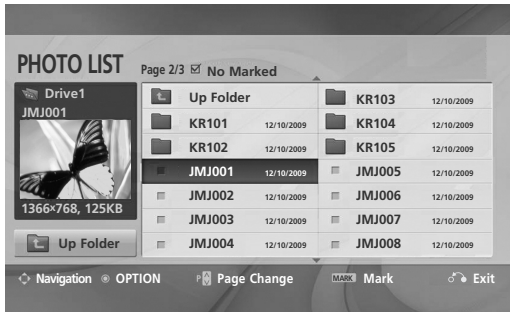

## Set up the menu in Full-Sized Screen

You can change the settings to display photos stored on a USB device, on a full-sized screen. Detailed operations are available on full-sized photo view screen.



The aspect ratio of a photo may change the size of the photo displayed on the screen in full size. Press the **RETURN** button to move to the previous menu screen.

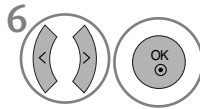
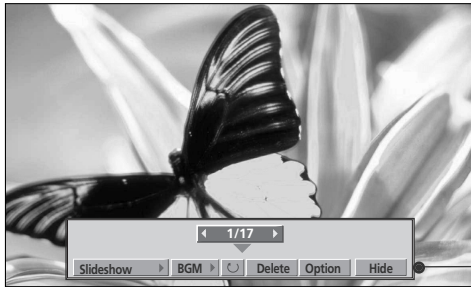

- 1  Select the target folder or drive.
- 2   Select the desired photos.
- 3  Show the PopUp menu.
- 4  Select **View**.
- 5  The selected photo is displayed in full size.

# TO USE A USB DEVICE



6 Select the **Slideshow**, **BGM**,  (**Rotate**), **Delete**, **Option** or **Hide**.

- Use < > button to select the previous or next photo.
- Use < > button to select and control the menu on the full-sized screen.

- ▶ **Slideshow** : When no picture is selected, all photos in the current folder are displayed during slide show. When selected, the selected photos are displayed during slide show.
  - Set the time interval of the slide show in **Option**.
- ▶ **BGM** : Listen to music while viewing photos in full size.
  - Set the BGM device and album in **Option**.
- ▶  (**Rotate**) : Rotate photos.
  - Rotates the photo 90°, 180°, 270°, 360° clockwise.
- ▶ **Delete** : Delete photos.
- ▶ **Option** : Set values for **Slide Speed** and **Music Folder**.
  - Use ^ v < > button and **OK** button to set values. Then go to  and press **OK** to save the settings.
  - You cannot change **Music Folder** while BGM is playing.
- ▶ **Hide** : Hide the menu on the full-sized screen.
  - To see the menu again on the full-sized screen, press **OK** button to display.

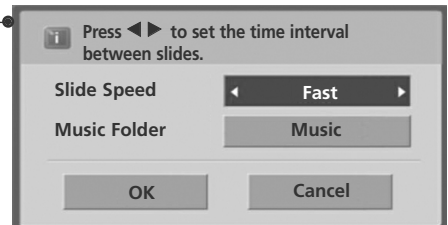

# MUSIC LIST

Purchased music files(\*.MP3) may contain copyright restrictions. Playback of these files may not be supported by this model.

Music file on your USB device can be played by this unit.

The On Screen Display may be different from your TV. Images are an example to assist with the TV operation.

**MUSIC (\*.MP3) supporting file**  
 Bit rate : 32k ~ 320kbps  
 Sampling rate MPEG1 layer 3: 32k ~ 48kHz

## Screen Components

**1**

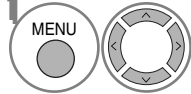

Select **USB**.

**2**



Select **MUSIC LIST**.

- 1** Moves to upper level folder
- 2** Current page/Total pages
- 3** Total number of marked music title
- 4** Corresponding buttons on the remote control



Title	Duration
Up Folder	
Favorite Music	
Favorite Music No.2	
Velvet Goldmine (OST vers2)	1:34
Good Bye (Original Ver.)	1:15
Urban Nite (Feat.Amin,J)	1:20

# TO USE A USB DEVICE

## Music Selection and PopUp Menu

As shown, up to 6 music titles are listed per page.

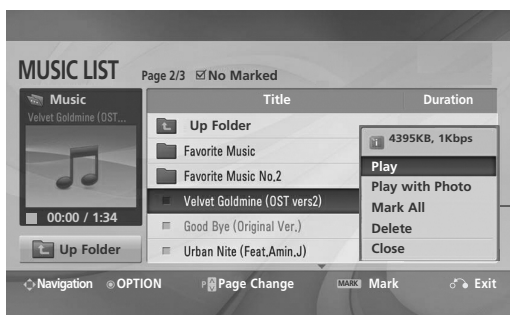
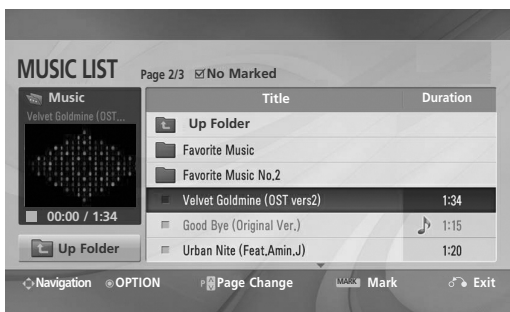

▶ **Play** (During stop) : Play the selected music titles.

Once a music finished playing, the next selected one will be played. When there are no selected music titles to play, the next one in the current folder will be played.

▶ **Play Marked** : Play the selected music titles. Once a music finishes playing, the next selected one will be played automatically.

▶ **Stop Play** (During playback) : Stop the playing music titles.

▶ **Play with Photo** : Start playing the selected music titles and then move to the Photo List.

▶ **Mark All** : Mark all music titles in the folder.

▶ **Unmark All** : Deselect all marked music titles.

▶ **Delete** : Delete the selected music titles.

▶ **Close** : Close the pop-up menu.

1 Select the target folder or drive.

2 Select the desired music title.

3 Show the PopUp menu.

4 Select the desired PopUp menu.

- Use the **P** ^ v button to navigation in the music page.
- Use **MARK** button to mark or unmark a music. When one or more music files are marked, the marked music title will be played in sequence. For example, if you want to listen to only one music repeatedly, just mark the music only and play it. If no music is marked, all the music in the folder will be played in sequence.

- If you don't press any button for a while during the playing, the play information box (as shown in the below) will float as a screen saver.

- The 'Screen Saver'?

Screen saver is to prevent screen pixel damage due to an fixed image remaining on the screen for a extended period of time.



## ! NOTE

- ▶ When music is playing, 🎵 is displayed in back of the music title.
- ▶ A damaged or corrupted music does not play but displays 00:00 in playtime.
- ▶ A music downloaded from a paid service with copyright protection does not start but displays inappropriate information in playtime.
- ▶ If you press **OK**, **■** buttons, screen saver is stopped.
- ▶ This TV can not play music files less than 32 Kbytes.
- ▶ The **PLAY(▶)**, **Pause(II)**, **■**, **▶▶**, **◀◀** buttons on the remote control are also available in this mode.
- ▶ You can use the **▶▶** button to select the next music and the **◀◀** button to select the previous music.

# TO USE A USB DEVICE

## MOVIE LIST

The movie list is activated once USB is detected. It is used when playing movie files on TV.

Displays the movies in the USB folder and supports Play.

Allows playback of all movies in the folder and user desired files.

Editing such as delete and add is not allowed.

It is a movie list that displays folder information and Divx file.

Supports up to four drives.

MOVIE(\*.avi/\*.Divx) supporting file

Video format : MPEG1 , MPEG2, MPEG4(Doesn't support Microsoft MPEG4-V2, V3), DivX 3.xx , DivX 4.xx, DivX 5.xx , DivX VOD ( DRM ), XviD, Divx 6.xx(Playback)

Audio format : Mpeg, Mp3, PCM, Dolby Digital, AC3

Sampling frequency : 32k ~ 48kHz

Bit rate : 32k ~ 320kbps

Subtitle format : \*.smi/ \*.srt/ \*.sub(MicroDVD, SubViewer 2.0)/ \*.ass/ \*.ssa/\*.txt(DVD Subtitle System)

- DivX may not be played depending on its types or recording methods.
- If the video and audio structure of recorded file is not interleaved, either video or audio is outputted.
- **Max bitrate of playable DivX file is 6Mbps.**
- Maximum FPS (Frame Per Second) can be reached only at SD level. FPS is 25 FPS (720\*576) or 30 FPS (720\*480) depending on Resolution.
- Time information in an external subtitle file should be arranged in ascending order to be played.
- Files of 25 FPS or 30 FPS of higher may not be played properly.
- If the file is recorded with GMC, the unit supports only 1 point of recorded level.  
(GMC is the acronym for Global Motion Compensation, a technique used to compensate MPEG Video files.)
- A video file name and its subtitle file name must be identical for it to be displayed.
- A DivX movie file and its subtitle file must be located in the same folder.
- Use the left/right ( < / > ) keys to move to a specific frame forward or backward while playing a movie.  
(The left/right ( < / > ) keys may not work properly for some files while playing a movie.)
- Playing a video via a USB connection that does not support high speed may not work properly.
- USB storage devices below USB 2.0 are supported as well. But they may not work properly in the movie list.

File Extension name	Video Codec	Audio Codec	Resolution
mpg, mpeg, mpe, vob, dat	MPEG1, MPEG2	AC3,MPEG,MP3,PCM	
Avi, divx, m4v	MPEG 4-SP, MPEG4-ASP, Divx 3.xx,Divx 4.xx, Divx 5.xx, Divx 6.xx(Playback), Xvid	AC3,MPEG,MP3,PCM	720x576@25p 720x480@30p

# Screen Components

**1** MENU Select **USB**.

**2** Select **MOVIE LIST**.

- 1 Moves to upper level folder
- 2 Current page/Total pages
- 3 Total number of marked movies
- 4 Corresponding buttons on the remote control

## Movie Selection and PopUp Menu

As shown, up to 6 movie titles are listed per page.

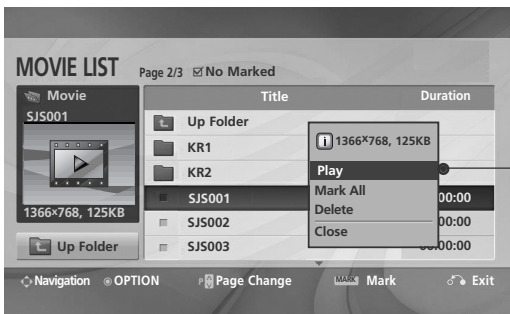
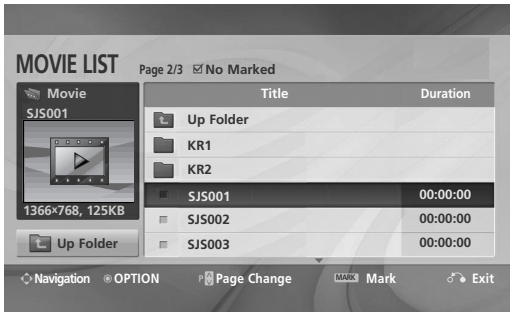

- ▶ **Play** : Play the selected movie titles. Divx Play is executed while screen changes.
- ▶ **Play Marked** : Play the selected movie titles. Once a music finishes playing, the next selected one will be played automatically.
- ▶ **Stop Play (During playback)** : Stop the playing movie titles.
- ▶ **Mark All** : Mark all movie titles in the folder.
- ▶ **Unmark All** : Deselect all marked movie titles.
- ▶ **Delete** : Delete the selected movie titles.
- ▶ **Close** : Close the pop-up menu.

**1** Select the target folder or drive.

**2** Select the desired movie.

**3** Show the PopUp menu.

**4** Select the desired PopUp menu.

• In the case of files not supported, a message regarding non-supported file is displayed.

# TO USE A USB DEVICE

## DivX Audio Language & Subtitle Language

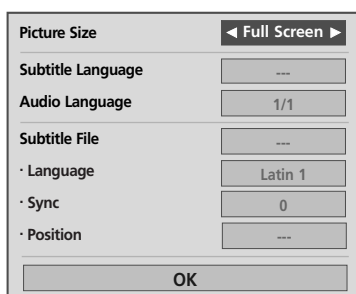

language	Latin1	French, Spanish, Catalan Basque, portuguese, Italian, Albanian, Rhaeto-Romanic, Dutch, German, Danish, Swedish, Norwegian, Finnish, Faroese, Icelandic, Irish, Scottish, English
	Latin2	Czech, Hungarian, Ploish, Romanian, Croatian, Slovak, Slovenian, Sorvian
	Latin4	Estonian, the Baltic languages Latvian(Lettish) and Lithuanian, Greenlandic and Lappish
	Latin5	English, Trukish
	Cyrillic	Bulgarian, Byelorussian, Macedonian, Russian, Serbian and pre-1990 (no ghe with upturn) Ukrainian
	Greek	English, modern Greek
	Hebrew	English, modern Hebrew
	Chinese	Chinese
	Thai	Thai
	Arabic	English, Arabic



1 Select the desired option.

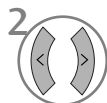

2 Select **Picture Size**, **Subtitle Language**, **Audio Language**, **Subtitle File**, **Language**, **Sync** or **Position**.

• When DivX is playing, if you press the **RED** button, this message is displayed.

- Press the **MENU** button to return to normal TV viewing.
- Press the **RETURN** button to move to the previous menu screen.

## Using the remote control

◀◀ / ▶▶	<p>When playing,</p> <p>repeatedly, press the <b>REW</b>(◀◀) button to speed up ◀◀ -&gt; ◀◀◀◀ -&gt; ◀◀◀◀◀◀ -&gt; ◀◀◀◀◀◀◀◀ -&gt; ◀◀◀◀◀◀◀◀◀◀◀◀.</p> <p>repeatedly, press the <b>FF</b>(▶▶) button to speed up ▶▶ -&gt; ▶▶▶▶ -&gt; ▶▶▶▶▶▶ -&gt; ▶▶▶▶▶▶▶▶.</p> <ul style="list-style-type: none"> <li>▪ Pressing these buttons repeatedly increases the fast forward/reverse speed.</li> </ul>
	<p>During playback, press the <b>Pause</b>(  ) button.</p> <ul style="list-style-type: none"> <li>▪ Still screen is displayed.</li> </ul>
< >	<ul style="list-style-type: none"> <li>▪ When using the &lt; or &gt; button during playback a cursor indicating the position can be viewed on the screen.</li> </ul>
PLAY(▶)	<p>Press the <b>PLAY</b>(▶) button to return to normal playback.</p>





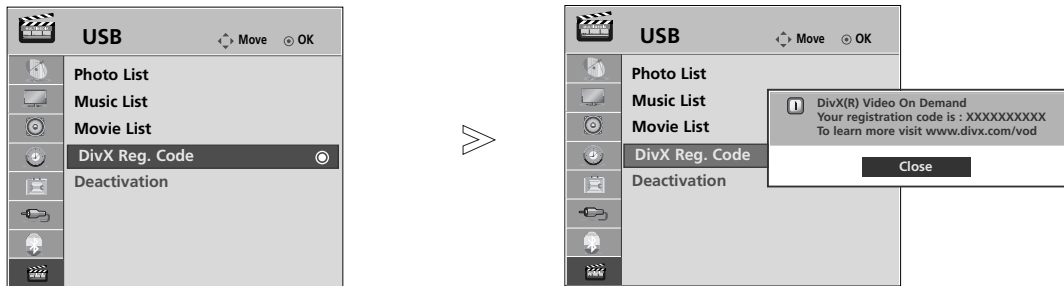

# DIVX REGISTRATION CODE

Confirm the DivX registration code number of the TV. Using the registration number, movies can be rented or purchased at [www.divx.com/vod](http://www.divx.com/vod).

With a DivX registration code from other TV, playback of rented or purchased DivX file is not allowed. (Only DivX files matched with the registration code of the purchased TV are playable.)



- 1   Select **USB**.
- 2   Select **DivX Reg. Code**.
- 3  Display **DivX Reg. Code**.

- Press the **MENU** button to return to normal TV viewing.
- Press the **RETURN** button to move to the previous menu screen.



- Official DivX® Certified Product
- Plays all version of DivX® video (including DivX® 6) with standard playback of DivX® media files
- “DivX Certified products: “DivX, DivX Certified, and associated logos are trademarks of DivX, Inc. and are used under license.”

## ! NOTE

### Supported movie file

Resolution : under 720x480(720x576) WxH pixels.  
Frame rate : under 30 frames/sec

- ▶ Video Codec : MPEG1, MPEG2, MPEG4(Doesn't support Microsoft MPEG4-V2, V3), DivX3.xx, DivX4.xx, DivX5.xx, DivX VOD(DRM), XviD.
- ▶ When loading, some buttons may not work.
- ▶ If you use the DivX registration code of another device, the rented or purchased DivX file cannot be played. Therefore always use the DivX registration code assigned to this product.

# TO USE A USB DEVICE

## DEACTIVATION

Delete the existing authentication information to receive a new DivX user authentication for TV.  
Once this function is executed, a DivX user authentication is required again to see DivX DRM files.



1 MENU Select **USB**.

2 OK Select **Deactivation**.

3 OK Select **Yes**.

4 OK

- Press the **MENU** button to return to normal TV viewing.
- Press the **RETURN** button to move to the previous menu screen.

# PICTURE CONTROL

## PICTURE SIZE (ASPECT RATIO) CONTROL

You can watch the screen in various picture formats; **16:9**, **Just Scan**, **Original**, **4:3**, **14:9**, **Zoom** and **Cinema Zoom**.

If a fixed image is displayed on the screen for a long time, that fixed image may become imprinted on the screen and remain visible.

1   Select **Aspect Ratio**.

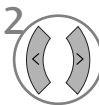
2  Select the desired picture format.

- You can also adjust **Aspect Ratio** in the **PICTURE** menu.
- For Zoom Setting, select **14:9**, **Zoom** and **Cinema Zoom** in Q.Menu or select **Cinema Zoom** in PICTURE menu.

### • 16:9

The following selection will allow you to adjust the picture horizontally, in linear proportion, to fill the entire screen (useful for viewing 4:3 formatted DVDs).

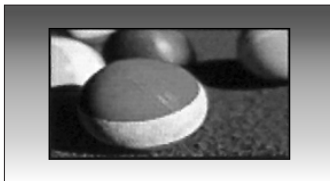

### • Original

When your TV receives a wide screen signal it will automatically change to the picture format broadcast.

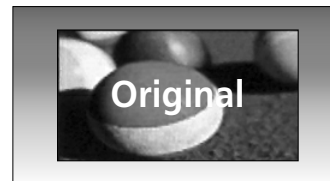

### • Just Scan

Following Selection will lead to you view the picture of best quality without loss of original picture in high resolution image.

Note : If there is noise in original Picture, You can see the noise at the edge.



### • 4:3

The following selection will allow you to view a picture with an original 4:3 aspect ration, black bars will appear on both the left and right of the screen.



# PICTURE CONTROL

## • 14:9

You can view a picture format of 14:9 or a general TV programme in the 14:9 mode. The 14:9 screen is viewed in the same way as in 4:3, but is magnified to the left and right.



## • Zoom

The following selection will allow you to view the picture without any alteration, while filling the entire screen. However, the top and bottom of the picture will be cropped.



## • Cinema Zoom

Choose Cinema Zoom when you wish the picture to be altered, both horizontally extended and vertically cropped. The picture adopting a compromise between alteration and screen coverage.

The adjustment range is 1-16.

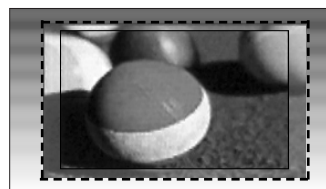

## ! NOTE

- ▶ You can only select **4:3**, **16:9 (Wide)**, **14:9**, **Zoom**, **Cinema Zoom** in Component, HDMI mode.
- ▶ You can only select **4:3**, **16:9 (Wide)** in RGB mode only.
- ▶ In HDMI/Component (over 720p) mode, **Just Scan** is available.

## ENERGY SAVING

It reduces the TV's power consumption by adjusting backlight level.

The default factory setting complies with the Energy Star requirements and is adjusted to the comfortable level to be viewed at home.

You can increase the brightness of your screen by adjusting the Energy Saving level or by setting the Picture Mode.

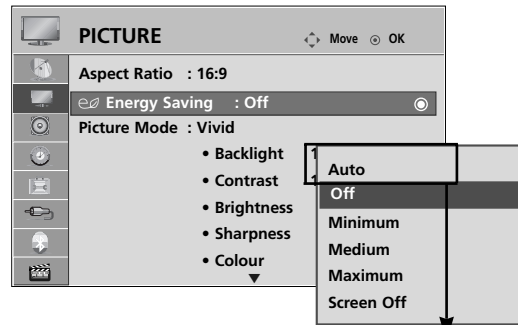
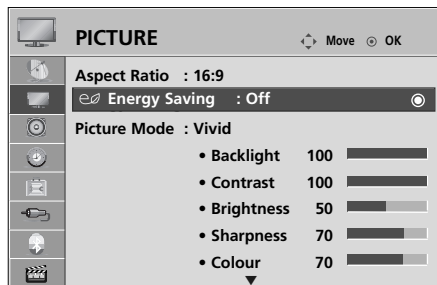

(Except 19/22/26/32/37/42LH2\*\*\*, 32/42LF2\*\*\*, 32/37/42/47LH3\*\*\*, 19/22/26LU5\*\*\*)

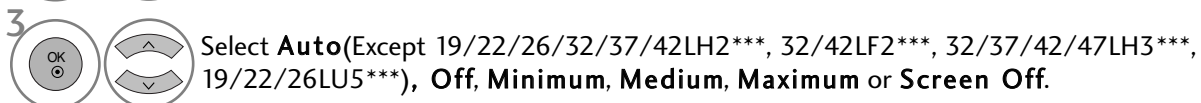

- Press the **MENU** button to return to normal TV viewing.
- Press the **RETURN** button to move to the previous menu screen.

- When selecting Screen Off, the screen will be turned off after 3 seconds. In this case, if you want turn the screen on, press any key on the set or the remote control or play the USB or Bluetooth device.
- If you adjust "**Energy Saving-Auto**(Except 19/22/26/32/37/42LH2\*\*\*, 32/42LF2\*\*\*, 32/37/42/47LH3\*\*\*, 19/22/26LU5\*\*\*), **Minimum**, **Medium**, **Maximum**", **Backlight** feature will not work.
- You can also adjust **Energy Saving** button.

# PICTURE CONTROL

## PRESET PICTURE SETTINGS

### Picture Mode-Preset

**Intelligent Sensor** Adjusts picture according to the surrounding conditions.

**Vivid** Strengthen the contrast, brightness, colour and sharpness for vivid picture.

**Standard** The most general and natural screen display status.

**Natural** The most natural screen display status.

**Cinema** Optimizes video for watching movies.

**Sport** Optimizes video for watching sports events.

**Game** Optimizes video for playing games.

(Except 19/22/26/32/37/42LH2\*\*\*, 32/42LF2\*\*\*, 32/37/42/47LH3\*\*\*, 19/22/26LU5\*\*\*)

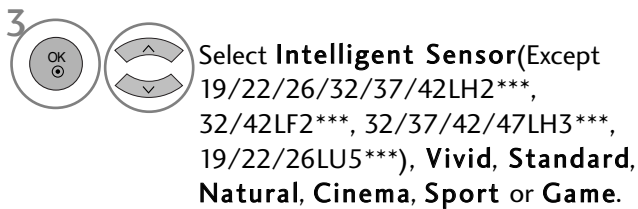
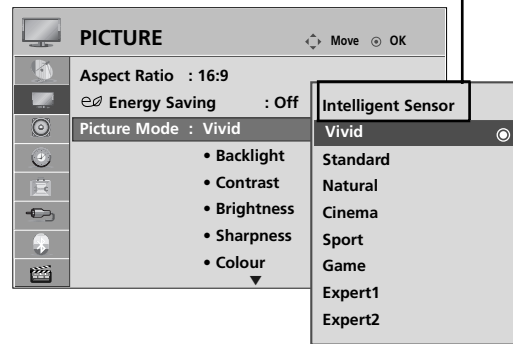
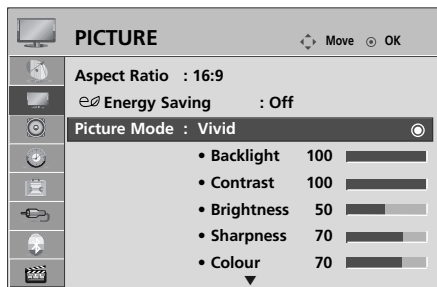

- **Picture Mode** adjusts the TV for the best picture appearance. Select the preset value in the **Picture Mode** menu based on the programme category.
- When the Intelligent sensor function is on, the most suitable picture is automatically adjusted according to the surrounding conditions.
- You can also adjust **Picture Mode** in the **Q. Menu**.

- Press the **MENU** button to return to normal TV viewing.
- Press the **RETURN** button to move to the previous menu screen.

# MANUAL PICTURE ADJUSTMENT

## Picture Mode-User option

- **Backlight**

To control the brightness of the screen, adjust the brightness of LCD panel.  
Adjusting the backlight when setting the brightness of the set is recommended.

- **Contrast**

Adjusts the difference between light and dark levels in the picture. You may use Contrast when the bright part of the picture is saturated.

- **Brightness**

Increases or decreases the amount of white in the picture.

- **Sharpness**

Adjusts the level of crispness in the edges between the light and dark areas of the picture.  
The lower the level, the softer the image.

- **Colour**

Adjusts intensity of all colours.

- **Tint**

Adjusts the balance between red and green levels.

It is not available to use this function in “Intelligent Sensor”.

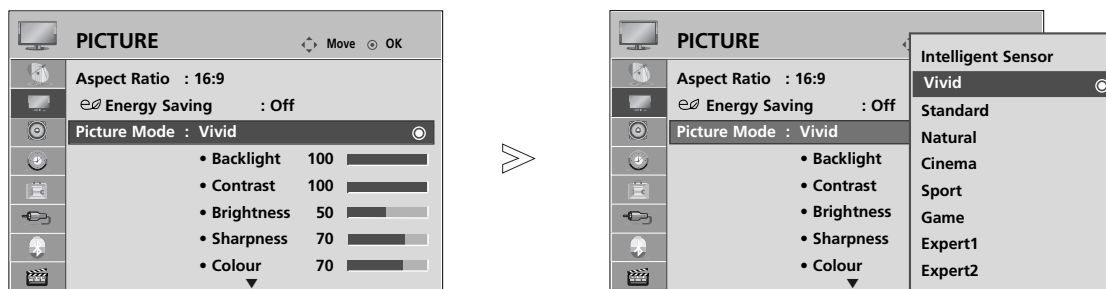

1. Select **PICTURE**.
2. Select **Picture Mode**.
3. Select **Vivid, Standard, Natural, Cinema, Sport or Game**.
4. Select **Backlight, Contrast, Brightness, Sharpness, Colour or Tint**.
5. Make appropriate adjustments.

- **Benefits of using Backlight**

- The electricity consumption is reduced by up to 60%.
- The black brightness is reduced. (As the black has greater depth, you can enjoy a better quality definition.)
- You can adjust brightness with maintaining original signal resolution.

- Press the **MENU** button to return to normal TV viewing.
- Press the **RETURN** button to move to the previous menu screen.

### ! NOTE

- ▶ You cannot adjust colour, sharpness and tint in the RGB-PC mode.

# PICTURE CONTROL

## PICTURE IMPROVEMENT TECHNOLOGY

You can calibrate the screen for each Picture Mode or set the video value according to the special video screen. you can set the video value differently for each input.

To reset to the factory default screen after making adjustment to each video mode, execute the “Reset” function for each Picture Mode.

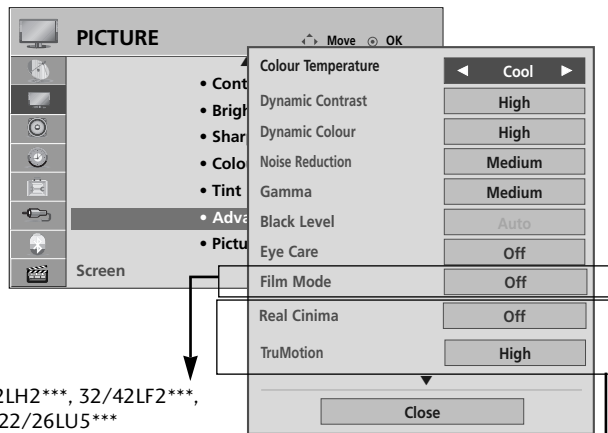
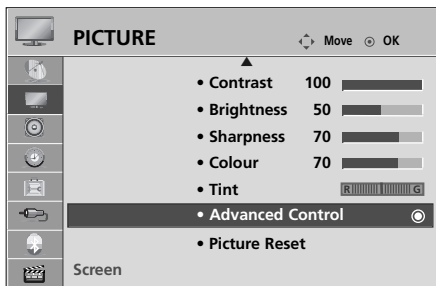

Only 19/22/26/32/37/42LH2\*\*\*, 32/42LF2\*\*\*, 32/37/42/47LH3\*\*\*, 19/22/26LU5\*\*\*

Except 19/22/26/32/37/42LH2\*\*\*, 32/42LF2\*\*\*, 32/37/42/47LH3\*\*\*, 19/22/26LU5\*\*\*

1 MENU Select **PICTURE**.

2 OK Select **Advanced Control**.

3 OK Select **Colour Temperature, Dynamic Contrast, Dynamic Colour, Noise Reduction, Gamma, Black Level, Eye Care, Film Mode**(Only 19/22/26/32/37/42LH2\*\*\*, 32/42LF2\*\*\*, 32/37/42/47LH3\*\*\*, 19/22/26LU5\*\*\*), **Real Cinema**(Except 19/22/26/32/37/42LH2\*\*\*, 32/42LF2\*\*\*, 32/37/42/47LH3\*\*\*, 19/22/26LU5\*\*\*), **TruMotion**(Except 19/22/26/32/37/42LH2\*\*\*, 32/42LF2\*\*\*, 32/37/42/47LH3\*\*\*, 19/22/26LU5\*\*\*), **Colour Gamut, Edge Enhancer or OPC**. (Refer to p.88~89)

4 Select your desired Source.

- Press the **MENU** button to return to normal TV viewing.
- Press the **RETURN** button to move to the previous menu screen.









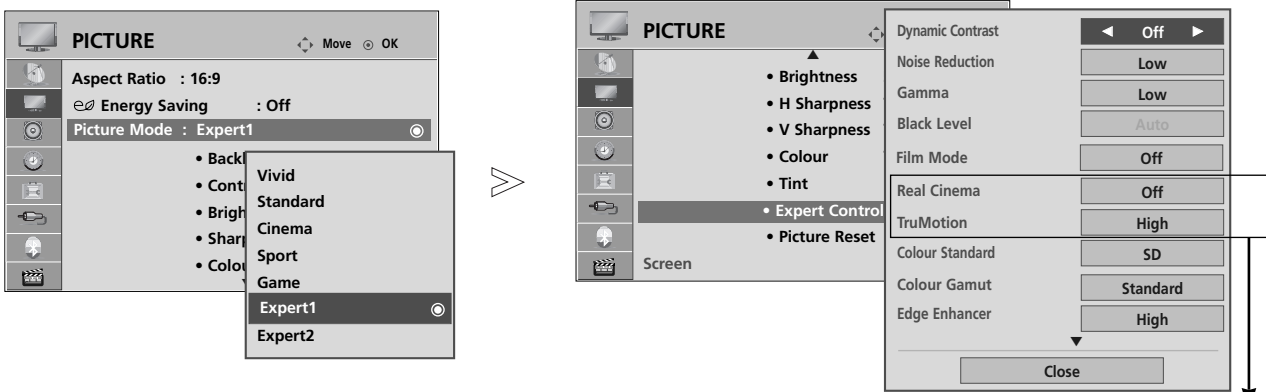



# EXPERT PICTURE CONTROL

By segmenting categories, Expert1 and Expert2 provide more categories which users can set as they see fit, offering the optimal picture quality for users.

As the detail item for video quality experts to adjust the video precisely using specific videos, this may not be effective for general videos.



Except 19/22/26/32/37/42LH2\*\*\*, 32/42LF2\*\*\*, 32/37/42/47LH3\*\*\*, 19/22/26LU5\*\*\*

- 1   Select **PICTURE**.
- 2   Select **Picture Mode**.
- 3   Select **Expert1** or **Expert2**.
- 4   Select **Expert Control**.
- 5   Select your desired Source.
- 6  Make appropriate adjustments.

- Press the **MENU** button to return to normal TV viewing.
- Press the **RETURN** button to move to the previous menu screen.

# PICTURE CONTROL

\*This feature is not available for all models.

<p><b>Colour Temperature</b> (Warm/Medium/Cool)</p>	<ul style="list-style-type: none"> <li>Choose one of three automatic colour adjustments. Set to warm to enhance hotter colours such as red, or set to cool to make picture bluish.</li> </ul>
<p><b>Dynamic Contrast</b> (Off/Low/Medium/High)</p>	<ul style="list-style-type: none"> <li>Adjusts the contrast to keep it at the best level according to the brightness of the screen. The picture is improved by making bright parts brighter and dark parts darker.</li> </ul>
<p><b>Dynamic Colour</b> (Off/Low/High )</p>	<ul style="list-style-type: none"> <li>Adjusts screen colours so that they look livelier, richer and clearer. This feature enhances hue, saturation and luminance so that red, blue, green and white look more vivid.</li> </ul>
<p><b>Noise Reduction</b> (Off/Low/Medium/High)</p>	<ul style="list-style-type: none"> <li>Reduces screen noise without compromising video quality.</li> </ul>
<p><b>Gamma</b> (Low/Medium/High)</p>	<ul style="list-style-type: none"> <li>You can adjust brightness of dark area and middle gray level area of the picture. <ul style="list-style-type: none"> <li><b>Low</b> : Make dark and middle gray level area of the picture brighter.</li> <li><b>Medium</b>: Express original picture levels.</li> <li><b>High</b>: Make dark and middle gray level area of the picture darker.</li> </ul> </li> </ul>
<p><b>Black Level</b> (Low/High)</p>	<ul style="list-style-type: none"> <li><b>Low</b> : The reflection of the screen gets darker.</li> <li><b>High</b> : The reflection of the screen gets brighter.</li> <li><b>Auto</b> : Realizing the black level of the screen and set it to High or Low automatically.</li> <li><b>Set black level of the screen to proper level.</b></li> <li>This function enables to select 'Low' or 'High' in the following mode: AV(NTSC-M), HDMI or Component. Otherwise, 'Black level' is set to 'Auto'.</li> </ul>
<p><b>Eye Care</b> (On/Off)</p>	<p>*This feature is not available for all models.</p> <ul style="list-style-type: none"> <li>Adjust the brightness of the screen to prevent the screen from being too bright. Dims extremely bright pictures.</li> <li>This feature is disable in "<b>Picture Mode-Vivid, Cinema, Intelligent Sensor</b>".</li> </ul>
<p><b>Real Cinema/Film Mode</b> (On/Off)</p>	<ul style="list-style-type: none"> <li>Makes video clips recorded in film look more natural by eliminating judder effect.</li> <li>This function can work when TruMotion is off.</li> </ul>
<p><b>TruMotion</b> (Off/Low/High )</p>	<p>*This feature is not available for all models.</p> <ul style="list-style-type: none"> <li><b>High</b> : Provides smoother picture movement.</li> <li><b>Low</b> : Provides smooth picture movement. Use this setting for standard use.</li> <li><b>Off</b> : Use this setting when "High" and "Low" setting result in noise.</li> </ul>
<p><b>TruMotion</b> (Off/Low/High )</p>	<ul style="list-style-type: none"> <li>TruMotion 100Hz can reduce perception of blur on fast moving scenes by displaying one hundred images per second. (Except 37/42/47/55LH5***)</li> <li>TruMotion 200Hz displays 200 scenes per second by combining advanced 100Hz technology with scanning backlight. This technology is verified from intertek &amp; TÜV Rheinland.(Only 37/42/47/55LH5***)</li> <li>It is used for the best picture quality without any motion blur or judder when you enter a quick image or Film Source.</li> <li>This feature is disable in RGB-PC mode.</li> <li>If you enable "TruMotion 100Hz or TruMotion 200Hz", noise may appear on the screen. If this occurs, set "TruMotion 100Hz or TruMotion 200Hz" to "Off".</li> </ul>





<p><b>Colour Gamut</b> (Wide/Standard)</p>	<ul style="list-style-type: none"> <li>• <b>Standard</b> : Mode to reproduce original colour according to the standard of input signal independent of the display characteristics.</li> <li>• <b>Wide</b>: Mode to use and set the rich colour area of the display. <ul style="list-style-type: none"> <li>■ Maximize the utilization for colour area that can be expressed.</li> </ul> </li> </ul>
<p><b>Edge Enhancer</b> (Off/Low/High)</p>	<ul style="list-style-type: none"> <li>■ Shows clearer and distinctive yet natural corners of the video.</li> </ul>
<p><b>OPC</b> (On/Off)</p>	<p>*This feature is not available for all models.</p> <ul style="list-style-type: none"> <li>■ As the technology to reduce the power consumption while keeping the same brightness, this has the effect of reducing power consumption, improvement in contrast.</li> </ul>
<p><b>Colour Standard</b> (SD/HD)</p>	<ul style="list-style-type: none"> <li>■ Converts the colour of a different video to HD colour. This function is set for SD video (BT-601) and HD video (BT-709) colour format.</li> <li>■ This feature is enabled in "Picture Mode - Expert1/2".</li> </ul>
<p><b>Colour Filter</b> (Off/Red/Green/Blue)</p>	<ul style="list-style-type: none"> <li>■ This is the function to filter the specific colours of the video. You can use the RGB filter to set colour saturation and hue accurately.</li> <li>■ This feature is enabled in "Picture Mode - Expert1/2".</li> </ul>
<p><b>White Balance</b> (Medium/Warm/Cool)</p>	<ul style="list-style-type: none"> <li>■ This is the function to adjust the overall colour of the screen to the feeling you want. <ul style="list-style-type: none"> <li>• Red/Green/Blue Contrast, Red/Green/Blue Brightness: The adjustment range is -50 ~ +50.</li> </ul> </li> <li>■ This feature is enabled in "Picture Mode - Expert1/2".</li> </ul>
<p><b>Colour Management System</b></p>	<ul style="list-style-type: none"> <li>■ As the tool used by the experts to make adjustments by using the test patterns, this does not affect other colours but can be used to selectively adjust the 6 colour areas (Red/Green/Blue/Cyan/Magenta/Yellow). Colour difference may not be distinctive even when you make the adjustments for the general video.</li> <li>■ Adjusts Red/Green/Blue/Yellow/Cyan/Magenta.</li> <li>• Red/Green/Blue/Yellow/Cyan, Magenta Colour : The adjustment range is -30 ~ +30.</li> <li>• Red/Green/Blue/Yellow/Cyan/Magenta Tint : The adjustment range is -30 ~ +30.</li> <li>■ This feature is disable in RGB-PC mode.</li> <li>■ This feature is enabled in "Picture Mode - Expert1/2".</li> </ul>

# PICTURE CONTROL

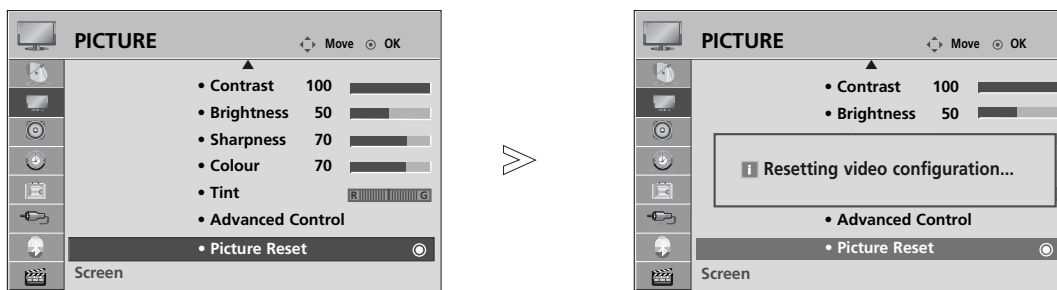
## PICTURE RESET

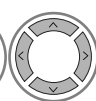
Settings of the selected picture modes return to the default factory settings.

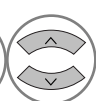

-   Select **PICTURE**.
-   Select **Picture Reset**.
-  Initialize the adjusted value.

- Press the **MENU** button to return to normal TV viewing.
- Press the **RETURN** button to move to the previous menu screen.

# POWER INDICATOR

It helps you adjust the brightness of moving LED and sound when power is turned on.

## Startup Sound

Determines whether to set the start up sound to **Off**, **Low**, **Medium** or **High** when the power turns on.

## Standby Light

Determines whether to set the indicator light on the front of the TV to **Off**, **Low** or **High** in standby mode.  
(Except 19/22/26/32/37/42LH2\*\*\*, 32/42LF2\*\*\*, 32/37/42/47LH3\*\*\*, 19/22/26LU5\*\*\*)

Determines whether to set the indicator light on the front of the TV to **On** or **Off** in standby mode.  
(Only 19/22/26/32/37/42LH2\*\*\*, 32/42LF2\*\*\*, 32/37/42/47LH3\*\*\*, 19/22/26LU5\*\*\*)

## Power Light

Determines whether to set the indicator light on the front of the TV to **On** or **Off** when the power turns on.

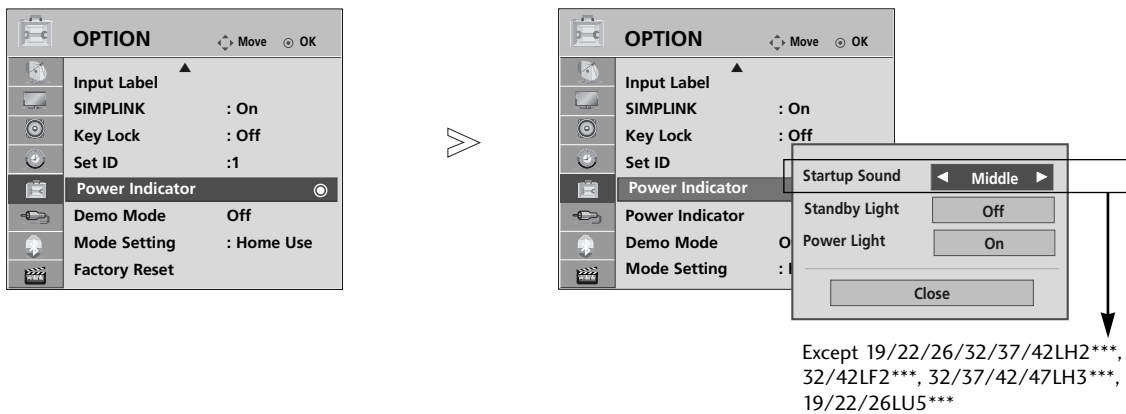

1 Select **OPTION**.

2 Select **Power Indicator**.

3 Select **Startup Sound**(Except 19/22/26/32/37/42LH2\*\*\*, 32/42LF2\*\*\*, 32/37/42/47LH3\*\*\*, 19/22/26LU5\*\*\*), **Standby Light** or **Power Light**.

4 Select your desired Source.

- Press the **MENU** button to return to normal TV viewing.
- Press the **RETURN** button to move to the previous menu screen.

# PICTURE CONTROL

## DEMO MODE

Display the slide show to explain the various logo of this TV.







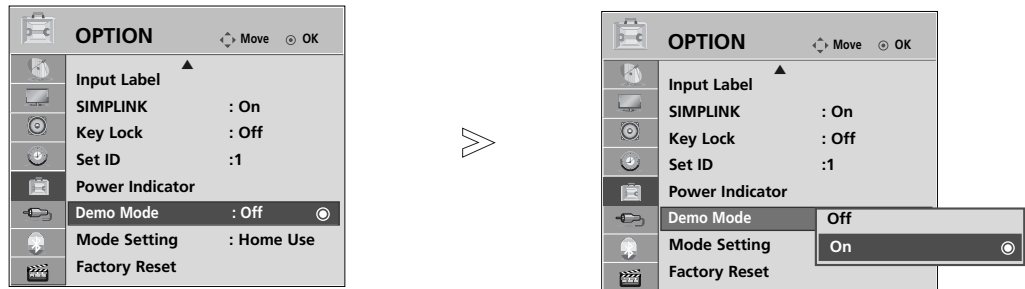

It is not possible to use **Demo Mode** in **Home Use** mode.

In **Store Demo**, **Demo Mode** is automatically set to **On**.

Once **Demo Mode** is set to **Off** in **Store Demo**, **Demo Mode** does not run and only the screen is reset.

The screen is reset automatically after 5 minutes in Demo Mode.









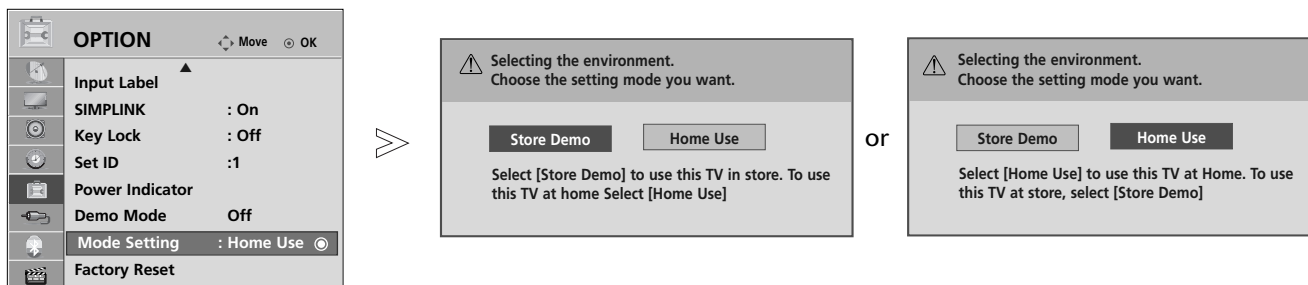

-   Select **OPTION**.
-   Select **Demo Mode**.
-   Select **On** to show the various logo of TV.
-  Return to TV viewing.  
If you want to stop the demo, press any button.  
(except MUTE,  + , - button)

- Press the **MENU** button to return to normal TV viewing.
- Press the **RETURN** button to move to the previous menu screen.

# MODE SETTING

We recommend setting the TV to “**Home Use**” mode for the best picture in your home environment. “**Store Demo**” mode is an optimal setting for displaying at stores.



-   Select **OPTION**.
-   Select **Mode Setting**.
-   Select **Store Demo** or **Home Use**.
-  Save.

- Press the **MENU** button to return to normal TV viewing.
- Press the **RETURN** button to move to the previous menu screen.





# SOUND & LANGUAGE CONTROL

## AUTO VOLUME LEVELER

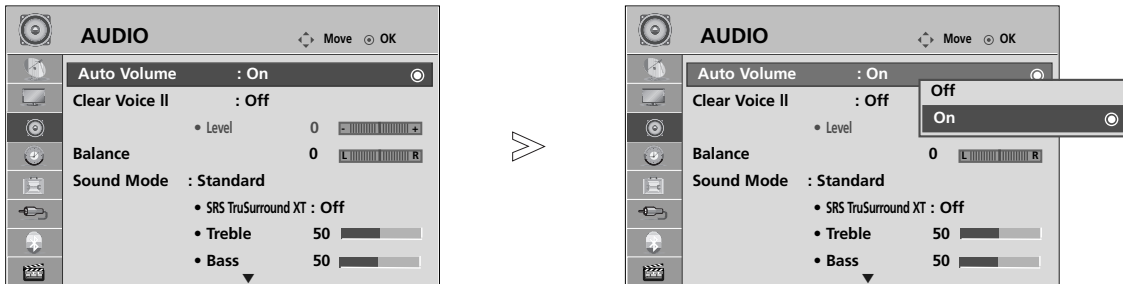
Auto volume automatically remains on the same level of volume if you change programmes.

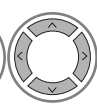
Because each broadcasting station has its own signal conditions, volume adjustment may be needed every time the channel is changed. This feature allows users to enjoy stable volume levels by making automatic adjustments for each programme.

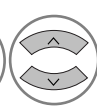

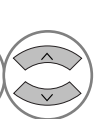
- 1   Select **AUDIO**.
- 2   Select **Auto Volume**.
- 3   Select **On** or **Off**.

- Press the **MENU** button to return to normal TV viewing.
- Press the **RETURN** button to move to the previous menu screen.



# PRESET SOUND SETTINGS-SOUND MODE

You can select your preferred sound setting; Standard, Music, Cinema, Sport or Game and you can also adjust the frequency of the equalizer.

Sound Mode lets you enjoy the best sound without any Special adjustment as the TV sets the appropriate sound options based on the programme content.

Standard, Music, Cinema, Sport and Game are preset for optimum sound quality at the factory.

- Standard** Offers standard-quality sound.
- Music** Optimizes sound for listening to music.
- Cinema** Optimizes sound for watching movies.
- Sport** Optimizes sound for watching sports events.
- Game** Optimizes sound for playing games.

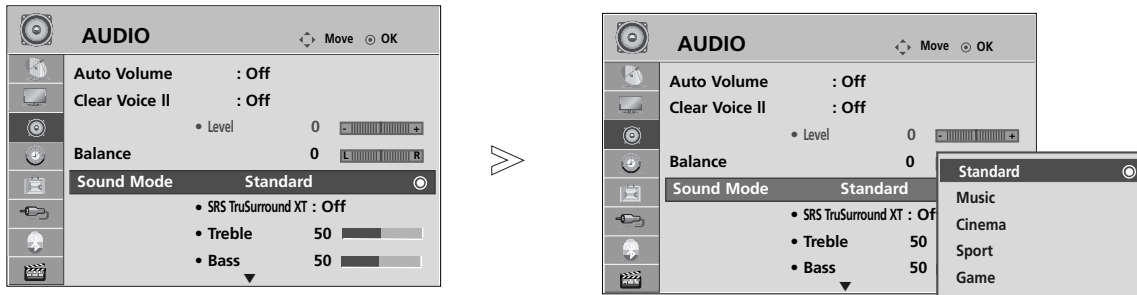

1 Select **AUDIO**.

2 Select **Sound Mode**.

3 Select **Standard, Music, Cinema, Sport or Game**.

4

• You can also adjust **Sound Mode** in the **Q. Menu**.

- Press the **MENU** button to return to normal TV viewing.
- Press the **RETURN** button to move to the previous menu screen.

# SOUND & LANGUAGE CONTROL

## SOUND SETTING ADJUSTMENT -USER MODE

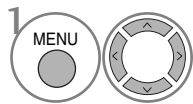
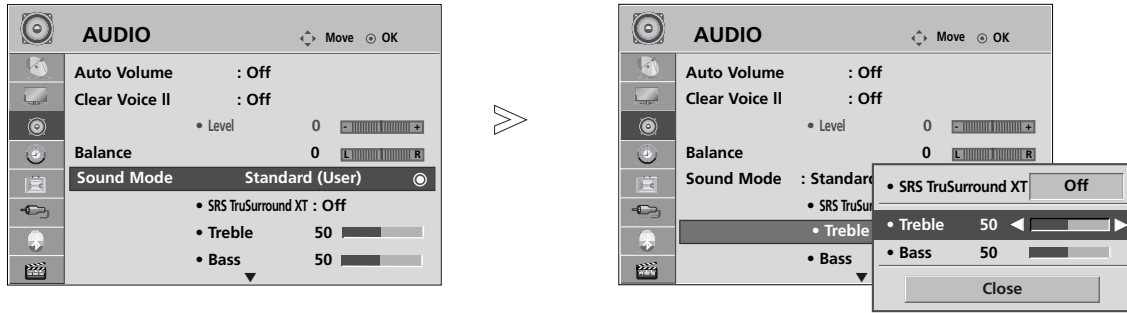

Select **AUDIO**.

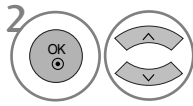

Select **Sound Mode**.

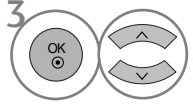

Select **Standard, Music, Cinema, Sport or Game**.

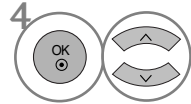

Select **Treble, Bass**.

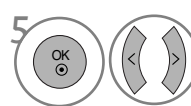

Make appropriate adjustments.



- Press the **MENU** button to return to normal TV viewing.
- Press the **RETURN** button to move to the previous menu screen.

## SRS TRUSURROUND XT

Select this option to sound realistic.

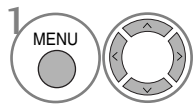

Select **AUDIO**.

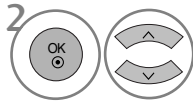

Select **SRS TruSurround XT**.

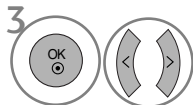

Select **On** or **Off**.

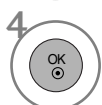

• **SRS TruSurround XT** : TruSurround XT is a patented SRS technology that solves the problem of playing 5.1 multichannel content over two speakers.

▶ **SRS** is a trademark of SRS Labs, Inc.  
 ▶ TruSurround XT technology is incorporated under license from SRS Labs, Inc.

# CLEAR VOICE II

By differentiating the human sound range from others, it helps users listen to human voices better.

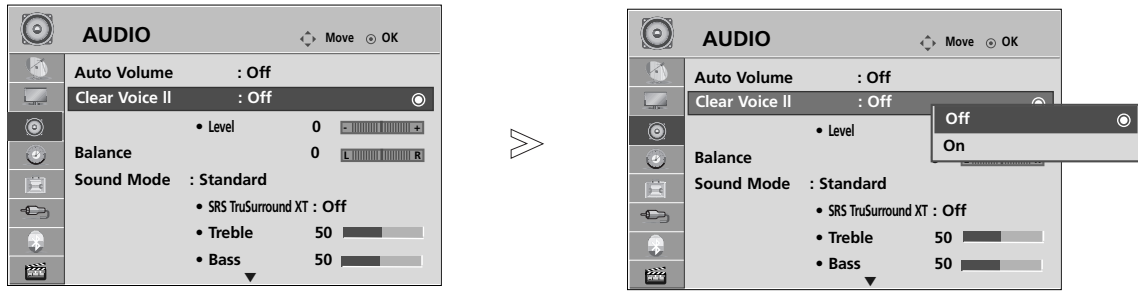

1   Select **AUDIO**.

2   Select **Clear Voice II**.

3   Select **On** or **Off**.

• If you select “On” for **Clear Voice II**, **SRS TruSurround XT** feature will not work.

## Adjustment for Clear Voice Level With selecting On

4   Select **Level**.

• Select levels from ‘-6’ to ‘+6’.

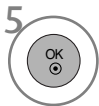
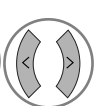
5   Make appropriate adjustments.

- Press the **MENU** button to return to normal TV viewing.
- Press the **RETURN** button to move to the previous menu screen.

# SOUND & LANGUAGE CONTROL

## BALANCE

You can adjust the sound balance of the speakers to preferred levels.

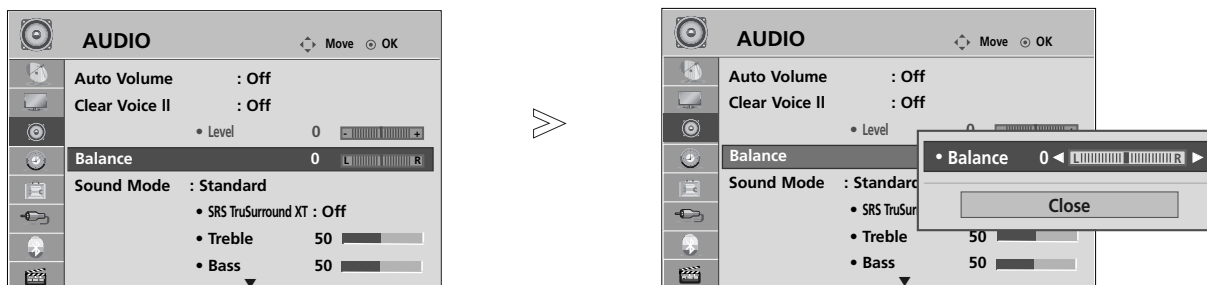

- 1   Select **AUDIO**.
- 2   Select **Balance**.
- 3   Make desired adjustment.

- Press the **MENU** button to return to normal TV viewing.
- Press the **RETURN** button to move to the previous menu screen.





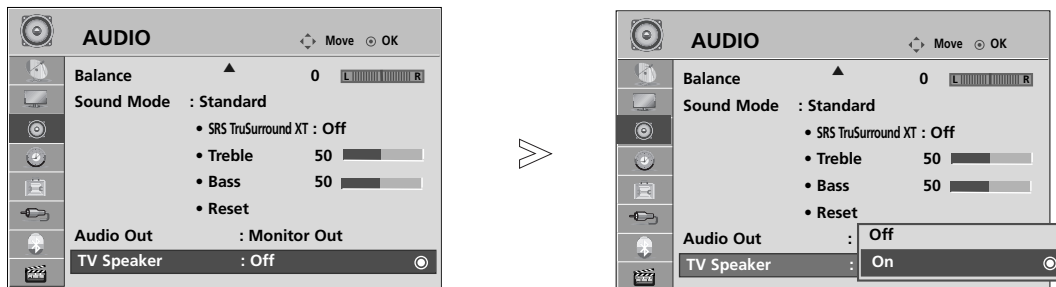

# TV SPEAKERS ON/ OFF SETUP

You can adjust the TV internal speaker status.

In **AV**, **COMPONENT**, **RGB** and **HDMI** with HDMI to DVI cable, the TV speaker can be operational even when there is no video signal.

If you wish to use an external Hi-Fi system, turn off the TV's internal speakers.



- 1   Select **AUDIO**.
- 2   Select **TV Speaker**.
- 3   Select **On** or **Off**.

- Press the **MENU** button to return to normal TV viewing.
- Press the **RETURN** button to move to the previous menu screen.

## ! NOTE

- ▶ When the TV speaker is turned off while the Simplink home theater is operating, the sound output automatically switches to the Home theater speaker, but when the TV speaker is turned on, the sound output the TV speaker.

# SOUND & LANGUAGE CONTROL

## SELECTING AUDIO OUT

Select **Monitor Out** or **Variable out** to connect the audio outputs.

### Monitor Out

It sounds connected to AV equipment input including exterior amp.





The level of the sound is always regular, regardless of the volume setup of the set. Thus the level of the sound from an exterior equipment can be controlled by adjusting the volume of the exterior equipment.

### Variable out

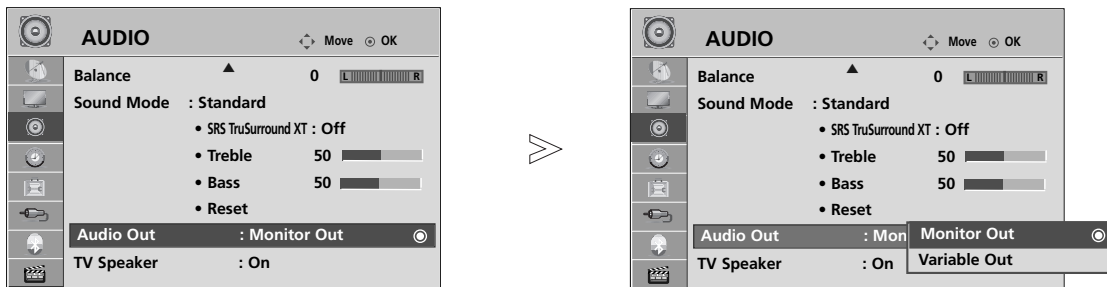
It sounds connected to AV equipment input including exterior amp.

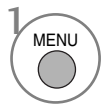
Sound can be adjusted depending on the volume setup of the set. Thus the level of the sound from the exterior equipment can be controlled either by the exterior equipment or the volume setup of the set.

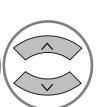
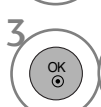

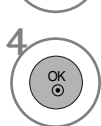



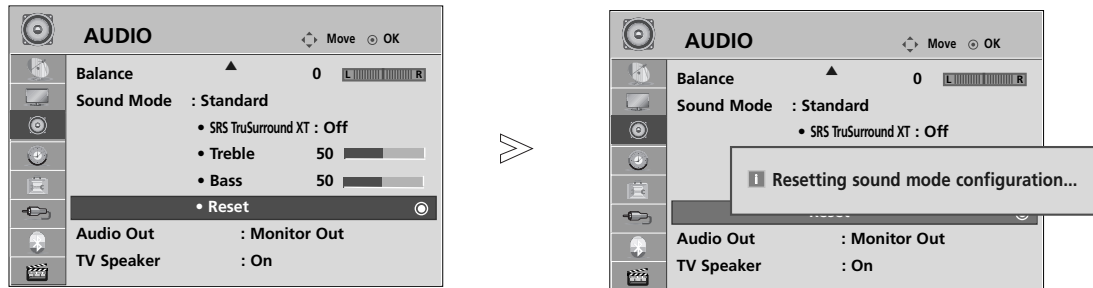

- 1   Select **AUDIO**.
- 2   Select **Audio Out**.
- 3   Select **Monitor Out** or **Variable out**.
- 4 

- Press the **MENU** button to return to normal TV viewing.
- Press the **RETURN** button to move to the previous menu screen.

# AUDIO RESET

Settings of the selected Sound Mode return to the default factory settings.



- 1   Select **AUDIO**.
- 2   Select **Reset**.
- 3  Initialize the adjusted value.

- Press the **MENU** button to return to normal TV viewing.
- Press the **RETURN** button to move to the previous menu screen.

# SOUND & LANGUAGE CONTROL

I/II

## Stereo/Dual Reception

When a programme is selected, the sound information for the station appears with the programme number and station name.

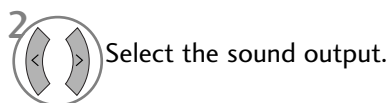

---

Broadcast	On Screen Display
Mono	MONO
Stereo	STEREO
Dual	DUAL I, DUAL II, DUAL I+II

### ■ Mono sound selection

If the stereo signal is weak in stereo reception, you can switch to mono. In mono reception, the clarity of sound is improved.

### ■ Language selection for dual language broadcast

If a programme can be received in two languages (dual language), you can switch to DUAL I, DUAL II or DUAL I+II.

- DUAL I Sends the primary broadcast language to the loudspeakers.
- DUAL II Sends the secondary broadcast language to the loudspeakers.
- DUAL I+II Sends a separate language to each loudspeaker.



## NICAM Reception

If the TV is equipped with a receiver for NICAM reception, high quality NICAM (Near Instantaneous Companding Audio Multiplex) digital sound can be received.

Sound output can be selected according to the type of broadcast received.

- 
- 1 When **NICAM mono** is received, you can select **NICAM MONO** or **FM MONO**.
- 
- 2 When **NICAM stereo** is received, you can select **NICAM STEREO** or **FM MONO**.  
If the stereo signal is weak, switch to **FM MONO**.
- 
- 3 When **NICAM dual** is received, you can select **NICAM DUAL I**, **NICAM DUAL II** or **NICAM DUAL I+II** or **FM MONO**.
- 

## Speaker Sound Output Selection

In AV, Component, RGB and HDMI mode, you can select output sound for the left and right loudspeakers.

Select the sound output.

**L+R:** Audio signal from audio L input is sent to the left loudspeaker and audio signal from audio R input is sent to the right loudspeaker.

**L+L:** Audio signal from audio L input is sent to left and right loudspeakers.

**R+R:** Audio signal from audio R input is sent to left and right loudspeakers.

# SOUND & LANGUAGE CONTROL

## ON-SCREEN MENU LANGUAGE SELECTION

The installation setup menu appears on the TV screen when it is switched on for the first time.

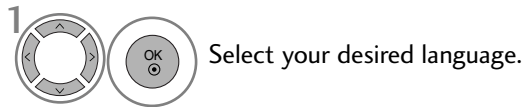

\* If you want to change Language selection

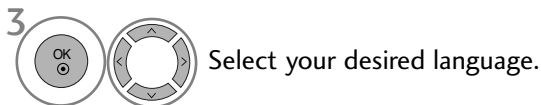

- Press the **MENU** button to return to normal TV viewing.
- Press the **RETURN** button to move to the previous menu screen.

### ! NOTE

- ▶ If you do not finish the set-up **Installation Setup** by pressing **RETURN** or if you time out on the OSD (On Screen Display) the installation menu will continuously appear until the set up is completed whenever the TV is switched on.





# TIME SETTING

## CLOCK SETUP

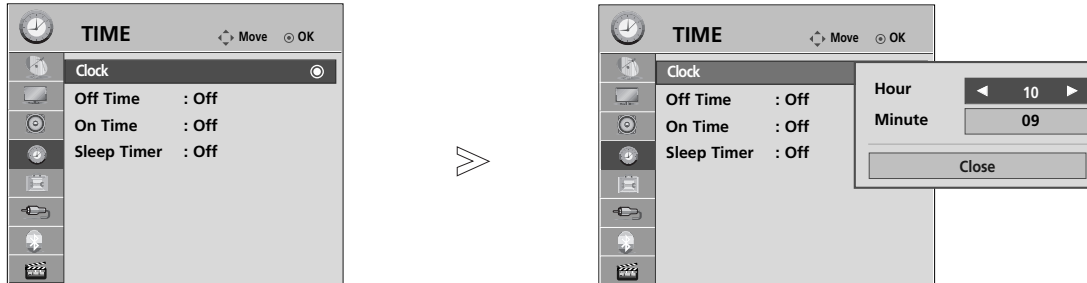
You must set the time correctly before using on/off timer function.

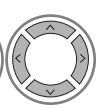
If current time setting is erased by a power failure or the TV is unplugged, reset the clock.

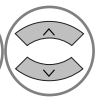
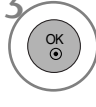
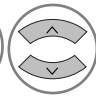

-   Select **TIME**.
-   Select **Clock**.
-   Select either the Hour or Minute option.
-   Set the Hour or Minute options.

- Press the **MENU** button to return to normal TV viewing.
- Press the **RETURN** button to move to the previous menu screen.

# TIME SETTING

## AUTO ON/OFF TIMER SETTING



The Off time function automatically switches the TV to standby at a preset time.

Two hours after the TV is switched on by the on time function it will automatically switch back to standby mode unless a button has been pressed.

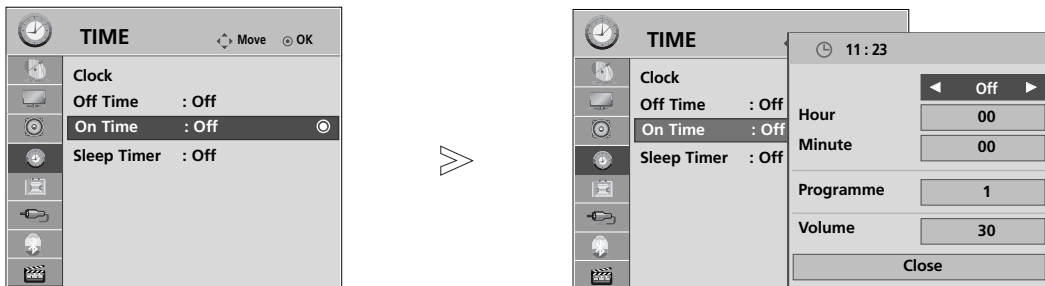

The Off time function overrides the On time function if both are set to the same time.

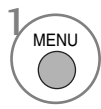
The TV must be in standby mode for the On time to work.

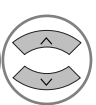

- 1   Select **TIME**.
- 2   Select **Off Time** or **On Time**.

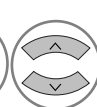
When the **On Time** is selected,

- 3   Select **Hour**, **Minute**, **Programme** or **Volume**.
- 4  Set the Hour, Minute, Programme, Volume.

- Press the **MENU** button to return to normal TV viewing.
- Press the **RETURN** button to move to the previous menu screen.

## SLEEP TIMER SETTING

You do not have to remember to switch the TV off before you go to sleep.

The sleep timer automatically switches the TV to standby after the preset time has elapsed.

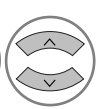
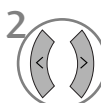
- 1   Select **Sleep Timer**.
- 2  Select **Off**, **10**, **20**, **30**, **60**, **90**, **120**, **180** or **240 Min**.

- When you switch the TV off, the preset sleep timer is cancelled.
- You can also adjust **Sleep Timer** in the **TIME** menu.

# TELETEXT

**This feature is not available in all countries.**

Teletext is a free service broadcast by most TV stations which gives up-to-the-minute information on news, weather, television programmes, share prices and many other topics.

The teletext decoder of this TV can support the SIMPLE, TOP and FASTEXT systems. SIMPLE (standard teletext) consists of a number of pages which are selected by directly entering the corresponding page number. TOP and FASTEXT are more modern methods allowing quick and easy selection of teletext information.

## SWITCH ON/OFF

Press the **TEXT** button to switch to teletext. The initial page or last page viewed appears on the screen.

Two page numbers, TV station name, date and time are displayed on the screen headline. The first page number indicates your selection, while the second shows the current page displayed.

Press the **TEXT** button to switch off teletext. The previous mode reappears.

## SIMPLE TEXT

### ■ Page selection

- 1 Enter the desired page number as a three digit number with the **NUMBER** buttons. If during selection you press a wrong number, you must complete the three digit number and then re-enter the correct page number.
- 2 The **P**  $\wedge$   $\vee$  button can be used to select the preceding or following page.

## TOP TEXT

The user guide displays four fields-red, green, yellow and blue at the bottom of the screen. The yellow field denotes the next group and the blue field indicates the next block.

### ■ Block / group / page selection

- 1 With the blue button you can progress from block to block.
- 2 Use the yellow button to proceed to the next group with automatic overflow to the next block.
- 3 With the green button you can proceed to the next existing page with automatic overflow to the next group. Alternatively the **P**  $\wedge$  button can be used.
- 4 The red button returns to the previous selection. Alternatively the **P**  $\vee$  button can be used.

### ■ Direct page selection

As with SIMPLE teletext mode, you can select a page by entering it as a three digit number using the **NUMBER** buttons in TOP mode.

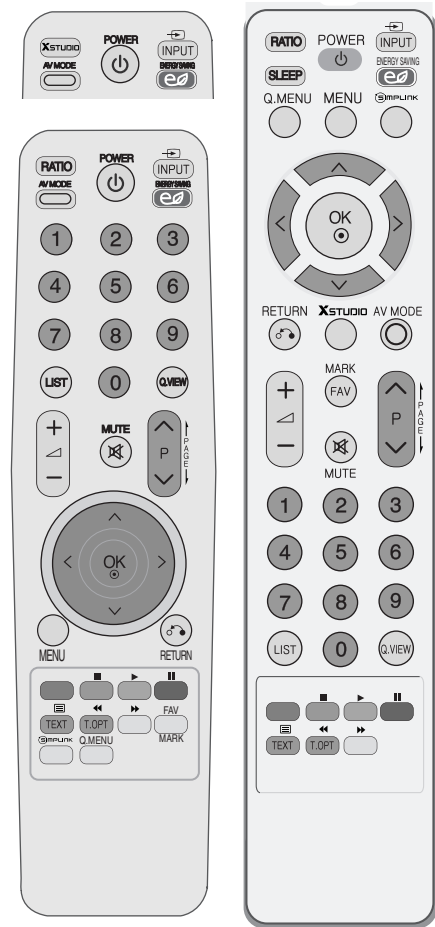

# TELETEXT

## FASTEXT

The teletext pages are colour coded along the bottom of the screen and are selected by pressing the corresponding coloured button.

### ■ Page selection

- 1 Press the **T.OPT** button and then use  $\wedge \vee$  button to select  menu. Display the index page.
- 2 You can select the pages which are colour coded along the bottom line with corresponding coloured buttons.
- 3 AS with SIMPLE teletext mode, you can select a page by entering its three digit page number with the NUMBER buttons in FASTEXT mode.
- 4 The **P**  $\wedge \vee$  button can be used to select the preceding or following page.

## SPECIAL TELETEXT FUNCTIONS

- Press the **T. OPT** button and then use  $\wedge \vee$  button to select the **Text Option** menu.



### ■ Index

Select the each index page.



### ■ Time

When viewing a TV programme, press this button to display the time at the top right hand corner of the screen. Press this button again to remove the display. In the teletext mode, press this button to select a sub page number. The sub page number is displayed at the bottom of the screen. To hold or change the sub page, press the RED/GREEN, **P**  $\wedge / \vee$  or NUMBER buttons.

Press again to exit this function.



### ■ Hold

Stops the automatic page change which will occur if a teletext page consists of 2 or more sub pages. The number of sub pages and the sub page displayed is, usually, shown on the screen below the time. When this button is pressed the stop symbol is displayed at the top left-hand corner of the screen and the automatic page change is inactive. To continue press this button again.



### ■ Reveal

Press this button to display concealed information, such as solutions to riddles or puzzles.

Press this button again to remove the information from the display.



### ■ Update

Displays the TV picture on the screen while waiting for a new teletext page. The display will appear at the top left hand corner of the screen. When the updated page is available then display will change to the page number. Press this button again to view the updated teletext page.

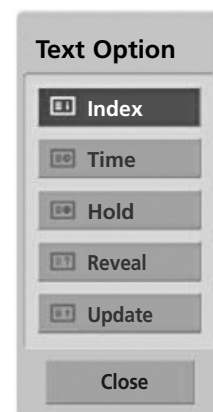

# APPENDIX

## TROUBLESHOOTING

The TV does not operate properly.	
The remote control does not work	<ul style="list-style-type: none"> <li>■ Check to see if there is any object between the TV and the remote control causing an obstruction. Ensure you are pointing the remote control directly at the TV.</li> <li>■ Ensure that the batteries are installed with correct polarity (+ to +, - to -).</li> <li>■ Install new batteries.</li> </ul>
Power is suddenly turned off	<ul style="list-style-type: none"> <li>■ Is the sleep timer set?</li> <li>■ Check the power control settings. Has the Power supply been interrupted.</li> <li>■ The TV goes into Standby mode automatically if no signal is received or no operation is performed for 15 minutes.</li> </ul>

The video function does not work.	
No picture & No sound	<ul style="list-style-type: none"> <li>■ Check whether the TV is switched on.</li> <li>■ Try another channel. The problem may be with the broadcast.</li> <li>■ Is the power cord inserted correctly into the mains?</li> <li>■ Check your antenna direction and/or location.</li> <li>■ Test the mains outlet by plugging another TV into the same outlet.</li> </ul>
Picture appears slowly after switching on	<ul style="list-style-type: none"> <li>■ This is normal, the image is muted during the TV startup process. Please contact your service centre, if the picture has not appeared after five minutes.</li> </ul>
No or poor colour or poor picture	<ul style="list-style-type: none"> <li>■ Adjust Colour in menu option.</li> <li>■ Allow a sufficient distance between the TV and the VCR.</li> <li>■ Try another channel. The problem may be with the broadcast.</li> <li>■ Are the video cables installed properly?</li> <li>■ Activate any function to restore the brightness of the picture.</li> </ul>
Horizontal/vertical bars or picture shaking	<ul style="list-style-type: none"> <li>■ Check for local interference such as an electrical appliance or power tool.</li> </ul>
Poor reception on some channels	<ul style="list-style-type: none"> <li>■ Station or cable channel experiencing problems, tune to another station.</li> <li>■ Station signal is weak, reposition the antenna to receive weaker stations.</li> <li>■ Check for sources of possible interference.</li> </ul>
Lines or streaks in pictures	<ul style="list-style-type: none"> <li>■ Check antenna (Change the position of the antenna).</li> </ul>
No picture when connecting HDMI	<ul style="list-style-type: none"> <li>■ Check that your HDMI cable is version 1.3 or higher. If the HDMI cables don't support HDMI version 1.3, flickering or no screen display can result. Please use the latest cables that support at least HDMI version 1.3.</li> </ul>

# APPENDIX

## The audio function does not work.

Picture OK & No sound	<ul style="list-style-type: none"> <li>■ Press the  + or - button.</li> <li>■ Sound muted? Press <b>MUTE</b> button.</li> <li>■ Try another channel. The problem may be with the broadcast.</li> <li>■ Are the audio cables installed properly?</li> </ul>
No output from one of the speakers	<ul style="list-style-type: none"> <li>■ Adjust <b>Balance</b> in menu option.</li> </ul>
Unusual sound from inside the TV	<ul style="list-style-type: none"> <li>■ A change in ambient humidity or temperature may result in an unusual noise when the TV is switched on or off and does not indicate a fault with the TV.</li> </ul>
No sound when connecting HDMI or USB	<ul style="list-style-type: none"> <li>■ Check HDMI cable over version 1.3.</li> <li>■ Check USB cable over version 2.0.</li> </ul>

\*This feature is not available for all models.

## There is a problem in PC mode. (Only PC mode applied)

The signal is out of range (Invalid format)	<ul style="list-style-type: none"> <li>■ Adjust resolution, horizontal frequency, or vertical frequency.</li> <li>■ Check the input source.</li> </ul>
Vertical bar or stripe on background & Horizontal Noise & Incorrect position	<ul style="list-style-type: none"> <li>■ Use Auto configure or adjust clock, phase, or H/V position. (Option)</li> </ul>
Screen colour is unstable or single colour	<ul style="list-style-type: none"> <li>■ Check the signal cable.</li> <li>■ Reinstall the PC video card.</li> </ul>

## There is a problem with PICTURE settings.

When the user changes the picture settings, the TV automatically converts back to the initial settings after a certain period of time.	<ul style="list-style-type: none"> <li>■ It means that the TV is currently set to <b>Store Demo</b> mode. To switch to <b>Home use</b> mode you should do the followings: From the TV Menu, choose <b>OPTION</b> -&gt; Choose <b>Mode Setting</b> -&gt; Choose <b>Home use</b>. Now, you have completed switching to the <b>Home use</b> mode.</li> </ul>
--	---



# MAINTENANCE

Early malfunctions can be prevented. Careful and regular cleaning can prolong the life of your new TV.

Caution: Be sure to switch the power off and unplug the power cord before you begin any cleaning.

## Cleaning the Screen

- 1 A good way to keep the dust off your screen for a while is to wet a soft cloth in a mixture of lukewarm water and a little fabric softener or dish washing detergent. Wring the cloth until it is almost dry, and then use it to wipe the screen.
- 2 Ensure there is no excess water on the screen. Allow any water or dampness to evaporate before switching on.

## Cleaning the Cabinet

- To remove dirt or dust, wipe the cabinet with a soft, dry, lint-free cloth.
- Do not to use a wet cloth.

## Extended Absence

### CAUTION

- ▶ If you expect to leave your TV dormant for prolonged periods (such as a holiday), unplug the power cord to protect against possible damage from lightning or power surges.

# APPENDIX

## PRODUCT SPECIFICATIONS

MODELS		19LH2***	22LH2***	26LH2***	32LH2***
		19LH20R-TA/LA	22LH20R-TA/LA	26LH20R-TA/LA	32LH20R-TA/LA
Dimensions (Width x Height x Depth)	with stand	462.4 x 353.0 x 171.0 mm 18.2 x 13.9 x 6.8 inches	533.4 x 397.0 x 171.0 mm 21.0 x 15.7 x 6.8 inches	667.0 x 504.0 x 224.0 mm 26.3 x 19.9 x 8.8 inches	805.0 x 583.0 x 224.0 mm 31.7 x 23.0 x 8.8 inches
	without stand	462.4 x 308.0 x 65.0 mm 18.2 x 12.2 x 2.6 inches	533.4 x 351.7 x 65.0 mm 21.0 x 13.9 x 2.6 inches	667.0 x 446.2 x 80.0 mm 26.3 x 17.6 x 3.2 inches	805.0 x 528.0 x 79.9mm 31.7 x 20.8 x 3.2 inches
Weight	with stand	3.8 kg / 8.4 lbs	4.8 kg / 10.6 lbs	8.9 kg / 19.7 lbs	11.5 kg / 25.4 lbs
	without stand	3.6 kg / 8.0 lbs	4.6 kg / 10.2 lbs	7.8 kg / 17.2 lbs	10.3 kg / 22.7 lbs
Power requirement		AC100-240V~ 50/60Hz	AC100-240V~ 50/60Hz	AC100-240V~ 50/60Hz	AC100-240V~ 50/60Hz
MODELS		37LH2***	42LH2***	32LF2***	42LF2***
		37LH20R-TA/LA	42LH20R-TA/LA	32LF20FR-TA/LA	42LF20FR-TA/LA
Dimensions (Width x Height x Depth)	with stand	922.0 x 659.0x 297.0mm 36.3x 26.0 x 11.7 inches	1028.0 x 715.4 x 297.0mm 40.5x 28.2 x 11.7 inches	801.8 x 604.2 x 227.3 mm 31.5 x 23.7 x 8.9 inches	1032.8 x 742.3 x 293.8 mm 40.6 x 29.2 x 11.5 inches
	without stand	922.0 x 595x 88.0mm 36.3x 23.4 x 3.5 inches	1028.0 x 655.0x 87.8mm 40.5 x 25.8 x 3.5 inches	801.8 x 544.1 x 79.0 mm 31.5 x 21.4 x 3.1 inches	1032.8 x 670.1 x 92.0 mm 40.6 x 26.3 x 3.6 inches
Weight	with stand	14.8 kg / 32.6 lbs	18.0 kg / 39.7 lbs	13.4 kg / 29.5 lbs	23.6 kg / 52.0 lbs
	without stand	13.0 kg / 28.7 lbs	16.2 kg / 35.7 lbs	11.9 kg / 26.2 lbs	21.0 kg / 46.2 lbs
Power requirement		AC100-240V~ 50/60Hz	AC100-240V~ 50/60Hz	AC100-240V~ 50/60Hz	AC100-240V~ 50/60Hz
MODELS		32LH2***	37LH2***	42LH2***	
		32LH22R-TB/LB	37LH22R-TB/LB	42LH22R-TB/LB	
Dimensions (Width x Height x Depth)	with stand	805.0 x 585.8 x 210.9 mm 31.7 x 23.0 x 8.3 inches	922.0 x 660.0x 270.6mm 36.3x 26.0 x 10.7 inches	1028.0 x 715.4 x 270.6mm 40.5x 28.2 x 10.7 inches	
	without stand	805.0 x 528.0 x 79.9mm 31.7 x 20.8 x 3.2 inches	922.0 x 595x 88.0mm 36.3x 23.4 x 3.5 inches	1028.0 x 655.0x 87.8mm 40.5 x 25.8 x 3.5 inches	
Weight	with stand	11.5 kg / 25.4 lbs	14.8 kg / 32.6 lbs	18.0 kg / 39.7 lbs	
	without stand	10.3 kg / 22.7 lbs	13.0 kg / 28.7 lbs	16.2 kg / 35.7 lbs	
Power requirement		AC100-240V~ 50/60Hz	AC100-240V~ 50/60Hz	AC100-240V~ 50/60Hz	
Television System		PAL/SECAM B/G/D/K, PAL I/II, NTSC-M			
Program Coverage		VHF: NZ1 ~E21, UHF: E21 ~ E69, CATV: S1 ~ S20, HYPER: S21 ~ S47			
External Antenna Impedance		75 Ω			
Environment condition	Operating Temperature	0 ~ 40°C / 32 ~ 104°F			
	Operating Humidity	Less than 80%			
	Storage Temperature	-20 ~ 60°C / -4 ~ 140°F			
	Storage Humidity	Less than 85%			

■ The specifications shown above may be changed without prior notice for quality improvement.

MODELS		32LH3***	37LH3***	42LH3***	47LH3***
		32LH35FR-TE/LE	37LH35FR-TE/LE	42LH35FR-TE/LE	47LH35FR-TE/LE
Dimensions (Width x Height x Depth)	with stand	805.0 x 586.0 x 211.0 mm 31.7 x 23.0 x 8.3 inches	922.0 x 660.0 x 270.6mm 36.3x 26.0 x 10.7 inches	1028.0 x 716.4 x 270.6mm 40.5x 28.2 x 10.7 inches	1140.6 x 788.3 x 318.9 mm 44.9 x 31.0 x 12.5 inches
	without stand	805.0x 531.0x 79.9mm 31.7 x 20.9 x 3.2 inches	922.0 x 595x 88.0mm 36.3x 23.4 x 3.5 inches	1028.0x 658.6x 87.8mm 40.5 x 25.9 x 3.5 inches	1140.6 x 722.9 x 99.0 mm 44.9 x 28.5 x 3.9 inches
Weight	with stand	12.1 kg / 26.6 lbs	14.9 kg / 32.8 lbs	18 kg / 39.7 lbs	22.5 kg / 49.6 lbs
	without stand	11.0 kg / 24.2 lbs	13.1 kg / 28.9 lbs	16.2 kg / 35.7 lbs	19.9 kg / 43.9 lbs
Power requirement		AC100-240V~ 50/60Hz	AC100-240V~ 50/60Hz	AC100-240V~ 50/60Hz	AC100-240V~ 50/60Hz
MODELS		19LU5***	22LU5***	26LU5***	
		19LU50R-TA/LA	22LU50FR-TA/LA	26LU50FR-TA/LA	
Dimensions (Width x Height x Depth)	with stand	462.0 x 373.0 x 182.0 mm 18.2 x 14.7 x 7.2 inches	529.1 x 416.6 x 196.0 mm 20.9 x 16.4 x 7.7 inches	668.0 x 538.3 x 236 mm 26.2 x 21.1 x 9.3 inches	
	without stand	462.0 x 305.0 x 65.0 mm 18.2 x 12.0 x 2.6 inches	529.1 x 342.3 x 65.0 mm 20.9 x 13.5 x 2.6 inches	668.0 x 456 x 81.0 mm 26.3 x 17.9 x 3.1 inches	
Weight	with stand	4.4 kg / 9.7 lbs	5.4 kg / 11.9 lbs	8.9 kg / 19.6 lbs	
	without stand	3.7 kg / 8.2 lbs	4.6 kg / 10.2 lbs	7.7 kg / 17 lbs	
Power requirement		AC100-240V~ 50/60Hz	AC100-240V~ 50/60Hz	AC100-240V~ 50/60Hz	
MODELS		32LH6***	42LH6***		
		32LH60YR-TA/LA	42LH60YR-TA/LA		
Dimensions (Width x Height x Depth)	with stand	805.6 x 626 x 333 mm 31.7 x 24.6 x 13.1 inches	1037.8 x 794.6 x 379.5 mm 40.9x 31.3 x 14.9 inches		
	without stand	805.6x 587.4x 96.2mm 31.7 x 23.1 x 3.7 inches	1037.8x 747x 80.8mm 40.9 x 29.4 x 3.2 inches		
Weight	with stand	14.4 kg / 31.7 lbs	21.4 kg / 47.2 lbs		
	without stand	12.2 kg / 26.9 lbs	20.4 kg / 45 lbs		
Power requirement		AC100-240V~ 50/60Hz	AC100-240V~ 50/60Hz		
Television System		PAL/SECAM B/G/D/K, PAL I/II, NTSC-M			
Program Coverage		VHF: NZ1 ~E21, UHF: E21 ~ E69, CATV: S1 ~ S20, HYPER: S21 ~ S47			
External Antenna Impedance		75 Ω			
Environment condition	Operating Temperature	0 ~ 40°C / 32 ~ 104°F			
	Operating Humidity	Less than 80%			
	Storage Temperature	-20 ~ 60°C / -4 ~ 140°F			
	Storage Humidity	Less than 85%			
Supported movie files		Refer to p. 76			

■ The specifications shown above may be changed without prior notice for quality improvement.

# APPENDIX

MODELS		37LH5***	42LH5***	47LH5***	55LH5***
		37LH50YR-TA/LA	42LH50YR-TA/LA	47LH50YR-TA/LA	55LH50YR-TA/LA
Dimensions (Width x Height x Depth)	with stand	940.8 x 665.2x 296.2mm 371x 26.2 x 11.7 inches	1052.2 x 719.1 x 296.2mm 41.5x 28.3 x 11.7 inches	1173.4 x 789.7x 337.4mm 46.2x 31.1 x 13.3 inches	1357.0 x 901.0 x 423.0 mm 53.4 x 35.5 x 16.7 inches
	without stand	940.8 x 603.5x 90.6mm 371x 23.8 x 3.6 inches	1052.2 x 657.3 x 90.8mm 41.5 x 25.9 x 3.6 inches	1173.4x 723.4x 100.8mm 46.2x 28.5 x 4.0 inches	1357.0 x 835.4 x 109.6 mm 53.4 x 32.9 x 4.3 inches
Weight	with stand	16.3 kg / 35.9 lbs	19.0 kg / 41.9 lbs	23.4 kg / 51.6 lbs	36.4 kg / 80.2 lbs
	without stand	14.5 kg / 32.0lbs	17.2 kg / 37.9 lbs	20.8 kg / 45.9 lbs	32.9 kg / 72.5 lbs
Power requirement		AC100-240V~ 50/60Hz	AC100-240V~ 50/60Hz	AC100-240V~ 50/60Hz	AC100-240V~ 50/60Hz
MODELS		32LH7***	37LH7***	42LH7***	47LH7***
		32LH70YR-TA/LA	37LH70YR-TA/LA	42LH70YR-TA/LA	47LH70YR-TA/LA
Dimensions (Width x Height x Depth)	with stand	803 x 632.9 x 284.8 mm 31.6 x 24.9 x 11.2 inches	903x 689.1x 299.5mm 35.5x 27.1 x 11.7inches	1009.7 x 753.6 x 334.4 mm 39.7 x 29.6x 13.1 inches	1123.5 x 823.4x 372.8 mm 44.2 x 32.4 x 14.7 inches
	without stand	803 x 584.2 x 75mm 31.6 x 23 x 2.9 inches	903 x 639.4x 51.8mm 35.5 x 25.1 x 2.0inches	1009.7 x 695.4 x 39.7 mm 39.7 x 27.3 x 1.5inches	1123.5 x 765.4x 40.9 mm 44.2 x 30.1 x 1.6inches
Weight	with stand	13.5kg / 29.7 lbs	16.2kg / 35.7 lbs	19.8 kg / 43.7 lbs	26.4 kg / 58.2 lbs
	without stand	11.6kg / 25.5 lbs	14.1 kg / 31.0lbs	17.2 kg / 37.9lbs	22.8 kg / 50.2 lbs
Power requirement		AC100-240V~ 50/60Hz	AC100-240V~ 50/60Hz	AC100-240V~ 50/60Hz	AC100-240V~ 50/60Hz
MODELS		42LH9***		47LH9***	
		42LH90QR-TA/LA		47LH90QR-TA/LA	
Dimensions (Width x Height x Depth)	with stand	1065.9 x 776 x 361.7 mm 42 x 30.5 x 14.2 inches		1179 x 851.4 x 398.8 mm 46.4x 33.5 x 15.7 inches	
	without stand	1065.9 x 716.4 x 94.4 mm 42 x 28.2 x 3.7 inches		1179 x 780.6 x 105.9 mm 46.4 x 30.7 x 4.2 inches	
Weight	with stand	23.2 kg / 51.1 lbs		27.3 kg / 60.1 lbs	
	without stand	19.5 kg / 42.9 lbs		23.5 kg / 51.8 lbs	
Power requirement		AC100-240V~ 50/60Hz		AC100-240V~ 50/60Hz	
Television System		PAL/SECAM B/G/D/K, PAL I/II, NTSC-M			
Program Coverage		VHF: NZ1 ~E21, UHF: E21 ~ E69, CATV: S1 ~ S20, HYPER: S21 ~ S47			
External Antenna Impedance		75 Ω			
Environment condition	Operating Temperature	0 ~ 40°C / 32 ~ 104°F			
	Operating Humidity	Less than 80%			
	Storage Temperature	-20 ~ 60°C / -4 ~ 140°F			
	Storage Humidity	Less than 85%			
Supported movie files		Refer to p. 76			

■ The specifications shown above may be changed without prior notice for quality improvement.

# IR CODES

## 1. How to Connect

- Connect your wired remote control to the Remote Control port on the TV.

## 2. Remote Control IR Codes

### ■ Output waveform

Single pulse, modulated with 37.917KHz signal at 455KHz

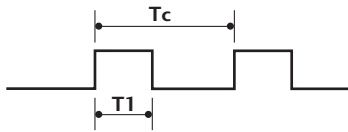

Carrier frequency  
 $FCAR = 1/T_C = f_{OSC}/12$   
 Duty ratio =  $T_1/T_C = 1/3$

### ■ Configuration of frame

1st frame

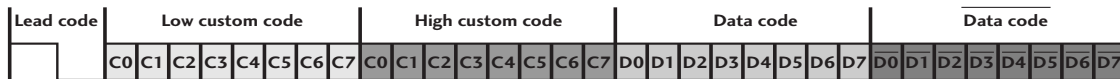

Repeat frame

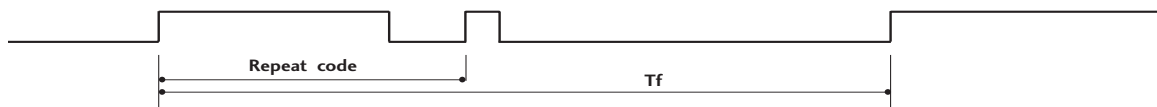

### ■ Lead code

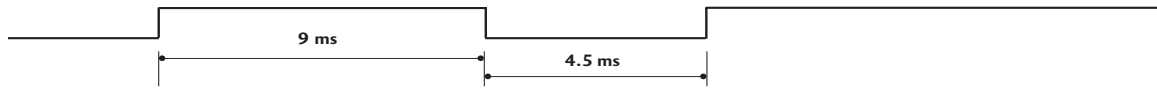

### ■ Repeat code

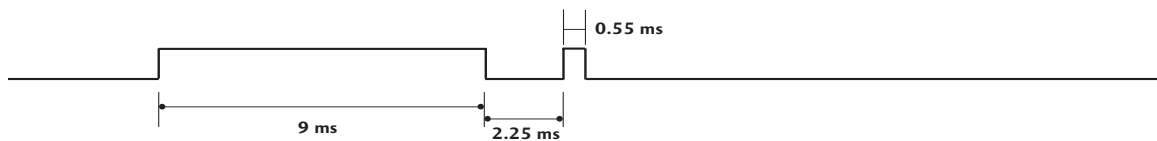

### ■ Bit description



### ■ Frame interval: $T_f$

The waveform is transmitted as long as a key is depressed.

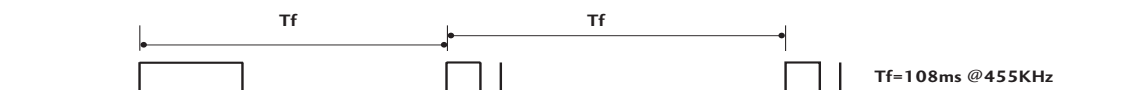

# APPENDIX

- This feature is not available for all models.

Code (Hexa)	Function	Note
08	POWER	R/C BUTTON (POWER ON/OFF)
0B	INPUT	R/C BUTTON
79	RATIO	R/C BUTTON
45	Q.MENU	R/C BUTTON
43	MENU	R/C BUTTON
1E	MARK	R/C BUTTON
07	Left (<)	R/C BUTTON
06	Right (>)	R/C BUTTON
40	Up (^)	R/C BUTTON
41	Down (v)	R/C BUTTON
44	OK(⊙)	R/C BUTTON
28	RETURN	R/C BUTTON
95	Energy Saving	R/C BUTTON
30	AV MODE	R/C BUTTON
02	⏏ +	R/C BUTTON
03	⏏ -	R/C BUTTON
00	P ^	R/C BUTTON
01	P v	R/C BUTTON
1E	FAV	R/C BUTTON
09	MUTE	R/C BUTTON
10 ~19	Number Key 0~9	R/C BUTTON
53	LIST	R/C BUTTON
1A	Q.VIEW	R/C BUTTON
72	RED Key	R/C BUTTON
71	GREEN Key	R/C BUTTON
63	YELLOW Key	R/C BUTTON
61	BLUE Key	R/C BUTTON
20	TEXT	R/C BUTTON
21	T.Option	R/C BUTTON
0E	SLEEP	R/C BUTTON
7E	SIMPLINK	R/C BUTTON
7C	<b>X</b> STUDIO	R/C BUTTON
71	■ Stop	R/C BUTTON
63	▶ Play	R/C BUTTON
61	Pause	R/C BUTTON
21	◀◀ Rew	R/C BUTTON
8E	▶▶ FF	R/C BUTTON

# EXTERNAL CONTROL DEVICE SETUP

## RS-232C Setup

Connect the RS-232C (serial port) input jack to an external control device (such as a computer or an A/V control system) to control the product's functions externally.

Connect the serial port of the control device to the RS-232C jack on the product back panel.

Note: RS-232C connection cables are not supplied with the product.

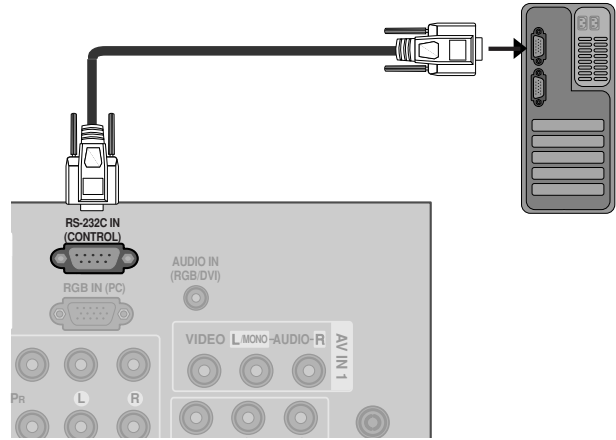

## Type of Connector; D-Sub 9-Pin Male

No.	Pin Name
1	No connection
2	RXD (Receive data)
3	TXD (Transmit data)
4	DTR (DTE side ready)
5	GND
6	DSR (DCE side ready)
7	RTS (Ready to send)
8	CTS (Clear to send)
9	No Connection

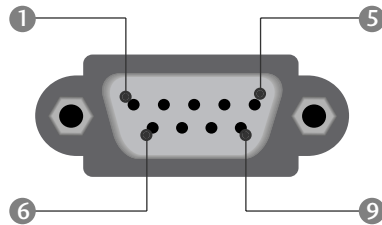

## RS-232C Configurations

### 7-Wire Configurations (Standard RS-232C cable)

	PC	TV	
RXD	2	3	TXD
TXD	3	2	RXD
GND	5	5	GND
DTR	4	6	DSR
DSR	6	4	DTR
RTS	7	8	CTS
CTS	8	7	RTS
	D-Sub 9	D-Sub 9	

### 3-Wire Configurations (Not standard)

	PC	TV	
RXD	2	3	TXD
TXD	3	2	RXD
GND	5	5	GND
DTR	4	6	DTR
DSR	6	4	DSR
RTS	7	7	RTS
CTS	8	8	CTS
	D-Sub 9	D-Sub 9	

# APPENDIX

## Set ID

Use this function to specify a set ID number.  
Refer to 'Real Data Mapping'. ▶ p.122

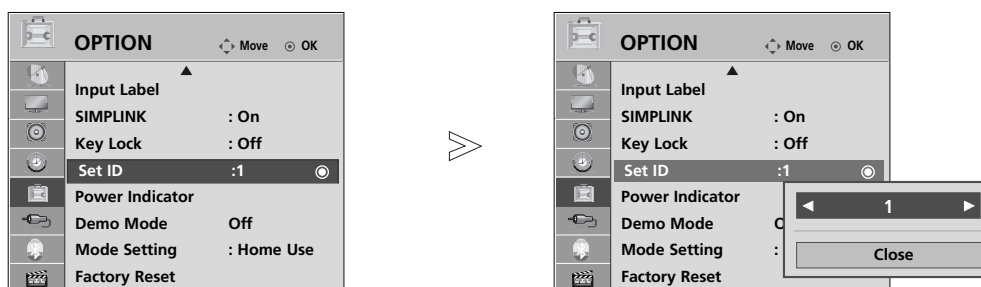

1   Select **OPTION**.

2   Select **Set ID**.

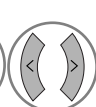
3   Adjust **Set ID** to choose the desired TV ID number.  
The adjustment range of SET ID is 1~99.

• Press **RETURN** to move to the previous menu screen.



## Communication Parameters

- Baud rate : 9600 bps (UART)
- Data length : 8 bits
- Parity : None
- Stop bit : 1 bit
- Communication code : ASCII code
- Use a crossed (reverse) cable.

## Command Reference List

	COMMAND1	COMMAND2	DATA (Hexadecimal)		COMMAND1	COMMAND2	DATA (Hexadecimal)
01. Power	k	a	00 ~ 01	13. Balance	k	t	00 ~ 64
02. Aspect Ratio	k	c	Refer to p.120	14. Colour Temperature	k	u	00 ~ 02
03. Screen Mute	k	d	Refer to p.120	15. Abnormal Status	k	z	FF
04. Volume Mute	k	e	00 ~ 01	16. Auto Configure	j	u	01
05. Volume Control	k	f	00 ~ 64	17. Channel Add/Del	m	b	00 ~ 01
06. Contrast	k	g	00 ~ 64	18. Key	m	c	Key Code
07. Brightness	k	h	00 ~ 64	19. Input select (Main)	x	b	Refer to p.122
08. Colour	k	i	00 ~ 64	20. Control Back Light	m	g	00 ~ 64
09. Tint	k	j	00 ~ 64	21. Energy Saving	j	q	00 ~ 05
10. Sharpness	k	k	00 ~ 64	22. Tune Command	m	a	Refer to p.123
11. OSD Select	k	l	00 ~ 01				
12. Remote Control Lock /Key Lock Mode	k	m	00 ~ 01				

## Transmission / Receiving Protocol

### Transmission

**[Command1][Command2][ ][Set ID][ ][Data][Cr]**

[Command 1] : First command to control the set.(j,k,m or x)

[Command 2] : Second command to control the set.

[Set ID] : You can adjust the set ID to choose desired TV ID number in Setup menu. Adjustment range is 1 ~ 99. When selecting Set ID '0', every connected TV is controlled. Set ID is indicated as decimal (1 ~ 99) on menu and as Hexa decimal (0x0 ~ 0x63) on transmission/receiving protocol.

[DATA] : To transmit command data.

Transmit 'FF' data to read status of command.

[Cr] : Carriage Return

ASCII code '0x0D'

[ ] : ASCII code 'space (0x20)'

### OK Acknowledgement

**[Command2][ ][Set ID][ ][OK][Data][x]**

The TV transmits ACK (acknowledgement) based on this format when receiving normal data. At this time, if the data is data read mode, it indicates present status data. If the data is data write mode, it returns the data of the PC computer.

### Error Acknowledgement

**[Command2][ ][Set ID][ ][NG][Data][x]**

TV transmits ACK(acknowledgement) based on this format when receiving abnormal data form non-viable functions or communication errors.

[Command 2] : use as command.

[Set ID]: use the small character, if set ID is 10, TV will send the '0'; 'a'

[Data]: use the small character, if data is 0xab, TV will send the 'a'; 'b'.

[NG]: use the large character.

# APPENDIX

## 01. Power (Command: k a)

To control Power On/Off of the TV.

*Transmission* [k][a][ ][Set ID][ ][Data][Cr]

Data 00 : Power Off      Data 01 : Power On

*Acknowledgement* [a][ ][Set ID][ ][OK/NG][Data][x]

To show Power On/Off.

*Transmission* [k][a][ ][Set ID][ ][FF][Cr]

*Acknowledgement* [a][ ][Set ID][ ][OK/NG][Data][x]

\* If there is the time delay between command and ack message during power on sequence, It should be described like "Note: In this model, TV will send the Acknowledge after power on processing completion. There might be a time delay between command and acknowledge."

## 02. Aspect Ratio (Command: k c) (Main picture size)

To adjust the screen format. (Main picture format)

You can adjust the screen format using the Aspect Ratio in the PICTURE menu.

*Transmission* [k][c][ ][Set ID][ ][Data][Cr]

Data 01: Normal screen (4:3)      Data 07: 14:9  
Data 02: Wide screen (16:9)      Data 09: Just Scan  
Data 04: Zoom                      Data 10~1f: Cinema Zoom  
Data 06: Original

*Acknowledgement* [c][ ][Set ID][ ][OK/NG][Data][x]

\* Using the RGB-PC, Component or HDMI input, you select either 16:9 or 4:3 screen aspect ratio.

\* In HDMI/Component (over 720p) mode, **Just Scan** is available.

## 03. Screen Mute (Command: k d)

To select screen mute on/off.

*Transmission* [k][d][ ][Set ID][ ][Data][Cr]

Data 00 : Screen mute off (Picture on)  
Data 01 : Screen mute on (Picture off)  
Data 00 : Video Mute off  
Data 10 : Video Mute on

*Acknowledgement* [d][ ][Set ID][ ][OK/NG][Data][x]

## 04. Volume Mute (Command: k e)

To control volume mute on/off.

You can also adjust mute using the MUTE button on remote control.

*Transmission* [k][e][ ][Set ID][ ][Data][Cr]

Data 00 : Volume mute on (Volume off)  
Data 01 : Volume mute off (Volume on)

*Acknowledgement* [e][ ][Set ID][ ][OK/NG][Data][x]

## 05. Volume Control (Command: k f)

To adjust volume.

You can also adjust volume with the volume buttons on remote control.

*Transmission* [k][f][ ][Set ID][ ][Data][Cr]

Data Min : 00 ~ Max : 64

Refer to 'Real data mapping 1'. See page 122.

*Acknowledgement* [f][ ][Set ID][ ][OK/NG][Data][x]

## 06. Contrast (Command: k g)

To adjust screen contrast.

You can also adjust contrast in the PICTURE menu.

*Transmission* [k][g][ ][Set ID][ ][Data][Cr]

Data Min : 00 ~ Max : 64

Refer to 'Real data mapping 1'. See page 122.

*Acknowledgement* [g][ ][Set ID][ ][OK][Data][x]

## 07. Brightness (Command: k h)

To adjust screen brightness.

You can also adjust brightness in the PICTURE menu.

*Transmission* [k][h][ ][Set ID][ ][Data][Cr]

Data Min : 00 ~ Max : 64

Refer to 'Real data mapping 1'. See page 122.

*Acknowledgement* [h][ ][Set ID][ ][OK/NG][Data][x]

## 08. Colour (Command: k i)

To adjust the screen colour.

You can also adjust colour in the PICTURE menu.

*Transmission* [k][i][ ][Set ID][ ][Data][Cr]

Data Min : 00 ~ Max : 64

Refer to 'Real data mapping 1'. See page 122.

*Acknowledgement* [i][ ][Set ID][ ][OK/NG][Data][x]

## 09. Tint (Command: k j)

To adjust the screen tint.

You can also adjust tint in the PICTURE menu.

*Transmission* [k][j][ ][Set ID][ ][Data][Cr]

Data Red : 00 ~ Green : 64

Refer to 'Real data mapping 1'. See page 122.

*Acknowledgement* [j][ ][Set ID][ ][OK/NG][Data][x]

**10. Sharpness (Command: k k)**

To adjust the screen sharpness.

You can also adjust sharpness in the PICTURE menu.

*Transmission* [k][k][ ][Set ID][ ][Data][Cr]

Data Min: 00 ~ Max: 64

Refer to 'Real data mapping 1'. See page 122.

*Acknowledgement* [k][ ][Set ID][ ][OK/NG][Data][x]

**11. OSD Select (Command: k l)**

To select OSD (On Screen Display) on/off when controlling remotely.

*Transmission* [k][l][ ][Set ID][ ][Data][Cr]

Data 00: OSD off

Data 01: OSD on

*Acknowledgement* [l][ ][Set ID][ ][OK][Data][x]

**12. Remote Control Lock/Key Lock Mode (Command: k m)**

To lock the remote control and the front panel controls on the set.

*Transmission* [k][m][ ][Set ID][ ][Data][Cr]

Data 00: Lock off

Data 01: Lock on

*Acknowledgement* [m][ ][Set ID][ ][OK/NG][Data][x]

\* When main power is on/off, remote control lock is released.

\* In the standby mode, if key lock is on, TV will not turn on by power on key of IR & Local Key.

**13. Balance (Command: k t)**

To adjust balance.

You can also adjust balance in the AUDIO menu.

*Transmission* [k][t][ ][Set ID][ ][Data][Cr]

Data Min: 00 ~ Max: 64

Refer to 'Real data mapping 1'. See page 122.

*Acknowledgement* [t][ ][Set ID][ ][OK/NG][Data][x]

**14. Colour Temperature (Command: k u)**

To adjust colour temperature.

You can also adjust Colour Temperature in the PICTURE menu.

*Transmission* [k][u][ ][Set ID][ ][Data][Cr]

Data 00: Medium 01: Cool 02: Warm

*Acknowledgement* [u][ ][Set ID][ ][OK/NG][Data][x]

**15. Abnormal State (Command: k z)**

To recognize an abnormal state.

*Transmission* [k][z][ ][Set ID][ ][FF][ ][Cr]

Data FF: Read

*Acknowledgement* [z][ ][Set ID][ ][OK/NG][Data][x]

Data 00: Normal (Power on and signal exist)

Data 01: No signal (Power on)

Data 02: Turn the TV off by remote control

Data 03: Turn the TV off by sleep time function

Data 04: Turn the TV off by RS-232C function

Data 05: 5V down

Data 06: AC down

Data 07: Turn the TV off by Fan Alarm function (option)

Data 08: Turn the TV off by Off time function

Data 09: Turn the TV off by Auto off function

Data a: Turn the TV off by AV board detection.

\* This function is "read only".

**16. Auto Configure (Command: j u)**

To adjust picture position and minimize image shaking automatically. It works only in RGB (PC) mode.

*Transmission* [j][u][ ][Set ID][ ][Data][Cr]

Data 01: To set

*Acknowledgement* [u][ ][Set ID][ ][OK/NG][Data][x]

**17. Channel Skip (Command: m b)**

To set skip status for the current Programme.

*Transmission* [m][b][ ][Set ID][ ][Data][Cr]

Data 00 : Skip 01 : Add

*Acknowledgement* [b][ ][Set ID][ ][OK/NG][Data][x]

**18. Key (Command: m c)**

To send IR remote key code.

*Transmission* [m][c][ ][Set ID][ ][Data][Cr]

Data: Key code - Refer to page 116.

*Acknowledgement* [c][ ][Set ID][ ][OK/NG][Data][x]

# APPENDIX

## 19. Input select (Command: x b)

### (Main Picture Input)

To select input source for TV.

Transmission [x][b][ ][Set ID][ ][Data][Cr]

Data: Structure

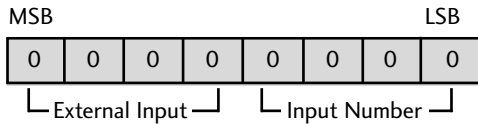

External Input				Data
0	0	0	1	Analog
0	0	1	0	AV
0	1	0	0	Component
0	1	1	0	RGB-PC
1	0	0	1	HDMI

Input Number				Data
0	0	0	0	Input1
0	0	0	1	Input2
0	0	1	0	Input3
0	0	1	1	Input4

Acknowledgement [b][ ][Set ID][ ][OK/NG][Data][x]

## 20. Control Back Light (Command: m g)

To Control the back light.

Transmission [m][g][ ][Set ID][ ][Data][Cr]

Data : data Min: 00 ~ Max: 64

(\* transmit by Hexadecimal code)

Acknowledgement [g][ ][Set ID][ ][OK/NG][Data][x]

## 21. Energy Saving (Command: j q)

To reduce the power consumption of the TV. You can also adjust Energy Saving in OPTION menu.

Transmission [j][q][ ][Set ID][ ][Data][Cr]

Data Min: 00H ~ Max: 05H

Data 00 : Off

01 : Minimum

02 : Medium

03 : Maximum

04 : Auto (Except 19/22/26/32/37/42LH2\*\*\*, 32/42LF2\*\*\*, 32/37/42/47LH3\*\*\*, 19/22/26LU5\*\*\*)

05 : Screen Off

Acknowledgement [q][ ][Set ID][ ][OK/NG][Data][x]

### \* Real data mapping 1

- 00 : Step 0
- ⋮
- A : Step 10
- ⋮
- F : Step 15
- 10 : Step 16
- ⋮
- 64 : Step 100
- ⋮
- 6E : Step 110
- ⋮
- 73 : Step 115
- 74 : Step 116
- ⋮
- C7 : Step 199
- ⋮
- FE : Step 254
- FF : Step 255

## 22 . Tune Command / Channel Tuning (Command: m a)

Tune Channel to following Physical number.

```
Transmission [m][a][ ][Set ID][ ][Data0][ ][Data1]
[ ][Data2][Cr]
```

Data0, Data1: Programme Number

Data0: High byte

Data1: Low byte

Data2: Attribute

### Air

7 Reserved	6 Reserved	5 Reserved	4 Reserved	RF Source	3 Reserved	2 Reserved	1 Reserved	0	
								Data	Main / Sub
0	x	0	0	ATV	x	x	x	0	Main picture
0	x	0	1	DTV	x	x	x	1	Sub picture
0	x	1	0	Radio					
0	x	1	1	Reserved					

### Cable

7 Reserved	6 Reserved	5 Reserved	4 Reserved	RF Source	3 Reserved	2 Reserved	1 Reserved	0	
								Data	Main / Sub
1	x	0	0	ATV	x	x	x	0	Main picture
1	x	0	1	DTV	x	x	x	1	Sub picture
1	x	1	0	Radio					
1	x	1	1	Reserved					

'x' : don't care

```
Acknowledgement [a][ ][Set ID][OK][ ][Data0][Data1][x]
[a][ ][Set ID][NG][ ][Data0][x]
```

**LG Electronics Inc.**