

# User's Guide

---

## M197WA

Make sure to read the **Safety Precautions** before using the product.

Keep the User's Guide(CD) in an accessible place for future reference.

See the label attached on the product and give the information to your dealer when you ask for service.



# Before Connecting to the PC

## Stand Installation

- Before setting up the product, ensure that the power supply, the computer system, and other attached devices is turned off.

**1** Carefully place the product screen side down on a cushioned surface that will protect product and screen from damage.

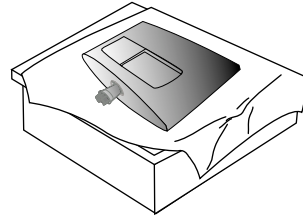

**2** Insert the **stand base** into the product

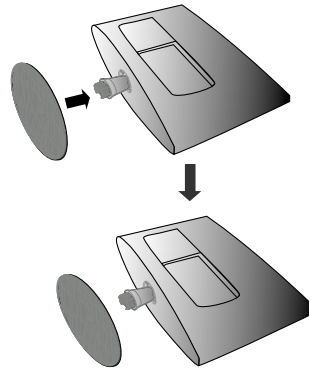

**3** Attach the monitor to the Stand Base by turning the screw to the right.

\* Turn the screw by using the screw handle

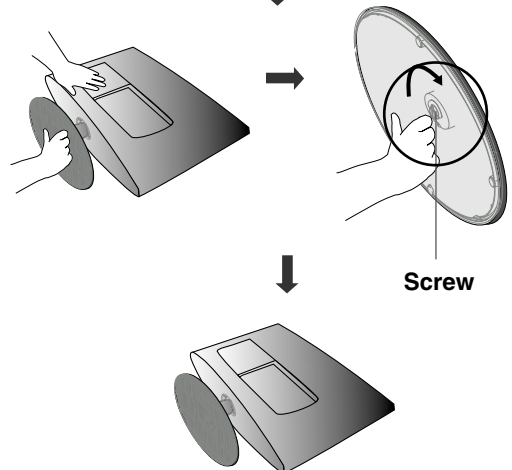

# Before Connecting to the PC

## Detaching Stand

- Before setting up the product, ensure that the power supply, the computer system, and other attached devices is turned off.

1 Place the set screen side down on a cushion or soft cloth.

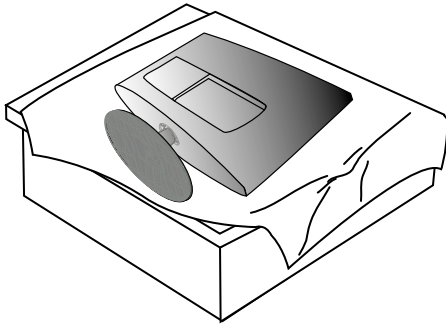

2 Detach the monitor to the Stand Base by turning the screw to the left.

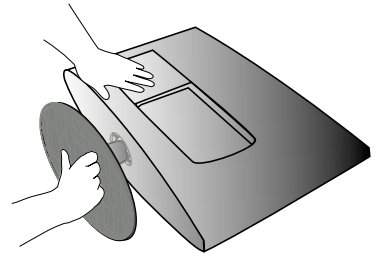

3 Turn the screw by using the screw handle

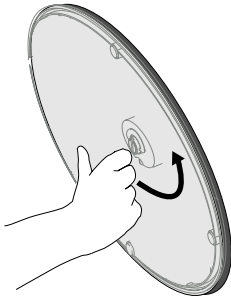

4 Pull the stand base.

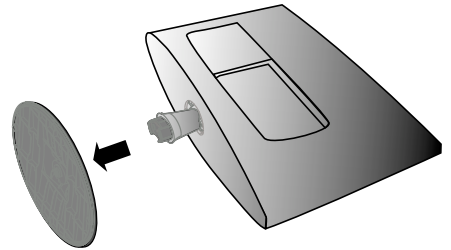

5

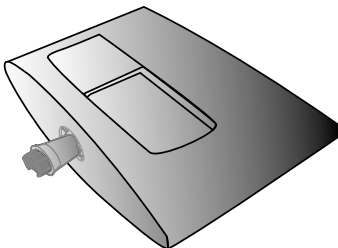

# Before Connecting to the PC

- Before setting up the product, ensure that the power supply, the computer system, and other attached devices is turned off.

## Positioning your display

1. Adjust the position of the panel in various ways for maximum comfort.

- Tilt Range

-6° ~ -2°

12° ~ 18°

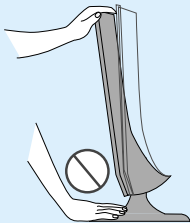
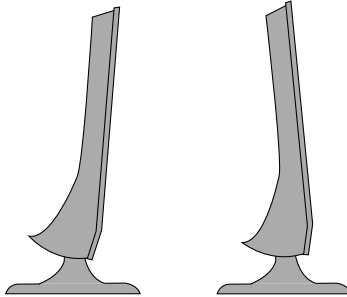

### Warning:

When adjusting the angle of the screen, do not put your finger(s) in between the head of the monitor and the stand body. You can hurt your finger(s).

## Theft prevention locking device

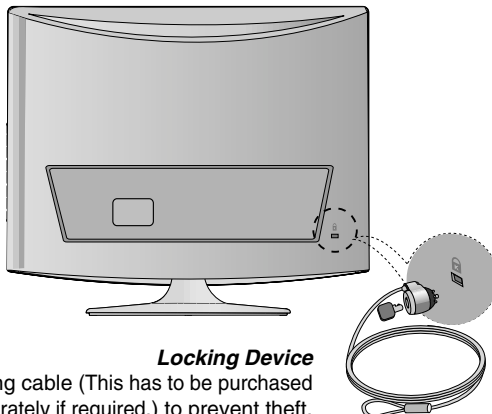

### Locking Device

Use this locking cable (This has to be purchased separately if required.) to prevent theft.

# Before Connecting to the PC

## WALL MOUNT:HORIZONTAL INSTALLATION

For proper ventilation, allow a clearance of 4 inches on each side and from the wall. Detailed installation instructions are available from your dealer, see the optional Tilt Wall Mounting Bracket Installation and Setup Guide.

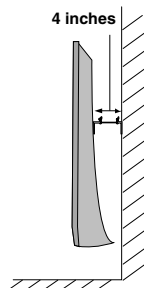
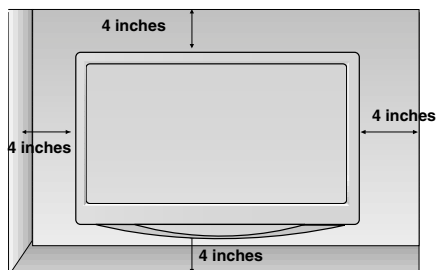
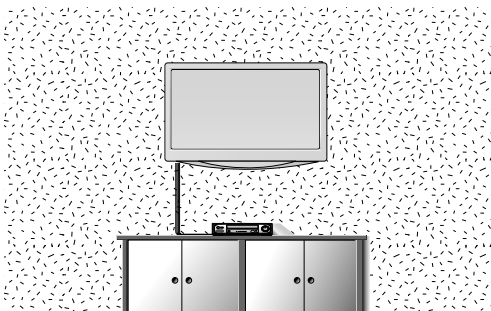

## LOCATION

Position your set so that no bright light or sunlight falls directly onto the screen. Care should be taken not to expose the set to any unnecessary vibration, moisture, dust or heat. Also, ensure that the set is placed in a position to allow a free flow of air. Do not cover the ventilation openings on the back cover. If you intend to mount the set to a wall, attach Wall mounting interface (optional parts) to the back of the set. When you install the set using the wall mounting interface (optional parts), attach it carefully so it will not drop.

- Be sure to use screws and a wall mount that meet VESA standards.
- Using screws longer than those recommended might damage the product.
- Using screws that do not meet VESA standards might either damage the product or result in it coming away from the wall. We will not be held responsible for any damage resulting from failure to follow these instructions.

<Screw Mounting Interface Dimension >  
100mm x 100mm hole spacing

# Name and Function of the Parts

## Name of the Remote Control Buttons

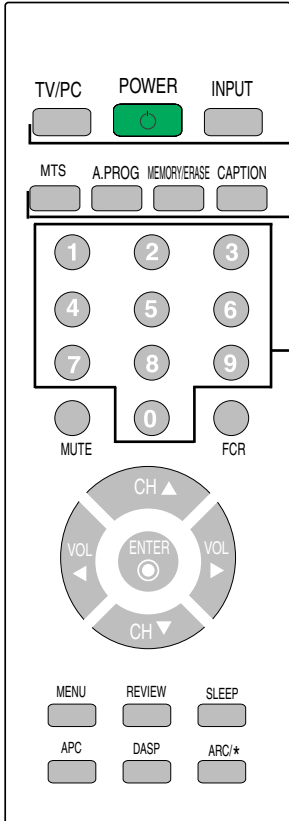

**TV/PC** : Selects TV or PC mode.  
Switches the set on.

### POWER INPUT

#### Input

✓ TV  
 AV  
 Component  
 RGB  
 DVI  
 HDMI

Each time you press the Input button it will change to

TV → AV → Component → RGB → DVI → HDMI

If nothing is inputted for several seconds the screen will automatically move to the selected menu.

▲▼ OK

### MTS

Press repeatedly to select **Mono, Stereo, SAP** sound tone.

But **Stereo, SAP** mode are available only if included on the broadcast signal.

### A.PROG

Auto Channel Button

PC: Automatic adjustment function (Operational for the analog signal only)

### MEMORY/ERASE

User can do manual channel selection and store or erase individual channels.

### CAPTION

Select a closed caption

Off → Mode1 → Mode2 → Text1 → Text2

### Number buttons

Able to directly select and change channel.

## Inserting batteries into remote control.

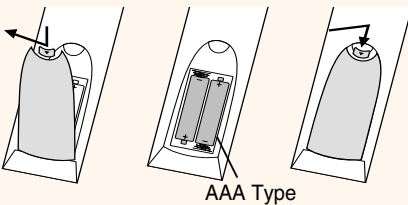

AAA Type

1. Take out the battery cap.

2. Insert the batteries with correct polarity (+/-).

3. Close the battery cap.

- Dispose of used batteries in the recycle bin to prevent environmental pollution.

# Name and Function of the Parts

## ● Name of the Remote Control Buttons

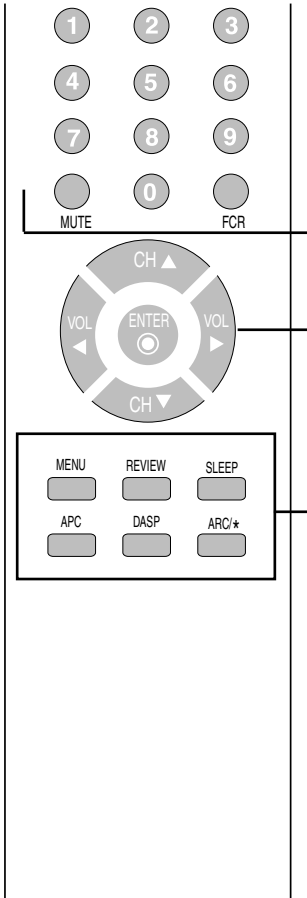

### MUTE

Switches the sound on or off.

### FCR

Favorite channel button.

### CH ( ▲ ▼ ) Buttons

Up and Down Button.  
Able to change channel.

### VOL ( ◀ ▶ ) Buttons

Volume Button

### ENTER Button

Use when functional adjustment is completed.

### MENU

Use this button to enter the On Screen Display menu.

### REVIEW

Turn to the last channel viewed.

### SLEEP : SLEEP Timer

You can set a time period after which the all modes should switch itself to standby.

Press the key repeatedly to select the number of minutes.

Press the key repeatedly to select the number of minutes.

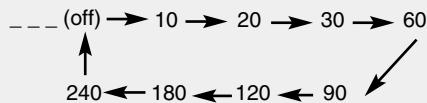

### APC Button(Auto Picture Control)

Press repeatedly to select **Clear**, **Optimum**, **Soft**, **User** picture mode.

### DASP Button (Digital Auto Sound Processing)

Use this button to select the sound tone.

Press repeatedly to select **Flat**, **Music**, **Movie**, **Sports**, **User** sound tone.

### ARC/\*

To select the image size of the screen.

- When TV, AV mode: 16:9, Horizon, Zoom1, Zoom2, 4:3
- When RGB/DVI/HDMI/Component mode: 16:9, 4:3

# Name and Function of the Parts

## ● Rear View

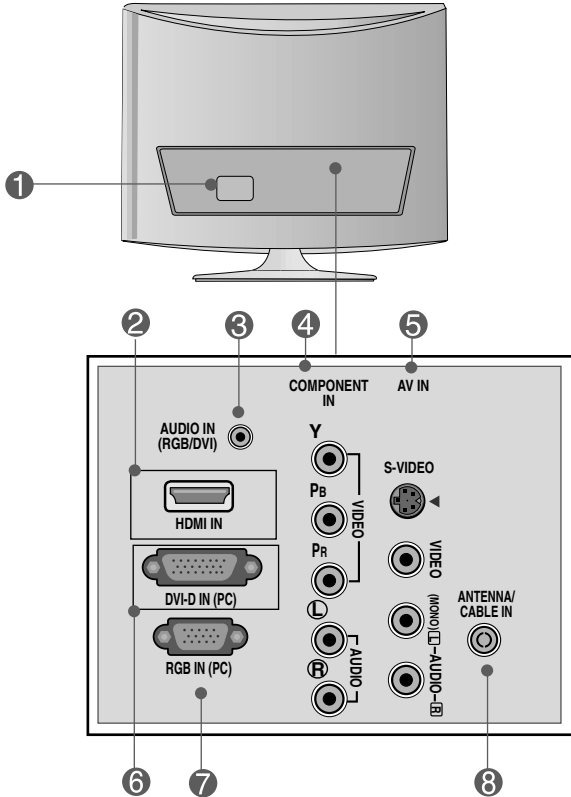

- ① Power Connector : Connect the power cord.
- ② HDMI Digital Signal Connector
- ③ RGB, DVI Sound Jack : Connect to the jack in the PC sound card.
- ④ Component Input Terminal
- ⑤ AV Input Terminal
- ⑥ DVI Digital Signal Connector
- ⑦ D-Sub Analog Signal Connector
- ⑧ TV Tuner Jack : Connect the antenna.



# Name and Function of the Parts

## ● AV Input Terminal

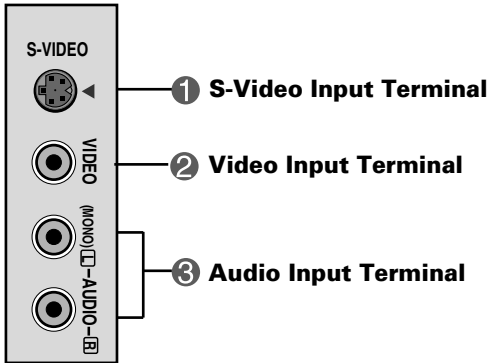

# Connecting to External Devices

## ■ ■ ■ Connecting to your PC

1. First of all, see if the computer, product and the peripherals are turned off. Then, connect the signal input cable.

Rear side of the product.

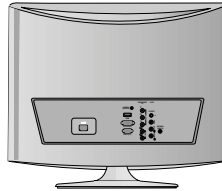

- A Connecting with the D-Sub signal input cable.

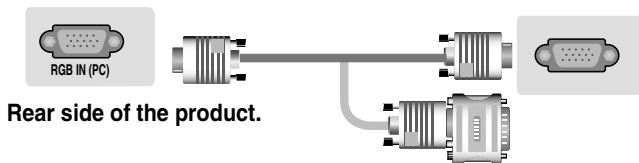

Rear side of the product.

**Macintosh Adapter (Not included)**  
Use the standard Macintosh adapter since an incompatible adapter is available in the market. (Different signaling system)

- B Connecting with the DVI signal input cable.



Rear side of the product.

2. Connect the audio cable.

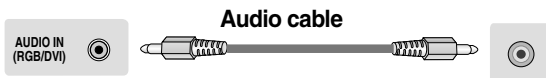

Rear side of the product.

- Make sure to check the sound card connection terminal in the PC before connecting to the product. If the PC sound card supports both Speaker Out and Line Out, change it to Line Out by setting the jumper or the PC application. (For more details, refer to the sound card user's guide.)
  - **Speaker Out** : The terminal connected to the speaker that is not equipped with an amplifier.
  - **\*Line Out** : The terminal connected to the speaker equipped with an amplifier.If Audio Out in the PC sound card has only Speaker Out, reduce the PC volume. This product is integrated with an amplifier.

# Connecting to External Devices

## 3. Connect the power cord.

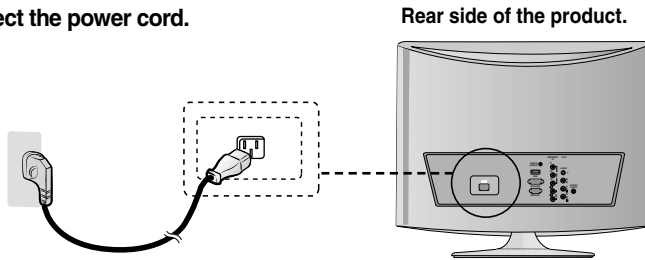

Rear side of the product.

## 4. ① Turn on power by pressing the power button on the product.

### ② Turn on the PC.

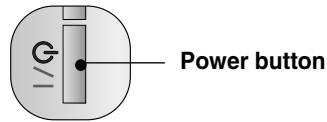

## 5. Select an input signal.

Press the INPUT button on the remote control to select the input signal.

INPUT → ENTER

Or, press the INPUT button at the top side of the product.

INPUT → ENTER

### A • Select RGB

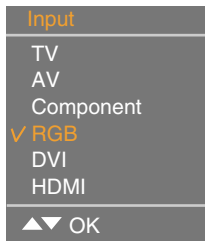

### B • Select DVI

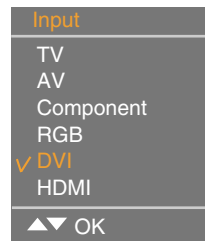

Each time you press the Input button it will change to TV → AV → Component →

RGB → DVI → HDMI

If nothing is inputted for several seconds the screen will automatically move to the selected menu.

## ● PC Mode – Preset Mode

	Preset mode	Horizontal Frequency (kHz)	Vertical Frequency (Hz)		Preset mode	Horizontal Frequency (kHz)	Vertical Frequency (Hz)
1	720 x 400	31.468	70	6	1024 x 768	48.363	60
2	640 x 480	31.469	60	7	1024 x 768	60.123	75
3	640 x 480	37.500	75	8	1280 x 768	47.776	60
4	800 x 600	37.879	60	9	1360 x 768	47.712	60
5	800 x 600	46.875	75	10	1366 x 768	47.7	60



### Note

- Directly connect to a grounded power outlet on the wall or a power bar with a ground wire.

# Connecting to External Devices

## ■ ■ ■ Connecting to VCR/DVD

1. Connect the video/audio cable as shown in the figure below and then connect the power cord (See page 10).

- (A) When using the RCA cable.**
- Connect the input terminal with a proper colour match.

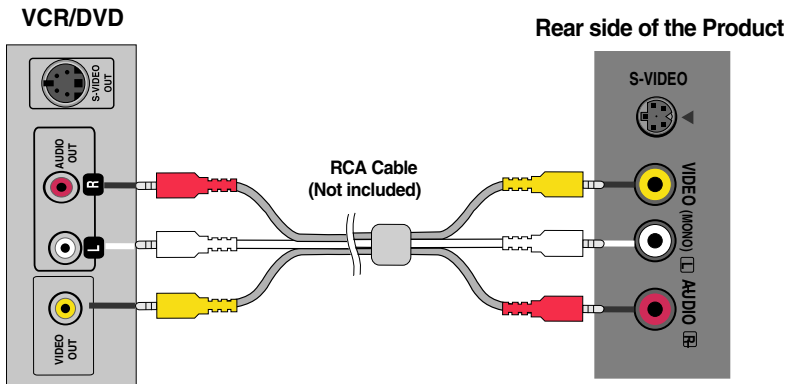

- (B) When using the S-Video cable.**
- Connect to the S-Video input terminal to watch high image quality movies.

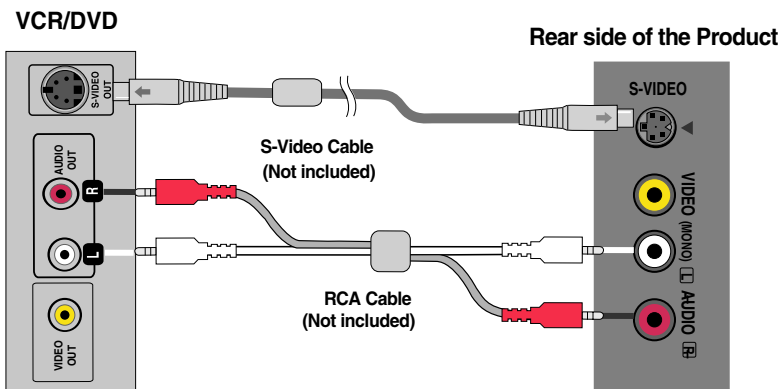

**Note** • In case the RCA cable is connected simultaneously as S-Video cable is connected, S-Video cable is first.

# Connecting to External Devices

2. Select an input signal.  
Press the **INPUT** button on the remote control to select the input signal.

INPUT → ENTER

Or, press the **INPUT** button at the top side of the product.

INPUT → ENTER

- A** When connecting with a RCA cable.  
• Select **AV**
- B** When connecting with a S-Video cable.  
• Select **AV**

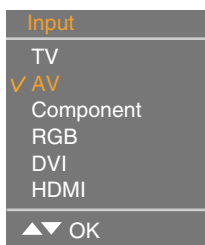

Each time you press the Input button it will change to TV → AV → Component → RGB → DVI → HDMI  
If nothing is inputted for several seconds the screen will automatically move to the selected menu.

# Connecting to External Devices

## ■ ■ ■ Connecting to Set-top Box /DVD (480p/576p/720p/1080i/480i/576i)

**1.** Connect the video/audio cable as shown in the figure below and then connect the power cord (See page 10).

- Connect the input terminal with a proper colour match.

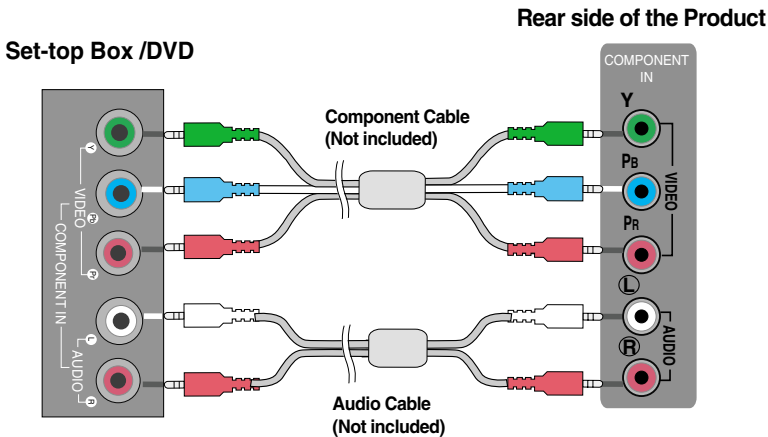

**2.** Select an input signal.  
Press the **INPUT** button on the remote control to select the input signal.

INPUT → ENTER

Or, press the **INPUT** button at the top side of the product.

INPUT → ENTER

- Select **Component**

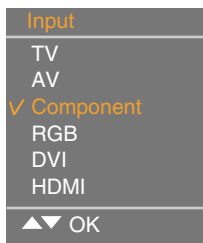

Each time you press the Input button it will change to TV → AV → Component → RGB → DVI → HDMI

If nothing is inputted for several seconds the screen will automatically move to the selected menu.

# Connecting to External Devices

## ■ ■ ■ When watching HDMI from the DVD/Set-top Box

1. Connect the HDMI cable as shown in the below figure and then connect the power cord. (see page 10)

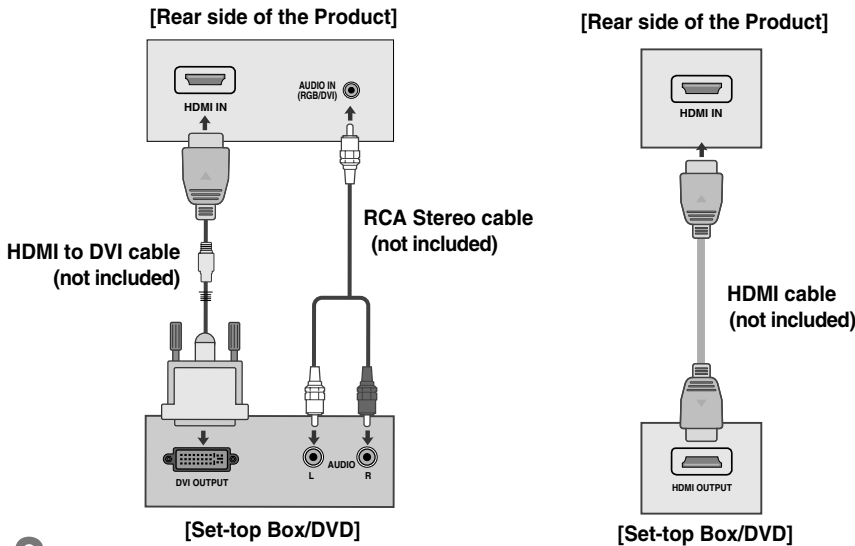

2. Select an input signal.  
Press the INPUT button on the remote control to select the input signal.

INPUT → ENTER

Or, press the INPUT button at the top side of the product.

INPUT → ENTER

• Select HDMI

Input
TV
AV
Component
RGB
DVI
✓ HDMI
▲ ▼ OK

Each time you press the Input button it will change to TV → AV → Component → RGB → DVI → HDMI.  
If nothing is inputted for several seconds the screen will automatically move to the selected menu.

### ● DTV -Timing

	Preset mode	Horizontal Frequency (kHz)	Vertical Frequency (Hz)		Preset mode	Horizontal Frequency (kHz)	Vertical Frequency (Hz)
1	720 x 480/60p	31.47	60	6	1280 x 720/60p	45	60
2	720 x 480/60p	31.5	60	7	1920 x 1080/60i	33.72	60
3	720 x 576/50p	31.25	50	8	1920 x 1080/60i	33.75	60
4	1280 x 720/50p	37.5	50	9	1920 x 1080/50i	28.125	50
5	1280 x 720/60p	44.96	60				

### Note

• HDMI Input does not support PC mode. If it is connected PC, the screen may not be displayed properly.

# Connecting to External Devices

## ■ ■ ■ When Watching TV

1. Check if the antenna cable is connected at the rear side of the product and then, connect the power cord.

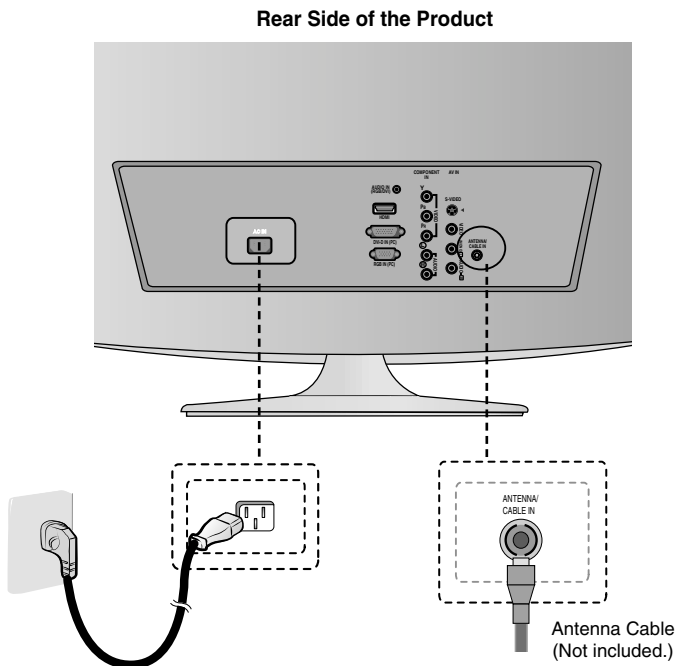

2. Select an input signal.  
Press the INPUT button on the remote control to select the input signal.

INPUT → ENTER

Or, press the INPUT button at the top side of the product.

INPUT → ENTER

- Select TV

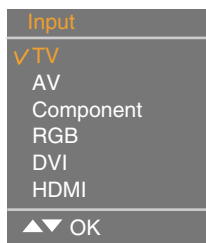

Each time you press the Input button it will change to TV → AV → Component → RGB → DVI → HDMI  
If nothing is inputted for several seconds the screen will automatically move to the selected menu.



# To arrange cables using cable management

1. Tie cables together with a cable management as shown in the illustration.

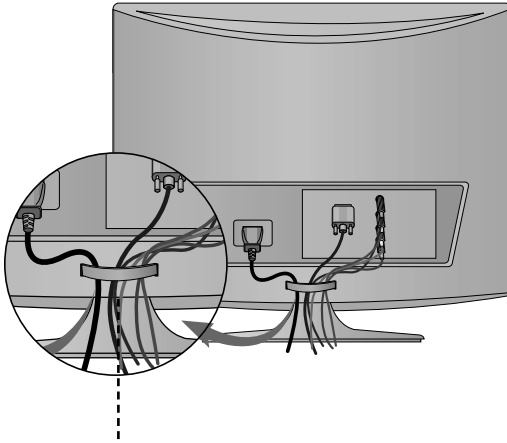

Cable management

# Adjusting the Screen

## ● Name of the Buttons in the Screen Adjustment Unit

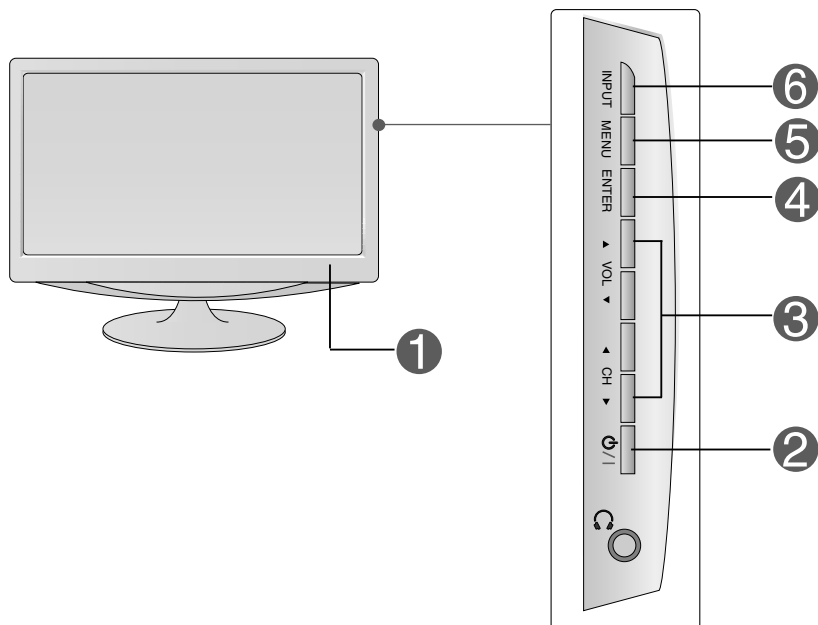

- 1 Power Indicator** • This Indicator lights up blue when the display operates normally (On Mode). If the display is in Sleep (Energy Saving) Mode, this indicator colour changes to amber.

- 2 Power Button** • Use this button to turn the product on and off.

- 3 OSD Select/Adjust Button** • Use this button to select an icon or adjust the setting in the OSD screen.

▼▲ • Use this button to control the channel for the TV signal.

◀▶ • Adjust the volume.



- 4 ENTER Button** • OK button is usually used in choosing the MENU. When there is no MENU on the screen pushing the OK button will give the information about the current input source.

# Adjusting the Screen

## 5 Name of the Buttons in the Screen Adjustment Unit

5

### MENU Button

- Use this button to show/hide the OSD (On Screen Display) menu screen.

6

### INPUT Button

<b>TV</b>	Television
<b>AV</b>	CVBS, S-Video
<b>Component</b>	HDTV, DVD
<b>RGB</b>	D-Sub analog signal
<b>DVI</b>	DVI Digital signal
<b>HDMI</b>	HDMI Digital signal

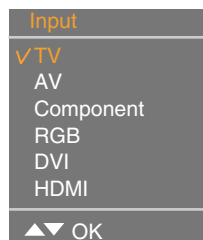







Each time you press the Input button it will change to TV → AV → Component → RGB → DVI → HDMI

If nothing is inputted for several seconds the screen will automatically move to the selected menu.

# Adjusting the Screen

## ● OSD (On Screen Display) Menu

Icon	Function Description
 Channel	Set/Select the channel when using the TV
 Picture	Adjusting the picture function.
 Sound	Adjusting the sound function.
 Time	Adjusting the time function.
 Special	Selecting the special function.
 Screen	Adjusting the screen function.



**Note** OSD(On Screen Display)

The OSD function enables you to adjust the screen status conveniently since it provides graphical presentation.

# Adjusting the Screen

## ● OSD (On Screen Display) Screen Tracking Order

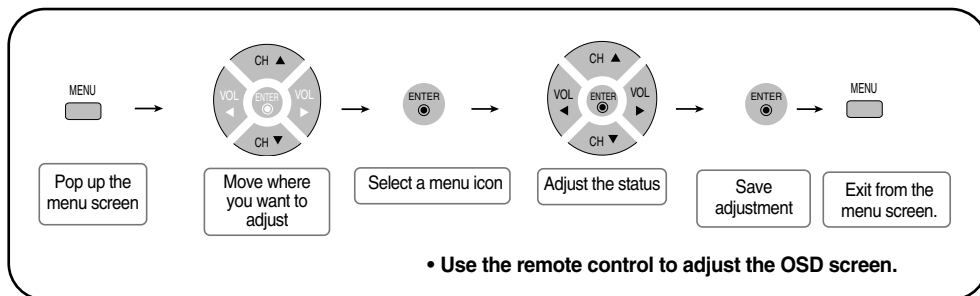

- 1 Press the **MENU** Button, then the main menu of the OSD will appear.
- 2 To access a control, use the **▼ ▲** Buttons.
- 3 When the icon you want becomes highlighted, press the **ENTER** Button.
- 4 Use the **▼ ▲ ◀ ▶** Buttons to adjust the item to the desired level.
- 5 Accept the changes by pressing the **ENTER** Button.
- 6 Exit the OSD by pressing the **MENU** Button repeatedly .

# Adjusting the Screen



## CHANNEL ID set/Select the channel when using the TV

### Auto programme

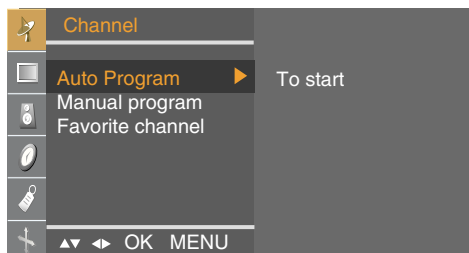

**Auto Program** Press ► button to start automatic programming. All available TV channels are searched and stored automatically. To stop Auto Program progress, press the **MENU** button.

- Wait for Auto Program progress to complete the channel search cycle before choosing a channel. The TV scans for over-the-air channels and then channels are provided by a cable service.

**Manual program** **TV/ CATV** Press ► button and then use ◀ ▶ button to select the channel.

**Erase/ Memory** User can do manual channel selection and store or erase individual channels.  
Press ► button and then use ◀ ▶ button to select a channel you want to add to memory or erase.

**Fine** In case of poor reception, you can improve the reception by fine tuning. Use the ◀ ▶ buttons to fine tune for the best picture and sound.

**Favorite channel** This function lets you select your favorite channels directly. Press the ▼ ▲ ◀ ▶ buttons to select a channel number.

\* **FCR Button (remote control)** : Rotate Favorite channel.

# Adjusting the Screen



## PICTURE ID adjust the picture function(RGB/DVI)

### APC (Auto Picture Control)

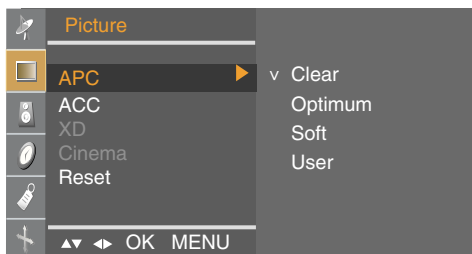

The **APC** function automatically adjusts the screen image quality.

- **Clear**  
Select this option to display with a sharp image.
- **Optimum**  
The most general and natural screen display status.
- **Soft**  
Select this option to display with a mild image.
- **User**  
Select this option to use the user-defined settings.

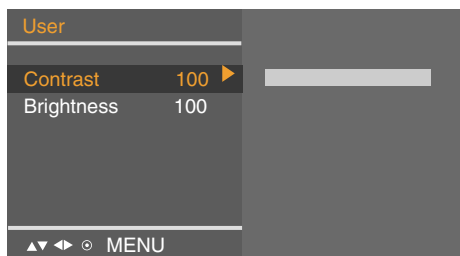

**Contrast** : To adjust the contrast of the screen.

**Brightness** : To adjust the brightness of the screen.

### ACC (Auto Color Control)

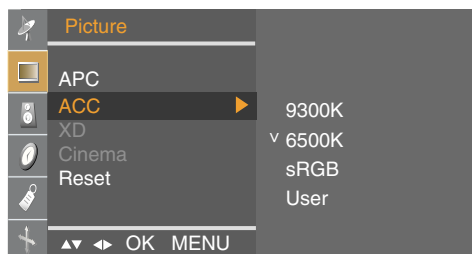

The **ACC** function automatically adjusts the screen colour set.

- **9300K**  
Slightly purplish white.
- **6500K**  
Slightly bluish white.
- **sRGB**  
Slightly lower brightness.
- **User**  
Select this option to use the user-defined settings.

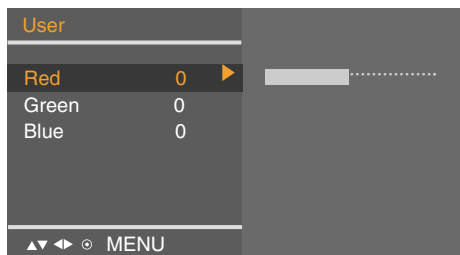

**Red / Green / Blue**

Set your own colour levels.

**Reset** Return to the default settings **APC**, **ACC** at the factory.

# Adjusting the Screen



## PICTURE ID adjust the picture function (TV/AV/Component/HDMI)

### APC (Auto Picture Control)

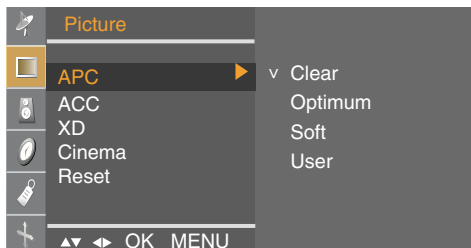

The **APC** function automatically adjusts the screen image quality.

- **Clear**  
Select this option to display with a sharp image.
- **Optimum**  
The most general and natural screen display status.
- **Soft**  
Select this option to display with a mild image.
- **User**  
Select this option to use the user-defined settings.

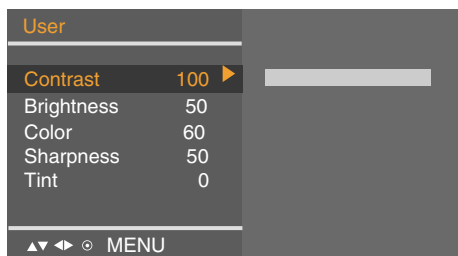

**Contrast** : To adjust the contrast of the screen.

**Brightness** : To adjust the brightness of the screen.

**Color** : To adjust the colour to desired level.

**Sharpness** : To adjust the clearness of the screen.

**Tint** : To adjust the tint to desired level.

### ACC (Auto Color Control)

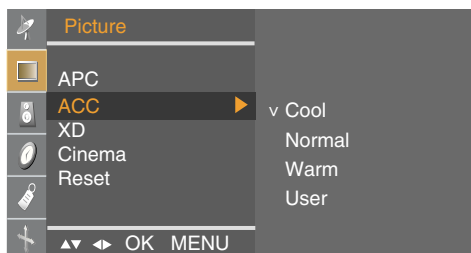

The **ACC** function automatically adjusts the screen color set.

- **Cool**  
Slightly purplish white.
- **Normal**  
Slightly bluish white.
- **Warm**  
Slightly reddish white.
- **User**  
Select this option to use the user-defined settings.

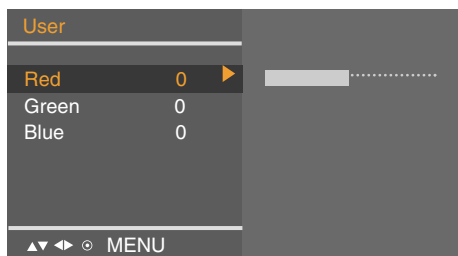

**Red / Green / Blue**

Set your own colour levels.



# Adjusting the Screen



## PICTURE ID adjust the picture function (TV/AV/Component/HDMI)

### XD

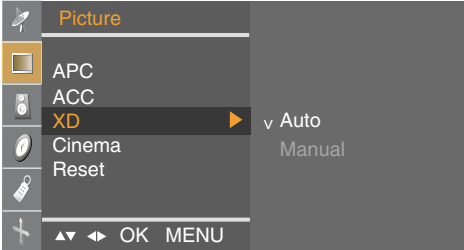

**XD** is LG Electronics unique picture improving technology to display a real **HD** source through an advanced digital signal processing algorithm.

**Manual** is activated after selecting the user of **APC**.

**Cinema** (Function works in the following mode - TV, AV, Component 480i)

When you watch the movie, this function adjusts the set to the best picture appearance.

**Reset** Return to the default settings **APC**, **ACC**, **XD**, **Cinema** at the factory.

# Adjusting the Screen



## SOUND ID to adjust the sound function

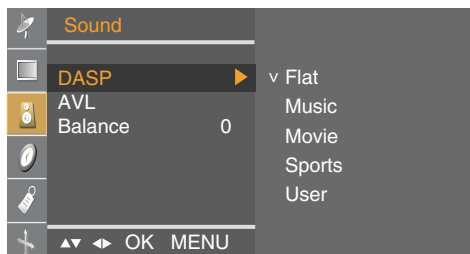

**DASP**  
(Digital Auto  
Sound  
Processing)

The best sound tone quality will be selected automatically depending on the video type that you're currently watching.

- **Flat** : The most commanding and natural audio.
- **Music** : Select this option to enjoy the original sound when listening to the music.
- **Movie** : Select this option to enjoy sublime sound.
- **Sports** : Select this option to watch sports broadcasting.
- **User** : Select this option to use the user-defined audio settings.

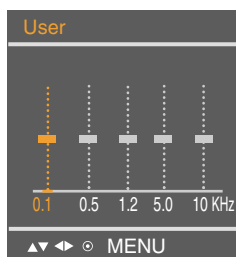

**AVL**

To adjust uneven sound volumes across all channels or signals automatically to the most appropriate level. To use this feature, select **On**.

**Balance**

Use this function to balance sound from the left and right speakers.

# Adjusting the Screen



## TIME ID to adjust the time function

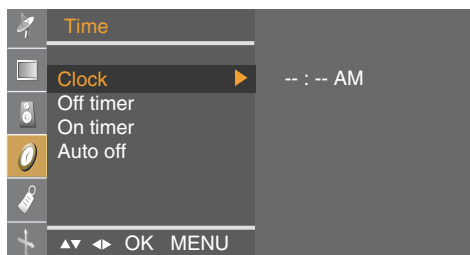

### Clock

This function is used to set up of current time.

You must set the time correctly before using **On/Off timer** function.

- 1) Press the **MENU** button and then use **▼▲** button to select the **Timer** menu.
- 2) Press the **▶** button and then use **▼▲** button to select the **Clock** menu.
- 3) Press **▶** button and then use **▼▲** button to set the hour(00~12 AM/PM).
- 4) Press **▶** button and then use **▼▲** button to set the minutes(00~59).

The default value is -- : --.

- 5) Press the **ENTER/MENU** button to save.

### Off/On timer

The **Off timer** automatically switches the set to off mode at the pre-set time.

- 1) Press the **MENU** button and then use **▼▲** button to select the **Timer** menu.
- 2) Press the **▶** button and then use **▼▲** button to select **Off timer** or **On timer**.
- 3) Press the **▶** button and then use **▼▲** button to set the hour(00~12 AM/PM).
- 4) Press the **▶** button and then use **▼▲** button to set the minutes(00~59).
- 5) Press the **▶** button and then use **▼▲** button to select **On** or **Off**.
- 6) Only **On timer** function; Press the **▶** button and then **▼▲** button to adjust volume level and programme number.
- 7) Press the **ENTER/MENU** button to save.

### Auto off

If **Auto off** is active and there is no input signal, the set switches to off mode automatically after 10 minutes. ( It is not working in PC)

- 1) Press the **MENU** button and then use **▼▲** button to select the **Auto off** menu.
- 2) Press the **▶** button and then use **▼▲** button to select **On** or **Off**.
- 3) Press the **ENTER/MENU** button to save .



#### Note

- In the event of power interruption (disconnection or power failure), the **Clock** must be reset.
- Two hours after the set is switched on by the **On timer** function it will automatically switch back to off mode unless a button has been pressed.
- Once the **On** or **Off timer** is set, these functions operate daily at the preset time.
- **Off timer** function overrides **On timer** function if they are set to the same time.
- The set must be in off mode for the **On timer** to work.
- **On timer** will move on to auto off if no activity is received in 2hours after setting the **On timer**.
- If the monitor switches to sleep mode when using the PC, "Clock" menu dose not operate.

# Adjusting the Screen



## SPECIAL ID to Select the special function

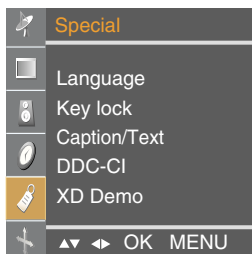

### Language

To choose the language in which the control names are displayed.

### Key lock

Use the ▼▲ buttons to select **On** or **Off**. It can be set up so that it can only be used with the remote control. This feature can prevent unauthorized viewing.

In order to lock the OSD screen adjustment, set the **Key lock** tab to the 'On' position.

In order to unlock it, do the following :

Push the **menu** button on the remote control and set **Key lock** to the 'Off' position.

### Caption/Text

Use the ▼▲ buttons to select caption mode.

Text services give a wide variety of information on all kind of subjects(ex. captioned program lists, weather forecasts, stock exchange topics, news for hearing-impaired....) on up to half of the screen. But not all stations offer text services, even though they might offer captioning.

In the event you are receiving a poor signal, an empty black box may appear and disappear, even when the text mode is selected. This is a normal when receiving a poor signal.

This set is programmed to remember the **Caption/Text** mode it was last set to, when you turn the power off.

### DDC-CI

DDC/CI(Display Data Channel Command Interface) is communication protocol for communications between PC and monitor.

DDC/CI makes it possible to adjust and setup detailed functions on PC instead of the monitor OSD.

Monitor can be adjusted with PC by connecting communication between PC and monitor when DDC/CI is ON, and monitor cannot be adjusted with PC because communication between PC and monitor is disconnected when DDC/CI is OFF.

### XD Demo

Use it to see the difference between XD demo on and XD Demo off.  
(XD Demo function is not available in RGB PC/ DVI PC mode.)

# Adjusting the Screen



## SCREEN ID to adjust the screen function

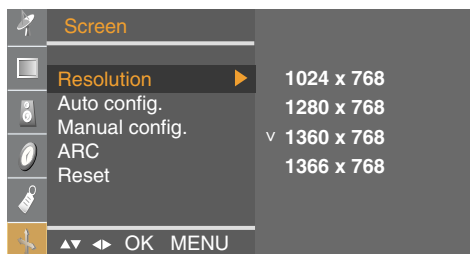

**Resolution** To view the best resolution of RGB-PC mode. Select the same resolution on OSD with PC's. It's working at RGB-PC mode when vertical frequency is 60Hz.

**Auto config.** This button is for the automatic adjustment of the screen **Position**, **Clock** and **Phase**. (It is not working in DVI.)

**Manual config.** This button is for the manual adjustment of the screen **Position**, **Clock** and **Phase**.

- **H-Position** (It is not working in DVI-PC)  
To move the displayed image left or right.
- **V-Position** (It is not working in DVI-PC)  
To move the displayed image up or down.
- **Phase** (It is not working in DVI-PC)  
To adjust the focus of the display. This item allows you to remove any horizontal noise and clear or sharpen the image of characters.
- **Clock** (It is not working in DVI-PC)  
To minimize any vertical bars or stripes visible on the screen background.  
The horizontal screen size will also change.

**ARC** To select the image size of the screen.

- **When TV, AV mode:** 16:9, Horozon, Zoom1, Zoom2, 4:3
- **When RGB/DVI/HDMI/Component mode:** 16:9, 4:3

**Reset** Use this function to reset the product to the factory default. However, language selection will not be initialized. (It is working In RGB-PC mode.)

# Troubleshooting

## No image is displayed

- Is the product's power cord connected?
  - Is the power indicator turning on?
  - Power is on, power indicator is blue but the screen appears extremely dark.
  - Does the power indicator look amber?
  - Does the 'Out of range' message appear?
  - Does the 'Check signal cable' message appear?
- Check if the power cord is properly connected to the outlet.
  - See if the power switch is turned on.
  - Adjust brightness and contrast again.
  - If the product is in power saving mode, move the mouse or press any key.
  - In DVD Player or Settop Box, check the power status of connected device.
  - The signal from the PC (video card) is out of the vertical or horizontal frequency range of the product. Adjust the frequency range by referring to the Specifications in this user's guide.
    - \* **Maximum resolution**  
1366 X 768 @60 Hz
  - The signal cable between PC and product is not connected. Check the signal cable.
  - Press the 'INPUT' button in the remote control to check the input signal.

## 'Unknown Product' message appears when the product is connected.

- Did you install the driver?
- Install the product driver, which is provided with the product, or download it from the web site. (<http://www.lge.com>)
  - See if the plug&play function is supported by referring to the video card user's guide.



### Note

\* **Vertical frequency:** To enable the user to watch the product display, screen image should be changed tens of times every second like a fluorescent lamp. The vertical frequency or refresh rate is the times of image display per second. The unit is Hz.

\* **Horizontal frequency:** The horizontal interval is the time to display one vertical line. When the 1 is divided by horizontal interval, the number of horizontal lines displayed every second can be tabulated as the horizontal frequency. The unit is kHz.

# Troubleshooting

## The screen image looks abnormal.

- Is the screen position wrong?
  - Adjust the Position menu in OSD .
  - See if the video card resolution and frequency are supported by the product. If the frequency is out of range, set to the recommended resolution in the Control Panel – Display – Setting menu.
- Do thin lines appear on the background screen?
  - Adjust the Clock menu in OSD.
- Horizontal noise appears or the characters look blurred.
  - Adjust the Phase menu in OSD.

## After-image appears on the product.

- After-image appears when the product is turned off.
  - If you use a fixed image for a long time, the pixels may be damaged quickly. Use the screen saver function.

# Troubleshooting

## The audio function does not work.

- No sound?
  - Check if the audio cable is connected properly.
  - Adjust the volume.
  - Check if the sound is set properly.
- Sound is too low.
  - Adjust the volume.

## The TV function does not work.

- The TV signal is not being received.
  - See if you have selected the proper channel mode.
  - Use the automatic channel setup function.
  - Check if the TV antenna is properly connected.

## Screen colour is abnormal.

- Screen has poor colour resolution (16 colours).
  - Set the colour resolution to more than 24 bits (true colour)  
Select Control Panel – Display – Settings  
– Colour Table menu in Windows.
- Screen colour is unstable or mono-colour.
  - Check the connection status of the signal cable.  
Or, re-insert the PC video card.
- Do black spots appear on the screen?
  - Several pixels (red, green, white or black colour) may appear on the screen, which can be attributable to the unique characteristics of the LCD panel. It is not a malfunction of the LCD.



# Specifications

The product specifications can change without prior notice for product improvement.

<b>LCD Panel</b>	<b>Screen Type</b>	18.51 inches Wide (47.01 cm) TFT (Thin Film Transistor) LCD (Liquid Crystal Display) Panel Visible diagonal size: 47.01 cm
	<b>Pixel Pitch</b>	0.10(H) x 0.30(V) mm
<b>Video Signal</b>	<b>Max. Resolution</b>	1366 X 768 @60 Hz
	<b>Recommended Resolution</b>	1360 X 768 @60 Hz
	<b>Horizontal Frequency</b>	30 - 61 kHz
	<b>Vertical Frequency</b>	56 - 75 Hz
	<b>Synchronization Type</b>	Separate Sync, Digital
<b>Input Connector</b>	S-Video, Composite video, TV, D-Sub Analog, DVI-D, HDMI, PC Audio In, Headphone/Earphone, component	
<b>Power</b>	<b>Rated Voltage</b>	AC 100-240V~ 50/60Hz 0.6A
	<b>Power Consumption</b>	On Mode : 35 W (Typ.) Sleep Mode ≤ 1 W Off Mode ≤ 1 W
<b>Tilt</b>	<b>Tilt Range</b>	-5° ~ 15°
<b>Dimension/Weight</b>	<b>Size (WxLxH)</b>	454.7 mm x 193.2 mm x 362.8 mm
	<b>Weight (excl. package)</b>	3.8 kg (8.38 lbs)
<b>Environmental Conditions</b>	<b>Operational Condition</b>	Temperature: 10°C ~ 35°C , Humidity: 20% ~ 80%
	<b>Storage Condition</b>	Temperature: -10°C ~ 60°C , Humidity: 5% ~ 90%

## Power Indicator

Mode	Product
On Mode	Blue
Sleep Mode	Amber
Off Mode	Off