



ENGLISH

DP450G



P/NO : MFL61857032



CAUTION: TO REDUCE THE RISK OF ELECTRIC SHOCK. DO NOT REMOVE COVER (OR BACK). NO USER-SERVICEABLE PARTS INSIDE. REFER SERVICING TO QUALIFIED SERVICE PERSONNEL.



This lightning flash with arrowhead symbol within an equilateral triangle is intended to alert the user to the presence of uninsulated dangerous voltage within the product's enclosure that may be of sufficient magnitude to constitute a risk of electric shock to persons.



The exclamation point within an equilateral triangle is intended to alert the user to the presence of important operating and maintenance (servicing) instructions in the literature accompanying the product.

WARNING: TO PREVENT FIRE OR ELECTRIC SHOCK HAZARD, DO NOT EXPOSE THIS PRODUCT TO RAIN OR MOISTURE.

WARNING: Do not install this equipment in a confined space such as a book case or similar unit.

CAUTION: Do not block any ventilation openings. Install in accordance with the manufacturer's instructions. Slots and openings in the cabinet are provided for ventilation and to ensure reliable operation of the product and to protect it from over heating. The openings shall be never be blocked by placing the product on a bed, sofa, rug or other similar surface. This product shall not be placed in a built-in installation such as a bookcase or rack unless proper ventilation is provided or the manufacturer's instruction has been adhered to.

CAUTION: This product employs a Laser System. To ensure proper use of this product, please read this owner's manual carefully and retain it for future reference.

Should the unit require maintenance, contact an authorized service centre. Use of controls, adjustments or the performance of procedures other than those specified herein may result in hazardous radiation exposure. To prevent direct exposure to laser beam, do not try to

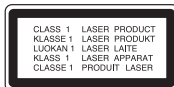

open the enclosure. Visible laser radiation when open. DO NOT STARE INTO BEAM.

CAUTION: The apparatus shall not be exposed to water (dripping or splashing) and no objects filled with liquids, such as vases, shall be placed on the apparatus.

CAUTION

- The ventilation shall not be impeded by covering the ventilation openings with items, such as newspapers, table-cloth, curtains etc.
- No naked flame sources, such as lighted candles, shall be placed on the apparatus.
- Used batteries shall be disposed of safely and not incinerated. Attention shall be shown to the environment aspects of battery disposal.
- Use the apparatus in tropical and moderate climates only.
- The excessive sound pressure from earphones and headphones can cause hearing loss.
- The battery shall not be exposed to excessive heat such as sunshine, fire or the like.
- Do not remove the battery incorporated with product for your safety.

If you need to replace the battery, take it to the nearest authorized LG Electronics service point or dealer for assistance

CAUTION concerning the Power Cord Most appliances recommend they be placed upon a dedicated circuit;

That is, a single outlet circuit which powers only that appliance and has no additional outlets or branch circuits. Check the specification page of this owner's manual to be certain. Do not overload wall outlets. Overloaded wall outlets, loose or damaged wall outlets, extension cords, frayed power cords, or damaged or cracked wire insulation are dangerous. Any of these conditions could result in electric shock or fire. Periodically examine the cord of your appliance, and if its appearance indicates damage or deterioration, unplug it, discontinue use of the appliance, and have the cord replaced with an exact replacement part by an authorized service centre. Protect the power cord from physical or mechanical abuse, such as being twisted, kinked, pinched, closed in a door, or walked upon. Pay particular attention to plugs, wall outlets, and the







point where the cord exits the appliance. To disconnect power from the mains, pull out the mains cord plug. When installing the product, ensure that the plug is easily accessible.

- The appliance is not intended for use by young children or infirm persons without supervision.
- Young Children shall be supervised to ensure that they do not play with appliance.
- If the appliance is supplied from a cord extension set or an electrical portable outlet device, the cord extension set on electrical portable outlet device must be positioned so that it is not subject to splashing or ingress of moisture.

Contents

Types of Playable Discs	3
Rechargeable battery	3
Main Unit	4
Remote Control	5
Power connections	6
Hooking up the unit	7
Adjust the settings	8-9
Displaying Disc Information.....	9
Playing a Disc.....	10-11
Playing a DivX movie file.....	11
Listening to Music Disc or files.....	12
Viewing photo files	12
Language Codes	13
Area Codes	13
Troubleshooting.....	14
Specifications	14



Types of Playable Discs

Type	Logo
DVD-VIDEO: Discs such as movies that can be purchased or rented.	
DVD-R: Video mode and finalized only	
DVD-RW: VR mode, Video mode and finalized only	
DVD+R: Video mode only	
DVD+RW: Video mode only	
Audio CD: Music CDs or CD-R/CD-RW in music CD format that can be purchased.	
This unit plays DVD±R/RW and CD-R/RW that contains audio titles, DivX, MP3, WMA and/or JPEG files. Some DVD±RW/DVD±R or CD-RW/CD-R cannot be played on this unit due to the recording quality or physical condition of the disc, or the characteristics of the recording device and authoring software.	

Manufactured under license from Dolby Laboratories. "Dolby" and the double-D symbol are trademarks of Dolby Laboratories.

"DVD Logo" is a trademark of DVD format/Logo Licensing Corporation.

About the Symbol Display

""
"  " may appear on your TV display during operation and indicates that the function explained in this owner's manual is not available on that disc.

Regional Codes

This unit has a regional code printed on the rear of the unit. This unit can play only DVD discs labelled same as the rear of the unit or "ALL".

- Most DVD discs have a globe with one or more numbers in it clearly visible on the cover. This number must match your unit's regional code or the disc cannot play.
- If you try to play a DVD with a different regional code from your player, the message "Check Regional Code" appears on the TV screen.

Copyrights

It is forbidden by law to copy, broadcast, show, broadcast via cable, play in public, or rent copyrighted material without permission. This product features the copy protection function developed by Macrovision. Copy protection signals are recorded on some discs. When recording and playing the pictures of these discs picture noise will appear. This product incorporates copyright protection technology that is protected by U.S. patents and other intellectual property rights. Use of this copyright protection technology must be authorized by Macrovision, and is intended for home and other limited viewing uses only unless otherwise authorized by Macrovision. Reverse engineering or disassembly is prohibited.

Rechargeable battery

- Its internal rechargeable battery provides you with the freedom to pass it around and play the files without the power cord.
- The internal rechargeable battery will start charging only when the unit is turned off and the AC adapter is connected to a power outlet.
- The charging stops if you turn on the unit.
- The charging will take approximately 2 hours and 30 minutes.
- Operating time on battery: approximately 2 hours and 30 minutes. The operating time on battery may vary depending on the battery status, operational status and environment conditions, and the maximum playing time is possible up to 3 hours.
- The battery indicator will turn red while charging. Once the charging is complete, the indicator light changes to green.
- When the remaining time of the battery power is under a few minutes,  will blink on the screen.

Main Unit

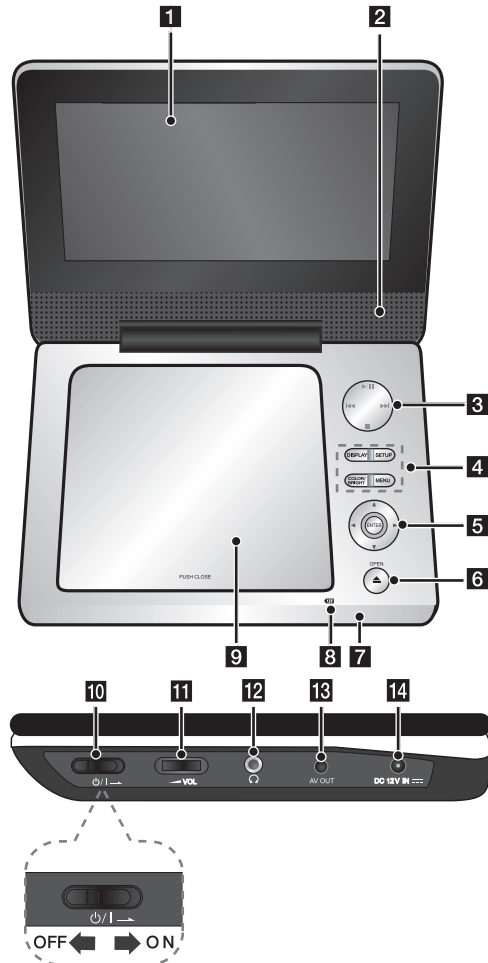

4

1 LCD screen

2 Speakers

3 Playback control buttons

- **▶ (Play) / || (PAUSE)**: Starts playback and pauses playback temporarily, press again to exit pause mode.
- **■ (Stop)**: Stops playback.
- **◀◀ (Skip)**: Searches backward* or returns to the beginning of current chapters/ tracks/ files or goes to the previous chapters/ tracks/ files.
- **▶▶ (Skip)**: Searches forward* or goes to next chapters/ tracks/ files.

* Press and hold button for about two seconds.

4 Function buttons

- **DISPLAY**: Accesses On-Screen Display.
- **SETUP**: Accesses or exits the setup menu.
- **COLOR/BRIGHT***: Displays the Brightness or Colour menu for LCD display.
- **MENU**: Accesses the DVD menu.

* To adjust the colour or brightness of the LCD display, press COLOR/BRIGHT repeatedly on the main unit to display the Brightness or Colour menu then use ◀ / ▶ to adjust the value. Press ENTER to confirm the adjustment.

5 Menu control buttons

- **◀▶▲▼ (left/right/up/down)**: Selects an item in the menu.
- **ENTER**: Confirms menu selection.

6 OPEN (▲): Opens the disc lid.

7 Remote sensor: Point the remote control here.

8 Battery charge and power indicator

- The indicator turns red in charging and changes to green colour when the charging is complete. (Refer to page 3 for details.)
- The indicator turns green for a few seconds when the unit is turned on.

9 Disc lid

10 ⏻/I (Power switch): Turn the unit ON or OFF.

Note: To operate this unit, the power switch must be located ON.

11 ◀ VOL (Volume): Adjusts the volume level of the built-in speaker and earphones.

12 🎧 (Earphones): Connect earphones here.

13 AV OUT: Connect to a TV with video and audio input.

14 DC 12V IN: Connect the AC adapter or automotive adapter.

Remote Control

Note:

To operate this unit with remote control, the power switch must be located ON. (Refer to 4 page)

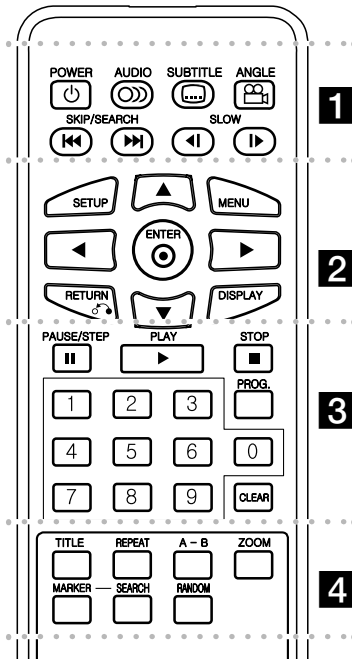

- • • • • **1** • • • • •
- POWER** (⏻): Switches the unit ON or OFF.
- AUDIO** (🔊): Selects an audio language or audio channel.
- SUBTITLE** (📄): Selects a subtitle language.

ANGLE (📷): Selects a DVD camera angle, if available.

SKIP/SEARCH (⏮ / ⏭): Searches* backward / forward. Goes to next or previous chapter/track/file.
* Press and hold button for about two seconds.

SLOW (⏪ / ⏩): Reverse/ Forward slow playback.

• • • • • **2** • • • • •

SETUP: Accesses or exits the setup menu.

MENU: Accesses the DVD menu.

▲▼◀▶: Navigates the menus.

ENTER (⊙): Confirms menu selection.

RETURN (↶): Returns backwards in the menu or exits the menu.

DISPLAY: Accesses On-Screen Display.

• • • • • **3** • • • • •

PAUSE/STEP (⏸): Pauses playback temporarily/ press repeatedly for frame-by-frame playback.

PLAY (▶): Starts playback.

STOP (■): Stops playback.

Numerical buttons: Selects numbered options in a menu.

PROG.: Enters the program edit mode.

CLEAR: Removes a track number on the Program List.

• • • • • **4** • • • • •

TITLE: Accesses the disc's title menu.

REPEAT: Repeats a chapter, track, title or all.

A-B: Repeats a section.

ZOOM: Enlarges a video image.

MARKER: Marks any point during playback.

SEARCH: Displays [Marker Search] menu.

RANDOM: Plays tracks in random order.

Put the battery into the Remote Control

Pinch the battery holder clip together then pull the tab to remove the battery holder. Insert the battery with the + facing in the same direction as the + on the battery holder. Replace the battery holder with battery into the Remote Control unit making sure that it is fully inserted.

- Replace Remote Control unit battery with 3V micro lithium cells such as CR. 2025 or its equivalent.
- Dispose of battery safely in accordance with local laws. Do not dispose of in fire.

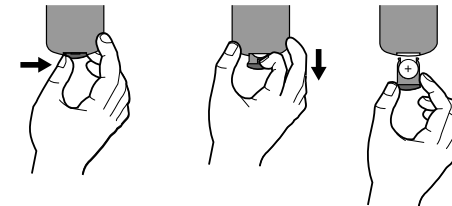

Warning for replaceable lithium battery

- danger of explosion if battery incorrectly replaced.
- replace only with the same type battery.
- additional warning marking close to the battery if intended to be replaced by users.

Warning: The battery used in this device may present a fire or chemical burn hazard if mis-treated. Do not recharge, disassemble, incinerate, or heat above 100 °C (212 °F). Replace the battery with Matsushita Elec. Ind. Co., Ltd. (Panasonic), part no. CR. 2025 only. Use of another battery may present a risk of fire or explosion. Dispose of used batteries. Keep batteries away from children. Do not disassemble or dispose of in fire.

Power connections

Connecting the AC Adapter

Connect the supplied AC Adapter from the unit to a power socket.

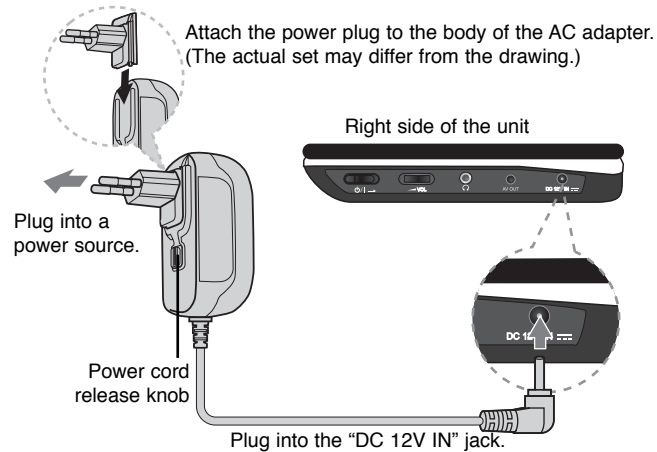

AC adapter

- This AC adapter operates on 100-240V~ 1 A 50/60Hz.
- Contact an electrical parts distributor for assistance in selecting a suitable AC plug adapter or AC cord set.
- Manufactured by NANJING WANLIDA TECHNOLOGY CO., LTD

Connect the Automotive adapter

This unit and its automotive adapter are designed for use in vehicles that have 8.5-16 volt, negative ground electrical systems. This is standard for most vehicles. If your vehicle has a different type of the electrical system, the DC power system cannot be used.

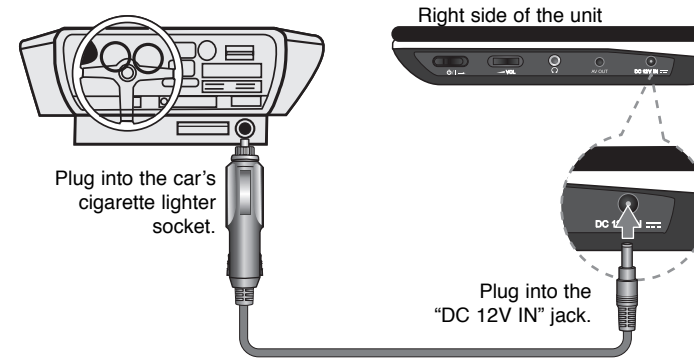

Automotive adapter

- This automotive adapter operates on DC 8.5-16V.
- Contact an electrical parts distributor for assistance in selecting a suitable automotive adapter.
- Manufactured by NANJING WANLIDA TECHNOLOGY CO., LTD.

Caution

- To prevent electrical shock and possible damage to your unit or vehicle, always unplug the automotive adapter from the cigarette lighter socket before you remove the plug from your unit.
- A 3 amp, 250V fuse for protection is installed in the automotive adapter.
- While the engine is being started, disconnect the automotive adapter from the car's cigarette lighter socket.
- Do not operate your unit when the car battery is discharged. Peak current from the car generator may cause the DC fuse to blow.
- If the vehicle's supply voltage drops below approximately 10 volts, your unit may not work properly.
- Do not leave your unit in a place where the temperature exceeds 70°C (158°F), or the pick-up device may be damaged. Examples include:
 - Inside a car with the windows closed and in direct sunshine.
 - Near a heating appliance.

Hooking up the unit

Audio and Video Connections to your TV

Connect the AV OUT jack on the unit to the corresponding input jacks on your TV as shown below.

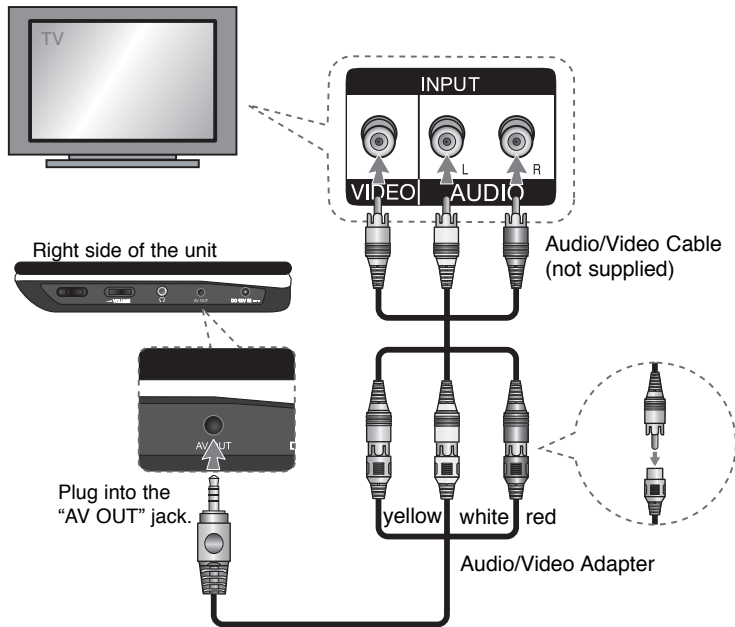

Adjust the settings	
	BUTTON
1 Display setup menu:	SETUP
2 Select a desired option on the first level:	▲ ▼
3 Move to second level:	▶
4 Select a desired option on the second level:	▲ ▼
5 Move to third level:	▶
6 Change the setting:	▲ ▼ / ENTER

Adjust the settings - more you can do

When you turn on for the first time (optional)

The menu for a language selection will appear when you turn on the unit for the first time. You must select a language to use the unit. Use ▲▼◀▶ to select a language then press **ENTER** and the confirm menu will appear. Use ◀▶ to select [ENTER] then press **ENTER**.

Adjust the language settings

Menu Language – Select a language for the Setup menu and on-screen display.

Disc Audio/Subtitle/Menu – Select a language for the Disc Audio/Subtitle/Menu.

[Original]: Refers to the original language in which the disc was recorded.

[Other]: To select another language, press number buttons then **ENTER** to enter the corresponding 4-digit number according to the language code list. (see page 13) If you make a mistake while entering number, press **CLEAR** to delete numbers then correct it.

[Off] (for Disc Subtitle): Turn off Subtitle.

Adjust the display settings

TV Aspect – Select which screen aspect to use based on the shape of your TV screen.

[4:3]: Select when a standard 4:3 TV is connected.

[16:9]: Select when a 16:9 wide TV is connected.

Display Mode – If you selected 4:3, you'll need to define how you would like widescreen programs and films to be displayed on your TV screen.

[Letterbox]: This displays a widescreen picture with black bands at the top and bottom of the screen.

[Panscan]: This fills the entire 4:3 screen, cropping the picture as necessary.

Adjust the audio settings

DRC (Dynamic Range Control) – Make the sound clear when the volume is turned down (Dolby Digital only). Set to [On] for this effect.

Vocal – Set to [On] only when a multi-channel karaoke DVD is playing. The karaoke channels on the disc mix into normal stereo sound.

Adjust the lock settings

You must set the [Area Code] option to use the lock options. Select [Area Code] option then press ▶. Enter a 4-digit password then press **ENTER**. Enter it again then press **ENTER** to verify. If you make a mistake while entering number, press **CLEAR** then correct it.

If you forget your password you can reset it. First, remove the disc in the unit. Display setup menu then input the 6-digit number "210499" and the password will be cleared.

Rating – Select a rating level. The lower the level, the stricter the rating. Select [Unlock] to deactivate the rating.

Password – Sets or changes the password for lock settings.

[New]: Enter a new 4-digits password using the numerical buttons then press **ENTER**. Enter the password again to confirm.

[Change]: Enter the new password twice after entering the current password.

Area Code – Select a code for a geographic area as the playback rating level. This determines which area's standards are used to rate DVDs controlled by the parental lock. (See page 13)

Adjust the others settings

DivX(R) VOD – We provide you with the DivX® VOD (Video On Demand) registration code that allows you to rent and purchase videos using the DivX® VOD service. For more information, visit www.divx.com/vod.

Press **ENTER** when [Select] icon is highlighted and you can view the registration code of the unit.

All the downloaded videos from DivX® VOD can only be played back on this unit.







Displaying Disc Information

	BUTTON
1 Press DISPLAY during playback:	DISPLAY
2 Select an item:	▲ ▼
3 Adjust the Display menu settings:	◀ ▶ / ENTER
4 Exit the menu:	DISPLAY



Displaying Disc Information - more you can do

You can select an item by pressing **▲▼** and change or select the setting by pressing **◀▶**.

 1 / 5	Current title number/total number of titles
 5 / 42	Current chapter number/total number of chapters
 0:13:45	Elapsed playing time
 1 ENG D/D 3 / 2 1CH	Selected audio language or channel
 OFF	Selected subtitle
 1 / 1	Selected angle/total number of angles

Symbol Used in this Manual

A section whose title has one of the following symbols are applicable only to the disc or file represented by the symbol.

ALL	All discs and files	ACD	Audio CDs
DVD	DVD and finalized DVD±R/RW	MP3	MP3 files
DivX	DivX files	WMA	WMA files

Playing a Disc

	BUTTON
1 Open the disc lid:	OPEN (▲)
2 Insert a Disc:	-
3 Close the disc lid:	-
4 Start playback:	▶ PLAY
5 Adjust the volume:	VOLUME
6 To stop playback:	■ STOP

Playing a Disc - more you can do

Stops the playback

Press **STOP** (■) to stop playback, the unit records the stopped point depending on the disc. "■■■" appears on the screen briefly. Press **PLAY** (▶) to resume playback (from the scene point). If you press **STOP** (■) again or unload the disc ("■" appears on the screen), the unit will clear the stopped point. (■■■ =Resume Stop, ■ =Complete Stop) The resume point may be cleared when a button is pressed. (for example: POWER, OPEN, etc)

Playing a DVD that has a menu **DVD**

Most DVD now have menus which load first before the film begins to play. You can navigate these menus using ▲▼◀▶ or number button to highlight an option. Press **ENTER** to select.

Playing a DVD VR disc

This unit will play DVD-RW disc that is recorded using the Video Recording (VR) format. When you insert a disc DVD VR disc, the menu will appear on the screen. Use ▲▼ to select a title then press **PLAY** (▶). To display DVD-VR menu, press **MENU** or **TITLE**.

Some DVD-VR disc are made with CPRM data by DVD RECORDER. The unit does not support these kinds of discs.

Skip to the next/previous chapter/track/file **ALL**

Press **SKIP** (▶▶) to move to the next chapter/track/file.

Press **SKIP** (◀◀) to return to the beginning of the current chapter/track/file.

Press **SKIP** (◀◀) twice briefly to step back to the previous chapter/track/file.

Pause a playback **ALL**

Press **PAUSE/STEP** (||) to pause playback. Press **PLAY** (▶) to continue playback.

Frame-by-Frame playback **DVD DivX**

Press **PAUSE/STEP** (||) repeatedly to play Frame-by-Frame playback.

Playing repeatedly **ALL**

Press **REPEAT** repeatedly to select an item to be repeated. The current title, chapter track or all will be played back repeatedly. To return to normal playback, press **REPEAT** repeatedly to select [Off].

Fast forward or fast reverse **DVD DivX ACD WMA MP3**

Press and hold **SKIP** (◀◀ or ▶▶) to play fast forward or fast reverse during playback. You can change the various playback speed by pressing and holding **SKIP** (◀◀ or ▶▶) repeatedly. Press **PLAY** (▶) to continue play at normal speed.

Repeating a specific portion (A-B) **DVD DivX ACD**

Press **A-B** at the beginning of the portion you wish to repeat and again at the end of the portion. Your selected portion will be repeated continually. To return to normal playback, press **A-B** to select [Off].

Selecting a subtitle language **DVD DivX**

During playback, press **SUBTITLE** (☒) repeatedly to select a desired subtitle language.

Watching from a different angle **DVD**

If the angle indicator appears on the screen for a moment, you can select a different camera angle by pressing **ANGLE** (☒) repeatedly.

Hearing a different audio **DVD DivX**

During playback, press **AUDIO** (☒) repeatedly to switch between the available audio languages, channels or encoding methods.

Slow down the playing speed **DVD DivX : Forward only**

During playback, press **SLOW** (◀| or |▶) to slow down reverse or forward playback. You can change the various playback speed by pressing **SLOW** (◀| or |▶) repeatedly. Press **PLAY** (▶) to continue play at normal speed.

Watching an enlarged video image **DVD DivX**

During playback or pause mode, press **ZOOM** repeatedly to select zoom mode. You can move through the zoomed picture using **▲▼◀▶** buttons. Press **CLEAR** to exit. (100 % → 200 % → 300 % → 400 % → 100 %)

Viewing the title menu **DVD**

Press **TITLE** to display the disc's title menu, if available.

Viewing the DVD menu **DVD**

Press **MENU** to display the disc menu, if available.

Starting play from selected time **DVD DivX**

Searches for the starting point of entered time code. Press **DISPLAY** then select clock icon. Enter a time then press **ENTER**. For example, to find a scene at 1 hour, 10 minutes, and 20 seconds, enter "11020" and press **ENTER**. If you enter the wrong number, press **CLEAR** to enter again.

Playing in random order **ACD WMA MP3**

During playback or in stop mode, press **RANDOM** for playback in random order. Press **RANDOM** again to return to normal playback.

Mark a scene on a disc **DVD DivX**

You can mark a position on a disc to return to at the place. Simply press **MARKER** at the desired position. The marker icon will appear on-screen briefly. Repeat to place up to nine markers.

Also you can recall or clear the positions. Press **SEARCH** and [Marker Search] menu will appear. Use **◀▶** to select a desired marker on the menu, then press **ENTER** to recall it or **CLEAR** to clear it.

Last Scene Memory **DVD ACD**

This unit memorizes last scene from the last disc that is viewed. The last scene remains in memory even if you remove the disc from the player or switch off the unit. If you load a disc that has the scene memorized, the scene is automatically recalled.

Screen Saver

The screen saver appears when you leave the unit in Stop mode for about five minutes. If the Screen Saver is displayed for five minutes, the unit automatically turns itself off.

Mixed disc – DivX, MP3/WMA and JPEG

When playing a disc contained with DivX, MP3/WMA and JPEG files together, you can select which menu of files you would like to play by pressing **TITLE**.

Playing a DivX movie file

	BUTTON
1 Open the disc lid:	OPEN (▲)
2 Insert a disc:	-
3 Close the disc lid:	-
4 Select a movie file from the menu:	▲ ▼, MENU
5 Start playback:	▶ PLAY
6 To stop playback:	■ STOP

Playing a DivX movie file - more you can do

Changing the character set to display DivX® subtitle correctly

Press and hold **SUBTITLE** for 3 seconds during playback. The language code will appear. Press **◀▶** to select another language code until the subtitle is displayed properly and then press **ENTER**.

DivX file requirement

DivX file compatibility with this player is limited as follows:

- Available resolution size: 720x576 (W x H) pixel.
- The file names of DivX and subtitle are limited to 45 characters.
- DivX file extensions: ".avi", ".mpg", ".mpeg"
- Playable DivX subtitle: SubRip (.srt / .txt), SAMI (.smi), SubStation Alpha (.ssa/.txt), MicroDVD (.sub/.txt), VobSub (.sub), SubViewer 2.0 (.sub/.txt), TMPlayer (.txt), DVD Subtitle System (.txt)
- Playable Codec format: "DIVX3.xx", "DIVX4.xx", "DIVX5.xx", "MP43", "3IVX".
- Only the playback function is supported with DivX 6.0 in the unit.
- Playable Audio format: "Dolby Digital", "PCM", "MP3", "WMA"
- Sampling frequency: within 8 - 48 kHz (MP3), within 32 - 48 kHz (WMA)
- Bit rate: within 8 - 320 kbps (MP3), within 32 - 192 kbps (WMA), less than 4Mbps (DivX file)
- CD-R/RW, DVD±R/RW Format: ISO 9660
- Maximum Files/Folders: Less than 600 (total number of files and folders)

Listening to Music Disc or files

	BUTTON
1 Open the disc lid:	OPEN (▲)
2 Insert a disc:	-
3 Close the disc lid:	-
4 Select a music from the menu:	▲ ▼, MENU
5 Start playback:	▶ PLAY
6 To stop playback:	■ STOP

Listening to Music Disc or files - more you can do

Creating your own program

You can play the contents of a disc in the order you want by arranging the order of the music titles on the disc. To add a music titles on the program list, press **PROG.** to enter the program edit mode (Ⓜ mark appears on the menu). Select a desired music on the [List] then press **ENTER** to add the music to the program list. Select a music from the program list then press **ENTER** to start programmed playback. To clear a music from the program list, select the music you want to clear then press **CLEAR** in program edit mode. To clear all music from the program list, select [Clear All] then press **ENTER** in program edit mode. The program is cleared when the disc is removed or the unit is turned off.

Displaying file information (ID3 TAG)

While playing a MP3 file containing file information, you can display the information by pressing **DISPLAY** repeatedly. If the file does not have ID3-Tag information, [No ID3 TAG] appears on the screen.

MP3/WMA music file requirement

MP3/WMA compatibility with this unit is limited as follows:

- File extensions: “.mp3”, “.wma”
- Sampling frequency: within 8 - 48 kHz (MP3), within 32 - 48kHz (WMA)
- Bit rate: within 8 - 320kbps (MP3), within 32 - 192kbps (WMA)
- CD-R/RW, DVD±R/RW Format: ISO 9660
- Maximum Files/Folders: Less than 600 (total number of files and folders)

12

Viewing photo files

	BUTTON
1 Open the disc lid:	OPEN (▲)
2 Insert a disc:	-
3 Close the disc lid:	-
4 Select a photo file on the menu:	▲ ▼, MENU
5 Display the selected file in full screen:	▶ PLAY
6 To return to the menu:	■ STOP

Viewing photo files - more you can do

Viewing photo files as a slide show

Use ▲▼◀▶ to highlight (🖼️) icon then press **ENTER** to start slide show. You can change slide show speed using ◀▶ when (🖼️) icon is highlighted.

Skip to the next/previous photo

Press **SKIP** (⏮ or ⏭) to view the previous/next photo.

Rotate a photo

Use ▲▼ to rotate the photo in full screen counter clockwise or clockwise while viewing a photo in full screen.

Pause a slide show

Press **PAUSE/STEP** (⏸) to pause a slide show. Press **PLAY** (▶) to continue the slide show.

Listening to music during slide show

You can listen to music during slide show, if the disc contain music and photo files together. Use ▲▼◀▶ to highlight (🎵🖼️) icon then press **ENTER** to start slide show.

Watching an enlarged photo image

While viewing a photo in full screen, press **ZOOM** repeatedly to select zoom mode. You can move through the zoomed photo using ▲▼◀▶ buttons. Press **CLEAR** to exit.

Photo file requirement

JPEG file compatibility with this unit is limited as follows:

- File extensions: “.jpg”
- Photo size: Less than 2MB recommended
- CD-R/RW, DVD±R/RW Format: ISO 9660
- Maximum Files/Folders: Less than 600 (total number of files and folders)

Language Codes

Use this list to input your desired language for the following initial settings: Disc Audio, Disc Subtitle, Disc Menu.

Language	Code	Language	Code	Language	Code	Language	Code	Language	Code	Language	Code
Afar	6565	Croatian	7282	Hausa	7265	Lingala	7678	Quechua	8185	Tajik	8471
Afrikaans	6570	Czech	6783	Hebrew	7387	Lithuanian	7684	Rhaeto-Romance	8277	Tamil	8465
Albanian	8381	Danish	6865	Hindi	7273	Macedonian	7775	Rumanian	8279	Telugu	8469
Ameharic	6577	Dutch	7876	Hungarian	7285	Malagasy	7771	Russian	8285	Thai	8472
Arabic	6582	English	6978	Icelandic	7383	Malay	7783	Samoan	8377	Tonga	8479
Armenian	7289	Esperanto	6979	Indonesian	7378	Malayalam	7776	Sanskrit	8365	Turkish	8482
Assamese	6583	Estonian	6984	Interlingua	7365	Maori	7773	Scots Gaelic	7168	Turkmen	8475
Aymara	6588	Faroeese	7079	Irish	7165	Marathi	7782	Serbian	8382	Twi	8487
Azerbaijani	6590	Fiji	7074	Italian	7384	Moldavian	7779	Serbo-Croatian	8372	Ukrainian	8575
Bashkir	6665	Finnish	7073	Japanese	7465	Mongolian	7778	Shona	8378	Urdu	8582
Basque	6985	French	7082	Kannada	7578	Nauru	7865	Sindhi	8368	Uzbek	8590
Bengali, Bangla	6678	Frisian	7089	Kashmiri	7583	Nepali	7869	Singhalese	8373	Vietnamese	8673
Bhutani	6890	Galician	7176	Kazakh	7575	Norwegian	7879	Slovak	8375	Volapük	8679
Bihari	6672	Georgian	7565	Kirghiz	7589	Oriya	7982	Slovenian	8376	Welsh	6789
Breton	6682	German	6869	Korean	7579	Panjabi	8065	Spanish	6983	Wolof	8779
Bulgarian	6671	Greek	6976	Kurdish	7585	Pashto, Pushto	8083	Sudanese	8385	Xhosa	8872
Burmese	7789	Greenlandic	7576	Laotian	7679	Persian	7065	Swahili	8387	Yiddish	7473
Byelorussian	6669	Guarani	7178	Latin	7665	Polish	8076	Swedish	8386	Yoruba	8979
Chinese	9072	Gujarati	7185	Latvian, Lettish	7686	Portuguese	8084	Tagalog	8476	Zulu	9085

Area Codes

Choose an area code from this list.

Area	Code	Area	Code	Area	Code	Area	Code	Area	Code	Area	Code
Afghanistan	AF	Costa Rica	CR	Greenland	GL	Maldives	MV	Paraguay	PY	Sri Lanka	LK
Argentina	AR	Croatia	HR	Hong Kong	HK	Mexico	MX	Philippines	PH	Sweden	SE
Australia	AU	Czech Republic	CZ	Hungary	HU	Monaco	MC	Poland	PL	Switzerland	CH
Austria	AT	Denmark	DK	India	IN	Mongolia	MN	Portugal	PT	Taiwan	TW
Belgium	BE	Ecuador	EC	Indonesia	ID	Morocco	MA	Romania	RO	Thailand	TH
Bhutan	BT	Egypt	EG	Israel	IL	Nepal	NP	Russian Federation	RU	Turkey	TR
Bolivia	BO	El Salvador	SV	Italy	IT	Netherlands	NL	Saudi Arabia	SA	Uganda	UG
Brazil	BR	Ethiopia	ET	Jamaica	JM	Netherlands Antilles	AN	Senegal	SN	Ukraine	UA
Cambodia	KH	Fiji	FJ	Japan	JP	New Zealand	NZ	Singapore	SG	United States	US
Canada	CA	Finland	FI	Kenya	KE	Nigeria	NG	Slovak Republic	SK	Uruguay	UY
Chile	CL	France	FR	Kuwait	KW	Norway	NO	Slovenia	SI	Uzbekistan	UZ
China	CN	Germany	DE	Libya	LY	Oman	OM	South Africa	ZA	Vietnam	VN
Colombia	CO	Great Britain	GB	Luxembourg	LU	Pakistan	PK	South Korea	KR	Zimbabwe	ZW
Congo	CG	Greece	GR	Malaysia	MY	Panama	PA	Spain	ES		

Troubleshooting

Symptom	Cause	Correction
No power.	The power cord is disconnected.	Plug the power cord into the wall outlet securely.
	The battery is discharged.	Recharge the battery.
The power is on, but the unit does not work.	No disc is inserted.	Insert a disc.
No picture.	The TV is not set to receive the signal from the unit.	Select the appropriate video input mode on the TV.
	The video cable is not connected securely.	Connect the video cable securely.
No sound.	The equipment connected with the audio cable is not set to receive the signal from the unit.	Select the correct input mode of the audio amplifier.
	The volume is set to minimum.	Use the volume controller to adjust the volume.
	The AUDIO options are set to the wrong position.	Set the AUDIO settings to the correct position.
The unit does not start playback.	An unplayable disc is inserted.	Insert a playable disc. (Check the disc type and regional code.)
	The rating level is set.	Change the rating level.
The remote control does not work properly.	The remote control is not pointed at the remote sensor on the unit.	Point the remote control at the remote sensor of the unit.
	The remote control is too far from the unit.	Operate the remote control closer to the unit.

Specifications

General

Power requirements	DC 12V
Power consumption	12W
External Dimensions	202 x 42.5 x 167 mm (W x H x D)
Net Weight (Approx.)	0.78kg
Operating temperature:	5 °C to 40 °C
Operating humidity	5 % to 90 %
Laser	Semiconductor laser
Signal system	PAL

Connectors

Audio/Video Output	ø3.5mm mini jack x 1
- Video:	1.0 V (p-p), 75 Ω, sync negative
- Audio:	1.5 Vrms (1 KHz, 0 dB)
Earphone terminal	ø3.5mm stereo mini jack x 1

Liquid Crystal Display

Panel size	7 inches wide (diagonal)
Projection system	R.G.B. stripe
Driving system	TFT active matrix
Resolution	480 x 234 (WQVGA)

Accessories

- Audio/Video adapter
- AC Adapter (MPA-630)
- Automotive Adapter (DPDC1)
- Remote Control
- Battery for Remote Control (Lithium Battery)

Designs and specifications are subject to change without prior notice.