



LG

website:<http://us.lgservice.com>

MICROWAVE OVEN

OWNER'S MANUAL & COOKING GUIDE

PLEASE READ THIS OWNER'S MANUAL THOROUGHLY BEFORE OPERATING.

LTRM1240SW/SB/ST

TABLE OF CONTENTS

SAFETY	3-4
Precautions to Avoid Possible Exposure to Excessive Microwave Energy.....	3
Grounding Instructions.....	3
Important Safety Instructions	4
SAFETY - TOASTER	5
UNDERSTANDING YOUR TOASTER CAMBO	6-8
Specifications.....	6
Installation.....	6
Parts and Accessories	7
Control Panel	8
USING YOUR MICROWAVE OVEN	9-20
Cookware Guide	9
Tips for Microwave Cooking.....	10
Cleaning	10
Custom Set	11
Custom Set Table	11
Sensor Touch Operation Instruction	12
Sensor Touch Table	12
Reheat	13
Reheat Table	13
Auto Cook	14
Auto cook Table	14
EZ-On	14
Kitchen Timer	15
Child Lock	15
Auto Defrost	16
Q-Defrost	16
Auto Defrost Table	17
Timed Cooking	17
Multi-stage Cooking	18
Microwave Power Levels	18
Cooking Tips	19-20
USING YOUR TOASTER	21-23
Tips For Toaster	21
Cleaning the Toaster	21
Cooking Tips	21
Operating Instruction.....	22
Toast	22
Bagel	23
TROUBLESHOOTING	24-26
Questions and Answers	24-25
Before Calling For Service	26
WARRANTY	Inside back cover

Thank you for purchasing a LG microwave oven.

Please record the model number and serial number of this unit for future reference. We also suggest you record the details of your contact with LG (LG Electronics U.S.A., Inc.) concerning this unit.

Staple your receipt here for proof of purchase.

Model No: _____

Serial No: _____

Dealer: _____

Dealer Phone No: _____

Customer Relations
 LG Electronics U.S.A., Inc.
 Service Division Bldg. #3
 201 James Record Rd.
 Huntsville, AL 35824-0126

SAFETY

PRECAUTIONS TO AVOID POSSIBLE EXPOSURE TO EXCESSIVE MICROWAVE ENERGY

- DO NOT attempt to operate this oven with the door open, since open-door operation can result in harmful exposure to microwave energy. **It is important not to defeat or tamper with the safety interlocks.**
- DO NOT operate the oven if it is damaged. It is particularly important that the oven door close properly and that there is no damage to the:
 1. door (bent)
 2. hinges and latches (broken or loosened)
 3. door seals and sealing surfaces.
- DO NOT place any object between the oven front face and the door, or allow soil or cleaner residue to accumulate on sealing surfaces.
- THE OVEN should not be adjusted or repaired by anyone except properly qualified service personnel.

GROUNDING INSTRUCTIONS

This appliance must be grounded! If an electrical short circuit occurs, grounding reduces the risk of electric shock by providing an escape wire for the electric current. This appliance is equipped with a

cord having a grounding wire with a grounding plug. Put the plug into an outlet that is properly installed and grounded.

WARNING

If you use the grounding plug improperly, you risk electric shock.

Ask a qualified electrician or the Authorized Service Department if you do not understand the grounding instructions or if you wonder whether the appliance is properly grounded.

This appliance has a short power supply cord to reduce the risk of anyone's tripping over or becoming entangled in the cord. You may use an extension cord if you are careful.

If you use an extension cord, be sure that:

- The extension cord has the same electrical rating as the appliance.
- The marked rating of the extension cord shall be equal to or greater than the electrical rating of the appliance.
- The extension cord is a grounding-type 3-wire cord.
- The extension cord does not drape over a countertop or tabletop, where it can be pulled on by children or tripped over accidentally.
- The electrical cord is dry and not pinched or crushed in any way.

NOTE: This oven draws 13.8 amperes at 120 Volts, 60 Hz.

SAFETY

IMPORTANT SAFETY INSTRUCTIONS

The safety instructions below will tell you how to use your oven to avoid harm to yourself or damage to your oven.

WARNING - To reduce the risk of burns, electric shock, fire, injury to persons, or exposure to excessive microwave energy:

1. Read all instructions before using the appliance.
2. Read and follow the specific **PRECAUTIONS TO AVOID POSSIBLE EXPOSURE TO EXCESSIVE MICROWAVE ENERGY** found on page 3 of this manual.
3. This appliance must be grounded. Connect only to properly grounded outlet. See **GROUNDING INSTRUCTIONS** found on page 3 of this manual .
4. Install or locate this appliance only in accordance with the provided installation instructions.
5. Some products, such as whole eggs and sealed containers – for example, closed glass jars are able to explode and should not be heated in this oven.
6. Use this appliance only for its intended use as described in the manual. Do not use corrosive chemicals or vapors in this appliance. This type of oven is specifically designed to heat, cook, or dry food. It is not designed for industrial or laboratory use.
7. As with any appliance, close supervision is necessary when used by children.
8. Do not operate this appliance if it has a damaged cord or plug, if it is not working properly, or if it has been damaged or dropped.
9. This appliance should be serviced only by qualified service personnel. Contact the nearest authorized service facility for examination, repair, or adjustment.
10. Do not cover or block any openings on the appliance.
11. Do not store this appliance outdoors. Do not use this product near water – for example, near a kitchen sink, in a wet basement, near a swimming pool, or similar location.
12. Do not immerse cord or plug in water.
13. Keep cord away from heated surfaces.
14. Do not let cord hang over the edge of a table or counter.
15. When cleaning surfaces of door and oven that come together on closing the door, use only mild, nonabrasive soaps or detergents applied with a sponge or soft cloth.
16. To reduce the risk of fire in the oven cavity:
 - a. Do not over cook food. Carefully attend appliance when paper, plastic, or other combustible materials are placed inside the oven to facilitate cooking.
 - b. Remove wire twist-ties from paper or plastic bags before placing bag in oven.
 - c. If materials inside the oven ignite, **KEEP OVEN DOOR CLOSED**, turn oven off, and disconnect the power cord or shut off power at the fuse or circuit breaker panel.
 - d. Do not use the cavity for storage purposes. Do not leave paper products, cooking utensils, or food in the cavity when not in use.
17. Liquids, such as water, coffee, or tea are able to be overheated beyond the boiling point without appearing to be boiling. Visible bubbling or boiling when the container is removed from the microwave oven is not always present. **THIS COULD RESULT IN VERY HOT LIQUIDS SUDDENLY BOILING OVER WHEN THE CONTAINER IS DISTURBED OR A SPOON OR OTHER UTENSIL IS INSERTED INTO THE LIQUID.** To reduce the risk of injury to persons; 1) Do not overheat the liquid. 2) Stir the liquid both before and halfway through heating it. 3) Do not use straight-sided containers with narrow necks. 4) After heating, allow the container to stand in the microwave oven for a short time before removing the container. 5) Use extreme care when inserting a spoon or other utensil into the container.
18. Avoid heating small-necked containers such as syrup bottles.
19. Avoid using corrosive and vapors, such as sulfide and chloride.
20. Liquids heated in certain shaped containers (especially cylindrical-shaped containers) may become overheated. The liquid may splash out with a loud noise during or after heating or when adding ingredients (instant coffee, etc.), resulting in harm to the oven and possible injury. In all containers, for best results, stir the liquid several times before heating. Always stir liquid several times between reheatings.

SAVE THESE INSTRUCTIONS

SAFETY - TOASTER

IMPORTANT SAFETY INSTRUCTIONS

When using electrical appliances, especially when children are present, basic safety precautions should always be followed, including the following:

1. Read all instructions before using your toaster.
2. Do not touch hot surfaces.
3. To protect against electrical hazards, do not immerse cord, plug, or the appliance in water or other liquid.
4. Close supervision is necessary when any appliance is used by or near children.
5. Unplug from outlet when not in use and before cleaning. Allow to cool before putting on or taking off parts and before cleaning.
6. Do not operate any appliance with a damaged cord or plug or after the appliance malfunctions or has been dropped or damaged in any manner. Return appliance to the nearest authorized service center for examination, repair or electrical or mechanical adjustment.
7. The use of attachments not recommended by the manufacturer may cause hazards.
8. Keep the cord away from heated surfaces. Do not let the cord hang over the edge of table or counter, as it could be pulled off.
9. Do not use outdoors.
10. Do not place on or near a hot gas or electric burner or in a heated oven.
11. Do not use the appliance for other than its intended use.
12. Oversized foods, metal foil packages or utensils must not be inserted in this appliance, as they may create a fire or electrical hazards.
13. A fire may occur if this toaster is covered or touching flammable material, including curtains, draperies, walls, etc., when in operation.
14. Do not attempt to dislodge food when this appliance is plugged in.
15. Toast Door must be closed before attaching or disconnecting the plug from wall outlet.
16. Do not clean with metal scouring pads. Pieces can burn off the pad and touch electrical parts involving a risk of electric shock.
17. Do not use paper products when appliance is operated in the toaster mode.
18. Do not store any materials, other than manufacturer's recommended accessories, in this oven when not in use.
19. Do not cover crumb tray or any other part of the oven with metal foil. This will cause overheating of this appliance.
20. Extreme caution must be used when moving an appliance containing hot oil or other hot liquids.
21. Do not toast oversized bagel. Because thick bagel's surface may become closer to the heater, this may cause overdone of surface and smoke.

SAVE THESE INSTRUCTIONS!

UNDERSTANDING YOUR TOASTER CAMBO

SPECIFICATIONS

Power Supply	120V AC, 60 Hz	
Rated Power Consumption	1650W	
Microwave Output	Microwave	*1200W
	Toaster	800W
Rated Current	13.8A	
Overall Dimensions(WxHxD)	23"x12 1/2"x17 1/8"	
Oven Cavity Dimensions(WxHxD)	14 1/16"x9 5/8"x15 5/8"	
Capacity of Oven Cavity	1.2 cu.ft	

*IEC 60705 RATING STANDARD

Specifications subject to change without prior notice.

INSTALLATION

1. Remove your LG Toast Combo and all packing materials from the shipping carton.
2. Place the oven on a level surface that provides at least 4 inches of space at the left, right, top, and rear sides for proper ventilation.
3. Place the rotating ring in the circle on the oven floor and then place the glass turntable on the top of the turntable roller rest.

NOTE: Never place the glass turntable in the oven upside down. Blocking the inlet and/or outlet openings can damage the oven.

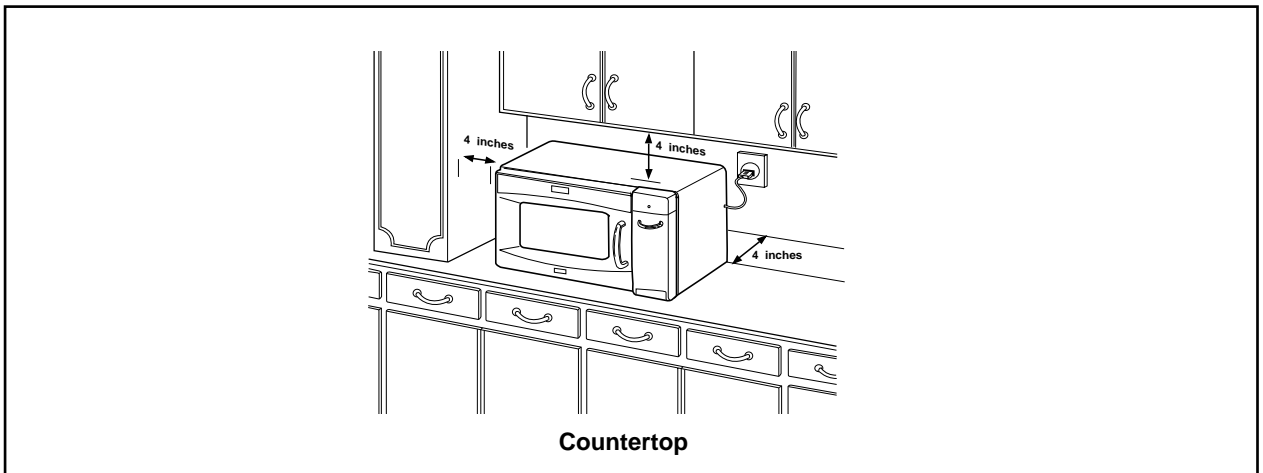

⚠️ WARNING

To reduce the risk of fire or electric shock, do not install closer than 4 inches to side and back wall.

UNDERSTANDING YOUR TOASTER CAMBO

PARTS AND ACCESSORIES

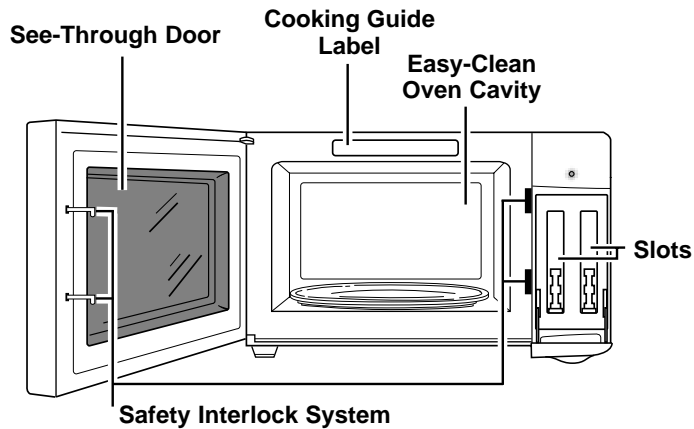
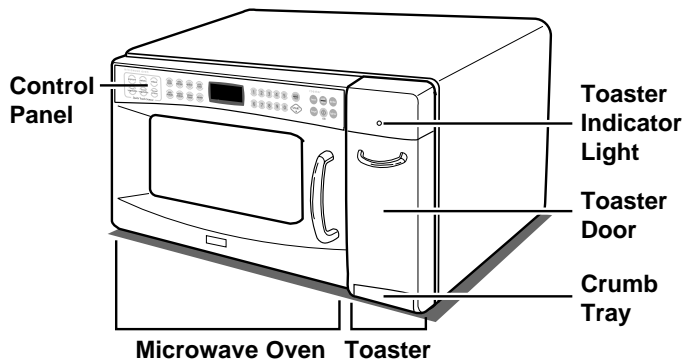

Your oven comes with the following accessories:

- 1 Use and Care Guide
- 1 Glass Turntable
- 1 Turntable Rotating Ring

Glass Turntable

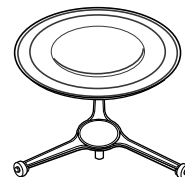

Turntable Rotating ring

UNDERSTANDING YOUR TOASTER CAMBO

CONTROL PANEL

MICROWAVE CONTROL AREA

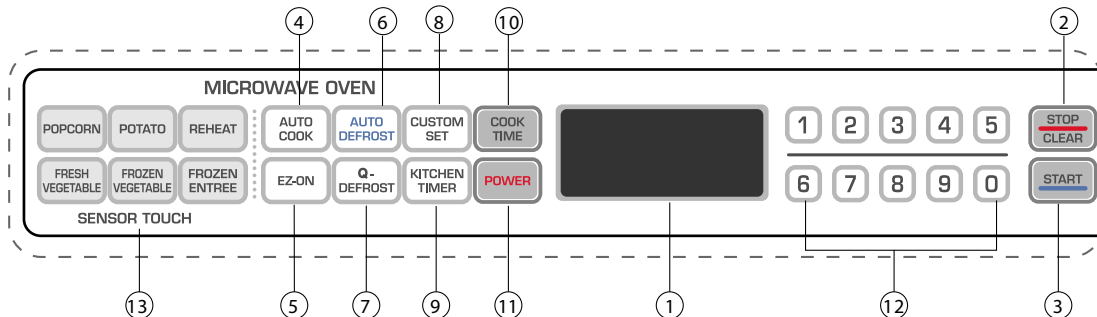

- 1. DISPLAY.** The Display includes a clock and indicators that tell you time of day, cooking time settings, and cooking functions selected.
- 2. STOP/CLEAR.** Touch this pad to stop the oven or clear entries.
- 3. START.** Touch this pad to start all entries (except the Auto Cook and Add Minute function which start automatically) and to turn Child Lock on or off.
- 4. AUTO COOK.** Touch this pad to select programming food items.
- 5. EZ-ON.** Touch this pad to cook at 100% cook power for 1 minute to 99 minutes 59 seconds.
- 6. AUTO DEFROST.** This pad is an accurate defrosting method for frozen meat, poultry and fish up to 6.0 lbs.
- 7. Q-DEFROST.** This pad provides you with the quick defrosting method for 1.0 pound frozen foods.
- 8. CUSTOM SET.** Touch this pad to change the oven's default settings for sound, clock, scroll speed and Lbs/Kg.
- 9. KITCHEN TIMER.** Touch this pad to use your microwave oven as a kitchen timer.
- 10. COOK TIME.** Touch this pad to set a cooking time.
- 11. POWER.** Touch this pad to set a cooking power.
- 12. NUMBER PADS.** Touch Number Pads to enter cooking time, power level, quantities, or weights.
- 13. SENSOR TOUCH.** This pad allows you to cook most of your favorite foods without having to select cooking times and power levels.

TOASTER CONTROL AREA

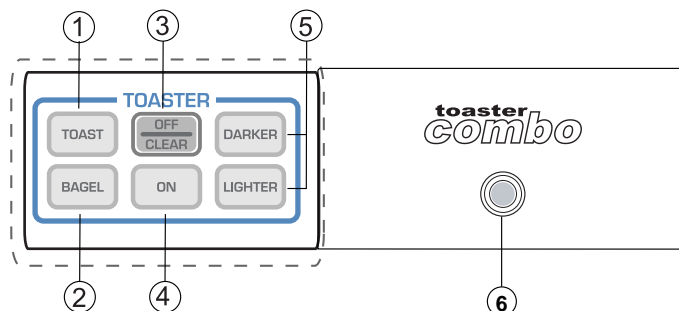

- 1. Toast.** Toast bread
- 2. Bagel.** Toasts Bagels
- 3. Off/Clear.** Touch this pad to stop the toaster or clear entries.
- 4. On.** Touch this pad to start the toasting process.
- 5. Darkness Control.** Adjust darkness control to desired setting before cooking foods.
(Default : 5, "1" is the lightest and "9" is the darkest)
- 6. Indicator Light.** When operating toaster with door closed, this will be illuminated. If you open the door during toasting, this will blink.

USING YOUR MICROWAVE OVEN

COOKWARE GUIDE

Most heat-resistant, non-metallic cookware is safe for use in your microwave oven. However, to test cookware before using, follow these steps:

1. Place the empty cookware in the microwave oven.
2. Measure 1 cup of water in a glass measuring cup and place it in the oven beside the cookware.
3. Microwave on 100% power for 1 minute. If the dish is warm, it **should not** be used for microwave cooking.

USE	DO NOT USE
<p>Ovenproof Glass</p> <ul style="list-style-type: none"> • Glass treated for use in high-intensity heat includes utility dishes, bread dishes, pie plates, cake plates, liquid measuring cups, casseroles, and bowls without metallic trim. <p>China</p> <ul style="list-style-type: none"> • Bowls, cups, serving plates, and platters without metallic trim can be used in your oven. <p>Plastic</p> <ul style="list-style-type: none"> • When using plastic wrap as a cover, make sure that the dish is deep enough so the plastic wrap does not touch the food. As the food heats, it may melt the plastic wrap wherever the wrap touches the food. • Place plastic wrap loosely over the top of the dish and secure it by pressing the wrap to the sides of the dish. • Vent by turning back one corner of the plastic wrap. This will allow excess steam to escape. • Use plastic dishes, cups, semi-rigid freezer containers, and plastic bags only for short time cooking. Use these with care because the plastic may soften from the heat of the food. <p>Paper</p> <ul style="list-style-type: none"> • Microwave-safe paper towels, waxed paper, paper napkins, and paper plates with no metallic trim or design can be used in your oven. • Refer to the paper manufacturer's label for use of any paper product in the microwave oven. 	<p>Metal Utensils</p> <ul style="list-style-type: none"> • Metal shields food from microwave energy and produces uneven cooking. Avoid metal skewers, thermometers, or foil trays. • Metal utensils can cause arcing, which is a discharge of electric current. Arcing can damage your microwave oven. <p>Metal Decoration</p> <ul style="list-style-type: none"> • Do not use metal-trimmed or metal-banded dinnerware, casserole dishes, etc. <p>Centura™ Tableware</p> <ul style="list-style-type: none"> • The Corning Company recommends that you do not use Centura tableware and some Corelle™ closed-handle cups for microwave cooking. <p>Aluminum Foil</p> <ul style="list-style-type: none"> • Do not use large sheets of aluminum foil because they hinder cooking and may cause arcing. You may use small pieces of foil to shield poultry legs and wings. • Keep all aluminum foil at least 1 inch from the walls and door of the oven. <p>Wood</p> <ul style="list-style-type: none"> • Wooden bowls, boards, and baskets will dry out and may split or crack when you use them in the microwave oven. <p>Tightly Closed Containers</p> <ul style="list-style-type: none"> • Tightly closed cookware can explode. Be sure to leave an opening for steam to escape from covered cookware. <p>Brown Paper</p> <ul style="list-style-type: none"> • Do not use brown paper bags. They absorb heat and could burn. <p>Metal Twist-Ties</p> <ul style="list-style-type: none"> • Always remove metal twist-ties as they can become hot and cause a fire.

USING YOUR MICROWAVE OVEN

TIPS FOR MICROWAVE COOKING

BROWNING

Meat and poultry with high fat content that are cooked for 10 or 15 minutes or longer will brown lightly. Foods cooked a shorter time can be brushed with a browning agent, such as Worcestershire sauce, soy sauce, or barbecue sauce.

COVERING

A cover traps heat and steam and causes the food to cook more quickly. Use a lid or microwave-safe plastic wrap with one corner folded back to vent the excess steam. Lids on glass casseroles can become hot during cooking. Handle carefully. Waxed paper will prevent the food from splattering in the oven and help retain heat. When warming bread items, use waxed paper, napkins, or paper towels. To absorb extra moisture, wrap sandwiches and fatty foods in paper towels.

SPACING

Arrange individual foods, such as baked potatoes, cupcakes, and hors d'oeuvres in a circle and at least 1 inch apart. This will help the food cook more evenly.

STIRRING

Stirring blends flavors and redistributes the heat in foods. Always stir from the outside toward the center of the dish. Food at the outside of the dish heats first.

TURNING

Large foods, such as roasts and whole poultry, should be turned so that the top and bottom cook evenly. Also turn over chicken pieces and chops.

CLEANING

Wipe the oven inside and outside with a soft cloth and a mild detergent solution. Then rinse and wipe dry. This should be done weekly or more often, if needed. Never use cleaning powders or rough pads. Excessive oil splatters on the inside top will be difficult to remove if left for many days. Wipe splatters with a wet paper towel, especially after cooking chicken or bacon.

REMOVABLE PARTS

The turntable and turntable support are removable. They should be hand-washed in warm (not hot) water with a mild detergent and a soft cloth. Once they are clean, rinse well and dry with a soft cloth. Never use cleaning powders, steel wool, or rough pads.

ARRANGEMENT

Do not stack food. Arrange in a single layer in the dish for more even cooking. Because dense foods cook more slowly, place thicker portions of meat, poultry, fish, and vegetables toward the outside of the dish.

TESTING FOR DONENESS

Because foods cook quickly in a microwave oven, you need to test frequently for doneness.

STANDING TIME IN OVEN

Depending on density, food often needs to stand from 2 to 15 minutes either in or outside of the oven after cooking power shuts off. Outside of the oven, you usually need to cover food during standing time to retain heat. Remove most foods when they are slightly undercooked and they will finish cooking during standing time. The internal temperature of food will rise about 10°F during standing time.

SHIELDING

To prevent some portions of rectangular or square dishes from overcooking, you may need to shield them with small strips of aluminum foil to block the microwaves. You can also cover poultry legs and wing tips with foil to keep them from overcooking. **Always keep foil at least 1 inch from oven walls** to prevent arcing.

PIERCING

Pierce the shell, skin, or membrane of foods before cooking to prevent them from bursting. Foods that require piercing include yolks and whites of eggs, hot dogs, clams, oysters, and whole vegetables, such as potatoes and squash.

- The turntable may be cleaned at the sink. Be careful not to chip or scratch the edges as this may cause the turntable to break during use. Oven turntable may also be cleaned in a dishwasher.
- The turntable support rest should be cleaned regularly.

SPECIAL CARE

For best performance and safety, the inner door panel and the oven front frame should be free of food or grease buildup. Wipe often with a mild detergent; then rinse and wipe dry. Never use cleaning powders or rough pads.





After cleaning the control panel, touch STOP/CLEAR to clear any entries that might have been entered accidentally while cleaning the panel.

USING YOUR MICROWAVE OVEN

CUSTOM SET









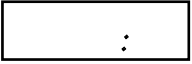

CUSTOM SET provides four modes which make using your microwave oven quite handy. You can select CLOCK, SOUND ON/OFF, SCROLL SPEED and LBS/KG.

Example: To turn off sound of beeper

Touch:	Display Shows:
1. 	Time of day.
2. 	Four modes show in the display.
3. 	<i>SOUND ON TOUCH 1 OFF TOUCH 2</i>
4. 	<i>SOUND OFF</i>



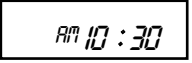

NOTE: To turn beep sound back on, repeat steps 1~3 then touch number 1.

Example: To set the clock for 10:30(AM).

Touch:	Display Shows:
1. 	
2. 	Four modes show in the display.
3. 	<i>:ENTER TIME OF DAY</i>
4.    	<i>10 : 30 TOUCH START</i>
5. 	<i>10 : 30 AM TOUCH 1 PM TOUCH 2</i>
6. 	<i>AM 10 : 30 TOUCH START</i>
7. 	

NOTE: This is a 12 hour clock. You can switch between AM and PM by touching 1 or 2 after step 5.

CUSTOM SET TABLE

NUMBER	OPTION	NUMBER	RESULT
	CLOCK		
	SOUND ON / OFF	1	Sound On
		2	Sound Off
	SCROLL SPEED	1	Slow speed
		2	Normal speed
		3	Fast speed
	LBS / KG	1	Lbs
		2	Kg

NOTE: When the power cord is first plugged in, the default settings are Sound On, Clock On, Normal Speed and LBS.

USING YOUR MICROWAVE OVEN

SENSOR TOUCH

OPERATION INSTRUCTION

Sensor touch cooking provides exciting new features to make microwaving easier. The Sensor Menu is preprogrammed with many popular food choices and helps you heat or reheat perfectly.

Sensor Menu:

Reheat, Potato
Popcorn, Fresh Vegetable
Frozen Vegetable, Frozen Entree

For most Sensor Touch Cooking programs, a table with specific food examples and cooking instructions is provided in the next few pages.

- The Sensor Touch system works by detecting a build-up of vapor.
- Make sure the door remains closed.
- Once the vapor is detected, two beeps will sound.
- Opening the door or touching the STOP/CLEAR pad before the vapor is detected will abort the process. The oven will stop.
- Before using Sensor Touch, make sure the exterior of the reheating container and the interior of the oven are dry, to assure the best results.
- Room temperature should not exceed 95°F.
- Oven should be plugged in at least 5 minutes before sensor cooking.

POTATO (EXAMPLE)

SENSOR COOK allows you to cook most of your favorite foods without having to select cooking times and power levels. This oven automatically determines required cooking times for each food item.

Example: To cook potato

Touch: **Display Shows:**

1.  Time of day.

2.  *POTATO*

SENSOR TOUCH TABLE

CATEGORY	DIRECTION	AMOUNT
Potato	Pierce each potato with a fork and place on the oven tray around the edge, at least one inch apart.	1~4 medium approx. 10 oz. each
Popcorn	Place bag of prepackaged microwave popcorn on the center of turntable	Regular sizes Use one fresh bag of popcorn
Fresh Vegetable	Prepare as desired, wash, and leave residual water on the vegetables. Place in an appropriately-sized microwave container, cover with plastic wrap and vent.	1~4 cups
Frozen Vegetable	Remove from package, rinse off frost under running water. Place in an appropriately-sized microwave container, cover with plastic wrap and vent.	1~4 cups
Frozen Entree	Remove from outer display package. Slit cover. If not in microwave-safe container, place on plate, cover with plastic wrap, and vent.	10~21 oz.

NOTE: If you open the door or press STOP during sensing, the process will be canceled.

USING YOUR MICROWAVE OVEN

REHEAT

This feature allows you to reheat precooked room-temperature or refrigerated foods without selecting cooking times and power levels. This feature has 3 categories: dinner plate, soup/sauce, casserole. See Reheat Table for more information.

Example: To reheat casserole.

Touch:



Display Shows:

Time of day.

*SELECT MENU 1 TO 3 -
-SEE COOKING GUIDE*

CASSEROLE

The oven will reheat food automatically using the sensor system.

REHEAT TABLE

Code	Category	Direction	Amount
1	Dinner plate	Place foods to be heated on dinner plate or similar dish. Cover with plastic wrap.	Approx. 8~16 oz.
2	Soup/Sauce	Place foods to be heated in an appropriately sized microwave container. Cover with plastic wrap.	1~4 cups
3	Casserole	Cover dish containing the casserole with plastic wrap.	1~4 cups



NOTE: Refer to the Cooking Guide located on the front of oven cavity for Reheat information.

USING YOUR MICROWAVE OVEN

AUTO COOK

Use this function to cook food without entering a cook time or power. Refer to the "Auto Cook Table" below for more information.

Example: To cook 4 slices of bacon.



- | Touch: | Display Shows: |
|--|---|
| 1.  | <i>SELECT MENU 1 TO 6 -
-SEE COOKING GUIDE</i> |
| 2.  | <i>BACON
TOUCH 2 TO 6 SLICES</i> |
| 3.  | Time counts down
after <i>4 SLICES</i> scrolls
in the display |

NOTE: Refer to the Cooking Guide located on the front of oven cavity for Auto Cook information.

EZ-ON







A time-saving pad, this simplified control lets you quickly set and start microwave cooking at 100% power without the need to touch START.

Example: To cook for 2 minutes.

- | Touch: | Display Shows: |
|--|---|
| 1.  | Time of day. |
| 2.  | Twice Time counting down
and power 100 |

NOTE: Each time you touch EZ-ON, it will add 1 minute up to 99 minutes 59 seconds.

AUTO COOK TABLE





CODE	CATEGORY	DIRECTION	AMOUNT
	Bacon	Place bacon strips on microwave bacon rack for best results. (Use dinner plate lined with paper towels if rack is not available).	2 to 6 slices
	Frozen Roll/Muffin	Remove from display package and place on plate. (If muffins are over 3 oz. each, count as two when entering quantity, heat no more than 3 at a time.)	1 to 6 pieces (2-3 oz. each)
	Fresh Roll/Muffin	Remove from display package and place on plate. (If muffins are over 3 oz. each, count as two when entering quantity, heat no more than 3 at a time.)	1 to 6 pieces (2-3 oz. each)
	Beverage	Remove from display package and place on plate. (Be careful! The beverage will be very hot! Sometimes liquids heated in cylindrical containers will splash out when the container is moved.)	1 to 2 cups
	Chicken Pieces	Place the chicken pieces in an appropriately sized microwaveable container, cover with plastic wrap, and vent.	0.5 to 2 lbs. (0.2 to 1.0 kg)
	Hot Cereal	Prepare as directed on package and cook. Stir and allow standing time before eating. Use only instant hot cereal.	1 to 6 servings

USING YOUR MICROWAVE OVEN

KITCHEN TIMER

Your microwave oven can be used as a kitchen timer. You can set up to 99 minutes, 99 seconds.

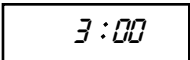

Example: To set 3 minutes.

- | Touch: | Display Shows: |
|--|---|
| 1.  | : ENTER TIME IN MIN
AND SEC |
| 2.    | 3 : 00 TOUCH START |
| 3.  | 
TIMER and time counting down. |

CHILD LOCK

You can use this safety feature to lock the control panel so that children cannot use the oven and toaster when you do not want them to and when you are cleaning the oven and toaster.

To set CHILD LOCK:

- | Touch: | Display Shows: |
|--|--|
| 1.  | Time of day. |
| 2.  | Touch and hold until LOCKED appears in the display (approximately 4 seconds).
LOCKED |

To cancel CHILD LOCK:

- | Touch: | Display Shows: |
|--|--|
| 1.  | Touch and hold until LOCKED disappears from the display (approximately 4 seconds).
Time of day. |

USING YOUR MICROWAVE OVEN





AUTO DEFROST

Three defrost sequences are preset in the oven. The auto defrost feature provides you with the best defrosting method for frozen foods. The Cooking Guide on the front of the oven cavity will show you which defrost sequence is recommended for the food you are defrosting.

For added convenience, the Auto Defrost includes a built-in beep mechanism that reminds you to check, turn over, separate, or rearrange the food to get best defrost results. Three different defrosting options are provided.

- 1 MEAT
- 2 POULTRY
- 3 FISH

*Available weight is 0.1~6.0 lbs. (0.1 ~ 4.0 kg)

Example: To defrost 1.2 lbs of ground beef.	
Touch:	Display Shows:
1. 	<i>MEAT TOUCH 1 POULTRY TOUCH 2 FISH TOUCH 3</i>
2. 	<i>0.0 Lbs ENTER WEIGHT</i>
3.  and  to enter the weight	<i>1.2 Lbs TOUCH START</i>
4. 	Time counting down and DEFROST.

NOTE:

When you touch the START pad, the display changes to defrost time count down. The oven will beep during the DEFROST cycle. At this time, open the door and turn, separate, or rearrange the food. Remove any portions that have thawed. Return frozen portions to the oven and touch START to resume the defrost cycle.

OPERATING TIPS

- For best results, remove fish, shellfish, meat, and poultry from its original closed paper or plastic package (wrapper). Otherwise, the wrap will hold steam and juice close to the foods, which can cause the outer surface of the foods to cook.
- For best results, shape your ground meat into the form of a doughnut before freezing. When defrosting, scrape off thawed meat when the beep sounds and continue defrosting.
- Place foods in a shallow container or on a microwave roasting rack to catch drippings.
- Food should still be somewhat icy in the center when removed from the oven.

Q-DEFROST

This feature should be used only when you defrost 1 pound of frozen ground beef.

Example: To defrost 1 lb ground beef.

Touch:	Display Shows:
1. 	Time of day.
2. 	Time counting down and EXPRESS DEFROST.

USING YOUR MICROWAVE OVEN

AUTO DEFROST TABLE







Category	Food to be Defrosted
1 MEAT	Beef Ground beef, Round steak, Cubes for stew, Tenderloin steak, Pot roast, Rib roast, Rump roast, Chuck roast, Hamburger patty Lamb Chops (1-inch thick), Rolled roast Pork Chops (1/2-inch thick), Hot dogs, Spareribs, Country-style ribs. Rolled roast, Sausage Veal Cutlets (1 lb., 1/2-inch thick)
2 POULTRY	Poultry Whole (under 4 lbs.), Cut-up, Breasts (boneless) Cornish Hens Whole Turkey Breast
3 FISH	Fish Fillets, Whole Steaks Shellfish Crab meat, Lobster tails, Shrimp, Scallops

TIMED COOKING

This feature lets you program a specific cook time and power. For best results, there are 10 power level settings in addition to HIGH power (100%). Refer to the "Microwave Power Level Table" on page 18 for more information.

NOTE: If you do not select a power level, the oven will automatically cook at HIGH (100%) power.

Example: To cook for 5 minutes, 30 seconds at 80% power.

- | Touch: | Display Shows: |
|--|-------------------------------------|
| 1.  | : ENTER COOKING TIME |
| 2.    | 5 : 30 TOUCH START
OR POWER |
| 3.  | ENTER POWER
LEVEL 1 TO 10 |
| 4.  | 5 : 30 POWER
80 TOUCH START |
| 5.  | Time counting down
and POWER 80. |

USING YOUR MICROWAVE OVEN

MULTI-STAGE COOKING



For best results, some recipes call for different cook powers during different stages of a cook cycle. You can program your oven for 2 stages, so that it will switch from one power level to another during the cook cycle.

Example: To set a 2-stage cook cycle.

Touch:

Display Shows:

1.  : ENTER COOKING TIME

2.    3 : 00 TOUCH START OR POWER

to set a 3 minute cook time for first stage.

3.  3 : 00 ENTER POWER LEVEL 1 TO 10

4.  to set an 80% cook power for the first stage. 3 : 00 POWER 80 TOUCH START

5.  : ENTER COOKING TIME

6.    7 : 00 TOUCH START OR POWER

to set a 7 minute cook time for second stage.

7.  7 : 00 ENTER POWER LEVEL 1 TO 10

8.  to set a 50% cook power for the second stage. 7 : 00 POWER 50 TOUCH START

9.  Time counting down and POWER 80.

10. When the first stage is over, you will hear two short tones as the oven begins the second cook stage.

MICROWAVE POWER LEVELS

Your microwave oven has 10 cook power levels to let you cook or heat a wide variety of foods. Refer to the table below for suggestions:

Microwave Power Level Table

Power Level	Use
10 (High)	<ul style="list-style-type: none"> Boiling water. Making candy. Cooking poultry pieces, fish, and vegetables. Cooking tender cuts of meat. Whole poultry.
9	<ul style="list-style-type: none"> Reheating rice, pasta, and vegetables.
8	<ul style="list-style-type: none"> Reheating prepared foods quickly. Reheating sandwiches.
7	<ul style="list-style-type: none"> Cooking egg, milk, and cheese dishes. Cooking cakes, breads. Melting chocolate.
6	<ul style="list-style-type: none"> Cooking veal. Cooking whole fish. Cooking puddings and custard.
5	<ul style="list-style-type: none"> Cooking ham, whole poultry, and lamb. Cooking rib roast, sirloin tip.
4	<ul style="list-style-type: none"> Thawing meat, poultry, and seafood.
3	<ul style="list-style-type: none"> Cooking less tender cuts of meat. Cooking pork chops, roast.
2	<ul style="list-style-type: none"> Taking chill out of fruit. Softening butter.
1	<ul style="list-style-type: none"> Keeping casseroles and main dishes warm. Softening butter and cream cheese.
0	<ul style="list-style-type: none"> Standing time.

NOTE: You may program standing time as the second stage in multi-stage cooking.

USING YOUR MICROWAVE OVEN

WARNING: Do not use large sheets of aluminum foil because they hinder cooking and may cause arcing. You may use small pieces of foil to shield poultry legs and wings. Keep all aluminum foil at least 1 inch from the walls and door of the oven.

COOKING TIPS

Meat

1. No special techniques are required. Meat should be prepared as with conventional cooking. Season if desired. Always thoroughly defrost meat before cooking.
2. Place the meat on a microwave roasting rack or microwave-proof plate and place on the turntable.
3. Cook according to the Meat Cooking Table (below). Use the longer time for large cuts of meats and the shorter time for small cuts of meats. For thicker chops, use the longer time.
4. Turn the meat over once halfway through the cooking time.
5. After cook time has finished, allow for 5~10 minutes of standing time to complete the cooking process. If you remove meat for standing time, wrap it in foil.
6. Make sure meat, especially pork, is thoroughly cooked before eating.

Meat Cooking Table

Meat	Microwave Power	Cooking Time Per Pound
BEEF Standing/Rolled Rib – Medium – Well-done Ground Beef (to brown for casserole) Hamburgers, Fresh or defrosted (4 oz. each) – 2 patties – 4 patties	8 8 HIGH (100%) HIGH (100%) HIGH (100%)	9½ to 11½ minutes 11½ to 14 minutes 6½ to 9½ minutes 2½ to 4½ minutes 3½ to 5½ minutes
PORK Loin, Leg Bacon – 4 slices – 6 slices	8 HIGH (100%) HIGH (100%)	12½ to 16½ minutes 2½ to 3½ minutes 3½ to 4½ minutes

NOTE: The times listed above are only a guide. Allow for difference in individual tastes and preferences. The times may also vary due to the shape, cut, and composition of the food.

Poultry

1. No special techniques are required. Poultry should be prepared as with conventional cooking. Season if desired.
2. Poultry should be thoroughly defrosted. Remove giblets and any metal clamps.
3. Prick the skin and brush lightly with vegetable oil unless the poultry is self-basting.
4. All poultry should be placed on a microwave roasting rack or a microwave-proof plate and placed on the turntable.
5. Cook according to the instructions in the Poultry Cooking Table below. Turn over halfway through the cooking time. Because of its shape, poultry has a tendency to cook unevenly, especially in very bony parts. Turning food over helps to cook these areas evenly.
6. After cook time has finished, allow for 5~10 minutes of standing time to complete the cooking process. If you remove poultry for standing time, wrap it in foil.
7. Make sure poultry is thoroughly cooked before eating. Whole poultry is completely cooked when the juices run clear from the inside thigh when it is pierced with a sharp knife. Poultry pieces should be pierced with a sharp knife through the thickest part to ensure that the juices are clear and the flesh is firm.

Poultry Cooking Table

Poultry	Microwave Power	Cooking Time Per Pound
CHICKEN Whole Breast (boned) Portions	8 8 8	11 to 15 minutes 10 to 14 minutes 11 to 17 minutes
TURKEY Whole	8	11 to 15 minutes

NOTES:

- The times listed above are only a guide. Allow for difference in individual tastes and preferences. The times may also vary due to the shape, cut, and composition of the food.
- If whole poultry is stuffed, the weight of the stuffed bird should be used when calculating the cooking time.

USING YOUR MICROWAVE OVEN

COOKING TIPS (continued)

Fish

1. Arrange fish in a large shallow non-metallic dish or casserole.
2. Cover with pierced microwave plastic wrap or casserole lid.
3. Place the dish on the turntable.
4. Cook according to the instructions in the Fresh Fish Cooking Table below. Flakes of butter can be added to the fish if desired.
5. Let stand as directed in the Cooking Table before serving.
6. After standing time, check to see that the fish is thoroughly cooked. The fish should be opaque and flake easily.

Fresh Fish Cooking Table

Fish	Microwave Power	Cooking Time Per Pound	Butter	Standing Time
Fish Fillets	HIGH	4½ to 8 minutes	Add 15 to 30 ml (1 to 2 tbsp lemon juice)	2 to 3 minutes
Whole Mackerel, Cleaned and Prepared	HIGH	4½ to 8 minutes	–	3 to 4 minutes
Whole Trout, Cleaned and Prepared	HIGH	5½ to 9 minutes	–	3 to 4 minutes
Salmon Steaks	HIGH	5½ to 8 minutes	Add 15 to 30 ml (1 to 2 tbsp lemon juice)	3 to 4 minutes

USING YOUR TOASTER

TIPS FOR TOASTER

IMPORTANT

Before using the toaster for the first time, set the Darkness Control at medium and operate the toaster without bread in order to burn off residues on the heating elements. You will notice an odor that is characteristic of new heating elements. This is normal and will soon disappear.

MAINTANANCE

This toaster requires little maintenance. It contains no user-serviceable parts inside the housing. Do not remove the cover. Contact Authorized Service, if the product requires servicing.

CLEANING THE TOASTER

Always unplug the Toaster Cambo and allow the toaster to cool completely before cleaning.

Exterior : Wipe surface with a soft, clean, damp cloth. Never use abrasive cleaners, as they may scratch the surface.

Interior : If food jams in the slots, disconnect Toaster cambo plug from wall outlet and wait until cooled completely. Remove food with wooden tongs. Do not use fork or other sharp, metal object to clean inside of the toaster, or to remove toast, as it may damage heating elements.

Crumb Tray : After allowing the toaster to cool down and closing the door, gently slide out the crumb tray. Brush crumbs off the tray and, if necessary, wipe it with a clean, damp cloth. Always dry the tray thoroughly. When sliding the crumb tray into place, be sure you feel and hear it snap into position.

COOKING TIPS

WARNING

Never place any non-food object in the toaster for any reason!

- DO NOT toast pastries with runny fillings or frosting.
- DO NOT toast torn slices of bread or broken pastries.
- DO NOT place buttered bread, wrapped food, or frozen pastries in the toaster.
- DO NOT use this toaster to toast or warm small-size bread slices. These include "melba" size breads, slices of mini-baguettes, breadsticks, etc.
- DO NOT toast oversized bagel. Because thick bagel's surface may become closer to the heater, this may cause overdone surface and smoke.

NOTE: Different types of bread and their moisture levels may require different darkness settings. For example, dry bread will brown more rapidly than moist bread and so should be toasted to your taste at a lighter setting.

USING YOUR TOASTER

OPERATING INSTRUCTIONS

- Make sure the crumb tray is pushed all the way in place before plugging toaster into wall outlet.
- Remove all protective wrappings from food before placing into toasting slots. Place bread into slots and close the door. Then select either the Toast or Bagel mode. The default setting is 5. Press the "lighter" or "darker" pad to adjust setting to individual taste. When you press the Start button, the heating element will turn on.
- **If you are only using one toasting slot, uneven browning may occur.** If you operate toaster several times using one slot continuously, the toaster's internal temperature will be hot and may cause "Hot" to appear in the display. This will go away after several minutes after the toaster cools down.
- Do not adjust the Darkness Control while the toaster is in use. To interrupt the toasting cycle, press the "stop/clear" control button.
- During the toasting cycle, the indicator light will be illuminated. If you open the door, toasting will stop and the light will blink. The toasting cycle can be resumed by closing the toaster door and pressing the start button.
- When the beep sounds, take out food, being careful not to touch toaster's hot surface.

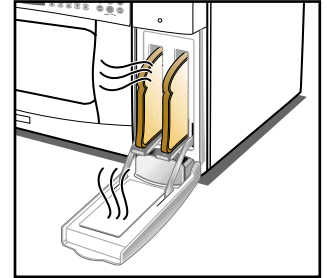

NOTE: After use of toaster, fan will run for 1 minute to cool.

Toast/Bagel Darkness Settings





Degree of darkness	Select darkness level
Light	1~3
Medium	4~6
Dark	7~9

NOTE : For English Muffins, use bagel settings.

Toast

This toaster automatically determines required cooking times for toasting

Example : To toast bread at level 3.





Touch:	Display Shows:	Indicator light
1. 	Time of day	
2. 	<i>5 TOAST TOUCH</i> <i>TOASTER START OR LEVEL</i>	off
3.  Twice	<i>3 TOAST TOUCH</i> <i>TOASTER START</i>	off
4. 	<i>3 TOAST</i> Starts toasting.	on

USING YOUR TOASTER

Bagel

Use this function to cook bagel.

Example : To toast bagel at level 7.

Touch:	Display Shows:	Indicator light
1. 	Time of day	
2. 	<i>5 BAGEL TOUCH TOASTER START OR LEVEL</i>	off
3.  Twice	<i>7 BAGEL TOUCH TOASTER START</i>	off
4. 	<i>7 BAGEL</i> Starts toasting.	on

TROUBLESHOOTING

Questions and Answers

Operation

Question	Answer
Why is the oven light not on during cooking?	There may be several reasons why the oven light is not on. Have you: <ul style="list-style-type: none"> • Set a cooking time? • Touched START?
Why does steam come out of the air exhaust vent?	Steam is normally produced during cooking. The microwave oven has been designed to vent this steam.
Will the microwave oven be damaged if it operates empty?	Yes. Never operate the oven empty or without the glass turntable.
Does microwave energy pass through the viewing screen in the door?	No. The metal screen bounces the energy back to the oven cavity. The holes (or ports) allow only light to pass through. They do not let microwave energy pass through.
Why does a tone sound when a pad on the control panel is touched?	The tone tells you that the setting has been entered.
Can my microwave oven be damaged if food is cooked for too long?	Like any other cooking appliance, it is possible to overcook food to the point that the food creates smoke, and even possibly fire and damage to the inside of the oven. It is always best to be near the oven while you are cooking.
When the oven is plugged into a wall outlet for the first time, it does not work properly. What is wrong?	The microcomputer controlling your oven may temporarily become scrambled and fail to function as programmed when you plug it in for the first time or when power resumes after a power interruption. Unplug the oven from the 120~ volt household outlet and then plug it back in to reset the microcomputer.
Why do I see light reflection around the outer case?	This light is from the oven light which is located between the oven cavity and the outer wall of the oven.
What are the various sounds I hear when the microwave oven is operating?	The clicking sound is caused by a mechanical switch turning the microwave oven's magnetron ON and OFF. The heavy hum and clunk is from the change in power the magnetron draws as it is turned ON and OFF by a mechanical switch. The change in blower speed is from the change in line voltage caused by the magnetron being turned ON and OFF.
Why does a fan sound for some time after toasting?	The fan blowing cools the toaster heater for about 1 minute after toasting. This is normal.
What does "HOT" code on the display mean?	If you operate toaster several times using one slot continuously, the toaster's internal temperature will be hot and may cause "Hot" to appear in the display. This will go away after several minutes after the toaster cools down. CAUTION: Do not operate toaster without bread.
What does "F-1" and "F-2" code on the display mean?	That means failure mode. Contact the nearest Authorized Service Center.

TROUBLESHOOTING

Questions and Answers (continued)

Food

Question	Answer
What is wrong when baked foods have a hard, dry, brown spot?	A hard, dry, brown spot indicates overcooking. Shorten the cooking or reheating time.
Why do eggs sometimes pop?	When baking, frying, or poaching eggs, the yolk may pop due to steam buildup inside the yolk membrane. To prevent this, simply pierce the yolk with a wooden toothpick before cooking. CAUTION: Never microwave eggs in the shell.
Why are scrambled eggs sometimes a little dry after cooking?	Eggs will dry out when they are overcooked, even if the same recipe is used each time. The cooking time may need to be varied for one of these reasons: <ul style="list-style-type: none"> • Eggs vary in size. • Eggs are at room temperature one time and at refrigerator temperature another time. • Eggs continue cooking during standing time.
Why do baked apples sometimes burst during cooking?	The peel has not been removed from the top half of each apple to allow for expansion of the interior of the apple during cooking. As in conventional cooking methods, the interior of the apple expands during the cooking process.
Why do baked potatoes sometimes burn during cooking?	If the cooking time is too long, fire could result. At the end of the recommended cooking time, potatoes should be slightly firm. CAUTION: Do not overcook.
Why is a standing time recommended after microwave cooking time is over?	Standing time allows foods to continue cooking evenly for a few minutes after the actual microwave oven cooking cycle ends. The amount of standing time depends upon the density of the foods.
Why is additional time required for cooking food stored in the refrigerator?	As in conventional cooking, the initial temperature of food affects total cooking time. You need more time to cook food taken out of a refrigerator than for food at room temperature.

TROUBLESHOOTING

BEFORE CALLING FOR SERVICE

You can often correct operating problems yourself. If your Toaster Cambo fails to work properly, locate the operating problem in the list below and try the solutions listed for each problem.

If the Toaster Cambo still does not work properly, contact the nearest Authorized Parts & Repair Center, which is fully equipped to handle your service requirements.

Problem	Possible Causes
Oven and Toaster does not start	<ul style="list-style-type: none"> • Is the power cord plugged in? • Is the door closed? • Are the cooking time or darkness control set?
Arcing or Sparking	<ul style="list-style-type: none"> • Are you using approved cookware? • Is the oven empty?
Incorrect time of day	<ul style="list-style-type: none"> • Have you tried to reset the time of day?
Unevenly Cooked Foods	<ul style="list-style-type: none"> • Are you using approved cookware? • Is the glass turntable in the oven? • Did you turn or stir the food while it was cooking? • Were the foods completely defrosted? • Was the time/cooking power level correct?
Overcooked Foods	<ul style="list-style-type: none"> • Was the time/cooking power level correct?
Undercooked Foods	<ul style="list-style-type: none"> • Are you using approved cookware? • Were the foods completely defrosted? • Was the time/cooking power level correct? • Are the ventilation ports clear?
Improper Defrosting	<ul style="list-style-type: none"> • Are you using approved cookware? • Was the time/cooking power level correct? • Did you turn the food over or stir during the defrosting cycle?
Toaster malfunctions or fails to operate.	<ul style="list-style-type: none"> • Is the machine plugged in? • Is the fuse in the circuit to the machine in working order? • If you have a circuit breaker box, be sure the circuit is closed. • Try unplugging and re-plugging.



LG MICROWAVE OVEN LIMITED WARRANTY – USA

Model LTRM1240SW/SB/ST

LG Electronics, Inc. will repair or replace your product, at LG's option, if it proves to be defective in material or workmanship under normal use, during the warranty period set forth below, effective from the date of original consumer purchase of the product. This warranty is good only to the original purchaser of the product and effective only when used in the United States, including U.S. Territories.

<u>WARRANTY PERIOD:</u>	<u>HOW SERVICE IS HANDLED:</u>
<p>LABOR: One Year from the Date of Purchase*.</p> <p>PARTS (except as listed below): One Year from the Date of Purchase*.</p> <p>MAGNETRON: Ten Years from the Date of Purchase*.</p> <p>Replacement Units and Repair Parts are warranted for the remaining portion of the original unit's warranty period.</p> <p>* Retain your Sales Receipt to prove the date of purchase. A copy of your Sales Receipt must be submitted at the time warranty service is provided.</p>	<p>Please call 1-800-243-0000 and choose the appropriate option. (Phones are answered 24 hours a day, 365 days per year.) Please have the product type (Microwave) and your ZIP code ready.</p> <p>Or visit our website at: http://us.lgservice.com</p>

THIS WARRANTY IS IN LIEU OF ANY OTHER WARRANTY, EXPRESS OR IMPLIED, INCLUDING WITHOUT LIMITATION, ANY WARRANTY OF MERCHANTABILITY OR FITNESS FOR A PARTICULAR PURPOSE. TO THE EXTENT ANY IMPLIED WARRANTY IS REQUIRED BY LAW, IT IS LIMITED IN DURATION TO THE EXPRESS WARRANTY PERIOD ABOVE. LG WILL NOT BE LIABLE FOR ANY INCIDENTAL, CONSEQUENTIAL, INDIRECT, SPECIAL, OR PUNITIVE DAMAGES OF ANY NATURE, INCLUDING WITHOUT LIMITATION, LOST REVENUES OR PROFITS, OR ANY OTHER DAMAGE WHETHER BASED IN CONTRACT, TORT, OR OTHERWISE. Some states do not allow the exclusion or limitation of incidental or consequential damages or limitations on how long an implied warranty lasts, so the above exclusion or limitation may not apply to you. This warranty gives you specific legal rights and you may also have other rights that vary from state to state.

THIS LIMITED WARRANTY DOES NOT APPLY TO:

- Service trips to your home to deliver, pick up, and/or install the product, instruct, or replace house fuses or correct wiring, or correction of unauthorized repairs.
- Damages or operating problems that result from misuse, abuse, operation outside environmental specifications or contrary to the requirements of precautions in the Operating Guide, accident, vermin, fire, flood, improper installation, acts of God, unauthorized modification or alteration, incorrect electrical current or voltage, or commercial use, or use for other than intended purpose.

The cost of repair or replacement under these excluded circumstances shall be borne by the consumer.

CUSTOMER INTERACTIVE CENTER NUMBERS

To obtain Customer Assistance, Product Information, or Dealer or Authorized Service Center location:	Call 1-800-243-0000 (24 hours a day, 365 days per year) and select the appropriate option from the menu. Or visit our website at: http://us.lgservice.com
---	--

TO CONTACT LG ELECTRONICS BY MAIL:

LG Customer Interactive Center
P. O. Box 240007
201 James Record Road
Huntsville, Alabama 35824
ATTN: CIC



LG Electronics Inc.

P/NO.: 3828W5A8059

Printed in China