

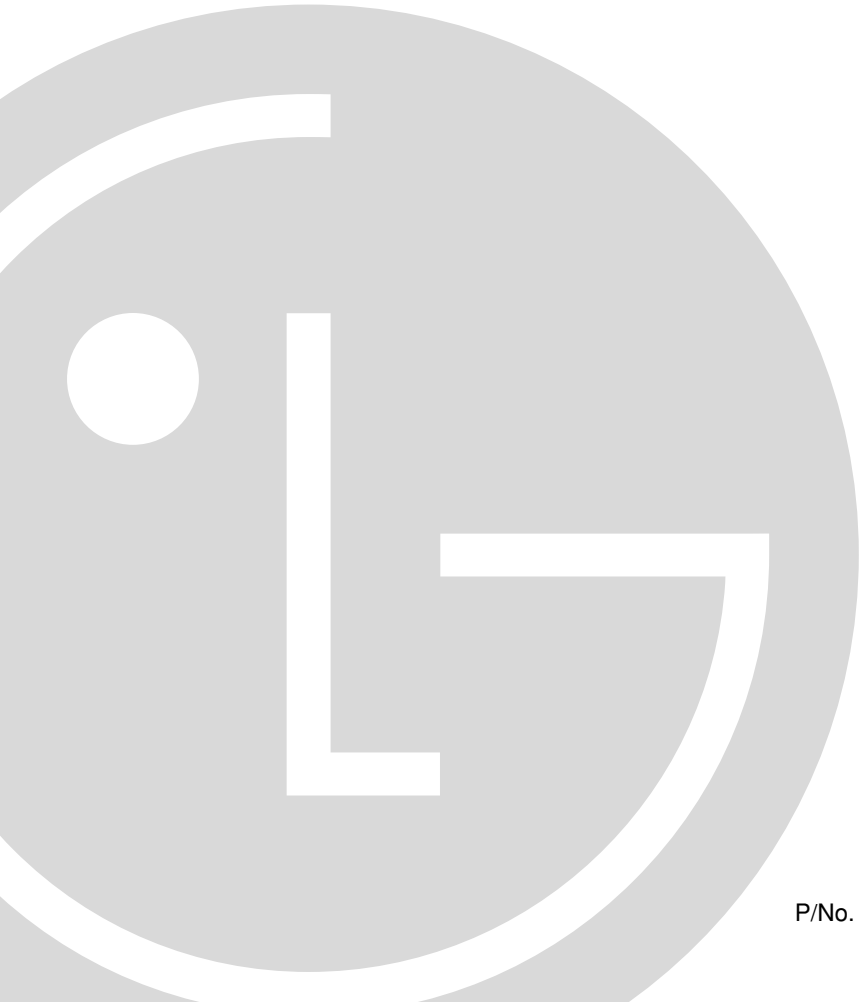

# **BOTTOM FREEZER REFRIGERATOR**

## **User's Guide**

Please read this guide thoroughly before operating and keep it handy for reference at all times.



## TABLE OF CONTENTS

<b>Safety Instructions</b>	<b>3–9</b>	Dairy Bin	24
<b>Parts and Features</b>	<b>10</b>	Utility Bin	24
<b>Refrigerator Installation</b>	<b>11–18</b>	<b>► Freezer section</b>	
Unpacking Your Refrigerator	11	Ice Bin	24
Installation	11	Tilt-Out Door Basket	25
Base Cover	11	Durabase	25
Removing and Replacing Your Refrigerator Handles and Doors	12–17	Durabase Divider	25
Leveling and Door Alignment	18	Pull out Drawer	25
<b>Using Your Refrigerator</b>	<b>19–25</b>	<b>Care and Cleaning</b>	<b>26–27</b>
Ensuring Proper Air Circulation	19	General Cleaning Tips	26
Multi-Flow	19	Outside	26
Setting the Controls	19	Inside Walls	26
Adjusting Control Settings	20	Door Liner and Gaskets	26
Food Storage Guide	20	Plastic Parts	26
Storing Frozen Food	21	Condenser Coils	26
<b>► Refrigerator section</b>		Light Bulb Replacement	26–27
Refrigerator Shelves	22	Power Interruptions	27
Bottle Holder	22	When you go on vacation	27
Crisper Humidity Control	23	When you move	27
Removing Crisper	23	<b>About the Automatic Icemaker</b>	<b>28</b>
Glide ‘N’ Serve	23	<b>Connecting the Water Line</b>	<b>29–31</b>
Modular Door Bin	24	<b>Troubleshooting Guide</b>	<b>32–35</b>

# SAFETY MESSAGES

## BASIC SAFETY PRECAUTIONS

This guide contains many important safety messages. Always **read and obey** all safety messages.



This is the safety alert symbol. It alerts you to safety messages that inform you of hazards that can kill or hurt you or others, or cause damage to the product.

All safety messages will be preceded by the safety alert symbol and the hazard signal word DANGER, WARNING, CAUTION. These words mean:

### DANGER

You **will** be killed or seriously injured if you don't follow instructions.

### WARNING

You **can** be killed or seriously injured if you don't follow instructions.

### CAUTION

Indicates an imminently hazardous situation which, if not avoided, **may** result in minor or moderate injury, or product damage only.

All safety messages will identify the hazard, tell you how to reduce the chance of injury, and tell you what can happen if the instructions are not followed.

## DANGER: RISK OF CHILD ENTRAPMENT

Child entrapment and suffocation are not problems of the past. Junked or abandoned refrigerators are still dangerous...even if they will sit for *just a few days*. If you are getting rid of your old refrigerator, please follow the instructions at right to help prevent accidents.

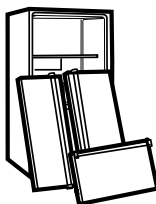

### BEFORE YOU THROW AWAY YOUR OLD REFRIGERATOR OR FREEZER

- Take off the doors.
- Leave the shelves in place so that children may not easily climb inside.

## CFC DISPOSAL

Your old refrigerator may have a cooling system that used CFCs (chlorofluorocarbons). CFCs are believed to harm stratospheric ozone.

If you are throwing away your old refrigerator, make sure the CFC refrigerant is removed for proper disposal by a qualified servicer. If you intentionally release this CFC refrigerant, you can be subject to fines and imprisonment under provisions of environmental legislation.

## GROUNDING REQUIREMENTS

**IMPORTANT:** Please read carefully.  
**TO CONNECT ELECTRICITY**

### **WARNING**

#### **Electrical Shock Hazard**

**FOR PERSONAL SAFETY,** this appliance must be properly grounded. Have the wall outlet and the circuit checked by a qualified electrician to make sure the outlet is properly grounded.

### **RECOMMENDED GROUNDING METHOD**

The refrigerator should always be plugged into its own individual properly grounded electrical outlet rated for 230 Volts, 50 Hz, AC only, and fused at 15 or 20 amperes.

This provides the best performance and also prevents overloading house wiring circuits which could cause a fire hazard from overheated wires. It is recommended that a separate circuit serving only this appliance be provided.

Use a receptacle which cannot be turned off with a switch or pull chain. Do not use an extension cord.

Where a standard two-prong wall outlet is encountered, it is your personal responsibility and obligation to have it replaced with a properly grounded three-prong wall outlet.

**Do not, under any circumstances, cut or remove the third (ground) prong from the power cord.**

**NOTE:** Before performing any type of installation, cleaning, or removing a light bulb, turn the control (Thermostat, Refrigerator Control or Freezer Control, depending on the model) to OFF and then disconnect the refrigerator from the electrical source. When you are finished, reconnect the refrigerator to the electrical source and reset the control (Thermostat, Refrigerator Control or Freezer Control, depending on the model) to the desired setting.

### **WARNING**

- Repair or replace immediately all electric service cords that have become frayed or otherwise damaged. Do not use a cord that shows cracks or abrasion damage along its length or at either the plug or connector end.
- When moving your refrigerator away from the wall, be careful not to roll over or damage the power cord.
- Keep fingers out of *pinch point areas*; clearances between the doors and cabinet are necessarily small. Be careful closing doors when children are in the area.
- This refrigerator must be properly installed in accordance with the **Attention Installer Instructions** that were taped to the front of the refrigerator.
- Don't touch the lamp, in case of light on the long time, Because it can be very hot.
- DO NOT refreeze frozen foods which have thawed completely. The United States Department of Agriculture in Home and Garden Bulletin No. 69 says:  
...You may safely refreeze frozen foods that have thawed if they still contain ice crystals or if they are still cold—below 4°C.  
...Thawed ground meats, poultry or fish that have any off-odor or off-color should not be refrozen and should not be eaten. Thawed ice cream should be discarded. If the odor or color of any food is poor or questionable, get rid of it.  
The food may be dangerous to eat.  
Even partial thawing and refreezing reduces the eating quality of foods, particularly fruits, vegetables and prepared foods. The eating quality of red meats is affected less than that of many other foods. Use refrozen foods as soon as possible to save as much of their quality as you can.

## SAVE THESE INSTRUCTIONS

# IMPORTANT SAFETY INSTRUCTIONS

## Don't use an extension cord

If possible, connect the refrigerator to its own individual electrical outlet to prevent it and other appliances or household lights from causing an overload that could cause a power outage.

## Accessibility of Supply Plug

The refrigerator-freezer should be so positioned that the supply plug is accessible for quick disconnection when accident happens.

## Supply Cord Replacement

If the supply cord is damaged, it must be replaced by the manufacturer or its service agent or a similarly qualified person in order to avoid a hazard.

## FEED WATER PIPE INSTALLATION

### Before installation

- Automatic ice maker can be installed only by manufacturer.
- Automatic ice maker operation needs water pressure of 147~834 kPa (1.5~8.5 kgf/cm<sup>2</sup>) (That is, an instant paper cup (180 cc) will be fully filled within 3 sec.).

- If water pressure does not reach the rating 147 kPa (1.5 kgf/cm<sup>2</sup>) or below, it is necessary to purchase a separate pressure pump for normal automatic icing and cool water feed.
- Keep the total length of the feed water pipe tube within 8 m and be careful for the tube not be bent. If the tube is 8 m or longer it may cause trouble in water feed owing to the drain water pressure.
- Install the feed water pipe tube at a place free from heat.

### ▲ WARNING

- Connect to potable water supply only.
- Refer to instructions with water filter kit for installation.

### ▲ WARNING

- The refrigerant and insulation blowing gas used in the appliance require special disposal procedures. When disposal, please consult with service agent or a similarly qualified person.

## ▲ WARNING

To reduce the risk of fire, electric shock, or injury to persons when using your product, basic safety precautions should be followed, including the following. Read all instructions before using this appliance.

### 1. When connecting the power

#### The dedicated outlet should be used.

- Using several devices at one outlet may cause fire.
- The electric leakage breaker may damage food and the dispenser may be leaked.

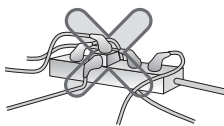

#### Do not allow the power plug to face upward or to be squeezed at the back of the refrigerator.

Water may be flown into or the plug may be damaged, which causes fire or electric shock.

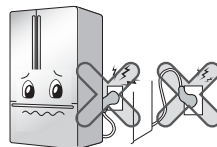

# ⚠ WARNING

To reduce the risk of fire, electric shock, or injury to persons when using your product, basic safety precautions should be followed, including the following. Read all instructions before using this appliance.

## 1. When connecting the power

**Do not allow the power cord bent or pressed by the heavy object to be damaged.**

It may damage the power cord to cause fire or electric shock.

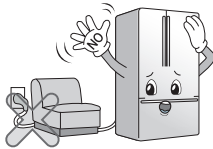

**Do not extend or modify the length of the power plug.**

It causes electric shock or fire by the electric damage of the power cord or others.

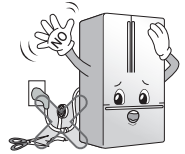

**Unplug the power plug when cleaning, handling or replacing the interior lamp of the refrigerator.**

- It may cause electric shock or injury.
- When replacing the interior lamp of the refrigerator, make sure that the rubber ring for preventing the electric spark within the socket is not taken off.

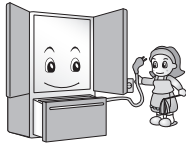

**Do not pull out the cord or touch the power plug with wet hands.**

- It may cause electric shock or injury.

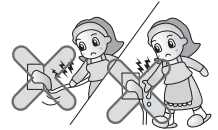

**Remove water or dust from the power plug and insert it with the ends of the pins securely connected.**

Dust, water or unstable connection may fire or electric shock.

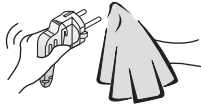

**Make sure of grounding.**

The incorrect grounding may cause breakdown and electric shock.

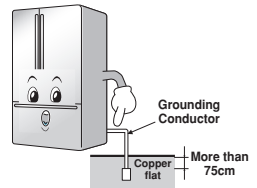

**When the power cord or the power plug is damaged or the holes of the outlet are loosed, do not use them.**

It may cause electric shock or short circuit to make fire.

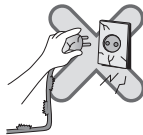

# IMPORTANT SAFETY INSTRUCTIONS

## 2. When using the refrigerator

**Do not place the heavy object or the dangerous object (container with liquid) on the refrigerator.**

It may be dropped to cause injury, fire or electric shock when opening or closing the door.



**Do not install the refrigerator in the wet place or the place which water or rain splashes.**

Deterioration of insulation of electric parts may cause electric leakage.



**Do not cling to the door or the shelves of the door or the home bar of the freezer or the cool chamber.**

It may make the refrigerator fallen down or damage the hands. Especially, do not allow the children to do the above.

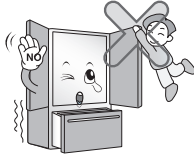

**Do not use or store inflammable materials ether, benzene, alcohol, medicine, LP gas, spray or cosmetics near or in the refrigerator.**

It may cause explosion or fire.

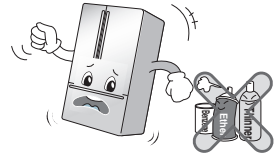

**Do not place the lit candle within the refrigerator to deodorize.**

It may cause explosion or fire.



**Do not insert the hands into the ice bucket or the ice dispenser.**

Operating the ice maker may cause injury.



**Do not store the medicine or the academic materials at the refrigerator.**

When the material with the strict temperature control is stored, it may be deteriorated or it may make an unexpected reaction to cause any risk.

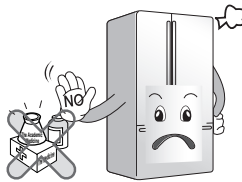

**Do not use the combustible spray near the refrigerator.**

It may cause fire.

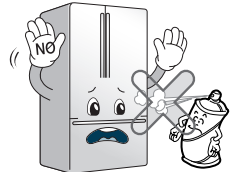

**Avoid the heating devices.**

It may cause fire.

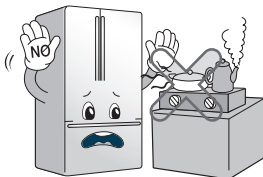

**Do not place flower vase, cup, cosmetics, medicine or any container with water on the refrigerator.**

It may cause fire, electric shock or injury by dropping down.

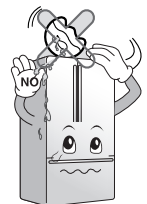

# IMPORTANT SAFETY INSTRUCTIONS

## 2. When using the refrigerator

**Use the submerged refrigerator after checking it.**

It may cause electric shock or fire.

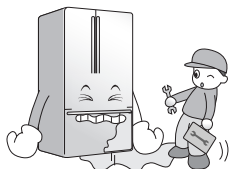

**When gas is leaked, do not touch the refrigerator or the outlet and ventilate the room immediately.**

- The explosion by spark may cause fire or burn.
- Because this refrigerator uses natural gas (isobutene, R600a) as the environment-friendly refrigerant, even a small amount (80~90g) is combustible. When the gas is leaked by the severe damage during delivering, installing or using the refrigerator, any spark may cause fire or burn.

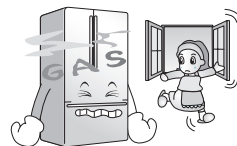

**Do not spray water at the outside or the inside of the refrigerator or do not clean it with benzene or thinner.**

Deterioration of insulation of electric parts may cause electric shock or fire.

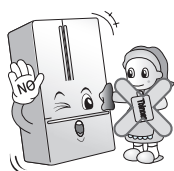

**When any strange smell or smoke is detected from the refrigerator, power plug get rid of electric outlet immediately and contact to the service center.**

It may cause fire.

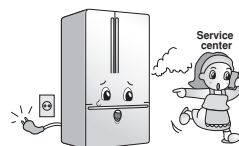

**Do not allow any person except the qualified engineer to disassemble, repair or alter the refrigerator.**

It may cause injury, electric shock or fire.

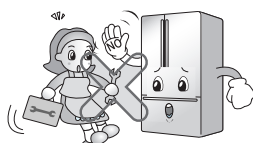

**Do not use the refrigerator for non-domestic purpose (storing medicine or testing material, using at the ship, etc.).**

It may cause an unexpected risk such as fire, electric shock, deterioration of stored material or chemical reaction.

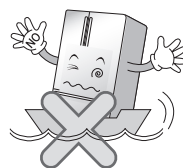

**When disposing the refrigerator, remove the packing materials from the door.**

It may cause to lock out the child.

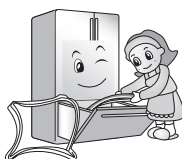

**Install the refrigerator on the solid and level floor.**

Installing it on the unstable place may cause death by falling down the refrigerator when opening or closing the door.

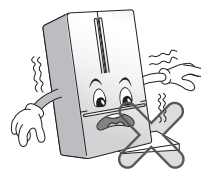

**Do not insert the hands or the metal stick into the exit of cool air, the cover, the bottom of the refrigerator, the heatproof grill (exhaust hole) at the backside.**

It may cause electric shock or injury.

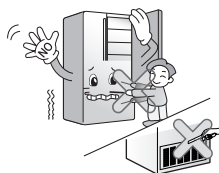

**When you want to dispose the refrigerator, contact to the down-block office.**

When you want to dispose the large living waste such as electric home appliance and furniture, you'd better contact the local down-block office.

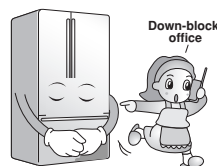



# ⚠ CAUTION

Violating this direction may cause injury or damage house or furniture. Always be careful, please.

**Do not touch food or containers at the freezer with wet hands.**

It may cause frostbite.



**Do not put ice in thin crystal cup or ceramic ware.**

It may break cup or ceramic ware to cause injury.

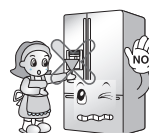

**Wait for 5 minutes or longer when reconnecting the plug.**

It may cause the operation of the freezer to fail.

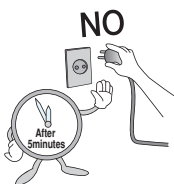

**Supply the automatic ice maker with drinkable water only (only for the model with the dispenser).**

Otherwise, it may cause any risk.

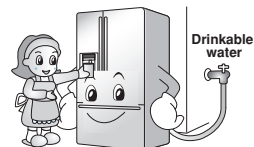

**Pull out the power plug not by grasping the cord but the plug of its end.**

It may cause electric shock or short circuit to fire.



**Do not put bottle in the freezer.**

It may freeze the contents to break the bottle to cause injury.



**Do not insert the hands into the bottom of the refrigerator.**

The iron plate of the bottom may cause injury.



**Do not install the refrigerator in the wet place or the place which water or rain splashes.**

Deterioration of insulation of electric parts may cause electric leakage.

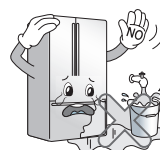

**Because opening or closing the door of the refrigerator may cause injury to the person around it, be careful, please.**

Opening or closing the door may cause feet or hands to be caught in the chink in door or the child to be get hurt by the corner.

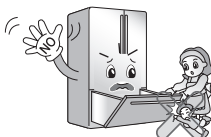

**Carry the refrigerator with the handle bar at the bottom of the front and the top of the rear.**

Otherwise, your hands may be slipped to cause injury.

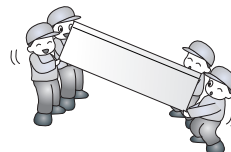

**Do not put any living animal in the refrigerator.**

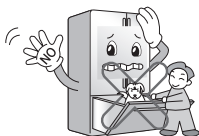

## PARTS AND FEATURES

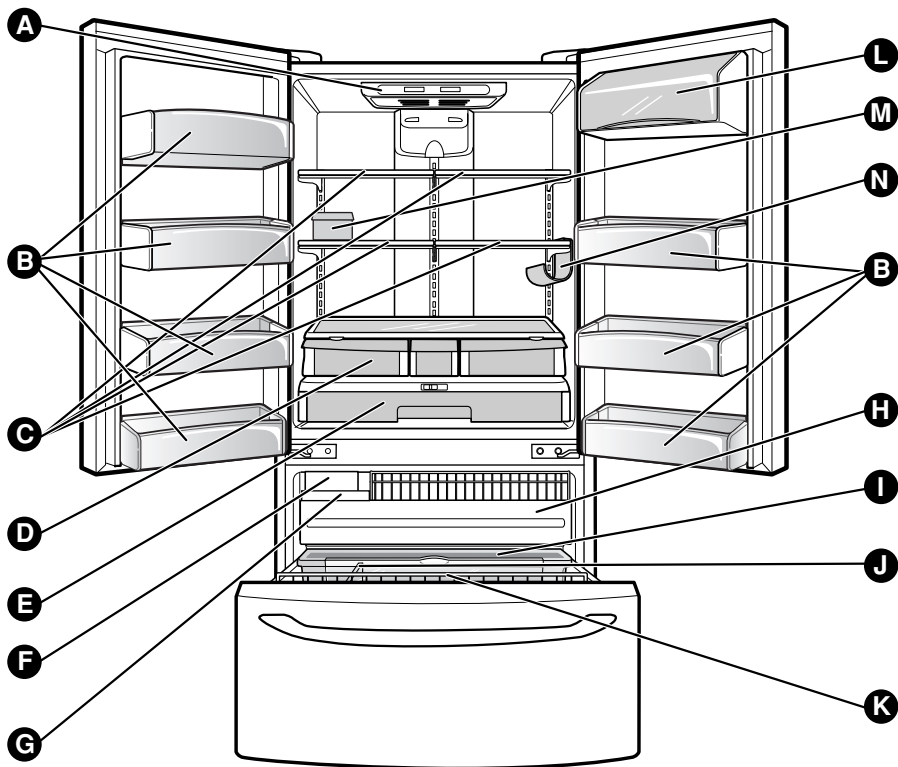

Use this page to become more familiar with the parts and features. Page references are included for your convenience.

**NOTE: This guide covers several different models. The refrigerator you have purchased may have some or all of the items listed below. The locations of the features shown below may not match your model.**

- A** Digital Sensor Control
- B** Modular Door Bins (p.24)
- C** Shelves (p.22)
- D** Crisper (p.23)  
(Keeps fruits and vegetable fresh and crisper)
- E** Glide 'N'Serve (p.23)
- F** Customcube Icemaker
- G** Ice Bin (p.24)
- H** Pull out Drawer (p.25)
- I** Durabase (p.25)
- J** Divider (p.25)
- K** Tilt-Out Door Basket (p.25)
- L** Dairy Bin (p.24)
- M** Utility Bin (p.24)
- N** Bottle Holder (p.22)

# REFRIGERATOR INSTALLATION

## ⚠ WARNING

### Excessive Weight Hazard

Use two or more people to move and install refrigerator.

Failure to do so can result in back or other injury.

## UNPACKING YOUR REFRIGERATOR

Remove tape and any temporary labels from your refrigerator before using. Do not remove any warning-type labels, the model and serial number label, or the TechSheet that is attached to back wall of the refrigerator.

To remove any remaining tape or glue, rub the area briskly with your thumb. Tape or glue residue can also be easily removed by rubbing a small amount of liquid dish soap over the adhesive with your fingers. Wipe with warm water and dry.

Do not use sharp instruments, rubbing alcohol, flammable fluids or abrasive cleaners to remove tape or glue. These products can damage the surface of your refrigerator. For more information, see the **Important Safety Instructions** section.

Refrigerator shelves are installed in the shipping position.

Please reinstall shelves according to your individual storage needs.

## ⚠ WARNING

### When Moving Your Refrigerator:

Your refrigerator is heavy. When moving the refrigerator for cleaning or service, be sure to protect the floor. Always pull the refrigerator straight out when moving it. Do not wiggle or walk the refrigerator when trying to move it, as floor damage could occur.

## ⚠ WARNING

### Explosion Hazard



Keep flammable materials and vapors, such as gasoline, away from refrigerator.

Failure to do so can result in death, explosion or fire.

- To reduce the risk of electric shock, do not install the refrigerator in a wet or damp area.
- Select a place where a water supply can be easily connected for the automatic icemaker.

▲ **CAUTION:** Avoid placing the unit near heat sources, direct sunlight or moisture.

## INSTALLATION

- To minimize noise and vibration, the refrigerator **MUST** be installed on a solidly constructed floor.
  - Carpeting and soft tile surfaces are not recommended.
  - Never install the refrigerator on a platform or weakly supported structure.
1. To avoid vibration, the unit must be level. If required, adjust the leveling screws to compensate for unevenness of the floor. The front should be slightly higher than the rear to aid in door closing. Leveling screws can be turned easily by tipping the cabinet slightly. Turn the leveling screws clockwise (  ) to raise the unit, counterclockwise (  ) to lower it.
  2. Install this appliance in an area where the temperature is between 13°C and 43°C. If the temperature around the appliance is too low or high, cooling ability may be adversely affected.
  3. Too small a distance from adjacent items may result in lowered freezing capability and increased electricity consumption charges. Allow at least 24 in. (61 cm) in front of the refrigerator to open the doors.

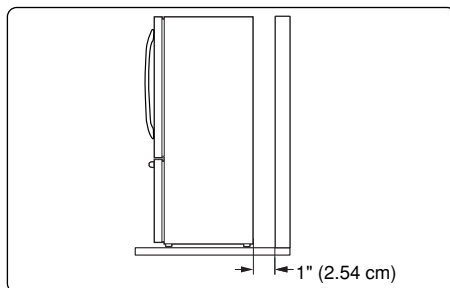

## NEXT

1. Clean your refrigerator thoroughly and wipe off all dust accumulated during shipping.
2. Install accessories such as ice cube bin, drawers, shelves, etc., in their proper places. They are packed together to prevent possible damage during shipment.
3. Let your refrigerator run for at least 2 or 3 hours before putting food in it. Check the flow of cold air in the freezer compartment to ensure proper cooling. Your refrigerator is now ready for use.

## BASE COVER

### To remove the base cover

1. Open the Freezer Drawer. (Drawer not shown for clarity.)
2. Once drawer is open there is sufficient clearance to remove screws on top of cover.

### To replace base cover:

- Place cover into position and insert and tighten screws.

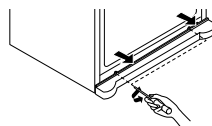

# REFRIGERATOR INSTALLATION

## HOW TO REMOVE DOOR HANDLES

To move refrigerator through a house door, it may be necessary to remove refrigerator and freezer door handles.

**NOTE:** Handle appearance may vary from illustrations on this page.

### 1. Removing Refrigerator Handle

- Loosen the set screws with the 3/32" Allen wrench and remove the handle.

**NOTE:** If the handle mounting fasteners need to be tightened or removed, use a 1/4" Allen wrench.

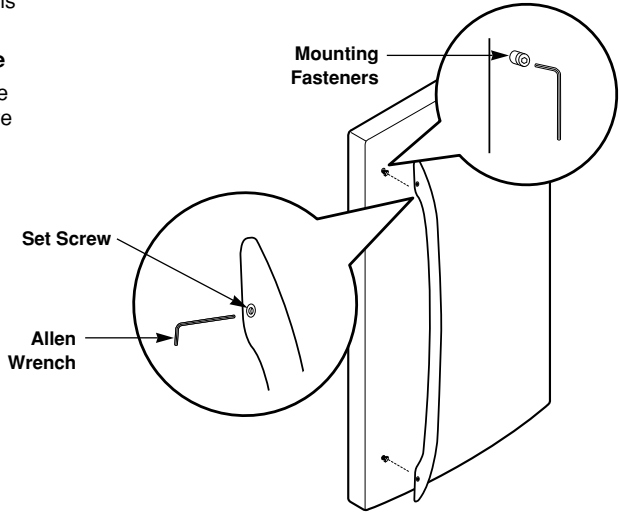

### 2. Removing Freezer Drawer Handle

- Loosen the set screws located on the lower side of the handle with the 3/32" Allen wrench and remove the handle.

**NOTE:** If the handle mounting fasteners need to be tightened or removed, use a 1/4" Allen wrench.

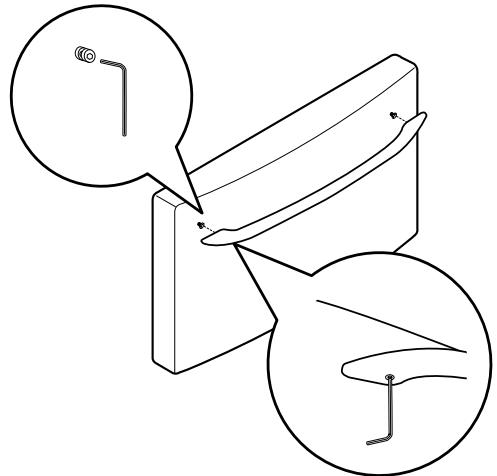

# REFRIGERATOR INSTALLATION

## HOW TO REPLACE DOOR HANDLES

**NOTE:** Handle appearance may vary from illustrations on this page.

### 1. Replacing Refrigerator Door Handle

- Place the handle on the door by adjusting handle footprints to fit mounting fasteners and tighten the set screws with the 3/32" Allen wrench.

**NOTE:** If the handle mounting fasteners need to be tightened or removed use a 1/4" Allen wrench.

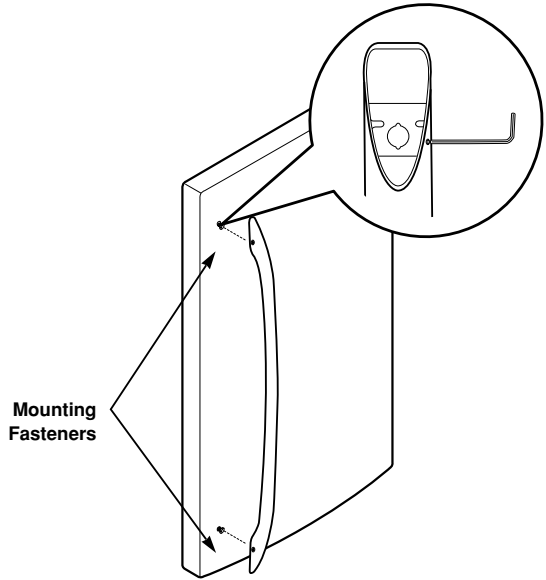

### 2. Replacing Freezer Drawer Handle

- Place the handle on the door by adjusting handle footprints to fit mounting fasteners and tighten the set screws on the bottom of the handle with a 3/32" Allen wrench.

**NOTE:** If the handle mounting fasteners need to be tightened or removed use a 1/4" Allen wrench.

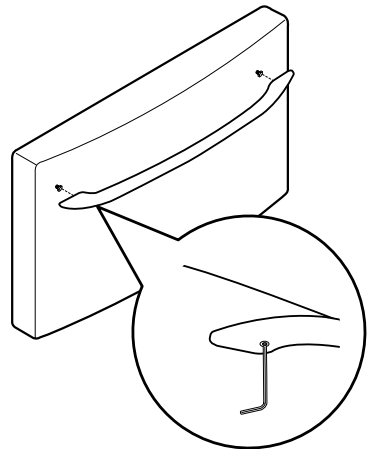

# REFRIGERATOR INSTALLATION

## HOW TO REMOVE REFRIGERATOR DOOR

### 1. Removing Refrigerator Door

**NOTE:** Handle appearance may vary.

**IMPORTANT:** Before you begin, turn the refrigerator OFF and unplug it. Remove food and any bins from doors.

#### ► Left Door

- Loosen the cover screw (1).
- Disconnect wire harness (2).
- Remove the ground screw (3).
- Rotate the lever hinge (4) counter clockwise and lift off the top hinge (5).
- Raising it up enough to clear the middle hinge pins.
- Place the door on a non-scratching surface with the inside up.

#### ► Right Door

- Remove the right door followed by the same way described above.
- Rotate the lever hinge (4) clockwise at this time, removing the top hinge (5).

**▲ CAUTION:** When removing top hinge, be careful that the door does not fall forward.

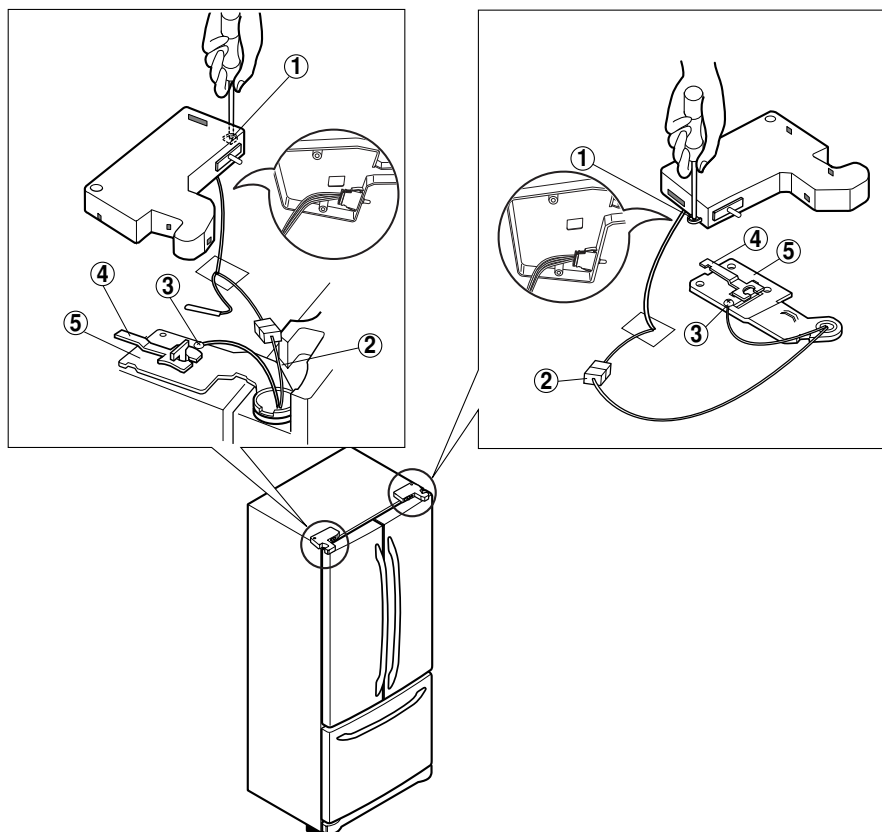

# REFRIGERATOR INSTALLATION

## 2. Replacing Refrigerator Door

### ► Right Door

- Lower the door onto the middle hinge pin (6).
- Make sure the door is aligned with the cabinet.
- Replace the top hinge (5) by rotating the lever hinge (4) counter clockwise to secure it.
- Make sure the gasket on the door is flush against the cabinet and is not folded.
- Support the door on the handle side while securing. And make sure the door is straight and the gap between the doors is even across the front.
- Install the ground screw (3) and connect the wire harness (2).
- Tighten the cover screw (1).

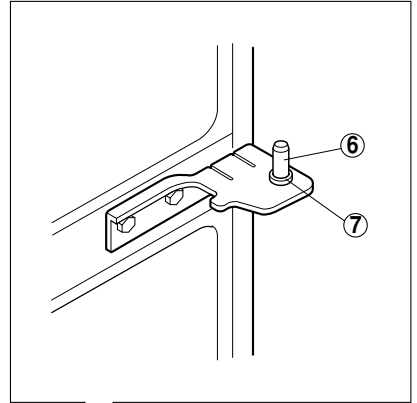
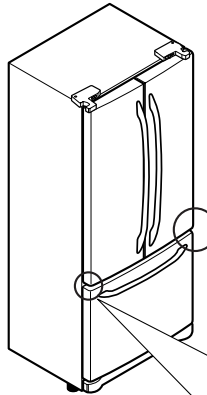

### ► Left Door

- Replace the left door followed by the same way described above.
- When replacing the top hinge (5), rotate the lever hinge (4) clockwise at this time.

▲ **CAUTION:** Be careful of missing the washer [part(7)]. Because it can be easily taken off.

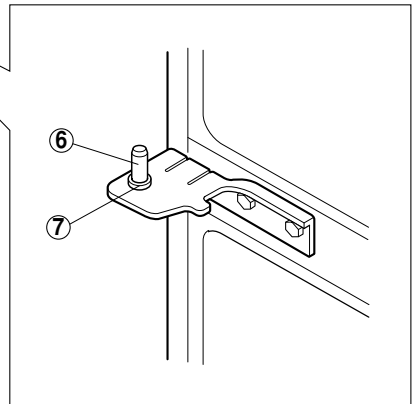

# REFRIGERATOR INSTALLATION

## HOW TO REMOVE AND INSTALL THE PULLOUT DRAWER

**IMPORTANT:** To avoid possible injury or product or property damage, you will need two people to perform the following instructions.

### 1. Removing Pullout Drawer

- Pull the drawer open to full extension. Remove the lower basket (1) by lifting basket from rail system. (If you tilt the door, it will be easier.)

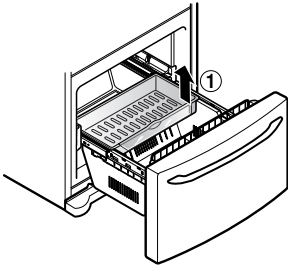

- Press both hangers with your thumbs to lift it up.
- Separate the left and right rail cover.

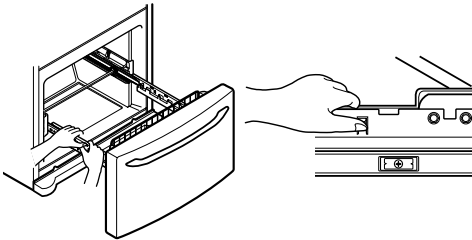

- Remove the screws (2) of the rail on both sides.

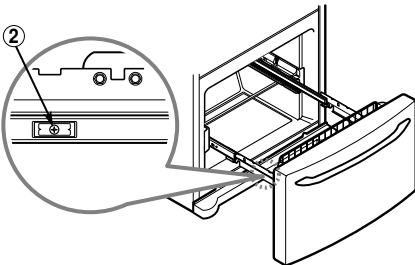

- With both hands, hold both sides of the door and pull it up to separate it from the rails.

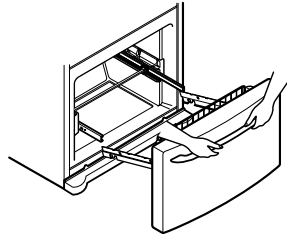
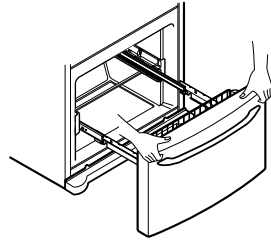

- With both hands, hold the center bar and push it in to let both rails fitted simultaneously.

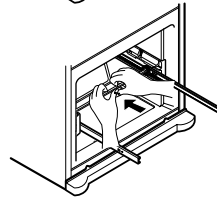
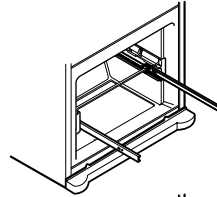

**▲ CAUTION:** When you remove the drawer, do not hold the handle. If it may come off and it could cause personal injury.

**▲ CAUTION:** When laying the drawer down, be careful not to damage the floor or hurt your feet by the sharp edges on hinge side.



# REFRIGERATOR INSTALLATION

## HOW TO REMOVE AND INSTALL THE PULLOUT DRAWER

**IMPORTANT:** To avoid possible injury or product or property damage, you will need two people to perform the following instructions.

### 2. Installing Pullout Drawer

- With both hands, hold the center bar and push it out to let both rails out to full extension simultaneously.

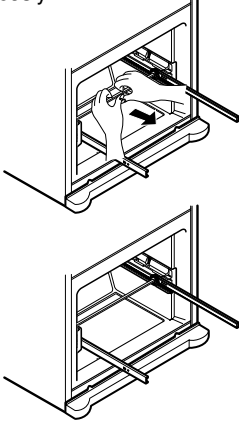

- Hook door supports (1) into rail tabs (2).

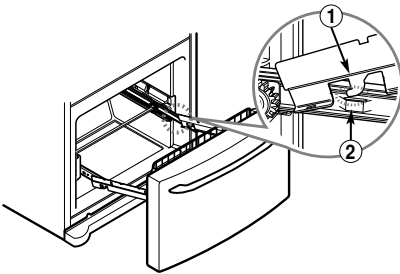

- Lower door into final position and tighten the screws (3).

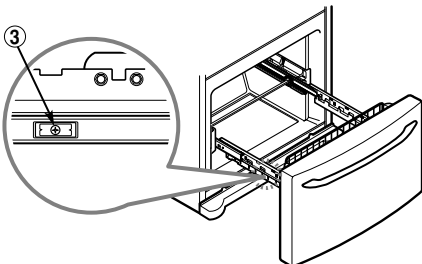

- Make sure you have a right rail cover for each side.

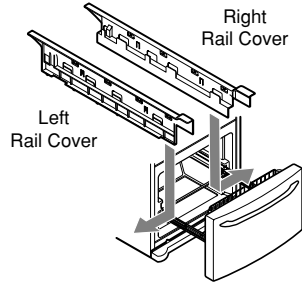

- Align the top holes of the rail cover with the top holes of the door supports to assemble the rail covers.

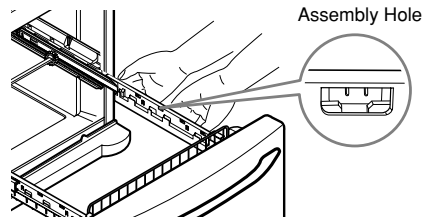
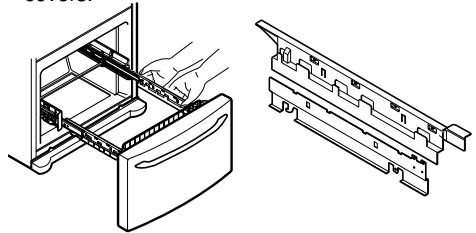

- With the drawer pulled out to full extension, insert the lower basket (4) in the rail assembly.

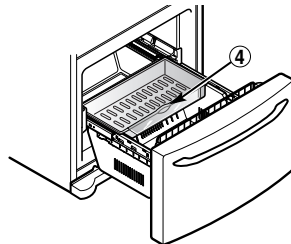

**▲ WARNING:** To prevent accidental child and pet entrapment or suffocation risk. DO NOT allow them to play inside of drawer.

**▲ WARNING:** DO NOT step or sit down on freezer door.

# REFRIGERATOR INSTALLATION

## LEVELING AND DOOR ALIGNMENT

### Leveling

After installing, secure the product with the LEG not to move left or right.

Your refrigerator has two front leveling screws—one on the right and one on the left. If your refrigerator seems unsteady or you want the doors to close easier, adjust the refrigerator's tilt using the instructions below:

1. Plug the refrigerator's power cord into a 3-prong grounded outlet. Move the refrigerator into its final position.
2. Turn the leveling leg clockwise to raise that side of the refrigerator or counterclockwise to lower it. It may take several turns of the leveling leg to adjust the tilt of the refrigerator. **NOTE:** Having someone push against the top of the refrigerator takes some weight off the leveling legs. This makes it easier to adjust the legs.

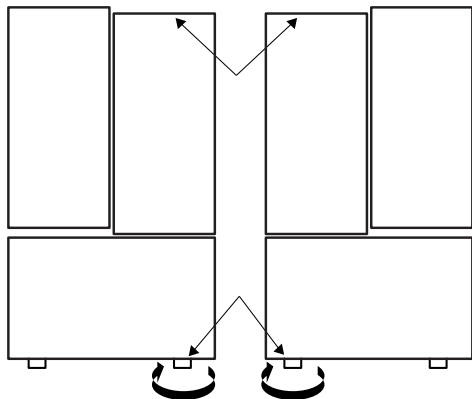

3. Open both doors again and check to make sure that they close easily. If not, tilt the refrigerator slightly more to the rear by turning both leveling screws clockwise. It may take several more turns, and you should turn both leveling screws the same amount.
4. Re-adjust if necessary.
5. Replace the base cover.

**NOTE:** Your new refrigerator is uniquely designed with two fresh food doors. Either door can be opened or closed independently of one another. You may have to exert slight pressure on doors to get them to close completely.

### Door Alignment

If the space between your doors is uneven, follow the instructions below to align the doors:

1. With one hand, lift up the door you want to raise at middle hinge.
2. With other hand, use pliers to insert snap ring as shown.
3. Insert additional snap rings until the doors are aligned. (Three snap rings are provided with unit.)

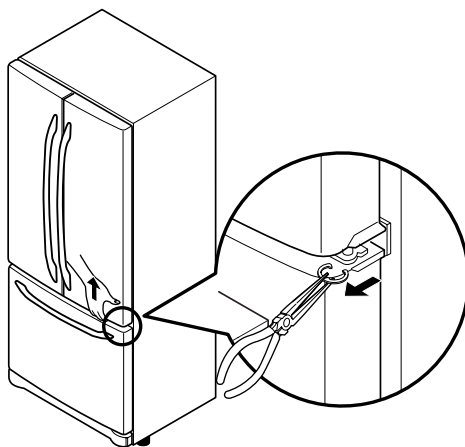

# USING YOUR REFRIGERATOR

## ENSURING PROPER AIR CIRCULATION

In order to ensure proper temperatures, air must flow between the refrigerator and freezer sections. As shown in the illustration below, air enters at top of freezer and circulates down. From bottom of freezer, air is forced up to top of refrigerator. Air enters refrigerator through top vent, then circulates and exists at bottom, where it returns to freezer.

## MULTI-FLOW

- Multi-Flow means powerful and effective cooling operation. This is especially noticeable when new food is placed in the refrigerator compartment.
- If water or foreign substances enter the cool air vent while cleaning, efficiency will be lowered. In addition, if gasket is damaged, efficiency may be lowered because of escaping cool air.

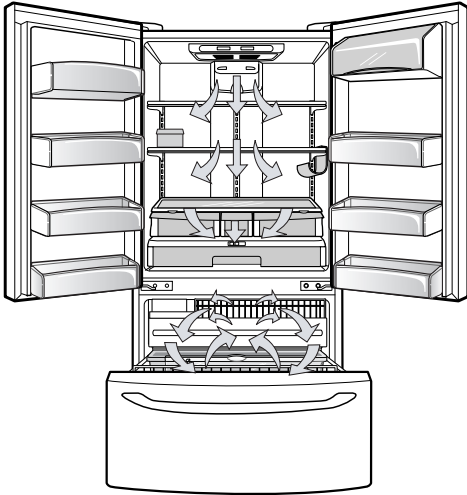

**Do not block any of cool air vents** with food packages. If the vents are blocked, airflow will be interrupted and temperature and moisture problems may occur.

**IMPORTANT:** Because air circulates between both sections, any odors formed in one section will transfer to the other. You must thoroughly clean both sections to eliminate odors. To prevent odor transfer and drying out of food, wrap or cover foods tightly. (See the Food Storage Guide section for details.)

## SETTING THE CONTROLS

- Your refrigerator has two controls that let you regulate the temperature in the freezer and refrigerator compartments.
- Initially set the REFRIGERATOR CONTROL at 3°C and the FREEZER CONTROL at -18°C. Leave it at this setting for 24 hours (one day) to stabilize. Then adjust the compartment temperature as desired.
- **Refrigerator control: 0°C to 8°C**  
The lower the number setting, the colder the refrigerator compartment will become.



- **Freezer control: -21°C to -13°C**  
When the setting is at a lower number, the freezer compartment becomes colder. But the refrigerator compartment becomes warmer because less cold air flows into the refrigerator.
- **ICE PLUS:**  
Press the ICE PLUS key and the LED will turn on. This function will remain activated for 24 hours and intensify the cooling speed of freezer and increase the amount of ice.

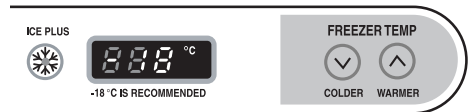

# USING YOUR REFRIGERATOR

## ADJUSTING CONTROL SETTINGS

Give the refrigerator time to cool down completely before making final adjustments. It is best to wait 24 hours before doing this. The mid-settings indicated in the previous section should be correct for normal household refrigerator usage. The controls are set correctly when milk or juice is as cold as you like and when ice cream is firm.

The refrigerator control functions as the thermostat for the entire appliance (refrigerator and freezer sections). The higher the number setting, the longer the compressor will run to keep the temperature colder. The freezer control adjusts the cold air flow from the freezer to the refrigerator. Setting the freezer control to a lower temperature keeps more cold air in the Freezer compartment to make it colder.

If you need to adjust temperatures in the refrigerator or freezer, start by adjusting the refrigerator. Then wait 24 hours before checking the freezer temperature. If it is too warm or too cold, then adjust the freezer control.

Use the settings listed in the chart below as a guide. **Always remember to wait at least 24 hours between adjustments.**

CONDITION/ REASON:	RECOMMENDED ADJUSTMENT:
<ul style="list-style-type: none"> <li>■ REFRIGERATOR section too warm</li> <li>– Door opened often</li> <li>– Large amount of food added</li> <li>– Room temperature very warm</li> </ul>	Set REFRIGERATOR control to next lower number, wait 24 hours, then re-check
<ul style="list-style-type: none"> <li>■ FREEZER section too warm/ice not made fast enough</li> <li>– Door opened often</li> <li>– Large amount of food added</li> <li>– Very cold room temperature (can't cycle often enough)</li> <li>– Heavy ice usage</li> <li>– Air vents blocked by items</li> </ul>	Set FREEZER control to next lower number, wait 24 hours, then re-check  Move items out of airstream
<ul style="list-style-type: none"> <li>■ REFRIGERATOR section too cold</li> <li>– Controls not set correctly for your conditions</li> </ul>	Set REFRIGERATOR control to next higher number, wait 24 hours, then re-check
<ul style="list-style-type: none"> <li>■ FREEZER section too cold</li> <li>– Controls not set correctly for your conditions</li> </ul>	Set FREEZER control to next higher number, wait 24 hours, then re-check

## FOOD STORAGE GUIDE

Wrap or store food in the refrigerator in airtight and moisture-proof material unless otherwise noted. This prevents food odor and taste transfer throughout the refrigerator. For dated products, check date code to ensure freshness.

Items	How to
<b>Butter or margarine</b>	▶ Keep opened butter in a covered dish or closed compartment. When storing an extra supply, wrap in freezer packaging and freeze.
<b>Cheese</b>	▶ Store in the original wrapping until you are ready to use it. Once opened, rewrap tightly in plastic wrap or aluminum foil.
<b>Milk</b>	▶ Wipe milk cartons. For best storage, place milk on interior shelf, not on door shelf.
<b>Eggs</b>	▶ Store in original carton or Utility Bin on interior shelf, not on door shelf.
<b>Fruit</b>	▶ Wash, let dry, and store in refrigerator in plastic bags or in the crisper. Do not wash or hull berries until you are ready to use them. Sort and keep berries in their original container in a crisper, or store in a loosely closed paper bag on a refrigerator shelf.
<b>Leafy vegetables</b>	▶ Remove store wrapping and trim or tear off bruised and discolored areas. Wash in cold water and drain. Place in plastic bag or plastic container and store in crisper.
<b>Vegetables with skins (carrots, peppers)</b>	▶ Place in plastic bags or plastic container and store in crisper.
<b>Fish</b>	▶ Use fresh fish and shellfish the same day purchased.
<b>Leftovers</b>	▶ Cover leftovers with plastic wrap or aluminum foil. Plastic containers with tight lids can also be used.

# USING YOUR REFRIGERATOR

## STORING FROZEN FOOD

**NOTE:** For further information about preparing food for freezing or food storage times, check a freezer guide or a reliable cookbook.

### Packaging

Successful freezing depends on correct packaging. When you close and seal the package, it must not allow air or moisture in or out. If it does, you could have food odor and taste transfer throughout the refrigerator and also dry out frozen food.

### Packaging recommendations:

- Rigid plastic containers with tight-fitting lids
- Straight-sided canning/freezing jars
- Heavy-duty aluminum foil
- Plastic-coated paper
- Non-permeable plastic wraps
- Specified freezer-grade self-sealing plastic bags

Follow package or container instructions for proper freezing methods.

### Do not use:

- Bread wrappers
- Non-polyethylene plastic containers
- Containers without tight lids
- Wax paper or wax-coated freezer wrap
- Thin, semi-permeable wrap

**▲ CAUTION:** Do not keep beverage cans or plastic food containers in the freezer compartment. They may break if they freeze.

## Freezing

Your freezer will not quick-freeze any large quantity of food. Do not put more unfrozen food into the freezer than will freeze within 24 hours. Leave enough space in the freezer for air to circulate around packages. Be careful to leave enough room at the front so the door can close tightly.

Storage times will vary according to the quality and type of food, the type of packaging or wrap used (airtight and moisture-proof) and the storage temperature. Ice crystals inside a sealed package are normal. This simply means that moisture in the food and air inside the package have condensed, creating ice crystals.

**NOTE:** Allow hot foods to cool at room temperature for 30 minutes, then package and freeze. Cooling hot foods before freezing saves energy.

# USING YOUR REFRIGERATOR

## REFRIGERATOR SECTION

### REFRIGERATOR SHELVES

The shelves in your refrigerator are adjustable to meet your individual storage needs. Your model may have glass or wire shelves.

Storing similar food items together in your refrigerator and adjusting the shelves to fit different heights of items will make finding the exact item you want easier; it will also reduce the amount of time the refrigerator door is open, saving energy.

**IMPORTANT:** Do not clean glass shelves with warm water when they are cold. Shelves may break if exposed to sudden temperature changes or impact, such as bumping. For your protection, glass shelves are made with tempered glass, which will shatter into small pebble-sized pieces.

**NOTE:** Glass shelves are heavy. Use special care when removing them to avoid dropping them.

#### Adjusting Shelves

Remove shelves from the shipping position and replace shelves in the position you want.

- **To remove a shelf**—Tilt up the front of the shelf in the direction of (1) and lift it in the direction of (2). Pull the shelf out.

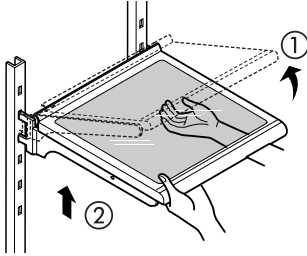

- **To reinstall a shelf**—Tilt the front of the shelf up and guide the shelf hooks into the slots at a desired height. Then lower the front of the shelf so that the hooks drop into the slots.

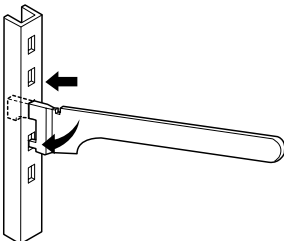

- ▲ **CAUTION :** Make sure that shelves are level from one side to the other. Failure to do so may result in the shelf falling or spilling food.

#### Sliding Out Shelves

You can slide glass shelves in and out of your refrigerator as follows.

- **To slide the shelf out**, carefully pull front of shelf toward you.
- **To slide shelf in**, push shelf in until it stops.

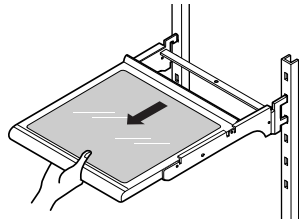

### BOTTLE HOLDER

Bottles can be stored laterally with this wine holder. It can be attached to any shelf.

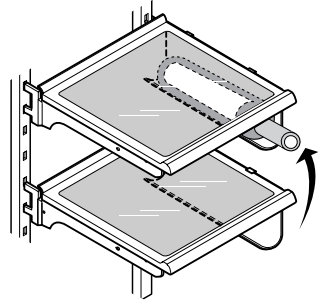

Wine holder can be removed by pulling it straight out and installed by placing it at the end of the shelf you want and pushing it inward.

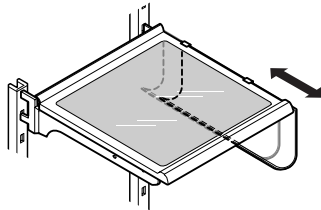

# USING YOUR REFRIGERATOR

## CRISPER HUMIDITY CONTROL

You can control the amount of humidity in the moisture-sealed crispers. Store vegetables or fruits requiring more or less humidity in separate crispers. Adjust the control to any setting between **HIGH** and **LOW**.

- **LOW** lets moist air out of the crisper for best storage of fruits.
- **HIGH** keeps moist air in the crisper for best storage of fresh, leafy vegetables.

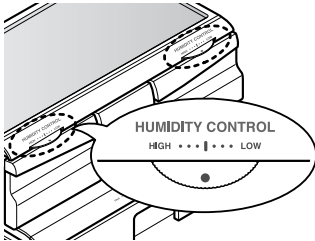

**▲ CAUTION :** The glass shelf over the crisper is not firmly secured. Be careful when tilting.

## REMOVING CRISPER

1. To remove, pull the drawer out to full extension.
2. Lift the front of the crisper up, then pull it straight out.
3. To install, slightly tilt up the front and insert the drawer into the frame and push it back into place.

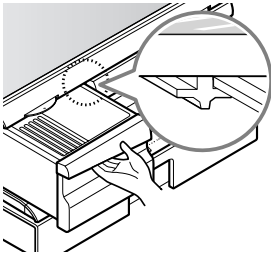

### To remove the glass

1. Lift up the glass under the crisper cover.
2. Pull the glass up and out.

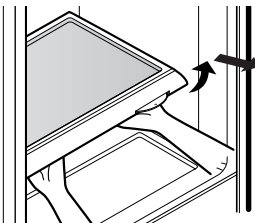

## GLIDE'N'SERVE

The **Glide'N'Serve** provides storage space with a variable temperature control that keeps the compartment colder than refrigerator.

This drawer can be used for large party trays, deli items, or beverages. (but this drawer can't be used for vegetable.)

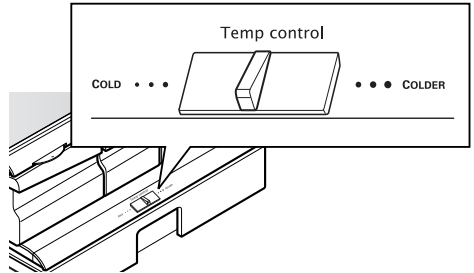

### Controls

The control regulates the air temperature in the drawer. Set control level to **COLD** (print on surface) to provide normal refrigerator temperature. Use the **COLDER** (print on surface) setting for meats or other deli items.

**NOTE:** Cold air directed to the **Glide'N'Serve** can decrease refrigerator temperature. Refrigerator control may need to be adjusted.

### To replace **Glide'N'Serve**

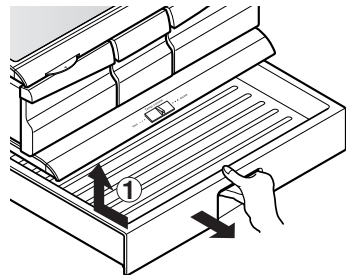

1. To remove, pull the drawer out to full extension.
2. Lift the front of the drawer up, then pull it straight out.
3. To install, slightly tilt up the front and insert the drawer into the frame and push it back into place.

# USING YOUR REFRIGERATOR

## MODULAR DOOR BIN

The door bins are removable for easy cleaning and adjusting.

1. To remove the bin, simply lift the bin up and pull straight out.
2. To replace the bin, slide it in above the desired support button and push down until it stops.

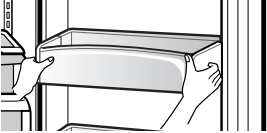

- ▲ **WARNING** : Somebody can be hurt if door bins are not firmly assembled.
- ▲ **NOTE** : DO NOT adjust a bin that is loaded with food.
- ▲ **CAUTION** : DO NOT allow children to play with baskets. Sharp corners on baskets could cause injury.

## DAIRY BIN

1. To remove the dairy bin, simply lift it and pull straight out.
2. To replace the dairy bin, slide it in above the desired location and push down until it stops.

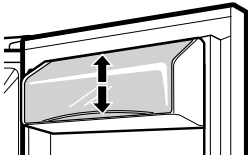

## UTILITY BIN

Store the utility bin on interior shelf, not on door shelf.

- ▲ **CAUTION** : Do not use the utility bin as an ice storage bin in the freezer compartment. The utility bin can easily break if it freezes.

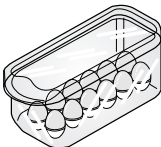

## FREEZER SECTION

### ICE BIN

1. To separate the ice bin, pull out the drawer as much as possible.
2. Gently lift and pull out the ice bin.
3. To install, pull out the drawer as much as possible and set the ice bin in its correct position, then push in the drawer.

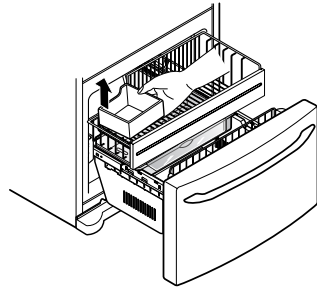
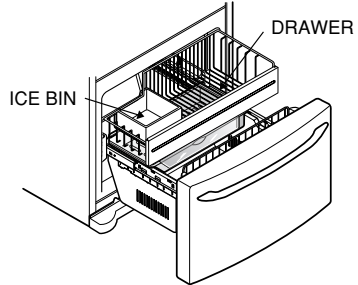



# USING YOUR REFRIGERATOR

## TILT-OUT DOOR BASKET

You can remove foods easily by tilting out the wire basket in the freezer compartment.

1. To remove, pull the bracket upward until you hear a clicking sound and remove the wire rack.
2. To replace, hook the end of the rack in the bracket, and push down until it locks into place.

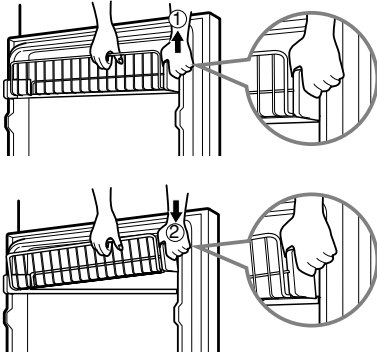

## DURABASE

1. To remove the Durabase, push it back to the end as much as possible. Tilt up the front of the Durabase and pull straight out.
2. To install, insert the Durabase in rail assembly.

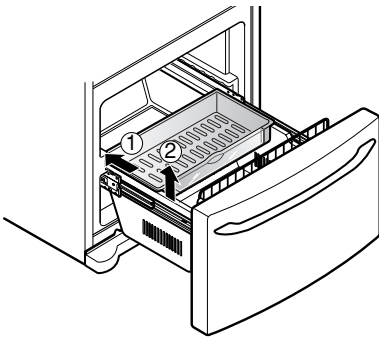

## DURABASE DIVIDER

The Durabase divider allows you to organize the Durabase area into sections.

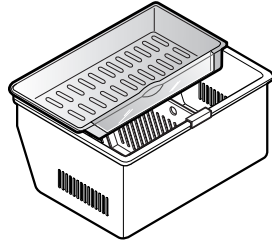

**▲ WARNING:** If the Durabase divider is removed, there is enough open space for children or pets to crawl inside. To prevent accidental child and pet entrapment or suffocation risk, DO NOT allow them to play inside of drawer.

## PULL OUT DRAWER

To separate the drawer, push the front left and right hooks in ① direction to pull up and remove.

Then gently lift the gear part of rear left and right side of the drawer and pull it out in ③ direction.

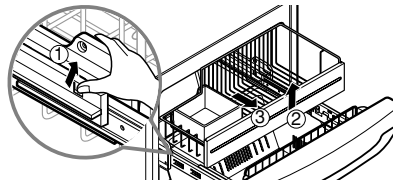

To install, reposition the gear part of rear left and right side of the drawer after pulling out both rails as much as possible, and gently push down both left and right side while checking the hook on the front part.

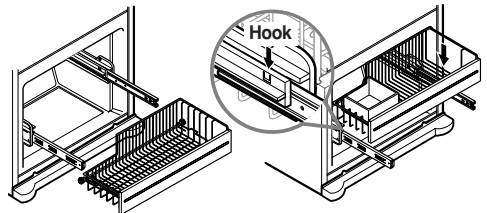

## CARE AND CLEANING

### **⚠ WARNING**



#### **Explosion Hazard**

Use non-flammable cleaner.

Failure to do so can result in death, explosion, or fire.

Both the refrigerator and freezer sections defrost automatically. However, clean both sections about once a month to prevent odors. Wipe up spills immediately.

### **GENERAL CLEANING TIPS**

- Unplug refrigerator or disconnect power.
- Remove all removable parts, such as shelves, crispers, etc. Refer to sections in Using Your Refrigerator for removal instructions.
- Use a clean sponge or soft cloth and a mild detergent in warm water. Do not use abrasive or harsh cleaners.
- Hand wash, rinse and dry all surfaces thoroughly.
- Plug in refrigerator or reconnect power.

### **OUTSIDE**

Waxing external painted metal surfaces helps provide rust protection. Do not wax plastic parts. Wax painted metal surfaces at least twice a year using appliance wax (or auto paste wax). Apply wax with a clean, soft cloth.

For products with a stainless steel exterior, use a clean sponge or soft cloth and a mild detergent in warm water. Do not use abrasive or harsh cleaners. Dry thoroughly with a soft cloth.

### **INSIDE WALLS (allow freezer to warm up so cloth won't stick)**

To help remove odors, you can wash the inside of the refrigerator with a mixture of baking soda and warm water. Mix 2 tablespoons baking soda to 1 quart of water (26 g soda to 1 liter water.) Be sure the baking soda is completely dissolved so does it not scratch the surfaces of the refrigerator.

**⚠ CAUTION:** While cleaning the inside, do not spray water.

### **DOOR LINERS AND GASKETS**

Do not use cleaning waxes, concentrated detergents, bleaches, or cleaners containing petroleum on plastic refrigerator parts.

### **PLASTIC PARTS (covers and panels)**

Do not use window sprays, abrasive cleansers, or flammable fluids. These can scratch or damage the material.

### **CONDENSER COILS**

Remove Back cover.

Use a vacuum cleaner with an extended attachment to clean condenser coils. Vacuum coils when dusty or dirty. Coils may need to be cleaned as often as every other month.

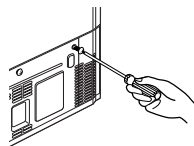

### **LIGHT BULB REPLACEMENT**

### **⚠ WARNING**

#### **Electrical Shock Hazard**

Before replacing a burned-out light bulb, either unplug the refrigerator or turn off power at the circuit breaker or fuse box.

**NOTE:** Moving the control to the OFF position does not remove power to the light circuit.

#### **NOTE:**

- Not all appliance bulbs will fit your refrigerator. Be sure to replace the bulb with one of the same size, shape and wattage.
- The light bulbs will turn off if door is left open for seven continuous minutes. Shutting door for one second will light bulbs to come back on.

#### **To change Refrigerator Light Bulbs**

1. Unplug Refrigerator, or disconnect power at the circuit breaker.
2. If necessary, remove top shelf or shelves.
3. Using a flat instrument, gently pry the lamp cover loose in the front as shown. Rotate downward to remove rear tabs.
4. Make sure the bulbs are cool to the touch. Turn bulbs counterclockwise to remove. Insert new bulb(s).
5. Replace with a new 40-watt appliance bulb.
6. Assemble in reverse order by snapping the Lamp Cover in, engaging the rear tabs followed by the front tabs.

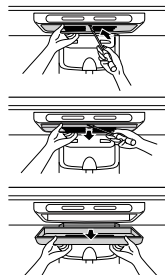

## CARE AND CLEANING

### To change freezer light

1. Unplug refrigerator power cord from outlet.
2. Using a flat instrument, gently pry the lamp cover loose in the front as shown. Rotate downward to remove the rear tabs.
3. Make sure the bulb is cool to the touch. Turn the bulb counterclockwise to remove.
4. Replace with a new 40-watt appliance bulb.
5. Insert tabs on back of cover into slots in freezer ceiling. Push cover up to snap front into place.

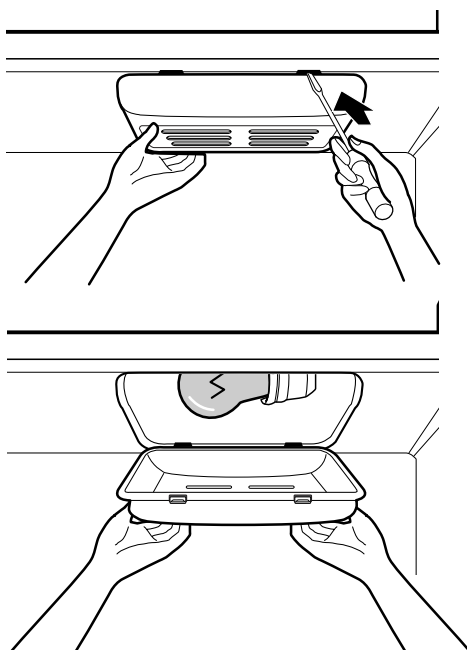

▲ **CAUTION:** DO NOT place fingers inside of cover. Lamp may be hot.

### POWER INTERRUPTIONS

1. If the power will be out for 24 hours or less, keep all refrigerator doors closed to help foods stay cold and frozen.
2. If the power will be out for more than 24 hours:
  - a) Remove all frozen food and store it in a frozen food locker.

### WHEN YOU GO ON VACATION

If you choose to leave the refrigerator on while you are away, follow these steps to prepare your refrigerator before you leave.

1. Use up any perishables and freeze other items.
2. Empty the ice bin.

If you choose to turn the refrigerator off before you leave, follow these steps.

1. Remove all food from the refrigerator.
2. Depending on your model, set the thermostat control (refrigerator control) to OFF. See the **Setting the Controls** section.
3. Clean refrigerator, wipe it and dry well.
4. Tape rubber or wood blocks to the tops of both doors to prop them open far enough for air to get in. This stops odor and mold from building up.

### WHEN YOU MOVE

When you are moving your refrigerator to a new home, follow these steps to prepare it for the move.

1. Remove all food from the refrigerator and pack all frozen food in dry ice.
2. Depending on your model, turn the thermostat control (refrigerator control) to OFF. See the **Setting the Controls** section.
3. Unplug the refrigerator.
4. Clean, wipe and dry thoroughly.
5. Take out all removable parts, wrap them well and tape them together so they don't shift and rattle during the move. Refer to sections in Using your Refrigerator for removal instructions.
6. Depending on the model, raise the front of the refrigerator so it rolls more easily OR screw in the leveling legs all the way so they don't scrape the floor. See the **Door Closing** section.
7. Tape the doors shut and tape the power cord to the refrigerator cabinet.

When you get to your new home, put everything back and refer to the **Installing Your Refrigerator** section for preparation instructions.

# ABOUT THE AUTOMATIC ICEMAKER

## **⚠ WARNING**

### **Personal Injury Hazard**

Avoid contact with the moving parts of the ejector mechanism, or with the heating element that releases the cubes. **DO NOT** place fingers or hands on the automatic icemaking mechanism while the refrigerator is plugged in.

## **OPERATION INSTRUCTIONS**

**A newly-installed refrigerator may take 12 to 24 hours to begin making ice.**

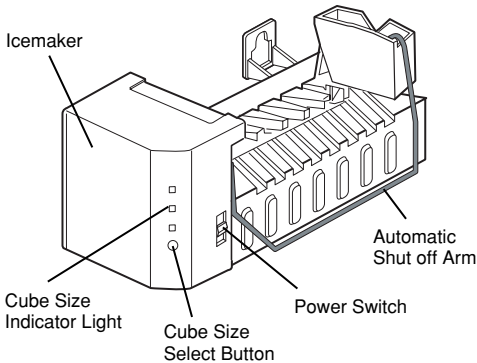

The icemaker will produce eight cubes per cycle—approximately 100–130 cubes in a 24-hour period, depending on freezer compartment temperature, room temperature, number of door openings and other operating conditions.

If the refrigerator is used before the water connection is made to the icemaker, set the power switch to **O (off)**.

When the refrigerator has been connected to the water supply, set the power switch to **I (on)**.

The icemaker will fill with water when it cools to freezing. A newly-installed refrigerator may take 12 to 24 hours to begin making ice cubes.

Throw away the first few batches of ice to allow the water line to clear.

Be sure nothing interferes with the sweep of the Automatic Shut off Arm.

When the bin fills to the level of the Automatic Shut off Arm, the icemaker will stop producing ice.

It is normal for several cubes to be stuck together.

If ice is not used frequently, old ice cubes will become cloudy, taste stale, and shrink.

**NOTE:** If the cube size is smaller or larger than you expected, you can regulate the size with the cube size button.

Every time you press the cube size button, the indicator moves up on light. The higher the light position, the larger the cubes will be. Pressing at highest position returns indicator to lowest position.

## **WHEN YOU SHOULD SET THE ICEMAKER POWER SWITCH TO O (OFF)**

- When the water supply will be shut off for several hours.
- When the ice bucket is removed for more than a minute or two.
- When the refrigerator will not be used for several days.

## **NORMAL SOUNDS YOU MAY HEAR**

- The icemaker water valve will buzz as the icemaker fills with water. If the power switch is in the **I (on)** position, it will buzz even if it has not yet been hooked up to water. To stop the buzzing, move the power switch to **O (off)**.

**NOTE:** Keeping the power switch in the **I (on)** position before the water line is connected can damage the icemaker.

- You will hear the sound of cubes dropping into the bin and water running in the pipes as the icemaker refills.

## **PREPARING FOR VACATION**

Set the icemaker power switch to **O (off)** and shut off the water supply to the refrigerator.

If the ambient temperature will drop below freezing, have a qualified servicer drain the water supply system to prevent serious property damage due to flooding from ruptured water lines or connections.

# CONNECTING THE WATER LINE

## BEFORE YOU BEGIN

This water line installation is not warranted by the refrigerator or icemaker manufacturer. Follow these instructions carefully to minimize the risk of expensive water damage.

Water hammer (water banging in the pipes) in house plumbing can cause damage to refrigerator parts and lead to water leakage or flooding. Call a qualified plumber to correct water hammer before installing the water supply line to the refrigerator.

To prevent burns and product damage, do not hook up the water line to the hot water line.

If you use your refrigerator before connecting the water line, make sure the icemaker power switch is in the **O (off)** position.

Do not install the icemaker tubing in areas where temperatures fall below freezing.

When using any electrical device (such as a power drill) during installation, be sure the device is double-insulated or grounded in a manner to prevent the hazard of electric shock, or is battery-powered.

All installations must be in accordance with local plumbing code requirements.

**NOTE:** Wear eye protection.

For installation, hose set will be provided with the refrigerator. When reinstalling, the hose must be discarded and replaced with a new one.

## WHAT YOU WILL NEED

- **Copper Tubing**, 1/4" outer diameter to connect the refrigerator to the water supply. Be sure both ends of the tubing are cut square.

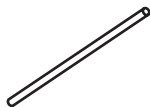

To determine how much tubing you need: measure the distance from the water valve on the back of the refrigerator to the water supply pipe.

Then add 8 feet (2.4 m). Be sure there is sufficient extra tubing (about 8 feet [2.4 m] coiled into 3 turns of about 10" [25 cm] diameter) to allow the refrigerator to move out from the wall after installation.

- **A cold water supply.** The water pressure must be between 147-834 kPa on models without a water filter and between 280-834 kPa on models with a water filter.
- **Power drill.**
- **1/2" or adjustable wrench.**
- **Straight- and Phillips-blade screwdriver.**

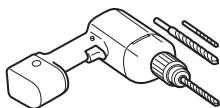

- **Two 1/4" outer diameter compression nuts and 2 ferrules (sleeves)** to connect the copper tubing to the shutoff valve and the refrigerator water valve.

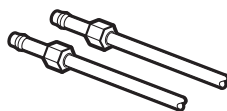

- If your existing copper water line has a flared fitting at the end, you will need an **adapter** (available at plumbing supply stores) to connect the water line to the refrigerator OR you can cut off the flared fitting with a tube cutter and then use a compression fitting.

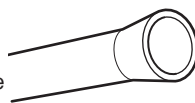

- **Shutoff valve to connect to the cold water line.** The shutoff valve should have a water inlet with a minimum inside diameter of 5/32" at the point of connection to the COLD WATER LINE. Saddle-type shutoff valves are included in many water supply kits. Before purchasing, make sure a saddle-type valve complies with your local plumbing codes.

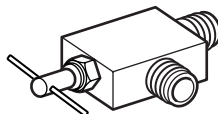

## INSTALLATION INSTRUCTIONS

Install the shutoff valve on the nearest frequently used drinking water line.

### 1. SHUT OFF THE MAIN WATER SUPPLY

Turn on the nearest faucet to relieve the pressure on the line.

### 2. CHOOSE THE VALVE LOCATION

Choose a location for the valve that is easily accessible. It is best to connect into the side of a vertical water pipe. When it is necessary to connect into a horizontal water pipe, make the connection to the top or side, rather than at the bottom, to avoid drawing off any sediment from the water pipe.

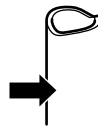

### 3. DRILL THE HOLE FOR THE VALVE

Drill a 1/4" hole in the water pipe (even if using a self-piercing valve) using a sharp bit. Remove any burrs resulting from drilling the hole in the pipe. Take care not to allow water to drain into the drill. Failure to drill a 1/4" hole may result in reduced ice production or smaller cubes.

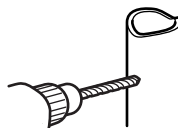

# CONNECTING THE WATER LINE

## INSTALLATION INSTRUCTIONS (CONTINUED)

### 4. FASTEN THE SHUTOFF VALVE

Fasten the shutoff valve to the cold water pipe with the pipe clamp.

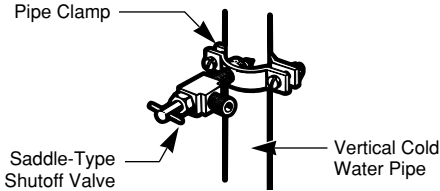

**NOTE:** Commonwealth of Massachusetts Plumbing Codes 248CMR shall be adhered to. Saddle valves are illegal and use is not permitted in Massachusetts. Consult with your licensed plumber.

### 5. TIGHTEN THE PIPE CLAMP

Tighten the clamp screws until the sealing washer begins to swell.

**NOTE:** Do not overtighten or you may crush the tubing.

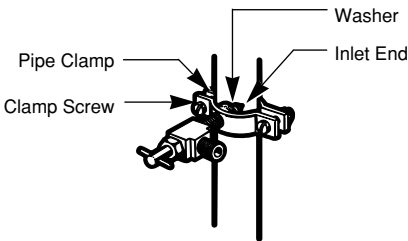

### 6. ROUTE THE TUBING

Route the tubing between the cold water line and the refrigerator.

Route the tubing through a hole drilled in the wall or floor (behind the refrigerator or adjacent base cabinet) as close to the wall as possible.

**NOTE:** Be sure there is sufficient extra tubing (about 8 feet coiled into 3 turns of about 10" diameter) to allow the refrigerator to move out from the wall after installation.

### 7. CONNECT THE TUBING TO THE VALVE

Place the compression nut and ferrule (sleeve) for copper tubing onto the end of the tubing and connect it to the shutoff valve. Make sure the tubing is fully inserted into the valve. Tighten the compression nut securely.

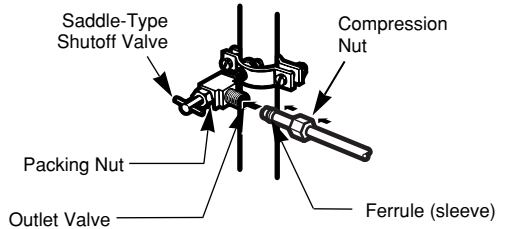

**NOTE:** Commonwealth of Massachusetts Plumbing Codes 248CMR shall be adhered to. Saddle valves are illegal and use is not permitted in Massachusetts. Consult with your licensed plumber.

### 8. FLUSH OUT THE TUBING

Turn the main water supply on and flush out the tubing until the water is clear.

Shut the water off at the water valve after about one quart of water has been flushed through the tubing.

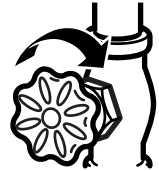

## CONNECTING THE WATER LINE

### 9. CONNECT THE TUBING TO THE REFRIGERATOR

Removing and Replacing Valve Cover

#### NOTE:

- Before making the connection to the refrigerator, be sure the refrigerator power cord is not plugged into the wall outlet.

1. Remove the plastic flexible cap from the water valve.
2. Place the compression nut and ferrule (sleeve) onto the end of the tubing as shown.
3. Insert the end of the copper tubing into the connection as far as possible. While holding the tubing, tighten the fitting.

**▲ CAUTION:** Check to see if leaks occurs at water line connections.

### 10. TURN THE WATER ON AT THE SHUTOFF VALVE

Tighten any connections that leak.  
Reattach the compressor compartment access cover.

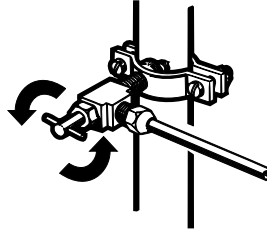

### 11. PLUG IN THE REFRIGERATOR

Arrange the coil of tubing so that it does not vibrate against the back of the refrigerator or against the wall. Push the refrigerator back to the wall.

### 12. START THE ICEMAKER

Set the icemaker power switch to the **ON** position. The icemaker will not begin to operate until it reaches its operating temperature of  $-9^{\circ}\text{C}$  or below. It will then begin operation automatically if the icemaker power switch is in the **I (on)** position.

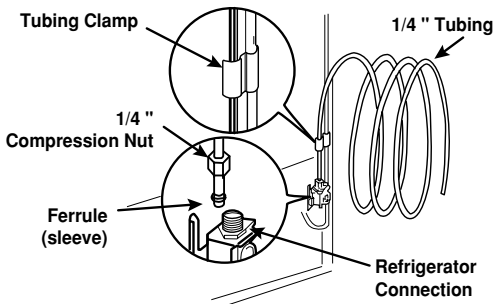

# TROUBLESHOOTING GUIDE

## UNDERSTANDING SOUNDS YOU MAY HEAR

Your new refrigerator may make sounds that your old one didn't make. Because the sounds are new to you, you might be concerned about them. Most of the new sounds are normal. Hard surfaces, like the floor, walls and cabinets, can make the sounds seem louder than they actually are. The following describes the kinds of sounds and what may be making them.

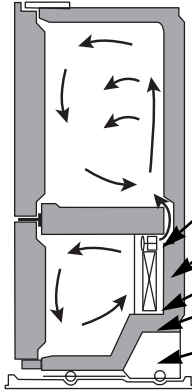

- The defrost timer will click when the automatic defrost cycle begins and ends. The thermostat control (or refrigerator control, depending on the model) will also click when cycling on and off.
- Rattling noises may come from the flow of refrigerant, the water line, or items stored on top of the refrigerator.
- Your refrigerator is designed to run more efficiently to keep your food items at the desired temperature. The high efficiency compressor may cause your new refrigerator to run longer than your old one, and you may hear a pulsating or high-pitched sound.
- You may hear the evaporator fan motor circulating the air through the refrigerator and freezer compartments.
- As each cycle ends, you may hear a gurgling sound due to the refrigerant flowing in your refrigerator.
- Contraction and expansion of the inside walls may cause a popping noise.
- Water dripping on the defrost heater during a defrost cycle may cause a sizzling sound.
- You may hear air being forced over the condenser by the condenser fan.
- You may hear water running into the drain pan during the defrost cycle.

	Check if...	Then...
<b>REFRIGERATOR DOES NOT OPERATE</b>	The power supply cord is unplugged.  A household fuse has blown or circuit breaker tripped.  The refrigerator control is set to the OFF position.  Refrigerator is in the defrost cycle.	<ul style="list-style-type: none"> <li>▶ Firmly plug the cord into a live outlet with proper voltage.</li> <li>▶ Replace the fuse or reset the circuit breaker.</li> <li>▶ Refer to the <b>Setting the Controls</b> section on page 19.</li> <li>▶ Wait about 30 minutes for defrost cycle to end.</li> </ul>
<b>VIBRATION OR RATTLING NOISE</b>	The refrigerator is not resting solidly on the floor.	<ul style="list-style-type: none"> <li>▶ Floor is weak or uneven or leveling legs need adjusting. See <b>Installation</b> section on page 11.</li> </ul>
<b>LIGHTS DO NOT WORK</b>	The power supply cord is unplugged.  Light bulb is loose in the socket.  Light bulb has burned out.  Door is left open for seven continuous minutes.	<ul style="list-style-type: none"> <li>▶ Firmly plug the cord into a live outlet with proper voltage.</li> <li>▶ Turn the refrigerator control to the OFF position and unplug the refrigerator. Gently remove the bulb and reinsert. Then plug in refrigerator and reset the refrigerator control.</li> <li>▶ Replace with an appliance bulb of the same wattage, size and shape available at your local hardware store. (See the <b>Changing the Light Bulb(s)</b> section on pages 26–27.) Turn the temperature control to the OFF position and unplug the refrigerator prior to replacement.</li> <li>▶ Shutting door for one second will light bulbs to come back on.</li> </ul>



# TROUBLESHOOTING GUIDE

	Check if...	Then...
<p><b>COMPRESSOR MOTOR SEEMS TO RUN TOO MUCH</b></p>	<p>The refrigerator that was replaced was an older model. The room temperature is hotter than normal.</p> <p>The door is opened often or a large amount of food has just been added.</p> <p>The refrigerator was recently plugged in and the refrigerator control was set correctly. The refrigerator control is not set correctly for the surrounding conditions. The doors are not closed completely.</p> <p>The condenser coils are dirty.</p>	<ul style="list-style-type: none"> <li>▶ Modern refrigerators with more storage space require more operating time.</li> <li>▶ The motor will run longer under warm conditions. At normal room temperatures, expect your motor to run about 40% to 80% of the time. Under warmer conditions, expect it to run even more often.</li> <li>▶ Adding food and opening the door warms the refrigerator. It is normal for the refrigerator to run longer in order to cool the refrigerator back down. Adding a large amount of food warms the refrigerator. See the <b>Food Storage Guide</b> section on page 20. In order to conserve energy, try to get everything you need out of the refrigerator at once, keep food organized so it is easy to find and close the door as soon as the food is removed.</li> <li>▶ The refrigerator will take up to 24 hours to cool completely.</li> <li>▶ See the <b>Adjusting Control Settings</b> section on page 20.</li> <li>▶ Push the doors firmly shut. If they will not shut all the way, see <b>Doors will not close completely</b> below.</li> <li>▶ This prevents air transfer and makes the motor work harder. Clean the condenser coils. Refer to the <b>Care and Cleaning</b> section on pages 26–27.</li> </ul>
<p><b>DOORS WILL NOT CLOSE COMPLETELY</b></p>	<p>The refrigerator is not level.</p> <p>Food packages are blocking the door open. The ice bin, crisper cover, pans, shelves, door bins or baskets are out of position.</p> <p>The gaskets are sticking.</p> <p>The refrigerator wobbles or seems unstable.</p> <p>The doors were removed during product installation and not properly replaced.</p>	<ul style="list-style-type: none"> <li>▶ See <b>Leveling and Door Alignment</b> on page 18.</li> <li>▶ Rearrange food containers to clear door and door shelves.</li> <li>▶ Push bins all the way in and put crisper cover, pans, shelves and baskets into their correct positions. See the <b>Using Your Refrigerator</b> section on pages 19–25.</li> <li>▶ Clean gaskets and the surface that they touch. Rub a thin coat of paraffin wax on the gaskets after cleaning.</li> <li>▶ Level the refrigerator. Refer to the <b>Leveling and Door Alignment</b> section on page 18.</li> <li>▶ Remove and replace the doors according to the <b>Removing and Replacing Refrigerator handles and doors</b> section on pages 12–17, or call a qualified service technician.</li> </ul>
<p><b>FROST OR ICE CRYSTALS ON FROZEN FOOD</b></p>	<p>The door is not closing properly.</p> <p>The door is opened often.</p>	<ul style="list-style-type: none"> <li>▶ See <b>Doors will not close completely</b> above.</li> <li>▶ When the door is opened, warm, humid air is allowed in the freezer, resulting in frost.</li> </ul>

## TROUBLESHOOTING GUIDE

	Check if...	Then...
<b>ICE HAS OFF-TASTE OR ODOR</b>	<p>The icemaker was recently installed.</p> <p>The ice has been stored for too long.</p> <p>The food has not been wrapped tightly in either compartment.</p> <p>The water supply contains minerals such as sulfur.</p> <p>The interior of refrigerator needs cleaning.</p> <p>Ice storage bin needs cleaning.</p>	<ul style="list-style-type: none"> <li>▶ Discard first few batches of ice to avoid discolored or off-flavored ice.</li> <li>▶ Throw away old ice and make new supply.</li> <li>▶ Rewrap foods since odors may migrate to the ice if food is not wrapped properly.</li> <li>▶ A filter may need to be installed (or replaced) to eliminate taste and odor problems.</li> <li>▶ See <b>Care and Cleaning</b> section on pages 26–27.</li> <li>▶ Empty and wash bin. Discard old cubes.</li> </ul>
<b>THERE IS WATER IN THE DEFROST DRAIN PAN</b>	<p>The refrigerator is defrosting.</p> <p>It is more humid than normal.</p>	<ul style="list-style-type: none"> <li>▶ The water will evaporate. It is normal for water to drip into the defrost pan.</li> <li>▶ Expect that the water in the defrost pan will take longer to evaporate. This is normal when it is hot or humid.</li> </ul>
<b>THE REFRIGERATOR SEEMS TO MAKE TOO MUCH NOISE</b>	<p>The sounds may be normal for your refrigerator.</p>	<ul style="list-style-type: none"> <li>▶ Refer to the <b>Understanding Sounds You May Hear</b> section on page 32.</li> </ul>
<b>THE ICEMAKER IS NOT PRODUCING ICE OR ICE CUBES ARE FREEZING TOO SLOWLY</b>	<p>The freezer temperature is cold enough to produce ice.</p> <p>Door left open.</p>	<ul style="list-style-type: none"> <li>▶ Wait 24 hours after hook-up for ice production. See the <b>Setting the Controls</b> section on page 19.</li> <li>▶ Check to see if something is holding the door open.</li> </ul>
<b>CUBES PRODUCED BY ICEMAKER ARE TOO SMALL</b>	<p>Smaller cube size level is selected.</p> <p>Water shutoff valve connecting refrigerator to water line may be clogged.</p>	<ul style="list-style-type: none"> <li>▶ Select larger cube size using cube size selector.</li> <li>▶ Call a plumber to clear the valve.</li> </ul>
<b>THE DOORS ARE DIFFICULT TO OPEN</b>	<p>The gaskets are dirty or sticky.</p> <p>The door is reopened within a short time after having been opened.</p>	<ul style="list-style-type: none"> <li>▶ Clean gaskets and the surfaces that they touch. Rub a thin coat of appliance polish or kitchen wax on the gaskets after cleaning.</li> <li>▶ When you open the door, warmer air enters the refrigerator. As the warm air cools, it can create a vacuum. If the door is hard to open, wait 5 minutes to allow the air pressure to equalize, then see if it opens more easily.</li> </ul>

# TROUBLESHOOTING GUIDE

	Check if...	Then...
<p><b>TEMPERATURE IS TOO WARM OR THERE IS INTERIOR MOISTURE BUILDUP</b></p>	<p>The air vents are blocked. Cold air circulates from the freezer to the fresh food section and back again through air vents in the wall dividing the two sections.</p>	<ul style="list-style-type: none"> <li>▶ Locate air vents by using your hand to sense airflow and move all packages that block vents and restrict airflow. Refer to <b>Multi-Flow</b> on page 19 for the location of air vents.</li> </ul>
	<p>The doors are opened often.</p>	<ul style="list-style-type: none"> <li>▶ When the door is opened, warm humid air is allowed into the refrigerator. The more the door is opened, the faster the humidity builds up, and the more warm air the refrigerator must cool. In order to keep the refrigerator cool, try to get everything you need out of the refrigerator at once, keep food organized so it is easy to find and close the door as soon as the food is removed.</li> </ul>
	<p>The control is not set correctly for the surrounding conditions.</p>	<ul style="list-style-type: none"> <li>▶ Refer to the <b>Setting the Controls</b> section on page 19. Wait 24 hours for temperatures to stabilize or even out. If the temperature is too cold or too warm, move the dial one number at a time.</li> </ul>
	<p>A large amount of food has just been added to the refrigerator or freezer.</p>	<ul style="list-style-type: none"> <li>▶ Adding food warms the refrigerator. It can take a few hours for the refrigerator to return to normal temperature.</li> </ul>
	<p>The food is not packaged correctly.</p>	<ul style="list-style-type: none"> <li>▶ Wrap food tightly and wipe off damp containers prior to storing in the refrigerator to avoid moisture accumulation. If necessary, repackage food according to the guidelines in the <b>Food Storage Guide</b> section on page 20.</li> </ul>
	<p>The doors are not closing completely.</p>	<ul style="list-style-type: none"> <li>▶ See <b>Doors will not close completely</b> on page 33.</li> </ul>
	<p>The weather is humid.</p>	<ul style="list-style-type: none"> <li>▶ In humid weather, air carries moisture into refrigerator when doors are opened.</li> </ul>
	<p>A self-defrost cycle was completed.</p>	<ul style="list-style-type: none"> <li>▶ It is normal for droplets to form on the back wall after the refrigerator self-defrosts.</li> </ul>



