

LCD TV | PLASMA TV OWNER'S MANUAL

LCD TV MODELS

32LG6***
37LG6***
42LG6***
47LG6***
42LG7***
47LG7***
52LG7***
32LG8***
42LG8***

PLASMA TV MODELS

50PG3***
42PG6***
50PG6***
60PG6***
50PG7***
60PG7***

Please read this manual carefully before operating your set.
Retain it for future reference.

Record model number and serial number of the set.
Refer to the label on the back cover and quote this information.

To your dealer when requiring service.

ACCESSORIES

Ensure that the following accessories are included with your TV.

If an accessory is missing, please contact the dealer where you purchased the product.

■ Image shown may differ from your TV.

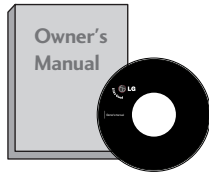

Owner's Manual

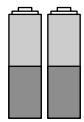

Batteries



Power Cord

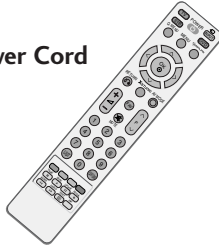

Remote Control

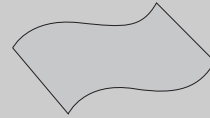

Polishing Cloth

Polishing cloth for use on the screen
This feature is not available for all models.

*Lightly wipe any stains or fingerprints on the surface of the TV with the polishing cloth.

Do not use excessive force. This may cause scratching or discolouration.

PLASMA TV models

Cable management clip

(except 50PG3***)



(only 50/60PG6***, (only 50PG3***)
50/60PG7***)

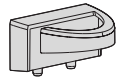

Cable Holder



42PG6***: 1EA
50PG3***: 2EA only

(only 42PG6***)



4-bolts for stand assembly
Refer to p. 10

protection cover (Refer to p.10)

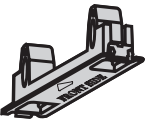

or

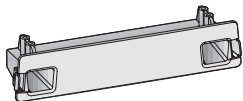

Ferrite Core



This feature is not available for all models.

Use of ferrite core (This feature is not available for all models.)

Ferrite core can be used to reduce the electromagnetic wave when connecting the power cord.
The closer the location of the ferrite core to the power plug, the better it is.

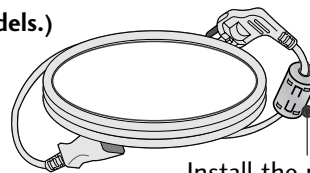

Install the power plug closely.

LCD TV models

Only 32/37/42/47LG6**



Cable management clip
(Refer to p.15)



Protection cover
(Refer to p.12)

(only 32/37LG6***)



32LG6***: 3EA
37LG6***: 4EA



4EA

(only 42LG6***)



2EA



1EA



4EA

bolts for stand assembly (Refer to p. 11)

Only 42/47/52LG7***, 32/42LG8***

(42LG7***, 32/42LG8*** only)



x 4



x 4

Bolts for stand assembly
(Refer to p.12)

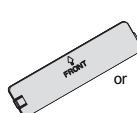

or

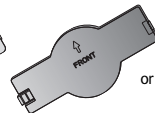

or

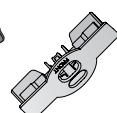

Protection cover

(32/42LG8*** only)



1-screw for stand fixing
(Refer to p.9)

CONTENTS

ACCESSORIES 1

PREPARATION

Front Panel Controls.....	4
Back Panel Information	7
Attaching the TV to a desk	9
Stand Installation.....	10
Back Cover for Wire Arrangement.....	13
Please set it up carefully so the product does not fall over	16
Desktop Pedestal Installation	17
Wall Mount: Horizontal installation.....	17
Antenna Connection.....	18

EXTERNAL EQUIPMENT SETUP

HD Receiver Setup	19
DVD Setup	22
VCR Setup.....	25
Other A/V Source Setup	28
External Stereo.....	29
AV Output Setup	30
PC Setup	31
- Screen Setup for PC Mode.....	34

WATCHING TV / PROGRAMME CONTROL

Remote Control Key Functions.....	38
Turning on the TV.....	40
Programme Selection	40
Volume Adjustment.....	40
Quick Menu.....	41
On Screen Menus Selection and Adjustment	42
Auto Programme Tuning.....	43
Manual Programme Tuning.....	44
Fine Tuning	45
Assigning a Station Name	46
Booster	47
Programme Edit	48

Favourite Programme	49
Selecting the Programme List.....	50
 SIMPLINK	51
Key lock.....	53
AV Mode	54

TO USE THE USB DEVICE

When connecting the USB device.....	55
Photo List.....	56
Music List.....	58
Movie List	60
Divx Registration Code	62

PICTURE CONTROL

Watching PIP(Picture-in-Picture)	63
Picture Size (Aspect Ratio)Control	64
Preset Picture Settings	
- Picture Mode-Preset.....	66
- Auto Colour Tone Control(Cool/Medium/Warm)	67
Manual Picture Adjustment	
- Picture Mode-User Option.....	68
- Colour Tone - User Option.....	69
XD - Picture Improvement Technology	70
Advanced - Gamma.....	71
Advanced - Film Mode/Real Cinema.....	72
Advanced - Black(Darkness) Level.....	73
Eye Care	74
Advanced-TruMotion	75
Picture Reset	76
TruMotion Demo	77
Power Indicator.....	78
Image Sticking Minimization(ISM) Method.....	79
Power Saving Picture Mode	80
Factory Reset	81

SOUND & LANGUAGE CONTROL

Auto Volume Leveler	82
Preset Sound Settings - Sound Mode	83
Sound Setting Adjustment - User Mode	84
Balance	85
TV Speakers On/Off Setup	86
Selecting Audio Out	86
Sliding Mode	87
I/II	
- Stereo/Dual Reception	88
- NICAM Reception	89
- Speaker Sound Output Selection	89
On-Screen Menu Language Selection	90

TIME SETTING

Clock Setup	91
Auto On/Off Timer Setting	92
Sleep Timer Setting	93
Auto Shut-off Setting	94

TELETEXT

Switch On/Off	95
SIMPLE Text	95
TOP Text	96
FASTEXT	96
Special Teletext Functions	97

APPENDIX

Troubleshooting	98
Maintenance	100
Product Specifications	101
Programming the Remote Control	103
IR Codes	105
External Control Through RS-232C	107

PREPARATION

FRONT PANEL CONTROLS

- This is a simplified representation of the front panel. Image shown may differ from your TV.
- If your product has a protection film attached, remove the film and then wipe the product with a polishing cloth.

Plasma TV Models

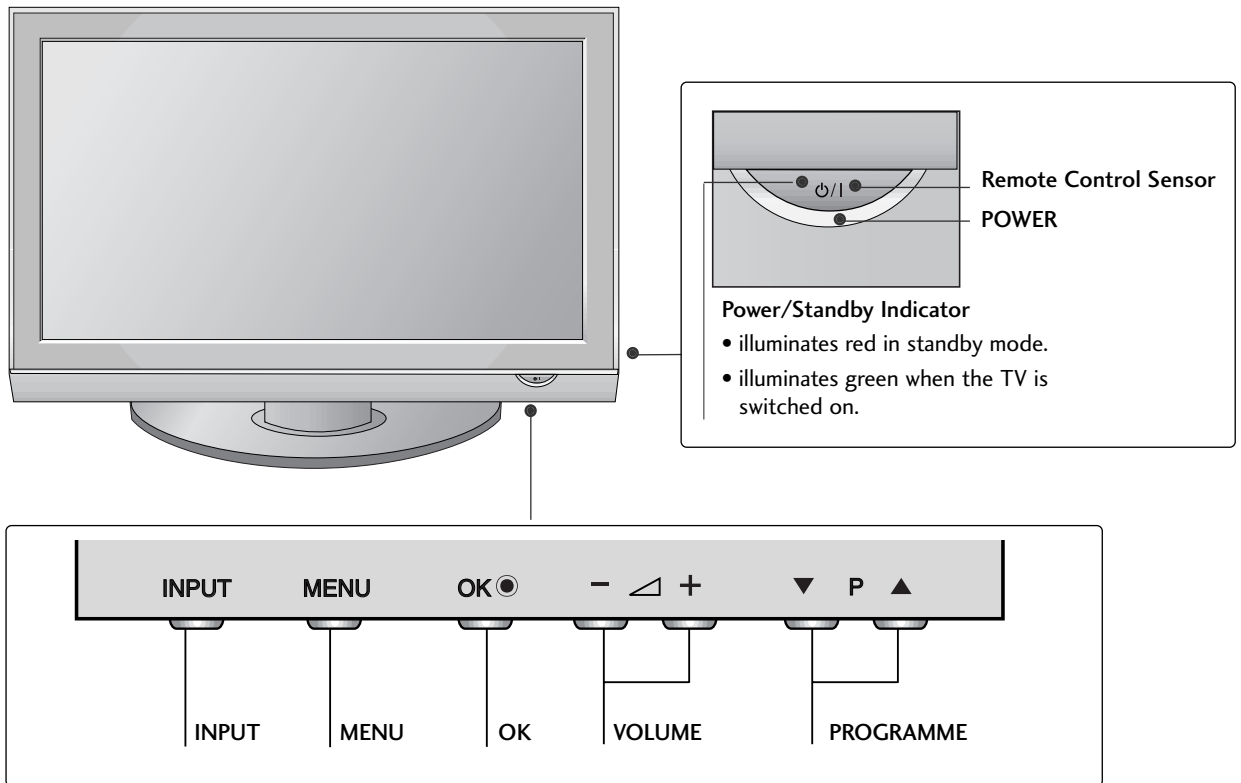

Swivel Stand

This feature is not available for all models.

After installing the TV, you can adjust the TV set manually to the left or right direction by 20 degrees to suit your viewing position.

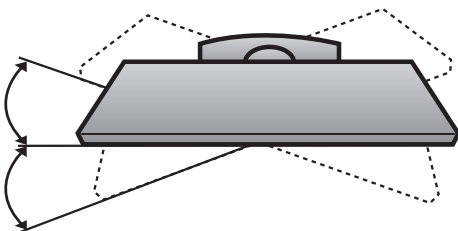

LCD TV Models

32/37/42/47LG6***

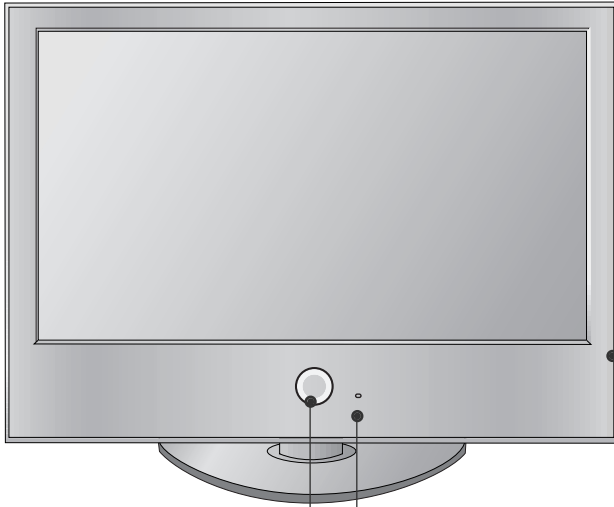

Intelligent Sensor
Adjusts picture according to the surrounding conditions

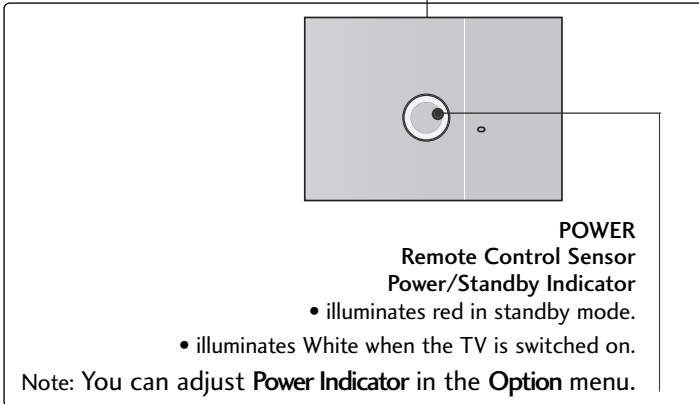

POWER Remote Control Sensor
Power/Standby Indicator

- illuminates red in standby mode.
- illuminates White when the TV is switched on.

Note: You can adjust **Power Indicator** in the **Option** menu.

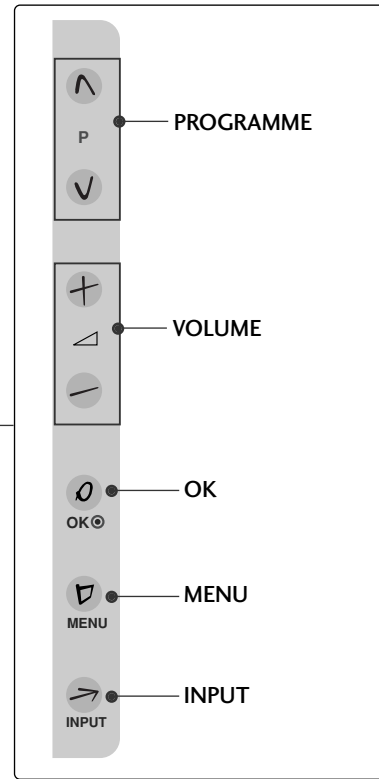

PROGRAMME

VOLUME

OK

MENU

INPUT

42/47/52LG7***

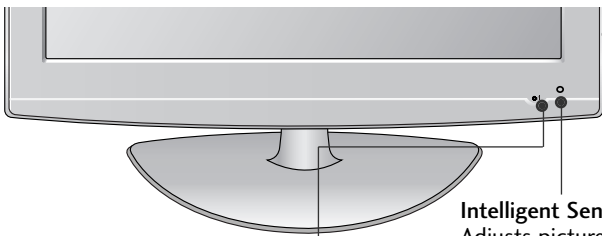

Intelligent Sensor
Adjusts picture according to the surrounding conditions.

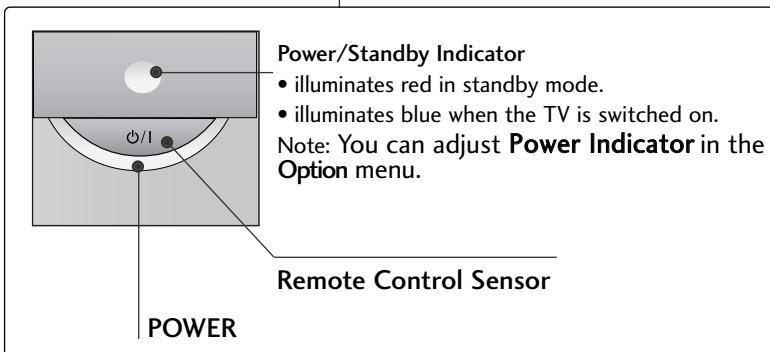

Power/Standby Indicator

- illuminates red in standby mode.
- illuminates blue when the TV is switched on.

Note: You can adjust **Power Indicator** in the **Option** menu.

Remote Control Sensor

POWER

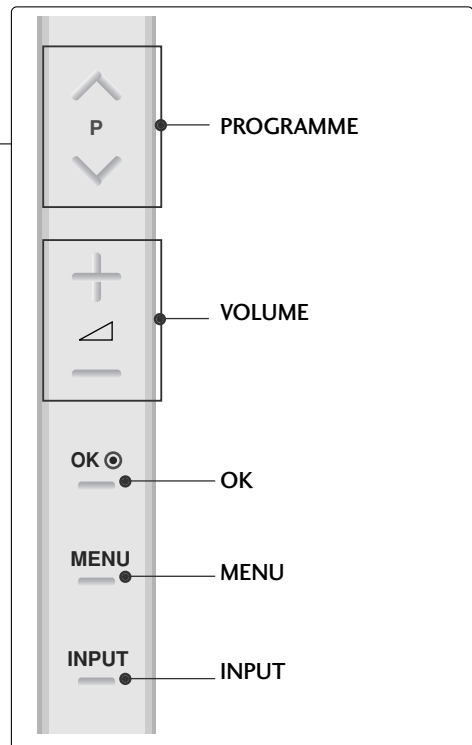

PROGRAMME

VOLUME

OK

MENU

INPUT

32/42LG8***

* Give extra space for installing speakers on both sides of the TV to allow for free movement.
(only 42LG8***)

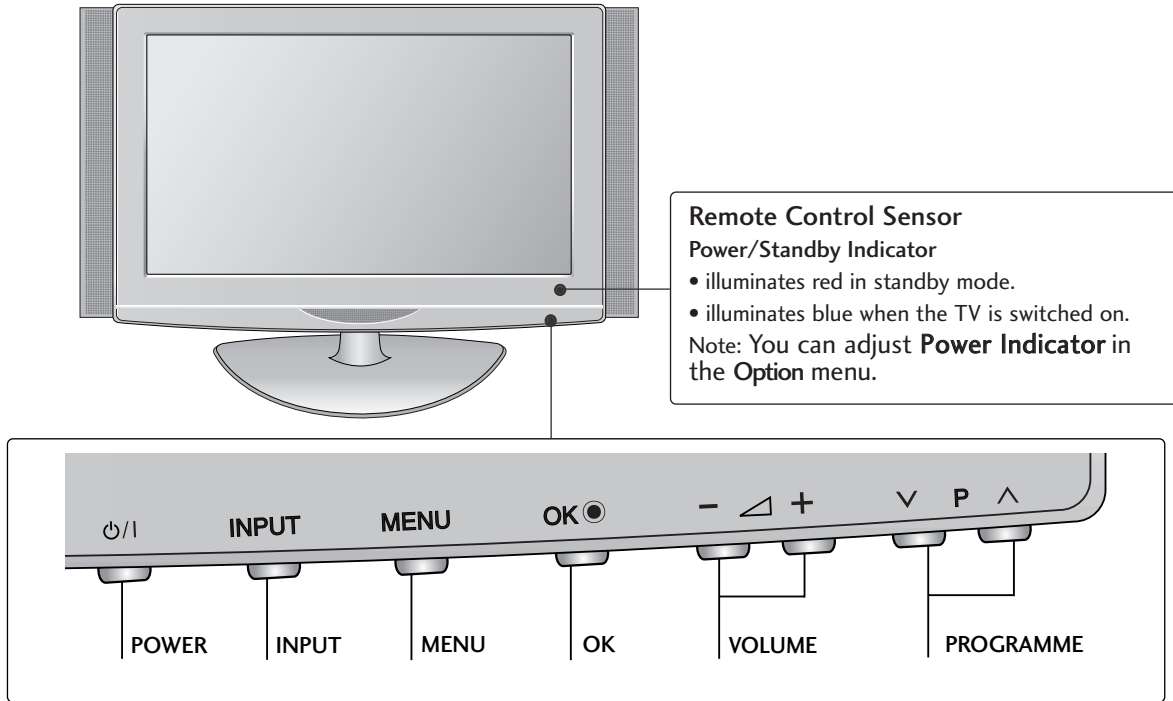

Not Using the Desk-type Stand

■ Image shown may differ from your TV.
 When installing the wall-mounted unit, use the protection cover for desk-type stand installation. Insert the **PROTECTION COVER** into the TV until clicking sound.

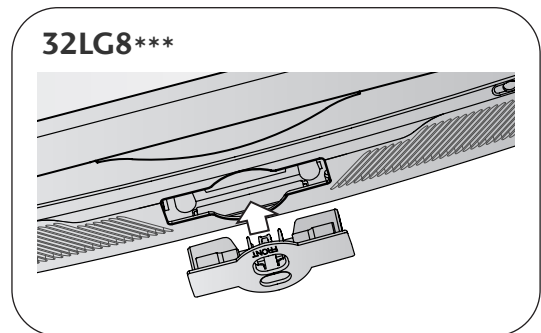

How to remove the portection cover

■ Image shown may differ from your TV.
 Press the A part of protection cover as shown and pull it backward.

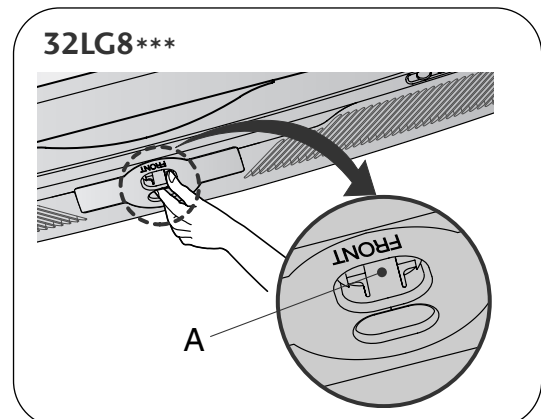

BACK PANEL INFORMATION

▪ This is a simplified representation of the back panel. Image shown may differ from your TV.

Plasma TV Models

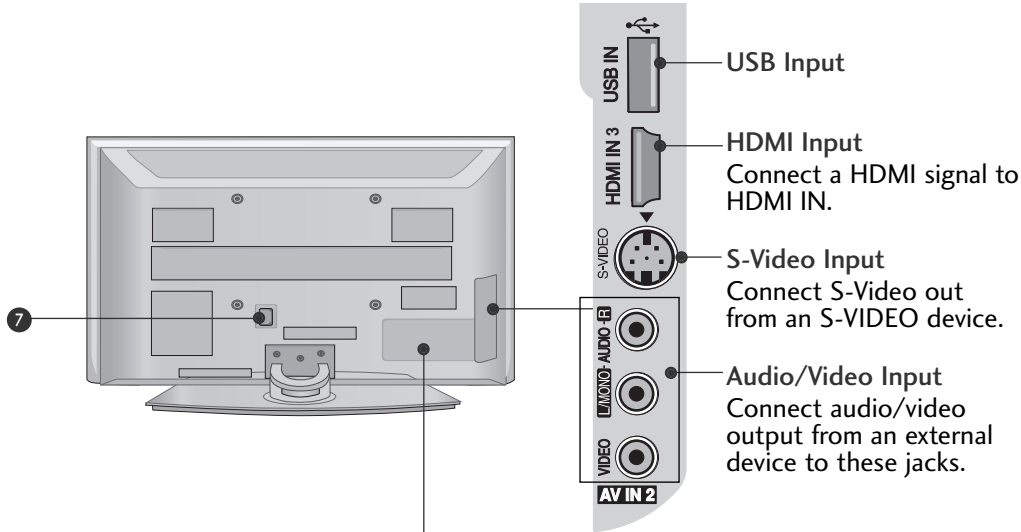

42/50/60PG6***

50PG3***, 50/60PG7***

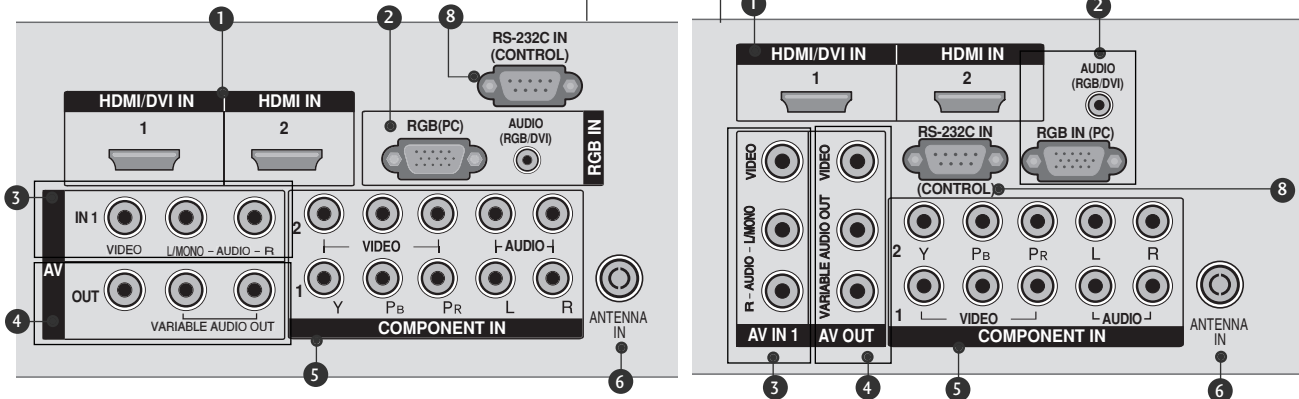

- ① **HDMI Input**
Connect a HDMI signal to HDMI IN.
Or DVI(VIDEO)signal to HDMI/DVI port with DVI to HDMI cable.
- ② **RGB/Audio Input**
Connect the monitor output from a PC to the appropriate input port.
- ③ **Audio/Video Input (AV IN 1)**
Connect audio/video output from an external device to these jacks.
- ④ **AV Output**
Connect second TV or monitor to the AV OUT socket on the TV.
Variable Audio Output
Connect an external amplifier or add a subwoofer to your surround sound system.

- ⑤ **Component Input**
Connect a component video/audio device to these jacks.
- ⑥ **Antenna Input**
Connect RF antenna to this jack.
- ⑦ **Power Cord Socket**
This TV operates on an AC power. The voltage is indicated on the Specifications page. Never attempt to operate the TV on DC power.
- ⑧ **RS-232C Input (CONTROL) Port**
Connect the serial port of the control devices to the RS-232C jack.
(This feature is not available for all models.)

PREPARATION

LCD TV Models

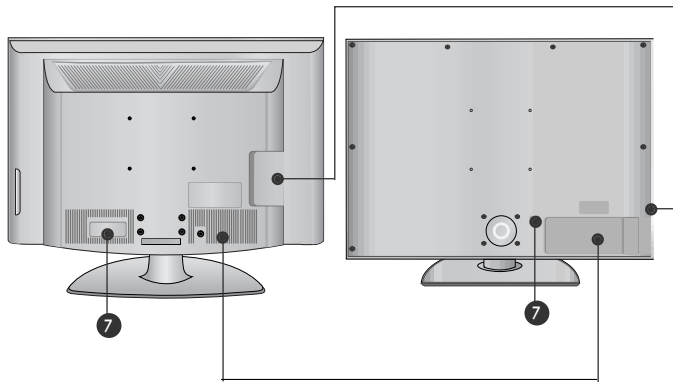

32/37LG6***

42/47LG6***, 42/47/52LG7***

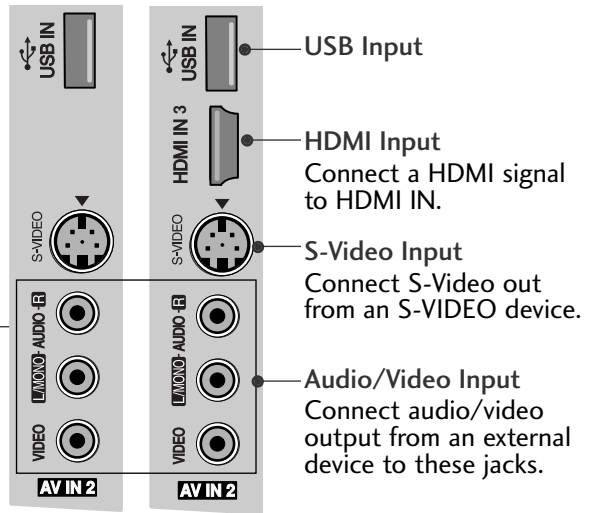

32/37/42/47LG6***

42/47/52LG7***

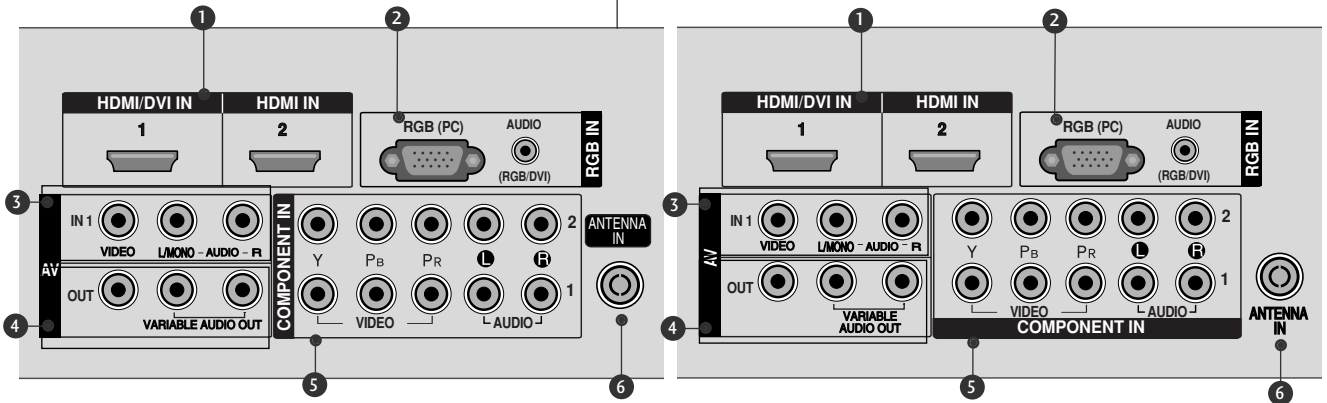

32/42LG8***

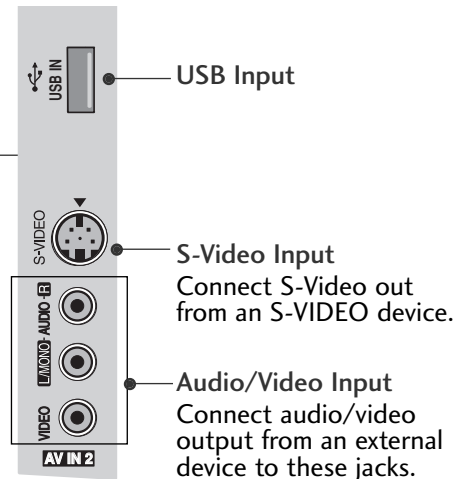
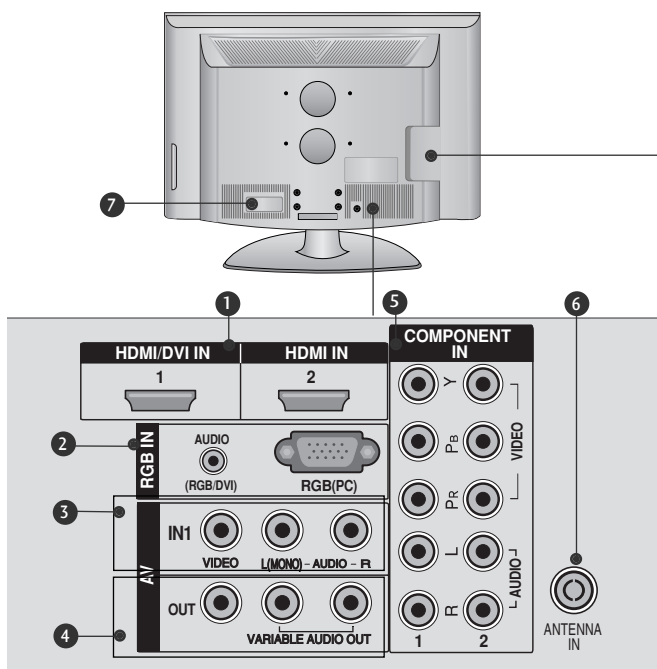

1 HDMI Input

Connect a HDMI signal to HDMI IN.
Or DVI(VIDEO)signal to HDMI/DVI port with DVI to HDMI cable.
(HDMI IN 3 is available for 42/47LG6***, 42/47/52LG7***)

2 RGB/Audio Input

Connect the monitor output from a PC to the appropriate input port.

3 Audio/Video Input

Connect audio/video output from an external device to these jacks.

4 AV Output

Connect second TV or monitor to the AV OUT socket on the TV.

Variable Audio Output

Connect an external amplifier or add a subwoofer to your surround sound system.

5 Component Input

Connect a component video/audio device to these jacks.

6 Antenna Input

Connect RF antenna to this jack.

7 Power Cord Socket

This TV operates on an AC power. The voltage is indicated on the Specifications page. Never attempt to operate the TV on DC power.

ATTACHING THE TV TO A DESK (Only 32/42LG8***)

The TV must be attached to desk so it cannot be pulled in a forward/backward direction, potentially causing injury or damaging the product. Use only an attached screw.

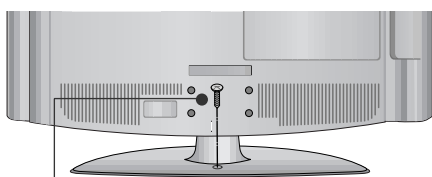

1 -Screw
(provided as parts of the product)

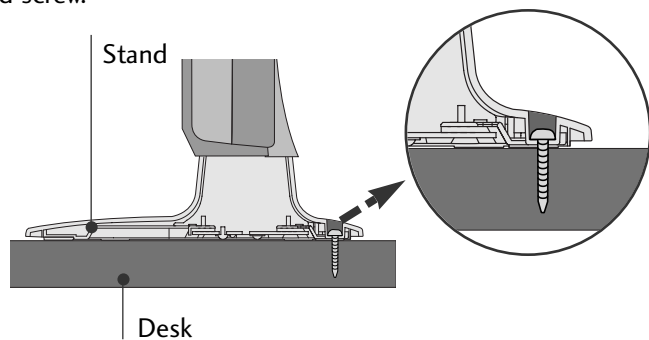

! WARNING

- ▶ To prevent TV from falling over, the TV should be securely attached to the floor/wall per installation instructions. Tipping, shaking, or rocking the machine may cause injury.

PREPARATION

STAND INSTALLATION

▪ Image shown may differ from your TV.

When assembling the desk type stand, check whether the bolt is fully tightened. (If not tightened fully, the product can tilt forward after the product installation.) If you tighten the bolt with excessive force, the bolt can deviate from abrasion of the tightening part of the bolt.

only 42PG6***

- 1 Carefully place the TV screen side down on a cushioned surface to protect the screen from damage.

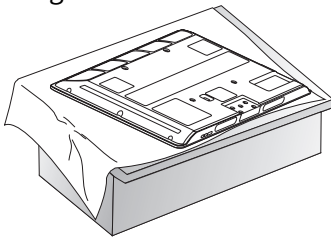

- 2 Assemble the TV as shown.

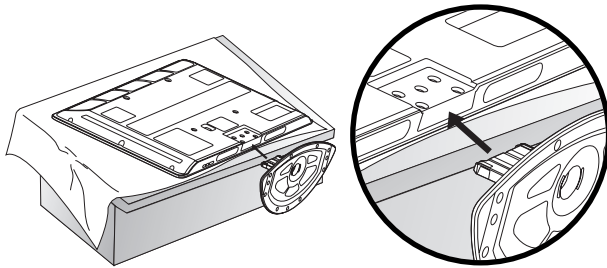

- 3 Fix the 4 bolts securely using the holes in the back of the TV.

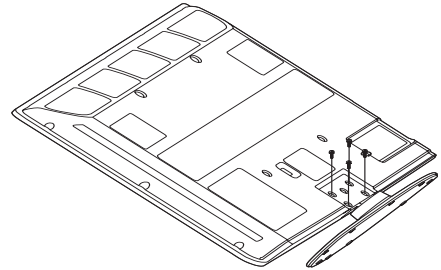

Not Using the Desk-type Stand

▪ Image shown may differ from your TV.

When installing the wall-mounted unit, use the protection cover for desk-type stand installation. Insert the PROTECTION COVER into the TV until clicking sound.

Plasma TV models

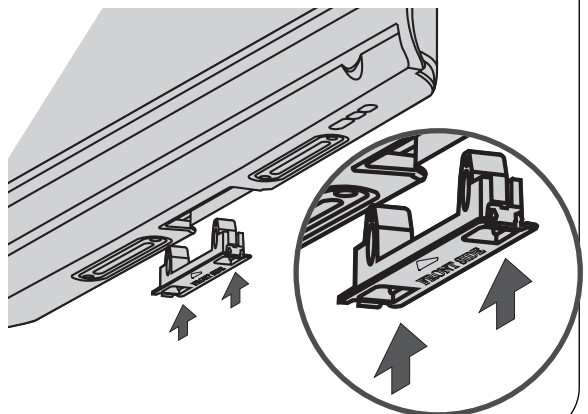

only 32/37/42LG6***

- 1 Carefully place the TV screen side down on a cushioned surface to protect the screen from damage.

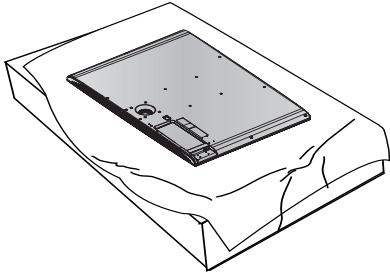

- 2 Assemble the parts of the **Stand Body** with **Cover Base** of the TV.

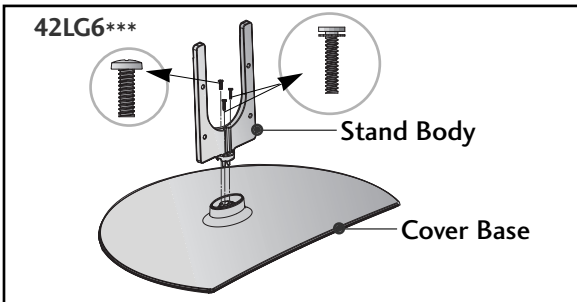
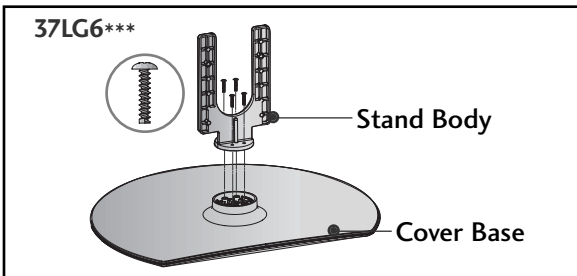
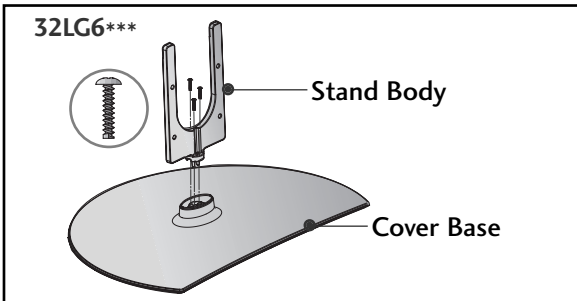

- 3 Assemble the TV as shown.

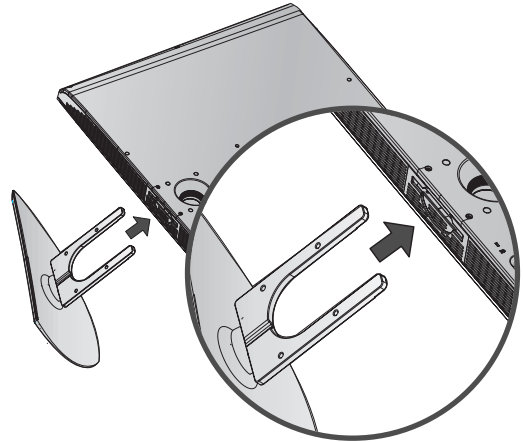

- 4 Fix the 4 bolts securely using the holes in the back of the TV.

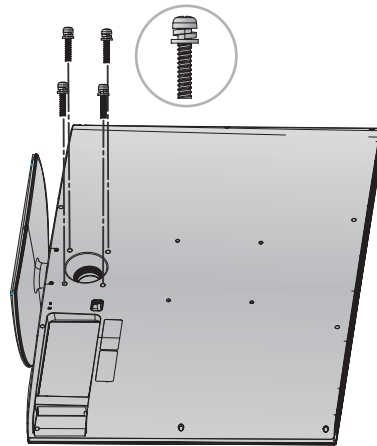

only 42LG7***, 32/42LG8***

- 1 Carefully place the TV screen side down on a cushioned surface to protect the screen from damage.

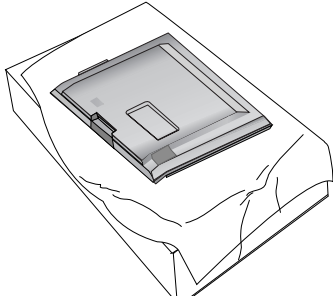

- 2 Assemble the parts of the **Stand Body** with the **Cover Base** of the TV.

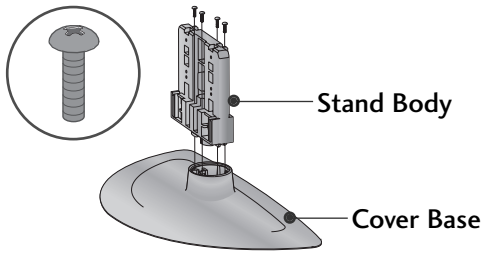

- 3 Assemble the TV as shown.

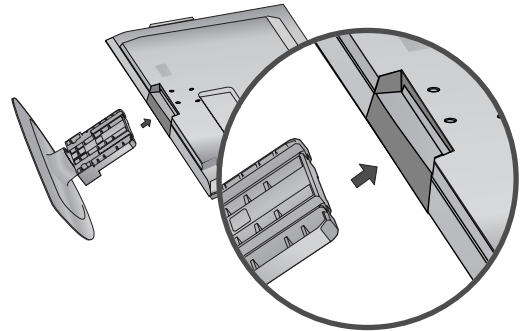

- 4 Fix the 4 bolts securely using the holes in the back of the TV.

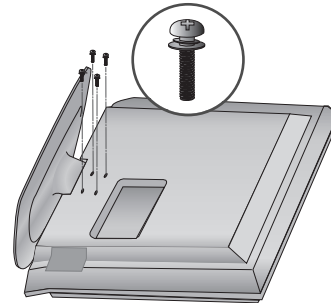

Not Using the Desk-type Stand

When installing the wall-mounted unit, use the protection cover for desk-type stand installation.

- Image shown may differ from your TV.

32/37/42/47LG6***

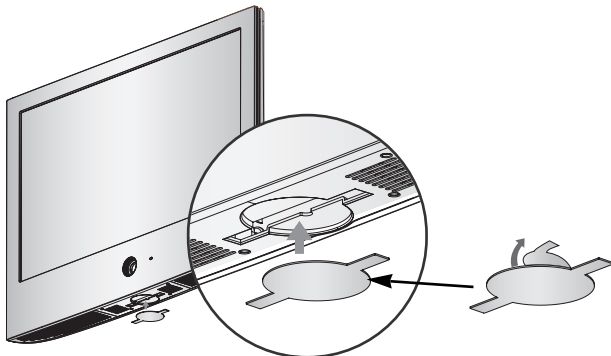

After removing the protection paper from the protection cover, adhere it to the TV as shown.

42/47/52LG7***, 42LG8***

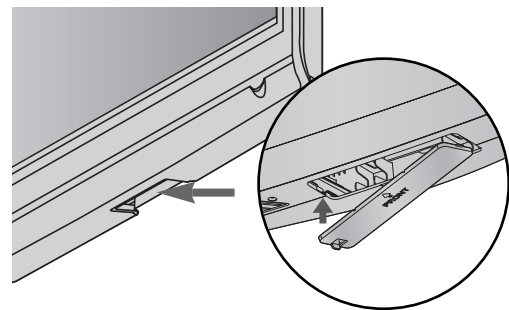

Insert the **PROTECTION COVER** into the TV until clicking sound.

BACK COVER FOR WIRE ARRANGEMENT

■ Image shown may differ from your TV.

42PG6***

1 Connect the cables as necessary.

To connect additional equipment, see the **External Equipment Setup** section.

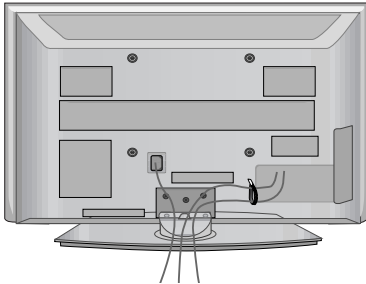

2 Install the **CABLE MANAGEMENT CLIP** as shown.

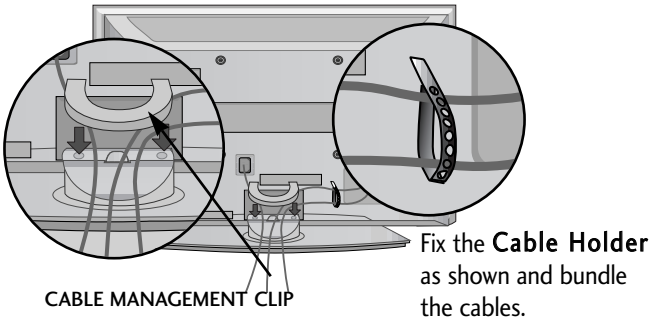

50/60PG6***, 50/60PG7***

1 Connect the cables as necessary.

To connect additional equipment, see the **External Equipment Setup** section.

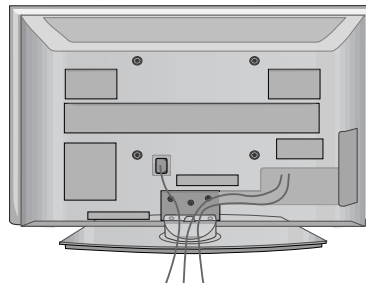

2 Install the **CABLE MANAGEMENT CLIP** as shown.

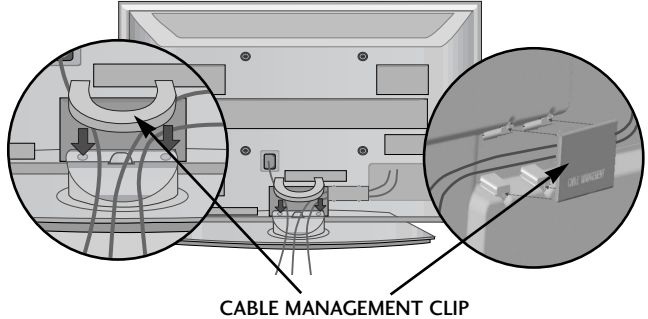

How to remove the cable management clip

Hold the **CABLE MANAGEMENT CLIP** with both hands and pull it upward.

42PG6***

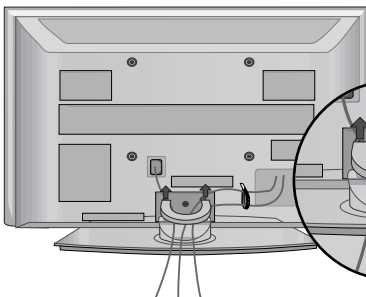

50/60PG6***, 50/60PG7***

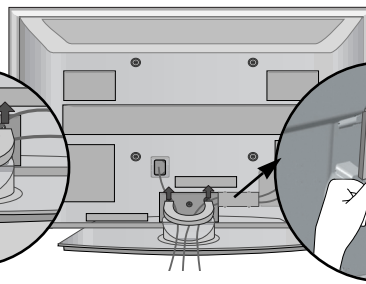

Separate **CABLE MANAGEMENT** from TV by pressing two latches.

* For the 42PG6*** model, press the center of the **CABLE MANAGEMENT CLIP** and then lift up it.

! NOTE

- ▶ Do not use the **CABLE MANAGEMENT CLIP** to lift the TV.
- If the TV is dropped, you may be injured or the TV may be damaged.

PREPARATION

■ Image shown may differ from your TV.

50PG3***

- 1 Connect the cables as necessary.
To connect additional equipment, see the **EXTERNAL EQUIPMENT SETUP** section.

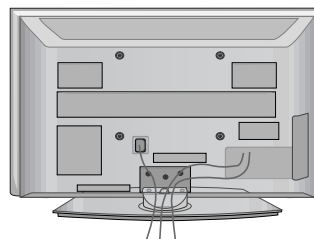

- 2 Install the **CABLE MANAGEMENT CLIP** as shown.
If your TV has the **CABLE HOLDER**, install it as shown and bundle the cables.

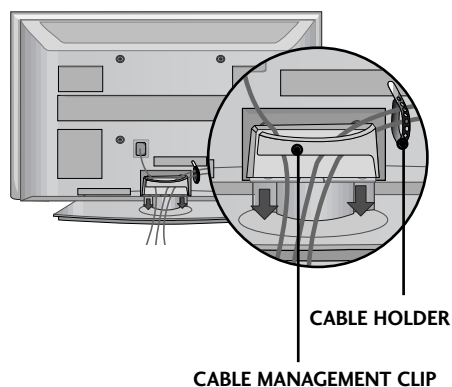

How to remove the cable management clip

Hold the **CABLE MANAGEMENT CLIP** with both hands and pull it upward.

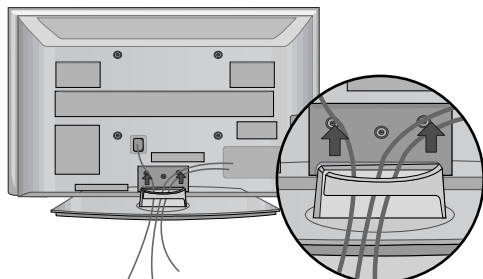

! NOTE

- ▶ Do not use the **CABLE MANAGEMENT CLIP** to lift the TV.
- If the TV is dropped, you may be injured or the TV may be damaged.

32/37/42/47LG6***

- 1** Align the hole with the tab on the **CABLE MANAGEMENT CLIP**.
Turn the **CABLE MANAGEMENT CLIP** as shown.

Note: This cable management can be broken by excessive pressure.

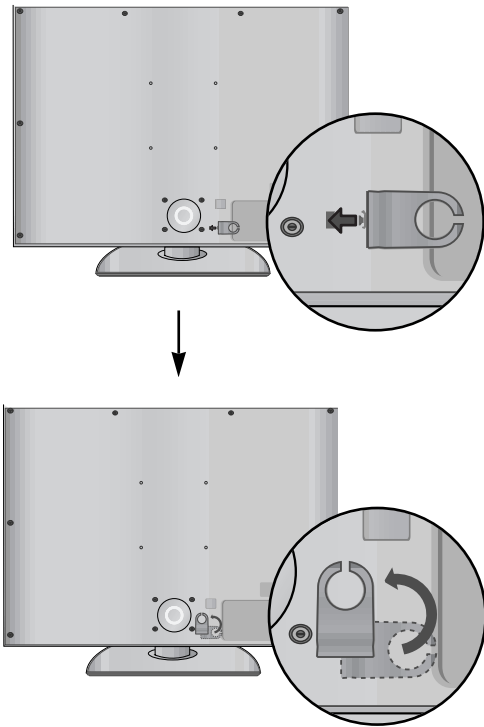

- 2** Connect the cables as necessary.
To connect additional equipment, see the **External Equipment Setup** section.

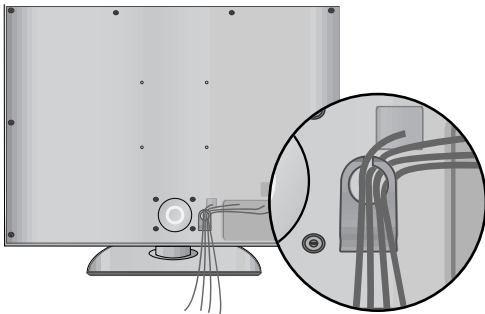

42/47/52LG7*, 32/42LG8*****

- 1** Connect the cables as necessary.
To connect additional equipment, see the **External Equipment Setup** section of the manual.

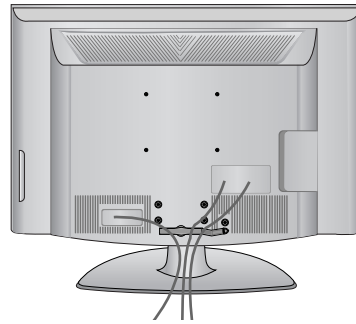

- 2** Open the **CABLE MANAGEMENT CLIP** as shown and manage the cables.

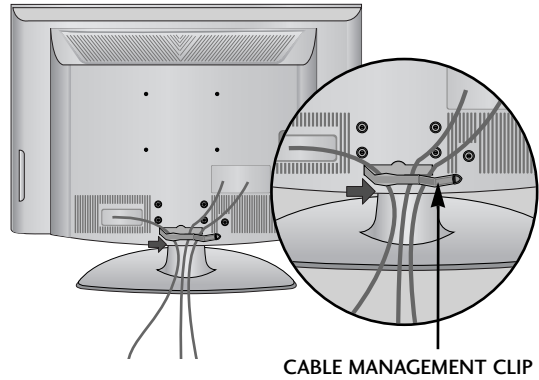

- 3** Fit the **CABLE MANAGEMENT CLIP** as shown.

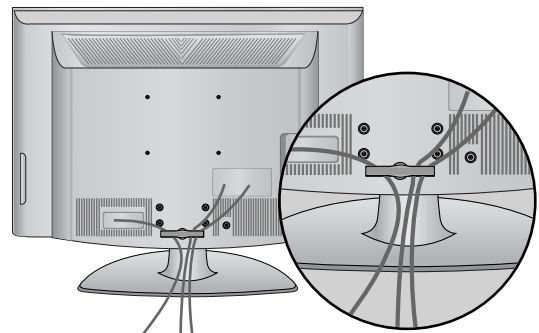

PREPARATION

PLEASE SET IT UP CAREFULLY SO THE PRODUCT DOES NOT FALL OVER.

- You should purchase necessary components to fix the TV to the wall on the market.
- Position the TV close to the wall to avoid the possibility of it falling when pushed.
- The instructions shown below are a safer way to set up the TV, which is to fix it to the wall, avoiding the possibility of it falling forwards if pulled. This will prevent the TV from falling forward and causing injury. This will also prevent the TV from damage. Ensure that children do not climb or hang from the TV.

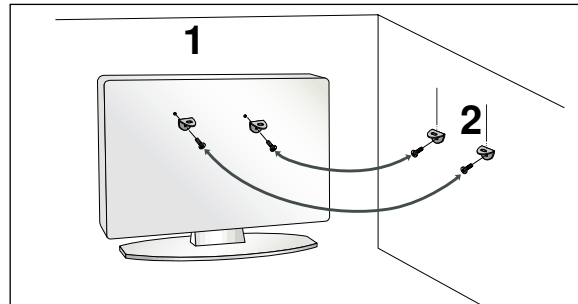
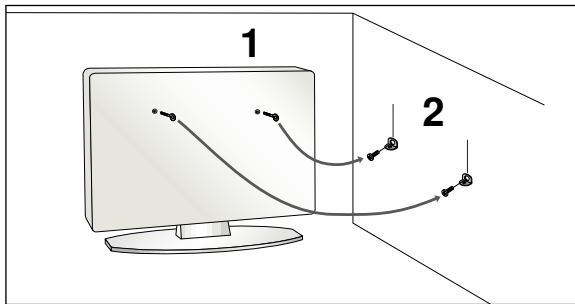

- 1 Use the eye-bolts or TV brackets/bolts to fix the product to the wall as shown in the picture.
(If your TV has bolts in the eyebolts, loosen then bolts.)
* Insert the eye-bolts or TV brackets/bolts and tighten them securely in the upper holes.
- 2 Secure the wall brackets with bolts to the wall.
Ensure that both brackets are even.

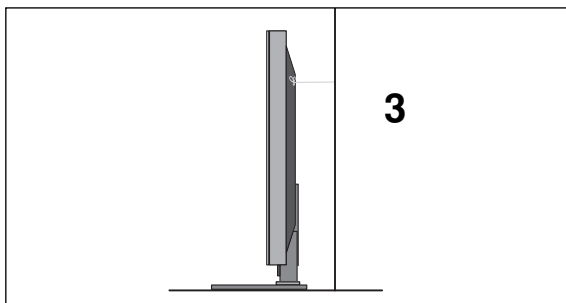

- 3 Use a strong cord to secure the TV.
Secure the cord in such a way that it becomes taught when the TV is in position.

! NOTE

- ▶ When moving the TV undo the cords first.
- ▶ Use a platform or cabinet string and large enough to support the size and weight of the TV.
- ▶ To use the TV safely make sure that the height of the bracket on the wall and on the TV is the same.

- The TV can be installed in various ways such as on a wall, or on a desktop etc.
- The TV is designed to be mounted horizontally.

EARTHING

Ensure that you connect the earth wire to prevent possible electric shock. If grounding methods are not possible, have a qualified electrician install a separate circuit breaker. Do not try to earth the TV by connecting it to telephone wires, lightening rods or gas pipes.

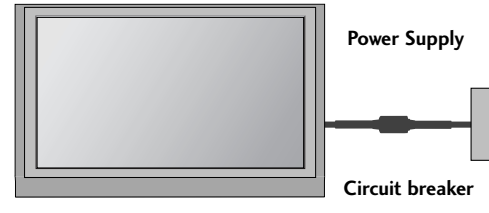

DESKTOP PEDESTAL INSTALLATION

For adequate ventilation allow a clearance of 4" (10cm) all around the TV .

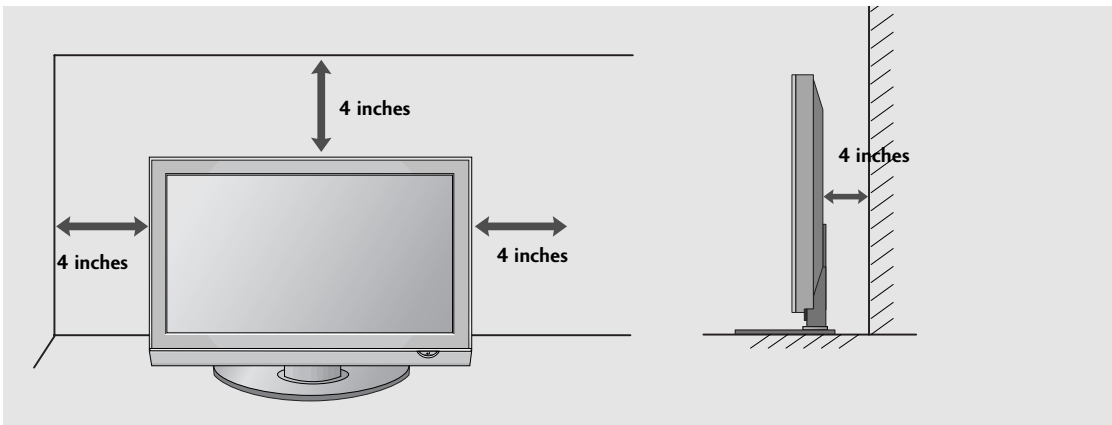

WALL MOUNT: HORIZONTAL INSTALLATION

For adequate ventilation allow a clearance of 4" (10cm) all around the TV. We recommend that you use a wall mounting bracket of LG brand when mounting the TV to a wall.

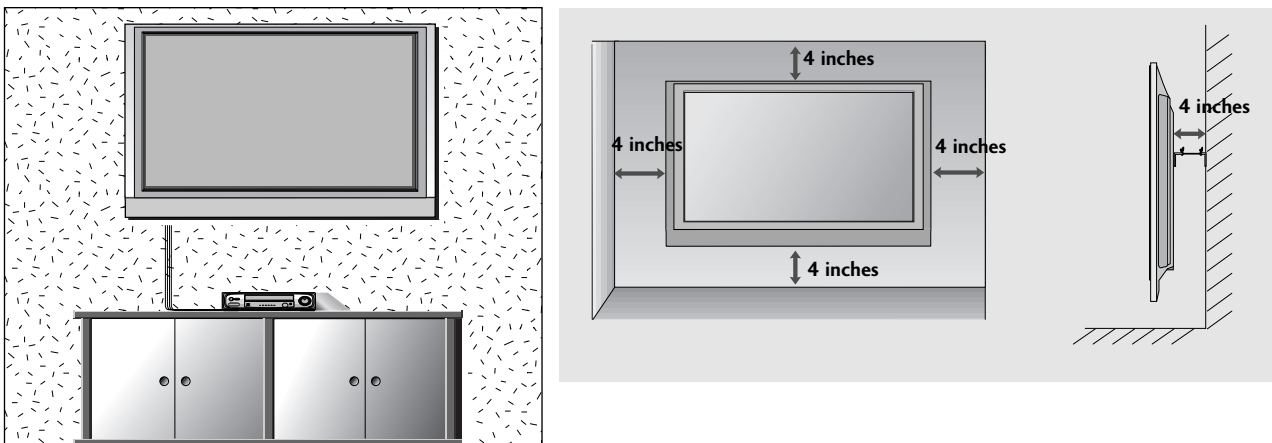

PREPARATION

- To prevent damage do not connect to the mains outlet until all connections are made between the devices.

ANTENNA CONNECTION

- For optimum picture quality, adjust antenna direction.
- An antenna cable and converter are not supplied.

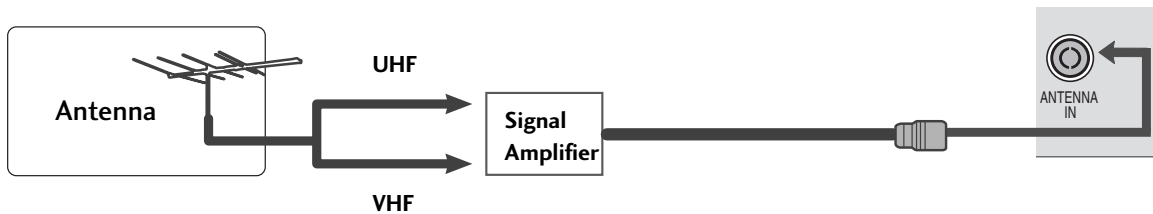
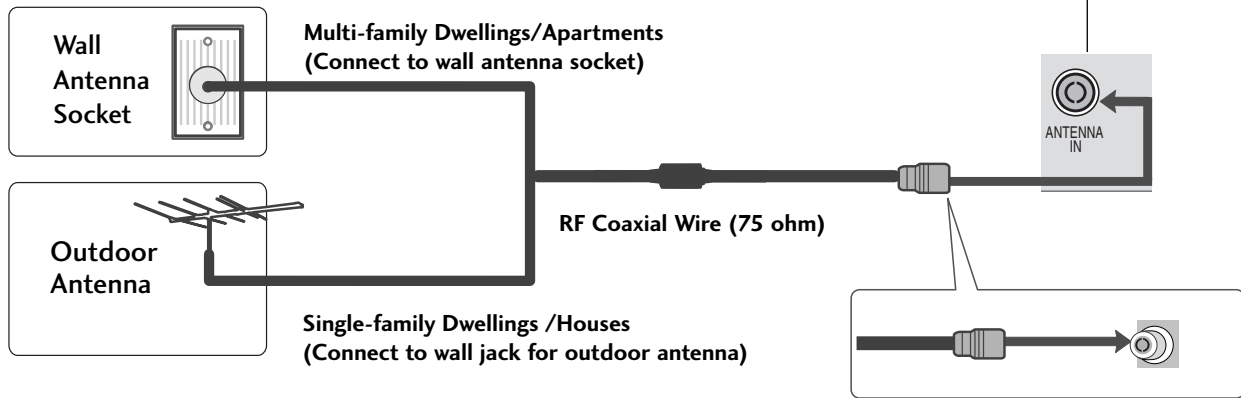
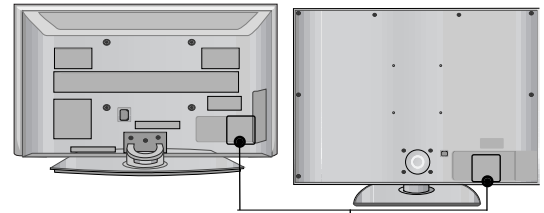

- In poor signal areas, to achieve better picture quality it may be necessary to install a signal amplifier to the antenna as shown above.
- If signal needs to be split for two TVs, use an antenna signal splitter for connection.

EXTERNAL EQUIPMENT SETUP

- To avoid damaging any equipment, never plug in any power cords until you have finished connecting all equipment.
- This section on EXTERNAL EQUIPMENT SETUP mainly uses diagrams for the 42/50/60PG6*** models.
- Image shown may differ from your TV.

HD RECEIVER SETUP

Connecting with a component cable

- 1 Connect the video outputs (Y, Pb, Pr) of the digital TV top box to the **COMPONENT IN VIDEO** jacks on the TV.
- 2 Connect the audio output of the digital set-top box to the **COMPONENT IN AUDIO** jacks on the TV.
- 3 Turn on the digital set-top box.
(Refer to the owner's manual for the digital set-top box.)
- 4 Select **Component1** input source using the **INPUT** button on the remote control.
If connected to **COMPONENT IN 2**, select **Component2** input source.

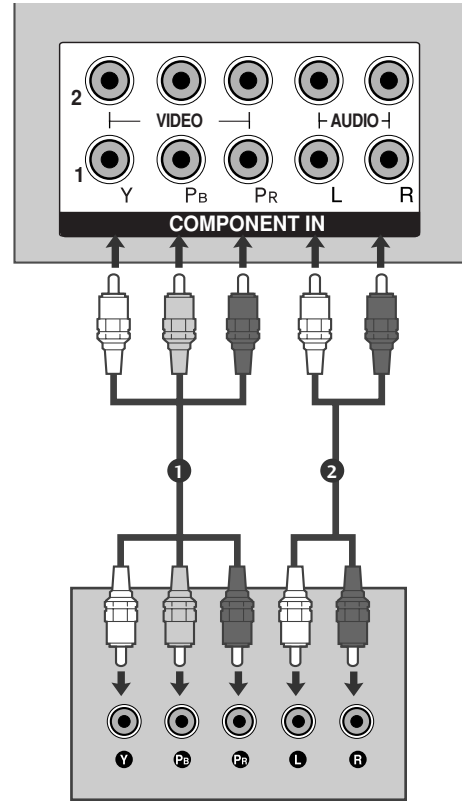

Signal	Component	HDMI1/DVI, HDMI2, HDMI3 (except 32/37LG6***, 32/42LG8***)
480i/576i	Yes	No
480p/576p	Yes	Yes
720p/1080i	Yes	Yes
1080p	Yes (50Hz, 60Hz only)	Yes (24Hz, 30Hz, 50Hz, 60Hz)

EXTERNAL EQUIPMENT SETUP

Connecting a set-top box with an HDMI cable

- 1 Connect the HDMI output of the digital set-top box to the **HDMI/DVI IN 1**, **HDMI IN 2** or **HDMI IN 3** (except 32/37LG6***, 32/42LG8***) jack on the TV.
- 2 Select **HDMI1/DVI**, **HDMI2** or **HDMI3** (except 32/37LG6***, 32/42LG8***) input source using the **INPUT** button on the remote control.
- 3 Turn on the digital set-top box.
(Refer to the owner's manual for the digital set-top box.)

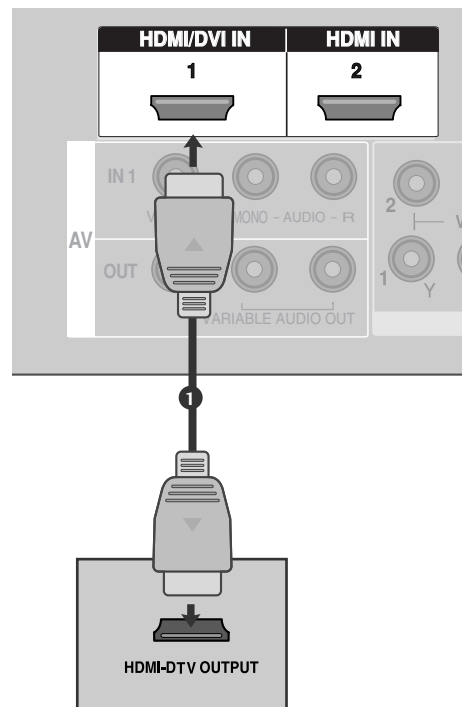

! NOTE

- ▶ TV can receive the video and audio signal simultaneously with using a HDMI cable.
- ▶ If the digital set-top box supports Auto HDMI function, the output resolution of the source device will be automatically TV to 1280x720p.
- ▶ If the digital set-top box player does not support Auto HDMI, you need to TV the output resolution appropriately.

To get the best picture quality, adjust the output resolution of the source device to 1280x720p.
(42/47LG6***, 42/47/52LG7***, 50PG3***, 50/60PG7***, 32/42LG80F* : 1920x1080i/1080p)

Connecting with a HDMI to DVI cable

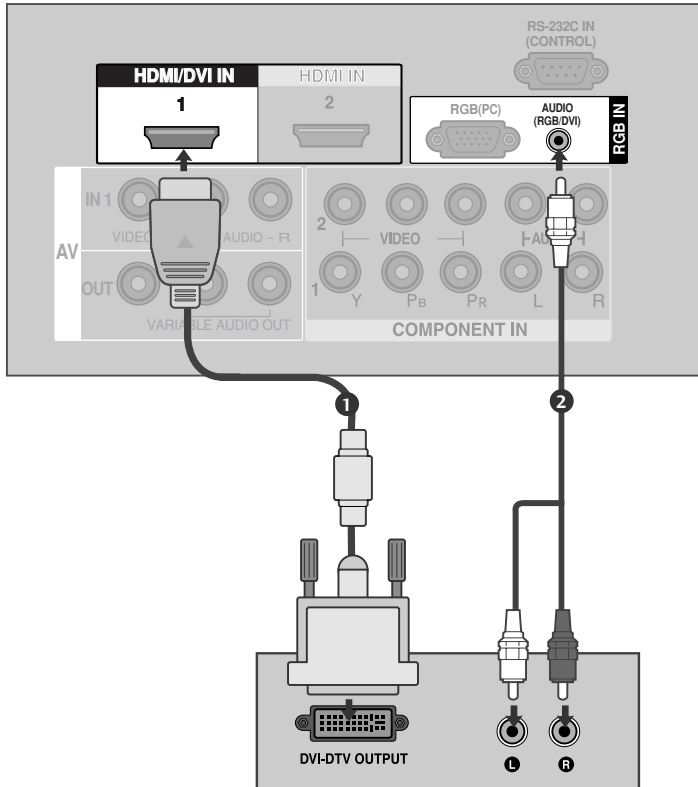

- 1 Connect the DVI output of the digital set-top box to the **HDMI/DVI IN 1** jack on the TV.
.....
- 2 Connect the audio output of the digital set-top box to the **AUDIO (RGB/DVI)** jack on the TV.
.....
- 3 Turn on the digital set-top box. (Refer to the owner's manual for the digital set-top box.)
.....
- 4 Select **HDMI1/DVI** input source using the **INPUT** button on the remote control.

! NOTE

- ▶ HDMI2, HDMI3 (except 32/37LG6***, 32/42LG8***) source does not support DVI source.
- ▶ If the set-top box has a DVI output and no HDMI output, a separated audio connection is necessary.
- ▶ If the set-top box does not support Auto DVI, you need to set the output resolution appropriately.

EXTERNAL EQUIPMENT SETUP

DVD SETUP

Connecting with a component cable

- 1 Connect the video outputs (Y, PB, PR) of the DVD to the **COMPONENT IN VIDEO** jacks on the TV.
- 2 Connect the audio outputs of the DVD to the **COMPONENT IN AUDIO** jacks on the TV.
- 3 Turn on the DVD player, insert a DVD.
- 4 Select **Component1** input source using the **INPUT** button on the remote control.
If connected to **COMPONENT IN 2**, select **Component 2** input source.
- 5 Refer to the DVD player's manual for operating instructions.

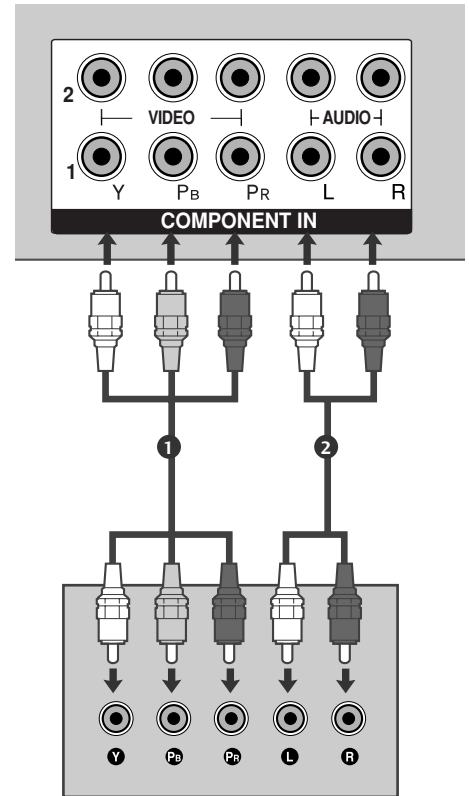

Component Input ports

To achieve better picture quality, connect a DVD player to the component input ports as shown below.

Component ports on the TV	Y	P _B	P _R
Video output ports on DVD player	Y	P _B	P _R
	Y	B-Y	R-Y
	Y	C _b	C _r
	Y	P _b	P _r

Connecting with a S-Video cable

- 1 Connect the S-VIDEO output of the DVD to the **S-VIDEO** input on the TV.
- 2 Connect the audio outputs of the DVD to the **AUDIO** input jacks on the TV.
- 3 Turn on the DVD player, insert a DVD.
- 4 Select **AV2** input source using the **INPUT** button on the remote control.
- 5 Refer to the DVD player's manual for operating instructions.

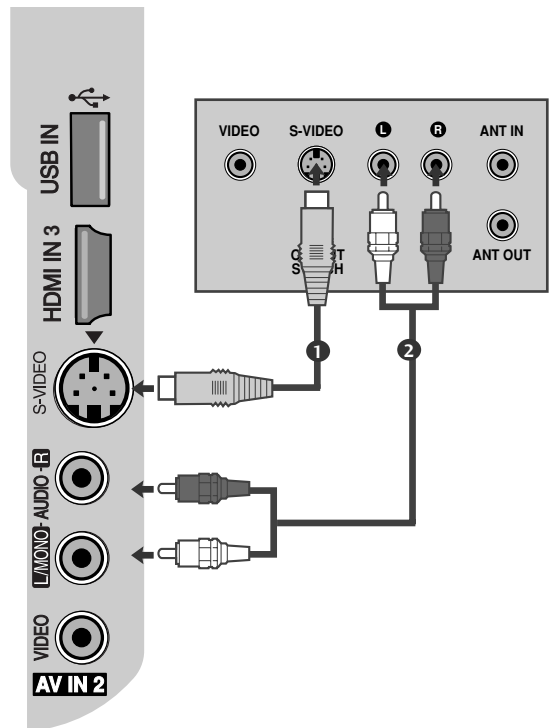

EXTERNAL EQUIPMENT SETUP

Connecting with a HDMI cable

- 1 Connect the HDMI output of the DVD to the **HDMI/DVI IN 1**, **HDMI IN 2** or **HDMI IN 3** (except 32/37LG6***, 32/42LG8***) jack on the TV.
- 2 Select **HDMI1/DVI**, **HDMI2** or **HDMI3** (except 32/37LG6***, 32/42LG8***) input source using the **INPUT** button on the remote control.
- 3 Refer to the DVD player's manual for operating instructions.

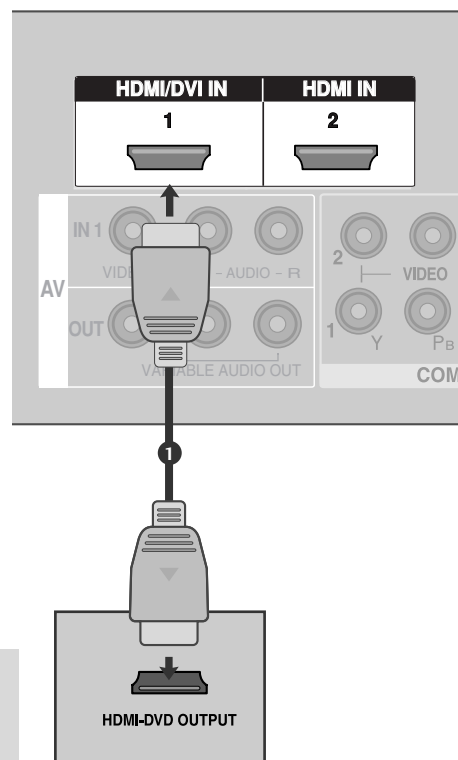

! NOTE

- ▶ The TV can receive video and audio signals simultaneously when using a HDMI cable.
- ▶ If the DVD player supports Auto HDMI function, the output resolution of the source device will be automatically TV to 1280x720p.
- ▶ If the DVD player does not support Auto HDMI, you must TV the output resolution appropriately.

To get the best picture quality, adjust the output resolution of the source device to 1280x720p.

(42/47LG6***, 42/47/52LG7***, 50PG3***, 50/60PG7***, 32/42LG80F* : 1920x1080i/1080p)

VCR SETUP

- To avoid picture noise (interference), allow adequate distance between the VCR and TV.
- Typically a frozen still picture from a VCR. If 4:3 picture format is used for an extended period the fixed images on the sides of the screen may remain visible.

Connecting with a RF cable

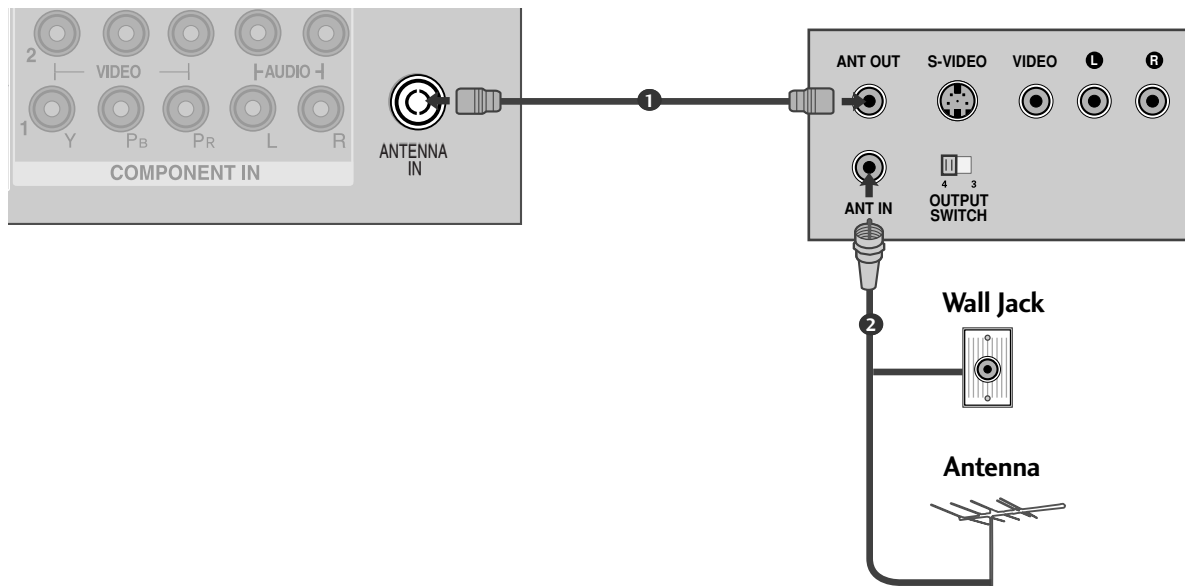

- 1 Connect the **ANT OUT** socket of the VCR to the **ANTENNA IN** socket on the TV.
.....
- 2 Connect the antenna cable to the **ANT IN** socket of the VCR.
.....
- 3 Press the **PLAY** button on the VCR and match the appropriate programme between the TV and VCR for viewing.
.....

EXTERNAL EQUIPMENT SETUP

Connecting with a RCA cable

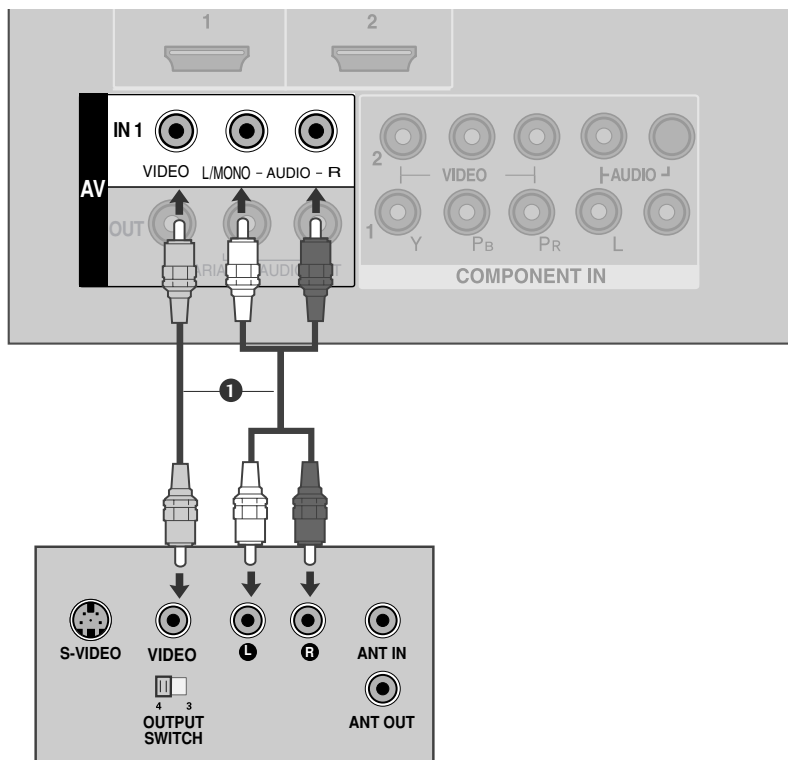

- 1 Connect the **AUDIO/VIDEO** jacks between TV and VCR. Match the jack colours (Video = yellow, Audio Left = white, and Audio Right = red)
- 2 Insert a video tape into the VCR and press PLAY on the VCR. (Refer to the VCR owner's manual.)
- 3 Select **AV1** input source using the **INPUT** button on the remote control. If connected to **AV IN 2**, select **AV2** input source.

! NOTE

- ▶ If you have a mono VCR, connect the audio cable from the VCR to the **AUDIO L/MONO** jack of the TV.

Connecting with a S-Video cable

- 1 Connect the S-VIDEO output of the VCR to the **S-VIDEO** input on the TV. The picture quality is improved; compared to normal composite (RCA cable) input.
- 2 Connect the audio outputs of the VCR to the **AUDIO** input jacks on the TV.
- 3 Insert a video tape into the VCR and press **PLAY** on the VCR. (Refer to the VCR owner's manual.)
- 4 Select **AV2** input source using the **INPUT** button on the remote control.

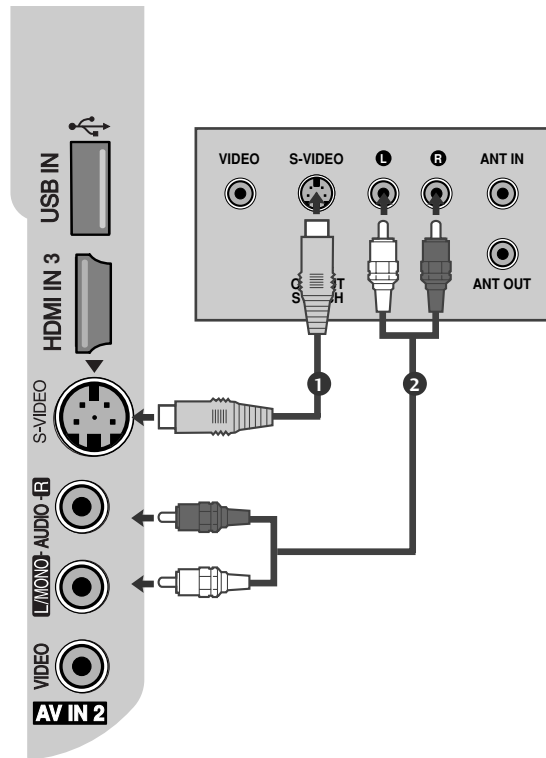

! NOTE

- ▶ If both S-VIDEO and VIDEO sockets have been connected to the S-VHS VCR simultaneously, only the S-VIDEO can be received.

EXTERNAL EQUIPMENT SETUP

OTHER A/V SOURCE SETUP

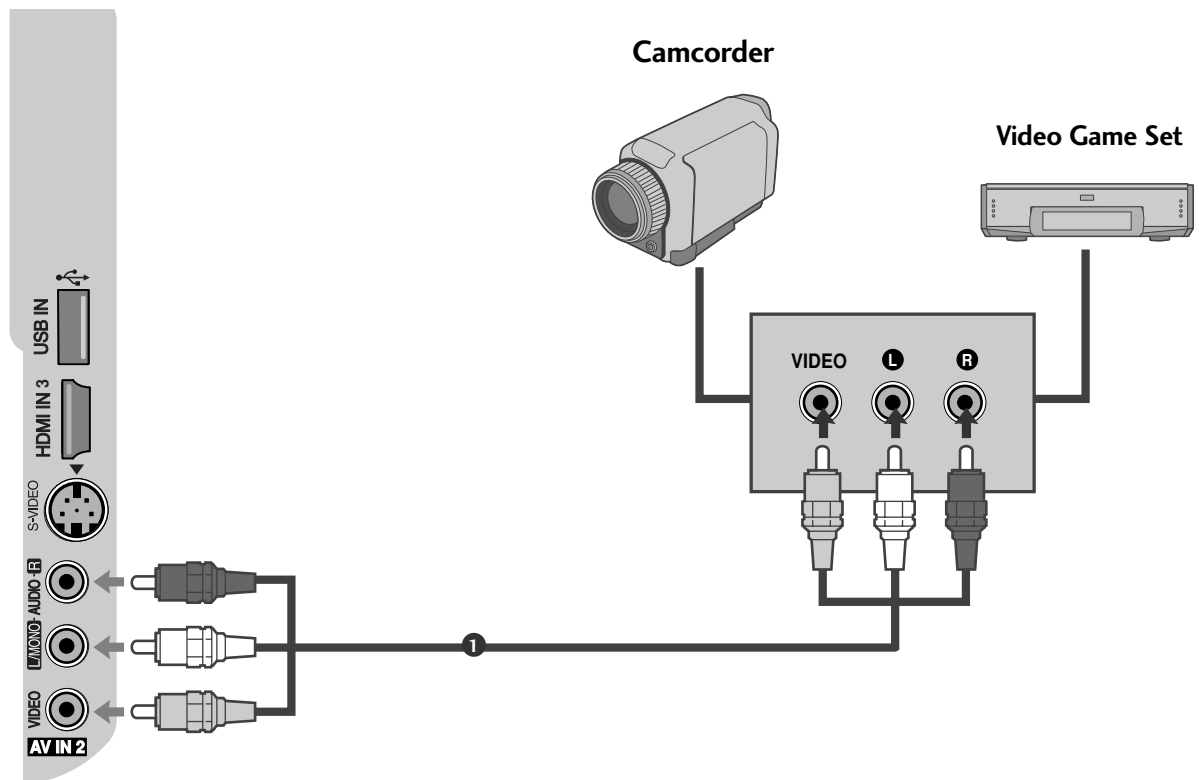

- 1 Connect the **AUDIO/VIDEO** jacks between TV and external equipment. Match the jack colours. (Video = yellow, Audio Left = white, and Audio Right = red)
- 2 Select **AV2** input source using the **INPUT** button on the remote control. If connected to **AV IN 1**, select **AV1** input source.
- 3 Operate the corresponding external equipment. Refer to external equipment operating guide.

EXTERNAL STEREO SETUP

Use to connect either an external amplifier, or add a sub-woofer to your surround sound system.

- 1 Connect the input jack of the stereo amplifier to the **VARIABLE AUDIO OUT** jacks on the TV.
- 2 Set up your speakers through your analog stereo amplifier, according to the instructions provided with the amplifier.

! NOTE

- ▶ When connecting with external audio equipments, such as amplifiers or speakers, please turn the TV speakers off. (▶ p.86)
- ▶ Select **Variable Out** in **Audio** menu to connect the **VARIABLE AUDIO OUT** jacks. (▶ p.86)

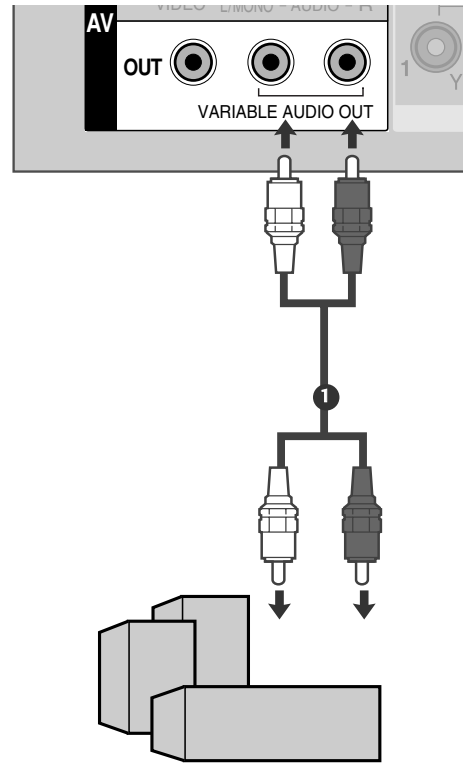

EXTERNAL EQUIPMENT SETUP

AV OUTPUT SETUP

The TV has a special signal output capability which allows you to hook up the second TV or monitor.

- 1 Connect the second TV or monitor to the TV's AV OUT jacks.
- 2 See the Operating Manual of the second TV or monitor for further details regarding that device's input settings.

NOTE

- ▶ Component, RGB, HDMI input sources cannot be used for AV out.
- ▶ We recommend to use the AV OUT jacks for VCR recording.

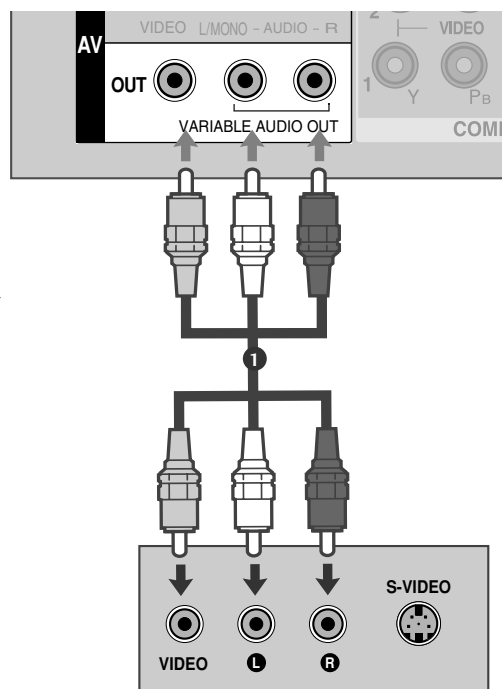

PC SETUP

This TV provides Plug and Play capability, meaning that the PC adjusts automatically to the TV's settings.

Connecting with a D-sub 15 pin cable

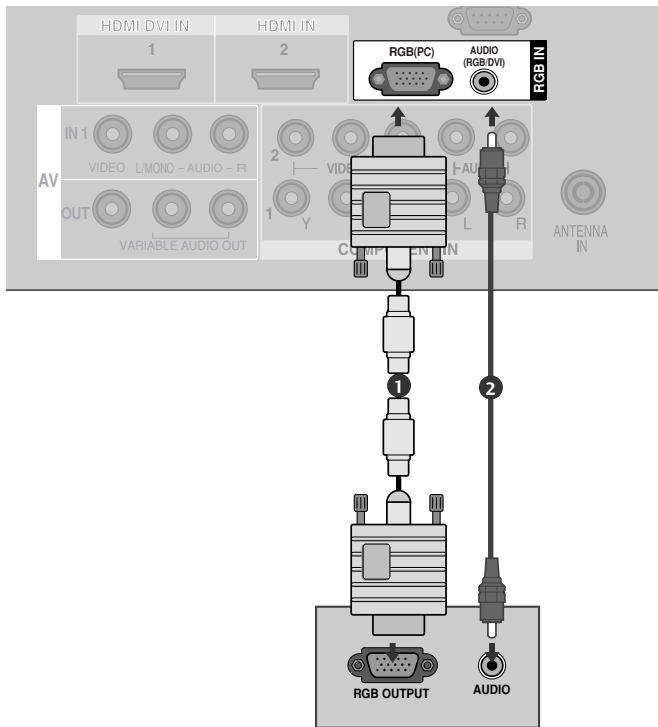

- 1 Connect the RGB output of the PC to the **RGB(PC)** jack on the TV.
.....
- 2 Connect the PC audio output to the **AUDIO (RGB/DVI)** jack on the TV.
.....
- 3 Turn on the PC and the TV.
.....
- 4 Select **RGB PC** input source using the **INPUT** button on the remote control.

EXTERNAL EQUIPMENT SETUP

! NOTE

- ▶ To enjoy vivid picture and sound, connect the PC to the TV.
- ▶ Avoid keeping a fixed image on the TV 's screen for prolonged periods of time.The fixed image may become permanently imprinted on the screen;use a screen saver when possible.
- ▶ Connect the PC to the RGB (PC) port of the TV; change the resolution output of PC accordingly.
- ▶ There may be interference relating to resolution, vertical pattern, contrast or brightness in PC mode. Change the PC mode to another resolution or change the refresh rate to another rate or adjust the brightness and contrast on the menu until the picture is clear. If the refresh rate of the PC graphic card can not be changed, change the PC graphic card or consult the manufacturer of the PC graphic card.
- ▶ The synchronization input waveform for Horizontal and Vertical frequencies are separate.
- ▶ If the resolution of PC is over SXGA, there will be no picture on the TV.(only HD Models)
- ▶ Connect the audio cable from the PC to the Audio input on the TV.(Audio cables are not included with the TV).
- ▶ If you use too long an RGB-PC cable, there may be interference on the screen. We recommend using under 5m of the cable. This provides the best picture quality.

Supported Display Resolution

Plasma TV models

RGB-PC mode

Resolution	Horizontal Frequency(kHz)	Vertical Frequency(Hz)
640x350	31.468	70.09
720x400	31.469	70.09
640x480	31.469	59.94
800x600	37.879	60.317
1024x768	48.363	60.004
1280x768	47.776	59.87
1360x768	47.720	59.799
1366x768	47.7	60
1280x1024	63.668	59.895
1920x1080	66.587	59.934

Only 50/60PG7***, 50PG3***

Only 50/60PG6***

HDMI-DTV mode

Resolution	Horizontal Frequency(kHz)	Vertical Frequency(Hz)
720x480	31.47 31.50	59.94 60.00
720x576	31.25	50.00
1280x720	44.96 45.00 37.50	59.94 60.00 50.00
1920x1080i	33.72 33.75 28.125	59.94 60.00 50.00
1920x1080p	67.432 67.5 56.250 27 33.75	59.94 60 50 24 30

LCD TV models

RGB-PC mode

Resolution	Horizontal Frequency(kHz)	Vertical Frequency(Hz)
640x350	31.468	70.09
720x400	31.469	70.09
640x480	31.469	59.94
800x600	37.879	60.317
1024x768	48.363	60.004
1280x768	47.776	59.87
1360x768	47.720	59.799
1366x768	47.7	60
1280x1024	63.668	59.895
1920x1080	66.587	59.934

Only 42/47LG6***, 42/47/52LG7***, 32/42LG80F*

HDMI-DTV mode

Resolution	Horizontal Frequency(kHz)	Vertical Frequency(Hz)
720x480	31.47 31.50	59.94 60.00
720x576	31.25	50.00
1280x720	44.96 45.00 37.50	59.94 60.00 50.00
1920x1080i	33.72 33.75 28.125	59.94 60.00 50.00
1920x1080p	67.432 67.5 56.250 27 33.75	59.94 60 50 24 30

EXTERNAL EQUIPMENT SETUP

Screen Setup for PC mode

Auto Configure (RGB [PC] mode only)

Automatically adjusts picture position and minimizes image instability. After adjustment, if the image is still not correct, your TV is functioning properly but needs further adjustment.

Auto configure

This function is for automatic adjustment of the screen position, clock, and phase. The displayed image will be unstable for a few seconds while the auto configuration is in progress.



1 Press the **MENU** button and then use \wedge/\vee button to select the **Picture** menu.

2 Press the \triangleright button and then use \wedge/\vee button to select **Screen**.

3 Press the \triangleright button and then use \wedge/\vee button to select **Auto Config..**

4 Press the \triangleright button to start **Auto Config..**

- When Auto config. has finished, OK will be shown on screen.
- If the position of the image is still not correct, try Auto adjustment again.

- If picture needs to be adjusted again after Auto adjustment in RGB (PC), you can adjust the **Manual Config..**

5 Press the **MENU** button to return to normal TV viewing. Press the **RETURN** button to move to the previous menu screen.

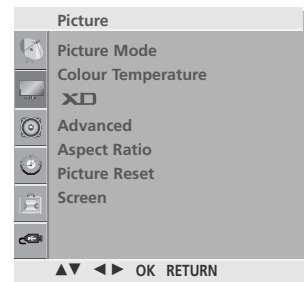

1

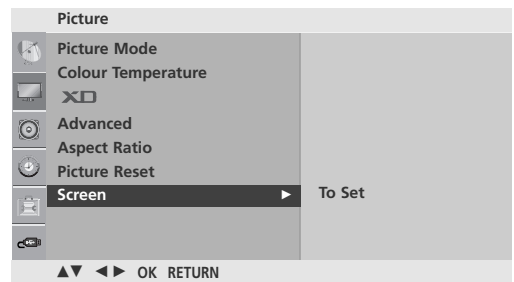

2

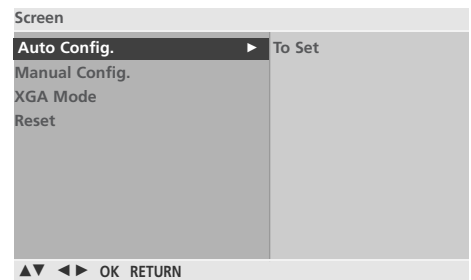

3 4

Manual Config. (RGB [PC] mode only) - Adjustment for screen Phase, Clock, Position

If the picture is not clear after auto adjustment and especially if characters are still trembling, adjust the picture phase manually.

It's not available to use Phase, Clock function in COMPONENT (480i/480p/576i/576p/720p/1080i/1080p), HDMI (480p/576p/720p/1080i/1080p).

Clock This function is to minimize any vertical bars or stripes visible on the screen background the horizontal screen size will also change.

Phase This function allows you to remove any horizontal noise and clear or sharpen the image of characters.



- 1 Press the **MENU** button and then use \wedge/\vee button to select the **Picture** menu.
- 2 Press the \triangleright button and then use \wedge/\vee button to select **Screen**.
- 3 Press the \triangleright button and then use \wedge/\vee button to select **Manual Config..**
- 4 Press the \triangleright button and then use \wedge/\vee button to select **Phase, Clock, H-Position** or **V-Position**.
- 5 Press the $\triangleleft/\triangleright$ button to make appropriate adjustments.
- 6 Press the **MENU** button to return to normal TV viewing. Press the **RETURN** button to move to the previous menu screen.

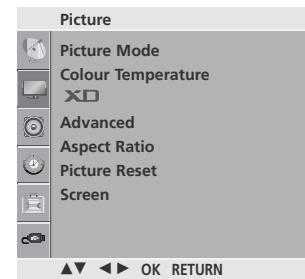

1

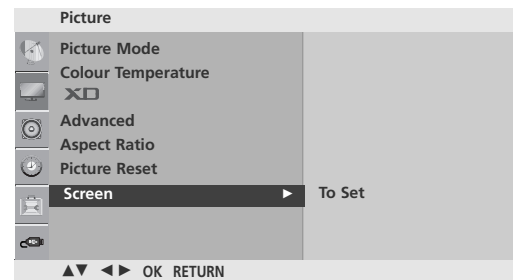

2

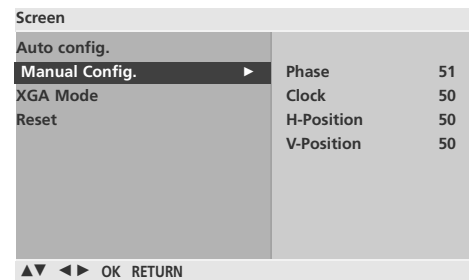

3 4 5

EXTERNAL EQUIPMENT SETUP

Selecting XGA mode (except 42PG6***)

To view a normal picture, match the resolution of RGB mode and selection of XGA mode.

This function works in the following mode: RGB[PC] mode.



- 1 Press the **MENU** button and then use \wedge/\vee button to select the **Picture** menu.
- 2 Press the \triangleright button and then use \wedge/\vee button to select **Screen**.
- 3 Press the \triangleright button and then use \wedge/\vee button to select **XGA Mode**.
- 4 Press the \triangleright button and then use \wedge/\vee button to select the desired XGA resolution.
- 5 Press the **MENU** button to return to normal TV viewing. Press the **RETURN** button to move to the previous menu screen.

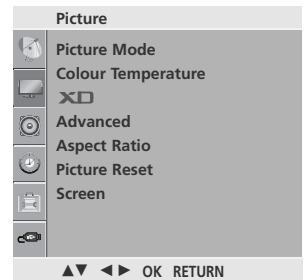

1

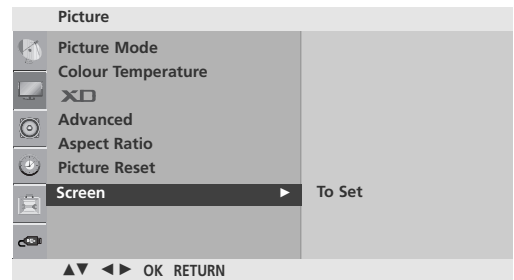

2

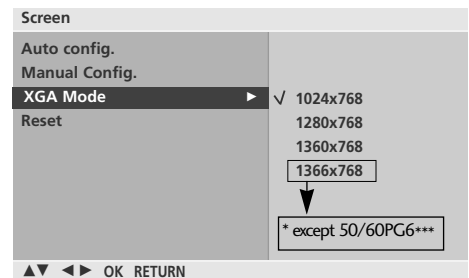

3 4

Initializing (Reset to original factory settings)

This function operates in current mode.
To initialize the adjusted value

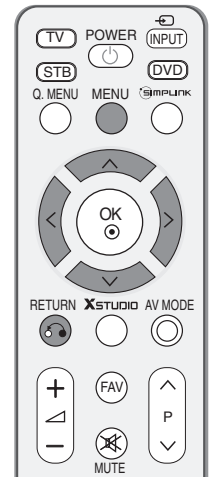

- 1 Press the **MENU** button and then use \wedge/\vee button to select the **Picture** menu.
- 2 Press the \triangleright button and then use \wedge/\vee button to select **Screen**.
- 3 Press the \triangleright button and then use \wedge/\vee button to select **Reset**.
- 4 Press the \triangleright button.
- 5 Press the **MENU** button to return to normal TV viewing.
Press the **RETURN** button to move to the previous menu screen.

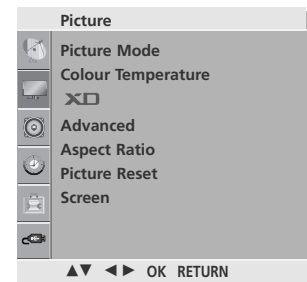

1

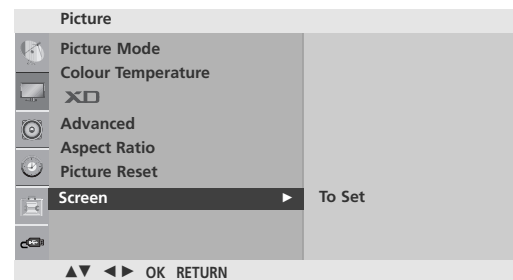

2



3 4

WATCHING TV / PROGRAMME CONTROL

REMOTE CONTROL KEY FUNCTIONS

When using the remote control, aim it at the remote control sensor on the TV.



1 **MODE** Selects the remote operating modes.

POWER Switches the TV on from standby or off to standby.

INPUT External input mode rotate in regular sequence. Switches the TV on from standby.

Q. MENU Select the desired quick menu source.

MENU Selects a menu. Clears all on-screen displays and returns to TV viewing from any menu.

SIMPLINK See a list of AV devices connected to TV. When you toggle this button, the Simplink menu appears at the screen.

RETURN Allows the user to move return one step in an interactive application or other user interaction function.

XSTUDIO Enter to the **XSTUDIO** mode.

AV MODE It helps you select and set images and sounds when connecting AV devices.

Coloured buttons These buttons are used for teletext (on **TELETEXT** models only) , **Programme edit**.

TELETEXT BUTTONS These buttons are used for teletext. For further details, see the 'Teletext' section.

PIP Switches the sub picture PIP, DW mode.



THUMBSTICK (Up/Down/Left/Right) Allows you to navigate the on-screen menus and adjust the system settings to your preference.

OK Accepts your selection or displays the current mode.

VOLUME UP /DOWN Adjusts the volume.

FAV Displays the selected favourite programme.

MUTE Switches the sound on or off.

Programme UP/DOWN Selects a programme.

0~9 number button Selects a programme. Selects numbered items in a menu.

LIST Displays the programme list.

Q.VIEW Returns to the previously viewed programme.

VCR/DVD control buttons Controls some video cassette recorders or DVD players. Control connected AV devices by pressing the ^ / v / < / > , OK buttons and buttons for ►, ■, ||, ◀◀ and ▶▶. (The ● button does not provide such functions.)

Installing Batteries

- Open the battery compartment cover on the back and install the batteries matching correct polarity (+with +,-with -).
- Install two 1.5V AAA batteries. Do not mix old or used batteries with new ones.
- Close cover.

WATCHING TV / PROGRAMME CONTROL

TURNING ON THE TV

When your TV is turned on, you will be able to use its features.

- 1 Firstly, connect the power cord correctly.
At this stage, the TV switches to standby mode.
 - In standby mode to turn TV on, press the $\phi/1$, **INPUT**, **P ▲ / ▼**(or **P ^ / v**) button on the TV or press the **POWER**, **TV**, **INPUT**, **P ^ / v** , **NUMBER(0~9)** buttons on the remote control and the TV will switch on.

Installation Guide

If the OSD (On Screen Display) is displayed on the screen after turning on the TV, you can adjust the **Language**, **Location**, **Auto Tuning**.

Note:

- a. It will automatically disappear after approx. 40 seconds unless a button is pressed.
- b. "In-Store" mode is only for shop display and not for general customer use.
- c. "Home" mode is the optimal setting for home environments, and is the TV's default mode.
- d. "In-Store" mode is the optimal setting for store environments. If a user modifies image quality data, "In-Store" mode initializes the product to the image quality set by us after a certain period of time.
- e. The mode (Home, In-Store) can be changed by executing Factory Reset in the Option menu.

PROGRAMME SELECTION

- 1 Press the **P ^ / v** or **NUMBER** buttons to select a programme number.

VOLUME ADJUSTMENT

- 1 Press the \triangle **+/-** button to adjust the volume.
- 2 If you wish to switch the sound off, press the **MUTE** button.
- 3 You can cancel the Mute function by pressing the **MUTE** or \triangle **+/-** button.

QUICK MENU

Your TV's OSD (On Screen Display) may differ slightly from that shown in this manual.

Q.Menu (Quick Menu) is a menu of features which users might use frequently.

- **Aspect Ratio:** Selects your desired picture format.
For Zoom Setting, select 14:9, Zoom1 and Zoom2 in Ratio Menu. After completing Zoom Setting, the display goes back to Q.Menu.
- **Power Saving** (only Plasma TV Models): Adjusts screen brightness to reduce the power consumption of the set.
- **Backlight** (only LCD TV Models): Adjusts screen brightness. It returns to the default settings brightness by changing mode source.
- **Picture Mode** : Selects your desired Picture Mode.
- **Sound Mode** : It is a feature to automatically set the sound combination which it deems the best for the images being watched. Selects your desired Sound Mode.
- **Multi Audio** : Selects the sound output.
- **Programme Edit** : Adjusts the stored programmes by delete, copy, move or skip.
- **Sleep Timer** : Selects the sleep timer.

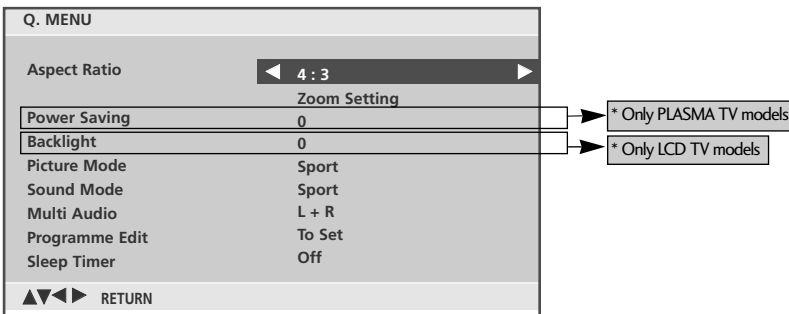
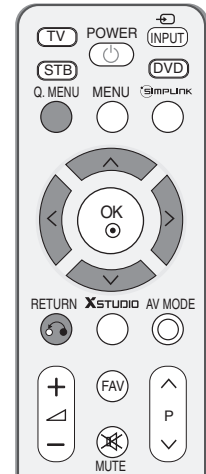

- 1 Press the **Q.MENU** button and then \wedge / \vee button to display each menu.
- 2 Press the $< / >$ button to select your desired Source.
- 3 Press the **Q.MENU** button to return to normal TV viewing.

WATCHING TV / PROGRAMME CONTROL

ON SCREEN MENUS SELECTION AND ADJUSTMENT

Your TV's OSD (On Screen Display) may differ slightly from that shown in this manual.

- 1 Press the **MENU** button and then \wedge / \vee button to display each menu.
- 2 Press the \triangleright button and then \wedge / \vee button to select a menu item.
- 3 Change the setting of an item in the sub or pull-down menu with $\triangleleft / \triangleright$ button.
You can move to a higher level menu by pressing the **OK** button.

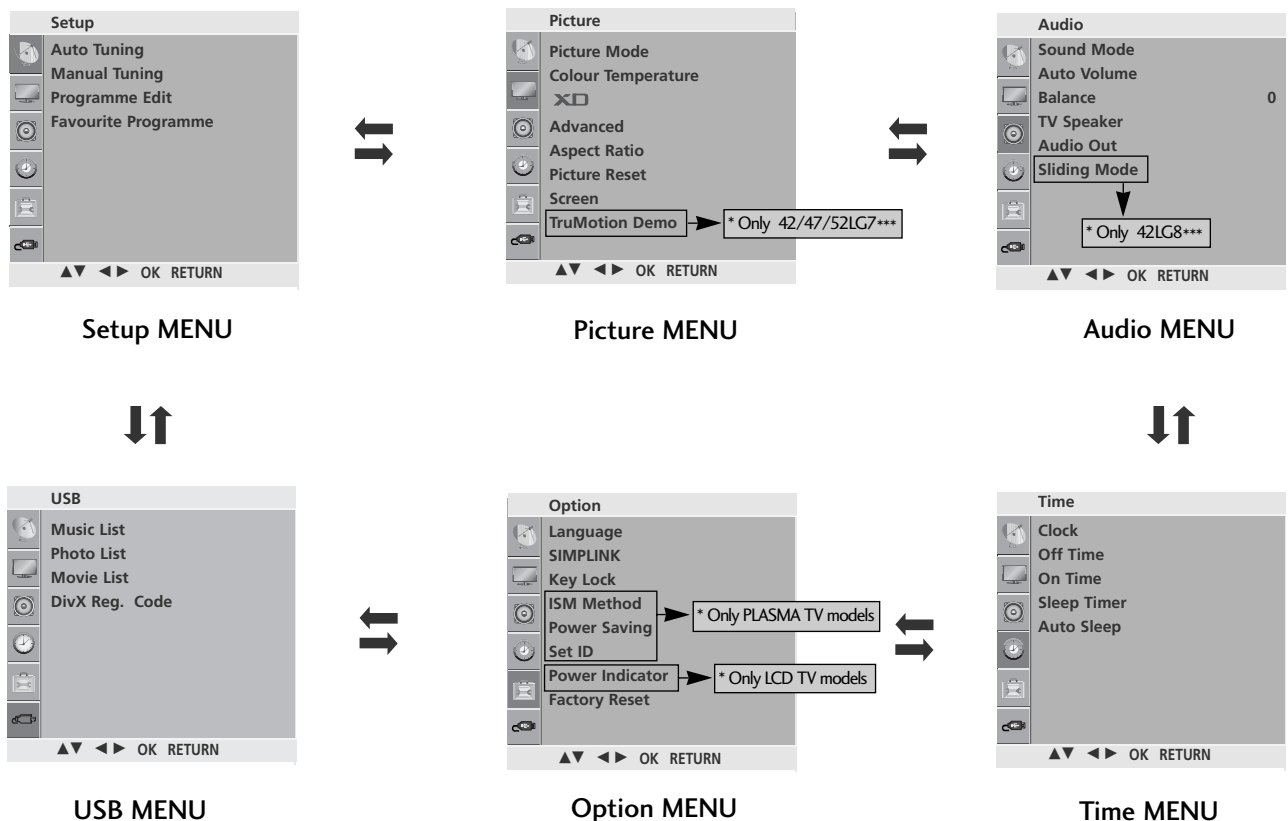

! NOTE

- The OSD (On Screen Display) function enables you to adjust the screen status conveniently since it provides graphical presentation.
- In this manual, the OSD (On Screen Display) may be different from your TV's because it is just example to help the TV operation.
- In the teletext mode and USB mode, menus are not displayed.

AUTO PROGRAMME TUNING

Up to 100 TV stations can be stored by programme numbers (0 to 99). Once you have preset the stations, you will be able to use the P \wedge / \vee or NUMBER buttons to scan the stations you have programmed. Stations can be tuned using automatic or manual modes.

All stations which can be received are stored by this method. It is recommended that you use Auto tuning during installation of this TV.

- 1 Press the **MENU** button and then \wedge / \vee button to select the **Setup** menu.
 - 2 Press the \triangleright button and then \wedge / \vee button to select **Auto Tuning**.
 - 3 Press the \triangleright button and then \wedge / \vee button to select **System**.
 - 4 Press the \wedge / \vee button to select a TV system menu;
 BG: PAL B/G, SECAM B/G (Europe / East Europe / Asia / NewZealand / M.East / Africa / Australia)
 I : PAL I/II (U.K. / Ireland / Hong Kong / South Africa)
 DK: PAL D/K, SECAM D/K (East Europe / China / Africa / CIS)
 M : (USA / Korea / Philippines)
 - 5 Press the \wedge / \vee button to select **Storage From**.
 - 6 Press the \triangleleft / \triangleright button or NUMBER buttons to select the initial programme number. If you use NUMBER buttons, any number under 10 is entered with a numeric '0' in front of it, i.e. '05' for 5.
 - 7 Press the \wedge / \vee button to select **Search**.
 - 8 Press the \triangleright button to begin auto tuning. All receivable stations are stored.
- To stop auto tuning, press the **RETURN** button.
 When auto tuning is complete, the Programme edit menu appears on the screen. See the Programme edit section to edit the stored programme.
- 9 Press the **MENU** button to return to normal TV viewing. Press the **RETURN** button to move to the previous menu screen.

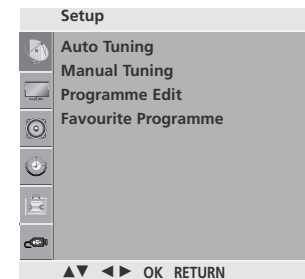
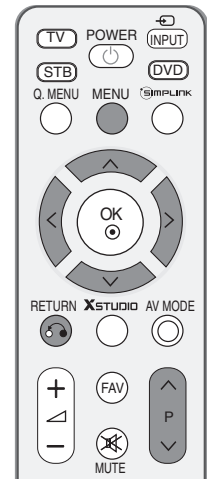

1

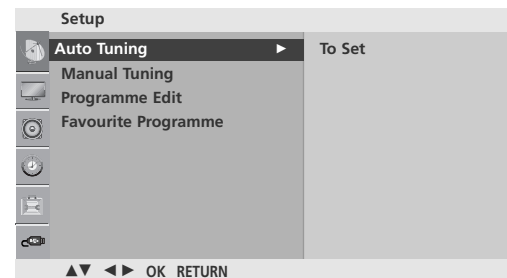

2



3 4 5 6 7

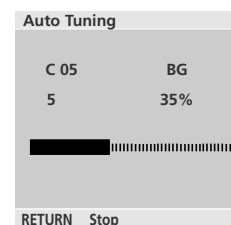

8

WATCHING TV / PROGRAMME CONTROL

MANUAL PROGRAMME TUNING

Manual programme lets you manually tune and arrange the stations in whatever order you desire.



1 Press the **MENU** button and then \wedge / \vee button to select the **Setup** menu.

2 Press the $\>$ button and then \wedge / \vee button to select **Manual Tuning**.

3 Press the $\>$ button and then \wedge / \vee button to select **Storage**.

4 Press the \lt / \gt button or NUMBER buttons to select the desired programme number (0 to 99). If you use NUMBER buttons, any number under 10 is entered with a numeric '0' in front of it, i.e. '05' for 5.

5 Press the \wedge / \vee button to select **System**.

6 Press the \wedge / \vee button to select a TV system menu;
 BG : PAL B/G, SECAM B/G (Europe / East Europe / Asia / NewZealand / M.East / Africa / Australia)
 I : PAL I/II (U.K. / Ireland / Hong Kong / South Africa)
 DK : PAL D/K, SECAM D/K (East Europe / China / Africa / CIS)
 M : (USA / Korea / Philippines)

7 Press the \wedge / \vee button to select **Band**.

8 Press the $\>$ button and then \wedge / \vee button to select **V/UHF** or **Cable**.

9 Press the \wedge / \vee button to select **Channel**.

10 You can select the desired programme number with the \lt / \gt button or NUMBER buttons. If possible, select the programme number directly with the number buttons. Any number under 10 is entered with a numeric '0' in front of it, i.e. '05' for 5.

11 Press the \wedge / \vee button to select **Search**.

12 Press the \lt / \gt button to commence searching. If a station is found the search will stop.

13 Press the **OK** button to store it.

14 To store another station, repeat steps **3** to **13**.

15 Press the **MENU** button to return to normal TV viewing.
 Press the **RETURN** button to move to the previous menu screen.

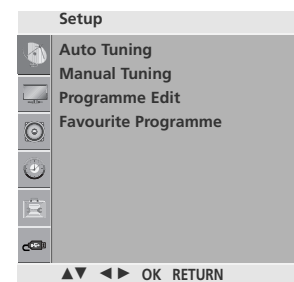

1

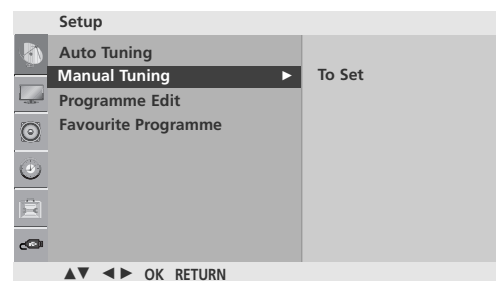

2

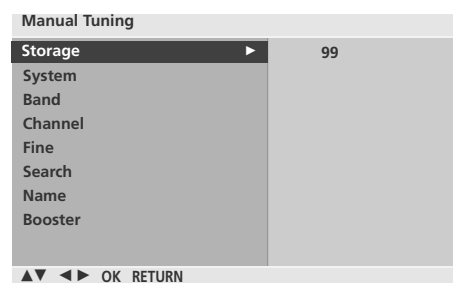

3 4 5 6 7
8 9 10 11 12

FINE TUNING

Normally fine tuning is only necessary if reception is poor.

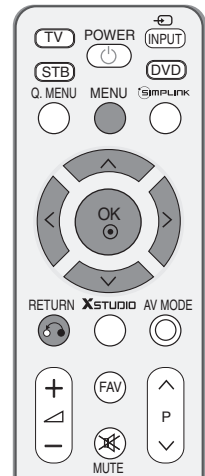

- 1 Press the **MENU** button and then \wedge / \vee button to select the **Setup** menu.

- 2 Press the \triangleright button and then \wedge / \vee button to select **Manual Tuning**.

- 3 Press the \triangleright button and then \wedge / \vee button to select **Fine**.

- 4 Press the \triangleright button and then $\triangleleft / \triangleright$ button to fine tune for the best picture and sound.

- 5 Press the **OK** button to store it.

- 6 Press the **MENU** button to return to normal TV viewing.
Press the **RETURN** button to move to the previous menu screen.

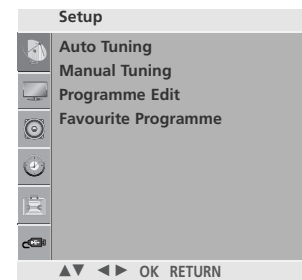

1



2



3 4 5

WATCHING TV / PROGRAMME CONTROL

ASSIGNING A STATION NAME

You can assign a station name up to five characters to each programme number.

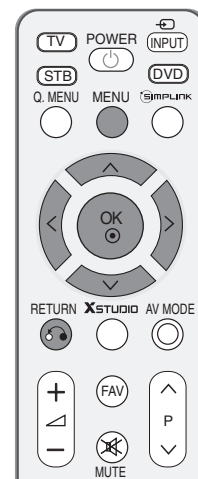

1 Press the **MENU** button and then \wedge/\vee button to select the **Setup** menu.

2 Press the \triangleright button and then \wedge/\vee button to select **Manual Tuning**.

3 Press the \triangleright button and then \wedge/\vee button to select **Name**.

4 Press the \triangleright button and then \wedge/\vee button. You can use a blank, +, -, the number 0 to 9 and the alphabet A to Z.

5 Press the $\triangleleft/\triangleright$ button to select the position and make your choice of the second character, and so on.

6 Press the **OK** button to store it.

7 Press the **MENU** button to return to normal TV viewing.
Press the **RETURN** button to move to the previous menu screen.

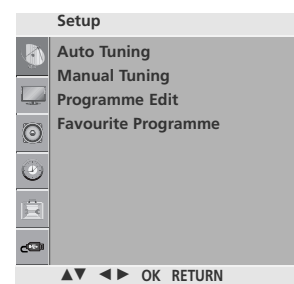

1

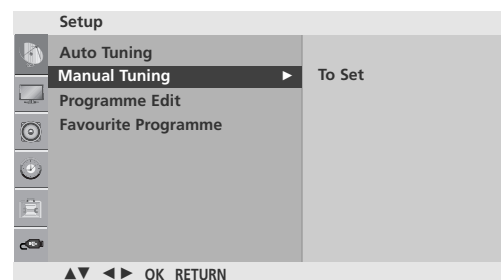

2

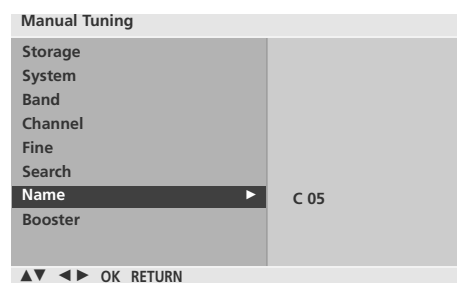

3 4 5 6

BOOSTER

In some models, **Booster** is an optional function. Only a set with **Booster** can perform this function.

If reception is poor, select **Booster** to **On**.
When the signal is strong, select "OFF".

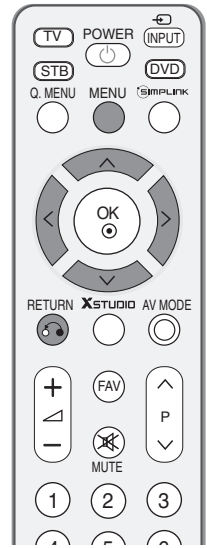

1 Press the **MENU** button and then \wedge / \vee button to select the **SETUP** menu.

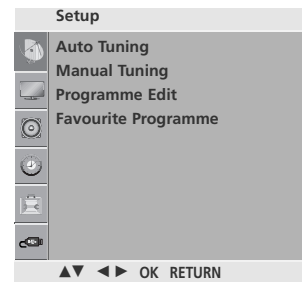

1

2 Press the \triangleright button and then \wedge / \vee button to select **Manual Tuning**.

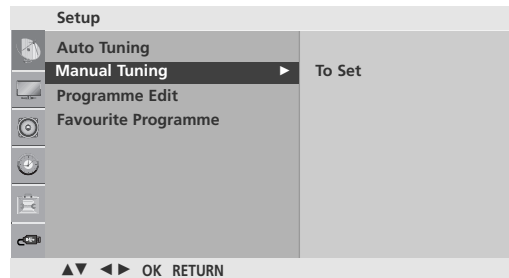

2

3 Press the \triangleright button and then use \wedge / \vee button to select **Booster**.

4 Press the \triangleright button and then use $\triangleleft / \triangleright$ button to select **On** or **Off**.



3 4

5 Press the **MENU** button to return to normal TV viewing.
Press the **RETURN** button to move to the previous menu screen.

WATCHING TV / PROGRAMME CONTROL

PROGRAMME EDIT

This function enables you to delete or skip stored programmes. Also you can move some stations to other programme numbers or copy a blank station data into the selected programme number.

1 Press the **MENU** button and then \wedge / \vee button to select the **Setup** menu.

2 Press the \triangleright button and then \wedge / \vee button to select **Programme Edit**.

3 Press the \triangleright button to display the Programme edit menu.

■ Deleting a programme

1. Select a programme to be deleted with the $\wedge / \vee / \langle / \rangle$ button.

2. Press the RED button twice.

The selected programme is deleted, all the following programmes are shifted up one position.

■ Copying a programme

1. Select a programme to be copied with the $\wedge / \vee / \langle / \rangle$ button.

2. Press the GREEN button.

All the following programmes are shifted down one position.

■ Moving a programme

1. Select a programme to be moved with the $\wedge / \vee / \langle / \rangle$ button.

2. Press the YELLOW button.

3. Move the programme to the desired programme number with the $\wedge / \vee / \langle / \rangle$ button.

4. Press the YELLOW button again to release this function.

■ Skipping a programme number

1. Select a programme number to be skipped with the $\wedge / \vee / \langle / \rangle$ button.

2. Press the BLUE button. The skipped programme turns to blue.

3. Press the BLUE button again to release the skipped programme.

When a programme number is skipped it means that you will be unable to select it using the \wedge / \vee button during normal TV viewing. If you wish to select the skipped programme, directly enter the programme number with the NUMBER buttons or select it in the programme edit or table menu.

4 Press the **MENU** button to return to normal TV viewing. Press the **RETURN** button to move to the previous menu screen.

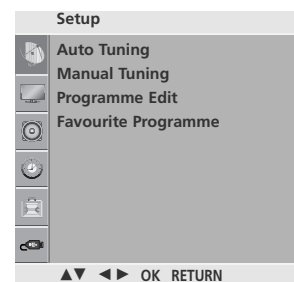
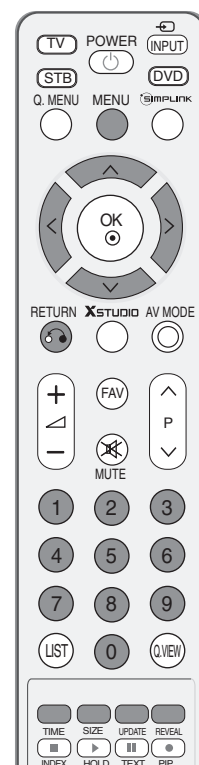

1

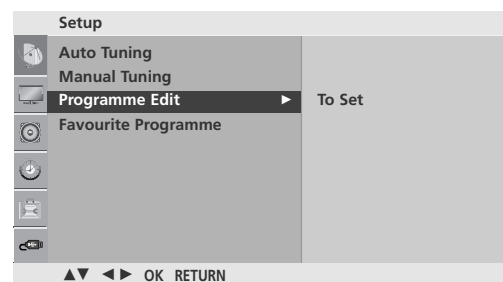

2

Programme Edit			
0	C	03	5 S 69
1	BLN	03	6 S 17
2	C	12	7 S 22
3	S	66	8 C 09
4	S	67	9 C 11

● Delete ● Copy
● Move ● Skip

3

FAVOURITE PROGRAMME

This function lets you select your favourite programmes directly.

Repeatedly press the FAV button to select stored favourite programmes.

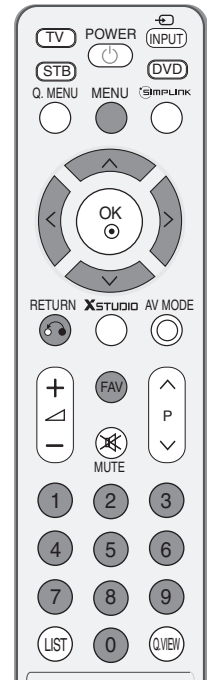

1 Press the **MENU** button and then \wedge / \vee button to select the **Setup** menu.

2 Press the \triangleright button and then \wedge / \vee button to select **Favourite Programme**.

3 Press the \triangleright button.

4 Press the \wedge / \vee button to select - - - - -.

5 Select a desired programme with the $\triangleleft / \triangleright$ button or **NUMBER** buttons. Any number under 10 is entered with a numeric '0' in front of it, i.e. '05' for 5.

6 To store another programme, repeat steps **4** to **5**. You can store up to 8 programmes.

7 Press the **MENU** button to return to normal TV viewing. Press the **RETURN** button to move to the previous menu screen.

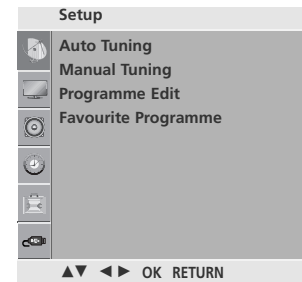

1

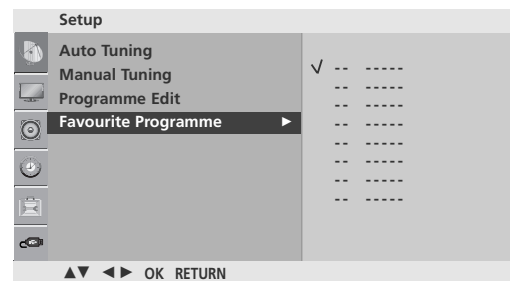

2 3 4 5

WATCHING TV / PROGRAMME CONTROL

SELECTING THE PROGRAMME LIST

You can check which programmes are stored in the memory by displaying the programme list.

■ Displaying programme list

Press the **LIST** button to display the Programme list menu.

The programme list appears on the screen.

One programme list contains ten programmes as shown.

! NOTE

- You may find some blue programmes. They have been set up to be skipped by auto programming or in the programme edit mode.
- Some programmes with the channel number shown in the programme list indicate there is no station name assigned.

■ Selecting a programme in the programme list

Select a programme with the $\wedge / \vee / \lt / \gt$ button.

Then press the **OK** button. The TV switches to the chosen programme number.

■ Paging through a programme list

There are 10 programme table pages in which contain 100 programmes. Pressing the $\wedge / \vee / \lt / \gt$ button repeatedly turns the pages.

Press the **LIST** button to return to normal TV viewing.



Programme List			
0	C	03	5 S 69
1	BLN	03	6 S 17
2	C	12	7 S 22
3	S	66	8 C 09
4	S	67	9 C 11



This function operates only with devices with the SIMPLINK logo.
Please check the SIMPLINK logo.

The product might not function properly when using it with other products with HDMI-CEC function.

This allows you to control and play other AV devices connected to the display through HDMI cable without additional cables and settings.

If you do not require the SIMPLINK menu, select "Off".

- 1 Press the **MENU** button and then \wedge / \vee button to select the **Option** menu.
- 2 Press the \triangleright button and then \wedge / \vee button to select **SIMPLINK**.
- 3 Press the \triangleright button and then \wedge / \vee button to select **On** or **Off**.
- 4 Press the **MENU** button to return to normal TV viewing.
Press the **RETURN** button to move to the previous menu screen.

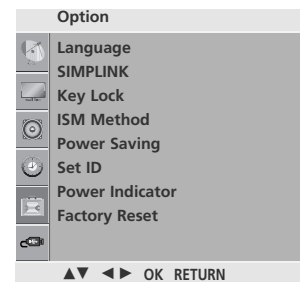

1

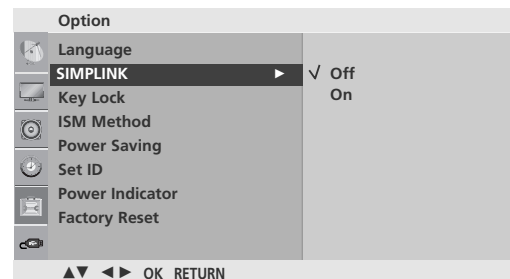

2 3

WATCHING TV / PROGRAMME CONTROL

SIMPLINK Functions

Disc playback

Control connected AV devices by pressing the $\wedge / \vee / < / >$, OK, \blacktriangleright , \blacksquare , I I , \blacktriangleleft and \blacktriangleright buttons. (The \bullet button does not provide such functions)

Direct Play

After connecting AV devices to the TV, you can directly control the devices and play media without additional settings.

Select AV device

Enables you to select one of the AV devices connected to the TV and operate it.

Power off all devices

When you switch off the TV, all connected devices are turned off.

Switch audio-out

Offers an easy way to switch audio-out.

Sync Power On

The television set will change automatically to turn on mode, after the Player with Simplink function start to reproduce through connection HDMI.

*** A device, which is connected to the TV through a HDMI cable but does not support SIMPLINK, does not provide this function.**

SIMPLINK Menu

Press the $\wedge / \vee / < / >$ button and then OK button to select the desired SIMPLINK source.

- 1 **TV viewing** : Switch to the previous TV programme regardless of the current mode.
- 2 **DISC playback** : Select and play discs. When multiple discs are available, the titles of the discs are conveniently displayed at the bottom of the screen.
- 3 **VCR playback** : Control the connected VCR.
- 4 **HDD Recordings playback** : Control recordings stored in HDD.
- 5 **Audio Out to Home theater/Audio Out to TV** : Select Home theater or TV speaker for Audio Out.

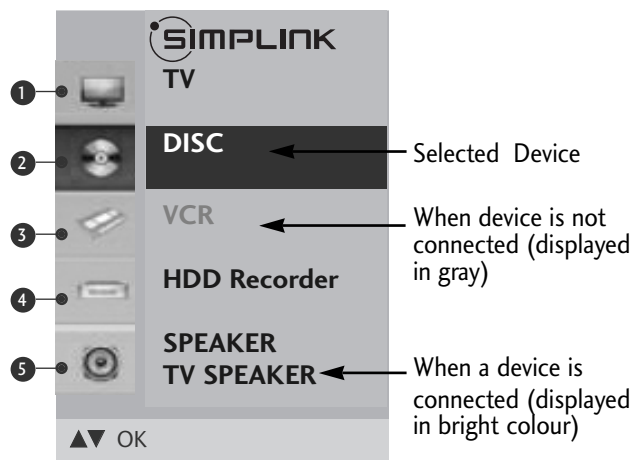

! NOTE

- ▶ Connect the HDMI/DVI IN or HDMI IN terminal of the TV to the rear terminal and Side terminal (HDMI terminal) of the SIMPLINK device with the HDMI cable.
- ▶ After connecting the HDMI terminal for the home theatre with SIMPLINK function using the above method, connect the VARIABLE AUDIO OUT terminal on the back of the TV to the VARIABLE AUDIO OUT terminal on the back of the SIMPLINK device with the VARIABLE AUDIO OUT cable.
- ▶ When operating an external device with SIMPLINK, press the TV button from the MODE button on the remote control.
- ▶ When you switch the Input source using the INPUT button on the remote control, you can stop the operation of a device controlled by SIMPLINK.
- ▶ When you select or operate a media device with home theatre function, the speaker automatically switches to home theatre speaker (HT speaker).

KEY LOCK

The TV can be set so that the remote control is needed to control it.

This feature can be used to prevent unauthorized viewing.

This TV is programmed to remember which option it was last set to even if you turn the TV off.

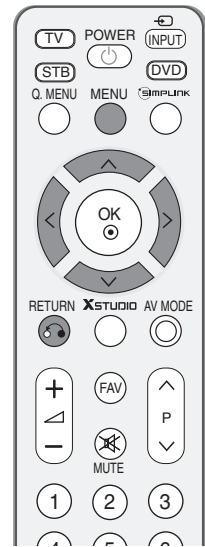

- 1 Press the **MENU** button and then \wedge/\vee button to select the **Option** menu.
- 2 Press the \triangleright button and then \wedge/\vee button to select **Key Lock**.
- 3 Press the \triangleright button and then \wedge/\vee button to select **On** or **Off**.
- 4 Press the **MENU** button to return to normal TV viewing. Press the **RETURN** button to move to the previous menu screen.

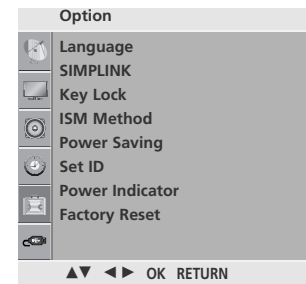

1

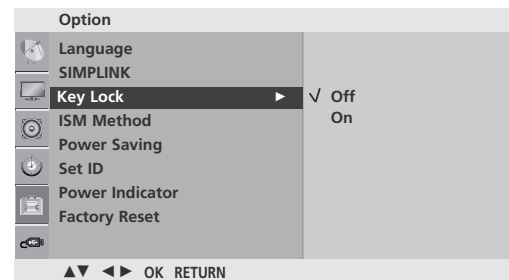

2 3

! NOTE

- ▶ In **Key Lock 'On'**, if the TV is turned off, press the ⏻ / **I**, **INPUT**, **P** \blacktriangle / \blacktriangledown (or **P** \wedge/\vee) button on the TV or **POWER**, **INPUT**, **TV**, **P** \wedge/\vee or **NUMBER** buttons on the remote control.
- ▶ With the **Key Lock On**, the display 'Key Lock On' appears on the screen if any button on the front panel is pressed while viewing the TV.

WATCHING TV / PROGRAMME CONTROL

AV MODE

You can select the optimal images and sounds when connecting AV devices to external input.

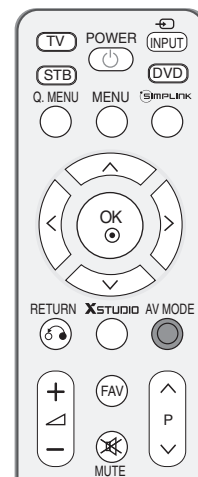
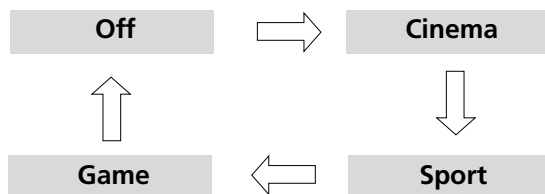

1 Press the **AV MODE** button repeatedly to select the desired source.

- If you select Cinema Mode in AV mode, Cinema mode will be selected both for Picture Mode and Sound Mode in PICTURE menu and AUDIO menu respectively.

- If you select "Off" in AV mode, the picture and image which you initially set will be selected.

2 Press the **RETURN** button to return to normal TV viewing.

TO USE THE USB DEVICE

When connecting the USB device

When you connect a USB device, this screen is displayed, automatically.

In USB device, you can not add a new folder or delete the existing folder.

- 1 Connect the USB device to the **USB IN** jacks on the side of TV.
- 2 Press the **XSTUDIO** button.
- 3 Press the **< / >** button to select the desired item.
- 4 Press the **OK** button.

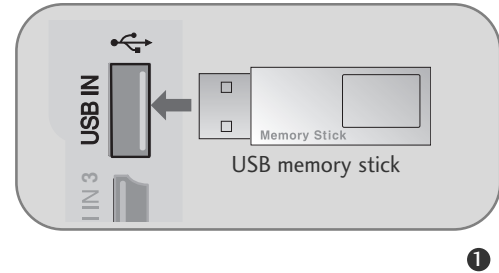

Manufactured under license from Dolby Laboratories. "Dolby" and the double-D symbol are trademarks of Dolby Laboratories.

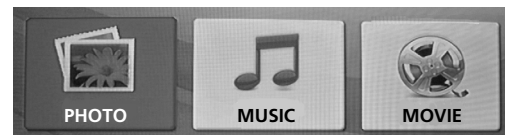

NOTE

- ▶ In USB mode, **P ▲ / ▼** (or **P ^ / v**), **◀ / ▶** +/- buttons on the TV are used to navigate (up/down/left/right).

Precautions when using the USB device

- ▶ Only a USB storage device is recognizable. Digital camera and mobile phone are not supported.
- ▶ If the USB storage device is connected through a USB hub, the device is not recognizable.
- ▶ A USB storage device using an automatic recognition programme may not be recognized.
- ▶ A USB storage device which uses its own driver may not be recognized.
- ▶ In case of a card reader, up to one memory cards are concurrently recognizable.
- ▶ The recognition speed of a USB storage device may depend on each device.
- ▶ Please do not turn off the TV or unplug the USB device when the connected USB storage device is working. When such device is suddenly separated or unplugged, the stored files or the USB storage device may be damaged.
- ▶ Please do not connect the USB storage device which was artificially maneuvered on the PC. The device may cause the product to malfunction or fail to be played. Never forget to use only a USB storage device which has normal music files or image files.
- ▶ Please use only a USB storage device which was formatted as a FAT32 file system provided with the Windows operating system. In case of a storage device formatted as a different utility programme which is not supported by Windows, it may not be recognized.
- ▶ Please connect power to a USB storage device which requires an external power supply. If not, the device may not be recognized.
- ▶ Please connect a USB storage device with cable is offered by USB maker. If connected with cable is not offered by USB maker or an excessively long cable, the device may not be recognized.
- ▶ Some USB storage devices may not be supported or operated smoothly.
- ▶ If the name of a folder or file is too long, it will not be displayed or recognized.
- ▶ File alignment method is based on storage order in USB storage device.
- ▶ Please backup the important file because a data of USB device may be damaged. Data management is consumer's responsibility and in consequence the manufactures does not cover the product bearing data damage.
- ▶ If the quantity of folders and files is over 1,000, it will not be displayed or recognized about exceeded files and folders.
- ▶ It is supported for only primary partition. If there is an extended partition, it is not displayed or recognized.

TO USE THE USB DEVICE

PHOTO LIST

It is available to playback only the photo file(*.jpg) in the USB device.

The On Screen Display may be different from your set. Images are an example to assist with the TV operation.

Screen Components

- 1 Slide show the selected item.
- 2 Set the time interval of the slide show.
- 3 Listen to music while viewing photos in full size.
- 4 Moves to upper level file
- 5 Corresponding buttons on the remote control

The screenshot shows the 'Photo List' screen. On the left is a 'Preview' window showing a photo of a butterfly with the filename 'JMJO03' and resolution '1366x768'. On the right is a 'List' window showing a folder hierarchy: 'Up Folder', 'KY102', 'JMJO01', 'JMJO02', and 'JMJO03'. A central control panel contains buttons for play, stop, and music. At the bottom is a navigation bar with buttons: 'Move', 'OK', 'Move Page', and 'RETURN Exit'. Numbered callouts 1-5 point to the play button, the music button, the 'Up Folder' button, the 'JMJO03' file, and the 'Move' button respectively.

Set up the menu in Full-Sized Screen

You can change the settings to display photos stored on a USB device, on a full-sized screen. Detailed operations are available on full-sized photo view screen.

- 1 Use the \wedge/\vee button to select the desired photos.
- 2 Press the **OK** button.
- 3 The selected photo is displayed in full size and show up the menu.

- ▶ \blacktriangle 90° \blacktriangledown 90° (**Rotate**) : Rotate photos.
- ▶ \blacktriangleleft **Prev** : Display the previous photo viewing.
- ▶ \blacktriangleright **Next** : Display the next photo viewing.
- ▶ \blacksquare **Stop** : Stop the viewing the photos.
- ▶ \odot **Hide** : Hide the menu on the full-sized screen.
 - To see the menu again on the full-sized screen, press OK button.

- 4 Press **RETURN** button to return to TV viewing or press **XSTUDIO** button to return to the X-STUDIO menu.
 - If JPEG Viewing is operated, it should be pressed the **XSTUDIO** button after pressing the **STOP** button.

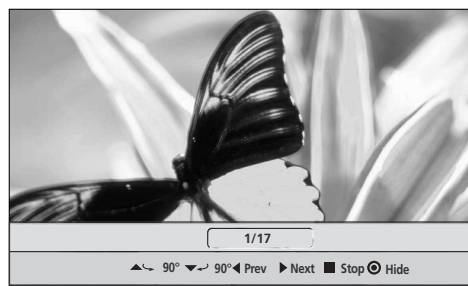



The aspect ratio of a photo may change the size of the photo displayed on the screen in full size.

* Viewing the Slide show

- 1 Use the ^/∨ button to select the desired photos.
- 2 Press the < button to select 
- 3 Press the OK button.

- ▶ Stop : Stop the viewing the slide show.
- ▶ Hide : Hide the menu on the full-sized screen.
 - To see the menu again on the full-sized screen, press OK button.

- 4 Press the < button to select 
- 5 Use < / > button to control the time interval of the slide show.
- 6 Press the OK button to store it.
- 7 Press the < button to select 
 - You should memorize FAV list to operate this function in MUSIC LIST.
- 8 Press the OK button to listen to music(BGM) while viewing photos in full size.
Set the music device and album in Option.
- 9 Press RETURN button to return to TV viewing or press XSTUDIO button to return to the X-STUDIO menu.
 - If Slideshow/BMG function is operated, it should be pressed the XSTUDIO button after pressing the STOP button.



1 2

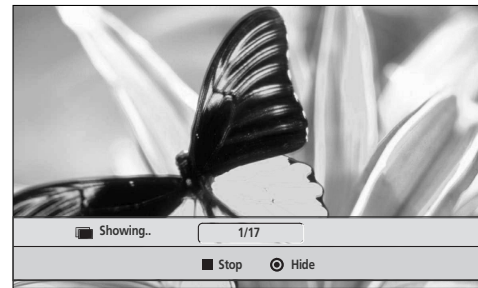

3

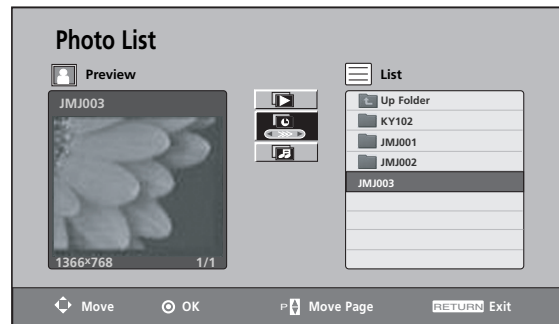

4 5 6

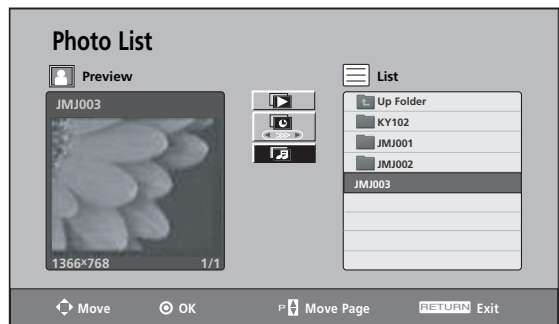

7 8

NOTE

- ▶ If it is Progressive JPEG format, some photos may be not decoded.
- ▶ If you do not press any button for 4 hours during the Slide show and BGM(Back Ground Music), it will be stopped.
- ▶ If the width of resolution is over 4800, it is not supported.
- ▶ When loading, some buttons may not work.

TO USE THE USB DEVICE

MUSIC LIST

Purchased music files(*.MP3) may contain copyright restrictions. Playback of these files may not be supported by this model.

Music file on your USB device can be played by this unit.

The On Screen Display may be different from your set. Images are an example to assist with the TV operation.

Screen Components

- ① Moves to upper level file
- ② Delete All : Delete all music in music list.
 - It is not possible to delete only one music in music list.
- ③ Corresponding buttons on the remote control

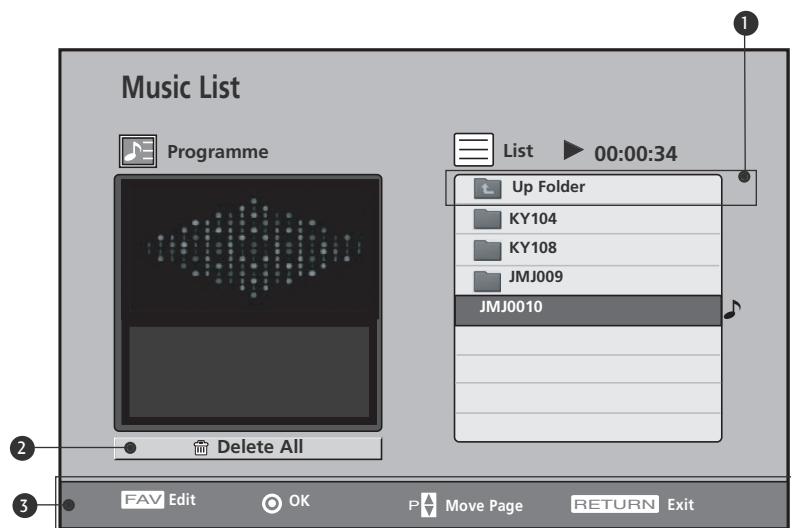

- ①
 - a. If you want to listen to music, use the \wedge / \vee button to select music.
 - b. Press the **OK** button to play the music.
 - c. All music in selected folder is played, repeatedly.
- ②
 - a. If you want to listen to several music in sequence, use the \wedge / \vee button to select music.
 - b. Press **FAV** button and then use **OK** button to make music list.
 - When **FAV** button is pressed, **e** is displayed and then it is possible to edit music list.
 - c. To make music list, repeat steps a to b.
 - d. Press \lt button and then use **OK** button to play music in music list.
 - e. Up to 30 files are stored.
- ③ Press **RETURN** button to return to TV viewing or press **XSTUDIO** button to return to the X-STUDIO menu.
 - If MP3 playing is operated, it should be pressed the **XSTUDIO** button after pressing the **STOP** button.

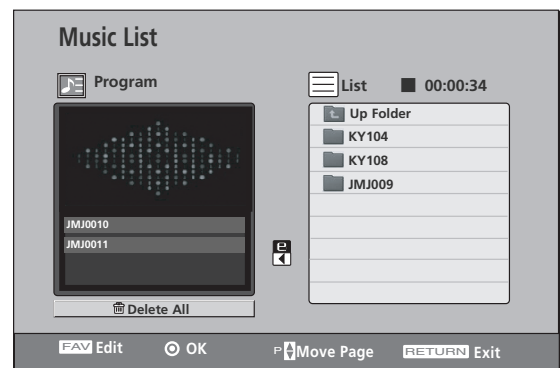

- If you don't press any button for a while during the playing, the play information box (as shown in the below) will float as a screen saver.
- The 'Screen Saver'?
Screen saver is to prevent screen pixel damage due to an fixed image remaining on the screen for a extended period of time.
- If you press **OK**, **■**, **RETURN**, **||** buttons, screen saver is stopped.



! NOTE

- ▶ When music is playing,  is displayed in Back of the music title.
- ▶ A music downloaded from a paid service with copyright protection does not start but displays inappropriate information in playtime.
- ▶ The **◀◀**, **▶▶** buttons on the remote control are not available in this mode.
- ▶ Customer should note that permission is required in order to download MP3 files form the internet, Our company has no right to quarantine such permission, Permission should always be sought from the copyright owner.
- ▶ When loading, some buttons may not work.
- ▶ MP3 files are supported as follows.
Sampling Frequency : 32 ~ 48kHz
Bit rate : 32 ~ 320kbps

TO USE THE USB DEVICE

MOVIE LIST

The movie list is activated once USB is detected. It is used when playing movie files on TV.

Displays the movies in the USB folder and supports Play.

Allows playback of all movies in the folder and user desired files.

Editing such as delete and add is not allowed.

It is a movie list that displays folder information and Divx file.

Screen Components

- 1 Moves to upper level file
- 2 Corresponding buttons on the remote control

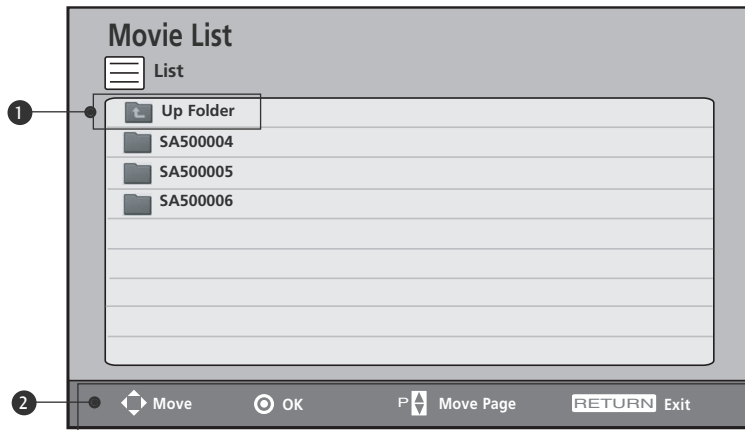

- 1 Use the $\wedge \vee$ button to select the desired movie titles.
- 2 Press the **OK** button to play the movie and show up the menu.



- ▶ **Control** : Turns the subtitle display on and off during movie play.
- ▶ **Language** : Changes the Language Group of the subtitle during movie play.
- ▶ **Position** : Changes the position of the subtitle either up or down during movie play.
- ▶ **Sync** : Adjusts the time synchronisation of the subtitle from -5 secs ~ +5 secs by steps of 1 secs during movie play.
- ▶ **ARC** : Adjusts the picture formats ; 4:3 or 16:9
 - To see the menu again on the full-sized screen, press OK button.

- 3 Press **RETURN** button to return to TV viewing or press **XSTUDIO** button to return to the X-STUDIO menu.
 - If movie playing is operated, it should be pressed the **XSTUDIO** button after pressing the STOP button.

! NOTE

- ▶ If you do not press any button for 10 minutes during Pause state, it will be stopped.
- ▶ When loading, some buttons may not work.

DivX Audio Language & Subtitle Language

- ▶ When DivX is playing, if you press the **OK** button and then select language, this message is displayed.

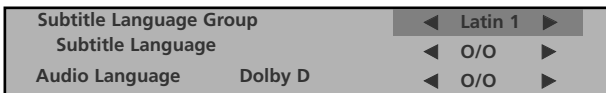

Press the $\wedge / \vee / < / >$ button to select the desired option.
 Supports up to Mpeg, Mp3, PCM, Dolby D file.

TO USE THE USB DEVICE

DIVX REGISTRATION CODE

Confirm the DivX registration code number of the TV. Using the registration number, movies can be rented or purchased at www.divx.com/vod.

With a DivX registration code from other TV, playback of rented or purchased DivX file is not allowed. (Only DivX files matched with the registration code of the purchased TV are playable.)

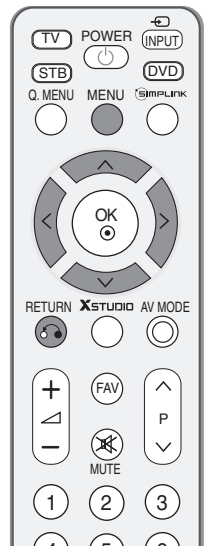

1 Press the **MENU** button and then use \wedge/\vee button to select the **USB** menu.

2 Press the \gt button and then use \wedge/\vee button to select **DivX Reg. Code**.

3 Press the \gt button to start **DivX Reg. Code**.

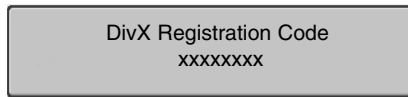

4 Press the **RETURN** button to return to normal TV viewing.

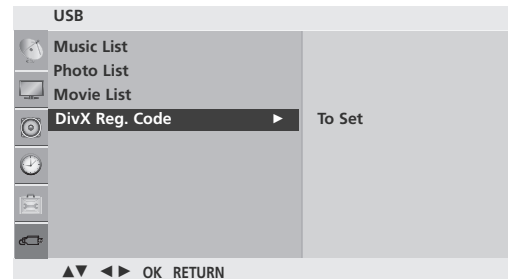

1 2 3



- Official DivX[®] Certified Product
- “Plays all versions of DivX[®] video (including DivX[®] 6) with standard playback of DivX[®] media files”
- “DivX Certified products: “DivX, DivX Certified, and associated logos are trademarks of DivX, Inc. and are used under license.”

! NOTE

- ▶ Movie files are supported as follows.
Resolution : under 720x480(720x576) WxH pixels.
Frame rate : under 30 frames/sec
- ▶ Video Codec : MP 43, DIVX_3_11, DIVX_4_12, DIVX_5_0, XVID, MP4S, RMP4, MP4V, _3IVX.

PICTURE CONTROL

WATCHING PIP(PICTURE-IN-PICTURE)

PIP lets you view 2 different inputs (sources) on your TV screen at the same time.

One source will be large, and the other source will show a smaller inset image.

PIP function is available in the Component, RGB, HDMI mode.

(For FHD models, it can support TV, AV1, AV2 mode.(except 32/42LG80F*))

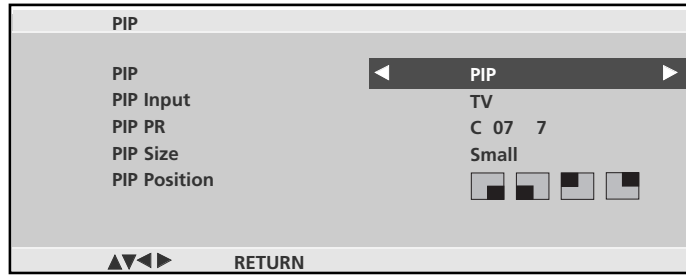

Watching PIP/Double Window

Press the **PIP** button and then press the $\wedge / \vee / \lt / \gt$ button to change the PIP options as shown below.

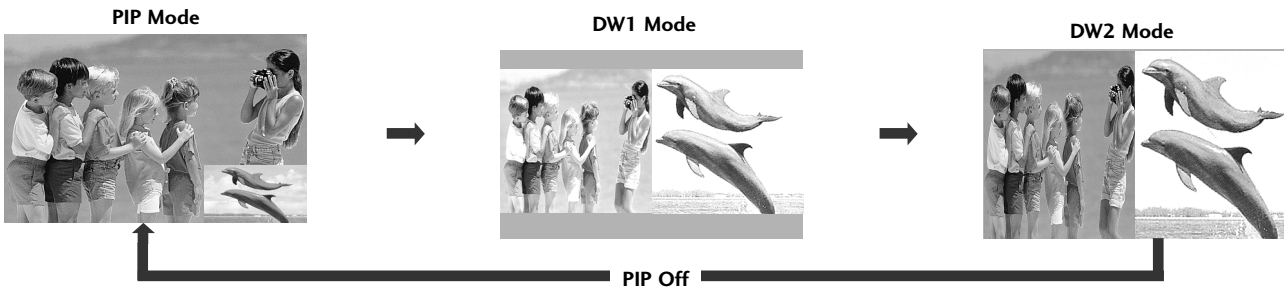

Programme Selection for Sub Picture

Press the **PIP** button and then press the $\wedge / \vee / \lt / \gt$ button to select a programme for the sub picture. The selected programme number is displayed just below the programme number of main picture.

Input Source Selection for Sub Picture

Press the **PIP** button and then press the $\wedge / \vee / \lt / \gt$ button to select the PIP Input source for the sub picture. (Sub picture can be selected only TV, AV1, AV2)

Sub Picture Size Adjustment (PIP mode only)

Press the **PIP** button and then press the $\wedge / \vee / \lt / \gt$ button to adjust the sub picture size.

Moving the Sub Picture (PIP mode only)

Press the **PIP** button and then press the $\wedge / \vee / \lt / \gt$ button to adjust the sub picture position.

PICTURE CONTROL

PICTURE SIZE (ASPECT RATIO) CONTROL

You can watch the screen in various picture formats; **16:9**, **Original**, **4:3**, **14:9**, **Zoom1/2** and **Just Scan**.

Just Scan works in the following mode:
Component (720p/1080i/1080p), HDMI (720p/1080i/1080p)

If a fixed image is displayed on the screen for a long time, that fixed image may become imprinted on the screen and remain visible.

You can adjust the enlarge proportion using \wedge \vee button.

This function works in the following signal.

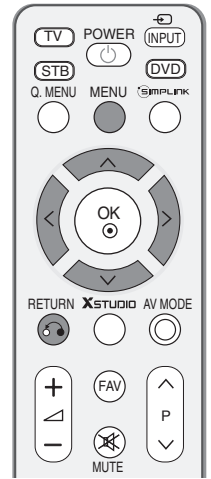

- 1 You can adjust **Aspect Ratio** in the **Picture** menu.

• 16:9

The following selection will allow you to adjust the picture horizontally, in linear proportion, to fill the entire screen (useful for viewing 4:3 formatted DVDs).



• 4:3

The following selection will allow you to view a picture with an original 4:3 aspect ratio, grey bars will appear on both the left and right hand of the screen.

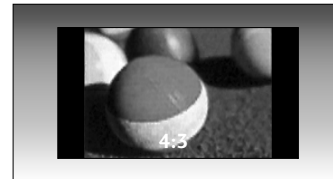

• Original

When your TV receives a wide screen signal it will automatically change to the picture format to be broadcast.

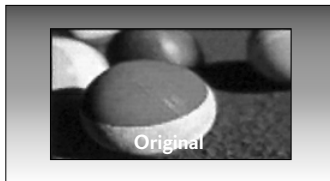

• 14:9

You can view a picture format of 14:9 or a general TV programme in the 14:9 mode. The 14:9 screen is viewed in the same way as in 4:3, but is magnified to the left and right.



- **Zoom1**

The following selection will allow you to view the picture without any alteration, while filling the entire screen. However, the top and bottom of the picture will be cropped.

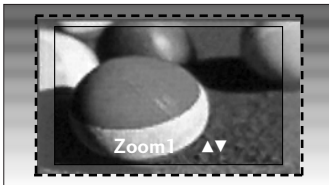

- **Zoom2**

Choose Zoom 2 when you wish the picture to be altered, both horizontally extended and vertically cropped. The picture adopting a compromise between alteration and screen coverage.

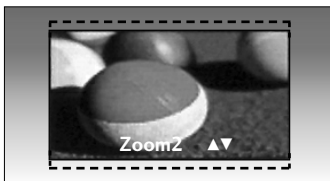

- **Just Scan**

Following Selection will lead to you view the picture of best quality without loss of original picture in high resolution image.

! NOTE

- ▶ You can only select **4:3**, **16:9 (Wide)** in Component, HDMI, RGB(PC) mode.
- ▶ In HDMI/Component (over 720p) mode, **Just Scan** is available.

PICTURE CONTROL

PRESET PICTURE SETTINGS

Picture Mode-Preset

Picture Mode adjusts the TV for the best picture appearance. Select the preset value in the **Picture Mode** menu based on the programme category.

Intelligent Sensor(Only 32/37/42/47LG6***, 42/47/52LG7***), Vivid, Standard, Cinema, Sport and Game are programmed for optimum picture reproduction at the factory and cannot be changed.

When the Intelligent Sensor function is on, the most suitable picture is automatically adjusted according to the surrounding conditions.(Only 32/37/42/47LG6***, 42/47/52LG7***)

1 Press the **MENU** button and then \wedge/\vee button to select the **Picture** menu.

2 Press the \triangleright button and then \wedge/\vee button to select **Picture Mode**.

3 Press the \triangleright button and then \wedge/\vee button to select **Intelligent Sensor**(Only 32/37/42/47LG6***, 42/47/52LG7***), **Vivid**, **Standard**, **Cinema**, **Sport**, **Game**, **User1** or **User2**.

4 Press the **MENU** button to return to normal TV viewing. Press the **RETURN** button to move to the previous menu screen.

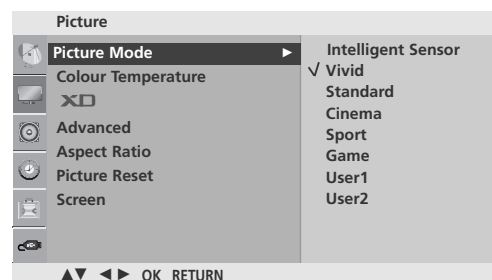
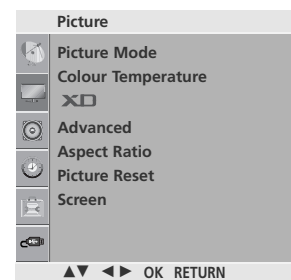
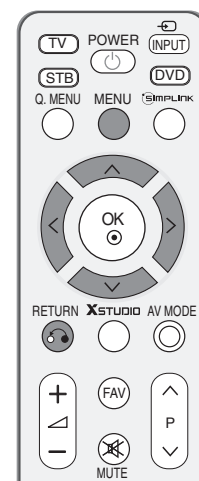

Auto Colour Tone Control(Cool/Medium/Warm)

To initialize values (reset to default settings), select the Cool option.

Choose one of three automatic colour adjustments. Set to warm to enhance hotter colours such as red, or set to cool to see less intense colours with more blue.

This menu is activated after selecting "User1" or "User2" in the Picture Mode.

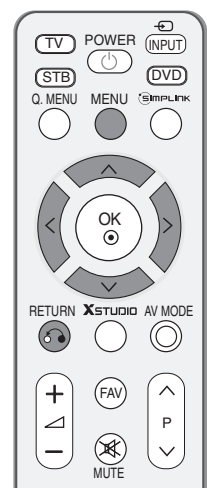

1 Press the **MENU** button and then \wedge/\vee button to select the **Picture** menu.

2 Press the \triangleright button and then \wedge/\vee button to select **Colour Temperature**.

3 Press the \triangleright button and then \wedge/\vee button to select either **Cool, Medium, Warm** or **User**.

4 Press the **MENU** button to return to normal TV viewing.
Press the **RETURN** button to move to the previous menu screen.

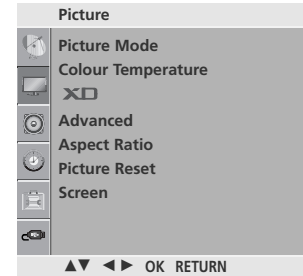

1

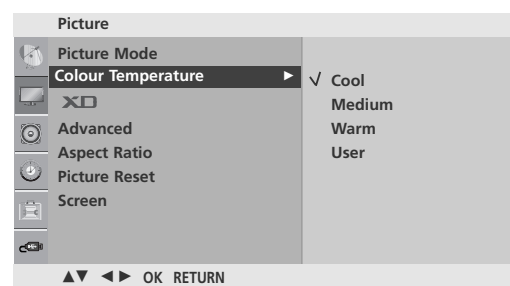

2 3

PICTURE CONTROL

MANUAL PICTURE ADJUSTMENT

Picture Mode-User Option

- Backlight** To control the brightness of the screen, adjust the brightness of LCD panel.
- Contrast** Adjusts the difference between light and dark levels in the picture.
- Brightness** Increases or decreases the amount of white in the picture.
- Colour** Adjusts intensity of all colours.
- Sharpness** Adjusts the level of crispness in the edges between the light and dark areas of the picture. The lower the level, the softer the image.
- Tint** Adjusts the balance between red and green levels.

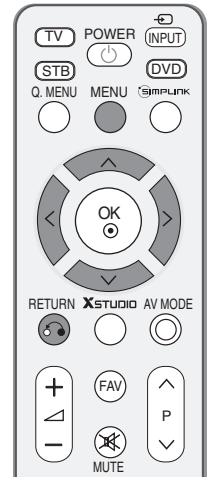

- 1 Press the **MENU** button and then \wedge / \vee button to select the **Picture** menu.
- 2 Press the \triangleright button and then \wedge / \vee button to select **Picture Mode**.
- 3 Press the \triangleright button and then \wedge / \vee button to select **User1** or **User2**.
- 4 Press the \triangleright button and then \wedge / \vee button to select the desired picture option (**Backlight**(Only LCD TV modes), **Contrast**, **Brightness**, **Colour**, **Sharpness** and **Tint**).
- 5 Press the $\triangleleft / \triangleright$ button to make appropriate adjustments.
- 6 Press the **MENU** button to return to normal TV viewing. Press the **RETURN** button to move to the previous menu screen.

! NOTE

- ▶ You cannot adjust colour, sharpness and tint in the RGB-PC mode.

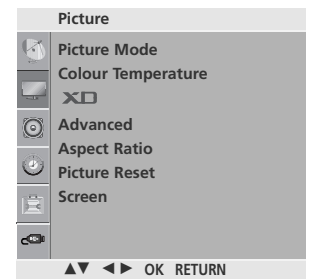

1

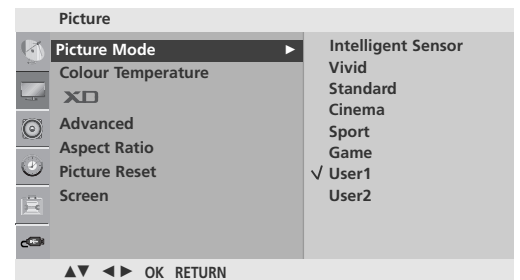

2 3

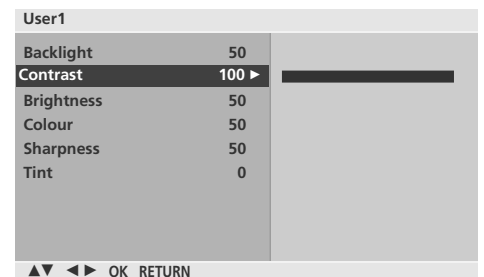

4



5

Colour Tone - User Option

To adjust red, green, blue to any colour temperature you prefer.

This menu is activated after selecting “User1” or “User2” in the Picture Mode.

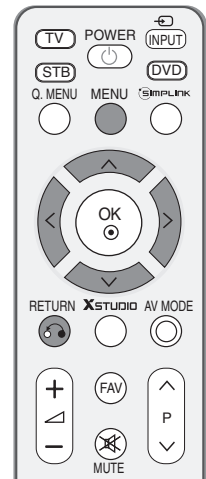

- 1 Press the **MENU** button and then \wedge / \vee button to select the **Picture** menu.

- 2 Press the \triangleright button and then \wedge / \vee button to select **Colour Temperature**.

- 3 Press the \triangleright button and then \wedge / \vee button to select **User**.

- 4 Press the \triangleright button and then \wedge / \vee button to select **Red**, **Green** or **Blue**.

- 5 Press the $\triangleleft / \triangleright$ button to make appropriate adjustments.

- 6 Press the **MENU** button to return to normal TV viewing.
Press the **RETURN** button to move to the previous menu screen.

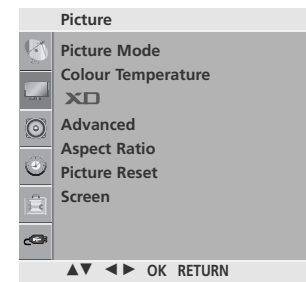

1

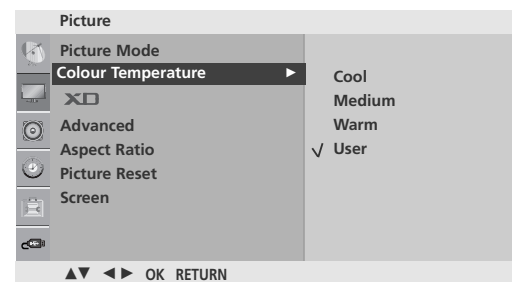

2 3

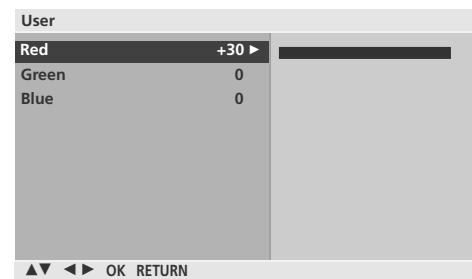

4



5

PICTURE CONTROL

XD - PICTURE IMPROVEMENT TECHNOLOGY

XD is LG electronic's unique picture improving technology to display a real HD source through an advanced digital signal processing algorithm.

It is not possible to use this function in RGB-PC mode.

- 1 Press the MENU button and then \wedge/\vee button to select the **Picture** menu.
- 2 Press the $\>$ button and then \wedge/\vee button to select **XD**.
- 3 Press the $\>$ button and then \wedge/\vee button to select **Auto** or **Manual**.
- 4 Press the **MENU** button to return to normal TV viewing.
Press the **RETURN** button to move to the previous menu screen.

* Manual Selection

This menu is activated after selecting the **User1** or **User2** of **Picture Mode**.

- 1 Press the $\>$ button and then \wedge/\vee button to select **XD Contrast**, **XD Colour** or **XD NR**.
- 2 Press the $\>$ button and then \wedge/\vee button to select **Off**, **Low** or **High**.
Select **Off**, **Low**, **High**, **Adaptive**.(only XD NR)
- 3 Press the **MENU** button to return to normal TV viewing.
Press the **RETURN** button to move to the previous menu screen.

- **XD Contrast** : Optimises the contract automatically according to the brightness of the reflection.
- **XD Colour** : Adjusts the colour of the reflection automatically to reproduce as close as possible to natural colours.
- **XD NR** : Removes interference up to the point where it does not damage the original picture.

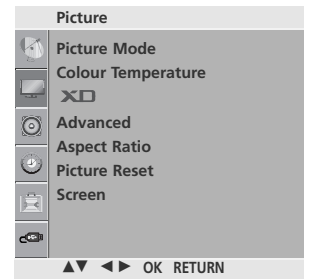
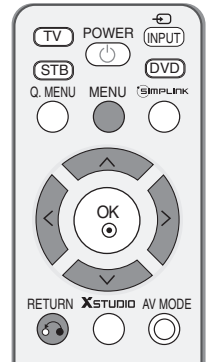

1

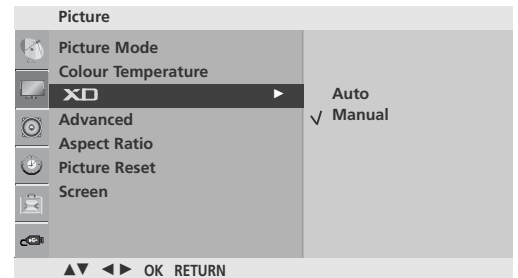

2 3



1 2

ADVANCED - GAMMA

High gamma values display whitish images and low gamma values display high contrast images.

It is not possible to use this function in RGB-PC mode.

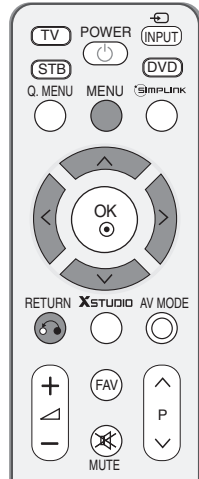

1 Press the **MENU** button and then \wedge/\vee button to select the **Picture** menu.

2 Press the \triangleright button and then \wedge/\vee button to select **Advanced**.

3 Press the \triangleright button and then \wedge/\vee button to select **Gamma**.

4 Press the \triangleright button and then \wedge/\vee button to select **Low**, **Medium** or **High**.

5 Press the **MENU** button to return to normal TV viewing. Press the **RETURN** button to move to the previous menu screen.

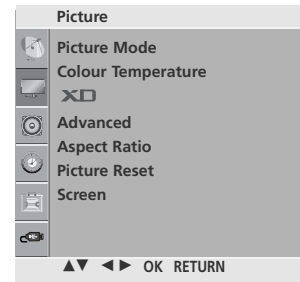

1

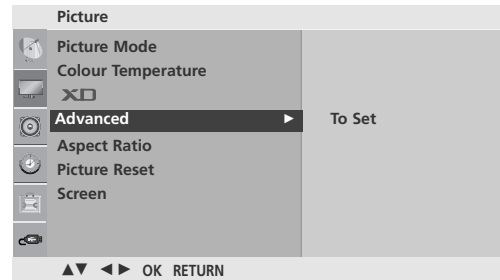

2 3



4

PICTURE CONTROL

ADVANCED - FILM MODE/REAL CINEMA

To set the TV up for the best picture quality for viewing films.

This feature operates only in Analog TV, AV, S-video and Component 480i/576i mode.(Film Mode only)

In HDMI mode(1080p 24Hz). (42/47/52LG7*** only)

Screen	TruMotion	Real Cinema
5:5 Pull-Down	Off	On

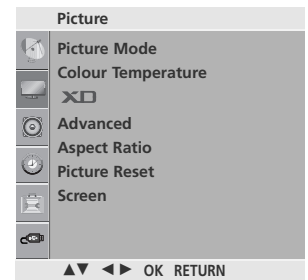
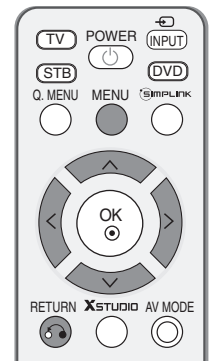

1 Press the **MENU** button and then \wedge/\vee button to select the **Picture** menu.

2 Press the \triangleright button and then \wedge/\vee button to select **Advanced**.

3 Press the \triangleright button and then \wedge/\vee button to select **Film Mode** or **Real Cinema**(42/47/52LG7*** only).

4 Press the \triangleright button and then \wedge/\vee button to select **On** or **Off**.

5 Press the **MENU** button to return to normal TV viewing.
Press the **RETURN** button to move to the previous menu screen.

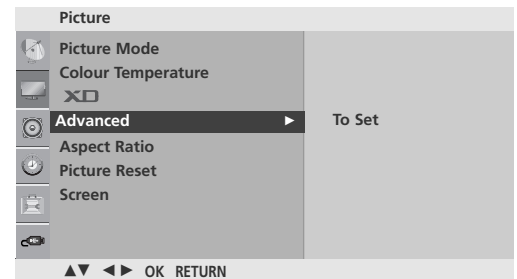

(42/47/52LG7*** only)



ADVANCED - BLACK(DARKNESS) LEVEL

When you view a film this function adjust the TV to best picture quality. Adjusting the contrast and the brightness of the screen using the black level of the screen.

This function works in the following mode:
 RF(NTSC-M), AV, S-Video(NTSC-M, NTSC 4.43),
 COMPONENT or HDMI.

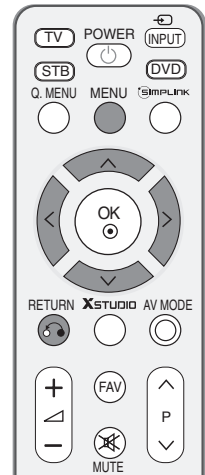

1 Press the **MENU** button and then \wedge/\vee button to select the **Picture** menu.

2 Press the \triangleright button and then \wedge/\vee button to select **Advanced**.

3 Press the \triangleright button and then \wedge/\vee button to select **Black Level**.

4 Press the \triangleright button and then \wedge/\vee button to select **Low** or **High**.

- **Low** : The reflection of the screen gets darker.
- **High** : The reflection of the screen gets brighter.

5 Press the **MENU** button to return to normal TV viewing.
 Press the **RETURN** button to move to the previous menu screen.

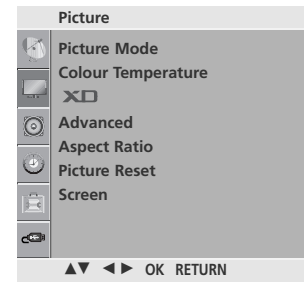

1

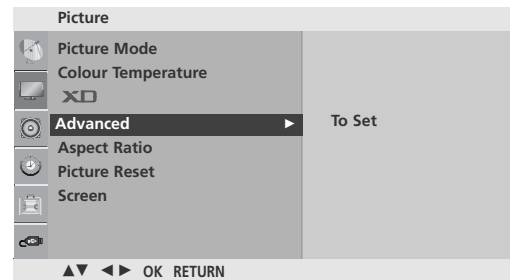

2 3



4

PICTURE CONTROL

EYE CARE (ONLY LCD TV MODELS)

It helps you adjust brightness when the screen is too bright to prevent dazzling.

When selecting Picture Mode(Standard, Sport, Game, User1 and User2), you can operate this function.

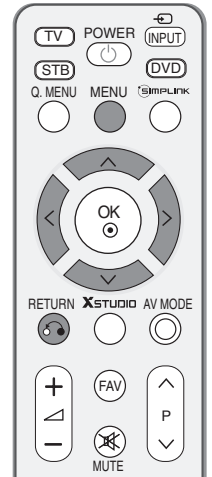

- 1 Press the **MENU** button and then \wedge/\vee button to select the **Picture** menu.
- 2 Press the \triangleright button and then \wedge/\vee button to select **Advanced**.
- 3 Press the \triangleright button and then \wedge/\vee button to select **Eye Care**.
- 4 Press the \triangleright button and then \wedge/\vee button to select **On** or **Off**.
- 5 Press the **MENU** button to return to normal TV viewing.
Press the **RETURN** button to move to the previous menu screen.

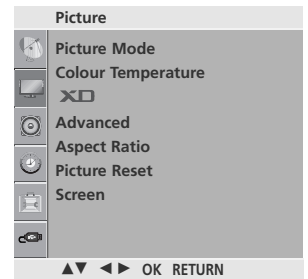

1

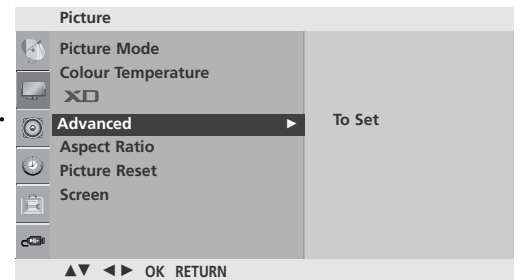

2 3



4

ADVANCED - TRUMOTION

(42/47/52LG7*** only)

It is used for the best picture quality without any motion blur or judder when you enter a quick image or Film Source.

This feature is disable in RGB-PC, HDMI-PC mode.

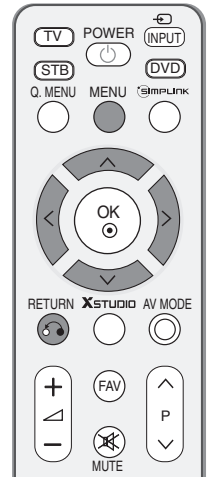

- 1 Press the **MENU** button and then \wedge / \vee button to select the **Picture** menu.
- 2 Press the \triangleright button and then \wedge / \vee button to select **Advanced**.
- 3 Press the \triangleright button and then \wedge / \vee button to select **TruMotion**.
- 4 Press the \langle / \triangleright button to select **Off**, **Low** or **High**.
 - **Low** : Provides smooth picture movement. Use this setting for standard use.
 - **High** : Provides smoother picture movement.
 - **Off** : Use this setting when “High” and “Low” setting result in noise.
- 5 Press the **MENU** button to return to normal TV viewing.
Press the **RETURN** button to move to the previous menu screen.

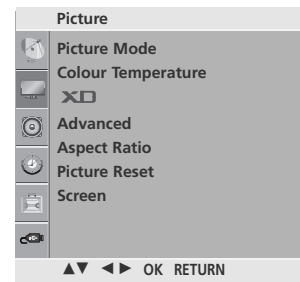

1

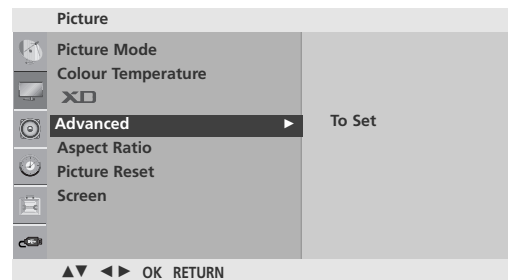

2 3

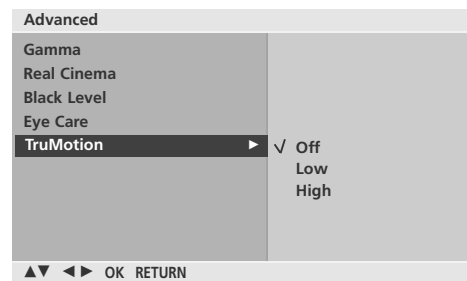

4

- If you enable “TruMotion”, noise may appear on the screen.
- If this occurs, set “TruMotion” to “Off”.

PICTURE CONTROL

PICTURE RESET

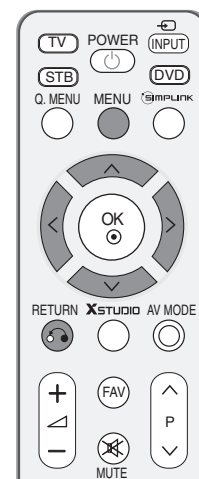

Returns to the default factory setting for Picture Mode, Colour Temperature, XD, Advanced, Aspect Ratio.

1 Press the **MENU** button and then \wedge/\vee button to select the **Picture** menu.

2 Press the \triangleright button and then \wedge/\vee button to select **Picture Reset**.

3 Press the \triangleright button to initialize the adjusted value.

4 Press the **MENU** button to return to normal TV viewing.
Press the **RETURN** button to move to the previous menu screen.

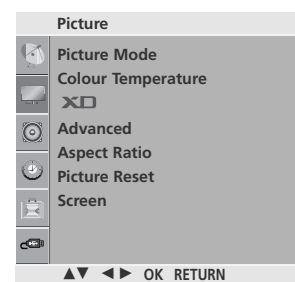

1

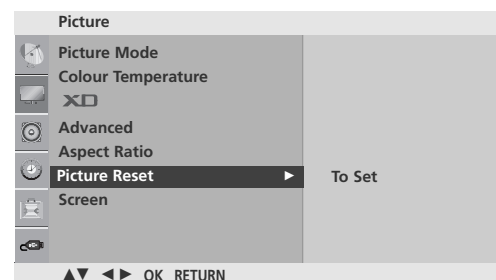

2 3

TRUMOTION DEMO (42/47/52LG7*** only)

Use it to see the difference between TruMotion Demo on and TruMotion Demo off.

It's not available to use this function in RGB/HDMI-PC mode.

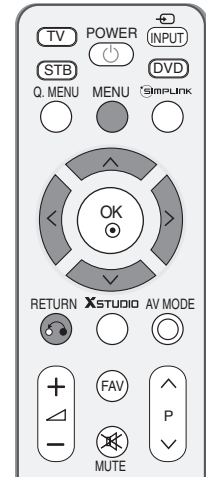

- 1 Press the MENU button and then \wedge/\vee button to select the **Picture** menu.
- 2 Press the \triangleright button and then \wedge/\vee button to select **TruMotion Demo**.
- 3 Press the \triangleright button to begin **TruMotion Demo**.
- 4 To stop **TruMotion Demo**, press the **MENU** button.

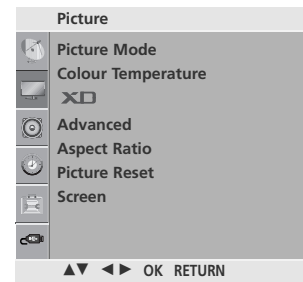

1

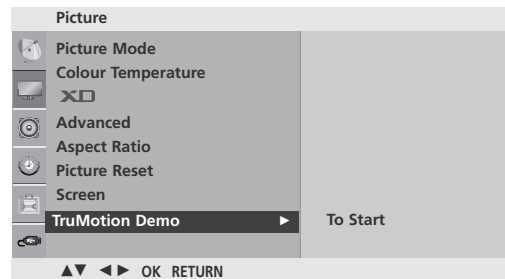

2 3

• TruMotion Demo

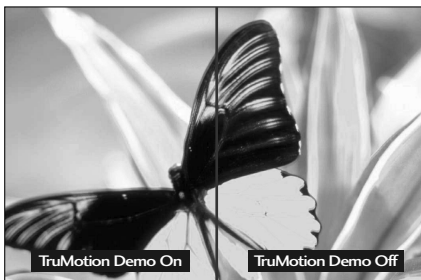

PICTURE CONTROL

POWER INDICATOR (ONLY LCD TV MODELS)

It helps you adjust the brightness of moving LED and sound when power is turned on.

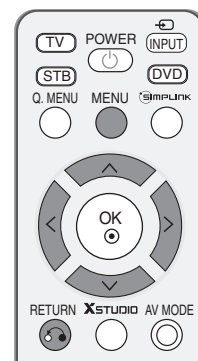

1 Press the **MENU** button and then \wedge / \vee button to select the **Option** menu.

2 Press the \triangleright button and then \wedge / \vee button to select **Power Indicator**.

3 Press the \triangleright button and then \wedge / \vee button to select **Startup Sound**(Only 32/37/42/47LG6***), **Standby Light**, **Power Light** or **Demo Mode**(Only 32/37/42/47LG6***).

4 Press the \triangleright button and then \wedge / \vee button to select your desired Source.

5 Press the **MENU** button to return to normal TV viewing.
Press the **RETURN** button to move to the previous menu screen.

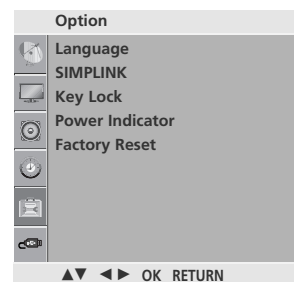

1

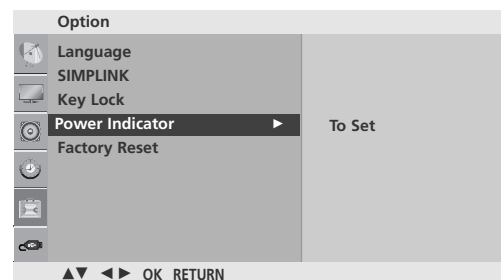

2 3

IMAGE STICKING MINIMIZATION(ISM)METHOD (ONLY PLASMA TV MODELS)

A frozen or still picture from a PC/Video game displayed on the screen for prolonged periods will result in a ghost image remaining even when you change the image. Avoid allowing a fixed image to remain on the screen for prolonged periods.

White Wash

White wash removes permanent images from the screen.

Note: An excessive permanent image may be impossible to clear entirely with White Wash.

Orbiter

Orbiter may help prevent ghost images. However, it is best not to allow any fixed image to remain on the screen. To avoid a permanent image on the screen, the screen will move every 2 minutes.

Inversion

This function inverts the panel colour of the screen.
The panel colour is automatically inverted every 30 minutes.

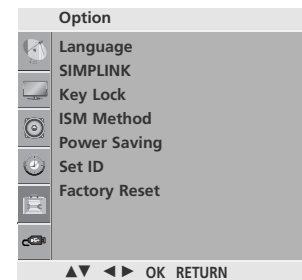
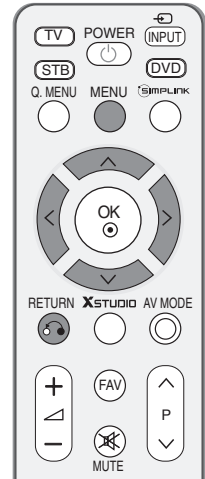

1

1 Press the **MENU** button and then \wedge/\vee button to select the **Option** menu.

2 Press the \triangleright button and then \wedge/\vee button to select **ISM Method**.

3 Press the \triangleright button and then \wedge/\vee button to select either **Normal**, **White Wash**, **Orbiter** or **Inversion**.
If you do not need this function, set **Normal**.

4 Press the **MENU** button to return to normal TV viewing.
Press the **RETURN** button to move to the previous menu screen.

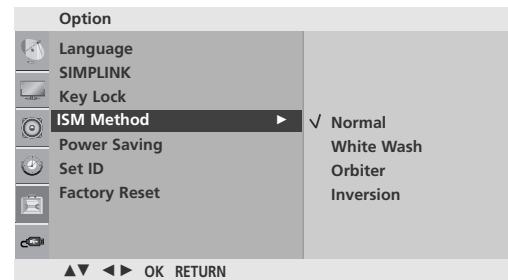

2 3

PICTURE CONTROL

POWER SAVING PICTURE MODE (ONLY PLASMA TV MODELS)

This function allows you to reduce the power consumption of the TV.

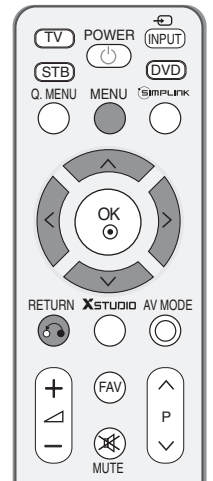

- 1 Press the **MENU** button and then \wedge/\vee button to select the **Option** menu.
- 2 Press the \triangleright button and then \wedge/\vee button to select **Power Saving**.
- 3 Press the \triangleright button and then \wedge/\vee button to select power levels.
- 4 Press the **MENU** button to return to normal TV viewing.
Press the **RETURN** button to move to the previous menu screen.

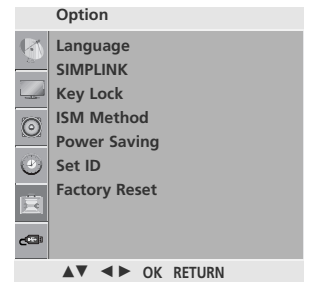

1

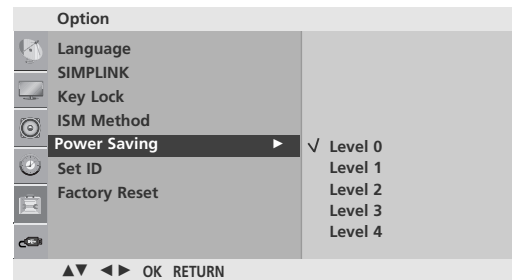

2 3

FACTORY RESET

Use to quickly reset all the menu options to their original factory preset values.

This function deletes all TV programmes.

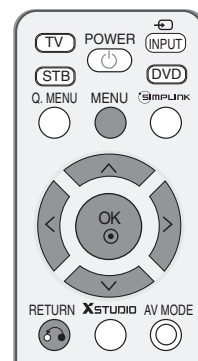

- 1 Press the **MENU** button and then \wedge / \vee button to select the **Option** menu.
- 2 Press the \triangleright button and then \wedge / \vee button to select **Factory Reset**.
- 3 Press the \triangleright button and then $\triangleleft / \triangleright$ button to select **YES** or **NO**.
- 4 Press the **MENU** button to return to normal TV viewing. Press the **RETURN** button to move to the previous menu screen.

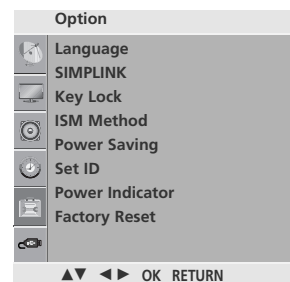

1

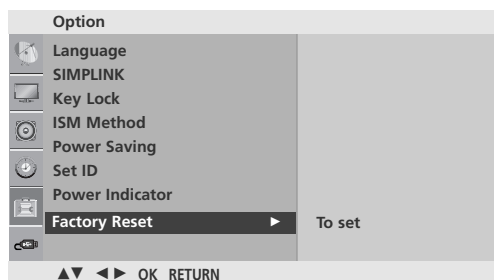

2

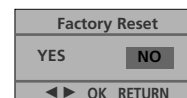

3

SOUND & LANGUAGE CONTROL

AUTO VOLUME LEVELER

Auto Volume automatically remains on the same level of volume if you change programmes.

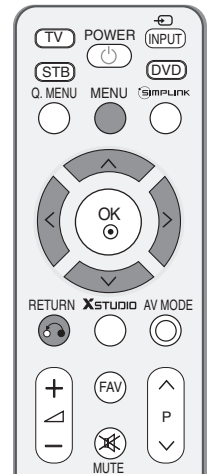

1 Press the **MENU** button and then \wedge/\vee button to select the **Audio** menu.

2 Press the \triangleright button and then \wedge/\vee button to select **Auto Volume**.

3 Press the \triangleright button and then \wedge/\vee button to select **On** or **Off**.

4 Press the **MENU** button to return to normal TV viewing.
Press the **RETURN** button to move to the previous menu screen.

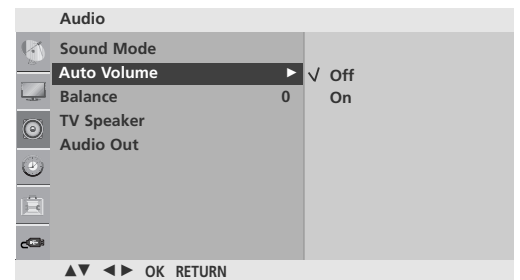
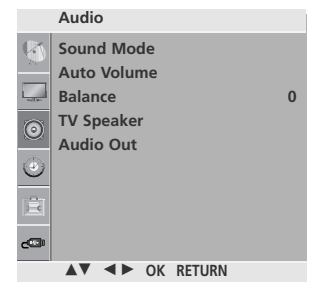

PRESET SOUND SETTINGS-SOUND MODE

You can select your preferred sound setting; SRS TSXT, Clear Voice, Standard, Music, Cinema, Sport or Game and you can also adjust the frequency of the equalizer.

Sound Mode lets you enjoy the best sound without any Special adjustment as the TV sets the appropriate sound options based on the programme content.

SRS TSXT, Clear Voice, Standard, Music, Cinema, Sport and Game are preset for optimum sound quality at the factory and are not adjustable.

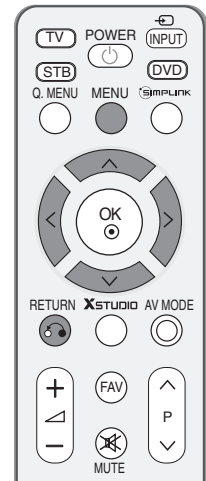

1 Press the **MENU** button and then \wedge / \vee button to select the **Audio** menu.

2 Press the \triangleright button and then \wedge / \vee button to select **Sound Mode**.

3 Press the \triangleright button and then \wedge / \vee button to select **SRS TSXT, Clear Voice, Standard, Music, Cinema, Sport, Game** or **User**.

4 Press the **MENU** button to return to normal TV viewing. Press the **RETURN** button to move to the previous menu screen.

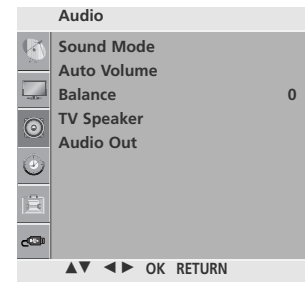

1

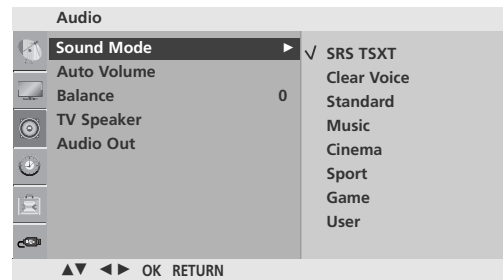

2 3

- ▶ **SRS** is a trademark of SRS Labs, Inc.
- ▶ TruSurround XT technology is incorporated under license from SRS Labs, Inc.

SOUND & LANGUAGE CONTROL

SOUND SETTING ADJUSTMENT -USER MODE

Adjusting the audio equalizer.

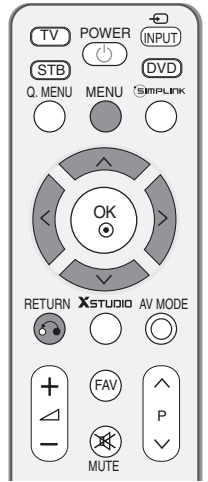

1 Press the **MENU** button and then \wedge/\vee button to select the **Audio** menu.

2 Press the \triangleright button and then \wedge/\vee button to select **Sound Mode**.

3 Press the \triangleright button and then \wedge/\vee button to select **User**.

4 Press the \triangleright button.

5 Select a frequency band by pressing the $\triangleleft/\triangleright$ button.
Set the desired sound level with the \wedge/\vee button.

6 Press the **MENU** button to return to normal TV viewing.
Press the **RETURN** button to move to the previous menu screen.

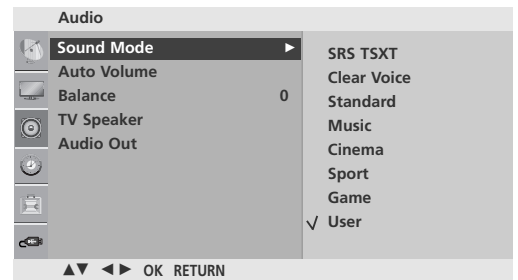
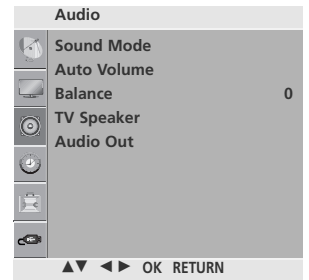

2 3 4

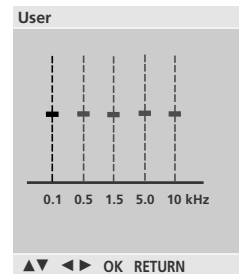

5

BALANCE

You can adjust the sound balance of the speakers to the preferred levels.

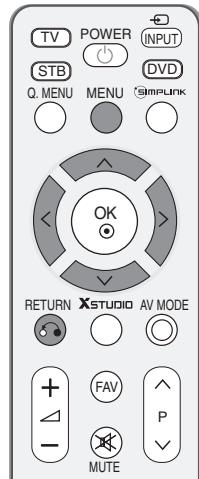

- 1 Press the **MENU** button and then \wedge / \vee button to select the **Audio** menu.
- 2 Press the \triangleright button and then \wedge / \vee button to select **Balance**.
- 3 Press the \triangleright button and then \langle / \triangleright button to make desired adjustment.
- 4 Press the **MENU** button to return to normal TV viewing. Press the **RETURN** button to move to the previous menu screen.

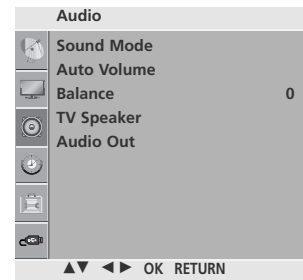

1

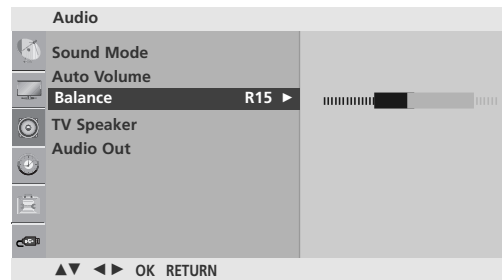

2 3

SOUND & LANGUAGE CONTROL

TV SPEAKERS ON/OFF SETUP

You can adjust the internal speaker status.

In TV, AV, COMPONENT, RGB[PC] and HDMI mode, internal speaker audio can be operational even though there is no video signal.

If you wish to use an external hi-fi system, turn off the TV internal speakers.

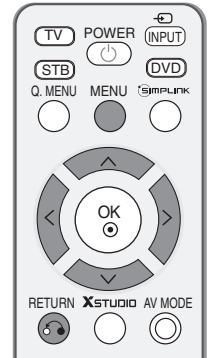

- 1 Press the **MENU** button and then \wedge/\vee button to select the **Audio** menu.
- 2 Press the \triangleright button and then \wedge/\vee button to select **TV Speaker**.
- 3 Press the \triangleright button and then \wedge/\vee button to select **On** or **Off**.
- 4 Press the **MENU** button to return to normal TV viewing.
Press the **RETURN** button to move to the previous menu screen.

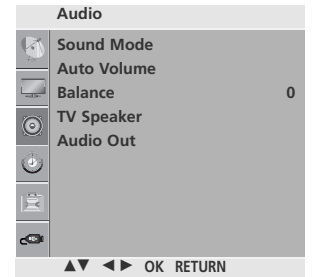

1

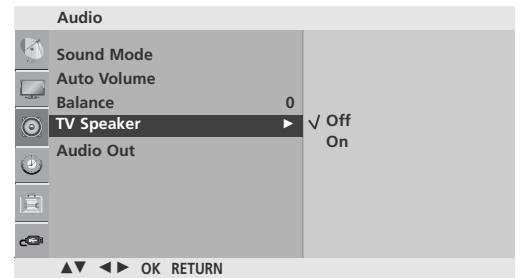

2 3

SELECTING AUDIO OUT

Select **Monitor Out** or **Variable out** to connect the audio outputs.

- 1 Press the **MENU** button and then \wedge/\vee button to select the **Audio** menu.
- 2 Press the \triangleright button and then \wedge/\vee button to select **Audio Out**.
- 3 Press the \triangleright button and then \wedge/\vee button to select **Monitor Out** or **Variable out**.
- 4 Press the **MENU** button to return to normal TV viewing.
Press the **RETURN** button to move to the previous menu screen.



1

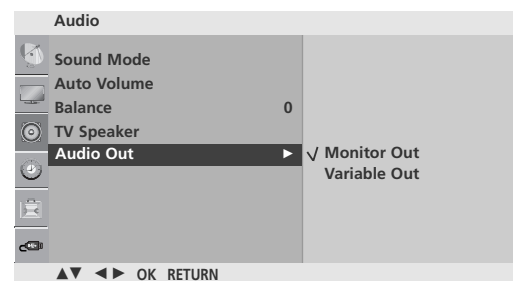

2 3

SLIDING MODE(ONLY 42LG8***)

Superior quality of sound can be appreciated when used a speaker by the sliding mode function

1 Press the **MENU** button and then \wedge/\vee button to select the **Audio** menu.

2 Press the \triangleright button and then \wedge/\vee button to select **Sliding Mode**.

3 Press the \triangleright button and then \wedge/\vee button to select **Open** or **Auto**.

- **Open** : The speaker is always open regardless of the power on or off.
- **Auto** : The speaker opens when the TV set is turned on only.

4 Press the **MENU** button to return to normal TV viewing.
Press the **RETURN** button to move to the previous menu screen.

! NOTE

- ▶ Speaker and related parts of the television can be damaged when the speaker is not put on action by a remote controller or control keys.
- ▶ Do not apply pressure onto speakers to avoid faulty movement and damages.

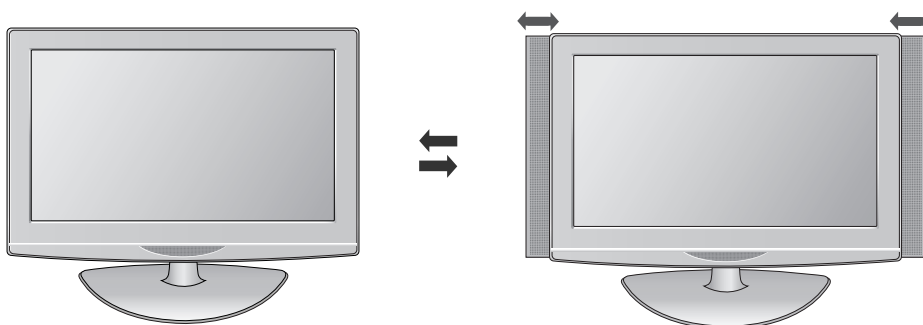
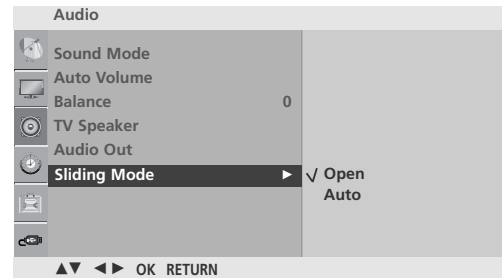
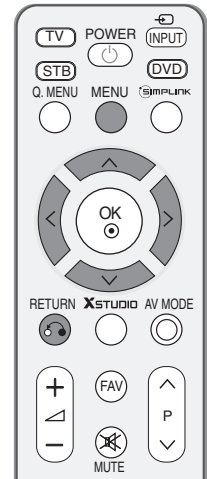

SOUND & LANGUAGE CONTROL

I/II

Stereo/Dual Reception

When a programme is selected, the sound information for the station appears with the programme number and station name.

1 Press the **Q.MENU** button and then \wedge / \vee button to select the **Multi Audio** menu.

2 Press the $< / >$ button to select the sound output.

Broadcast	On Screen Display
Mono	MONO
Stereo	STEREO
Dual	DUAL I, DUAL II, DUAL I+II

■ Mono sound selection

If the stereo signal is weak in stereo reception, you can switch to mono. In mono reception, the clarity of sound is improved. To switch back to stereo.

■ Language selection for dual language broadcast

If a programme can be received in two languages (dual language), you can switch to DUAL I, DUAL II or DUAL I+II.

DUAL I Sends the primary broadcast language to the loudspeakers.

DUAL II Sends the secondary broadcast language to the loudspeakers.

DUAL I+II Sends a separate language to each loudspeaker.

NICAM Reception

If the TV is equipped with a receiver for NICAM reception, high quality NICAM (Near Instantaneous Companding Audio Multiplex) digital sound can be received.

Sound output can be selected according to the type of broadcast received.

-
- 1 When **NICAM mono** is received, you can select **NICAM MONO** or **FM MONO**.
 - 2 When **NICAM stereo** is received, you can select **NICAM STEREO** or **FM MONO**.
If the stereo signal is weak, switch to **FM MONO**.
 - 3 When **NICAM dual** is received, you can select **NICAM DUAL I**, **NICAM DUAL II** or **NICAM DUAL I+II** or **FM MONO**.
-

Speaker Sound Output Selection

In AV, Component, RGB and HDMI mode, you can select output sound for the left and right loudspeakers.

Select the sound output.

L+R: Audio signal from audio L input is sent to the left loudspeaker and audio signal from audio R input is sent to the right loudspeaker.

L+L: Audio signal from audio L input is sent to left and right loudspeakers.

R+R: Audio signal from audio R input is sent to left and right loudspeakers.

SOUND & LANGUAGE CONTROL

ON-SCREEN MENU LANGUAGE SELECTION

The menus can be shown on the screen in the selected language. First select your language.



-
- 1 Press the **MENU** button and then use \wedge / \vee button to select the **Option** menu.

 - 2 Press the \triangleright button and then use \wedge / \vee button to select **Language**.

 - 3 Press the \triangleright button and then use $\wedge / \vee / \triangleleft / \triangleright$ button to select your desired language.

 - 4 Press the **OK** button

 - 5 Press the **MENU** button to return to normal TV viewing.
Press the **RETURN** button to move to the previous menu screen.
-

TIME SETTING

CLOCK SETUP

You must set the time correctly before using on/off timer function.

If current time setting is erased by a power failure or the TV is unplugged, reset the clock.

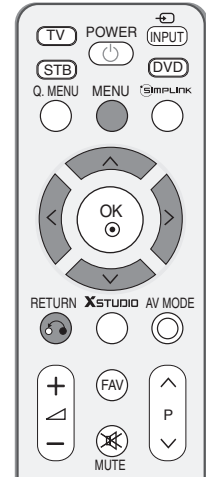

1 Press the **MENU** button and then \wedge/\vee button to select the **Time** menu.

2 Press the \triangleright button and then \wedge/\vee button to select **Clock**.

3 Press the \triangleright button and then \wedge/\vee button to set the hour.

4 Press the \triangleright button and then \wedge/\vee button to set the minute.

5 Press the **MENU** button to return to normal TV viewing.
Press the **RETURN** button to move to the previous menu screen.

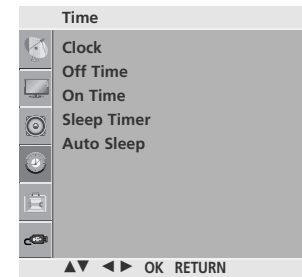

1

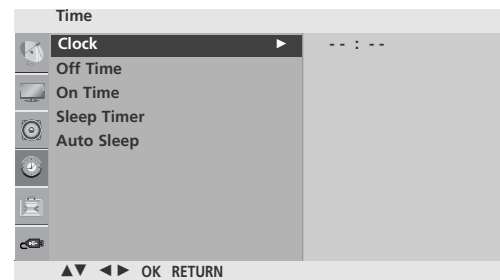

2 3 4

TIME SETTING

AUTO ON/OFF TIMER SETTING

The Off time function automatically switches the TV to standby at a preset time.

Two hours after the TV is switched on by the on time function it will automatically switch back to standby mode unless a button has been pressed.

Once the on time/off time is set, these functions operate daily at the preset time.

The Off time function overrides the On timer function if both are set to the same time.

The TV must be in standby mode for the On timer to work.

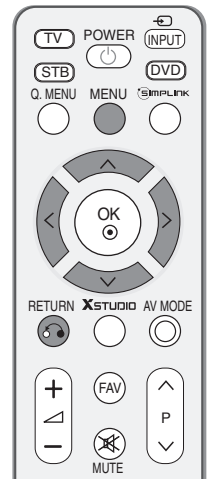

1 Press the **MENU** button and then \wedge/\vee button to select the **Time** menu.

2 Press the \triangleright button and then \wedge/\vee button to select **On/Off Time**.

- To cancel **On/Off Time** function, select **Off**.

3 Press the \triangleright button and then \wedge/\vee button to set the hour.

4 Press the \triangleright button and then \wedge/\vee button to set the minutes.

5 **For On Time function only**

- **Programme:** Press the \triangleright button and then \wedge/\vee button to select the programme.
- **Volume:** Press the \triangleright button and then \wedge/\vee button to adjust volume level at switch-on.

6 Press the **MENU** button to return to normal TV viewing.
Press the **RETURN** button to move to the previous menu screen.

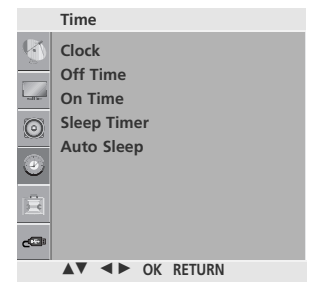

1

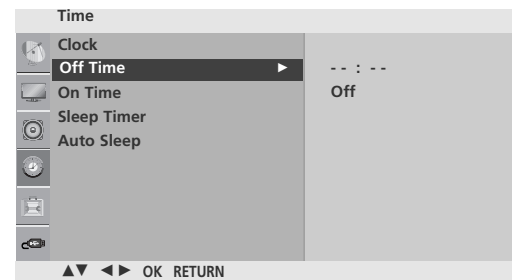

2 3 4

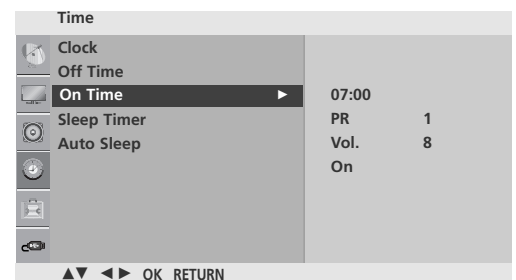

2 3 4 5

SLEEP TIMER SETTING

You do not have to remember to switch the TV off before you go to sleep. The sleep timer automatically switches the TV to standby after the preset time has elapsed.

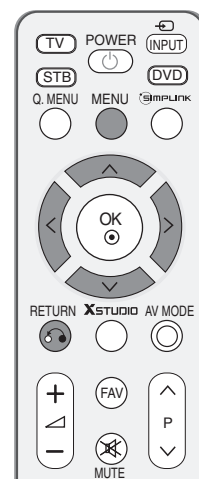

1 Press the **MENU** button and then \wedge/\vee button to select the **Time** menu.

2 Press the $\>$ button and then \wedge/\vee button to select **Sleep Timer**.

3 Press the $\>$ button and then \wedge/\vee button to set the minute.

4 Press the **MENU** button to return to normal TV viewing. Press the **RETURN** button to move to the previous menu screen.

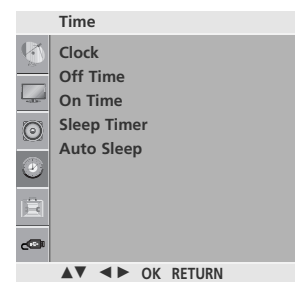

1



2 3 4

! NOTE

- ▶ When you switch the TV off, the TV releases the preset sleep time.

TIME SETTING

AUTO SHUT-OFF SETTING

If the TV set is switched on and there is no input signal, it will switch off automatically after 10 minutes.

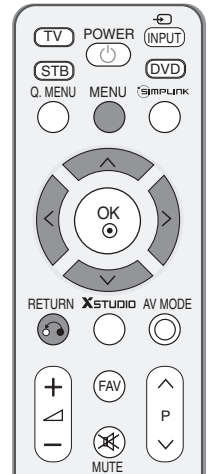

1 Press the **MENU** button and then \wedge/\vee button to select the **Time** menu.

2 Press the \triangleright button and then \wedge/\vee button to select **Auto Sleep**.

3 Press the \triangleright button and then \wedge/\vee button to select **On** or **Off**.

4 Press the **MENU** button to return to normal TV viewing.
Press the **RETURN** button to move to the previous menu screen.

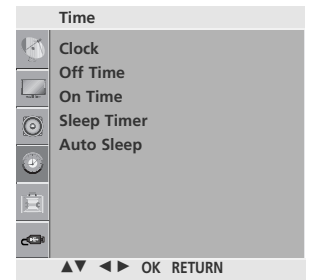

1



2 3

TELETEXT

This feature is not available in all countries.

Teletext is a free service broadcast by most TV stations which gives up-to-the-minute information on news, weather, television programmes, share prices and many other topics.

The teletext decoder of this TV can support the SIMPLE, TOP and FASTEXT systems. SIMPLE (standard teletext) consists of a number of pages which are selected by directly entering the corresponding page number. TOP and FASTEXT are more modern methods allowing quick and easy selection of teletext information.

SWITCH ON/OFF

Press the **TEXT** button to switch to teletext. The initial page or last page viewed appears on the screen.

Two page numbers, TV station name, date and time are displayed on the screen headline. The first page number indicates your selection, while the second shows the current page displayed.

Press the **TEXT** or **RETURN** button to switch off teletext. The previous mode reappears.

SIMPLE TEXT

■ Page selection

- ① Enter the desired page number as a three digit number with the NUMBER buttons. If during selection you press a wrong number, you must complete the three digit number and then re-enter the correct page number.
- ② The **P** \wedge / \vee button can be used to select the preceding or following page.

TELETEXT

TOP TEXT

The user guide displays four fields-red, green, yellow and blue at the bottom of the screen. The yellow field denotes the next group and the blue field indicates the next block.

■ Block / group / page selection

- ① With the blue button you can progress from block to block.
- ② Use the yellow button to proceed to the next group with automatic overflow to the next block.
- ③ With the green button you can proceed to the next existing page with automatic overflow to the next group. Alternatively the **P** ^ button can be used.
- ④ The red button return to the previous selection. Alternatively the **P** v button can be used.

■ Direct page selection

As with SIMPLE teletext mode, you can select a page by entering it as a three digit number using the NUMBER buttons in TOP mode.

FASTEXT

The teletext pages are colour coded along the bottom of the screen and are selected by pressing the corresponding coloured button.

■ Page selection

- ① Press the  button to select the index page.
- ② You can select the pages which are colour coded along the bottom line with corresponding coloured buttons.
- ③ As with SIMPLE teletext mode, you can select a page by entering its three digit page number with the NUMBER buttons in FASTEXT mode.
- ④ The **P** ^ / v button can be used to select the preceding or following page.

SPECIAL TELETEXT FUNCTIONS



■ TIME

When viewing a TV programme, press this button to display the time at the top right hand corner of the screen. Press this button again to remove the display. In the teletext mode, press this button to select a sub page number. The sub page number is displayed at the bottom of the screen. To hold or change the sub page, press the RED/GREEN, P ^ / ∨ or NUMBER buttons.

Press again to exit this function.



■ SIZE

Selects double height text.

Press this button to enlarge the top half of the page.

Press this button again to enlarge the bottom half of the page.

Press this button again to return to the normal display.



■ UPDATE

Displays the TV picture on the screen while waiting for a new teletext page. The display will appear at the top left hand corner of the screen. When the updated page is available then display will change to the page number. Press this button again to view the updated teletext page.



■ REVEAL

Press this button to display concealed information, such as solutions to riddles or puzzles.

Press this button again to remove the information from the display.



■ INDEX

Select the each index page.



■ HOLD

Stops the automatic page change which will occur if a teletext page consists of 2 or more sub pages. The number of sub pages and the sub page displayed is, usually, shown on the screen below the time. When this button is pressed the stop symbol is displayed at the top left-hand corner of the screen and the automatic page change is inactive. To continue press this button again.

APPENDIX

TROUBLESHOOTING

The TV does not operate properly	
The remote control does not work	<ul style="list-style-type: none">■ Check to see if there is any object between the TV and the remote control causing an obstruction.■ Are batteries installed with correct polarity (+ to +, - to -)?■ Correct remote operating mode set: TV, STB etc.?■ Install new batteries.
Power is suddenly turned off	<ul style="list-style-type: none">■ Is the sleep time set?■ Check the power control settings. Has the Power supply been interrupted.■ Is Auto sleep activated on this station.

The video function does not work.	
No picture & No sound	<ul style="list-style-type: none">■ Check whether the TV is switched on.■ Try another channel. The problem may be with the broadcast.■ Is the power cord inserted correctly into the mains?■ Check your antenna direction and/or location.■ Test the mains outlet by plugging another TV into the same outlet.
Picture appears slowly after switching on	<ul style="list-style-type: none">■ This is normal, the image is muted during the TV startup process. Please contact your service center, if the picture has not appeared after five minutes.
No or poor colour or poor picture	<ul style="list-style-type: none">■ Adjust Colour in menu option.■ Allow a sufficient distance between the TV and the VCR.■ Try another channel. The problem may be with the broadcast.■ Are the video cables installed properly?■ Activate any function to restore the brightness of the picture.
Horizontal/vertical bars or picture shaking	<ul style="list-style-type: none">■ Check for local interference such as an electrical appliance or power tool.
Poor reception on some channels	<ul style="list-style-type: none">■ Station or cable channel experiencing problems, tune to another station.■ Station signal is weak, reposition the antenna to receive weaker stations.■ Check for sources of possible interference.
Lines or streaks in pictures	<ul style="list-style-type: none">■ Check antenna (Change the position of the antenna).
No picture when connecting HDMI	<ul style="list-style-type: none">■ Check HDMI cable over version 1.3. If the HDMI cables don't support HDMI version 1.3, it can cause flickers or no screen display. In this case use the latest cables that support HDMI version 1.3.

The audio function does not work.	
Picture OK & No sound	<ul style="list-style-type: none"> ■ Press the  +/- (or Volume) button. ■ Sound muted? Press MUTE button. ■ Try another channel. The problem may be with the broadcast. ■ Are the audio cables installed properly?
No output from one of the speakers	<ul style="list-style-type: none"> ■ Adjust Balance in menu option.
Unusual sound from inside the TV	<ul style="list-style-type: none"> ■ A change in ambient humidity or temperature may result in an unusual noise when the TV is switched on or off and does not indicate a fault with the TV.
No sound when connecting HDMI or USB	<ul style="list-style-type: none"> ■ Check HDMI cable over version 1.3. ■ Check USB cable over version 2.0. <p style="text-align: right;">*This feature is not available for all models.</p>

There is a problem in PC mode. (Only PC mode applied)	
The signal is out of range.	<ul style="list-style-type: none"> ■ Adjust resolution, horizontal frequency, or vertical frequency. ■ Check the input source.
Vertical bar or stripe on background & Horizontal Noise & Incorrect position	<ul style="list-style-type: none"> ■ Use Auto configure or adjust clock, phase, or H/V position.
Screen colour is unstable or single colour	<ul style="list-style-type: none"> ■ Check the signal cable. ■ Reinstall the PC video card.

APPENDIX

MAINTENANCE

Early malfunctions can be prevented. Careful and regular cleaning can prolong the life of your new TV.
Caution: Be sure to switch the power off and unplug the power cord before you begin any cleaning.

Cleaning the Screen

- 1 A good way to keep the dust off your screen for a while is to wet a soft cloth in a mixture of lukewarm water and a little fabric softener or dish washing detergent. Wring the cloth until it's almost dry, and then use it to wipe the screen.
- 2 Ensure there is no excess water on the screen. Allow any water or dampness to evaporate before switching on.

Cleaning the Cabinet

- To remove dirt or dust, wipe the cabinet with a soft, dry, lint-free cloth.
- Do not use a wet cloth.

Extended Absence

⚠ CAUTION

- ▶ If you expect to leave your TV dormant for prolonged periods (such as a holiday), unplug the power cord to protect against possible damage from lightning or power surges.

PRODUCT SPECIFICATIONS

MODELS		42PG6***	50PG6***	60PG6***
		42PG60UR-TA 42PG61UR-TA	50PG60UR-TA 50PG61UR-TA	60PG60UR-TA 60PG61UR-TA
Dimensions (Width x Height x Depth)	with stand	1044.4 x 735.4 x 308.0 mm 41.1 x 28.9 x 12.1 inches	1235.6 x 849.3 x 364.1 mm 48.6 x 33.4 x 14.3 inches	1455 x 985 x 414 mm 57.3 x 38.8 x 16.3 inches
	without stand	1044.4 x 680.6 x 79.6 mm 41.1 x 26.7 x 3.1 inches	1235.6 x 792.8 x 79.6 mm 48.6 x 31.2 x 3.1 inches	1455 x 924.8 x 84.1 mm 57.3 x 36.4 x 3.3 inches
Weight	with stand	28 kg / 61.7 lbs	43.65 kg / 96.2 lbs	59.2 kg / 130.5 lbs
	without stand	25 kg / 55.1 lbs	39.7 kg / 87.5 lbs	51.7 kg / 114 lbs
Power requirement		AC100-240V~ 50/60Hz	AC100-240V~ 50/60Hz	AC100-240V~ 50/60Hz
MODELS		50PG3***	50PG7***	60PG7***
		50PG30FR-TD	50PG70FR-TB	60PG70FR-TB 60PG70FR-TA
Dimensions (Width x Height x Depth)	with stand	1232 x 850 x 363.6 mm 48.5 x 33.5 x 14.3 inches	1235.6 x 849.3 x 364.1 mm 48.6 x 33.4 x 14.3 inches	1455 x 985 x 414 mm 57.3 x 38.8 x 16.3 inches
	without stand	1232 x 793 x 84 mm 48.5 x 31.2 x 3.3 inches	1235.6 x 792.8 x 79.6 mm 48.6 x 31.2 x 3.1 inches	1455 x 924.8 x 84.1 mm 57.3 x 36.4 x 3.3 inches
Weight	with stand	42.3 kg / 93.3 lbs	45.65 kg / 100.6 lbs	62.4 kg / 137.6 lbs
	without stand	38.3 kg / 84.4 lbs	41.7 kg / 91.9 lbs	54.9 kg / 121 lbs
Power requirement		AC100-240V~ 50/60Hz	AC100-240V~ 50/60Hz	AC100-240V~ 50/60Hz
Television System		PAL/SECAM B/G/D/K, PAL I/II, NTSC-M		
Program Coverage		VHF: NZ1 ~ E21, UHF: E21 ~ E69, CATV: S1 ~ S20, HYPER: S21 ~ S47		
External Antenna Impedance		75 Ω		
Environment condition	Operating Temperature	0 ~ 40°C / 32 ~ 104°F		
	Operating Humidity	Less than 80%		
	Storage Temperature	-20 ~ 60°C / -4 ~ 140°F		
	Storage Humidity	Less than 85%		

■ The specifications shown above may be changed without prior notice for quality improvement.

APPENDIX

MODELS		32LG6***	37LG6***	42LG6***	47LG6***
		32LG60UR-TA	37LG60UR-TA	42LG60FR-TA	47LG60FR-TA
Dimensions (Width x Height x Depth)	with stand	805.6 x 626 x 333 mm 31.7 x 24.6 x 13.1 inches	929 x 706.9 x 374.7 mm 36.6 x 27.8 x 14.8 inches	1037.8 x 794.6 x 379.5 mm 40.9 x 31.3 x 14.9 inches	1152.8 x 868.6 x 434.5 mm 45.4 x 34.2 x 17.1 inches
	without stand	805.6 x 587.4 x 96.2 mm 31.7 x 23.1 x 3.7 inches	929 x 665 x 98.7 mm 36.6 x 26.2 x 3.9 inches	1037.8 x 747 x 80.8 mm 40.9 x 29.4 x 3.2 inches	1152.8 x 820.8 x 79 mm 45.4 x 32.3 x 3.1 inches
Weight	with stand	14.4 kg / 31.7 lbs	18.1 kg / 39.9 lbs	21.4 kg / 47.2 lbs	32.8 kg / 72.3 lbs
	without stand	12.2 kg / 26.9 lbs	21.2 kg / 46.7 lbs	20.4 kg / 45 lbs	27.2 kg / 60 lbs
Power requirement		AC100-240V~ 50/60Hz	AC100-240V~ 50/60Hz	AC100-240V~ 50/60Hz	AC100-240V~ 50/60Hz
MODELS		42LG7***	47LG7***	52LG7***	
		42LG70YR-TA	47LG70YR-TA	52LG70YR-TA	
Dimensions (Width x Height x Depth)	with stand	1026.2 x 734.0 x 293.4 mm 40.4 x 28.8 x 11.5 inches	1140.4 x 820.1 x 342.9 mm 44.8 x 32.2 x 13.5 inches	1284.4 x 898.6 x 342.9 mm 50.5 x 35.3 x 13.5 inches	
	without stand	1026.2 x 687.9 x 111.8 mm 40.4 x 27.0 x 4.4 inches	1140.4 x 764.8 x 129.0 mm 44.8 x 30.1 x 5.0 inches	1284.4 x 844.6 x 129.5 mm 50.5 x 33.2 x 5.0 inches	
Weight	with stand	21.7 kg / 47.8 lbs	30.1 kg / 66.3 lbs	39.9 kg / 87.9 lbs	
	without stand	19.1 kg / 42.1 lbs	25.4 kg / 55.9 lbs	35.2 kg / 77.6 lbs	
Power requirement		AC100-240V~ 50/60Hz	AC100-240V~ 50/60Hz	AC100-240V~ 50/60Hz	
MODELS		32LG8***	42LG8***	47LG7***	
		32LG80UR-TA 32LG80FR-TA	42LG80FR-TA	47LG75QR-TA	
Dimensions (Width x Height x Depth)	with stand	830 x 581.3 x 232 mm 32.7 x 22.9 x 9.1 inches	1063 x 722.2 x 293.3 mm 41.9 x 28.4 x 11.5 inches	1140.4 x 820.1 x 342.9 mm 44.8 x 32.2 x 13.5 inches	
	without stand	830 x 518.7 x 108.5 mm 32.7 x 20.4 x 4.3 inches	1063 x 649 x 99 mm 41.9 x 25.6 x 3.9 inches	1140.4 x 764.8 x 129.0 mm 44.8 x 30.1 x 5.0 inches	
Weight	with stand	13.79 kg / 30.4 lbs	24.65 kg / 54.3 lbs	30.1 kg / 66.3 lbs	
	without stand	12.32 kg / 27.2 lbs	22.05 kg / 48.6 lbs	25.4 kg / 55.9 lbs	
Power requirement		AC100-240V~ 50/60Hz	AC100-240V~ 50/60Hz	AC100-240V~ 50/60Hz	
Television System		PAL/SECAM B/G/D/K, PAL I/II, NTSC-M			
Program Coverage		VHF: NZ1 ~ E21, UHF: E21 ~ E69, CATV: S1 ~ S20, HYPER: S21 ~ S47			
External Antenna Impedance		75 Ω			
Environment condition	Operating Temperature	0 ~ 40°C / 32 ~ 104°F			
	Operating Humidity	Less than 80%			
	Storage Temperature	-20 ~ 60°C / -4 ~ 140°F			
	Storage Humidity	Less than 85%			

■ The specifications shown above may be changed without prior notice for quality improvement.

PROGRAMMING THE REMOTE CONTROL

The remote control is a multi brand or universal remote. It can be programmed to operate most remote controlled devices from other manufacturers.

Note that the remote control may not control all models from other brands.

Programming a code into a remote mode

- 1** Testing your remote control.
To find out whether your remote control can operate other components without programming, turn on a component such as a **STB** and press the corresponding mode button (such as a **DVD** or **STB**) on the remote control, while pointing at the component. Test the **POWER** and **P** \wedge / \vee buttons to see if the component responds correctly. If the component does not operate correctly, the remote control requires programming to operate the device.
- 2** Switch on the component to be programmed, then press the corresponding mode button (such as a **DVD** or **STB**) on the remote control. The remote control button of the desired device is illuminated.
- 3** Press the **MENU** and **MUTE** buttons simultaneously, the remote control is ready to be programmed with the code.
- 4** Enter a code number using the number buttons on the remote control. Programming code numbers for the corresponding component can be found on the following pages. If the code is correct, the device will turn off.
- 5** Press the **MENU** button to store the code.
- 6** Test the remote control functions to see if the component responds correctly. If not, repeat from step 2.

APPENDIX

Programming code

(This feature is not available for all models.)

DVD

Brand	Codes	Brand	Codes	Brand	Codes
APEX DIGITAL	022	mitsubishi	002	RCA	005 006
DENON	020 014	NAD	023	SAMSUNG	011 015
GE	005 006	ONKYO	008 017	SONY	007
HARMAN KARDON	027	PANASONIC	003 009	THOMPSON	005 006
JVC	012	PHILIPS	013	TOSHIBA	019 008
LG	001 010 016 025	PIONEER	004 026	YAMAHA	009 018
MAGNAVOX	013	PROCEED	021	ZENITH	010 016 025
MARANTZ	024	PROSCAN	005 006		

HDSTB

Brand	Codes	Brand	Codes	Brand	Codes
ALPHASTAR DSR	123	HOUSTON TRACKER	033 037 039 051	REALISTIC	043 074
AMPLICA	050		057 104	SAMSUNG	123
Astro Philips(ML)	159	HUGHES	068	SATELLITE SERVICE CO	028 035 047 057
Astro Thompson(ML)	160	Humax(SL)	158		085
Astro Nokia(ML)	161	JANIEL	060 147	Samart(TH)	156
BIRDVIEW	051 126 129	JERROLD	061	SCIENTIFIC ATLANTA	032 138
CHANNEL MASTER	013 014 015 018	KATHREIN	108	SONY	103
	036 055	LEGEND	057	STARCAST	041
CHAPARRAL	008 009 012 077	LG	001	SUPER GUIDE	020 124 125
CITOH	054	LUTRON	132	TEECOM	023 026 075 087
CURTIS MATHES	050 145	LUXOR	062 144		088 090 107 130
DRAKE	005 006 007 010	MACOM	010 059 063 064		137
	011 052 112 116		065	TOSHIBA	002 127
	141	MEMOREX	057	True Vision(TH)	155
DX ANTENNA	024 046 056 076	NEXTWAVE	028 124 125	UBC(TH)	153
ECHOSTAR	038 040 057 058	NORSAT	069 070	UBC/SAMART(TH)	154
	093 094 095 096	PACE SKY SATELLITE	143	UNIDEN	016 025 042 043
	097 098 099 100	PANASONIC	060 142		044 045 048 049
	122	PANSAT	121		078 079 080 086
ELECTRO HOME	089	PERSONAL CABLE	117		10 135 136
EUROPLUS	114	PHILIPS	071	VIEWSTAR	115
FUJITSU	017 021 022 027	PICO	105	VTC(VN)	162
	133 134	PRESIDENT	019 102	WINEGARD	128 146
GENERAL INSTRUMENT	003 004 016 029	PRIMESTAR	030 110 111	ZENITH	081 082 083 084
	031 059 101	PROSAT	072		091 120
HITACHI	139 140	PSI(TH)	157		
		RCA	066 106		

IR CODES

1. How to Connect

- Connect your wired remote control to the Remote Control port on the TV.

2. Remote Control IR Codes

■ Output waveform

Single pulse, modulated with 37.917KHz signal at 455KHz

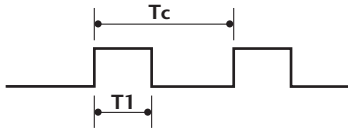

Carrier frequency
 $FCAR = 1/Tc = fOSC/12$
 Duty ratio = $T1/Tc = 1/3$

■ Configuration of frame

1st frame

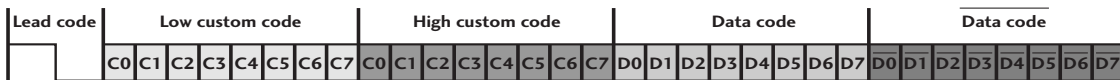

Repeat frame

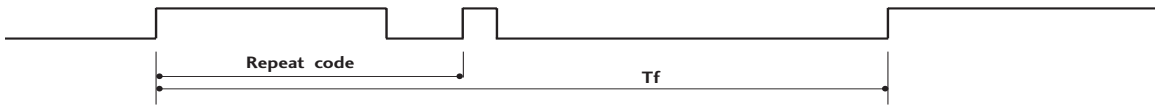

■ Lead code

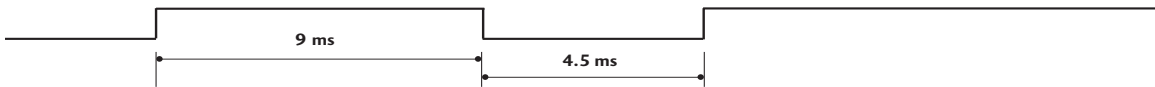

■ Repeat code

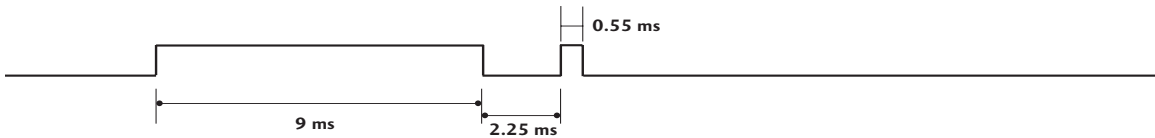

■ Bit description



■ Frame interval: Tf

The waveform is transmitted as long as a key is depressed.

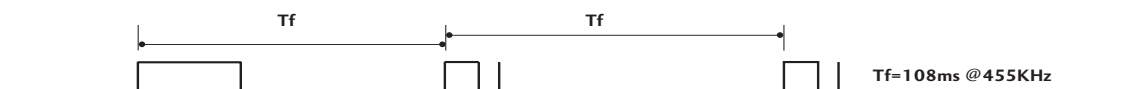

APPENDIX

Code (Hexa)	Function	Note	Code (Hexa)	Function	Note
0B	INPUT	R/C Button	09	MUTE	R/C Button
08	POWER	R/C Button (Power On/Off)	53	LIST	R/C Button
60	PIP	R/C Button	10 ~ 19	Number Key 0 ~ 9	R/C Button
43	MENU	R/C Button	1E	FAV	R/C Button
5B	RETURN	R/C Button	1A	Q.VIEW	R/C Button
07	<	R/C Button	20	TEXT	R/C Button
06	>	R/C Button	B0	SIZE	R/C Button
40	^	R/C Button	8F	INDEX	R/C Button
41	∨	R/C Button	B1	TIME	R/C Button
44	OK	R/C Button	BD	REVEAL	R/C Button
72	RED	R/C Button	8E	HOLD	R/C Button
71	GREEN	R/C Button	BA	UPDATE	R/C Button
63	YELLOW	R/C Button	7E	SIMPLINK	R/C Button
61	BLUE	R/C Button	B1	■ Stop	R/C Button
02	▴ +	R/C Button	B0	▶ Play	R/C Button
03	▾ -	R/C Button	BA	Pause	R/C Button
00	P ^	R/C Button	8F	◀◀ Rew	R/C Button
01	P ∨	R/C Button	8E	▶▶ FF	R/C Button
30	AV MODE	R/C Button	45	Q.MENU	R/C Button
7C	X STUDIO	R/C Button	BD	● (Record)	R/C Button

EXTERNAL CONTROL THROUGH RS-232C (ONLY PLASMA TV MODELS)

Connect the RS-232C input jack to an external control device (such as a computer or an A/V control system) and control the TV's functions externally.

Connect the serial port of the control device to the RS-232C jack on the TV back panel.

RS-232C connection cables are not supplied with the TV.

RS-232C Setup

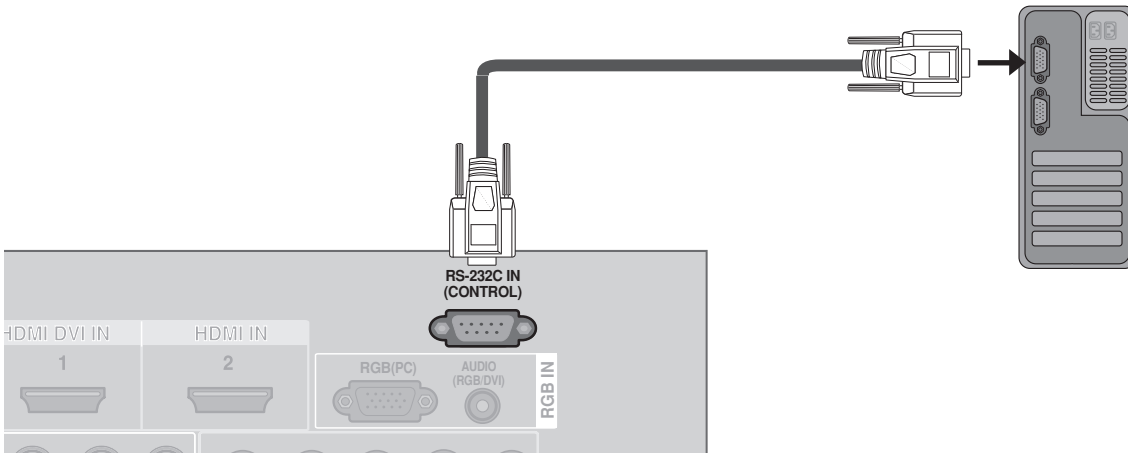

Type of Connector; D-Sub 9-Pin Male

No.	Pin Name
1	No connection
2	RXD (Receive data)
3	TXD (Transmit data)
4	DTR (DTE side ready)
5	GND
6	DSR (DCE side ready)
7	RTS (Ready to send)
8	CTS (Clear to send)
9	No Connection

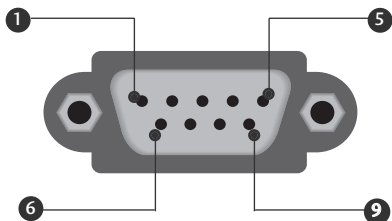

APPENDIX

RS-232C Configurations

7-Wire Configurations (Standard RS-232C cable)

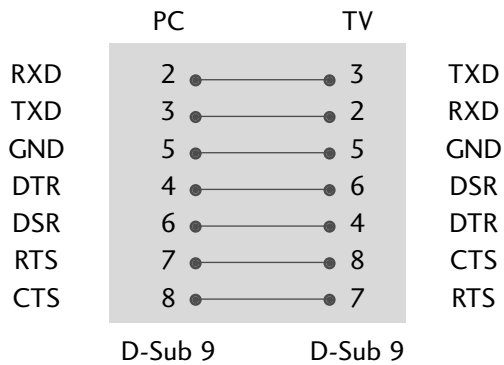

3-Wire Configurations (Not standard)

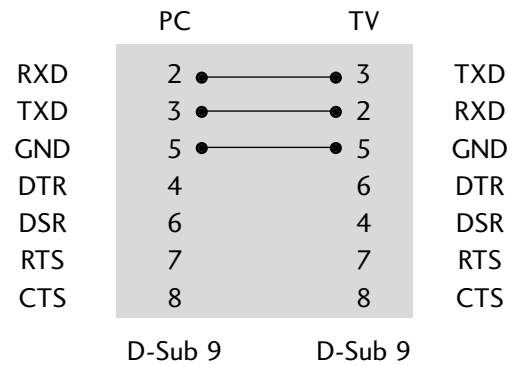

Set ID (Only Plasma TV models)

Use this function to specify a set ID number.
Refer to 'Real Data Mapping' 1. See page p.112.

1 Press the **MENU** button and then use \wedge / \vee button to select the **OPTION** menu.

2 Press the \gt button and then use \wedge / \vee button to select **Set ID**.

3 Press the \gt button and then use \lt / \gt button to adjust **Set ID** to choose the desired TV ID number.
• The adjustment range of SET ID is 1~99.

4 Press the **MENU** button to return to normal TV viewing.
Press the **RETURN** button to move to the previous menu screen.

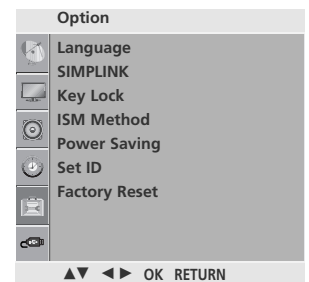

1



2 3

Communication Parameters

- Baud rate : 9600 bps (UART)
- Data length : 8 bits
- Parity : None
- Stop bit : 1 bit
- Communication code : ASCII code
- Use a crossed (reverse) cable.

Command Reference List

	COMMAND1	COMMAND2	DATA (Hexadecimal)		COMMAND1	COMMAND2	DATA (Hexadecimal)
01. Power	k	a	00 ~ 01	15. Balance	k	t	00 ~ 64
02. Aspect Ratio	k	c	Refer to p.110	16. Colour Temperature	k	u	00 ~ 03
03. Screen Mute	k	d	00 ~ 01	17. Red Adjustment	k	v	00 ~ 3C
04. Volume Mute	k	e	00 ~ 01	18. Green Adjustment	k	w	00 ~ 3C
05. Volume Control	k	f	00 ~ 64	19. Blue Adjustment	k	\$	00 ~ 3C
06. Contrast	k	g	00 ~ 64	20. Abnormal Status	k	z	FF
07. Brightness	k	h	00 ~ 64	21. ISM Method	j	p	Refer to p.112
08. Colour	k	i	00 ~ 64	22. Power Saving	j	q	00 ~ 04
09. Tint	k	j	00 ~ 64	23. Auto Configure	j	u	01
10. Sharpness	k	k	00 ~ 64	24. Equalize	j	v	Refer to p.112
11. OSD Select	k	l	00 ~ 01	25. Tune Command	m	a	Refer to p.113
12. Remote Control Lock /Key Lock Mode	k	m	00 ~ 01	26. Channel Skip	m	b	00 ~ 01
13. PIP/DW	k	n	00 ~ 03	27. Key	m	c	Key Code
14. PIP Position	k	q	00 ~ 03	28. Input select (Main)	x	b	Refer to p.113
				29. Input select(PIP)	x	y	Refer to p.113

Transmission / Receiving Protocol

Transmission

[Command1][Command2][][Set ID][][Data][Cr]

[Command 1] : First command to control the set.(j,k,m or x)

[Command 2] : Second command to control the set.

[Set ID] : You can adjust the set ID to choose desired TV ID number in Setup menu. Adjustment range is 1 ~ 99. When selecting Set ID '0', every connected TV is controlled. Set ID is indicated as decimal (1 ~ 99) on menu and as Hexa decimal (0x0 ~ 0x63) on transmission/receiving protocol.

[DATA] : To transmit command data.

Transmit 'FF' data to read status of comand.

[Cr] : Carriage Return

ASCII code '0x0D'

[] : ASCII code 'space (0x20)'

OK Acknowledgement

[Command2][][Set ID][][OK][Data][x]

The TV transmits ACK (acknowledgement) based on this format when receiving normal data. At this time, if the data is data read mode, it indicates present status data. If the data is data write mode, it returns the data of the PC computer.

Error Acknowledgement

[Command2][][Set ID][][NG][Data][x]

TV transmits ACK(acknowledgement) based on this format when receiving abnormal data form non-viable functions or communication errors.

[Command 2] : use as command.

[Set ID]: use the small character, if set ID is 10, TV will send the '0', 'a'

[Data]: use the small character, if data is 0xab, TV will send the 'a', 'b'.

[NG]: use the large character.

APPENDIX

01. Power (Command: k a)

To control Power On/Off of the TV.

Transmission [k][a][][Set ID][][Data][Cr]

Data 00 : Power Off Data 01 : Power On

Acknowledgement [a][][Set ID][][OK/NG][Data][x]

To show Power On/Off.

Transmission [k][a][][Set ID][][FF][Cr]

Acknowledgement [a][][Set ID][][OK/NG][Data][x]

* If there is the time delay between command and ack message during power on sequence, It should be described like "Note: In this model, TV will send the Acknowledge after power on processing completion. There might be a time delay between command and acknowledge."

02. Aspect Ratio (Command: k c) (Main picture size)

To adjust the screen format. (Main picture format)

You can adjust the screen format using the Aspect Ratio in the Picture menu.

Transmission [k][c][][Set ID][][Data][Cr]

Data 01: Normal screen (4:3) Data 06: Original

Data 02: Wide screen (16:9) Data 07: 14:9

Data 04: Zoom1 Data 09: Just Scan

Data 05: Zoom2

Acknowledgement [c][][Set ID][][OK/NG][Data][x]

* Using the RGB-PC, Component or HDMI input, you select either 16:9 or 4:3 screen aspect ratio.

* In HDMI/Component (over 720p) mode, **Just Scan** is available.

03. Screen Mute (Command: k d)

To select screen mute on/off.

Transmission [k][d][][Set ID][][Data][Cr]

Data 00 : Screen mute off (Picture on)

Data 01 : Screen mute on (Picture off)

Acknowledgement [d][][Set ID][][OK/NG][Data][x]

04. Volume Mute (Command: k e)

To control volume mute on/off.

You can also adjust mute using the MUTE button on remote control.

Transmission [k][e][][Set ID][][Data][Cr]

Data 00 : Volume mute on (Volume off)

Data 01 : Volume mute off (Volume on)

Acknowledgement [e][][Set ID][][OK/NG][Data][x]

05. Volume Control (Command: k f)

To adjust volume.

You can also adjust volume with the volume buttons on remote control.

Transmission [k][f][][Set ID][][Data][Cr]

Data Min : 00 ~ Max : 64

Refer to 'Real data mapping 1' : See page 112.

Acknowledgement [f][][Set ID][][OK/NG][Data][x]

06. Contrast (Command: k g)

To adjust screen contrast.

You can also adjust contrast in the Picture menu.

Transmission [k][g][][Set ID][][Data][Cr]

Data Min : 00 ~ Max : 64

Refer to 'Real data mapping 1'. See page 112.

Acknowledgement [g][][Set ID][][OK][Data][x]

07. Brightness (Command: k h)

To adjust screen brightness.

You can also adjust brightness in the Picture menu.

Transmission [k][h][][Set ID][][Data][Cr]

Data Min : 00 ~ Max : 64

Refer to 'Real data mapping 1'. See page 112.

Acknowledgement [h][][Set ID][][OK/NG][Data][x]

08. Colour (Command: k i)

To adjust the screen colour.

You can also adjust colour in the Picture menu.

Transmission [k][i][][Set ID][][Data][Cr]

Data Min : 00 ~ Max : 64

Refer to 'Real data mapping 1'. See page 112.

Acknowledgement [i][][Set ID][][OK/NG][Data][x]

09. Tint (Command: k j)

To adjust the screen tint.

You can also adjust tint in the Picture menu.

Transmission [k][j][][Set ID][][Data][Cr]

Data Red : 00 ~ Green : 64

Refer to 'Real data mapping 1'. See page 112.

Acknowledgement [j][][Set ID][][OK/NG][Data][x]

10. Sharpness (Command: k k)

To adjust the screen sharpness.

You can also adjust sharpness in the Picture menu.

Transmission [k][k][][Set ID][][Data][Cr]

Data Min: 00 ~ Max: 64

Refer to 'Real data mapping 1'. See page 112.

Acknowledgement [k][][Set ID][][OK/NG][Data][x]

11. OSD Select (Command: k l)

To select OSD (On Screen Display) on/off when controlling remotely.

Transmission [k][l][][Set ID][][Data][Cr]

Data 00: OSD off

Data 01: OSD on

Acknowledgement [l][][Set ID][][OK][Data][x]

12. Remote Control Lock/Key Lock Mode (Command: k m)

To lock the remote control and the front panel controls on the set.

Transmission [k][m][][Set ID][][Data][Cr]

Data 00: Lock off

Data 01: Lock on

Acknowledgement [m][][Set ID][][OK/NG][Data][x]

13. PIP / DW (Command: k n)

To control the PIP (Picture In picture)/DW.

You can also control the PIP/DW using the PIP button on the remote control or in the PIP/DW menu.

Transmission [k][n][][Set ID][][Data][Cr]

Data 00: PIP/DW off

Data 01: PIP

Data 02: DW1

Data 03: DW2

Acknowledgement [n][][Set ID][][OK/NG][Data][x]

14. PIP Position (Command: k q)

To select sub picture position for PIP.

You can also adjust the sub picture position using PIP button on the remote control or in the PIP/DW menu.

Transmission [k][q][][Set ID][][Data][Cr]

Data 00: Right down on screen

Data 01: Left down on screen

Data 02: Left up on screen

Data 03: Right up on screen

Acknowledgement [q][][Set ID][][OK/NG][Data][x]

15. Balance (Command: k t)

To adjust balance.

You can also adjust balance in the Audio menu.

Transmission [k][t][][Set ID][][Data][Cr]

Data Min: 00 ~ Max: 64

Refer to 'Real data mapping 1'. See page 112.

Acknowledgement [t][][Set ID][][OK/NG][Data][x]

16. Colour Temperature (Command: k u)

To adjust colour temperature.

You can also adjust Colour Temperature in the Picture menu.

Transmission [k][u][][Set ID][][Data][Cr]

Data 00: Medium 01: Cool 02: Warm 03: User

Acknowledgement [u][][Set ID][][OK/NG][Data][x]

17. Red Adjustment (Command: k v)

To adjust red in colour temperature.

Transmission [k][v][][Set ID][][Data][Cr]

Data Min: 00 ~ Max: 3C

Refer to 'Real data mapping 2'. See page 112.

Acknowledgement [v][][Set ID][][OK/NG][Data][x]

18. Green Adjustment (Command: k w)

To adjust green in colour temperature.

Transmission [k][w][][Set ID][][Data][Cr]

Data Min: 00 ~ Max: 3C

Refer to 'Real data mapping 2'. See page 112.

Acknowledgement [w][][Set ID][][OK/NG][Data][x]

19. Blue Adjustment (Command: k \$)

To adjust blue in colour temperature.

Transmission [k][\$][][Set ID][][Data][Cr]

Data Min: 00 ~ Max: 3C

Refer to 'Real data mapping 2'. See page 112.

Acknowledgement [\$][][Set ID][][OK/NG][Data][x]

25. Tune Command (Command: m a)

Tune Channel to following Physical/major/minor number

```
Transmission [m][a][ ][Set ID][ ][Data0][ ][Data1]
           [ ][Data2][Cr]
```

Data 0: Min: 00H ~ Max: 63H
 (* transmit by Hexadecimal code)
 Data 1: Don't care
 Data 2: 0 : Main
 1 : Sub

```
Acknowledgement [a][ ][Set ID][ ][OK][Data0][Data1][x]
                [a][ ][Set ID][ ][NG][Data0][x]
```

26. Channel Skip(Command: m b)

► To set skip status for the current Programme.

```
Transmission [m][b][ ][Set ID][ ][Data][Cr]
```

Data 00 : Skip 01 : Add

```
Acknowledgement [b][ ][Set ID][ ][OK/NG][Data][x]
```

27. Key (Command: m c)

To send IR remote key code.

```
Transmission [m][c][ ][Set ID][ ][Data][Cr]
```

Data: Key code - Refer to page 106.

```
Acknowledgement [c][ ][Set ID][ ][OK/NG][Data][x]
```

28. Input select (Command: x b)**(Main Picture Input)**

To select input source for TV.

```
Transmission [x][b][ ][Set ID][ ][Data][Cr]
```

Data: Structure

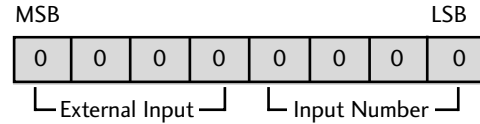

External Input				Data
0	0	0	1	Analog
0	0	1	0	AV
0	1	0	0	Component
0	1	1	0	RGB-PC
1	0	0	1	HDMI

Input Number				Data
0	0	0	0	Input1
0	0	0	1	Input2
0	0	1	0	Input3
0	0	1	1	Input4

```
Acknowledgement [b][ ][Set ID][ ][OK/NG][Data][x]
```

29. Input select (Command: x y)

To adjust input source for sub picture in PIP mode

```
Transmission [x][y][ ][Set ID][ ][Data][Cr]
```

Data: Structure

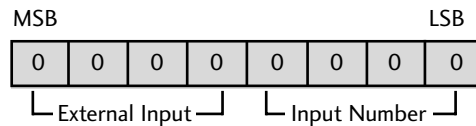

External Input				Data
0	0	0	1	Analog
0	0	1	0	AV

Input Number				Data
0	0	0	0	Input1
0	0	0	1	Input2
0	0	1	0	Input3
0	0	1	1	Input4

```
Acknowledgement [y][ ][Set ID][ ][OK/NG][Data][x]
```

LG Electronics Inc.