

# Table of Contents

<b>Introduction</b>	Registration	4
	Important Safety Instruction	4
	Identification of Parts	16
<b>Installation</b>	Installation	17
	Starting	17
<b>Operation</b>	Temperature Control	18
	• Display Panel	18
	• How to adjust the temperature in the refrigerator and freezer compartment	19
	• Fresh Drawer(Optional)	19
	Function	20
	• Super Freezer	20
	• Vacation	20
	• Lock	20
	• On/Off	21
	• Memory feature	21
	• Door Alarm	21
	• Self Test	21
	Ice Making	21
Defrosting	21	
<b>Suggestion On Food storage</b>	Storing Food	22
<b>Care and Maintenance</b>	General Information	23
	Lamp Replacement	23
	Cleaning	24
<b>Trouble Shooting</b>	Trouble Shooting	25
<b>To Reverse the Doors</b>	Precaution	27
	How to Reverse the Door	27

**Introduction**

## Registration

The model and serial number are found on the rear of this unit. This number is unique to this unit and not available to others. You should record requested information here and retain this guide as a permanent record of your purchase. Staple your receipt here.

Date of Purchase : \_\_\_\_\_

Dealer Purchased From : \_\_\_\_\_

Dealer Address : \_\_\_\_\_

Dealer Phone No. : \_\_\_\_\_

Model No. : \_\_\_\_\_

Serial No. : \_\_\_\_\_

## Important Safety Instruction

### BASIC SAFETY PRECAUTIONS

This guide contains many important safety messages. Always read and obey all safety messages.

**▲** This is the safety alert symbol. It alerts you to safety messages that inform you of hazards that can kill or hurt you or others or cause damage to the product. All safety messages will be preceded by the safety alert symbol and the hazard signal word DANGER, WARNING, or CAUTION. These words mean:

**▲ DANGER** You will be killed or seriously injured if you don't follow instructions.

**▲ WARNING** You can be killed or seriously injured if you don't follow instructions.

**▲ CAUTION** Indicates an imminently hazardous situation which, if not avoided, may result in minor or moderate injury, or product damage only.

All safety messages will identify the hazard, tell you how to reduce the chance of injury, and tell you what can happen if the instructions are not followed.

## Important Safety Instruction

### **⚠ WARNING**

To reduce the risk of fire, electric shock, or injury to persons when using your product, basic safety precautions should be followed, including the following. Read all instructions before using this appliance.

#### **1. When connecting the power**

##### **The dedicated outlet should be used.**

- Using several devices at one outlet may cause fire.
- The electric leakage breaker may damage food and the dispenser may be leaked.



##### **Do not allow the power plug to face upward or to be squeezed at the back of the fridge-freezer.**

Water may be flown into or the plug may be damaged, which causes fire or electric shock.

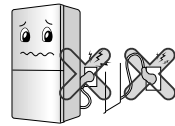

##### **Do not allow the power cord bent or pressed by the heavy object to be damaged.**

It may damage the power cord to cause fire or electric shock.



##### **Do not extend or modify the length of the power plug.**

It causes electric shock or fire by the electric damage of the power cord or others.



##### **Unplug the power plug when cleaning, handling or replacing the interior lamp of the fridge-freezer.**

- It may cause electric shock or injury.
- When replacing the interior lamp of the fridge-freezer, make sure that the rubber ring for preventing the electric spark within the socket is not taken off.



## Important Safety Instruction

**Do not pull out the cord or touch the power plug with wet hands.**

- It may cause electric shock or injury.



**Remove water or dust from the power plug and insert it with the ends of the pins securely connected.**

Dust, water or unstable connection may fire or electric shock.

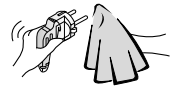

**Make sure of grounding.**

The incorrect grounding may cause breakdown and electric shock.

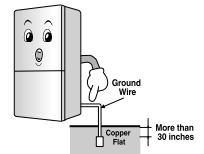

**When the power cord or the power plug is damaged or the holes of the outlet are loosed, do not use them.**

It may cause electric shock or short circuit to make fire.

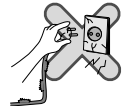

## 2. When using the fridge-freezer

**Do not place the heavy object or the dangerous object (container with liquid) on the fridge-freezer.**

It may be dropped to cause injury, fire or electric shock when opening or closing the door.



**Do not cling to the door or the shelves of the door or the home bar of the freezer or the cool chamber.**

It may make the fridge-freezer fallen down or damage the hands. Especially, do not allow the children to do the above.



## Important Safety Instruction

**Do not install the fridge-freezer in the wet place or the place which water or rain splashes.**

Deterioration of insulation of electric parts may cause electric leakage.



**Do not use or store inflammable materials ether, benzene, alcohol, medicine, LP gas, spray or cosmetics near or in the fridge-freezer.**

It may cause explosion or fire.

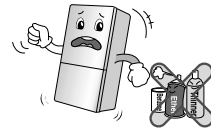

**Do not place the lit candle within the fridge-freezer to deodorize.**

It may cause explosion or fire.



**Do not store the medicine or the academic materials at the fridge-freezer.**

When the material with the strict temperature control is stored, it may be deteriorated or it may make an unexpected reaction to cause any risk.

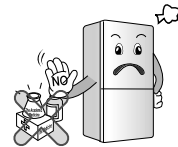

**Do not use the combustible spray near the fridge-freezer.**

It may cause fire.



## Important Safety Instruction

### Avoid the heating devices.

It may cause fire.

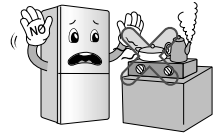

### Do not place flower vase, cup, cosmetics, medicine or any container with water on the fridge-freezer.

It may cause fire, electric shock or injury by dropping down.

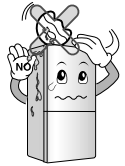

### Use the submerged fridge-freezer after checking it.

It may cause electric shock or fire.

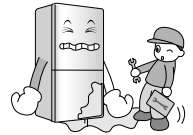

### When gas is leaked, do not touch the fridge-freezer or the outlet and ventilate the room immediately.

- The explosion by spark may cause fire or burn.
- Because this fridge-freezer uses natural gas (isobutene, R600a) as the environment-friendly refrigerant, even a small amount (80~90g) is combustible. When the gas is leaked by the severe damage during delivering, installing or using the fridge-freezer, any spark may cause fire or burn.

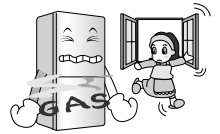

### Do not spray water at the outside or the inside of the fridge-freezer or do not clean it with benzene or thinner.

Deterioration of insulation of electric parts may cause electric shock or fire.



## Important Safety Instruction

**When any strange smell or smoke is detected from the fridge-freezer, disconnect the power plug immediately and contact to the service center.**  
It may cause fire.

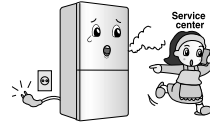

**Do not allow any person except the qualified engineer to disassemble, repair or alter the fridge-freezer.**  
It may cause injury, electric shock or fire.

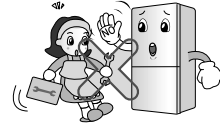

**Do not use the fridge-freezer for non-domestic purpose (storing medicine or testing material, using at the ship, etc.).**

It may cause an unexpected risk such as fire, electric shock, deterioration of stored material or chemical reaction.

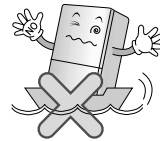

**When disposing the fridge-freezer, remove the packing materials from the door.**  
It may cause to lock out the child.



**Install the fridge-freezer on the solid and level floor.**  
Installing it on the unstable place may cause death by falling down the fridge-freezer when opening or closing the door.



## Important Safety Instruction

**Do not insert the hands or the metal stick into the exit of cool air, the cover, the bottom of the fridge-freezer, the heatproof grill (exhaust hole) at the backside.**

It may cause electric shock or injury.

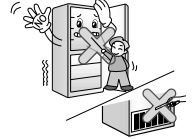

**When you want to dispose the fridge-freezer, contact to the down-block office.**

When you want to dispose the large living waste such as electric home appliance and furniture, you'd better contact the local down-block office.



### **⚠ CAUTION**

Violating this direction may cause injury or damage house or furniture. Always be careful, please.

**Do not touch food or containers at the freezer with wet hands.**

It may cause frostbite.



**Wait for 5 minutes or longer when reconnecting the plug.**

It may cause the operation of the freezer to fail.

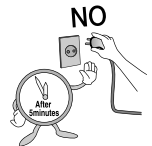

**Do not put bottle in the freezer.**

It may freeze the contents to break the bottle to cause injury.



**Pull out the power plug not by grasping the cord but the plug of its end.**

It may cause electric shock or short circuit to fire.





## Important Safety Instruction

### Do not install the fridge-freezer in the wet place or the place which water or rain splashes.

Deterioration of insulation of electric parts may cause electric leakage.



### Do not insert the hands into the bottom of the fridge-freezer.

The iron plate of the bottom may cause injury.



### Carry the fridge-freezer with the handle bar at the bottom of the front and the top of the rear.

Otherwise, your hands may be slipped to cause injury.

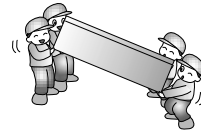

### Because opening or closing the door of the fridge-freezer may cause injury to the person around it, be careful, please.

Opening or closing the door may cause feet or hands to be caught in the chink in door or the child to be get hurt by the corner.

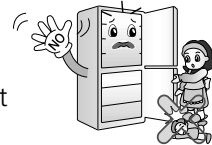

### Do not put any living animal in the fridge-freezer.

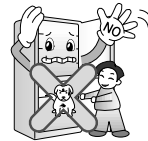

## ⚠ CAUTION

This appliance is not intended for use by persons (including children) with reduced physical, sensory or mental capabilities, or lack of experience and knowledge, unless they have been given supervision or instruction concerning use of the appliance by a person responsible for their safety.

Children should be supervised to ensure that they do not play with the appliance.

## Important Safety Instruction

### **⚠ WARNING**

#### **Precaution**

- This fridge-freezer must be properly installed and located in accordance with the Installation Instruction before it is used.
- Never unplug your fridge-freezer by pulling on the power cord. Always grip plug firmly and pull straight out from the outlet.
- When moving your appliance away from the wall, be careful not to roll over or damage the power cord.
- After your fridge-freezer is in operation, do not touch the cold surfaces in the freezer compartment, particularly when hands are damp or wet. Skin may adhere to these extremely cold surfaces.
- Pull out the power plug prior to cleaning the fridge-freezer.  
Never damage, severely bend, pull out, or twist the power cord because power cord damage may cause a fire or electronic shock.  
Never place glass products in the freezer because they may be broken when their inner contents are frozen.
- Do not directly spray water inside or outside the fridge/freezer.  
There is a risk of explosion or fire.
- Do not insert the power plug with wet hands.  
You may receive an electric shock.
- Do not put a container filled with water on top of the appliance.  
If the water spills on to any electrical parts, it may lead to fire or electric shock.
- Do not install the fridge/freezer in a damp place, where it could be splashed with water.  
Incorrect insulation of the electrical parts may cause an electric shock or fire.

## Important Safety Instruction

- Do not disassemble, repair or alter the appliance. It may cause fire or abnormal operations, which may lead to injury.
- Pull the power plug out of the socket before replacing the interior light in the refrigerator. Otherwise, there is a risk of electric shock.
- If possible, connect the fridge-freezer to its own individual electrical outlet to prevent it and other appliances or household lights from causing an overload.

It will cause electric shock or fire.

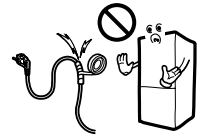

If possible, connect the fridge-freezer to its own individual electrical outlet to prevent it and other appliances or household lights from causing an overload.

The supply plug of the refrigerator-freezer should be placed in easy accessible position for quick disconnection in emergency.

If the supply cord is damaged, it must be replaced by the manufacturer or its service agent or a similarly qualified person in order to avoid a hazard.

Risk of child entrapment.

Before you throw away your old refrigerator or freezer:  
Take off the doors.

Leave the shelves in place so that children may not easily climb inside.

Don't store or use gasoline or other flammable vapors and liquids in the vicinity of this or any other appliance. In the event of an electric short circuit, grounding (earthing) reduces the risk of electric shock by providing an escape wire for the electric current. In order to prevent possible electric shock, this appliance must be grounded. Improper use of the grounding plug can result in an electric shock. Consult a qualified electrician or service person if the grounding instructions are not completely understood, or if you have doubts on whether the appliance is properly grounded.

**Do not modify or extend the Power Cord length**

**Don't Use on Extension Cord**

**Accessibility of Supply Plug**

**Supply Cord Replacement**

**⚠ DANGER**

**Don't store**

**Grounding (Earthing)**

# Important Safety Instruction

## **⚠ WARNING**

- ⚠ Keep ventilation openings, in the appliance enclosure or in the built-in structure, clear of obstruction.
- ⚠ Do not use mechanical devices or other means to accelerate the defrosting process, other than those recommended by the manufacturer.
- ⚠ Do not damage the refrigerant circuit.
- ⚠ Do not use electrical appliances inside the food storage compartments of the appliance, unless they are of the type recommended by the manufacturer.
- ⚠ The refrigerant and insulation blowing gas used in the appliance require special disposal procedures. When disposal, please consult with service agent or a similarly qualified person.



This appliance contains a small amount of isobutane refrigerant (R600a), natural gas with high environmental compatibility, but it is also combustible. When transporting and installing the appliance, care should be taken to ensure that no parts of the refrigerating circuit are damaged. Refrigerant squirting out of the pipes could ignite or cause an eye injury. If a leak is detected, avoid any naked flames or potential sources of ignition and air the room in which the appliance is standing for several minutes.

In order to avoid the creation of a flammable gas air mixture if a leak in the refrigerating circuit occurs, the size of the room in which the appliance may be sited depends on the amount of refrigerant used. The room must be 1m<sup>2</sup> in size for every 8g of R600a refrigerant inside the appliance. The amount of refrigerant in your particular appliance is shown on the identification plate inside the appliance.

Never start up an appliance showing any signs of damage. If in doubt, consult your dealer.

## Important Safety Instruction

### **⚠ CAUTION**

- If the wall socket is loose, do not insert the power plug.  
It may cause electric shock or fire.
- Never unplug your refrigerator by pulling on the power cord. Always grip plug firmly and pull it straight out from the outlet.  
You may disconnect a wire and cause a short circuit.
- Do not use a wet or damp cloth when cleaning the plug. Remove any foreign matter from the power plug pins.  
Otherwise, there is a risk of fire.
- Do not put your hands into the bottom area of the appliance.  
Any Sharp edges may cause personal injury..
- After unplugging the appliance, wait for at least five minutes before plugging it again to the wall socket.  
Abnormal operation of the freezer may cause material damage.
- If the appliance is not to be used for a long time, pull out the power plug.  
Any deterioration in the insulation may cause fire.
- Do not let children touch or play with the control panel on the front of the appliance.
- The refrigerant used in fridge/freezer and the gases in the insulation material require special disposal procedures. Ensure that none of the pipes on the back of the appliances are damaged prior to disposal.

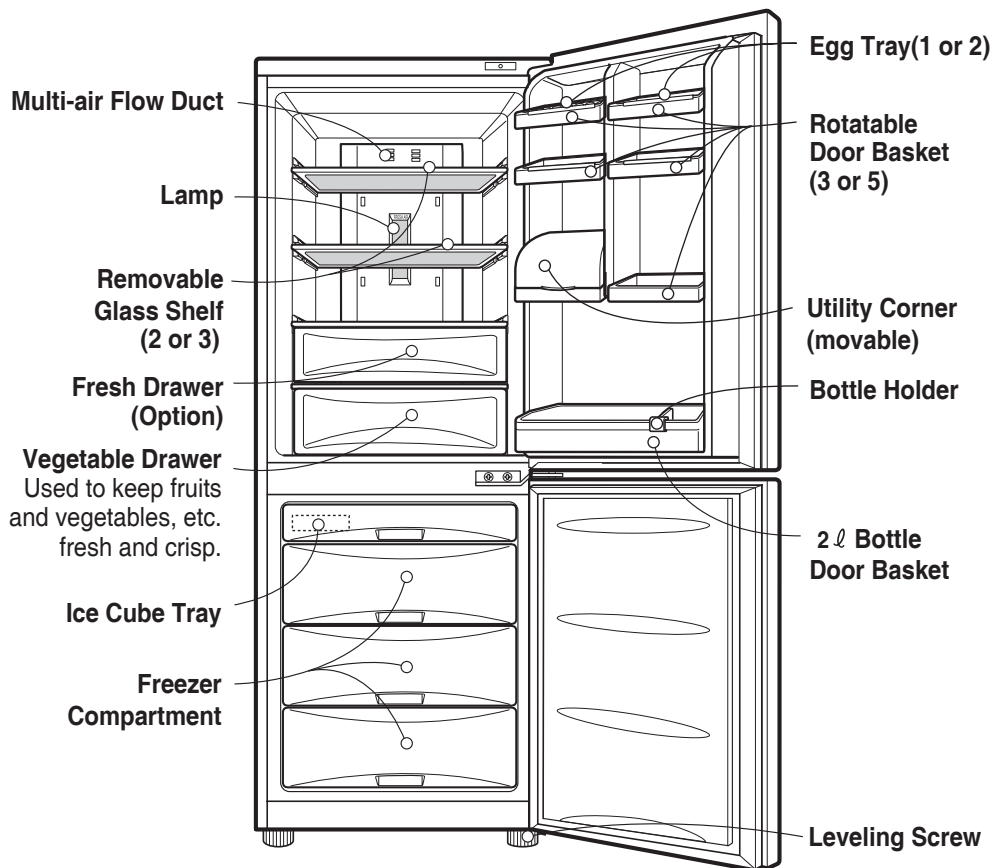

## Identification of Parts



**Note**

If you find some parts missing from your unit, they may be parts only used in other models.

## Installation

1. Select a good location.  
Place your fridge-freezer where it is easy to use.
2. Avoid placing the unit near heat sources, direct sunlight or moisture.
3. There must be proper air circulation around your fridge-freezer to keep it operating efficiently.
4. To avoid vibration, the unit must be leveled.  
If required, adjust the leveling screws to compensate for the uneven floor.  
The front should be slightly higher than the rear to aid in door closing.  
Leveling screws can be turned easily by tipping the cabinet slightly.  
Turn the leveling screws counterclockwise(  ) to raise the unit, clockwise(  ) to lower it.
5. Clean your fridge-freezer thoroughly and wipe off all dust accumulated during shipping.
6. Install accessories such as ice cube box, etc., in their proper places.They are packed together to prevent possible damage during shipment.
7. Connect the power supply cord (or plug) to the outlet.  
Don't double up with other appliances on the same outlet.
8. To ensure proper air circulation around the fridge - freezer, please maintain sufficient space on both the sides as well as top and maintain at least 2 inches (5 cm) from the rear wall.

## Starting

When your fridge-freezer is installed, allow it 2-3 hours to stabilize at normal operating temperature prior to filling it with fresh or frozen foods.  
If power plug is disconnected, allow 5 minutes delay before restarting.  
Your fridge-freezer is now ready for use.

## Temperature Control

Your fridge-freezer has two controls that let you regulate the temperature in the fridge and freezer compartments.

### Display Panel

Display Panel For Temperature Control

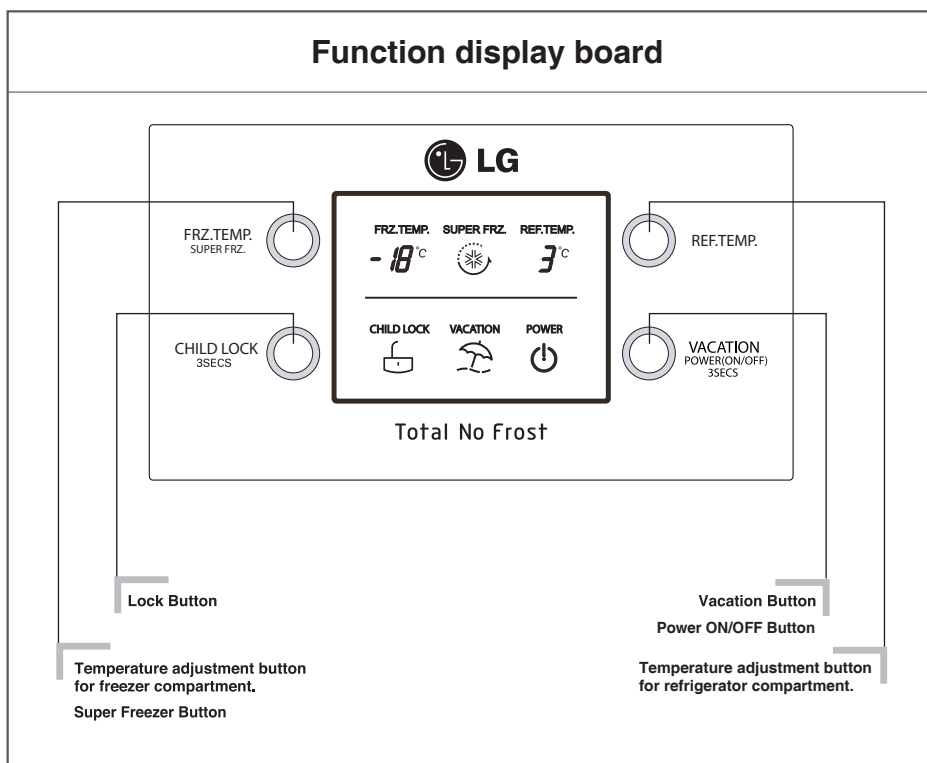



## How to adjust the temperature in the refrigerator and freezer compartment

- You can now adjust the temperature of the refrigerator and freezer compartment as you want.

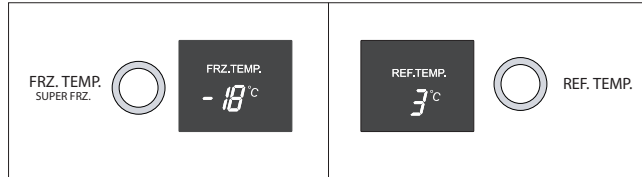

- When you press the temperature control buttons, the temperature of Refrigerator and Freezer compartment is repeated in the following order.

Refrigerator Compartment :

0°C → 1°C → 2°C → 3°C → 4°C → 5°C → 6°C → 0°C

Freezer Compartment :

-19°C → -20°C → -21°C → -22°C → -23°C →  
 -27°C (SUPER FRZ.) → -15°C → -16°C → -17°C → -18°C  
 → -19°C

## Fresh Drawer (Option)

- This drawer is designed to set up 2°C lower than the temperature of the refrigerator compartment to keep the contents fresh for longer period. When setting up the refrigerator temperature (REF. TEMP.) to 2°C, the temperature in the fresh drawer is about 0°C.



### Note

The actual inner temperature varies depending on the food status, as the indicated setting temperature is a target temperature, not actual temperature within refrigerator.

Refrigeration function is weak in the initial time. Please adjust temperature as above after using refrigerator for minimum 2~3 days.



## Super Freezer

### Function

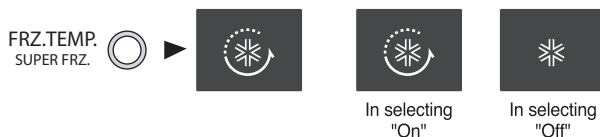
- This function is used when you want to freeze the foods quickly. Press the  button repeatedly. When the 'FRZ.TEMP.' light is -27°C, the quick freeze operation starts with the 'SUPER FRZ.' light on.
- The Super Freeze operation takes about 3 hours. When its operation ends, it automatically returns to the -23°C. If you want to stop the quick freeze operation, press the  button. When the 'FRZ.TEMP.' light isn't -27°C any more, the 'SUPER FRZ.' light goes out, and the Super Freeze operation stops.



## Vacation

- This function makes the fridge-freezer work in a power saving mode which is useful when you are away on holiday, by reducing energy consumption as much as possible. Pressing  button for 1 sec starts operation with the 'vacation' light on and pressing it again stops the operation. (Time of pressing  button shouldn't be more than 3 secs.)

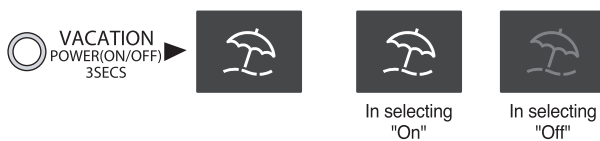



## On/Off

- Refrigerator Power On or Off is repeated when pressing the  button for 3 secs.



## Lock

- Pressing this button stops operation of other buttons.
- “Locking” or “Un-Locking” is repeated whenever pressing the  button. (For “Locking” or “Un-Locking” press the  button for 3 secs.)
- When  is activated, pressing the other buttons would not work.



## Memory feature

Function to save the set temperature and vacation status and On/Off status. When the power is turned on after the power failure, it will be restored with the set temperature and vacation status and On/Off status.

## Door Alarm

- 3 times of warning of 30 seconds if a minute passes with the door of refrigerator opened or not completely closed.
- Please contact with the local service center if warning continue to sound even after closing the door.

## Self Test

- This function automatically detects failure when failure is found in product during the use of refrigerator.
- If the failure occurs at product and it does not operate by pressing any button and normal indication is not done, do not turn the power off and immediately contact with the local service center.
- A lot of time is needed for service engineer to detect the failed part by turning it off.

## Ice Making

- To make ice cubes, fill the ice tray to the water level and place it in the freezer.
- If ice cubes are required fast, set the 'SUPER FRZ.' state.
- To remove ice cubes, hold the tray at its ends and twist gently.

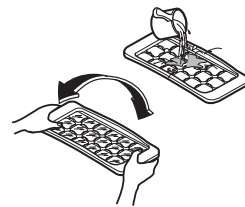

### Tip

To remove ice cubes easily, run water on the tray before twisting.

## Defrosting

Defrosting takes place automatically. The defrosting water flows down to the evaporating tray and is evaporated automatically.

## Storing Food

### Storing Food

- Do not store food which goes bad easily at low temperature, such as banana, and melon.
- Allow hot food to cool prior to storing. Placing hot food in the fridge-freezer could spoil other food, and lead to higher electric bills.
- When storing the food, use a container with a lid. This prevents moisture from evaporating, and helps food to keep its taste and nutrients.
- Do not block air vents with food. Smooth circulation of cold air keeps fridge-freezer temperature even.
- Do not open the door frequently. Opening the door lets warm air enter the fridge-freezer, and cause temperature to rise.
- To adjust the temperature control easily, do not store food near the temperature control dial.
- Never keep too many foods in door rack, as this may stop the door from fully closing.
- Do not store bottles in the freezer compartment - they may break when frozen.
- Do not refreeze food that has been thawed. This causes loss of taste and nutrition.

#### Note

If you keep the fridge-freezer in a hot, and humid place, frequently open its door or put a lot of vegetables in it, dew may form in it, which has no effect on its performance.

Remove the dew with dust cloth free from care.

## General Information

### Power Failure

- 1~2 hour power failure does no harm to the foods stores. Try to avoid opening and closing the door too frequently.

### If You Move

- Take out foods from the fridge-freezer and firmly fix the loose items with tape.
- Turn the leveling screws until they stop before moving the fridge-freezer. Otherwise the screw may scratch the floor or the fridge-freezer cannot move.

### Anti Condensation Pipe

- The Anti-Condensation pipe is installed around the front side of fridge-freezer as well as on the partition between fridge compartment and freezer compartment to prevent dewing.
- Especially after installation or when ambient temperature is high, the fridge-freezer may feel hot, which is quite normal.

Anti-Condensation Pipe

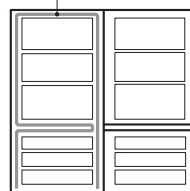

## Lamp Replacement

1. Unplug the power cord from the outlet.
2. Remove fridge shelves.
3. To remove the lamp cover, insert ⊖ type driver in the underside of the lamp cover and pull it out forwards.
4. Turn the lamp counterclockwise.
5. Assemble in reverse order of disassembly.

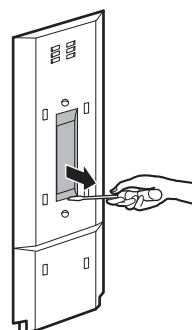

Replacement lamp must be the same specification as original.

LED lamp can be purchased at the service center.

- You must check the O-RING, which is made by rubber and prevent electric spark.

## Cleaning

### Before Cleaning

Be sure to unplug the power.

### Exterior

Clean the outside of the fridge-freezer with a soft cloth soaked with hot water or liquid detergent. If you use a detergent, be sure to wipe it with a clean wet cloth.

### Interior

As above.

### After Cleaning

Check that the power cord is not damaged, power plug has not overheated, and that the power plug is tightly inserted into the outlet.

### **WARNING**

Be sure to dry the appliance with a cloth after washing it with water.

Do not use abrasive, petroleum, benzene, thinner, hydrochloride acid, boiling water, rough brush, etc, as they may damage parts of the fridge-freezer.

## Trouble Shooting

Before calling for service, check this list.

It may save you both time and expense.

This list includes common occurrences that are not the result of defective workmanship or materials in this appliance.

### Problem

### Possible Causes

**Fridge-Freezer does not operate**

- Power plug may be unplugged from the electric outlet.  
Plug it in securely.
- House fuse has blown or circuit breaker has tripped.  
Check and/or replace fuse and reset circuit breaker.
- Power cut.  
Check house lights.

**Fridge or Freezer Compartment Temperature too warm**

- Temperature control not set on proper position.  
Refer to Temperature Control section.
- Appliance is placed close to heat source.
- Warm weather-frequent door openings.
- Door left open for a long time.
- Package holding door open or blocking air duct in freezer compartment.

**Vibration or Rattling or Abnormal Noise**

- The floor on which the fridge-freezer is installed may be uneven or the fridge-freezer may be unstable.  
Make it even by rotating the leveling screw.
- Unnecessary objects placed in the back side of the fridge-freezer.

**Frost or Ice Crystals on frozen Food**

- Door may have been left ajar or package holding door open.
- Too frequent or too long door openings.
- Frost within package is normal.

**Moisture forms on Cabinet Surface**

- This phenomenon is likely to occur in a wet space.  
Wipe it with a dry towel.

## Problem

## Possible Causes

### Moisture collects inside

- Too frequent or too long door openings.
- In humid weather, air carries moisture into fridge when doors are opened.

### Fridge has odor

- Foods with strong odors should be tightly covered or wrapped.
- Check for spoiled food.
- Interior needs cleaning.  
Refer to CLEANING section

### Door not closing properly

- Food package is keeping door open.  
Move packages that keep door from closing.
- Fridge-freezer is not level.  
Adjust the leveling screws.
- The floor on which the fridge-freezer is installed may be uneven or the fridge-freezer may be unstable.  
Slightly raise the front side with the leveling screw.

### Interior light does not work

- No power at outlet.
- Light lamp needs replacing.  
Refer to the Lamp Replacement section



## Disposal of your old appliance

1. When this crossed-out wheeled bin symbol is attached to a product it means the product is covered by the European Directive 2002/96/EC.
2. All electrical and electronic products should be disposed of separately from the municipal waste stream via designated collection facilities appointed by the government or the local authorities.
3. The correct disposal of your old appliance will help prevent potential negative consequences for the environment and human health.
4. For more detailed information about disposal of your old appliance, please contact your city office, waste disposal service or the shop where you purchased the product.



# To Reverse the Doors

Your fridge-freezer is designed with reversible doors, so that they may open from either the left or right hand side to suit your kitchen design.

## Precaution

1. Before reversing the door, first of all, you should take out food and accessories like shelves or trays which are not fixed in the fridge-freezer.
2. Use Torque Wrench or Spanner to fix or remove the bolt.
3. Do not lay the fridge-freezer down. This will cause problems.
4. Be careful not to drop the doors in disassembling or assembling.

## How to Reverse the Door

1. Separate the right hinge cover ① on the top. Separate the connecting cable ②. Separate the upper right hinge ③, and carefully separate the refrigerator door ④. Remove the left cover ⑩.

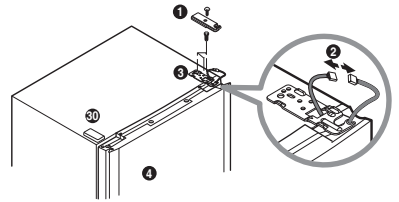

2. After separating the upper left cap ⑤ of the separated refrigerator door ④, carefully take off the top cap ⑥ and pull the cable ⑦ on the left side. Set the top cap ⑥, then set the cap ⑤ on the right side.

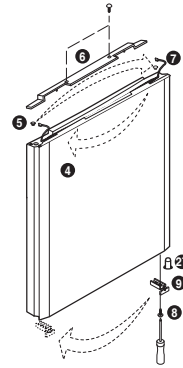

3. Loosen the screw ⑧ under the refrigerator door ④, move the door stopper ⑨ to the left. Move the bush ⑳ to the left.

4. Use a sharp gimlet or knife to disconnect the cap ⑩ from the cover front ⑫, loosen the screw ⑪, and then move the cable ⑬ to the left to be mounted. Disconnect the cable ⑭ and the door switch ⑮ from the disconnected cover front ⑫, swap the position of the disconnected cable ⑭ and door switch ⑮ with the cap ⑯, and then install the cover front ⑫ with the screw ⑪ and the cap ⑩.

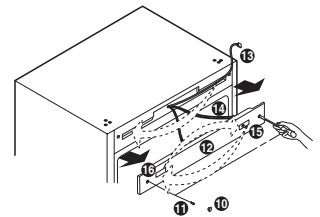

5. Loosen the bolt to remove the middle hinge 17 and sheet hinge, then lift up the freezer door 18 to separate it. Separate the cover 19 and set it on the right side.

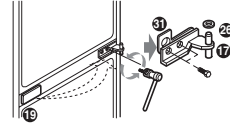

6. Loosen the pin 20 in counterclockwise direction and move to the hole on the left side to tighten in clockwise direction. Loosen the bolt to separate the lower hinge 21. Move the leveling screw 22 to the right side.

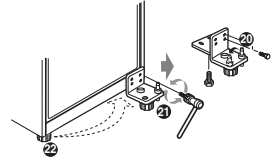

7. Unscrew the screw 23 under the freezer door 18, move the door stopper 24 to the left of the freezer door. Move the bush 22 to the left of the freezer door. And then move the cap 25 to the right side and cover it.

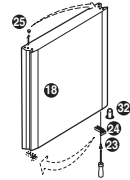

8. Set the separate lower hinge 21 on the bottom hole of the left side of the refrigerator. Assemble the freezer door 18 on the pin 20 of lower hinge 21 to attach it properly. Turn over the separated middle hinge 17 and sheet hinge 31 to assemble them. And set the washer 26.

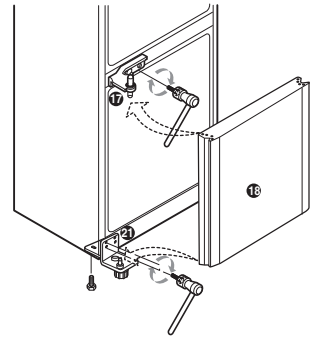

9. After assembling the door by aligning the hinge hole on the bottom of the refrigerator door 4 and the pin of the middle hinge 17, connect properly to the hold of the upper left hinge 28 included in the owner's manual. After connecting the cable 2. Use bolt to fixation the left hinge 23, then assemble the left hinge cover 29 included in the owner's manual with the screw. Take the right cap 33 out of the alternate bag, then install it on the right side of the refrigerator top.

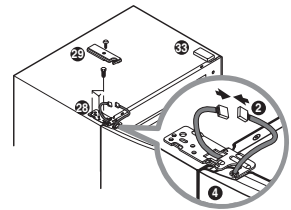

**Note**

Reversing the doors is not covered by the warranty.