

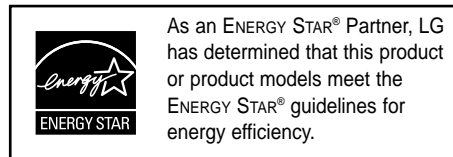

**HB954PA (HB954PA-DD / SB94PA-C/F/S/W)  
HB954SA (HB954SA-DD / SB94SA-C/S/W)**



ENERGY STAR® is a U.S. registered mark.

ENGLISH

DEUTSCH

ITALIANO

ESPAÑOL

PORTUGUÊS

SVENSKA

DANSK

NORSK

SUOMI

**CAUTION****RISK OF ELECTRIC SHOCK  
DO NOT OPEN**

**CAUTION: TO REDUCE THE RISK OF ELECTRIC SHOCK DO NOT REMOVE COVER (OR BACK) NO USER-SERVICEABLE PARTS INSIDE REFER SERVICING TO QUALIFIED SERVICE PERSONNEL.**



This lightning flash with arrowhead symbol within an equilateral triangle is intended to alert the user to the presence of uninsulated dangerous voltage within the product's enclosure that may be of sufficient magnitude to constitute a risk of electric shock to persons.



The exclamation point within an equilateral triangle is intended to alert the user to the presence of important operating and maintenance (servicing) instructions in the literature accompanying the product.

**WARNING: TO PREVENT FIRE OR ELECTRIC SHOCK HAZARD, DO NOT EXPOSE THIS PRODUCT TO RAIN OR MOISTURE.**

**WARNING:** Do not install this equipment in a confined space such as a book case or similar unit.

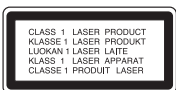

**CAUTION:** Do not block any ventilation openings. Install in accordance with the manufacturer's instructions.

Slots and openings in the cabinet are provided for ventilation and to ensure reliable operation of the product and to protect it from over heating. The openings shall be never be blocked by placing the product on a bed, sofa, rug or other similar surface. This product shall not be placed in a built-in installation such as a bookcase or rack unless

proper ventilation is provided or the manufacturer's instruction has been adhered to.

**CAUTION:** This product employs a Laser System. To ensure proper use of this product, please read this owner's manual carefully and retain it for future reference. Shall the unit require maintenance, contact an authorized service center.

Use of controls, adjustments or the performance of procedures other than those specified herein may result in hazardous radiation exposure.

To prevent direct exposure to laser beam, do not try to open the enclosure. Visible laser radiation when open. **DO NOT STARE INTO BEAM.**

**CAUTION:** The apparatus shall not be exposed to water (dripping or splashing) and no objects filled with liquids, such as vases, shall be placed on the apparatus.

**CAUTION concerning the Power Cord  
Most appliances recommend they be placed upon a dedicated circuit;**

That is, a single outlet circuit which powers only that appliance and has no additional outlets or branch circuits. Check the specification page of this owner's manual to be certain. Do not overload wall outlets. Overloaded wall outlets, loose or damaged wall outlets, extension cords, frayed power cords, or damaged or cracked wire insulation are dangerous. Any of these conditions could result in electric shock or fire. Periodically examine the cord of your appliance, and if its appearance indicates damage or deterioration, unplug it, discontinue use of the appliance, and have the cord replaced with an exact replacement part by an authorized service center. Protect the power cord from physical or mechanical abuse, such as being twisted, kinked, pinched, closed in a door, or walked upon. Pay particular attention to plugs, wall outlets, and the point where the cord exits the appliance. To disconnect power from the mains, pull out the mains cord plug. When installing the product, ensure that the plug is easily accessible.

**Disposal of your old appliance**

1. When this crossed-out wheeled bin symbol is attached to a product it means the product is covered by the European Directive 2002/96/EC.
2. All electrical and electronic products should be disposed of separately from the municipal waste stream via designated collection facilities appointed by the government or the local authorities.
3. The correct disposal of your old appliance will help prevent potential negative consequences for the environment and human health.
4. For more detailed information about disposal of your old appliance, please contact your city office, waste disposal service or the shop where you purchased the product.



**This product is manufactured to comply with EMC Directive 2004/108/EC and Low Voltage Directive 2006/95/EC.**

European representative:  
LG Electronics Service Europe B.V.  
Veluwezoom 15, 1327 AE Almere, The Netherlands  
(Tel : +31-036-547-8940)

## Notes on Copyrights

- Because AACS (Advanced Access Content System) is approved as content protection system for BD format, similar to use of CSS (Content Scramble System) for DVD format, certain restrictions are imposed on playback, analog signal output, etc., of AACS protected contents. The operation of this product and restrictions on this product may vary depending on your time of purchase as those restrictions may be adopted and/or changed by AACS after the production of this product. Furthermore, BD-ROM Mark and BD+ are additionally used as content protection systems for BD format, which imposes certain restrictions including playback restrictions for BD-ROM Mark and/or BD+ protected contents. To obtain additional information on AACS, BD-ROM Mark, BD+, or this product, please contact an authorized Customer Service Center.
- Many BD-ROM/DVD discs are encoded with copy protection. Because of this, you should only connect your player directly to your TV, not to a VCR. Connecting to a VCR results in a distorted picture from copy-protected discs.
- This product incorporates copyright protection technologies that are protected by certain U.S. patents and other intellectual property rights owned by Macrovision Corporation and other rights owners. Use of this copyright protection technology must be authorized by Macrovision Corporation and is intended for home and other limited viewing uses only, unless otherwise authorized by Macrovision Corporation. Reverse engineering or disassembly is prohibited.
- Under the U.S. Copyright laws and Copyright laws of other countries, unauthorized recording, use, display, distribution, or revision of television programs, videotapes, BD-ROM discs, DVDs, CDs and other materials may subject you to civil and/or criminal liability.

### To use BD-Live functionality

You must attach an external USB device using the USB port (see page 20).



### What is SIMPLINK?

Some functions of this unit are controlled by the TV's remote control when this unit and LG TV's with SIMPLINK are connected through HDMI connection.

- Controllable functions by LG TV's remote control; Play, Pause, Scan, Skip, Stop, Power Off, etc.
- Refer to the TV owner's manual for the details of SIMPLINK function.
- LG TV's with SIMPLINK function have the logo as shown above.

### Notes:

- Depending on the disc type or playing status, some SIMPLINK operation may differ from your purpose or not work.
- If "SIMPLINK" function does not work, check that your HDMI cable supports by CEC (Consumer Electronics Control) for HDMI.
- If the sound is output from both the system's speakers and TV speaker or not output from both them during SIMPLINK operation, reset speaker setting of LG TV's SIMPLINK menu.

### Licenses

Java and all Java-based trademarks and logos are trademarks or registered trademarks of Sun Microsystems, Inc. in the United States and other countries.

Manufactured under license from Dolby Laboratories. Dolby, Pro Logic, and the double-D symbol are trademarks of Dolby Laboratories.

Manufactured under license under U.S. Patent #'s: 5,451,942; 5,956,674; 5,974,380; 5,978,762; 6,226,616; 6,487,535; 7,392,195; 7,272,567; 7,333,929; 7,212,872 & other U.S. and worldwide patents issued & pending. DTS is a registered trademark and the DTS logos, Symbol, DTS-HD and DTS-HD Master Audio I Essential are trademarks of DTS, Inc. © 1996-2008 DTS, Inc. All Rights Reserved.

HDMI, the HDMI logo and High-Definition Multimedia Interface are trademarks or registered trademarks of HDMI licensing LLC.

"BD-LIVE" logo is trademark of Blu-ray Disc association.

"DVD Logo" is trademark of DVD Format/Logo Licensing Corporation.

"x.v.Colour" is a trademark of Sony Corporation.

"Blu-ray Disc" is a trademark.

"BONUSVIEW" is trademark of Blu-ray Disc Association.

This product is licensed under the AVC patent portfolio license and VC-1 patent portfolio license for the personal and non-commercial use of a consumer to (i) encode video in compliance with the AVC Standard and VC-1 Standard ("AVC/VC-1 Video") and/or (ii) decode AVC/VC-1 Video that was encoded by a consumer engaged in a personal and non-commercial activity and/or was obtained from a video provider licensed to provide AVC/VC-1 Video. No license is granted or shall be implied for any other use. Additional information may be obtained from MPEG LA, LLC. See <http://www.mpegla.com>.

"AVCHD" and the AVCHD logo are trademarks of Panasonic and Sony Corporation.

iPod is a trademark of Apple Inc., registered in the U.S. and other countries.

iPhone is a trademark of Apple Inc.

YouTube is a trademark of Google Inc.

"Made for iPod" means that an electronic accessory has been designed to connect specifically to iPod and has been certified by the developer to meet Apple performance standards.

"Works with iPhone" means that an electronic accessory has been designed to connect specifically to iPhone and has been certified by the developer to meet Apple performance standards.

Apple is not responsible for the operation of this device or its compliance with safety and regulatory standards.

## Contents

Introduction .....	5-8	Playing YouTube videos .....	38-40
Remote control .....	9	Listening to the radio .....	41
Front panel .....	10	Playing the iPod .....	41-42
Rear panel .....	11	Listening to music from your portable audio player .....	43
Assembling the speakers (HB954PA) .....	12	Listening to the sound from your component .....	43
Speaker connection .....	12-13	Using HDMI IN jacks .....	44
Positioning the system .....	13	Using DIGITAL AUDIO IN jacks .....	44
Connections to your TV .....	14-15	Reference .....	45
Resolution Setting .....	16-17	Language Codes .....	46
Internet connection .....	18-19	Area Codes .....	46
Setting the sound mode .....	19	Troubleshooting .....	47-48
Adjust the speaker level settings .....	19	Specifications .....	49-50
Using the late night function .....	19	Open source software notice .....	51
Using the sleep timer .....	19		
Using USB devices .....	20		
Using the Home Menu .....	21		
Adjust the Setup settings .....	21-27		
Play a disc .....	28-30		
Displaying disc Information .....	31		
Enjoying BD-LIVE™ .....	32-33		
Playing a movie .....	33-34		
Listening to a music .....	35-36		
Viewing a photo .....	36-37		

Before connecting, operating or adjusting this product,  
please read this instruction booklet carefully and completely.

## Introduction

To ensure proper use of this product, please read this owner's manual carefully and retain for future reference.

This manual provides information on the operation and maintenance of your player. Should the unit require service, contact an authorized service location.

### About the Symbol Display

"" may appear on your TV display during operation and indicates that the function explained in this owner's manual is not available on that specific media.

### Symbols Used in this Manual

#### **Note:**

Indicates special notes and operating features.

#### **Tip:**

Indicates tips and hints for making the task easier.

A section whose title has one of the following symbols are applicable only to the disc represented by the symbol.

<b>ALL</b>	All discs listed below
<b>BD</b>	BD-ROM disc
<b>DVD</b>	DVD-Video, DVD±R/RW in Video mode or VR mode and finalized
<b>AVCHD</b>	DVD±R/RW in AVCHD format
<b>DivX</b>	DivX files
<b>ACD</b>	Audio CDs
<b>MP3</b>	MP3 files
<b>WMA</b>	WMA files

## Handling the Unit

### When shipping the unit

Please save the original shipping carton and packing materials. If you need to ship the unit, for maximum protection, re-pack the unit as it was originally packed at the factory.

### Keeping the exterior surfaces clean

- Do not use volatile liquids such as insecticide spray near the unit.
- Wiping with strong pressure may damage the surface.
- Do not leave rubber or plastic products in contact with the unit for a long period of time.

### Cleaning the unit

To clean the player, use a soft, dry cloth. If the surfaces are extremely dirty, use a soft cloth lightly moistened with a mild detergent solution.

Do not use strong solvents such as alcohol, benzene, or thinner, as these might damage the surface of the unit.

### Maintaining the Unit

The unit is a high-tech, precision device. If the optical pick-up lens and disc drive parts are dirty or worn, the picture quality could be diminished.

For details, please contact your nearest authorized service center.

## Notes on Discs

### Handling Discs

Do not touch the playback side of the disc. Hold the disc by the edges so that fingerprints do not get on the surface. Never stick paper or tape on the disc.

### Storing Discs

After playing, store the disc in its case. Do not expose the disc to direct sunlight or sources of heat and never leave it in a parked car exposed to direct sunlight.

### Cleaning Discs

Fingerprints and dust on the disc can cause poor picture quality and sound distortion. Before playing, clean the disc with a clean cloth. Wipe the disc from the center out.

Do not use strong solvents such as alcohol, benzene, thinner, commercially available cleaners, or anti-static spray intended for older vinyl records.

## Playable Discs



### Blu-ray Disc

- Discs such as movies that can be purchased or rented
- BD-R/RE discs that contain audio titles, DivX, MP3, WMA, or Photo files.



### DVD-VIDEO (8 cm / 12 cm disc)

Discs such as movies that can be purchased or rented



### DVD-R (8 cm / 12 cm disc)

- Video mode and finalized only
- Supports the dual layer disc also
- AVCHD format
- DVD-R discs that contain audio titles, DivX, MP3, WMA, or Photo files.



### DVD-RW (8 cm / 12 cm disc)

- VR mode, Video mode and finalized only
- AVCHD format
- DVD-RW discs that contain audio titles, DivX, MP3, WMA, or Photo files.



### DVD+R (8 cm / 12 cm disc)

- Finalized disc only
- Supports the dual layer disc also
- AVCHD format
- DVD+R discs that contain audio titles, DivX, MP3, WMA, or Photo files.



### DVD+RW (8 cm / 12 cm disc)

- Video mode and finalized only
- AVCHD format
- DVD+RW discs that contain audio titles, DivX, MP3, WMA, or Photo files.



### Audio CD (8 cm / 12 cm disc)

Audio CDs or CD-Rs/CD-RWs in audio CD format that can be purchased



### CD-R/CD-RW (8 cm / 12 cm disc)

CD-R/CD-RW discs that contain audio titles, DivX, MP3, WMA, or Photo files.

## Notes:

- Depending on the conditions of the recording equipment or the CD-R/RW (or DVD±R/RW) disc itself, some CD-R/RW (or DVD±R/RW) discs cannot be played on the unit.
- Do not attach any seal or label to either side (the labeled side or the recorded side) of a disc.
- Do not use irregularly shaped CDs (e.g., heart-shaped or octagonal). Doing so may result in malfunctions.
- Depending on the recording software & the finalization, some recorded discs (CD-R/RW or DVD±R/RW) may not be playable.
- DVD±R/RW and CD-R/RW discs recorded using a personal computer or a DVD or CD Recorder may not play if the disc is damaged or dirty, or if there is dirt or condensation on the player's lens.
- If you record a disc using a personal computer, even if it is recorded in a compatible format, there are cases in which it may not play because of the settings of the application software used to create the disc. (Check with the software publisher for more detailed information.)
- This player requires discs and recordings to meet certain technical standards in order to achieve optimal playback quality. Pre-recorded DVDs are automatically set to these standards. There are many different types of recordable disc formats (including CD-R containing MP3 or WMA files) and these require certain pre-existing conditions to ensure compatible playback.
- Customers should note that permission is required in order to download MP3 / WMA files and music from the Internet. Our company has no right to grant such permission. Permission should always be sought from the copyright owner.
- You have to set the disc format option to [Mastered] in order to make the discs compatible with the LG players when formatting rewritable discs. When setting the option to Live System, you cannot use it on LG player. (Mastered/Live File System : Disc format system for windows Vista)

## BD-ROM Disc Features

BD-ROM Discs can store 25 GB (single layer) or 50 GB (dual layer) on a single sided disc - about 5 to 10 times the capacity of a DVD.

BD-ROM Discs also support the highest quality HD video available in the industry (up to 1920 x 1080) - Large capacity means no compromise on video quality. Furthermore, a BD-ROM disc has the same familiar size and look as DVD.

- The following BD-ROM disc features are disc dependent and will vary.
- Appearance and navigation of features will also vary from disc to disc.
- Not all discs will have the features described below.
- BD-ROM, Hybrid disc have both BD-ROM and DVD (or CD) layers on one side. On such discs, BD-ROM layer will be only played back in this player.

### Video highlights

The BD-ROM format for movie distribution supports three highly advanced video codecs, including MPEG-2, MPEG4 AVC (H.264), and SMPTE VC1. HD video resolutions are also available:

- 1920 x 1080 HD
- 1280 x 720 HD

### Graphic planes

Two individual, full HD resolution (1920x1080) graphic planes (layers) are available, on top of the HD video layer. One plane is assigned to video-related, frame accurate graphics (like subtitles), and the other plane is assigned to interactive graphic elements, such as buttons or menus. For both planes, various wipes, fades and scroll effects may be available.

### For High-Definition Playback

To view high-definition contents from BD-ROM discs, an HDTV is required. Some discs may require HDMI OUT for viewing of high-definition contents. Ability to view high-definition contents in BD-ROM discs may be limited depending on the resolution of your TV.

### Menu sounds

When you highlight or select a menu option, sounds can be heard such as button clicks or a voice-over explaining the highlighted menu choice.

### Multi-page/PopUp Menus

With DVD-Video, playback is interrupted each time a new menu screen is accessed. Due to BD-ROM disc's ability to preload data from the disc without interrupting playback, a menu can consist of several pages.

You can browse through the menu pages or select different menu paths, while the audio and video remain playing in the background.

### Interactivity

Certain BD-ROM Discs may contain animated menus and/or trivia games.

### User Browsable Slideshows

With BD-ROM Discs, you can browse through various still pictures while the audio remains playing.

### Subtitles

Depending on what is contained on the BD-ROM disc, you may be able to select different font styles, sizes and colours for some subtitles. Subtitles may also be animated, scrolled or faded in and out.

### BD-J Interactive Capability

The BD-ROM format supports Java for interactive functions. "BD-J" offers content providers almost unlimited functionality when creating interactive BD-ROM titles.

### BD-ROM Disc Compatibility

This player supports BD-ROM Profile 2.

- Discs supporting BD-Live (BD-ROM version 2 Profile 2) that allows interactive functions to be used when this unit is connected to the Internet in addition to the BONUSVIEW function.
- Discs supporting BONUSVIEW (BD-ROM version 2 Profile 1 version 1.1/Final Standard Profile) that allows Virtual packages or Picture-in-Picture functions to be used.

## Regional Code

---

This unit has a regional code printed on the rear of the unit. This unit can play only BD-ROM or DVD discs labeled same as the rear of the unit or "ALL".

## AVCHD (Advanced Video Codec High Definition)

---

- This player can playback AVCHD format discs. These discs are normally recorded and used in camcorders.
- The AVCHD format is a high definition digital video camera format.
- The MPEG-4 AVC/H.264 format is capable of compressing images at higher efficiency than that of the conventional image compressing format.
- Some AVCHD discs use the "x.v.Colour" format.
- This player can playback AVCHD discs using "x.v.Colour" format.
- "x.v.Colour" is a trademark of Sony Corporation.
- Some AVCHD format discs may not play, depending on the recording condition.
- AVCHD format discs need to be finalized.
- "x.v.Colour" offers a wider colour range than normal DVD camcorder discs.

## Compatibility Notes

---

- Because BD-ROM are a new format, certain disc, digital connection and other compatibility issues are possible. If you experience compatibility problems, please contact an authorized Customer Service Center.
- Viewing high-definition content and up-converting standard DVD content may require a HDMI-capable input or HDCP-capable DVI input on your display device.
- Some BD-ROM and DVD discs may restrict the use of some operation commands or features.
- Dolby Digital EX, DTS-ES and DTS 96/24 are output as Dolby Digital 5.1 or DTS 5.1.
- You can use the USB device that is used to store some disc related information, including downloaded on-line content. The disc you are using will control how long this information is retained.

## Certain System Requirements

---

For high definition video playback:

- High definition display that has COMPONENT or HDMI input jacks.
- BD-ROM disc with high definition content.
- HDMI or HDCP capable DVI input on your display device is required for some content (as specified by disc authors).
- For up-conversion of standard definition DVD, a HDMI or HDCP capable DVI input on your display device is required for copy protected content.

## Important Notice for TV colour system

---

The colour system of this player differs according to currently playing discs or video contents (YouTube, etc.).

For example, when the player plays back the disc recorded in the NTSC colour system, the image is outputted as a NTSC signal.

Only the multi system colour TV can receive all signals outputted from the player.

### Notes:

- If you have a PAL colour system TV, you will see just distorted images when using discs recorded in NTSC.
- The multi system colour TV changes the colour system automatically according to input signals. In case that the colour system is not changed automatically, turn it off and then on to see normal images on screen.
- Even if the disc and video contents (YouTube, etc.) recorded in NTSC colour system are well displayed on your TV, these may not be recorded correctly on your recorder.



## Remote control



**1**

**INPUT (TUNER):** Changes the input source (FM, AUX, PORTABLE, OPTICAL, COAXIAL, HDMI IN 1, HDMI IN 2)

**POWER:** Switches the player ON or OFF.

**OPEN/CLOSE (▲):** Opens and closes the disc tray.

**iPod:** Selects REMOTE IPOD or OSD IPOD mode.

**PIP\*:** Switches on/off Secondary Video (Picture-in-picture) (BD-ROM only).

**DISPLAY:** Displays or exits On-Screen Display.

**HOME:** Displays or exits the [Home Menu].

**DISC MENU:** Accesses menu on a disc.

**2**

**Direction buttons:** Selects an option in the menu.

**PRESET (▲/▼):** Selects programme of Radio.

**TUN. (+/-):** Tunes in the desired radio station.

**ENTER (⊙):** Acknowledges menu selection.

**RETURN (↶):** Exits the menu or resumes playback. The resume play function may work depending on the BD-ROM disc.

**TITLE/POPUP:** Displays the DVD title menu or BD-ROM's popup menu, if available.

**3**

**STOP (■):** Stops playback.

**PLAY (▶):** Starts playback.

**PAUSE/STEP (⏸):** Pauses playback.

**SKIP (◀◀ / ▶▶):** Go to next or previous chapter / track / file.

**SCAN (◀◀ / ▶▶):** Searches backward or forward.

**SPK LEVEL (🔊):** Sets the sound level of desired speaker.

**SOUND (🎵):** Selects a sound mode.

**MUTE:** Press MUTE to mute your unit. You can mute your unit in order, for example, to answer the telephone.

**VOL. (+/-):** Adjusts speaker volume.

**NIGHT (🌙):** Sets the late night function.

**4**

**0-9 numerical buttons:** Select numbered options in a menu.

**SUBTITLE (🗣):** Selects a subtitle language.

**RESOLUTION:** Sets the output resolution for HDMI and COMPONENT VIDEO OUT jacks.

**MARKER:** Marks any point during playback.

**SEARCH:** Displays or exits the search menu.

**REPEAT:** Repeat a desired section.

**CLEAR:** Removes a mark on the search menu or a number when setting the password.

**Coloured (A, B, C, D) buttons:** Use to navigate BD-ROM menus. They are also used for [MOVIE], [PHOTO], [MUSIC] and [YouTube] menu.

- A button (RDS): Radio Data System.

- B button (PTY): Views the programme type of the RDS.

- C button (PTY SEARCH): Searches programme type.

- D button: Selects MONO or STEREO in FM mode.

**TV Control Buttons:** See page 45.

**SLEEP:** Sets a certain period of time after which the unit will switch to standby.

\* Depending on a disc type or the pre-recorded contents of the BD-ROM disc, different functions may be executed than other media or there are no response when pressing some buttons (depending on media used).

### Remote Control Operation

Point the Remote Control at the remote sensor and press the buttons.

#### Remote Control Battery Installation

Remove the battery cover on the rear of the Remote Control, and insert a R03 (size AAA) battery with **+** and **-** matched correctly.

## Front panel

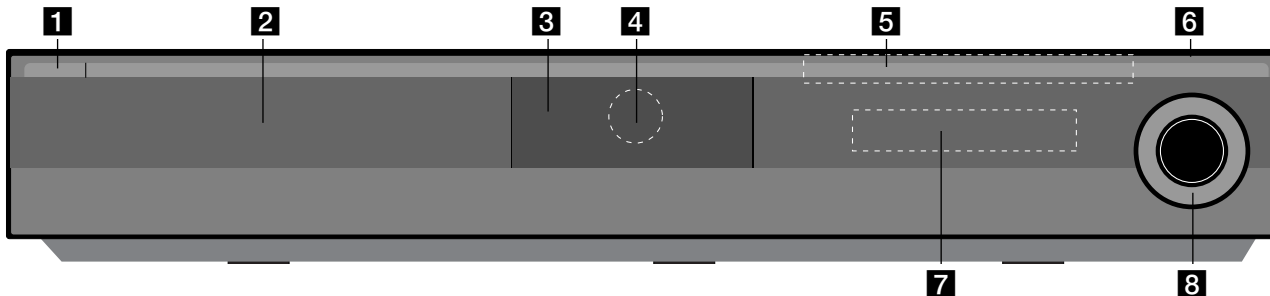

### 1 **⏻/⏻ (POWER) Button**

Switches the unit ON or OFF.

### 2 **Disc Tray**

Insert a disc here.

### 3 **iPod Dock**

Connect your iPod here.

Push **⏻** to open the iPod Dock.

### 4 **Remote Sensor**

Point the remote control here.

### 5 **Touch Buttons**

#### - **⏻ (OPEN/CLOSE)**

Opens or closes the disc tray.

#### - **▶/⏸ (PLAY / PAUSE)**

Starts playback.

Pause playback temporarily, press again to exit pause mode.

#### - **■ (STOP)**

Stops playback.

#### - **◀◀ / ▶▶ (SKIP)**

Go to next or previous file/track/chapter.

Searches backward or forward if you press and hold it.

### - **FUNC.**

Changes the input source (FM, OSD IPOD, REMOTE IPOD, AUX, PORTABLE, OPTICAL, COAXIAL, HDMI IN 1, HDMI IN 2) or displays On-Screen Display.

### 6 **USB Port**

Connect a USB device.

### 7 **Display Window**

Shows the current status of the player.

### 8 **VOLUME**

Adjusts speaker volume.

### Precautions in using the touch buttons

- Use the touch buttons with clean and dry hands.
  - In a humid environment, wipe out any moisture on the touch buttons before using.
- Do not press the touch buttons hard to make it work.
  - If you apply too much strength, it can damage the sensor of the touch buttons.
- Touch the button that you want to work in order to operate the function correctly.
- Be careful not to have any conductive material such as metallic object on the touch buttons. It can cause malfunctions.

## Rear panel

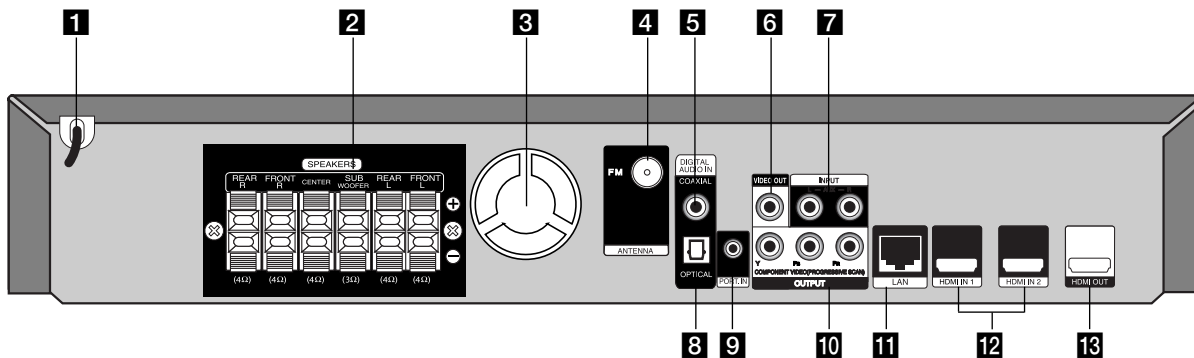

- 1 AC Power Cord**  
Plug into the power source.
- 2 SPEAKER Connectors**  
Connect the speakers.
- 3 Cooling Fan**
- 4 FM ANTENNA Connector**  
Connect the FM antenna.
- 5 DIGITAL AUDIO IN (COAXIAL)**  
Connect to digital (coaxial) audio equipment.
- 6 VIDEO OUT**  
Connect to a TV with video inputs.
- 7 AUX (L/R) INPUT**  
Connect to an external source with 2 channel audio outputs.
- 8 DIGITAL AUDIO IN (OPTICAL)**  
Connect to digital (optical) audio equipment.
- 9 PORT. IN**  
Connect to a portable player with audio outputs.
- 10 COMPONENT VIDEO (Y Pb Pr) OUTPUT (PROGRESSIVE SCAN)**  
Connect to a TV with Y Pb Pr inputs.
- 11 LAN port**  
Connect a network with an always-on broadband connection.
- 12 HDMI IN (Type A) 1/2**  
Connect to an external source with HDMI outputs.
- 13 HDMI OUT (Type A)**  
Connect to TV with HDMI inputs. (Interface for digital audio and video)

## Assembling the Speakers (HB954PA)

Before connecting the speakers, assemble the speakers.  
(The illustrations in the following steps are for the front speakers.)

- 1 Attach the speaker to the desktop stand.**  
Secure the speaker with the screws.

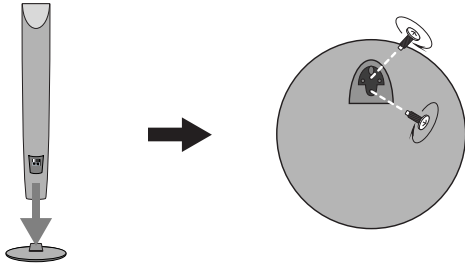

- 2 Thread the speaker cable through the hole in the bottom of the desktop stand.**

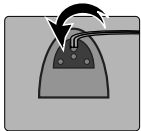

- 3 Connect the speaker cables to the speaker.**  
Use the speaker cable of the red and white tube. Connect the black end of each wire to the terminal marked - (minus) and the other end to the terminal marked + (plus).

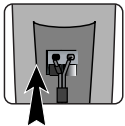

## Speaker Connection

### Attaching the speakers to the player

- 1 You will have received six speaker cables.**  
Each one is colour-coded by a band near each end and connects one of the six speakers to the player.
- 2 Connect the wires to the player.**  
Match each wire's coloured band to the same coloured connection terminal on the rear of the player. To connect the cable to the player, press each plastic finger pad to open the connection terminal. Insert the wire and release the finger pad.

Connect the black end of each wire to the terminals marked - (minus) and the other end to the terminals marked + (plus).

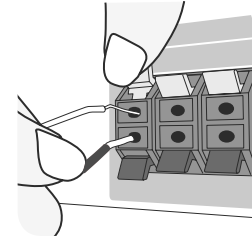

- 3 Connect the wires to the speakers.**  
Connect the other end of each wire to the correct speaker according to the colour coding:

COLOUR	SPEAKER	POSITION
Grey	Rear	Behind you and to your right.
Blue	Rear	Behind you and to your left.
Green	Center	Above or below screen, directly in front of you.
Orange	Sub Woofer	This can be placed in any front position.
Red	Front	In front of you, to the right of the screen.
White	Front	In front of you, to the left of the screen.

To connect the cable to the speakers, press each plastic finger pad to open the connection terminals on the base of each speaker. Insert the wire and release the finger pad.

#### Be careful of the following

Be careful to make sure children not to put their hands or any objects into the \*speaker duct.

\*Speaker duct: A hall for plentiful bass sound on speaker cabinet(enclosure).

#### FM Antenna connection

FM - Connect the FM antenna to the player.

The reception will be its best when the two loose ends of the antenna are in a straight and horizontal line.

## Positioning the System

The following illustration shows an example of positioning the system. Note that the illustrations in these instructions differ from the actual unit for explanation purposes.

For the best possible surround sound, all the speakers other than the subwoofer should be placed at the same distance from the listening position (A).

- Ⓐ Front left speaker (L)/ Ⓑ Front right speaker (R): Place the front speakers to the sides of the monitor or screen and as flush with the screen surface as possible.
- Ⓒ Center speaker: Place the center speaker above or below the monitor or screen.
- Ⓓ Surround left speaker (L)/ Ⓔ Surround right speaker (R): Place these speakers behind your listening position, facing slightly inwards.
- Ⓕ Subwoofer: The position of the subwoofer is not so critical, because low bass sounds are not highly directional. But it is better to place the subwoofer near the front speakers. Turn it slightly toward the center of the room to reduce the wall reflections.
- Ⓖ Unit

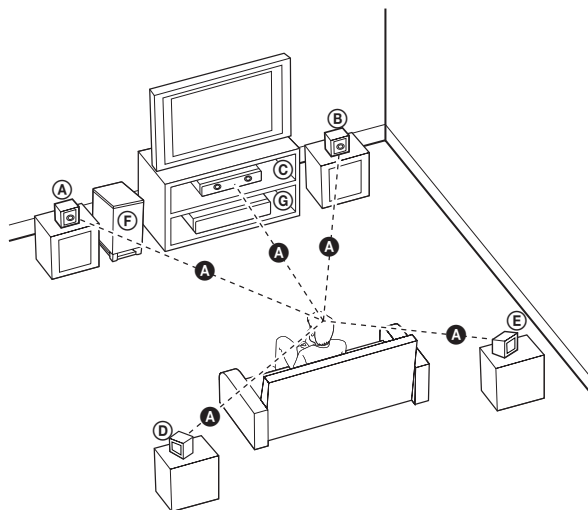

## Connections to Your TV

Make one of the following connections, depending on the capabilities of your existing equipment.

### Tips:

- Depending on your TV and other equipment you wish to connect, there are various ways you could connect the player. Use only one of the connections described below.
- Please refer to the manuals of your TV or other devices as necessary to make the best connections.

### Cautions:

- Make sure the player is connected directly to the TV. Tune the TV to the correct video input channel.
- Do not connect your player via your VCR. The image could be distorted by the copy protection system.

## HDMI Connection

If you have a HDMI TV or monitor, you can connect it to this player using a HDMI cable.

Connect the HDMI OUT jack on the player to the HDMI IN jack on a HDMI compatible TV or monitor (**H**).

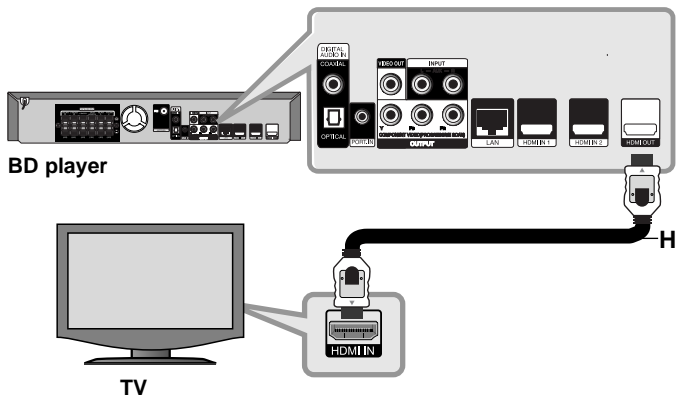

Set the TV's source to HDMI (refer to TV's Owner's manual).

### Notes:

- You must select a HDMI audio output that your TV accepts using [HDMI Audio] options on the [Setup] menu (see page 24).
- If a connected HDMI device does not accept the audio output of the unit, the HDMI device's audio sound may be distorted or may not output.

### Tips:

- You can fully enjoy digital audio and video signals together with this HDMI connection.
- When you use HDMI connection, you can change the resolution for the HDMI output. (Refer to "Resolution Setting" on page 16-17.)
- Select the type of video output from the HDMI OUT jack using [HDMI Color Setting] option on the [Setup] menu (see page 22).

### Cautions:

- Changing the resolution when the connection has already been established may result in malfunctions. To solve the problem, turn off the player and then turn it on again.
- When the HDMI connection with HDCP is not verified, TV screen is changed to black or green screen or the snow noise may occur on the screen. In this case, check the the HDMI connection, or disconnect the HDMI cable.
- If there is noise or lines on the screen, please check the HDMI cable (length is generally limited to 4.5m) and use a High Speed HDMI cable (Version 1.3).

### Additional Information for HDMI

- When you connect a HDMI or DVI compatible device make sure of the following:
  - Try switching off the HDMI/DVI device and this player. Next, switch on the HDMI/DVI device and leave it for around 30 seconds, then switch on this player.
  - The connected device's video input is set correctly for this unit.
  - The connected device is compatible with 720x576p, 1280x720p, 1920x1080i or 1920x1080p video input.
- Not all HDCP-compatible HDMI or DVI devices will work with this player.
  - The picture will not be displayed properly with non-HDCP device.
  - This player does not playback and TV screen is changed to black or green screen or the snow noise may occur on the screen.

### Component Video Connection

Connect the COMPONENT VIDEO OUT jacks on the player to the corresponding input jacks on the TV using Y Pb Pr cables (C). You can hear the sound through the system's speakers.

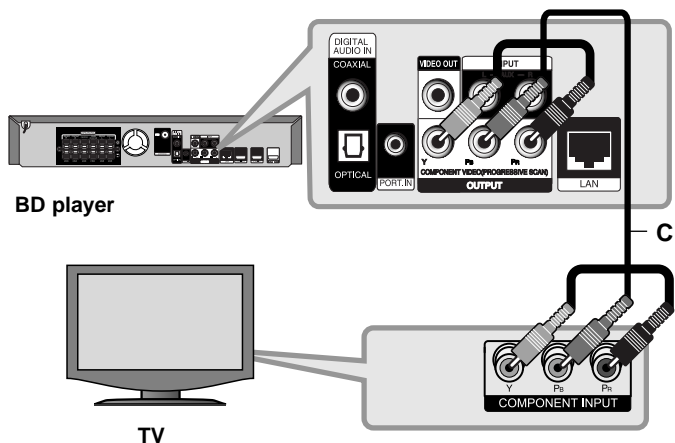

### Tip:

When you use COMPONENT VIDEO OUT connection, you can change the resolution for the output. (Refer to "Resolution setting" on page 16-17.)

### Video Connection

Connect the VIDEO OUT jack on the player to the video in jack on the TV using a video cable (V). You can hear the sound through the system's speakers.

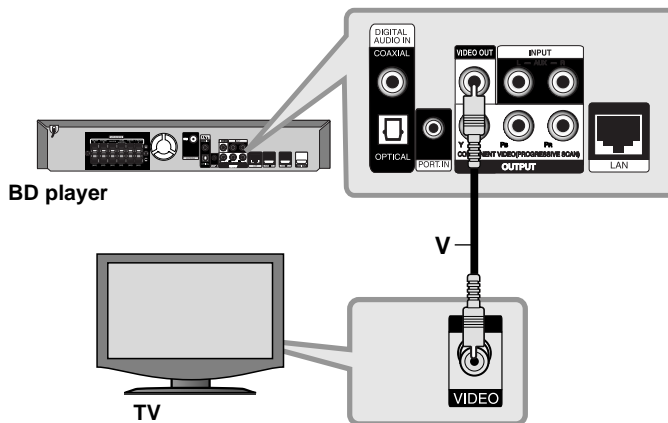

## Resolution Setting

The player provides several output resolutions for HDMI OUT and COMPONENT VIDEO OUT jacks.

You can change the resolution using [Setup] menu or pressing the RESOLUTION button in [Home Menu] and [Setup] Menu.

### Note:

Since several factors affect the resolution of video output, see “Available resolution according to the resolution setting” to the right.

### How to change the resolution using RESOLUTION button

Press RESOLUTION repeatedly in [Home Menu] and [Setup] Menu to change the resolution. The display window will show you the current resolution.

### How to change the resolution using the [Setup] menu

- 1 Press HOME and the [Home Menu] appears.
- 2 Select the [Setup] and press ENTER. The [Setup] menu appears.
- 3 Use ▲ / ▼ to select [DISPLAY] option then press ► to move to the second level.
- 4 Use ▲ / ▼ to select the [Resolution] option then press ► to move to the third level.
- 5 Use ▲ / ▼ to select the desired resolution then press ENTER to confirm your selection.

### Note:

If the video signal from the HDMI OUT jack is not output from the TV screen when [Resolution] is set to [Auto], change the video output resolution by pressing RESOLUTION button.

## Available resolution according to the resolution setting

### • When the non-copy protected media is playing back

Resolution Setting \ Video Output	HDMI OUT	COMPONENT VIDEO OUT	
		HDMI connected	HDMI disconnected
576i	576p	576i	
576p	576p	576i	576p
720p	720p	720p	
1080i	1080i	1080i	
1080p / 24Hz	1080p / 24Hz	576i	1080i
1080p / 50Hz	1080p / 50Hz	576i	1080i

### • When the copy protected media is playing back

Resolution Setting \ Video Output	HDMI OUT	COMPONENT VIDEO OUT	
		HDMI connected	HDMI disconnected
576i	576p	576i	
576p	576p	576i	576p
720p	720p	576i	576p
1080i	1080i	576i	576p
1080p / 24Hz	1080p / 24Hz	576i	576p
1080p / 50Hz	1080p / 50Hz	576i	576p

### Notes:

- Depending on your display, some of the resolution settings may result in the picture disappearing or an abnormal picture appearing. In this case, press HOME then RESOLUTION repeatedly until the picture re-appear.
- This player supports simultaneous output of all video out jacks. The resolution of the HDMI output will not be the same as the resolution output on the component video output.



### HDMI OUT connection

- For the 576i resolution setting, real output resolution of HDMI OUT will change to 576p.
- If you select a resolution manually and then connect the HDMI jack to TV and your TV does not accept it, the resolution setting is set to [Auto].
- If you select a resolution that your TV does not accept, the warning message will appear. After resolution change, if you cannot see the screen, please wait 20 seconds and the resolution will automatically revert back to the previous resolution.
- The 1080p video output frame rate may be automatically set to either 24Hz or 50Hz depending both on the capability and preference of the connected TV and based on the native video frame rate of the content on the BD-ROM disc.

### COMPONENT VIDEO OUT connection

- For the 1080p resolution setting with unprotected media, real output resolution of COMPONENT VIDEO OUT will change to 1080i.
- For the 720p, 1080i, 1080p resolution setting with protected media, real output resolution of COMPONENT VIDEO OUT will change to 576i or 576p depending on the connectivity of HDMI cable.
- BD or DVD could prevent up-scaling on analog output.

### VIDEO OUT connection

The resolution of the VIDEO OUT jack is always outputted at 576i resolution.

## Internet connection

This player can be connected to a local area network (LAN) via the LAN port on the rear panel.

After making the physical connection the player needs to be set up for network communication. This is done from the [Setup] menu — see “[NETWORK] Menu” on page 26 for detailed instructions.

Connect the player's LAN port to the corresponding port on your Modem or Router using a LAN cable.

Use a commercially available straight LAN cable (Category 5/CAT5 or better with RJ45 connector).

By connecting the unit to broadband Internet, you can use a disc that offers BD-Live and YouTube features.

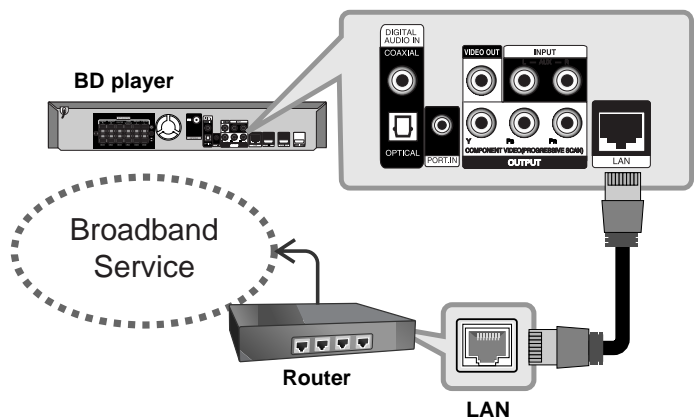

### Cautions:

- When plugging or unplugging the LAN cable, hold the plug portion of the cable. When unplugging, do not pull on the LAN cable but unplug while pressing down on the lock.
- Do not connect a modular phone cable to the LAN port.

- Since there are various connection configurations, please follow the specifications of your telecommunication carrier or internet service provider.

### Notes:

- Depending on the internet service provider (ISP), the number of devices that can receive internet service may be limited by the applicable terms of service. For details, contact your ISP.
- Our company is not responsible for any malfunction of the player and/or the internet connection feature due to communication errors/malfunctions associated with your broadband internet connection, or other connected equipment.
- Our company is not responsible for any trouble in your internet connection.
- The features of BD-ROM discs made available through the Internet Connection feature are not created or provided by our company, and our company is not responsible for their functionality or continued availability. Some disc related material available by the Internet Connection may not be compatible with this player. If you have questions about such content, please contact the producer of the disc.
- Some internet contents may require a higher bandwidth connection.
- Even if the player is properly connected and configured, some internet contents may not operate properly because of internet congestion, the quality or bandwidth of your internet service, or problems at the provider of the content.
- Some internet connection operations may not be possible due to certain restrictions set by the Internet service provider (ISP) supplying your broadband Internet connection.
- Any fees charged by an ISP including, without limitation, connection charges are your responsibility.
- A 10 Base-T or 100 Base-TX LAN port is required for connection to this player. If your internet service does not allow for such a connection, you will not be able to connect the player.
- You must use a Router to use xDSL service.

- A DSL modem is required to use DSL service and a cable modem is required to use cable modem service. Depending on the access method of and subscriber agreement with your ISP, you may not be able to use the internet connection feature contained in this player or you may be limited to the number of devices you can connect at the same time. (If your ISP limits subscription to one device, this player may not be allowed to connect when a PC is already connected.)
- The use of a "Router" may not be allowed or its usage may be limited depending on the policies and restrictions of your ISP. For details, contact your ISP directly.
- Your ISP may protect this player from being connected to network when confirming MAC ADDRESS. In that case, contact your ISP to request to initialize MAC ADDRESS.

## Setting the sound mode

You can select a suitable sound mode. Press SOUND repeatedly until the desired mode appears on the front panel display or the TV screen. The setting of the sound mode is not available when [HDMI Audio] is set to [On] (see page 24).

**[Natural] mode:** You can enjoy comfortable and natural sound.

**[Bypass] mode:** Software with multichannel surround audio signals is played according to the way it was recorded.

**[Bass Booster] mode:** Reinforce the bass sound effect from front left and right speaker and subwoofer.

**[PL II Movie] mode:** Performs Pro Logic II movie mode decoding to the input signal and produces five full-bandwidth output channels from 2 channel sources. This setting is ideal for watching videos of overdubbed or old movies. This mode is available only to 2 channel sources.

**[PL II Music] mode:** Performs Pro Logic II music mode decoding to the input signal and produces five full-bandwidth output channels from 2 channel sources. This setting is ideal for normal stereo sources such as CD. This mode is available only to 2 channel sources.

**[News] mode:** This mode makes voice sound clear, improving the quality of voice sound. This mode outputs sound from the front left and right speakers, center speaker, and subwoofer.

**[Drama] mode:** You can enjoy more dynamic sound with improved center channel while watching a television drama. This mode outputs sound from the front left and right speakers, center speaker, and subwoofer.

**[Sports] mode:** This mode produces dynamic sound expansion for the sports program.

**[Game] mode:** You can enjoy more virtual sound while playing video games.

**[Concert] mode:** Creates the sound of concert hall.

**[Music ReTouch] mode:** When listening to MP3 files or other compressed music, you can enhance the sound. This mode is available only to 2 channel sources.

### Note:

Only [BYPASS] mode is available when [HD Audio Effect] is set to [off] and playing a source that contains Dolby Digital Plus, Dolby TrueHD and DTS-HD.

## Adjust the speaker level settings

You can adjust the sound level of each speaker. Press SPK LEVEL repeatedly to select a desired speaker to set. Press VOL. (+/-) to adjust the sound level of the selected speaker while the level setting menu is displayed on the front panel display or the TV screen. Repeat and adjust the sound level of the other speakers.

## Using the late night function

You can compress the dynamic range of the sound track.

Press NIGHT repeatedly.

This may be useful when you want to watch movies at low volumes late at night.

**[NIGHT OFF]:** Late night function off.

**[NIGHT ON]:** Reduction in dynamic range.

### Notes:

- The late night function may be less effective or have no effect depending on the source.
- During the late night mode is on, the lighting of the touch buttons and the volume knob are turned off and the front panel display is dimmed.

## Using the sleep timer

You can set the system to turn off at a preset time, so you can fall asleep listening to music.

- Press SLEEP repeatedly to select the desired time period options (in minutes): (Dimmer on → Sleep timer value → Dimmer off)

Dimmer on: The lighting of the touch buttons and the volume knob are turned off and the front panel display is dimmed.

- To view the time countdown to the standby mode, press SLEEP again.

- To deactivate the sleep timer, press SLEEP until the previous status is displayed or press POWER to switch the unit to standby.

## Using USB devices

This unit can play the movie, music and photo files contained on the USB device.

	ON REMOTE
<b>1. Connect a USB device:</b>	–
<b>2 Displays the [Home Menu]:</b>	HOME
<b>3 Select a main option:</b> [Movie], [Photo] or [Music] option	◀ ▶, ENTER
<b>4 Select the [USB] option:</b>	◀ ▶
<b>5 Displays corresponding menu list:</b> [MOVIE], [PHOTO] or [MUSIC] menu appears. Details for the menu are on pages 33-37.	ENTER

### Tip:

If you select the [Movie], [Photo] or [Music] option when the USB device is connected and a disc is inserted simultaneously, the menu for selecting a media will appear. Select a media then press ENTER.

For example:

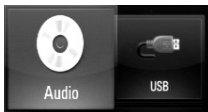

## Inserting/Removing the USB device

**Inserting the USB device** – Insert straight-in until it fits into place.

**Removing the USB device** – Withdraw the USB device or cable carefully.

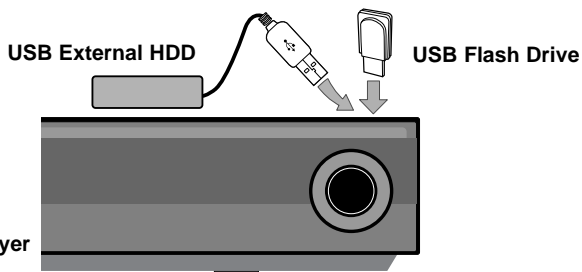

### Notes:

- This unit supports only USB Flash Drive and USB External HDD with FAT16 or FAT32 format.
- The USB device can be used for the local storage for enjoying BD-Live discs with Internet.
- This unit can support up to 4 partitions of the USB device.
- Do not extract the USB device during operation (play, etc.).
- A USB device which requires additional program installation when you have connected it to a computer is not supported.
- USB device: USB device that support USB1.1 and USB2.0.
- Movie files (DivX), Music files (MP3/WMA) and photo files (JPEG/PNG) can be played. For details of operations on each file, refer to relevant pages.
- Regular back up is recommended to prevent data loss.
- If you use a USB extension cable or USB HUB, the USB device may not be recognized.
- Some USB devices may not work with this unit.
- Digital camera and mobile phone are not supported.
- USB Port of the unit cannot be connected to PC. The unit cannot be used as a storage device.

## Using the Home Menu

	ON REMOTE
1 Displays the [Home Menu]:	HOME
2 Select an option:	◀▶
3 Displays the selected option menu:	ENTER
4 Exit the [Home Menu]:	HOME

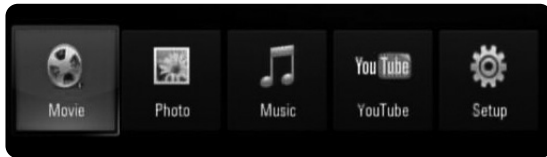

[Movie] – Start video media’s playback or displays the [MOVIE] menu.

[Photo] – Displays [PHOTO] menu. (page 36-37)

[Music] – Displays [MUSIC ]menu. (page 35-36)

[YouTube] – Watch YouTube videos streamed from the Youtube server via the internet to your TV. (page 38-40)

[Setup] – Displays the [Setup] menu. (page 21-27)

### Tip:

If you select the [Movie], [Photo] or [Music] option when the USB device is connected and a disc is inserted simultaneously, the menu for selecting a media will appear. Select a media then press ENTER.

### Notes:

- The unit will be in stop mode then the [Home Menu] will appear if you press HOME during playback.
- If you insert a DVD or an unplayable disc that is formatted as ISO9660 or UDF, the [Movie], [Photo] or [Music] option can be selected in the [Home Menu]. But you cannot play it.

## Adjust the Setup settings

	ON REMOTE
1 Displays the [Home Menu]:	HOME
2 Select the [Setup] option:	◀▶, ENTER
3 Select a desired option on the first level:	▲▼
4 Move to second level:	▶
5 Select a desired option on the second level:	▲▼
6 Move to third level:	▶
7 Adjust or confirm the setting: Some items require additional steps.	▲▼, ENTER
8 Go back to the previous level:	◀
9 Exit the [Setup] menu:	HOME or RETURN

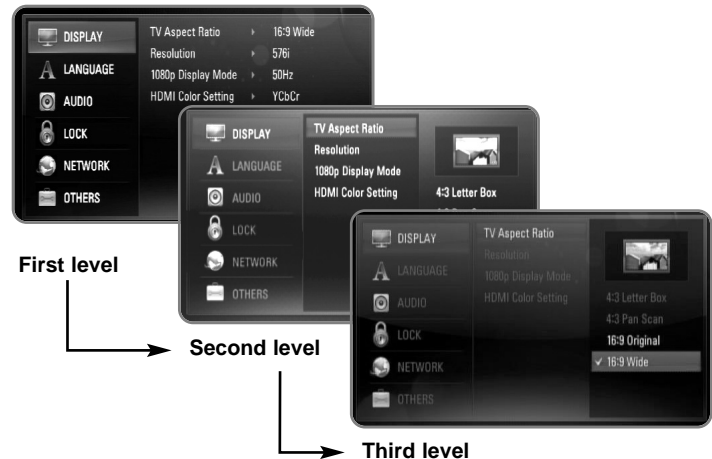

## [DISPLAY] Menu

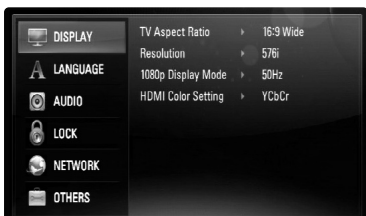

### TV Aspect Ratio

**[4:3 Letter Box]** – Select when a standard 4:3 TV is connected. Displays theatrical images with masking bars above and below the picture.

**[4:3 Pan Scan]** – Select when a standard 4:3 TV is connected. Displays pictures cropped to fill your TV screen. Both sides of the picture are cut off.

**[16:9 Original]** – Select when a 16:9 wide TV is connected. The 4:3 picture is displayed with an original 4:3 aspect ratio, with black bars appearing at the left and right sides.

**[16:9 Wide]** – Select when a 16:9 wide TV is connected. The 4:3 picture is adjusted horizontally (in a linear proportion) to fill the entire screen.

### Note:

You cannot select [4:3 Letter Box] and [4:3 Pan Scan] option when the resolution is set to higher than 720p.

### Resolution

Sets the output resolution of the Component and HDMI video signal. Refer to “Resolution Setting” on page 16-17 for details about the resolution.

**[Auto]** – If the HDMI OUT jack is connected for TVs providing display information (EDID), automatically selects the resolution best suited to the connected TV. If the COMPONENT VIDEO OUT is only connected, this changes the resolution to 1080i as default resolution.

**[1080p]** – Outputs 1080 lines of progressive video (only for HDMI connection).

**[1080i]** – Outputs 1080 lines of interlaced video.

**[720p]** – Outputs 720 lines of progressive video.

**[576p]** – Outputs 576 lines progressive video.

**[576i]** – Outputs 576 lines of interlaced video.

### 1080p Display Mode

When the resolution is set to 1080p, select [24Hz] for smooth presentation of film material (1080/24p) with a HDMI-equipped display compatible with 1080/24p input.

### Notes:

- When you select [24Hz], you may experience some picture disturbance when the video switches video and film material. In this case, select [50Hz].
- Even when [1080p Display Mode] is set to [24Hz], if your TV is not compatible with 1080/24p, the actual frame frequency of the video output will be 50Hz or 60Hz to match the video source format.

### HDMI Color Setting

Select the type of output from the HDMI OUT jack. For this setting, please refer to the manuals of your display device.

**[YCbCr]** – Select when connecting to a HDMI display device.

**[RGB]** – Select when connecting to a RGB display device.

## [LANGUAGE] Menu

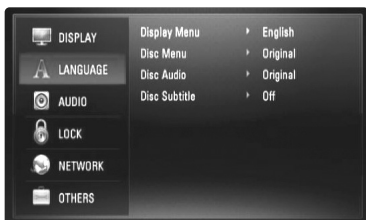

### Display Menu

Select a language for the [Setup] menu and on-screen display.

### Disc Menu / Disc Audio / Disc Subtitle

Select the language you prefer for the audio track (disc audio), subtitles, and the disc menu.

**[Original]** – Refers to the original language in which the disc was recorded.

**[Other]** – Press ENTER to select another language. Use number buttons then ENTER to enter the corresponding 4-digit number according to the language code list on page 46.

**[Off] (for Disc Subtitle)** – Turn off Subtitle.

### Note:

Depending on a disc, your language setting may not work for some disc.

## [AUDIO] Menu



### Speaker Setup

To obtain the best possible sound, use the Speaker Setup display to specify the volume of the speakers you have connected and their distance from your listening position. Use the Test to adjust the volume of the speakers to the same level.

**[Speaker]** – Select a speaker that you want to adjust.

**[Volume]** – Adjust the output level of each speaker. Be sure to set “Test” to “All” for easy adjustment.

**[Distance]** – Adjust the distance between each speaker and the listening position.

**[Test]** – The speakers will emit a test tone.  
All: The test tone is emitted from each speaker in sequence.

To save your settings, press ENTER and select [Yes] by pressing ◀ / ▶.

## HD Audio Effect

Selects whether to mix or not mix primary audio and secondary audio.

**[Off]** – Outputs the primary audio only.

**[On]** – Outputs the audio obtained by mixing the primary audio, secondary audio and sound effects.

## HD AV Sync

Sometimes Digital TV encounters a delay between picture and sound. If this happens you can compensate by setting a delay on the sound so that it effectively 'waits' for the picture to arrive: this is called HD AV Sync.

Use ▲ ▼ to scroll up and down through the delay amount, which you can set at anything between 0 and 300m sec.

The delay will vary depending on which digital TV channel you are on. If you change channel you may need to readjust the HD AV Sync.

## HDMI Audio

You can set TV speaker output for the audio signal from the HDMI OUT jack.

**[Off]** – Audio signals are output to the system speakers only.

**[On]** – Audio signals are output from the TV's speaker and the system's front left and right speaker and subwoofer.

### Note:

When [HDMI Audio] is set to [On], the sound mode is switched to [BYPASS] automatically.

## [LOCK] Menu (Parental Control)

The [LOCK] settings affect only BD and DVD playback.

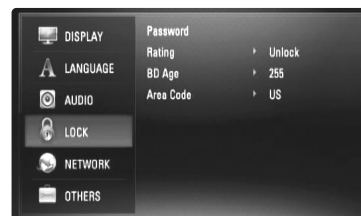

To access the any features in [LOCK] settings, you must enter the 4-digit security code you have created.

If you have not entered a password yet, you are prompted to do so. Enter a 4-digit password and press ENTER. Enter it again and press ENTER to verify.

### Password

You can create, change or delete the password.

**[New]** – Enter a 4-digit password and press ENTER. Enter it again and press ENTER to create a new password.

**[Change]** – Enter the current password and press ENTER.

Enter a 4-digit password and press ENTER. Enter it again and press ENTER to create a new password.

**[Delete]** – Enter the 4-digit password and press ENTER to delete the password.

### Tip:

If you make a mistake before pressing ENTER, press CLEAR. Then input the correct password.

### If you forget your password

If you forget your password, you can clear it using the following steps:

- 1 Remove any disc that might be in the player.
- 2 Highlight [Password] in the [LOCK] option.
- 3 Use Number buttons to enter "210499". The password is cleared.



## Rating

Blocks playback of rated disc based on their content. (Not all discs are rated.)

**[Rating 1-8]** – Rating one (1) has the most restrictions and rating eight (8) is the least restrictive.

**[Unlock]** – If you select unlock, parental control is not active and the disc plays in full.

## BD Age

Set an age limit of BD-ROM play. Use number buttons to input an age limit for BD-ROM viewing.

**[255]** – All BD-ROM can be played.

**[0-254]** – Prohibits play of BD-ROM with corresponding ratings recorded on them.

## Area Code

Enter the code of the area whose standards were used to rate the DVD video disc, based on the list on page 46.

## [NETWORK] Menu

The [NETWORK] settings are needed to use the BD Live and YouTube features.

Some BD-ROM discs may enable you to access special BD-ROM sites, if you connect the player to the Internet. For example, if a BD-ROM site includes content such as links to future movie trailers, you can watch the downloaded on-line content on the player.

You do not need to connect to a PC to use this function.

### Preparations:

- This feature requires an always-on broadband internet connection. (see page 18-19.)
- A BD-ROM disc compatible with this feature is required. Not all BD-ROM discs are compatible.

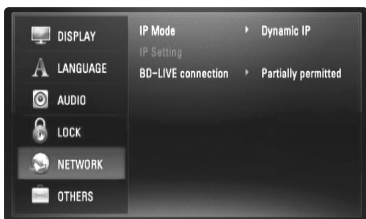

### IP Mode

If there is a DHCP server on the local area network (LAN), this player will automatically be allocated an IP address. If you're using a broadband router or broadband modem that has a DHCP (Dynamic Host Configuration Protocol) server function, select [Dynamic IP]. The IP address will automatically be determined.

If there is no DHCP server on the network and you want to set the IP address manually, select [Static IP] then set the [IP Address], [Subnet Mask], [Gateway] and [DNS Server] using [IP Setting] option.

### Note:

The [IP Mode] menu shows if the internet is connected or not. "⊗" will appear when connection is failed.

### How to check the network configuration

Select [IP Mode] option and check the Network status indicator shown above the menu. (The Network status indicator changes according to Network configuration.)



Able to use network



Testing Network



Unable to use network

### IP Setting

This option is available only if [IP Mode] option is set to [Static IP].

Use the ▲ / ▼ / ◀ / ▶ buttons to select a field; use the number buttons to enter a value. Press ENTER when [OK] is highlighted to finish and exit the screen.

### BD-LIVE connection

You can restrict Internet access when BD-Live functions are used.

**[Permitted]** – Internet access is permitted for all BD-Live contents.

**[Partially permitted]** – Internet access is permitted only for BD-Live contents which have content owner certificates. Internet access and AACS Online functions are prohibited for all BD-Live contents without a certificate.

**[Prohibited]** – Internet access is prohibited for all BD-Live contents.

## [OTHERS] Menu



### Skin

Changes the background of the initial screen.

### Java Font Size **BD**

You can adjust the default text size displayed for the BD-J contents during BD-ROM playback.

This setting is not valid when the size of text on BD-J contents is fixed.

Please select a font size bigger than 24 when the player is connected with an HD TV.

### Initialize

You can reset the player to its original factory settings, initialize the BD storage or deactivate the player.

**[Factory Set]** – If you need to, you can reset the player to all its factory settings. Some options cannot be reset. (Rating, Password and Area Code, etc.)

**[BD Storage Clear]** – Initializes the BD contents from the connected USB device.

### DivX Registration Code

DivX® is a digital video format created by DivX, Inc. This is an official DivX Certified or DivX Ultra Certified device that plays DivX video.

This DivX® Certified device must be registered in order to play DivX Video-on-Demand (VOD) content. First generate the DivX VOD registration code for your device and submit it during the registration process. [Important: DivX VOD content is protected by a DivX DRM (Digital Rights Management) system that restricts playback to registered DivX Certified devices. If you try to play DivX VOD content not authorized for your device, the message "Authorization Error" will be displayed and your content will not play.]. Learn more at [www.divx.com/vod](http://www.divx.com/vod).

Press ENTER or ► when [DivX Reg. Code] is highlighted and you can view the registration code of the unit.

### Note:

All the downloaded videos from DivX® VOD can only be played back on this unit.

## Play a disc

	ON REMOTE
<b>1 Open the disc tray:</b>	OPEN/CLOSE (▲)
<b>2 Insert a disc:</b>	-
<b>3 Close the disc tray:</b>	OPEN/CLOSE (▲)
<b>4 Adjust the disc menu settings:</b> A disc menu may not appear on the screen depending on the disc.	▲ ▼ ◀ ▶, ENTER
<b>5 Starts playback:</b>	PLAY (▶)
<b>6 Stops playback:</b>	STOP (■)

### Notes:

- When you turn on the player or replace a disc, the player returns to the initial default setting. Depending on a disc, a specific type of audio that the disc has is output.
- Depending on the pre-recorded contents of the BD-ROM, some functions may not be available or may be operated differently than other media.

### If a disc menu screen is displayed

**BD DVD AVCHD**

The menu screen may be displayed first after loading a disc which contains a menu.

Use ◀ / ▶ / ▲ / ▼ buttons to select the title/chapter you want to view, then press ENTER to start playback.

### Skip to the next/previous chapter/track/file **ALL**

During playback, press ◀◀ or ▶▶ to go to the next chapter/track/file or to return to the beginning of the current chapter/track/file.

Press ◀◀ twice briefly to step back to the previous chapter/track/file.

### Resume playback **ALL**

During playback, press STOP (■) to stop playback.

The unit records the stopped point, depending on the disc. "■■■" appears on the screen briefly. Press PLAY (▶) to resume playback (from the scene point). If you press STOP (■) again or unload the disc ("■" appears on the screen.), the unit will clear the stopped point. (■■■ = Resume Stop, ■ = Complete Stop)

### Notes:

- The resume point may be cleared when a button is pressed (for example; POWER, OPEN/CLOSE, etc).
- On BD-Video discs including BD-J, the resume play function does not work.
- On BD-ROM interactive title, the unit will be in Complete Stop mode if you press STOP once during playback.

### Pause a playback **ALL**

During playback, press PAUSE/STEP (||) to pause playback. Press PLAY (▶) to continue playback.

**Tip:** During Audio CD or MP3/WMA playback, press || once again to resume playback.

### Frame-by-Frame playback **BD DVD AVCHD DivX**

Press PAUSE/STEP (||) repeatedly to play Frame-by-Frame playback.

### Slow down the playing speed **BD DVD AVCHD DivX**

While the playback is paused, press SCAN ▶▶ repeatedly to play in slow motion (4 steps, forward only).

### Fast forward or fast reverse **ALL**

Press SCAN (◀◀ or ▶▶) to play fast forward or fast reverse during playback.

You can change the various playback speeds by pressing SCAN (◀◀ or ▶▶) repeatedly. Press PLAY (▶) to continue play at normal speed.

### Note:

This function may not work on some disc or titles.

## Playing repeatedly **BD DVD ACD MP3 WMA AVCHD**

During playback, press REPEAT repeatedly to select a desired repeat mode. The current title, chapter or track will be played back repeatedly. To return to normal playback, press REPEAT repeatedly to select [OFF].

### **Note:**

If you press ►| once during Repeat Chapter/Track playback, the repeat playback cancels.

## Viewing the Title menu or Popup menu

**BD DVD AVCHD**

Press TITLE/POPUP to display the title menu or popup menu. If the current DVD or BD-ROM disc has a menu, the Title menu or Popup menu appears on the screen. Depending on the disc, the menu may not be available.

## Using the search menu **BD DVD AVCHD DivX**

During playback, press SEARCH to display the search menu. Press ◀ / ▶ to skip the playback by about 15 seconds forward or backward.

### **Tip:**

You can select a point that you want to skip by pressing and holding ◀ / ▶ button.

## Marker Search **BD DVD AVCHD DivX**

### **To enter a Marker**

You can start playback from up to nine memorized points. To enter a marker, press MARKER at the desired point on the disc. The Marker icon appears on the TV screen briefly. Repeat to enter up to nine markers.

### **To Recall or Clear a Marked Scene**

Press SEARCH and the search menu appears on the screen. Press a number button to select a marker number that you want to recall. Playback starts from the marked scene.

**OR**

Press ▼ to highlight a marker number. Use ◀ / ▶ to select a marked scene that you want to recall or clear.

Press ENTER and playback starts from the marked scene. Press CLEAR and the marked scene is erased from the search menu.

### **Notes:**

- This function may not work on some discs or titles.
- All marked points are cleared if you press STOP (■) twice (complete stop), the title is changed or if you unload the disc.

## Selecting a subtitle language **BD DVD AVCHD DivX**

During playback, press SUBTITLE repeatedly to select a desired subtitle language.

OR

During playback, press DISPLAY to display the playback menu. Use ▲ ▼ to select the [Subtitle] option then use ◀ ▶ to select desired subtitle language.

### Note:

Some discs allow you to change subtitle selections only via the disc menu. If this is the case, press TITLE/POPOP or DISC MENU button and choose the appropriate subtitle from the selections on the disc menu.

## Hearing a different audio **BD DVD AVCHD DivX**

During playback, press DISPLAY to display the playback menu. Use ▲ ▼ to select the [Audio] option then use ◀ ▶ to select desired audio language or audio track.

### Notes:

- Some discs allow you to change audio selections only via the disc menu. If this is the case, press TITLE/POPOP or DISC MENU button and choose the appropriate audio from the selections on the disc menu.
- Immediately after you have switched sound, there may be a temporary discrepancy between the display and actual sound.
- On BD-ROM disc, the multi audio format (5.1CH or 7.1CH) is displayed with [MultiCH] in the on-screen display.

## Using coloured (A, B, C, D) Buttons **BD**

These buttons are available only during BD-J contents playback. Use the appropriate buttons as indicated by the display. Depending on the disc contents, the functions of each button may differ.

## Last Scene Memory **BD DVD**

This unit memorizes last scene from the last disc that is viewed. The last scene remains in memory even if you remove the disc from the unit or switch off the unit. If you load a disc that has the scene memorized, the scene is automatically recalled.

### Notes:

- Settings are stored in memory for use any time.
- This unit does not memorize settings of a disc if you switch off the unit before commencing to play it.
- Last Scene Memory function for a previous disc is erased once a different disc is played.
- This function may not work depending on the disc.

## Screen Saver

The screen saver appears when you leave the player in Stop mode for about five minutes.

### Note:

Depending on the unit status, the screen saver may not appear.

## Displaying disc information

	ON REMOTE
1 Play the disc loaded on the unit:	PLAY
2 Displays the playback menu:	DISPLAY
3 Select an item:	▲ ▼
4 Adjust the playback menu settings:	◀ ▶
5 Exit the disc playback menu:	DISPLAY



- 1 Title – Current title number/total number of titles.
- 2 Chapter – Current chapter number/total number of chapters.
- 3 Time – Elapsed playing time.
- 4 Audio – Selected audio language or channel.
- 5 Subtitle – Selected subtitle.
- 6 Angle – Selected angle/total number of angles.

### Notes:

- If no button is pressed for a few seconds, the on-screen display disappears.
- A title number cannot be selected on some discs.
- An item may not be available on some discs or titles.
- If BD interactive title is playing back, some setting information is displayed on the screen but prohibited to be changed.

## Moving to another title/chapter

**BD DVD AVCHD DivX**

When a disc has more than one title/chapter, you can move to another title/chapter/track.

Press DISPLAY during playback then use ▲ / ▼ to select the [Title/Chapter] icon. Then, press the appropriate numbered button (0-9) or ◀ / ▶ to select a title/chapter number.

## Playing from selected time **BD DVD AVCHD DivX**

Press DISPLAY during playback. The time search box shows the elapsed playing time. Select the [Time] option and then input the required start time in hours, minutes, and seconds from left to right. For example, to find a scene at 2 hours, 10 minutes, and 20 seconds, enter “21020” and press ENTER. If you enter the wrong numbers, press CLEAR and enter the correct numbers.

### Note:

This function may not work on some disc or titles.

## Watching from a different angle **BD DVD**

If the disc contains scenes recorded at different camera angles, you can change to a different camera angle during playback.

During playback, press DISPLAY to display the playback menu. Use ▲ ▼ to select the [Angle] option, then use ◀ ▶ to select desired angle.

## Enjoying BD-LIVE™

	ON REMOTE
<b>1 Inserts a BD-ROM disc with BD-LIVE™ features:</b>	<b>OPEN/CLOSE (▲)</b>
<b>2 Check the network connection and settings:</b> BD-Live features need the internet connection.	–
<b>3 Connect a USB device:</b> A USB device is required to use this function.	–
<b>4 Select a BD-LIVE™ features on the disc menu:</b>	<b>▲ ▼ ◀ ▶, ENTER</b>

This unit allows you to enjoy functions such as picture-in-picture, secondary audio and Virtual packages, etc., with BD-Video supporting BONUSVIEW (BD-ROM version 2 Profile 1 version 1.1/ Final Standard Profile). In addition to the BONUSVIEW function, BD-Video supporting BD-Live (BD-ROM version 2 Profile 2) that has a network extension function allows you to enjoy more functions such as online games by connecting this unit to the Internet.

### Enjoying BD-Live discs with Internet

This unit supports BD-Live, a new BD-Video function that allows you to use the following interactive functions when connected to the Internet. (The usable functions and the operating method may vary with each disc. For details, refer to the instructions for the disc.)

- Additional contents such as movie's trailer, subtitles and BD-J, etc. can be downloaded to USB device to play them.
- Special video data, etc. may be played back while they are being downloaded to a USB device.

#### Preparations:

- The unit must be connected to the Internet and set up to use the BD-Live functions (see page 18-19 and 26).
- A USB device is required to use this function. Connect a USB device (see page 20).
- The free space in the USB device must be more than 1GB.

#### Caution:

Do not extract the connected USB device while content is being downloaded or a Blu-ray disc is still in the disc tray. Doing so may damage the connected USB device and BD-Live features may not operate properly with the damaged USB device anymore.

If the connected USB device seems damaged from such an action, you can format the connected USB device from the PC and reuse it with this player.

#### Notes:

- Some BD-Live contents may be restrictively accessed in some territories by contents provider's own decision.
- It may take up to several minutes to load and start enjoying BD-Live contents.
- Depending on a disc, the BD-Live function may not be operated if [BD-LIVE connection] option is set to [Partially permitted]. (See page 26.)
- The connection to the Internet may take time or the Internet may not be connected depending on the connection environment. It is required that you use a broadband connection.
- Do not remove the USB device during operation. The USB device may be damaged. Stop playback and turn off the menu beforehand.

#### Tip:

Special video data, etc. may be played back while they are being downloaded to a USB device using one function of BD-Live. The playback may be paused depending on the communication environment. Some functions may be disabled to prevent skipping to sections that have not been downloaded, etc.

### AACS Online

When discs supporting BD-Live are played back, the player or disc IDs may be sent to the content provider via the Internet.

- Services and functions to be provided differ depending on the disc.
  - You can be introduced to other similar movies if you record your viewing history on the server by using these IDs.
  - Game score histories can be saved.



## Playing secondary video (picture-in-picture)

Secondary video can be played from a disc compatible with the picture-in-picture function.

For the playback method, refer to the instructions for the disc.

To turn on/off secondary video, press PIP. Secondary video is played.

Press the button to turn it ON or OFF.

### Notes:

- Discs may not always be played back according to the settings on this unit, as certain playback formats are prioritized on certain discs.
- Only the primary video is played during search/slow-motion or frame-by-frame.
- This function may not work depending on the disc.

## Playing a movie

The player can play DivX files on the disc/USB device and video contents recorded on a DVD-RW(VR mode) discs. Before playing DivX files, read "DivX file requirement" on page 34.

### ON REMOTE

<b>1 Insert a disc containing DivX files, or connect the USB device containing DivX files.</b>	—
<b>2 Displays the [Home Menu]:</b>	<b>HOME</b>
<b>3 Select the [Movie] option:</b>	<b>◀▶, ENTER</b>
<b>4 Selects a movie from the [MOVIE] menu:</b>	<b>▲▼</b>
<b>5 Plays the selected movie:</b>	<b>PLAY</b>
<b>6 Stops the playback:</b>	<b>STOP</b>

### Note:

- When the USB device is connected and a disc is inserted simultaneously, the menu for selecting a media will appear. Select a media then press ENTER.
- You can use various playback functions. Refer to pages 28-31.
- On the [MOVIE] menu, use red (A) or blue (D) button to move to the previous or next page.
- Unfinalized DVD VR format discs may not be played in this player.
- Some DVD-VR disc are made with CPRM data by DVD RECORDER. This unit cannot support these kinds of discs.
- Some DivX files may not play, depending on the DivX format or the recording format.
- Press DISC MENU to move to the list menu.

### What is CPRM?

CPRM is a copy protection system (with scramble system) only allowing the recording of 'copy once' broadcast programs. CPRM stands for Content Protection for Recordable Media.

## Movie List menu options (DVD-RW (VR mode disc))

Use ▲ / ▼ to select a title on the [MOVIE] menu then press ENTER. The menu options appear.

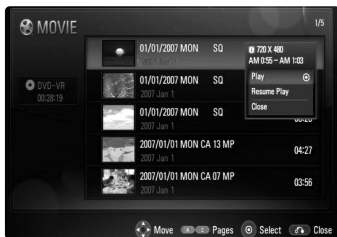

Use ▲ / ▼ to select an option, then press ENTER.

- **[Play]** Starts playback of the selected title.
- **[Resume Play]** Starts playback from where you stopped it previously.
- **[Close]** Exits menu options. Also you can disappear it by pressing RETURN button.

## Notice for displaying the DivX subtitle

If the subtitle does not display properly, change the language code as described below.

- 1 Press and hold SUBTITLE for 3 seconds during playback.  
The language code will appear.
- 2 Press SUBTITLE repeatedly to select another language code until the subtitle is displayed properly and then press ENTER.

## DivX file requirement

DivX file compatibility with this player is limited as follows:

- Available resolution size: 720x576 (W x H) pixel.
- The file names of DivX and subtitle are limited to 50 characters.
- DivX file extensions: “.avi”, “.divx”, “.mpg”, “.mpeg”
- Playable DivX subtitle: SubRip (.srt / .txt), SAMI (.smi), SubStation Alpha (.ssa/.txt), MicroDVD (.sub/.txt), SubViewer 1.0 (.sub), SubViewer 2.0 (.sub/.txt), TMPlayer (.txt), DVD Subtitle System (.txt)
- Playable Codec format: “DIVX3.xx”, “DIVX4.xx”, “DIVX5.xx”, “DIVX6.xx” (Standard playback only)
- Only the playback function is supported with DivX 6.0 in the unit.
- Playable Audio format: “Dolby Digital”, “DTS”, “MP3”
- Sampling frequency: within 32 - 48 kHz (MP3)
- Bit rate: within 32 - 320 kbps (MP3)
- CD-R/RW, DVD±R/RW, BD-R/RE Format: ISO 9660+JOLIET, UDF and UDF Bridge format
- Maximum Files/Folder:  
Less than 1999 (total number of files and folders)

## Listening to a music

The player can play Audio CDs and MP3/WMA files. Before playing MP3/WMA files, read "MP3/WMA audio file requirement" on page 36.

### ON REMOTE

<b>1 Insert Audio CD or a disc containing MP3/WMA files, or connect the USB device containing MP3/WMA files.</b>	–
<b>2 Displays the [Home Menu]:</b>	<b>HOME</b>
<b>3 Select a [Music] option:</b>	<b>◀▶, ENTER</b>
<b>4 Selects a music from the [MUSIC] menu:</b>	<b>▲▼</b>
<b>5 Plays the selected music:</b>	<b>PLAY</b>
<b>6 Stops the playback:</b>	<b>STOP</b>

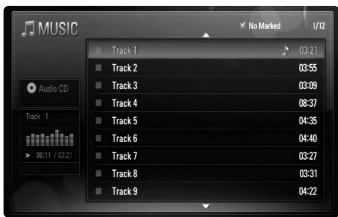

Example) Audio CD

### Note:

When the USB device is connected and a disc is inserted simultaneously, the menu for selecting a media will appear. Select a media then press ENTER.

### Tips:

- To go directly to any track or file and play, enter the track/file number using the numbered buttons (0-9).
- The playback may start automatically if the Audio CD inserted.
- Select a folder then press ENTER and you can view the files in the folder. If you want to move to the upper directory, use ◀ or ▶/▲ to highlight [UP Folder] and press ENTER.

- On the [MUSIC] menu, use red (A) or blue (D) button to move to the previous or next page.
- The equalizer indicator is not coupled with the music in play back.
- If there is impossible code to express in the file name, it may be displayed as illegible.
- You can use variable playback functions. Refer to page 28-29.

### The [MUSIC] menu options

Use ▲ / ▼ to select a track or file on the [MUSIC] menu then press ENTER. The menu options appear.

Use ▲ / ▼ to select an option, then press ENTER.



- [Play]** Starts playback the selected track or file.
- [Select Play]** Plays back only the marked track(s) or file(s). Use MARKER for selecting the multiple files or tracks.
- [Random]** Starts or stops random playback. By pressing ▶▶ during random playback, the unit selects another track and resumes random playback.
- [Unmark All]** Unmarks all marked files or tracks.
- [Close]** Exits menu options. Also you can disappear it by pressing RETURN button.

### Note:

You cannot use [Select Play] and [Random] functions simultaneously.

## MP3/WMA audio file requirement

**File extensions:** “.mp3”, “.wma”

**Sampling frequency:** within 32 - 48 kHz (MP3),  
within 32 - 48 kHz (WMA)

**Bit rate:** within 32 - 320 kbps (MP3), within 40 - 320 kbps (WMA)

**CD-R/RW, DVD±R/RW, BD-R/RE Format:**

ISO 9660+JOLIET, UDF and UDF Bridge format

**Maximum Files/Disc:**

Less than 1999 (total number of files and folders)

**Notes on MP3/WMA file**

- Depending on the size and number of the MP3/WMA files, it may take several minutes to read the contents of the media.
- This unit cannot support the ID3 Tag embedded in the MP3 file.

## Viewing a photo

This unit can play a photo files. Before playing photo files, read “Photo file requirement” on page 37.

ON REMOTE

<b>1 Insert a disc containing photo files, or connect the USB device containing photo files.</b>	—
<b>2 Displays the [Home Menu]:</b>	HOME
<b>3 Select a [Photo] option:</b>	◀▶, ENTER
<b>4 Selects a photo from the [PHOTO] menu:</b>	▲▼/◀▶
<b>5 Displays the selected photo in full screen:</b>	ENTER
<b>6 Displays the next or previous photo:</b>	◀◀ / ▶▶
<b>7 Return to the [PHOTO] menu screen:</b>	STOP



### Note:

When the USB device is connected and a disc is inserted simultaneously, the menu for selecting a media will appear. Select a media then press ENTER.

### Tips:

- To go directly to any file and play, enter the file number using the numbered buttons (0-9).
- You can advance to the previous or next file by pressing ◀◀ or ▶▶ during viewing a photo file in full screen.
- You can start the slide show by pressing PLAY (▶) while the [PHOTO] menu appears.

- Select a folder then press ENTER and you can view the files in the folder. If you want to move to the upper directory, use ▲/▼/◀/▶ to highlight [UP Folder] and press ENTER.
- On the [PHOTO] menu, use red (A) or blue (D) button to move to the previous or next page.
- If there is impossible code to express in the file name, it may be displayed as illegible.

### Options during viewing a photo file in full screen

You can use various options during viewing a picture in full screen. Use ▲ ▼ ◀ ▶ to select an option and use the options as described below.

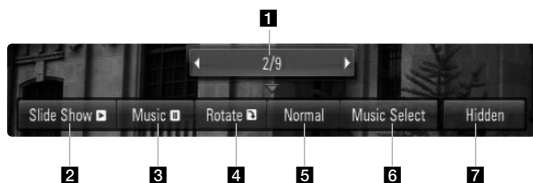

- 1 Use ◀/▶ to advance to the previous or next file.
- 2 Press ENTER to start or pause the slide show.
- 3 Press ENTER to play or pause the background music. This option is available after the background music is selected using [Music Select] option.
- 4 Press ENTER to rotate the picture clockwise. This option is not available during slide show.
- 5 Press ENTER to set the Slide Show speed.
- 6 Selects the background music.
  - 1) Press ENTER and the menu will appear.
  - 2) Use ▲/▼/◀/▶ to select a media or folder that there are music file(s).
  - 3) Press ENTER to confirm your selection.
- 7 Press ENTER to exit the option menu. To appear the menu again, press ENTER.

### Photo file requirement

**File extensions:** “.jpg”, “.jpeg”, “.png”

**Recommended size:**

Less than 3,000 x 3,000 x 24 bit/pixel

Less than 3,000 x 2,250 x 32 bit/pixel

**CD-R/RW, DVD±R/RW, BD-R/RE Format:**

ISO 9660+JOLIET, UDF and UDF Bridge format

**Maximum Files/Disc:**

Less than 1999 (total number of files and folders)

**Notes on Photo file**

- Progressive and lossless compression photo image files are not supported.
- Depending on the size and number of the photo files, it may take several minutes to read the contents of the media.

## Playing YouTube videos

	ON REMOTE
<b>1 Check the network connection and settings:</b> See page 18-19 and 26.	–
<b>2 Check the network configurations:</b> See page 26.	–
<b>3 Displays the [Home Menu]:</b>	HOME
<b>4 Select the [YouTube] option:</b>	◀▶, ENTER
<b>5 Select a desired option on the YouTube menu:</b>	◀▶, ENTER
<b>6 Select a video you want to play:</b>	◀▶
<b>7 Start playback the selected video:</b>	PLAY (▶), ENTER or DISPLAY



### About the YouTube menu

There are various options on the YouTube menu. Use ▲▼◀▶ to select an option and press ENTER to select the options as described below.



- 1** Featured – The featured videos list will be displayed.
- 2** Recent Videos – The most recently updated videos list will be displayed.
- 3** Most Viewed – The most viewed videos list will be displayed. The period option appears at the bottom of the screen.
- 4** Top Rated – The best rated videos list from YouTube server will be displayed. The period option appears at the bottom of the screen.
- 5** Search – The keyboard menu will be displayed. See “Searching videos” on page 40 for more detail.
- 6** History – The list of videos that you recently played on this unit will be displayed. Maximum of 25 videos can be displayed.
- 7** Favorites – This option will be appeared only when the unit is in sign-in status. Displays the videos list that is arranged in the YouTube server with your account. Some videos may not appear on the [Favorites] list, even if the videos are arranged in the server.
- 8** Sign in (Sign Out) – Displays the keyboard menu to sign in or returns to the sign-out status. See “Sign in with your YouTube account” on page 40 for more details.
- 9** Local site – Choose which country's videos you would like to view. The countries listed on the [Local Site] menu may differ with those listed on the YouTube web site.

### Notes:

- The YouTube menu can display 5 videos in the videos list. Press red or blue button to display next/previous 5 videos.
- If you select the [Most Viewed] or [Top Rated] option in the YouTube menu, the period options appear at the bottom of the screen. Use ▲▼◀▶ to select a period option and press ENTER to display the videos list within the selected period.
- The videos list searched from the player may different with the list searched from a web browser on PC.

## About YouTube playback screen

When you press PLAY (▶) or ENTER at the video you want to watch, the playback screen and content detail will appear on the screen.



while playing

And when the playback ends or stops, the stopped playback screen and related videos list appear on the screen. Use ▲ ▼ ◀ ▶ to select the current video or a video from the related videos list and then press PLAY (▶) or ENTER to play the selected video.



while stopped

When you press DISPLAY at the video you want to watch, the playback starts in full screen.



Full Screen

Press DISPLAY to toggle between playback in full screen and playback screen with content detail.

## Playing a video

While watching a video from YouTube via your player, you can control the YouTube video playback. You can use the buttons on the remote to pause and resume viewing, just like when you watch a DVD. While playing a video, the buttons on the remote do the following:

Button(s)	Operations
▶ or ENTER	Starts playback the video with content detail.
DISPLAY	Toggle between playback in full screen and playback screen with content detail.
	To pause a video while it is playing. To resume playing a paused video, press PLAY (▶) again.
■	Stops the video and displays related videos list.
◀▶	Skip the playback forward or backward .
HOME	When you have finished watching videos, simply press the HOME button on the remote control to go to the [Home Menu].

### Notes:

- The settings of this player do not affect the YouTube's playback quality.
- The playback of YouTube videos may be paused, stopped or buffering occurring often depending on your broadband speed. We recommend a minimum connection speed of 1.5 Mbps. For the best playback condition, a connection speed of 4.0 Mbps is required. Sometimes your broadband speed varies based on your ISP's network conditions. Contact your ISP if you have problems maintaining a fast connection that is reliable, or if you want to increase your connection speed. Many ISPs offer a variety of broadband speed options.

## Searching videos

You can search for videos by entering search words of up to 128 characters.

Use ◀▶ to select [Search] option from the menu and press ENTER to display the keyboard menu. Use ▲▼◀▶ to select a character then press ENTER to confirm your selection on the keyboard menu.

To enter a letter with an accent mark, select the letter from extended character set.

Example: Select "D" and then press DISPLAY to display the extended character set. Use ◀▶ to select "D" or "D̂" and then press ENTER.



[OK]: Searching related videos of search words.

[Clear]: Clear all entered characters.

[Space]: Inserts a space at the cursor position.

[Backspace]: Deletes the previous character at the cursor position.

[ABC / abc / #+==&]: Change the keyboard menu settings to capital letter, small letters or symbols.

When you finish entering the search words, select [OK] and press ENTER to display the related videos list.

### Note:

Available languages to enter on the keyboard menu are as follows: English, Spanish, Italian, French, German, Dutch, Portuguese, Swedish, Polish and Czech.

## Sign in with your YouTube account

To watch videos from your [Favorites] video list on the YouTube server with your account, you need to sign in with your YouTube account.

Use ◀▶ to select [Sign In] option from the menu and press ENTER to display the keyboard menu. Use ▲▼◀▶ to select a character then press ENTER to confirm your selection on the keyboard menu.



[OK]: Finish entering an ID or password.

[Clear]: Clear all entered characters.

[Space]: Inserts a space at the cursor position.

[Backspace]: Deletes the previous character at the cursor position.

[ABC / abc / #+==&]: Change the keyboard menu settings to capital letters, small letters or symbols.

If you want to sign out, select the [Sign Out] from the YouTube menu and press ENTER.

This unit can automatically store up to 5 IDs which were previously signed-in. The IDs list appears when you select the [Sign In] option. Select a stored ID on the list and press ENTER to display the keyboard menu with the selected ID is entered. You will then only need to enter the password to sign in.

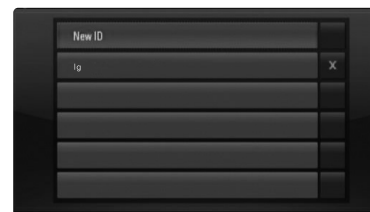

[New ID]: Displays the keyboard menu for entering a new ID and password.

[X]: Delete the stored ID as shown left of the [X] symbol.



## Listening to the radio

Be sure that FM antenna is connected.

### ON REMOTE

<b>1 Select FM:</b>	<b>TUNER (INPUT)</b>
<b>2 Select a radio station:</b>	<b>TUN.-/+</b>
<b>3 To save a radio station:</b> A preset number will show on the display. Up to 50 radio stations can be saved.	<b>ENTER</b>
<b>4 To confirm press:</b>	<b>ENTER</b>
<b>5 To select a saved station</b>	<b>PRESET ▲/▼</b>

## Listening to the radio - more you can do

### Look for radio stations automatically

Press and hold TUN.-/TUN.+ for more than a second. The tuner will scan automatically and stop when it finds a radio station.

### Choose a preset number for a radio station

When storing a radio station, the preset number can be chosen. When this unit automatically shows a preset number, press PRESET ▲/▼ to change it. Press ENTER to save your chosen number.

### Delete all the saved stations

Press and hold ENTER for two seconds. ERASE ALL will flash up on the display. Press ENTER to erase all saved radio stations.

### Improve poor FM reception

Press MO./ST. This will change the tuner from stereo to mono and usually improve the reception.

### See information about a radio station

The FM tuner is supplied with the RDS (Radio Data System) facility. This shows information about the radio station being listened to. Press RDS repeatedly to cycle through the various data types:

<b>PS</b>	(Programme Service Name) The name of the channel will appear in the display
<b>PTY</b>	(Programme Type Recognition) The programme type (e.g. Jazz or News) will appear in the display.
<b>RT</b>	(Radio Text) A text message contains special information from the broadcast station. This text may scroll across the display.
<b>CT</b>	(Time controlled by the channel) This shows the time and date as broadcast by the station.

## Playing the iPod

For details about iPod, refer to the iPod User Guide.

### Preparation

- To view iPod's Videos and Photos on the TV screen.
  - Be sure to use the video connection through the VIDEO OUT jack on the rear panel of this unit.
  - Select the appropriate video input mode on the TV.
  - Depending on the iPod, make sure that select Videos > Video settings, and then set TV Out to Ask or On from your iPod.
  - For details about Video Settings, refer to the iPod User Guide.
  - The viewing photos is available only if this unit is in REMOTE IPOD mode and you can view photos only as a slideshow.
  - You have to start a slideshow on your iPod to view a photo on a TV.
  - For details about a slideshow, refer to the iPod User Guide.
- Before connecting the iPod, turn this unit off and reduce the volume of this unit to its minimum.

### Connect the iPod firmly.

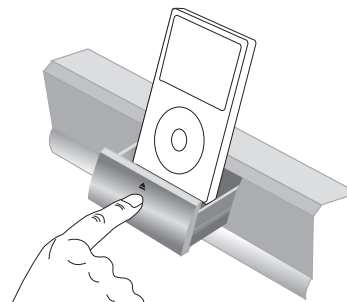

To open the iPod Dock:  
Push the marked ▲.  
To close the iPod Dock:  
Push the iPod Dock forward.

- If you turn this unit on, your iPod is automatically turned on and recharging starts.

To	Do this on remote
<b>Select an iPod mode</b>	Press iPod.
<ul style="list-style-type: none"> <li><b>REMOTE IPOD mode:</b> You can operate your iPod through an iPod's display by using the supplied remote control and also control on your iPod.</li> <li><b>OSD IPOD mode:</b> You can operate your iPod by controlling OSD menu on the TV screen with the supplied remote control. The controls on your iPod are not operational in the OSD iPod mode.</li> </ul>	

To	Do this on remote
Select a menu item	Press ▲ ▼ and ► or ENTER.
Go back to the previous menu	Press RETURN (↶) or DISC MENU or ◀.
Browse for a song	From the main menu, select Music.
Browse for a video	From the main menu, select Videos.
Play a song or video	Select the song or video and press ENTER.
Pause a song or video	Press PAUSE/STEP (⏸) or PLAY (▶). To continue playback, press PAUSE/STEP (⏸) or PLAY (▶) again.
Skip to the next song or video	Press SKIP (▶▶).
Start a song or video over	Press SKIP (◀◀).
Play the previous song or video	Press SKIP (◀◀) twice.
Fast-forward or rewind a song or video	Press and hold SCAN (◀◀ or ▶▶).
Repeat a song	Press REPEAT repeatedly to select a desired repeat mode: Track (↺), All (↻) Off (No display).

### Tip:

You may use the dock adapter which should be supplied with your iPod to the dock for the stable use of the iPod.

If you need an adapter, consult your iPod dealer.

### Notes:

- Compatibility with your iPod may vary depending on the type of your iPod.
- iPod touch and iPhone have may differ in operation from the iPod.  
You may need any additional control to use them with this unit.  
(e.g. "slide to unlock")
- **If you use an application, make a call, or send and receive SMS text message, etc. on your iPod touch or iPhone, disconnect it from the iPod dock of this unit and then use it.**
- Depending on your iPod's software version, it may not be possible to control your iPod from this unit. We recommend installing the latest software version.
- The video quality depends on the video sources on your iPod.
- When LG TV's SIMPLINK is set to On, the audio signals are output to the system speakers only.
- If this unit displays an error message, follow the message.  
An error message "CHECK IPOD" or "Please check your iPod." appears when:
  - the communication between this unit and your iPod is failed.  
→ Undock & re-dock your iPod in this unit.
  - your iPod is not connected firmly.
  - this unit recognizes your iPod as unknown device.
  - your iPod is exceptionally low on power.  
→ The battery needs to be charged.
  - If you charge the battery while iPod is extremely low in power, it may take longer to charge.
- An error message "CHECK IPOD" or "Connected iPod model is not supported." appears when:
  - your iPod is not available for the function to be operated.
- An error message "CHECK IPOD" or "Please update iPod's software." appears when:
  - your iPod has an old software version.  
→ Update your iPod software to latest version.
- If you have a problem with your iPod, please visit [www.apple.com/support/ipod](http://www.apple.com/support/ipod).

## Listening to music from your portable audio player

You can enjoy the sound of your portable audio player from the speakers of the system.

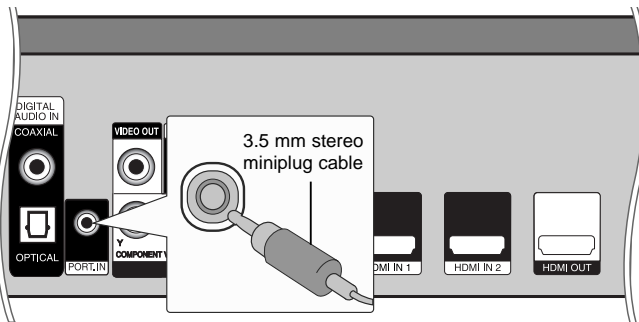

	ON REMOTE
<b>1</b> Connect the headphones (or line out ) jack of the portable audio player into the PORT. IN on the rear panel of this unit:	-
<b>2</b> Turn the power on:	POWER
<b>3</b> Select the [PORTABLE] option:	INPUT
<b>4</b> Turn down the volume of this unit:	VOL. (+/-)
<b>5</b> Turn the portable audio player on and start it playing:	-
<b>6</b> Adjust the volume of this unit and your portable audio player:	VOL. (+/-)

## Listening to the sound from your component

You can enjoy the sound of your component with the analog audio output jacks from the speakers of the system.

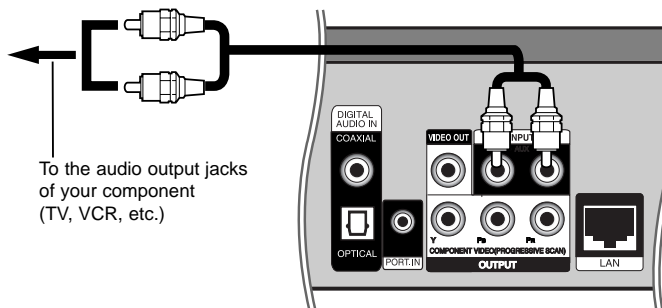

	ON REMOTE
<b>1</b> Connect the analog audio output jacks of your component into the AUX L/R (INPUT) on the rear panel of this unit:	-
<b>2</b> Turn the power on:	POWER
<b>3</b> Select the [AUX] option:	INPUT
<b>4</b> Turn down the volume of this unit:	VOL. (+/-)
<b>5</b> Turn your component on:	-
<b>6</b> Adjust the volume:	VOL. (+/-)

## Using HDMI IN jacks

You can enjoy the pictures and sound of your component with the HDMI OUT jack.

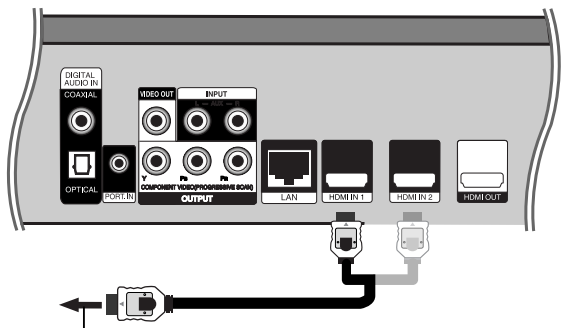

To the HDMI OUT jack of your component  
(set-top box, digital satellite receiver, video game machine, etc.)

	ON REMOTE
1 Connect the HDMI OUT jack of your component into the HDMI IN 1 or 2 jack on the rear panel of this unit.	-
2 Turn the power on:	POWER
3 Select the [HDMI IN 1] or [HDMI IN 2] option:	INPUT
4 Turn down the volume of this unit:	VOL.(+/-)
5 Turn your component on:	-
6 Adjust the volume of this unit:	VOL.(+/-)

### Note:

- You cannot change the video resolution at the HDMI IN 1/2 mode. Change the video resolution of the connected component.
- You cannot operate SIMPLINK function at the HDMI IN 1/2 mode.
- The setting of the sound mode is not available when Dolby Digital Plus, Dolby TrueHD and DTS-HD are played at HDMI IN 1/2 mode.
- If the video output signal is abnormal when your personal computer is connected to HDMI IN 1/2 jack, change the resolution of your personal computer to 576p, 720p, 1080i or 1080p.

## Using DIGITAL AUDIO IN jacks

You can enjoy the sound of your component with the digital optical or coaxial output jack from the speakers of the system.

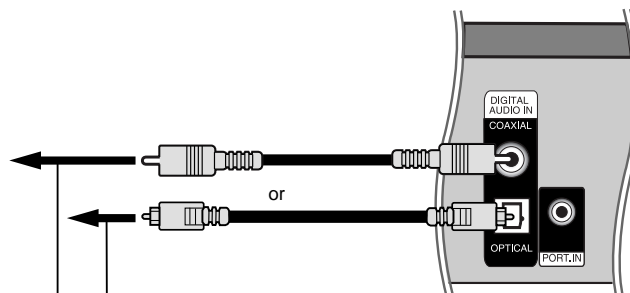

To the digital optical output jack of your component  
To the digital coaxial output jack of your component

	ON REMOTE
1 Connect the optical or coaxial output jack of your component into the OPTICAL or COAXIAL (DIGITAL AUDIO IN) jack on the rear panel of this unit.	-
2 Turn the power on:	POWER
3 Select the [OPTICAL] or [COAXIAL] option:	INPUT
4 Turn down the volume:	VOL.(+/-)
5 Turn your component on:	-
6 Adjust the volume:	VOL.(+/-)

## Reference

### Controlling a TV with the Supplied Remote Control

You can control the volume, input source, and power state of your LG/GoldStar TV with the supplied Remote Control.

You can control your TV using the buttons below.

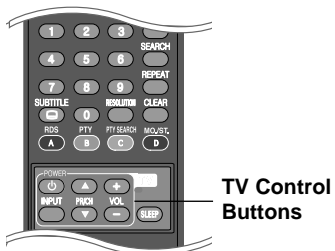

### Setting up the remote to control your TV

You can operate your LG/GoldStar TV with the supplied remote control.

While holding down TV POWER button, press PR/CH ▲ or ▼. Release the TV POWER button to complete setting.

When you replace the batteries of the remote, you may have reset the remote control.

By pressing	You can
TV POWER	Turn the TV on or off.
INPUT	Switch the TV's input source between the TV and other input sources.
PR/CH ▲/▼	Scan up or down through memorized channels.
VOL +/-	Adjust the volume of the TV.

## Language Codes

Use this list to input your desired language for Disc Audio, Disc Subtitle and Disc Menu.

Language	Code	Language	Code	Language	Code	Language	Code	Language	Code
Afar	6565	Croatian	7282	Hausa	7265	Lingala	7678	Quechua	8185
Afrikaans	6570	Czech	6783	Hebrew	7387	Lithuanian	7684	Rhaeto-Romance	8277
Albanian	8381	Danish	6865	Hindi	7273	Macedonian	7775	Rumanian	8279
Ameharic	6577	Dutch	7876	Hungarian	7285	Malagasy	7771	Russian	8285
Arabic	6582	English	6978	Icelandic	7383	Malay	7783	Samoan	8377
Armenian	7289	Esperanto	6979	Indonesian	7378	Malayalam	7776	Sanskrit	8365
Assamese	6583	Estonian	6984	Interlingua	7365	Maori	7773	Scots Gaelic	7168
Aymara	6588	Faroese	7079	Irish	7165	Marathi	7782	Serbian	8382
Azerbaijani	6590	Fiji	7074	Italian	7384	Moldavian	7779	Serbo-Croatian	8372
Bashkir	6665	Finnish	7073	Japanese	7465	Mongolian	7778	Shona	8378
Basque	6985	French	7082	Kannada	7578	Nauru	7865	Sindhi	8368
Bengali; Bangla	6678	Frisian	7089	Kashmiri	7583	Nepali	7869	Singhalese	8373
Bhutani	6890	Galician	7176	Kazakh	7575	Norwegian	7879	Slovak	8375
Bihari	6672	Georgian	7565	Kirghiz	7589	Oriya	7982	Slovenian	8376
Breton	6682	German	6869	Korean	7579	Panjabi	8065	Spanish	6983
Bulgarian	6671	Greek	6976	Kurdish	7585	Pashto, Pushto	8083	Sudanese	8385
Burmese	7789	Greenlandic	7576	Laotian	7679	Persian	7065	Swahili	8387
Byelorussian	6669	Guarani	7178	Latin	7665	Polish	8076	Swedish	8386
Chinese	9072	Gujarati	7185	Latvian, Lettish	7686	Portuguese	8084	Tagalog	8476
								Tajik	8471
								Tamil	8465
								Telugu	8469
								Thai	8472
								Tonga	8479
								Turkish	8482
								Turkmen	8475
								Twi	8487
								Ukrainian	8575
								Urdu	8582
								Uzbek	8590
								Vietnamese	8673
								Volapük	8679
								Welsh	6789
								Wolof	8779
								Xhosa	8872
								Yiddish	7473
								Yoruba	8979
								Zulu	9085

## Area Codes

Choose an area code from this list.

Area	Code	Area	Code	Area	Code	Area	Code	Area	Code
Afghanistan	AF	Costa Rica	CR	Greenland	GL	Maldives	MV	Paraguay	PY
Argentina	AR	Croatia	HR	Hong Kong	HK	Mexico	MX	Philippines	PH
Australia	AU	Czech Republic	CZ	Hungary	HU	Monaco	MC	Poland	PL
Austria	AT	Denmark	DK	India	IN	Mongolia	MN	Portugal	PT
Belgium	BE	Ecuador	EC	Indonesia	ID	Morocco	MA	Romania	RO
Bhutan	BT	Egypt	EG	Israel	IL	Nepal	NP	Russian Federation	RU
Bolivia	BO	El Salvador	SV	Italy	IT	Netherlands	NL	Saudi Arabia	SA
Brazil	BR	Ethiopia	ET	Jamaica	JM	Netherlands Antilles	AN	Senegal	SN
Cambodia	KH	Fiji	FJ	Japan	JP	New Zealand	NZ	Singapore	SG
Canada	CA	Finland	FI	Kenya	KE	Nigeria	NG	Slovak Republic	SK
Chile	CL	France	FR	Kuwait	KW	Norway	NO	Slovenia	SI
China	CN	Germany	DE	Libya	LY	Oman	OM	South Africa	ZA
Colombia	CO	Great Britain	GB	Luxembourg	LU	Pakistan	PK	South Korea	KR
Congo	CG	Greece	GR	Malaysia	MY	Panama	PA	Spain	ES
								Sri Lanka	LK
								Sweden	SE
								Switzerland	CH
								Taiwan	TW
								Thailand	TH
								Turkey	TR
								Uganda	UG
								Ukraine	UA
								United States	US
								Uruguay	UY
								Uzbekistan	UZ
								Vietnam	VN
								Zimbabwe	ZW

## Troubleshooting

Symptom	Possible Cause	Correction
No power.	<ul style="list-style-type: none"> <li>The power cord is disconnected.</li> </ul>	<ul style="list-style-type: none"> <li>Plug the power cord into the wall outlet securely.</li> </ul>
The power is on, but the player does not work.	<ul style="list-style-type: none"> <li>No disc is inserted.</li> </ul>	<ul style="list-style-type: none"> <li>Insert a disc. (Check the disc indicator in the display window is lit.)</li> </ul>
No picture.	<ul style="list-style-type: none"> <li>The TV is not set to receive DVD signal output.</li> </ul>	<ul style="list-style-type: none"> <li>Select the appropriate video input mode on the TV.</li> </ul>
	<ul style="list-style-type: none"> <li>The video cable is not connected securely.</li> </ul>	<ul style="list-style-type: none"> <li>Connect the video cable securely.</li> </ul>
	<ul style="list-style-type: none"> <li>The selected resolution is not capable with your TV.</li> </ul>	<ul style="list-style-type: none"> <li>Select another resolution using RESOLUTION button.</li> </ul>
No sound.	<ul style="list-style-type: none"> <li>The equipment connected with the audio cable is not set to receive disc signal output.</li> </ul>	<ul style="list-style-type: none"> <li>Select the correct input mode of the audio receiver so you can listen to the sound from the player.</li> </ul>
	<ul style="list-style-type: none"> <li>The power of the equipment connected with the audio cable is turned off.</li> </ul>	<ul style="list-style-type: none"> <li>Turn on the equipment connected with the audio cable.</li> </ul>
	<ul style="list-style-type: none"> <li>The [AUDIO] options are set to the wrong position.</li> </ul>	<ul style="list-style-type: none"> <li>Set the [AUDIO] options to the correct position (see page 23-24).</li> </ul>
	<ul style="list-style-type: none"> <li>The player is in reverse play, fast forward, slow motion or pause mode.</li> </ul>	<ul style="list-style-type: none"> <li>Return to the normal playback.</li> </ul>
The player does not start playback.	<ul style="list-style-type: none"> <li>The disc is upside down.</li> </ul>	<ul style="list-style-type: none"> <li>Insert the disc with the playback side down.</li> </ul>
	<ul style="list-style-type: none"> <li>An unplayable disc is inserted.</li> </ul>	<ul style="list-style-type: none"> <li>Insert a playable disc. (Check the disc type and regional code.)</li> </ul>
	<ul style="list-style-type: none"> <li>The rating level is set.</li> </ul>	<ul style="list-style-type: none"> <li>Change the rating level.</li> </ul>
	<ul style="list-style-type: none"> <li>The disc was recorded on another unit and was not finalized.</li> </ul>	<ul style="list-style-type: none"> <li>Finalize the disc on that unit.</li> </ul>
The Remote Control does not work properly.	<ul style="list-style-type: none"> <li>The Remote Control is not pointed at the remote sensor on the player.</li> </ul>	<ul style="list-style-type: none"> <li>Point the Remote Control at the remote sensor of the player.</li> </ul>
	<ul style="list-style-type: none"> <li>The Remote Control is too far from the player.</li> </ul>	<ul style="list-style-type: none"> <li>Operate the Remote Control closer to the player.</li> </ul>

## Troubleshooting

Symptom	Possible Cause	Correction
BD-Live feature does not work.	<ul style="list-style-type: none"> <li>External USB device is not connected.</li> </ul>	<ul style="list-style-type: none"> <li>Connect a FAT16 or FAT32 formatted USB device to the USB port (see page 20).</li> </ul>
	<ul style="list-style-type: none"> <li>The connected USB device does not have enough space.</li> </ul>	<ul style="list-style-type: none"> <li>Secure at least 1GB free space in the USB device for using BD-Live features.</li> </ul>
	<ul style="list-style-type: none"> <li>Internet connection is not established.</li> </ul>	<ul style="list-style-type: none"> <li>Ensure that the unit is correctly connected to the local area network and can access the internet (see page 18-19).</li> </ul>
	<ul style="list-style-type: none"> <li>The [BD-LIVE connection] option in the [Setup] menu is set to [Prohibited].</li> </ul>	<ul style="list-style-type: none"> <li>Set the [BD-LIVE connection] option to [Permitted].</li> </ul>
The YouTube video playback is often buffering.	<ul style="list-style-type: none"> <li>Your broadband speed is not fast enough to play YouTube videos.</li> </ul>	<ul style="list-style-type: none"> <li>Contact your Internet Service Provider (ISP) and increase the broadband speed is recommended.</li> </ul>
The YouTube ID is not automatically stored in the ID list.	<ul style="list-style-type: none"> <li>The ID list is full.</li> </ul>	<ul style="list-style-type: none"> <li>Delete one of the stored IDs and SignIn with the ID again.</li> </ul>
Radio stations cannot be tuned in.	<ul style="list-style-type: none"> <li>The signal strength of the stations is too weak (when tuning in with automatic tuning).</li> </ul>	<ul style="list-style-type: none"> <li>Use direct tuning.</li> </ul>

### Customer Support

You can update the Player using the latest software to enhance the products operation and/or add new features.

To obtain the latest software for this player (if updates have been made), please visit <http://lgservice.com> or contact LG Electronics customer care centre.

- Design and specifications are subject to change without notice.

### Resetting the unit

**If you observe any of the following symptoms.**

- The unit is plugged in, but the power will not turn on or off.
- The front panel display is not working.
- The unit is not operating normally.

**You can reset the unit as follows.**

- Press and hold the POWER button for at least five seconds. This will force the player to power off. Press the POWER button again to turn the player back on.
- Unplug the power cord, wait at least five seconds, and then plug it in again.



## Specifications

### General

<b>Power requirements:</b>	AC 200 - 240 V, 50/60 Hz
<b>Power consumption:</b>	130 W
<b>Dimensions (W x H x D):</b>	Approx. 430 x 76 x 379 mm without foot
<b>Net Weight (Approx.):</b>	4.8 kg
<b>Operating temperature:</b>	41 °F to 95 °F (5 °C to 35 °C)
<b>Operating humidity:</b>	5 % to 90 %

### Inputs/Outputs

<b>VIDEO OUT:</b>	1.0 V (p-p), 75 Ω, sync negative, RCA jack x 1
<b>COMPONENT VIDEO OUT:</b>	(Y) 1.0 V (p-p), 75 Ω, sync negative, RCA jack x 1 (Pb)/(Pr) 0.7 V (p-p), 75 Ω, RCA jack x 2
<b>HDMI OUT (video/audio):</b>	19 pin (HDMI standard, Type A)
<b>HDMI IN (video/audio):</b>	19 pin (HDMI standard, Type A)
<b>ANALOG AUDIO IN:</b>	2.0 Vrms (1 kHz, 0 dB), 600 Ω, RCA jack (L, R) x 1
<b>DIGITAL IN (COAXIAL):</b>	0.5 V (p-p), 75 Ω, RCA jack x 1
<b>DIGITAL IN (OPTICAL):</b>	3 V (p-p), Optical jack x 1
<b>PORT. IN:</b>	0.5 Vrms (3.5φ stereo jack)

### Tuner FM

<b>FM Tuning Range:</b>	87.5 - 108.0 MHz
-------------------------	------------------

### Amplifier

<b>Stereo mode:</b>	155 W + 155 W (4Ω at 1 KHz, THD 10%)
<b>Surround mode:</b>	Left+Right: 155 W + 155 W (THD 10%) Center: 155 W Surround: 155 W + 155 W (4Ω at 1 KHz, THD 10%) Subwoofer: 225 W (3Ω at 30 Hz, THD 10%)

## System

<b>Laser:</b>	Semiconductor laser, wavelength: 405nm / 650 nm
<b>Signal system:</b>	Standard PAL/NTSC colour TV system
<b>Frequency response:</b>	20 Hz to 20 kHz (48 kHz, 96 kHz, 192 kHz sampling)
<b>Signal-to-noise ratio:</b>	More than 100 dB (ANALOG OUT connectors only)
<b>Harmonic distortion:</b>	Less than 0.008%
<b>Dynamic range:</b>	More than 95 dB
<b>LAN port:</b>	Ethernet jack x 1, 10BASE-T/100BASE-TX

### Speakers (HB954PA)

	Front speaker	Rear Speaker	Center Speaker	Passive Subwoofer
<b>Type</b>	2 Way 3speaker	1 Way 1 speaker	2 Way 3 speaker	1 Way 1 speaker
<b>Impedance</b>	4Ω	4Ω	4Ω	3Ω
<b>Rated Input Power</b>	155 W	155 W	155 W	225 W
<b>Max. Input power</b>	310 W	310 W	310 W	450 W
<b>Net Dimensions (W x H x D)</b>	290 x 1150 x 290 mm	96 x 240 x 108 mm	350 x 105 x 93 mm	216 x 405 x 360 mm
<b>Net Weight</b>	4.3 kg	0.8 kg	1.5 kg	7.1 kg

## Speakers (HB954SA)

	<b>Front speaker</b>	<b>Rear Speaker</b>	<b>Center Speaker</b>	<b>Passive Subwoofer</b>
<b>Type</b>	1 Way 1 speaker	1 Way 1 speaker	1 Way 1 speaker	1 Way 1 speaker
<b>Impedance</b>	4Ω	4Ω	4Ω	3Ω
<b>Rated Input Power</b>	155 W	155 W	155 W	225 W
<b>Max. Input power</b>	310 W	310 W	310 W	450 W
<b>Net Dimensions (W x H x D)</b>	96 x 240 x 108 mm	96 x 240 x 108 mm	350 x 105 x 93 mm	216 x 405 x 310 mm
<b>Net Weight</b>	0.8 kg	0.8 kg	0.9 kg	5.9 kg

## Accessories

Speaker cable (6), Remote control (1), Battery (1), HDMI cable (1), FM antenna (1), Video cable (1), 3.5 mm stereo miniplug cable (1)

## Open source software notice

The following GPL executables and LGPL libraries used in this product are subject to the GPL2.0/LGPL2.1 License Agreements:

### GPL EXECUTABLES:

Linux kernel 2.6, bash, busybox, dhcpcd, mtd-utils, net-tools, procps, sysutils, tinylogin

### LGPL LIBRARIES:

uClibc, DirectFB, iconv, cairo, blowfish, mpg123

LG Electronics offers to provide source code to you on CD-ROM for a charge covering the cost of performing such distribution, such as the cost of media, shipping and handling upon e-mail request to LG Electronics at: [opensource@lge.com](mailto:opensource@lge.com)

This offer is valid for a period of three(3) years from the date of the distribution of this product by LG Electronics.

You can obtain a copy of the GPL, LGPL licenses from <http://www.gnu.org/licenses/old-licenses/gpl-2.0.html> and <http://www.gnu.org/licenses/old-licenses/lgpl-2.1.html>

This software is based in part on the work of the Independent JPEG Group copyright © 1991-1998, Thomas G. Lane.

This product includes

- Freetype library : Copyright © 2003 The FreeType Project ([www.freetype.org](http://www.freetype.org)).
- libpng library: Copyright © 2004 Glenn Randers-Pehrson
- Zlib compression library: Copyright © 1995-2002 Jean-loup Gailly and Mark Adler
- Expat library : copyright © 2006 expat maintainers.
- cryptographic software written by Eric Young ([eay@cryptsoft.com](mailto:eay@cryptsoft.com)).
- software written by Tim Hudson ([tjh@cryptsoft.com](mailto:tjh@cryptsoft.com)).
- software developed by the OpenSSL Project for use in the OpenSSL Toolkit. (<http://www.openssl.org>)

This product includes other open source software.

- Copyright © 1998 by the Massachusetts Institute of Technology.
  - Copyright © 2003 Simtec Electronics
  - Copyright © 2001 by First Peer, Inc. All rights reserved.
  - Copyright © 2001 by Eric Kidd. All rights reserved.
  - Copyright © 1996 - 2008, Daniel Stenberg, <[daniel@haxx.se](mailto:daniel@haxx.se)>.
  - Copyright © David L. Mills 1992-2006
  - Copyright © 1998-2003 Daniel Veillard.
  - Copyright © 1998, 1999, 2000 Thai Open Source Software Center Ltd.
  - Copyright © 1991, 1992, 1993, 1994 by Stichting Mathematisch Centrum, Amsterdam, The Netherlands.
  - Copyright © 1990 The Regents of the University of California.
  - Copyright © 1998-2005 The OpenSSL Project.
- All rights reserved.

Permission is hereby granted, free of charge, to any person obtaining a copy of this software and associated documentation files (the "Software"), to deal in the Software without restriction, including without limitation the rights to use, copy, modify, merge, publish, distribute, sublicense, and/or sell copies of the Software, and to permit persons to whom the Software is furnished to do so, subject to the following conditions:

THE SOFTWARE IS PROVIDED "AS IS", WITHOUT WARRANTY OF ANY KIND, EXPRESS OR IMPLIED, INCLUDING BUT NOT LIMITED TO THE WARRANTIES OF MERCHANTABILITY, FITNESS FOR A PARTICULAR PURPOSE AND NONINFRINGEMENT. IN NO EVENT SHALL THE AUTHORS OR COPYRIGHT HOLDERS BE LIABLE FOR ANY CLAIM, DAMAGES OR OTHER LIABILITY, WHETHER IN AN ACTION OF CONTRACT, TORT OR OTHERWISE, ARISING FROM, OUT OF OR IN CONNECTION WITH THE SOFTWARE OR THE USE OR OTHER DEALINGS IN THE SOFTWARE.

