



---

NO.12 Ying Bin Road,Hai Ling District,Tai Zhou,Jiang Su,China  
<http://www.lg.com>



## **FRIDGE-FREEZER**

### **User's Guide**

Please read this User's Guide carefully before operating and keep it handy for reference at all times.

## **FRIGORIFICO- CONGELADOR**

### **Instrucciones de uso**

Lea estas instrucciones de uso con atención antes de poner el aparato en funcionamiento y manténgalo siempre a mano para que pueda consultarlo en cualquier momento.

## **FRIGORIFICO- CONGELADOR**

### **Instruções de uso**

Leia estas instruções de uso com atenção antes de pôr o aparelho a funcionar e mantenha-as sempre à mão para que possam ser consultadas a qualquer hora.

[Lea detenidamente el contenido de esta tarjeta de Garantía](#)

# Table of Contents

<b>Introduction</b>	Registration	4
	Important Safety Instruction	4
	Identification of Parts	16
<b>Installation</b>	Installation	17
	Starting	17
<b>Operation</b>	Temperature Control	18
	• Refrigerator	18
	• Freezer	18
	Function	19
	• Super Freezer	19
	• Vacation	19
	• Memory Feature	20
	• Self Test	20
	Ice Making	20
	Defrosting	20
<b>Suggestion On Food storage</b>	Storing Food	21
<b>Care and Maintenance</b>	General Information	22
	Lamp Replacement	22
	Cleaning	23
<b>Trouble Shooting</b>	Trouble Shooting	24
<b>To Reverse the Doors</b>	Precaution	26
	How to Reverse the Door	26

**Introduction****Registration**

The model and serial number are found on the rear of this unit. This number is unique to this unit and not available to others. You should record requested information here and retain this guide as a permanent record of your purchase. Staple your receipt here.

Date of Purchase : \_\_\_\_\_

Dealer Purchased From : \_\_\_\_\_

Dealer Address : \_\_\_\_\_

Dealer Phone No. : \_\_\_\_\_

Model No. : \_\_\_\_\_

Serial No. : \_\_\_\_\_

**Important Safety Instruction****BASIC SAFETY PRECAUTIONS**

This guide contains many important safety messages. Always read and obey all safety messages.

**▲** This is the safety alert symbol. It alerts you to safety messages that inform you of hazards that can kill or hurt you or others or cause damage to the product. All safety messages will be preceded by the safety alert symbol and the hazard signal word DANGER, WARNING, or CAUTION. These words mean:

**▲ DANGER** You will be killed or seriously injured if you don't follow instructions.

**▲ WARNING** You can be killed or seriously injured if you don't follow instructions.

**▲ CAUTION** Indicates an imminently hazardous situation which, if not avoided, may result in minor or moderate injury, or product damage only.

All safety messages will identify the hazard, tell you how to reduce the chance of injury, and tell you what can happen if the instructions are not followed.



# Important Safety Instruction

## ⚠ WARNING

To reduce the risk of fire, electric shock, or injury to persons when using your product, basic safety precautions should be followed, including the following. Read all instructions before using this appliance.

### 1. When connecting the power

#### The dedicated outlet should be used.

- Using several devices at one outlet may cause fire.
- The electric leakage breaker may damage food and the dispenser may be leaked.



#### Do not allow the power plug to face upward or to be squeezed at the back of the fridge-freezer.

Water may be flown into or the plug may be damaged, which causes fire or electric shock.

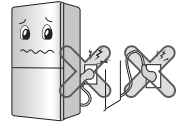

#### Do not allow the power cord bent or pressed by the heavy object to be damaged.

It may damage the power cord to cause fire or electric shock.



#### Do not extend or modify the length of the power plug.

It causes electric shock or fire by the electric damage of the power cord or others.



#### Unplug the power plug when cleaning, handling or replacing the interior lamp of the fridge-freezer.

- It may cause electric shock or injury.
- When replacing the interior lamp of the fridge-freezer, make sure that the rubber ring for preventing the electric spark within the socket is not taken off.



# Important Safety Instruction

**Do not pull out the cord or touch the power plug with wet hands.**

- It may cause electric shock or injury.



**Remove water or dust from the power plug and insert it with the ends of the pins securely connected.**

Dust, water or unstable connection may fire or electric shock.

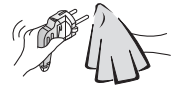

**Make sure of grounding.**

The incorrect grounding may cause breakdown and electric shock.

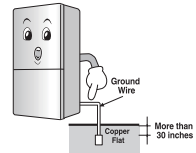

**When the power cord or the power plug is damaged or the holes of the outlet are loosed, do not use them.**

It may cause electric shock or short circuit to make fire.

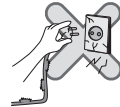

## 2. When using the fridge-freezer

**Do not place the heavy object or the dangerous object (container with liquid) on the fridge-freezer.**

It may be dropped to cause injury, fire or electric shock when opening or closing the door.



**Do not cling to the door or the shelves of the door or the home bar of the freezer or the cool chamber.**

It may make the fridge-freezer fallen down or damage the hands. Especially, do not allow the children to do the above.



## Important Safety Instruction

**Do not install the fridge-freezer in the wet place or the place which water or rain splashes.**

Deterioration of insulation of electric parts may cause electric leakage.



**Do not use or store inflammable materials ether, benzene, alcohol, medicine, LP gas, spray or cosmetics near or in the fridge-freezer.**

It may cause explosion or fire.

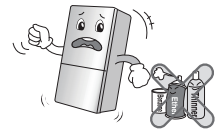

**Do not place the lit candle within the fridge-freezer to deodorize.**

It may cause explosion or fire.



**Do not store the medicine or the academic materials at the fridge-freezer.**

When the material with the strict temperature control is stored, it may be deteriorated or it may make an unexpected reaction to cause any risk.



**Do not use the combustibile spray near the fridge-freezer.**

It may cause fire.



## Important Safety Instruction

### Avoid the heating devices.

It may cause fire.

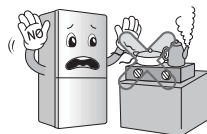

### Do not place flower vase, cup, cosmetics, medicine or any container with water on the fridge-freezer.

It may cause fire, electric shock or injury by dropping down.

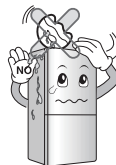

### Use the submerged fridge-freezer after checking it.

It may cause electric shock or fire.

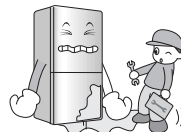

### When gas is leaked, do not touch the fridge-freezer or the outlet and ventilate the room immediately.

- The explosion by spark may cause fire or burn.
- Because this fridge-freezer uses natural gas (isobutene, R600a) as the environment-friendly refrigerant, even a small amount (80~90g) is combustible. When the gas is leaked by the severe damage during delivering, installing or using the fridge-freezer, any spark may cause fire or burn.

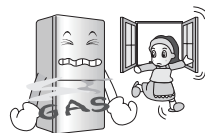

### Do not spray water at the outside or the inside of the fridge-freezer or do not clean it with benzene or thinner.

Deterioration of insulation of electric parts may cause electric shock or fire.



## Important Safety Instruction

**When any strange smell or smoke is detected from the fridge-freezer, disconnect the power plug immediately and contact to the service center.**

It may cause fire.

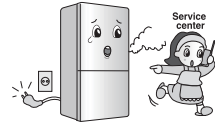

**Do not allow any person except the qualified engineer to disassemble, repair or alter the fridge-freezer.**

It may cause injury, electric shock or fire.

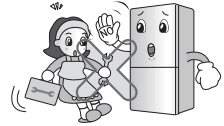

**Do not use the fridge-freezer for non-domestic purpose (storing medicine or testing material, using at the ship, etc.).**

It may cause an unexpected risk such as fire, electric shock, deterioration of stored material or chemical reaction.

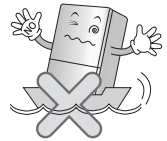

**When disposing the fridge-freezer, remove the packing materials from the door.**

It may cause to lock out the child.



**Install the fridge-freezer on the solid and level floor.**

Installing it on the unstable place may cause death by falling down the fridge-freezer when opening or closing the door.



## Important Safety Instruction

**Do not insert the hands or the metal stick into the exit of cool air, the cover, the bottom of the fridge-freezer, the heatproof grill (exhaust hole) at the backside.**

It may cause electric shock or injury.

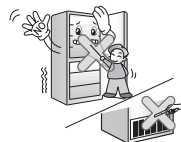

**When you want to dispose the fridge-freezer, contact to the down-block office.**

When you want to dispose the large living waste such as electric home appliance and furniture, you'd better contact the local down-block office.

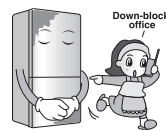

### **⚠ CAUTION**

Violating this direction may cause injury or damage house or furniture. Always be careful, please.

**Do not touch food or containers at the freezer with wet hands.**

It may cause frostbite.



**Wait for 5 minutes or longer when reconnecting the plug.**

It may cause the operation of the freezer to fail.



**Do not put bottle in the freezer.**

It may freeze the contents to break the bottle to cause injury.



**Pull out the power plug not by grasping the cord but the plug of its end.**

It may cause electric shock or short circuit to fire.



## Important Safety Instruction

### Do not install the fridge-freezer in the wet place or the place which water or rain splashes.

Deterioration of insulation of electric parts may cause electric leakage.



### Do not insert the hands into the bottom of the fridge-freezer.

The iron plate of the bottom may cause injury.



### Carry the fridge-freezer with the handle bar at the bottom of the front and the top of the rear.

Otherwise, your hands may be slipped to cause injury.

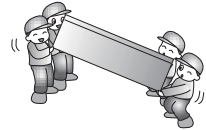

### Because opening or closing the door of the fridge-freezer may cause injury to the person around it, be careful, please.

Opening or closing the door may cause feet or hands to be caught in the chink in door or the child to be get hurt by the corner.

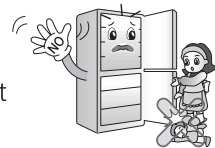

### Do not put any living animal in the fridge-freezer.

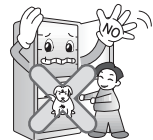

## ⚠ CAUTION

This appliance is not intended for use by persons (including children) with reduced physical, sensory or mental capabilities, or lack of experience and knowledge, unless they have been given supervision or instruction concerning use of the appliance by a person responsible for their safety. Children should be supervised to ensure that they do not play with the appliance.

## Important Safety Instruction

### **⚠ WARNING**

#### **Precaution**

- This fridge-freezer must be properly installed and located in accordance with the Installation Instruction before it is used.
- Never unplug your fridge-freezer by pulling on the power cord. Always grip plug firmly and pull straight out from the outlet.
- When moving your appliance away from the wall, be careful not to roll over or damage the power cord.
- After your fridge-freezer is in operation, do not touch the cold surfaces in the freezer compartment, particularly when hands are damp or wet. Skin may adhere to these extremely cold surfaces.
- Pull out the power plug prior to cleaning the fridge-freezer.  
Never damage, severely bend, pull out, or twist the power cord because power cord damage may cause a fire or electronic shock.  
Never place glass products in the freezer because they may be broken when their inner contents are frozen.
- Do not directly spray water inside or outside the fridge/freezer.  
There is a risk of explosion or fire.
- Do not insert the power plug with wet hands.  
You may receive an electric shock.
- Do not put a container filled with water on top of the appliance.  
If the water spills on to any electrical parts, it may lead to fire or electric shock.
- Do not install the fridge/freezer in a damp place, where it could be splashed with water.  
Incorrect insulation of the electrical parts may cause an electric shock or fire.



## Important Safety Instruction

- **Do not disassemble, repair or alter the appliance.** It may cause fire or abnormal operations, which may lead to injury.
- **Pull the power plug out of the socket before replacing the interior light in the refrigerator.** Otherwise, there is a risk of electric shock.
- **If possible, connect the fridge-freezer to its own individual electrical outlet to prevent it and other appliances or household lights from causing an overload.**

It will cause electric shock or fire.

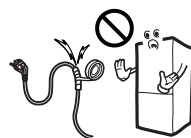

If possible, connect the fridge-freezer to its own individual electrical outlet to prevent it and other appliances or household lights from causing an overload.

The supply plug of the refrigerator-freezer should be placed in easy accessible position for quick disconnection in emergency.

If the supply cord is damaged, it must be replaced by the manufacturer or its service agent or a similarly qualified person in order to avoid a hazard.

**Do not modify or extend the Power Cord length**

**Don't Use on Extension Cord**

**Accessibility of Supply Plug**

**Supply Cord Replacement**

**⚠ DANGER**

Risk of child entrapment.

Before you throw away your old refrigerator or freezer: Take off the doors.

Leave the shelves in place so that children may not easily climb inside.

**Don't store**

**Grounding (Earthing)**

Don't store or use gasoline or other flammable vapors and liquids in the vicinity of this or any other appliance. In the event of an electric short circuit, grounding (earthing) reduces the risk of electric shock by providing an escape wire for the electric current. In order to prevent possible electric shock, this appliance must be grounded. Improper use of the grounding plug can result in an electric shock. Consult a qualified electrician or service person if the grounding instructions are not completely understood, or if you have doubts on whether the appliance is properly grounded.

## Important Safety Instruction

### **⚠ WARNING**

- ⚠ Keep ventilation openings, in the appliance enclosure or in the built-in structure, clear of obstruction.
- ⚠ Do not use mechanical devices or other means to accelerate the defrosting process, other than those recommended by the manufacturer.
- ⚠ Do not damage the refrigerant circuit.
- ⚠ Do not use electrical appliances inside the food storage compartments of the appliance, unless they are of the type recommended by the manufacturer.
- ⚠ The refrigerant and insulation blowing gas used in the appliance require special disposal procedures. When disposal, please consult with service agent or a similarly qualified person.



This appliance contains a small amount of isobutane refrigerant (R600a), natural gas with high environmental compatibility, but it is also combustible. When transporting and installing the appliance, care should be taken to ensure that no parts of the refrigerating circuit are damaged. Refrigerant squirting out of the pipes could ignite or cause an eye injury. If a leak is detected, avoid any naked flames or potential sources of ignition and air the room in which the appliance is standing for several minutes.

In order to avoid the creation of a flammable gas air mixture if a leak in the refrigerating circuit occurs, the size of the room in which the appliance may be sited depends on the amount of refrigerant used. The room must be 1m<sup>2</sup> in size for every 8g of R600a refrigerant inside the appliance. The amount of refrigerant in your particular appliance is shown on the identification plate inside the appliance.

Never start up an appliance showing any signs of damage. If in doubt, consult your dealer.

## Important Safety Instruction

### **⚠ CAUTION**

- If the wall socket is loose, do not insert the power plug.  
It may cause electric shock or fire.
- Never unplug your refrigerator by pulling on the power cord. Always grip plug firmly and pull it straight out from the outlet.  
You may disconnect a wire and cause a short circuit.
- Do not use a wet or damp cloth when cleaning the plug. Remove any foreign matter from the power plug pins.  
Otherwise, there is a risk of fire.
- Do not put your hands into the bottom area of the appliance.  
Any Sharp edges may cause personal injury..
- After unplugging the appliance, wait for at least five minutes before plugging it again to the wall socket.  
Abnormal operation of the freezer may cause material damage.
- If the appliance is not to be used for a long time, pull out the power plug.  
Any deterioration in the insulation may cause fire.
- Do not let children touch or play with the control panel on the front of the appliance.
- The refrigerant used in fridge/freezer and the gases in the insulation material require special disposal procedures. Ensure that none of the pipes on the back of the appliances are damaged prior to disposal.

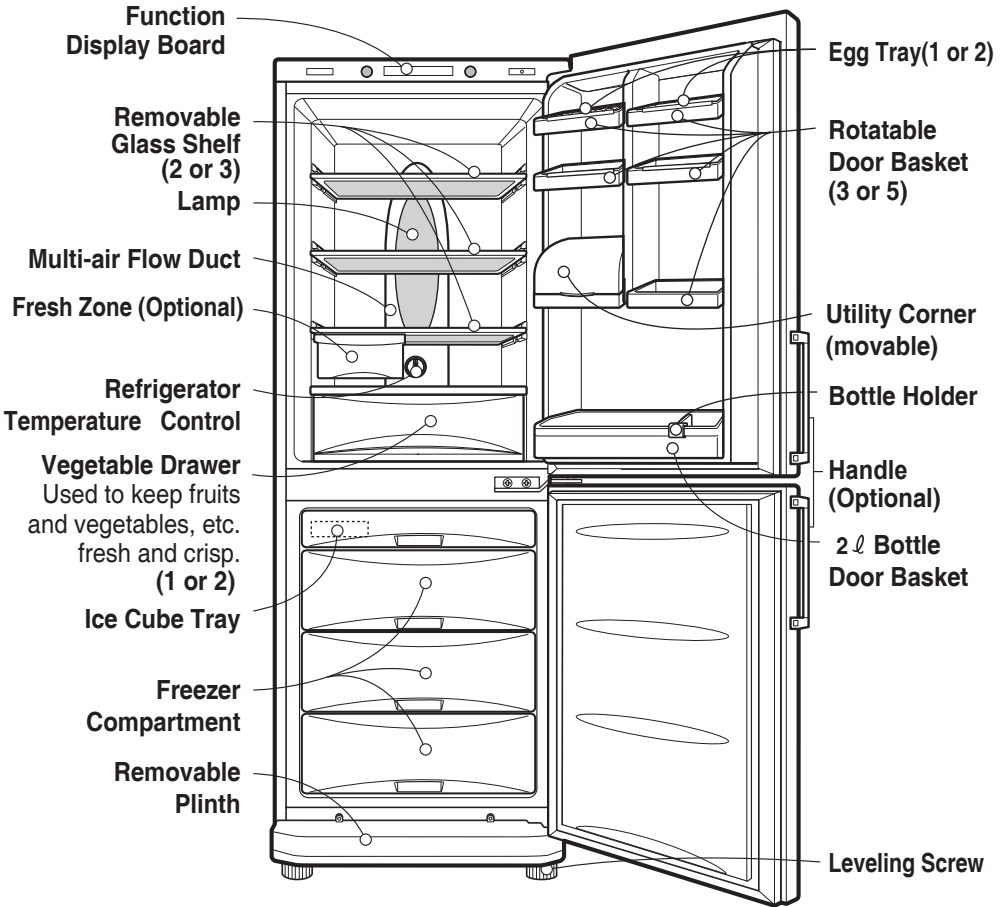

# Identification of Parts



**Note**

If you find some parts missing from your unit, they may be parts only used in other models.

**Installation**

1. Select a good location.  
Place your fridge-freezer where it is easy to use.
2. Avoid placing the unit near heat sources, direct sunlight or moisture.
3. There must be proper air circulation around your fridge-freezer to keep it operating efficiently.
4. To avoid vibration, the unit must be leveled.  
If required, adjust the leveling screws to compensate for the uneven floor.  
The front should be slightly higher than the rear to aid in door closing.  
Leveling screws can be turned easily by tipping the cabinet slightly.  
Turn the leveling screws counterclockwise(  ) to raise the unit, clockwise(  ) to lower it.
5. Clean your fridge-freezer thoroughly and wipe off all dust accumulated during shipping.
6. Install accessories such as ice cube box, etc., in their proper places.They are packed together to prevent possible damage during shipment.
7. Connect the power supply cord (or plug) to the outlet.  
Don't double up with other appliances on the same outlet.
8. To ensure proper air circulation around the fridge - freezer, please maintain sufficient space on both the sides as well as top and maintain at least 2 inches (5 cm) from the rear wall.

**Starting**

When your fridge-freezer is installed, allow it 2-3 hours to stabilize at normal operating temperature prior to filling it with fresh or frozen foods.  
If power plug is disconnected, allow 5 minutes delay before restarting.  
Your fridge-freezer is now ready for use.

## Temperature Control

Your fridge-freezer has two controls that let you regulate the temperature in the fridge and freezer compartments.

### Refrigerator

- Initially set the TEMP. CONTROL at "4". Then adjust the compartment temperature according to your desire.

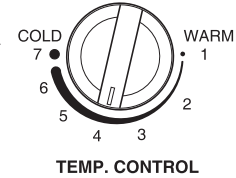

- If you want an inside temperature slightly less cold or colder, turn the knob towards WARM or COLD, respectively. When the surrounding temperature is low, adjust the TEMP. CONTROL 'WARM'.

### Freezer

Display Panel For Temperature Control

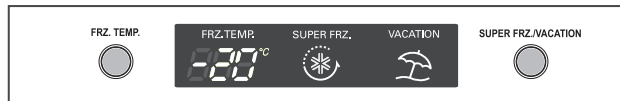

- Freezer temperature control is on the top of the fridge-freezer. You can now adjust the temperature of the compartment as you want.
- When you press the 'FRZ. TEMP.' button, the temperature of freezer compartment is repeated in the following order:  
 $-18^{\circ}\text{C} \rightarrow -19^{\circ}\text{C} \rightarrow -20^{\circ}\text{C} \rightarrow -21^{\circ}\text{C} \rightarrow -22^{\circ}\text{C} \rightarrow -23^{\circ}\text{C}$   
 $\rightarrow -15^{\circ}\text{C} \rightarrow -16^{\circ}\text{C} \rightarrow -17^{\circ}\text{C} \rightarrow -18^{\circ}\text{C}$



#### Note

The actual inner temperature varies depending on the food status, as the indicated setting temperature is a target temperature, not actual temperature within refrigerator.

Refrigeration function is weak in the initial time. Please adjust temperature as above after using refrigerator for minimum 2~3 days.

## Function

### Super Freezer

- This function is used when you want to freeze the foods quickly. Press the 'SUPER FRZ./VACATION' , and then the super freeze operation starts with the 'SUPER FRZ.' display light on.

The super freeze operation takes about 3 hours. When its operation ends, it automatically returns to the normal state. If you want to stop the super freeze operation, press the 'SUPER FRZ./VACATION' button, the display light goes out, the super freeze operation stops and the refrigerator returns to the normal state.



### Vacation

- This function makes the fridge-freezer work in a power saving mode which is useful for when you are away on holiday, by reducing energy consumption as much as possible.

Pressing 'SUPER FRZ./VACATION' button, the vacation operation starts with the 'VACATION' display light on and pressing it twice more, the display light goes out and the vacation operation stops.

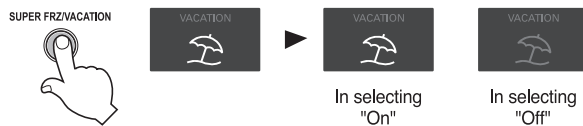

#### Note

Press the 'SUPER FRZ./VACATION' button once the 'VACATION' display light on and the vacation operation starts; Twice the 'VACATION' display light is off, the 'SUPER FRZ.' display light on and the super freeze operation starts; Three times both the display lights go out and both the operation stop.

## Memory feature

Function to save the set temperature and vacation status. When the power is turned on after the power failure, it will be restored with the set temperature and vacation status.

## Self Test

- This function automatically detects failure when failure is found in product during the use of refrigerator.
- If the failure occurs at product and it does not operate by pressing any button and normal indication is not done, do not turn the power off and immediately contact with the local service center.
- A lot of time is needed for service engineer to detect the failed part by turning it off.

## Ice Making

- To make ice cubes, fill the ice tray to the water level and place it in the freezer.
- If ice cubes are required fast, set the 'SUPER FRZ.' state.
- To remove ice cubes, hold the tray at its ends and twist gently.

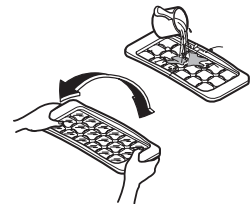

### Tip

To remove ice cubes easily, run water on the tray before twisting.

## Defrosting

Defrosting takes place automatically.

The defrosting water flows down to the evaporating tray and is evaporated automatically.



## Storing Food

### Storing Food

- Do not store food which goes bad easily at low temperature, such as banana, and melon.
- Allow hot food to cool prior to storing. Placing hot food in the fridge-freezer could spoil other food, and lead to higher electric bills.
- When storing the food, use a container with a lid. This prevents moisture from evaporating, and helps food to keep its taste and nutrients.
- Do not block air vents with food. Smooth circulation of cold air keeps fridge-freezer temperature even.
- Do not open the door frequently. Opening the door lets warm air enter the fridge-freezer, and cause temperature to rise.
- To adjust the temperature control easily, do not store food near the temperature control dial.
- Never keep too many foods in door rack, as this may stop the door from fully closing.
- Do not store bottles in the freezer compartment - they may break when frozen.
- Do not refreeze food that has been thawed. This causes loss of taste and nutrition.

#### Note

If you keep the fridge-freezer in a hot, and humid place, frequently open its door or put a lot of vegetables in it, dew may form in it, which has no effect on its performance.

Remove the dew with dust cloth free from care.

## General Information

### Power Failure

- 1~2 hour power failure does no harm to the foods stores. Try to avoid opening and closing the door too frequently.

### If You Move

- Take out foods from the fridge-freezer and firmly fix the loose items with tape.
- Turn the leveling screws until they stop before moving the fridge-freezer. Otherwise the screw may scratch the floor or the fridge-freezer cannot move.

### Anti Condensation Pipe

- The Anti-Condensation pipe is installed around the front side of fridge-freezer as well as on the partition between fridge compartment and freezer compartment to prevent dewing.
- Especially after installation or when ambient temperature is high, the fridge-freezer may feel hot, which is quite normal.

Anti-Condensation Pipe

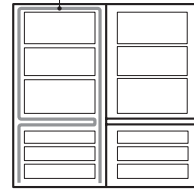

## Lamp Replacement

1. Unplug the power cord from the outlet.
2. Remove fridge shelves.
3. To remove the lamp cover, insert ⊖ type driver in the underside of the lamp cover and pull it out forwards.
4. Turn the lamp counterclockwise.
5. Assemble in reverse order of disassembly.

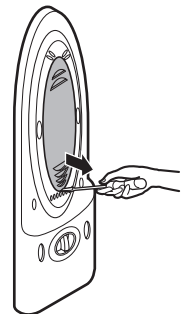

Replacement lamp must be the same specification as original.

- You must check the O-RING, which is made by rubber and prevent electric spark.

## Cleaning

### Before Cleaning

Be sure to unplug the power.

### Exterior

Clean the outside of the fridge-freezer with a soft cloth soaked with hot water or liquid detergent. If you use a detergent, be sure to wipe it with a clean wet cloth.

### Interior

As above.

### After Cleaning

Check that the power cord is not damaged, power plug has not overheated, and that the power plug is tightly inserted into the outlet.

### **WARNING**

Be sure to dry the appliance with a cloth after washing it with water.

Do not use abrasive, petroleum, benzene, thinner, hydrochloride acid, boiling water, rough brush, etc, as they may damage parts of the fridge-freezer.

## Trouble Shooting

**Before calling for service, check this list.**

**It may save you both time and expense.**

**This list includes common occurrences that are not the result of defective workmanship or materials in this appliance.**

### Problem

### Possible Causes

**Fridge-Freezer does not operate**

- Power plug may be unplugged from the electric outlet.  
Plug it in securely.
- House fuse has blown or circuit breaker has tripped.  
Check and/or replace fuse and reset circuit breaker.
- Power cut.  
Check house lights.

**Fridge or Freezer Compartment Temperature too warm**

- Temperature control not set on proper position.  
Refer to Temperature Control section.
- Appliance is placed close to heat source.
- Warm weather-frequent door openings.
- Door left open for a long time.
- Package holding door open or blocking air duct in freezer compartment.

**Vibration or Rattling or Abnormal Noise**

- The floor on which the fridge-freezer is installed may be uneven or the fridge-freezer may be unstable.  
Make it even by rotating the leveling screw.
- Unnecessary objects placed in the back side of the fridge-freezer.

**Frost or Ice Crystals on frozen Food**

- Door may have been left ajar or package holding door open.
- Too frequent or too long door openings.
- Frost within package is normal.

**Moisture forms on Cabinet Surface**

- This phenomenon is likely to occur in a wet space.  
Wipe it with a dry towel.

## Problem

## Possible Causes

### Moisture collects inside

- Too frequent or too long door openings.
- In humid weather, air carries moisture into fridge when doors are opened.

### Fridge has odor

- Foods with strong odors should be tightly covered or wrapped.
- Check for spoiled food.
- Interior needs cleaning.  
Refer to CLEANING section

### Door not closing properly

- Food package is keeping door open.  
Move packages that keep door from closing.
- Fridge-freezer is not level.  
Adjust the leveling screws.
- The floor on which the fridge-freezer is installed may be uneven or the fridge-freezer may be unstable.  
Slightly raise the front side with the leveling screw.

### Interior light does not work

- No power at outlet.
- Light lamp needs replacing.  
Refer to the Lamp Replacement section

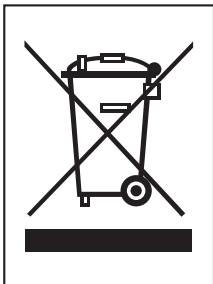

## Disposal of your old appliance

1. When this crossed-out wheeled bin symbol is attached to a product it means the product is covered by the European Directive 2002/96/EC.
2. All electrical and electronic products should be disposed of separately from the municipal waste stream via designated collection facilities appointed by the government or the local authorities.
3. The correct disposal of your old appliance will help prevent potential negative consequences for the environment and human health.
4. For more detailed information about disposal of your old appliance, please contact your city office, waste disposal service or the shop where you purchased the product.

# To Reverse the Doors

Your fridge-freezer is designed with reversible doors, so that they may open from either the left or right hand side to suit your kitchen design.

## Precaution

1. Before reversing the door, first of all, you should take out food and accessories like shelves or trays which are not fixed in the fridge-freezer.
2. Use Torque Wrench or Spanner to fix or remove the bolt.
3. Do not lay the fridge-freezer down. This will cause problems.
4. Be careful not to drop the doors in disassembling or assembling.

## How to Reverse the Door

1. To separate the door handle **1** of the left side, separate the door cap **2** and unscrew the screw **3** in counterclockwise direction. Separate the door handle **4** of the freezer in the same order. (You do not need to follow the above procedure for the hidden handle.)
2. After unscrewing the screw **6** of the right hinge cover **5** on the top, separate the bolt **7** fixing the upper right hinge **8**, and carefully separate the refrigerator door **9**. Remove the left cover **19**.
3. Loosen the screw **10** under the refrigerator door **9**, move the door stopper **11** to the left. Move the bush **12** **13** to the left.
4. Use a sharp gimlet or knife to disconnect the cap **13** from the cover front **14**, loosen the screw **15** to remove the cover front **14**. Disconnect the cable **16** and the door switch **17** from the disconnected cover front **14**, swap the position of the disconnected cable **16** and door switch **17** with the cap **18**, mount them, fix them with the screw **15**, and then install the cap **13**.

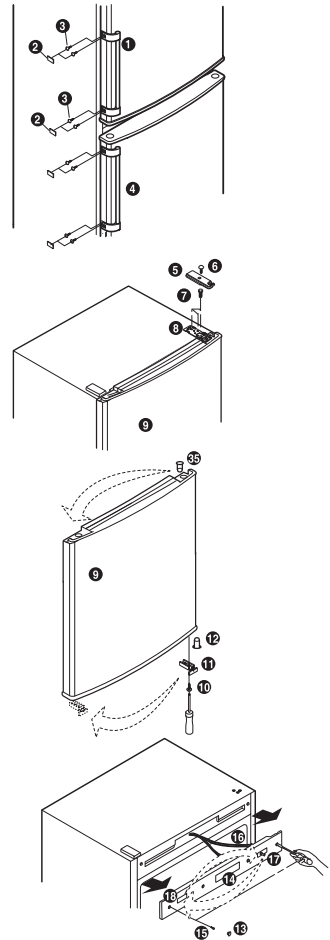

5. Loosen the bolt 20 of the Hinge Middle 21, remove the middle hinge 21, and lift up the freezer door 30 to separate it. Separate the hinge cover 23 and set it on the separated part of middle hinge 21. After unscrewing the screw connected to the bottom cover 25 connect the cover cap 26 on the right side. Loosen the pin 29 in counterclockwise direction and move to the hole on the left side to tighten in clockwise direction. Loosen the bolt 27 connected to the lower hinge 28. Unscrew the screw 32 fixating the door stopper 31 at the bottom of the freezer door 30, and fixate it on the hole on the left side with the door stopper 31. And then, move the upper cap 33 to the right and cover it.

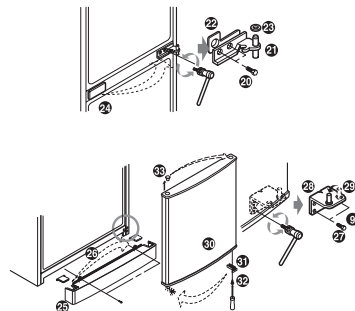

6. Set the separate lower hinge 28 on the bottom hole of the left side of the freezer, and tighten the bolt 27. After fixating the bottom cover 25 at the regular position, align the freezer door 30 on the pin 29 of lower hinge 28 to attach it properly. Turn over the separated middle hinge 21 and sheet hinge 22 to assemble them. Tighten the bolt 20, then set the washer 23 on the middle hinge 21. (When tightening the bolt, be careful not to cause a scratch on the cap decor on top of the freezer door).

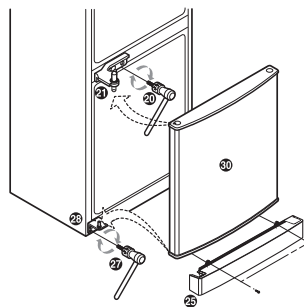

7. After assembling the door by aligning the hinge hole on the bottom of the refrigerator door 9 and the pin of the middle hinge 21, connect properly to the hold of the upper left hinge 37 included in the alternate bag. Tighten the bolt 7 to screw the screws 6 to the left hinge cover 36 included in the alternate bag. Take the right cap 38 out of the alternate bag, then install it on the right side of the refrigerator top.

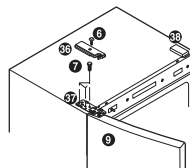

8. Move the separated door handle 1 to the right and fixate the screw 3 on the right position to attach the door cap 2. Move the door cap 38 on the right side to the left and attach it. Attach the freezer door handle 2 in the same method as the refrigerator door handle 1.

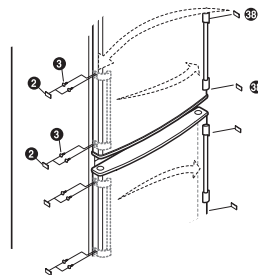

**Note**

Reversing the doors is not covered by the warranty.

