



ENGLISH

DP471BT



P/NO. : MFL47349765



CAUTION: TO REDUCE THE RISK OF ELECTRIC SHOCK. DO NOT REMOVE COVER (OR BACK). NO USER-SERVICEABLE PARTS INSIDE. REFER SERVICING TO QUALIFIED SERVICE PERSONNEL.

 This lightning flash with arrowhead symbol within an equilateral triangle is intended to alert the user to the presence of uninsulated dangerous voltage within the product's enclosure that may be of sufficient magnitude to constitute a risk of electric shock to persons.

 The exclamation point within an equilateral triangle is intended to alert the user to the presence of important operating and maintenance (servicing) instructions in the literature accompanying the product.

WARNING: TO PREVENT FIRE OR ELECTRIC SHOCK HAZARD, DO NOT EXPOSE THIS PRODUCT TO RAIN OR MOISTURE.

WARNING: Do not install this equipment in a confined space such as a book case or similar unit.

CAUTION: Do not block any ventilation openings. Install in accordance with the manufacturer's instructions. Slots and openings in the cabinet are provided for ventilation and to ensure reliable operation of the product and to protect it from over heating. The openings should be never be blocked by placing the product on a bed, sofa, rug or other similar surface. This product should not be placed in a built-in installation such as a bookcase or rack unless proper ventilation is provided or the manufacturer's instruction has been adhered to.

CAUTION: This product employs a Laser System. To ensure proper use of this product, please read this owner's manual carefully and retain it for future reference. Should the unit require maintenance, contact an authorized service center.

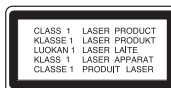

Use of controls, adjustments or the performance of procedures other than those specified herein may result in hazardous radiation exposure.

To prevent direct exposure to laser beam, do not try to open the enclosure. Visible laser radiation when open. DO NOT STARE INTO BEAM.

CAUTION: The apparatus should not be exposed to water (dripping or splashing) and no objects filled with liquids, such as vases, should be placed on the apparatus.

CAUTION

- The ventilation should not be impeded by covering the ventilation openings with items, such as newspapers, table-cloth, curtains etc.
- No naked flame sources, such as lighted candles, should be placed on the apparatus.
- Used batteries should be disposed of safely and not incinerated. Attention should be shown to the environment aspects of battery disposal.
- Use the apparatus in tropical and moderate climates only.

2

- The excessive sound pressure from earphones and headphones can cause hearing loss.
- The battery shall not be exposed to excessive heat such as sunshine, fire or the like.

CAUTION concerning the Power Cord

Most appliances recommend they be placed upon a dedicated circuit;

That is, a single outlet circuit which powers only that appliance and has no additional outlets or branch circuits. Check the specification page of this owner's manual to be certain. Do not overload wall outlets. Overloaded wall outlets, loose or damaged wall outlets, extension cords, frayed power cords, or damaged or cracked wire insulation are dangerous. Any of these conditions could result in electric shock or fire. Periodically examine the cord of your appliance, and if its appearance indicates damage or deterioration, unplug it, discontinue use of the appliance, and have the cord replaced with an exact replacement part by an authorized service center.

Protect the power cord from physical or mechanical abuse, such as being twisted, kinked, pinched, closed in a door, or walked upon. Pay particular attention to plugs, wall outlets, and the point where the cord exits the appliance.

To disconnect power from the mains, pull out the mains cord plug. When installing the product, ensure that the plug is easily accessible.

Warning for replaceable lithium battery

- danger of explosion if battery incorrectly replaced.
- replace only with the same type battery.
- additional warning marking close to the battery if intended to be replaced by users.

Disposal of your old appliance



1. When this crossed-out wheeled bin symbol is attached to a product it means the product is covered by the European Directive 2002/96/EC.
2. All electrical and electronic products should be disposed of separately from the municipal waste stream via designated collection facilities appointed by the government or the local authorities.
3. The correct disposal of your old appliance will help prevent potential negative consequences for the environment and human health.
4. For more detailed information about disposal of your old appliance, please contact your city office, waste disposal service or the shop where you purchased the product.







CE This product is manufactured to comply with EMC Directive 2004/108/EC and Low Voltage Directive 2006/95/EC.

European representative :

LG Electronics Service Europe B.V.
Veluwezoom 15, 1327 AE Almere,
The Netherlands (Tel : +31-036-547-8940)

| | |
|--|-------|
| Types of Playable Discs | 3 |
| Rechargeable battery | 3 |
| Main Unit | 4 |
| Remote Control | 5 |
| Power connections | 6 |
| Hooking up the unit | 7 |
| Revolving the LCD panel | 7 |
| Selecting the operation mode | 7 |
| Adjust the settings | 8-9 |
| Displaying Disc Information | 9 |
| Playing a Disc | 10-11 |
| Playing a DivX movie file | 11 |
| Listening to Music Disc or files | 12 |
| Viewing photo files | 12 |
| Using an USB Flash Drive | 13 |
| Watching the TV program | 14 |
| Auto Channel Memory | 15 |
| Language Codes | 16 |
| Area Codes | 16 |
| Troubleshooting | 17 |
| Specifications | 17 |
| Enjoying in a car with the Headrest Mounting Bracket | 18 |

Types of Playable Discs

| Type | Logo |
|--|--|
| DVD-VIDEO: Discs such as movies that can be purchased or rented. |  |
| DVD-R: Video mode and finalized only |  |
| DVD-RW: VR mode, Video mode and finalized only |  |
| DVD+R: Video mode only |  |
| DVD+RW: Video mode only |  |
| Audio CD: Music CDs or CD-R/CD-RW in music CD format that can be purchased. |  |

This unit plays DVD±R/RW and CD-R/RW that contains audio titles, DivX, MP3, WMA and/or JPEG files. Some DVD±RW/DVD±R or CD-RW/CD-R cannot be played on this unit due to the recording quality or physical condition of the disc, or the characteristics of the recording device and authoring software.

About the Symbol Display

"" may appear on your TV display during operation and indicates that the function explained in this owner's manual is not available on that disc.

Regional Codes

This unit has a regional code printed on the rear of the unit. This unit can play only DVD discs labeled same as the rear of the unit or "ALL".

- Most DVD discs have a globe with one or more numbers in it clearly visible on the cover. This number must match your unit's regional code or the disc cannot play.
- If you try to play a DVD with a different regional code from your player, the message "Check Regional Code" appears on the TV screen.

Copyrights

It is forbidden by law to copy, broadcast, show, broadcast via cable, play in public, or rent copyrighted material without permission. This product features the copy protection function developed by Macrovision. Copy protection signals are recorded on some discs. When recording and playing the pictures of these discs picture noise will appear. This product incorporates copyright protection technology that is protected by method claims of certain U.S. patents and other intellectual property rights owned by Macrovision Corporation and other rights owners. Use of this copyright protection technology must be authorized by Macrovision Corporation, and is intended for home and other limited viewing uses only unless otherwise authorized by Macrovision Corporation. Reverse engineering or disassembly is prohibited.

Rechargeable battery

- Its internal rechargeable battery provides you with the freedom to pass it around and play the files without the power cord.
- The internal rechargeable battery will start charging only when the unit is turned off and the AC adapter is connected to a power outlet.
- The charging stops if you turn on the unit.
- The charging will take approximately 2 hour 30 minutes.
- Operating time on battery: approximately 2 hour 20 minutes. The operating time on battery may vary depending on the battery status, operational status and environment conditions.
- The battery indicator will turn red while charging. Once the charging is complete, the indicator light changes to green.
- When the remaining time of the battery power is under a few minutes, " or " Check Battery Status" will blink on the screen.

Main Unit

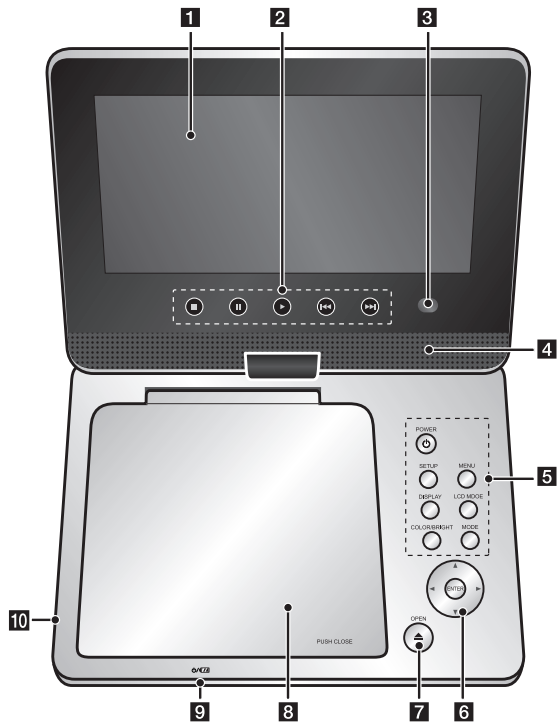

Volume: You can adjust the volume level using the volume controller on the right side.

Earphones: Connect a earphones to the earphones jack on the right side to enjoy the sound individually.

Antenna Input: Refer to page 14-15.

AV OUT: Refer to page 7.

4

1 LCD screen

2 Playback Control Buttons

- **(Stop):** Stops playback.
- || **(PAUSE/STEP):** Pauses playback temporarily/ press repeatedly for frame-by-frame playback.
- ▶ **(Play):** Starts playback.
- ◀◀ **(Skip):** Search backward* or returns to the beginning of current chapter or track or go to the previous chapter or track.
- ▶▶ **(Skip):** Search forward* or Go to next chapter or track.

* Press and hold button for about two seconds.

3 Remote sensor: Point the remote control here. To control the unit using the remote control, do not fold the LCD panel down.

4 Speakers

5 Function Buttons

- POWER** (⏻): Turn the unit ON or OFF.
- SETUP:** Accesses or exits the setup menu.
- MENU:** Accesses the DVD menu.
- DISPLAY:** Accesses On-Screen Display.
- LCD MODE:** Selects the LCD mode. (16:9, 4:3 or Off)
- COLOR/BRIGHT*:** Displays the Brightness or Color menu for LCD display.
- MODE:** Selects a operation mode between [DISC], [TV] and [USB].

* To adjust the color or brightness of the LCD display, press COLOR/BRIGHT repeatedly on the main unit to display the Brightness or Color menu then use ◀ / ▶ to adjust the value. Press ENTER to confirm the adjustment.

6 Menu Control Buttons

- ◀ ▶ ▲ ▼ **(left/right/up/down):** Selects an item in the menu.
- ENTER:** Confirms menu selection.

7 OPEN (⏏): Opens the disc lid.

8 Disc Lid

9 Battery charge and power indicator

- The indicator turns red in charging and changes to green color when the charging is complete. (Refer to page 3 for details.)
- The indicator turns green for a few seconds when the unit is turned on.

10 USB Port: Connect an USB Flash Drive.

Remote Control

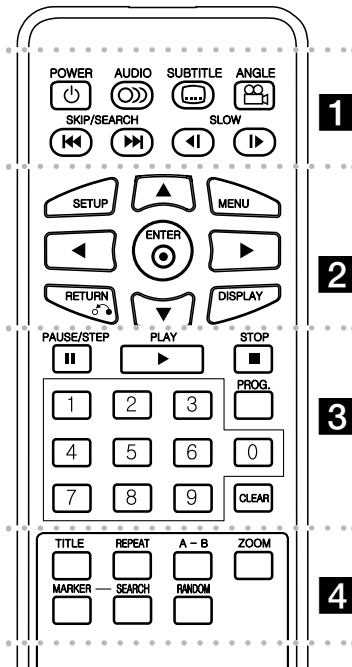

- 1
- POWER** (⏻): Switches the unit ON or OFF.
 - AUDIO** (🔊): Selects an audio language or audio channel.
 - SUBTITLE** (📄): Selects a subtitle language.
 - ANGLE** (📷): Selects a DVD camera angle, if available.

SKIP/SEARCH (⏮ / ⏭): Search* backward / forward. Go to next or previous chapter/track.
* Press and hold button for about two seconds.

SLOW (⏪ / ⏩): Reverse/ Forward slow playback.

..... 2

SETUP: Accesses or exits the setup menu.

MENU: Accesses the DVD menu.

▲▼◀▶: Navigates the menus.

ENTER (⊙): Confirms menu selection.

RETURN (↶): Press to move backwards in the menu or exit the menu.

DISPLAY: Accesses On-Screen Display.

..... 3

PAUSE/STEP (⏸): Pauses playback temporarily/ press repeatedly for frame-by-frame playback.

PLAY (▶): Starts playback.

STOP (■): Stops playback.

Numerical buttons: Selects numbered options in a menu.

PROG.: Enters the program edit mode.

CLEAR: Removes a track number on the Program List.

..... 4

TITLE: Access the disc's title menu.

REPEAT: Repeats a chapter, track, title or all.

A-B: Repeats a section.

ZOOM: Enlarges video image.

MARKER: Marks any point during playback.

SEARCH: Displays [Marker Search] menu.

RANDOM: Plays tracks in random order.

Put the battery into the Remote Control

Pinch the battery holder clip together then pull the tab to remove the battery holder. Insert the battery with the + facing in the same direction as the + on the battery holder. Replace the battery holder with battery into the Remote Control unit making sure that it is fully inserted.

- Replace Remote Control unit battery with 3V micro lithium cells such as CR. 2025 or its equivalent.
- Dispose of battery safely in accordance with local laws. Do not dispose of in fire.

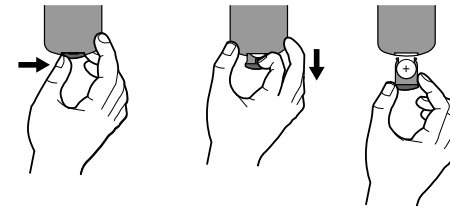

Warning: The battery used in this device may present a fire or chemical burn hazard if mis-treated. Do not recharge, disassemble, incinerate, or heat above 100 °C (212 °F). Replace the battery with Matsushita Elec. Ind. Co., Ltd. (Panasonic), part no. CR. 2025 only. Use of another battery may present a risk of fire or explosion. Dispose of used batteries. Keep batteries away from children. Do not disassemble or dispose of in fire.

5

Power connections

Connecting the Power Cable

Connect the supplied power cable from the unit to a power socket.

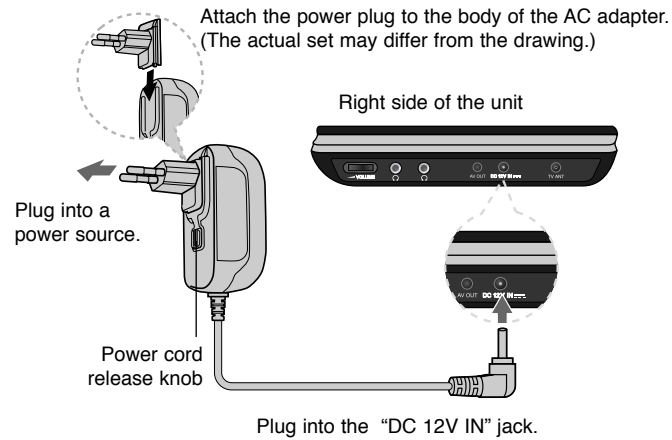

AC adapter

- This AC adapter operates on 100-240V~ 1A 50/60Hz.
- Contact an electrical parts distributor for assistance in selecting a suitable AC plug adapter or AC cord set.
- Manufactured by NANJING WANLIDA TECHNOLOGY CO., LTD

Connect the Automotive adapter

This unit and its automotive adapter are designed for use in vehicles that have 8.5-16 volt, negative ground electrical systems. This is standard for most vehicles. If your vehicle has a different type of electrical system, the DC power system cannot be used.

6

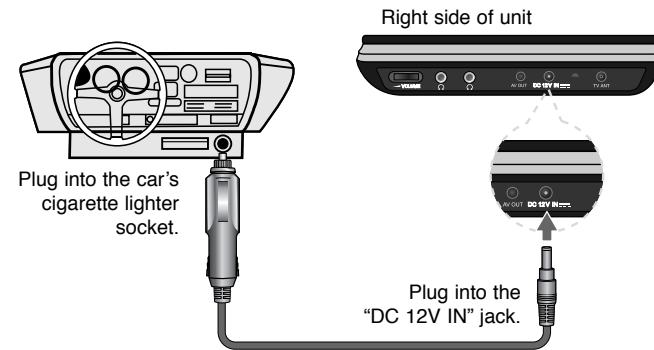

Automotive adapter

- This automotive adapter operates on DC 8.5-16V.
- Contact an electrical parts distributor for assistance in selecting a suitable automotive adapter.
- Manufactured by NANJING WANLIDA TECHNOLOGY CO., LTD.

Caution

- To prevent electrical shock and possible damage to your unit or vehicle, always unplug the automotive adapter from the cigarette lighter socket before you remove the plug from your unit.
- A 3 amp, 250V fuse for protection is installed in the automotive adapter.
- While the engine is being started, disconnect the automotive adapter from the car's cigarette lighter socket.
- Do not operate your unit when the car battery is discharged. Peak current from the car generator may cause the DC fuse to blow.
- If the vehicle's supply voltage drops below approximately 10 volts, your unit may not work properly.
- Do not leave your unit in a place where the temperature exceeds 70°C (158°F), or the pick-up device may be damaged. Examples include:
 - Inside a car with the windows closed and in direct sunshine.
 - Near a heating appliance.

Hooking up the unit

Audio and Video Connection

Connect the AV OUT jack on the unit to the corresponding input jacks on your TV using the supplied AV cable as shown below.

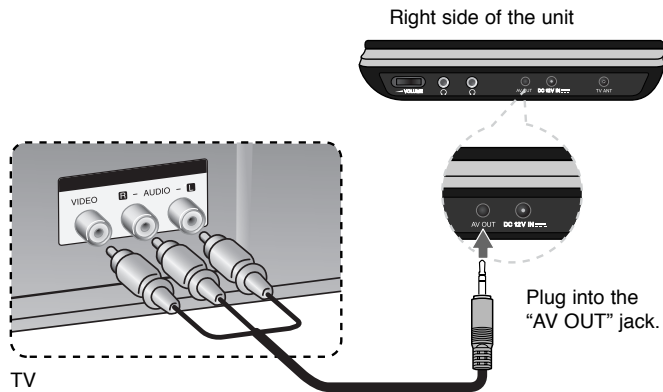

Note: The signal does not come out from AV OUT jack when the unit is set to [TV] mode.

Manufactured under license from Dolby Laboratories. "Dolby" and the double-D symbol are trademarks of Dolby Laboratories.

Revolving the LCD panel

You can revolve the LCD panel of the unit clockwise a maximum of 180 degrees for use. You can also operate the unit after revolving the LCD panel 180 degrees and folding it back down.

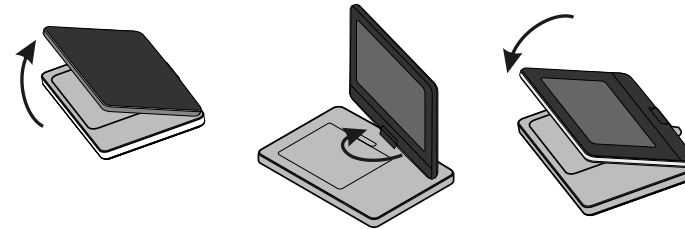

To revolve the LCD panel, place the unit on a stable and even surface such as on a table. Push the LCD panel up and then lift it into a vertical position. Revolve the LCD panel clockwise slowly 180 degrees. If you need, fold the LCD panel after revolving it.

To revolve the LCD panel to its original position, open the LCD panel to a vertical position. Revolve the LCD panel counter clockwise slowly 180 degrees.

- When finished using the unit, return the LCD panel to its original position.
- Do not leave the LCD panel in the face-up position, or sudden shocks may damage it.

Selecting the operation mode



You need to select a operation mode before using this unit. Press **MODE** on the unit and the operation mode selection menu appears. Use ◀ / ▶ to select a mode then press **ENTER**.

- Select [DISC] to playback the inserted disc.
- Select [TV] to view the TV connecting the antenna.
- Select [USB] to playback the file(s) in the connected USB Flash Drive.

Adjust the settings

| | BUTTON |
|--|-------------|
| 1 Display setup menu: | SETUP |
| 2 Select a desired option on the first level: | ▲ ▼ |
| 3 Move to second level: | ▶ |
| 4 Select a desired option on the second level: | ▲ ▼ |
| 5 Move to third level: | ▶ |
| 6 Change the setting: | ▲ ▼ / ENTER |

Adjust the settings - more you can do

When you turn on for the first time

The menu for a language selection will appear when you turn on the unit for the first time. You must select a language to use the unit. Use ▲▼◀▶ to select a language then press **ENTER** and the confirm menu will appear. Use ◀▶ to select [ENTER] then press **ENTER**.

Adjust the language settings

Menu Language – Select a language for the Setup menu and on-screen display.

Disc Audio/Subtitle/Menu – Select a language for the Disc Audio/Subtitle/Menu.

[Original]: Refers to the original language in which the disc was recorded.

[Other]: To select another language, press number buttons then **ENTER** to enter the corresponding 4-digit number according to the language code list. (see page 16) If you make a mistake while entering number, press **CLEAR** to delete numbers then correct it.

[Off] (for Disc Subtitle): Turn off Subtitle.

Adjust the display settings

TV Aspect – Select which screen aspect to use based on the shape of your TV screen.

[4:3]: Select when a standard 4:3 TV is connected.

[16:9]: Select when a 16:9 wide TV is connected.

Display Mode – If you selected 4:3, you'll need to define how you would like widescreen programs and films to be displayed on your TV screen.

[Letterbox]: This displays a widescreen picture with black bands at the top and bottom of the screen.

[Panscan]: This fills the entire 4:3 screen, cropping the picture as necessary.

Adjust the audio settings

DRC (Dynamic Range Control) – Make the sound clear when the volume is turned down (Dolby Digital only). Set to [On] for this effect.

Vocal – Set to [On] only when a multi-channel karaoke DVD is playing. The karaoke channels on the disc mix into normal stereo sound.

Adjust the lock settings

You must set the [Area Code] option to use the lock options. Select [Area Code] option then press ▶. Enter a 4-digit password then press **ENTER**. Enter it again then press **ENTER** to verify. If you make a mistake while entering number, press **CLEAR** then correct it.

If you forget your password you can reset it. First, remove the disc in the unit. Display setup menu then input the 6-digit number "210499" and the password will be cleared.

Rating – Select a rating level. The lower the level, the stricter the rating. Select [Unlock] to deactivate the rating.

Password – Sets or changes the password for lock settings.

[New]: Enter a new 4-digits password using the numerical buttons then press **ENTER**. Enter the password again to confirm.

[Change]: Enter the new password twice after entering the current password.

Area Code – Select a code for a geographic area as the playback rating level. This determines which area's standards are used to rate DVDs controlled by the parental lock. (See page 16)

Adjust the others settings

DivX(R) VOD – We provide you with the DivX® VOD (Video On Demand) registration code that allows you to rent and purchase videos using the DivX® VOD service. For more information, visit www.divx.com/vod.

Press **ENTER** when [Select] icon is highlighted and you can view the registration code of the unit.

All the downloaded videos from DivX® VOD can only be played back on this unit.





Displaying Disc Information

| | BUTTON |
|---|--------------------|
| 1 Press DISPLAY during playback: | DISPLAY |
| 2 Select an item: | ▲ ▼ |
| 3 Adjust the Display menu settings: | ◀ ▶ / ENTER |
| 4 Exit the menu: | DISPLAY |

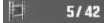

Displaying Disc Information - more you can do

You can select an item by pressing **▲▼** and change or select the setting by pressing **◀▶**.

| | |
|--|--|
|  1 / 6 | Current title (or track) number/total number of titles (or tracks) |
|  5 / 42 | Current chapter number/total number of chapters |
|  0:13:45 | Elapsed playing time |
|  1 ENG 3/2 1CH | Selected audio language or channel |
|  OFF | Selected subtitle |
|  1 / 1 | Selected angle/total number of angles |

Symbol Used in this Manual

A section whose title has one of the following symbols are applicable only to the disc or file represented by the symbol.

| | | | |
|-------------|----------------------------|------------|-----------|
| ALL | All discs and files | ACD | Audio CDs |
| DVD | DVD and finalized DVD±R/RW | MP3 | MP3 files |
| DivX | DivX files | WMA | WMA files |

Playing a Disc

| | BUTTON |
|-----------------------|----------|
| 1 Open the disc lid: | OPEN (▲) |
| 2 Insert a Disc: | - |
| 3 Close the disc lid: | - |
| 4 Start playback: | ▶ PLAY |
| 5 Adjust the volume: | VOLUME |
| 6 To stop playback: | ■ STOP |

Playing a Disc - more you can do

Stops the playback

Press **STOP** (■) to stop playback, the unit records the stopped point depending on the disc. "■■■" appears on the screen briefly. Press **PLAY** (▶) to resume playback (from the scene point). If you press **STOP** (■) again or unload the disc ("■" appears on the screen), the unit will clear the stopped point.

(■■■ =Resume Stop, ■ =Complete Stop)

The resume point may be cleared when a button is pressed. (for example: POWER, OPEN, etc)

Playing a DVD that has a menu **DVD**

Most DVD now have menus which load first before the film begins to play. You can navigate these menus using ▲▼◀▶ or number button to highlight an option. Press **ENTER** to select.

Playing a DVD VR disc

This unit will play DVD-RW disc that is recorded using the Video Recording (VR) format. When you insert a disc DVD VR disc, the menu will appear on the screen. Use ▲▼ to select a title then press **PLAY** (▶). To display DVD-VR menu, press **MENU** or **TITLE**.

Some DVD-VR disc are made with CPRM data by DVD RECORDER. The unit does not support these kinds of discs.

Skip to the next/previous chapter/track/file **ALL**

Press **SKIP** (▶▶) to move to the next chapter/track/file.

Press **SKIP** (◀◀) to return to the beginning of the current chapter/track/file.

Press **SKIP** (◀◀) twice briefly to step back to the previous chapter/track/file.

10

Pause a playback **ALL**

Press **PAUSE/STEP** (||) to pause playback. Press **PLAY** (▶) to continue playback.

Frame-by-Frame playback **DVD DivX**

Press **PAUSE/STEP** (||) repeatedly to play Frame-by-Frame playback.

Playing repeatedly **ALL**

Press **REPEAT** repeatedly to select an item to be repeated. The current title, chapter or track will be played back repeatedly. To return to normal playback, press **REPEAT** repeatedly to select [Off].

Fast forward or fast reverse **DVD DivX ACD WMA MP3**

Press and hold **SKIP** (◀◀ or ▶▶) to play fast forward or fast reverse during playback. You can change the various playback speed by pressing and hold **SKIP** (◀◀ or ▶▶) repeatedly. Press **PLAY** (▶) to continue play at normal speed.

Repeating a specific portion (A-B) **DVD DivX ACD**

Press **A-B** at the beginning of the portion you wish to repeat and again at the end of the portion. Your selected portion will be repeated continually.

To return to normal playback, press **A-B** to select [Off].

Selecting a subtitle language **DVD DivX**

During playback, press **SUBTITLE** (☒) repeatedly to select a desired subtitle language.

Watching from a different angle **DVD**

If the angle indicator appears on the screen for a moment, you can select a different camera angle by pressing **ANGLE** (📷) repeatedly.

Hearing a different audio **DVD DivX**

During playback, press **AUDIO** (🔊) repeatedly to switch between the available audio languages, channels or encoding methods.

Slow down the playing speed **DVD DivX** : Forward only

During playback, press **SLOW** (◀| or |▶) to slow down reverse or forward playback. You can change the various playback speed by pressing **SLOW** (◀| or |▶) repeatedly. Press **PLAY** (▶) to continue play at normal speed.

Watching an enlarged video image **DVD** **DivX**

During playback or pause mode, press **ZOOM** repeatedly to select zoom mode. You can move through the zoomed picture using **▲▼◀▶** buttons. Press **CLEAR** to exit.

Viewing the title menu **DVD**

Press **TITLE** to display the disc's title menu, if available.

Viewing the DVD menu **DVD**

Press **MENU** to display the disc menu, if available.

Starting play from selected time **DVD** **DivX**

Searches for the starting point of entered time code. Press **DISPLAY** then select clock icon. Enter a time then press **ENTER**. For example, to find a scene at 1 hour, 10 minutes, and 20 seconds, enter "11020" and press **ENTER**. If you enter the wrong number, press **CLEAR** to enter again.

Playing in random order **ACD** **WMA** **MP3**

During playback or in stop mode, press **RANDOM** for playback in random order. Press **RANDOM** again to return to normal playback.

Mark a scene on a disc **DVD** **DivX**

You can mark a position on a disc to return to at the place. Simply press **MARKER** at the desired position. The marker icon will appear on-screen briefly. Repeat to place up to nine markers. Also you can recall or clear the positions. Press **SEARCH** and [Marker Search] menu. Use **◀** or **▶** to select a desired marker on the menu, then press **ENTER** to recall it or **CLEAR** to clear it.

Last Scene Memory **DVD** **ACD**

This unit memorizes last scene from the last disc that is viewed. The last scene remains in memory even if you remove the disc from the player or switch off the unit. If you load a disc that has the scene memorized, the scene is automatically recalled.

Screen Saver

The screen saver appears when you leave the unit in Stop mode for about five minutes. If the Screen Saver is displayed for five minutes, the unit automatically turns itself off.

Mixed disc or USB Flash Drive – DivX, MP3/WMA and JPEG

When playing a disc or USB Flash Drive contained with DivX, MP3/WMA and JPEG files together, you can select which menu of files you would like to play by pressing **TITLE**.

Playing a DivX movie file

| | BUTTON |
|--------------------------------------|-----------|
| 1 Open the disc lid: | OPEN (▲) |
| 2 Insert a disc: | - |
| 3 Close the disc lid: | - |
| 4 Select a movie file from the menu: | ▲ ▼, MENU |
| 5 Start playback: | ▶ PLAY |
| 6 To stop playback: | ■ STOP |

Playing a DivX movie file - more you can do

Changing the character set to display DivX® subtitle correctly

Press and hold **SUBTITLE** for 3 seconds during playback. The language code will appear. Press **◀▶** to select another language code until the subtitle is displayed properly and then press **ENTER**.

DivX file requirement

DivX file compatibility with this player is limited as follows:

- Available resolution size: 720x576 (W x H) pixel.
- The file names of DivX and subtitle are limited to 20 characters.
- DivX file extensions: ".avi", ".mpg", ".mpeg"
- Playable DivX subtitle: SubRip (.srt / .txt), SAMI (.smi), SubStation Alpha (.ssa/.txt), MicroDVD (.sub/.txt), VobSub (.sub), SubViewer 2.0 (.sub/.txt), TMPlayer (.txt), DVD Subtitle System (.txt)
- Playable Codec format: "DIVX3.xx", "DIVX4.xx", "DIVX5.xx", "MP43", "3IVX"
- Only the playback function is supported with DivX 6.0 in the unit.
- Playable Audio format: "Dolby Digital", "PCM", "MP3", "WMA"
- Sampling frequency: within 8 - 48 kHz (MP3), within 32 - 48 kHz (WMA)
- Bit rate: within 8 - 320 kbps (MP3), within 32 - 192 kbps (WMA), less than 4Mbps (DivX file)
- CD-R/RW, DVD±R/RW Format: ISO 9660
- Maximum Files/Disc: Less than 650 (total number of files and folders)

Listening to Music Disc or files

| | BUTTON |
|---------------------------------|-----------|
| 1 Open the disc lid: | OPEN (▲) |
| 2 Insert a disc: | - |
| 3 Close the disc lid: | - |
| 4 Select a music from the menu: | ▲ ▼, MENU |
| 5 Start playback: | ▶ PLAY |
| 6 To stop playback: | ■ STOP |

Listening to Music Disc or files - more you can do

Creating your own program

You can play the contents of a disc in the order you want by arranging the order of the musics on the disc. To add a music(s) on the program list, press **PROG.** to enter the program edit mode (Ⓢ mark appears on the menu). Select a desired music on the [List] then press **ENTER** to add the music to the program list. Select a music from the program list then press **ENTER** to start programmed playback. To clear a music from the program list, select the music you want to clear then press **CLEAR** in program edit mode. To clear all music from the program list, select [Clear All] then press **ENTER** in program edit mode. The program is cleared when the disc is removed or the unit is turned off.

Displaying file information (ID3 TAG)

While playing a MP3 file containing file information, you can display the information by pressing **DISPLAY** repeatedly.

MP3/WMA music file requirement

MP3/WMA compatibility with this unit is limited as follows:

- File extensions: “.mp3”, “.wma”
- Sampling frequency: within 8 - 48 kHz (MP3), within 32 - 48kHz (WMA)
- Bit rate: within 8 - 320kbps (MP3), within 32 - 192kbps (WMA)
- CD-R/RW, DVD±R/RW Format: ISO 9660
- Maximum Files/Disc: Less than 650 (total number of files and folders)

12

Viewing photo files

| | BUTTON |
|---|-----------|
| 1 Open the disc lid: | OPEN (▲) |
| 2 Insert a disc: | - |
| 3 Close the disc lid: | - |
| 4 Select a photo file on the menu: | ▲ ▼, MENU |
| 5 Display the selected file in full screen: | ▶ PLAY |
| 6 To return to the menu: | ■ STOP |

Viewing photo files - more you can do

Viewing photo files as a slide show

Use ▲▼◀▶ to highlight (Ⓢ) icon then press **ENTER** to start slide show. You can change slide show speed using ◀▶ when (Ⓢ) icon is highlighted.

Skip to the next/previous photo

Press **SKIP** (◀◀ or ▶▶) to view the previous/next photo.

Rotate a photo

Use ▲▼ to rotate the photo in full screen counter clockwise or clockwise while viewing a photo in full screen.

Pause a slide show

Press **PAUSE/STEP** (||) to pause a slide show. Press **PLAY** (▶) to continue the slide show.

Listening to music during slide show

You can listen to music during slide show, if the disc contain music and photo files together. Use ▲▼◀▶ to highlight (Ⓢ) icon then press **ENTER** to start slide show.

Watching a enlarged photo image

While viewing a photo in full screen, press **ZOOM** repeatedly to select zoom mode. You can move through the zoomed photo using ▲▼◀▶ buttons. Press **CLEAR** to exit.

Photo file requirement

JPEG file compatibility with this unit is limited as follows:

- File extensions: “.jpg”
- Photo size: Less than 2MB recommended
- CD-R/RW, DVD±R/RW Format: ISO 9660
- Maximum Files/Disc: Less than 650 (total number of files and folders)

Using an USB Flash Drive

You can play MP3/WMA/JPEG/DivX files in the USB Flash Drive with version 1.1.

| | BUTTON |
|---|-----------|
| 1 Connect an USB Flash Drive to the USB port on the unit: | - |
| 2 Display the menu to select the USB operation mode: | MODE |
| 3 Select [USB]: | ◀▶, ENTER |
| 4 Select a file or folder: | ▲▼, MENU |
| 5 Play the file or folder: | ▶ PLAY |
| 6 Remove the USB Flash Drive: | - |

Notes an USB Flash Drive

- You can switch among [DISC], [TV] and [USB] mode using **MODE** button.
- Do not extract the USB device in operating.
- We recommend that you back up your important files in the USB Flash Drive to protect against accidental loss.
- If you use a USB extension cable or USB HUB, the USB device might not be recognized.
- Music files (MP3/WMA), photo files (JPEG) and DivX files can be played. For details of operations on each files, refer to relevant pages.
- Maximum Files/USB Flash Drive: Less than 650 (total number of files and folders)
- The USB function of this unit does not support all kinds of USB devices.
- Digital camera and mobile phone are not supported.



Watching the TV program

Antenna Connection

Connect the TV antenna to the TV ANT jack on the unit as below after selecting one of the following patterns **A** and **B**.

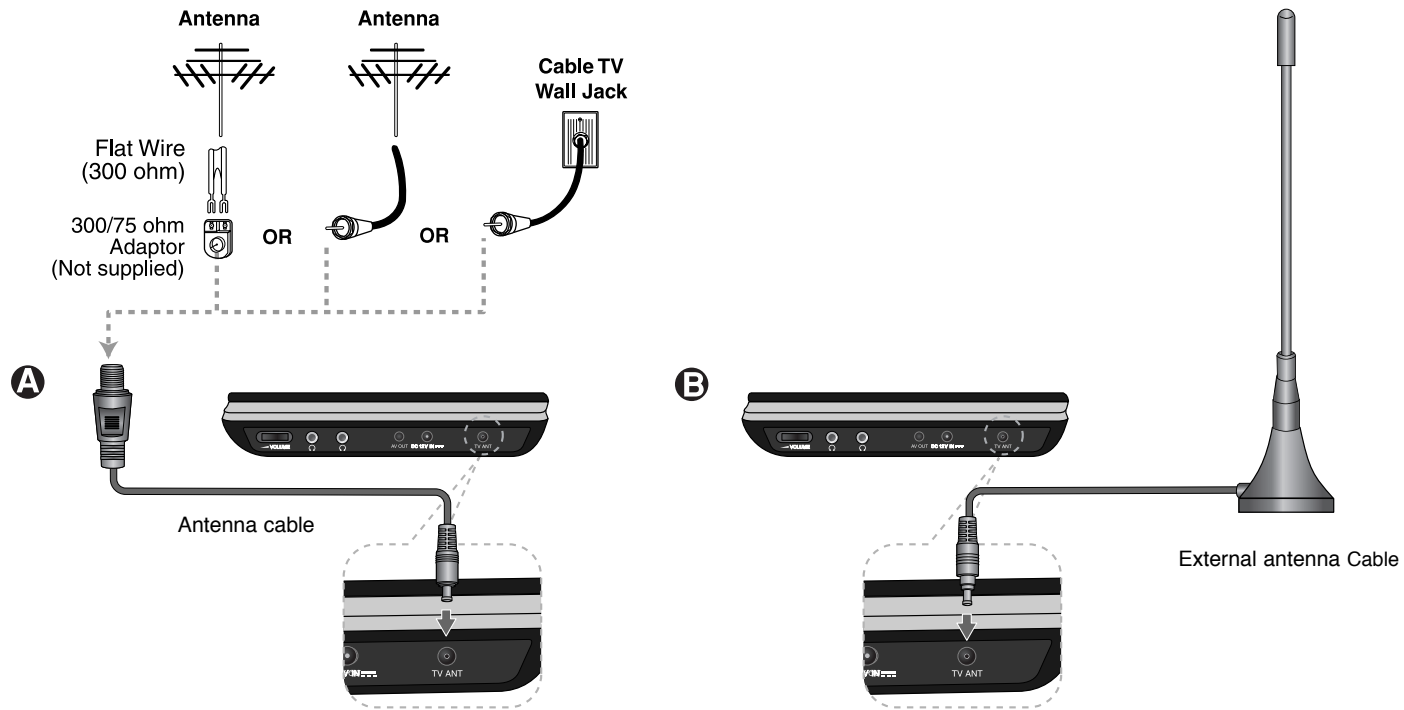

Auto Channel Memory

Automatically finds all channels available and stores all the active channels found.

| | BUTTON |
|---|---------------|
| 1 Connect an antenna: | - |
| 2 Display the menu to select the TV operation mode: | MODE |
| 3 Select [TV]: | ◀ ▶, ENTER |
| 4 Display [TV SETUP] menu: | SETUP |
| 5 Select [CH. SYSTEM] on the [TV SETUP]: - Select a channel system used in your area. (PAL B/G, PAL/I, PAL D/K or SECAM B/G, SECAM D/K) | ▶, ▲ ▼ /ENTER |
| 6 Select [AUTO SCAN] on the [TV SETUP]: - Select [START] and then press ENTER to start auto tuning. | ▶ /ENTER |

Watching the TV program - more you can do

Channel selection

You can select channels as described below.

- Use ▲ /▼ on the remote control to select a channel through the channels in memory.
- Use number (0-9) buttons to select a channel directly.
- Press **RETURN** (↵) to return to the previous channel you viewed.

Manual Channel Edit

You can edit a channel using [CHANNELS] option in the [TV SETUP] menu.

1. Select [TV] mode.
2. Press **SETUP** to display [TV SETUP] menu.

3. Select [CHANNELS] option then press ▶.

4. Use ▲ /▼ to select a menu and use ◀/▶ to select a value of the item to be set.

- [CH. No]: Selects a channel number.
- [Fine]: Selects a frequency to obtain a clear picture.
- [Band]: Selects a channel band. (VHF H, VHF L or UHF)
- [Skip]: Sets the channel to the skipped channel. The channel cannot be selected using the ▲ /▼ button during TV viewing.
- [Manual]: Searches for a channel automatically. Searching stops when the unit tunes in a channel.

Notes on the TV receiving signal

If the TV receiving signal is not poor, it may appear following symptoms.

- Screen: - Shaking
 - Faded in double or triple
 - Field gets bad gradually.
 - Color appears or disappears.
 - Screen is spotted.
 - Stripes appear.
- Sound: - It noises.

It may not receive TV receiving signals as following.

- Between Buildings
- At an airplane or a train passing nearby
- A power cable nearby
- In the mountain or forest
- A automobile, A motorcycle
- A high tension wire

Language Codes

Use this list to input your desired language for the following initial settings: Disc Audio, Disc Subtitle, Disc Menu.

| Language | Code | Language | Code | Language | Code | Language | Code | Language | Code | Language | Code |
|-----------------|------|-------------|------|------------------|------|----------------|------|----------------|------|------------|------|
| Afar | 6565 | Croatian | 7282 | Hausa | 7265 | Lingala | 7678 | Quechua | 8185 | Tajik | 8471 |
| Afrikaans | 6570 | Czech | 6783 | Hebrew | 7387 | Lithuanian | 7684 | Rhaeto-Romance | 8277 | Tamil | 8465 |
| Albanian | 8381 | Danish | 6865 | Hindi | 7273 | Macedonian | 7775 | Rumanian | 8279 | Telugu | 8469 |
| Ameharic | 6577 | Dutch | 7876 | Hungarian | 7285 | Malagasy | 7771 | Russian | 8285 | Thai | 8472 |
| Arabic | 6582 | English | 6978 | Icelandic | 7383 | Malay | 7783 | Samoan | 8377 | Tonga | 8479 |
| Armenian | 7289 | Esperanto | 6979 | Indonesian | 7378 | Malayalam | 7776 | Sanskrit | 8365 | Turkish | 8482 |
| Assamese | 6583 | Estonian | 6984 | Interlingua | 7365 | Maori | 7773 | Scots Gaelic | 7168 | Turkmen | 8475 |
| Aymara | 6588 | Faroese | 7079 | Irish | 7165 | Marathi | 7782 | Serbian | 8382 | Twi | 8487 |
| Azerbaijani | 6590 | Fiji | 7074 | Italian | 7384 | Moldavian | 7779 | Serbo-Croatian | 8372 | Ukrainian | 8575 |
| Bashkir | 6665 | Finnish | 7073 | Japanese | 7465 | Mongolian | 7778 | Shona | 8378 | Urdu | 8582 |
| Basque | 6985 | French | 7082 | Kannada | 7578 | Nauru | 7865 | Sindhi | 8368 | Uzbek | 8590 |
| Bengali, Bangla | 6678 | Frisian | 7089 | Kashmiri | 7583 | Nepali | 7869 | Singhalese | 8373 | Vietnamese | 8673 |
| Bhutani | 6890 | Galician | 7176 | Kazakh | 7575 | Norwegian | 7879 | Slovak | 8375 | Volapük | 8679 |
| Bihari | 6672 | Georgian | 7565 | Kirghiz | 7589 | Oriya | 7982 | Slovenian | 8376 | Welsh | 6789 |
| Breton | 6682 | German | 6869 | Korean | 7579 | Panjabi | 8065 | Spanish | 6983 | Wolof | 8779 |
| Bulgarian | 6671 | Greek | 6976 | Kurdish | 7585 | Pashto, Pushto | 8083 | Sudanese | 8385 | Xhosa | 8872 |
| Burmese | 7789 | Greenlandic | 7576 | Laotian | 7679 | Persian | 7065 | Swahili | 8387 | Yiddish | 7473 |
| Byelorussian | 6669 | Guarani | 7178 | Latin | 7665 | Polish | 8076 | Swedish | 8386 | Yoruba | 8979 |
| Chinese | 9072 | Gujarati | 7185 | Latvian, Lettish | 7686 | Portuguese | 8084 | Tagalog | 8476 | Zulu | 9085 |

Area Codes

Choose a area code from this list.

| Area | Code | Area | Code | Area | Code | Area | Code | Area | Code | Area | Code |
|-------------|------|----------------|------|------------|------|----------------------|------|--------------------|------|---------------|------|
| Afghanistan | AF | Costa Rica | CR | Greenland | GL | Maldives | MV | Paraguay | PY | Sri Lanka | LK |
| Argentina | AR | Croatia | HR | Hong Kong | HK | Mexico | MX | Philippines | PH | Sweden | SE |
| Australia | AU | Czech Republic | CZ | Hungary | HU | Monaco | MC | Poland | PL | Switzerland | CH |
| Austria | AT | Denmark | DK | India | IN | Mongolia | MN | Portugal | PT | Taiwan | TW |
| Belgium | BE | Ecuador | EC | Indonesia | ID | Morocco | MA | Romania | RO | Thailand | TH |
| Bhutan | BT | Egypt | EG | Israel | IL | Nepal | NP | Russian Federation | RU | Turkey | TR |
| Bolivia | BO | El Salvador | SV | Italy | IT | Netherlands | NL | Saudi Arabia | SA | Uganda | UG |
| Brazil | BR | Ethiopia | ET | Jamaica | JM | Netherlands Antilles | AN | Senegal | SN | Ukraine | UA |
| Cambodia | KH | Fiji | FJ | Japan | JP | New Zealand | NZ | Singapore | SG | United States | US |
| Canada | CA | Finland | FI | Kenya | KE | Nigeria | NG | Slovak Republic | SK | Uruguay | UY |
| Chile | CL | France | FR | Kuwait | KW | Norway | NO | Slovenia | SI | Uzbekistan | UZ |
| China | CN | Germany | DE | Libya | LY | Oman | OM | South Africa | ZA | Vietnam | VN |
| Colombia | CO | Great Britain | GB | Luxembourg | LU | Pakistan | PK | South Korea | KR | Zimbabwe | ZW |
| Congo | CG | Greece | GR | Malaysia | MY | Panama | PA | Spain | ES | | |

Troubleshooting

| Symptom | Cause | Correction |
|--|--|--|
| No power. | The power cord is disconnected. | Plug the power cord into the wall outlet securely. |
| | The battery is discharged. | Recharge the battery. |
| The power is on, but the unit does not work. | No disc is inserted. | Insert a disc. |
| | The operation mode is not selected correctly. | Use MODE button to select the operation mode. (Page 7) |
| No picture. | The TV is not set to receive the signal from the unit. | Select the appropriate video input mode on the TV. |
| | The video cable is not connected securely. | Connect the video cable securely. |
| | The LCD mode is set to [Off]. | Select a LCD mode other than [Off]. |
| No sound. | The equipment connected with the audio cable is not set to receive the signal from the unit. | Select the correct input mode of the audio amplifier. |
| | The volume is set to minimum. | Use the volume controller to adjust the volume. |
| | The AUDIO options are set to the wrong position. | Set the AUDIO settings to the correct position. |
| The unit does not start playback. | An unplayable disc is inserted. | Insert a playable disc. (Check the disc type and regional code.) |
| | The rating level is set. | Change the rating level. |
| The remote control does not work properly. | The remote control is not pointed at the remote sensor on the unit. | Point the remote control at the remote sensor of the unit. |
| | The remote control is too far from the unit. | Operate the remote control closer to the unit. |

Specifications

General

| | |
|-----------------------|-------------------------------|
| Power requirements | DC 12V |
| Power consumption | 12W |
| External Dimensions | 207 x 39 x 168 mm (W x H x D) |
| Net Weight (Approx.) | 0.85kg |
| Operating temperature | 5 °C to 40 °C |
| Operating humidity | 5 % to 90 % |
| Laser | Semiconductor laser |
| Signal system | PAL |

Connectors

| | |
|---|-----------------------------|
| Audio/Video Output | ø3.5mm mini jack x 1 |
| - Video: 1.0 V (p-p), 75 Ω, sync negative | |
| - Audio: 1.5 Vrms (1 KHz, 0 dB) | |
| Earphone terminal | ø3.5mm stereo mini jack x 2 |
| Antenna Input | 75 ohms (VHF / UHF) |
| Channel coverage | Analog (VHF/ UHF): 1-125 |

Liquid Crystal Display

| | |
|-------------------|--------------------------|
| Panel size | 7 inches wide (diagonal) |
| Projection system | R.G.B. stripe |
| Driving system | TFT active matrix |
| Resolution | 480 x 234 (WQVGA) |

Accessories

- RCA Video/Audio cable
- AC Adapter (MPA-630)
- Automotive Adapter (DPDC1)
- Remote Control
- Battery for Remote Control (Lithium Battery)
- Antenna Cable
- External Antenna Cable
- Carrying Bag
- Headrest Mounting Bracket

Designs and specifications are subject to change without prior notice.

Enjoying in a car with the Headrest Mounting Bracket

You can enjoy video in the back seat attaching the unit to the back of the front seat.

Warnings

- The driver must not operate this unit while the vehicle is moving.
Do not operate this unit where it can be viewed by the driver.
Driver operation or viewing of this unit while the vehicle is moving will cause distraction which may result in serious accident and personal injury or property damage.
- Do not attach or detach while driving, and do not attach in the following locations, otherwise it may result in injury or traffic accidents:
 - anywhere other than the back of the seat
 - in a location that interferes with the driver's view or operation of the car
 - in a location that interferes with the operation of an airbag
 - in a location that interferes with the driving instruments.
- Depending on the type of headrest, you may not be able to attach the bracket.

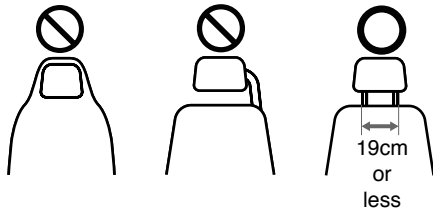

Headrest Mounting Bracket

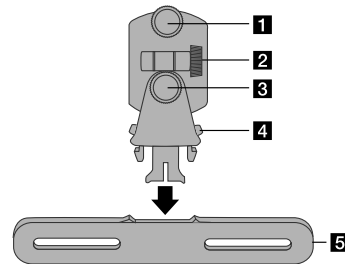

- 1 Fixing Screw**
Fixes the unit on the bracket.
- 2 Tilt Fixing Screw**
Fixes a tilt angle of the bracket.
- 3 Horizontal Fixing Screw**
Fixes a horizontal angle of the bracket.
- 4 Release knob**
Press both knobs to release the bracket body from the cradle.
- 5 Headrest Mounting Cradle**

Installation

- 1** Separate the headrest. (Refer to your car's user guide.)
- 2** Install the headrest mount cradle as shown in the figure.
- 3** Fit the bracket body to the cradle.
- 4** Put the unit on the bracket and fix it using the fixing screw.
- 5** Adjust the horizontal and tilt angle of the bracket and enjoy the unit.

