



**MODEL : LAC8900N / LAC7900N**

ENGLISH



## Table of Contents

2	Table of Contents	
3	Safety Note	
4	[LAC8900N] Front Panel / Remote Control	
5	[LAC7900N] Front Panel / Remote Control	
6	[LAC8900N] About Detachable Control Panel	
7	[LAC7900N] About Detachable Control Panel	
8	Installation	
	Basic installation	
	Removing the existing receiver unit	
	ISO-DIN installation	
	Battery installation	
9	Connection	
10	Basic operation	
	Mute	
	Using the EQ	
	Adjusting the sound level	
	XDSS+	
	Checking the clock	
	Setting the clock	
11	Listening to a CD	
	Pause or restart a CD	
	Search for a section within a track / file	
	Skip to another track / file	
	Intro scan	
	Repeat	
	Shuffle	
	MP3/WMA Track -10 / +10	
	MP3/WMA Folder UP/DOWN	
	Checking information about your music	
12	Listening to the radio	
	Auto search memory	
	Storing and recalling broadcast frequencies	
	To scan the preset stations	
	To tune in the preset stations	
	Connecting USB device	
13	Connecting an Auxiliary Equipment	
	Changing settings	
14-15	Connecting a Bluetooth wireless technology	
	Disconnecting a phone	
	Answering and Ending a call	
	Rejecting a call	
	Making a call saved preset number	
	Missed call notification	
	Audio transfer	
	Making a call from the latest call	
	Paring your unit and device with Bluetooth wireless technology	
	Playing MP3 files	
	Storing a call number in last answered	
	Bluetooth wireless technology profiles information	
	The buttons with bluetooth wireless technology	
16	Adjusting the setting (Bluetooth wireless technology)	
17-18	Phone compatibility list (Bluetooth wireless technology)	
19	Troubleshooting	
20	Specifications	



This product is manufactured to comply with Directive 2006/28/EC (ANNEX I , 3.2.9), 72/245/EEC, 99/5/EC, and 2006/95/EC.

### European representative:

LG Electronics Service Europe B.V. Veluwezoom 15, 1327 AE Almere, The Netherlands (Tel: +31-036-547-8940)

## Safety Note



**CAUTION**  
RISK OF ELECTRIC SHOCK  
DO NOT OPEN



**CAUTION : TO REDUCE THE RISK OF ELECTRIC SHOCK DO NOT SPLIT COVER(OR BACK) NO USER SERVICEABLE PARTS INSIDE. REFER SERVICING TO QUALIFIED SERVICE PERSONNEL.**



This lightning flash with arrowhead symbol within an equilateral triangle is intended to alert the user to the presence of uninsulated dangerous voltage within the product's enclosure that may be of sufficient magnitude to constitute a risk of electric shock to persons.



The exclamation point within an equilateral triangle is intended to alert the user to the presence of important operating and maintenance (servicing) instructions in the literature accompanying the product.



Always operate the vehicle in a safe manner. Do not become distracted by the vehicle while driving, and always be fully aware of all driving condition. Do not change settings, or any functions. Pull over in a safe and legal manner before attempting such operations.



Do not use for many hours at extremely low or high temperature. (-10~60°C)



To reduce the risk of electric shock, do not remove the cover or back of this product. There are no user-serviceable parts inside. Refer servicing to qualified service personnel.



To reduce the risk of fire or electric shock, do not expose this product to dripping or splashing water, rain, or moisture.



The temperature of unit's outside can be extremely high, please use the unit after proper installation in your vehicle.



This unit cannot play 8cm disc (use 12cm disc only).

**CAUTION** : This product uses a Laser System.

To ensure proper use of this product, please read this owner's manual carefully and retain it for future reference.

Should the unit require maintenance, contact an authorized service center. Performing controls, adjustments, or carrying out procedures other than those specified herein may result in hazardous radiation exposure.

To prevent direct exposure to laser beam, do not try to open the enclosure. Visible laser radiation when open. **DO NOT STARE INTO BEAM.**

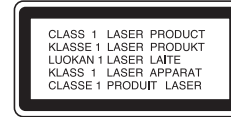

### **Caution**

When being connected in a wrong way, the unit displays as follows.

- **Antenna port short** : "ANTENNA ON PORT SHORT CIRCUIT CHECK"  
After connecting it again, restart the unit.

You have to set the disc format option to [Mastered] in order to make the discs compatible with the LG players when formatting rewritable discs.

When setting the option to Live File System, you cannot use it on LG players. (Mastered/Live File System : Disc format system for Windows Vista)

## [LAC8900N] Front Panel / Remote Control

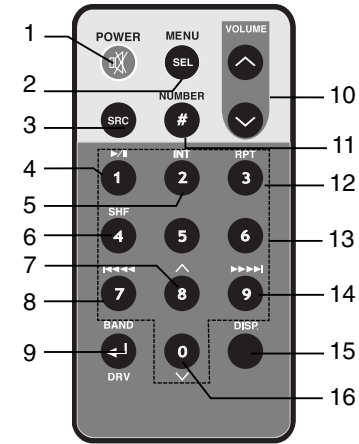
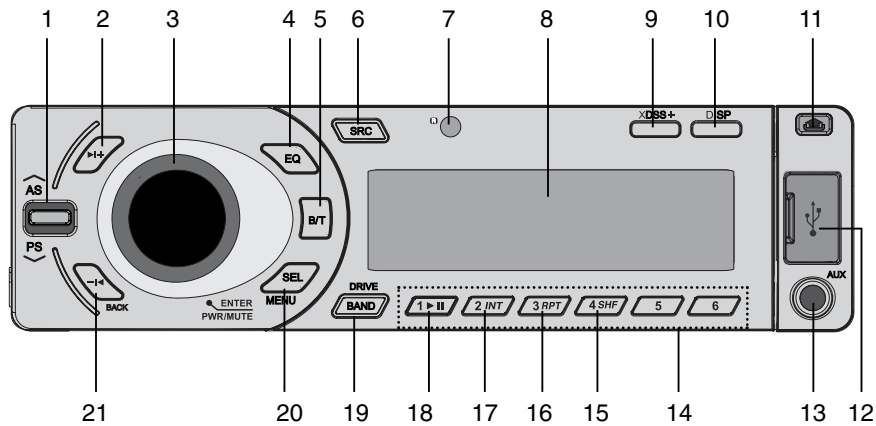

- 1 • Auto Store [A/AS]
- Preset Scan [V/PS]
- MP3/WMA Track +10/-10 A/V
- Folder Up/Down A/V
- 2 Skip / Search / Seek / Tune ►I+
- 3 • ENTER
- Volume
- [MUTE]
- Power [PWR]
- 4 Equalizer [EQ]
- 5 Bluetooth wireless technology [B/T]
- 6 SOURCE [SRC]
- 7 Remote Sensor
- 8 Display window

- 9 Extreme Dynamic Sound System [XDSS+]
- 10 Display [DISP]
- 11 Release
- 12 USB slot
- 13 AUX in
- 14 Preset Station [1~6]
- 15 Shuffle [SHF]
- 16 Repeat [RPT]
- 17 Intro Scan [INT]
- 18 Play/Pause ►II
- 19 • [BAND]
- [DRIVE]
- 20 Select [SEL] / [MENU]
- 21 Skip / Search / Seek / Tune / Back -I◀

- 1 Power [POWER] / Mute
- 2 Select [MENU/SEL]
- 3 Source [SRC]
- 4 Play / Pause ►II
- 5 Intro Scan [INT]
- 6 Shuffle [SHF]
- 7 • MP3/WMA Track +10
- Folder Up ▲
- 8 • CD Skip / Search
- Seek / Tune I◀◀◀

- 9 • [BAND]
- DRIVE [DRV]
- 10 Volume Up ▲ / Down ▼
- 11 Number [#]
- 12 Repeat [RPT]
- 13 Number [0 -9]
- 14 • CD Skip / Search
- Seek / Tune ►►►I
- 15 Display [DISP.]
- 16 • MP3/WMA Track -10
- Folder Down ▼

### Note

There is the microphone in the left top position of the unit when you detach the control panel.

## [LAC7900N] Front Panel / Remote Control

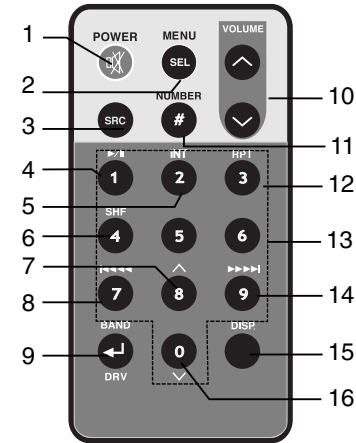
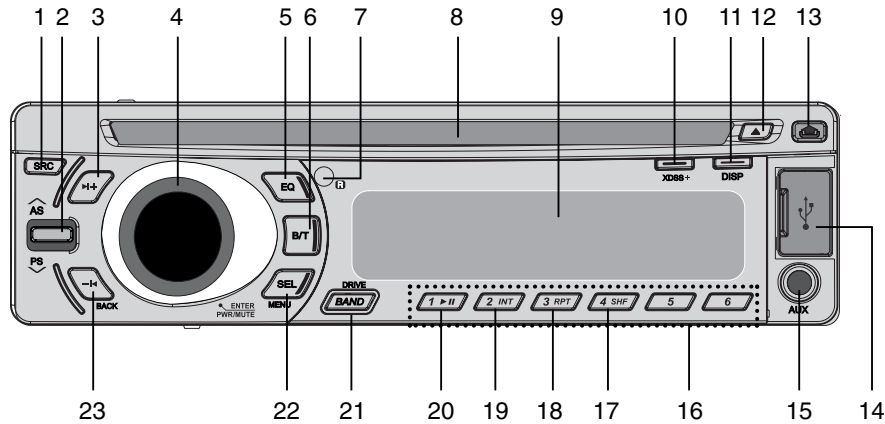

- 1 SOURCE [SRC]
- 2 • Auto Store [A/AS]
- Preset Scan [V/PS]
- MP3/WMA Track +10/-10  $\wedge/\vee$
- Folder Up/Down  $\wedge/\vee$
- 3 Skip / Search / Seek / Tune  $\blacktriangleright$ I+
- 4 • ENTER
- Volume
- [MUTE]
- Power [PWR]
- 5 Equalizer [EQ]
- 6 Bluetooth wireless technology [B/T]
- 7 Remote Sensor
- 8 CD slot
- 9 Display window

- 10 Extreme Dynamic Sound System [XDSS+]
- 11 Display [DISP]
- 12 Eject
- 13 Release  $\uparrow$
- 14 USB slot
- 15 AUX in
- 16 Preset Station [1-6]
- 17 Shuffle [SHF]
- 18 Repeat [RPT]
- 19 Intro Scan [INT]
- 20 Play/Pause  $\blacktriangleright$ II
- 21 • [BAND]
- [DRIVE]
- 22 Select [SEL] / [MENU]
- 23 Skip / Search / Seek / Tune / Back  $\blacktriangleleft$

- 1 Power [POWER] / Mute  $\times$
- 2 Select [MENU/SEL]
- 3 Source [SRC]
- 4 Play / Pause  $\blacktriangleright$ II
- 5 Intro Scan [INT]
- 6 Shuffle [SHF]
- 7 • MP3/WMA Track +10
- Folder Up  $\wedge$
- 8 • CD Skip / Search
- Seek / Tune  $\blacktriangleleft\blacktriangleleft\blacktriangleleft$
- 9 • [BAND]
- DRIVE [DRV]
- 10 Volume Up  $\wedge$  / Down  $\vee$
- 11 Number [#]
- 12 Repeat [RPT]
- 13 Number [0-9]
- 14 • CD Skip / Search
- Seek / Tune  $\blacktriangleright\blacktriangleright\blacktriangleright$
- 15 Display [DISP.]
- 16 • MP3/WMA Track -10
- Folder Down  $\vee$

### Note

There is the microphone in the left top position of the unit when you detach the control panel.

# [LAC8900N] About Detachable Control Panel

## Attaching the control panel

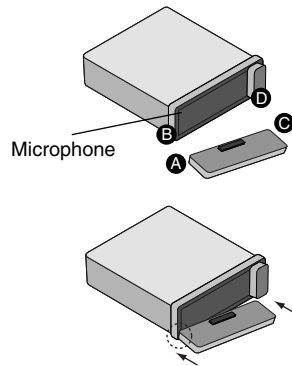



- 1 Attach part **A** of the control panel to part **B** of the unit.
- 2 Attach part **C** of the control panel to part **D** of the unit while pushing the control panel to left.
- 3 Close the control panel.

### **Caution**

- When detaching or attaching the control panel, do not press the display or control buttons.
- The control buttons may not work properly if the control panel is not attached properly. If this occurs, gently press the control panel.
- Do not leave the control panel in any area exposed to high temperatures or direct sunlight.
- Do not drop the control panel or otherwise subject it to strong impact.
- Do not allow such volatile agents as benzene, thinner, or insecticides to come into contact with the surface of the control panel.
- Do not try to disassemble the control panel.

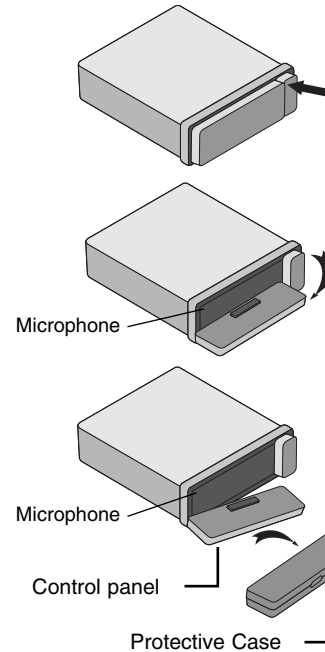
## Detaching the control panel



- 1 Press the “” button to unlock the control panel.
- 2 Push the control panel to left.
- 3 Pull the control panel out of the unit.
- 4 Put the detached control panel into the protective case.

### **Note**

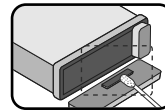

Periodically wipe the contacts on the back of the control panel with a cotton swab moistened with alcohol. For safety, turn off the ignition before cleaning, and remove the key from the ignition switch.

# [LAC7900N] About Detachable Control Panel

## Attaching the control panel

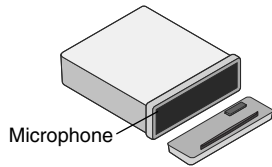

- 1 Align the left side of the panel with the stopper.
- 2 Push the right side of panel into the unit until it clicks.

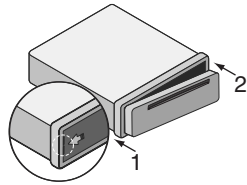

## Detaching the control panel

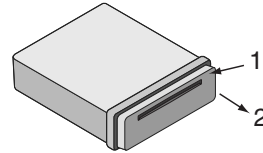

- 1 Press the "▲" (RELEASE) to open the control panel.
- 2 Hold the right part of the control panel.
- 3 Pull out the control panel.
- 4 Place the control panel in the supplied protective case.

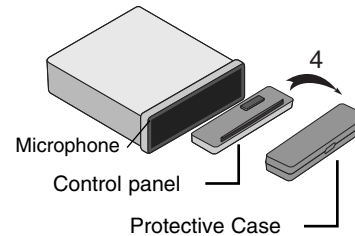
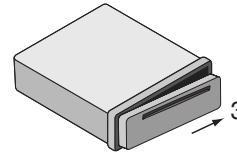

### Note

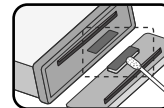

Periodically wipe the contacts on the back of the control panel with a cotton swab moistened with alcohol. For safety, turn off the ignition before cleaning, and remove the key from the ignition switch.

## Installation

### Basic Installation

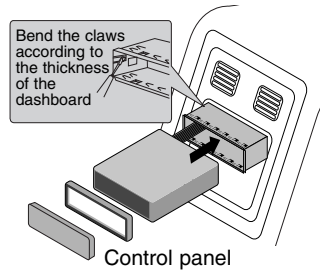

Before installing, make sure that the ignition-switch is set to OFF and remove the terminal of the car battery to avoid short-circuiting.

- 1 Remove the existing receiver unit.
- 2 Make the necessary connections.
- 3 Install the installation sleeve.
- 4 Install the unit into the installation sleeve.

### Removing the existing receiver unit

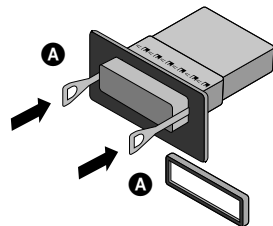

If there is already an installation sleeve for the receiver unit in the dashboard, it must be removed.

- 1 Remove the rear support from the unit.
- 2 Remove the control panel and trim ring from the unit.
- 3 Insert the lever **A** into the hole on one side of the unit. Perform the same operation on the other side and pull the unit out from the mounting sleeve.

### ISO-DIN Installation

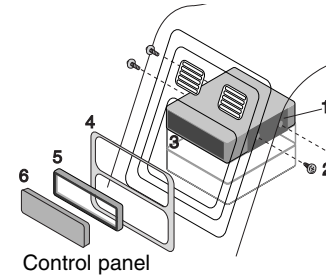

- 1 Slide the unit into the ISO-DIN frame.
- 2 Fit screws removed from the old unit.
- 3 Slide the unit and frame into the dash opening.
- 4 Install the dash panel or adapter plate.
- 5 Install the trim ring to the unit.
- 6 Install the control panel to the unit.

### Battery Installation

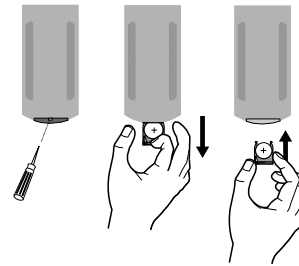

- 1 Pull out the battery holder with a sharp product like a ball point pen.
- 2 Put the battery with **+** and **-** correctly on the battery holder.
- 3 Push the battery holder back into its original position.

#### Note

- Use only one CR2025 (3V) lithium battery.
- Remove the battery if the remote control is not used for a long period of time.
- Do not leave the product in a hot or humid place.
- Do not handle the battery with metallic tools.
- Do not store the battery with metallic materials.



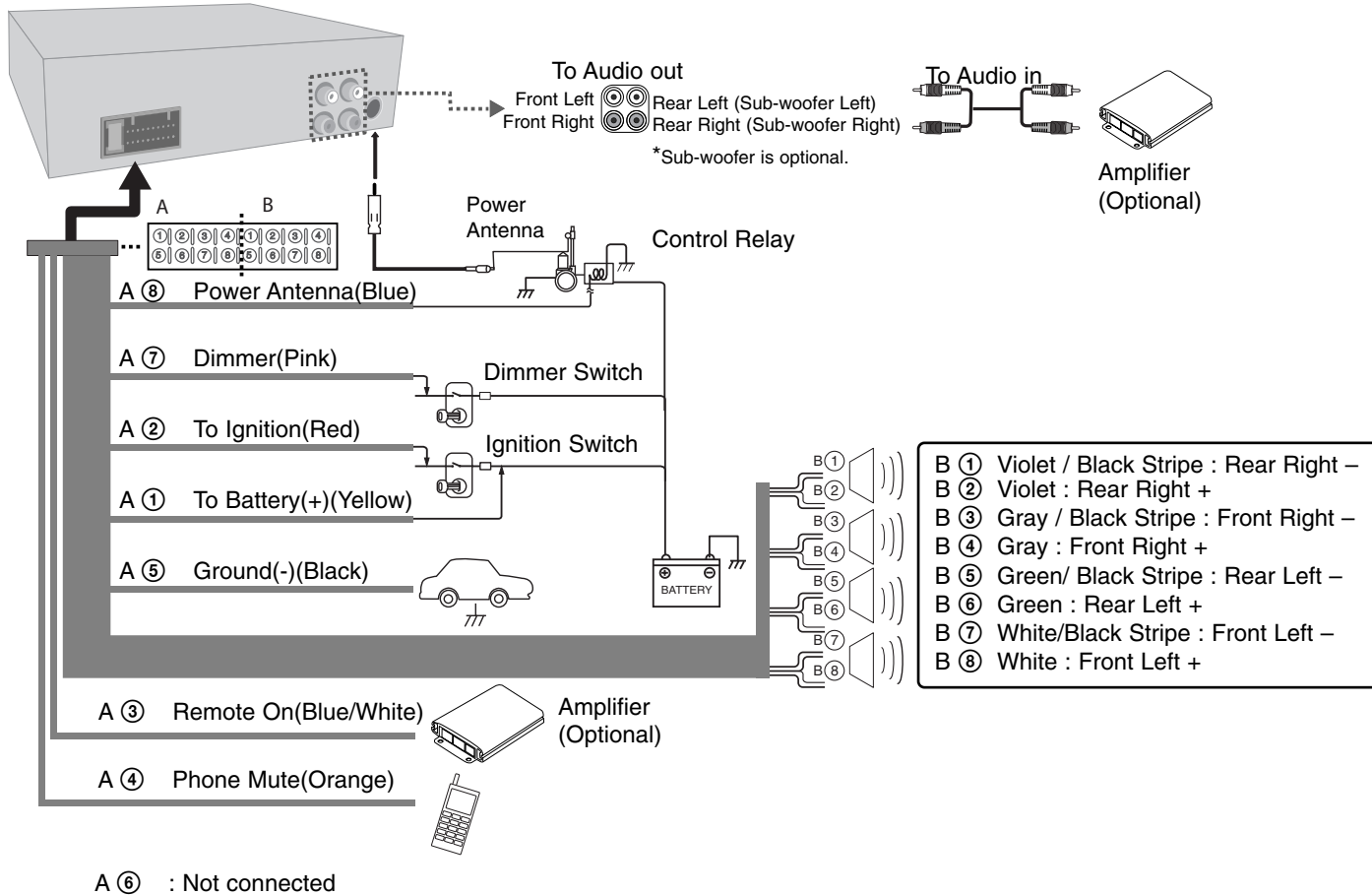

# Connection

Before connecting, make sure that the ignition switch is set to OFF, and remove the battery ⊖ terminal to avoid short circuits.



## Basic Operation

	ON PLAYER	ON REMOTE
1. Turn the unit on.	PWR/MUTE	POWER 
2. Select a source.	SRC	SRC
3. Adjust the volume.	Rotate PWR	VOLUME  

## Basic operation - more you can do

### Mute

Press **PWR/MUTE** (**POWER**  on the remote control) to cut the sound. To cancel it, press again.

### Using the EQ



EQ is to increase or decrease the signal strength of audio frequencies. The function helps you to enjoy sound more plentifully. Press **EQ** repeatedly. The screen lights up in the following order.

POP → CLASSIC → ROCK → JAZZ → VOCAL → SALSA → SAMBA → REGGAE → RUSSY → USER1 → USER2 → Off (not displayed)

#### Note

- When XDSS+ is set to "Off", you can adjust the EQ settings.
- You can adjust sound level to your preference. Once you select a USER mode and then make an adjustment, it will be automatically stored for the currently selected USER mode. Refer to the "Adjusting the sound level" for USER mode.

### Adjusting the sound level

Press **SEL/MENU** (**SEL/MENU** on the remote control) repeatedly to select the mode you want to adjust from VOL (volume), BAL (left/right speaker), FAD (front/rear speaker) and SUB (Sub-woofer: optional). To adjust sound quality, rotate **PWR** or press **VOLUME**   on the remote control.

#### Note

When EQ and XDSS+ is set to "Off", you can adjust the sound level (BAS (bass), MID (middle), TRB (treble)) settings.

### XDSS+ (Extreme Dynamic Sound System)

Press and hold **XDSS+**. (XDSS+ : Improves the treble, bass sound.)  
To cancel it, press and hold again.



### Checking the clock

You can see the clock pressing **DISP** (**DISP.** on the remote control).

### Setting the clock

- 1 Press the **DISP** (**DISP.** on the remote control) and then, press and hold **DISP** for more 1 second.
- 2 Press the **▶|+** (**▶▶ ▶▶|** on the remote control) to adjust the hour.
- 3 Press the **-|◀** (**|◀◀ ◀◀** on the remote control) to adjust the minute.
- 4 Press the **DISP** (**DISP.** on the remote control) again to finish the setting.

## Listening to a CD

	ON PLAYER	ON REMOTE
1. Open the front panel. [Only in LAC8900N]		-
2. Insert a CD.	-	-
3. Adjust the volume.	Rotate PWR	VOLUME  

## Listening a CD - more you can do

### Pause or restart a CD

Press **▶||** on the player (**▶||** on the remote control) during playback. Press this button again to resume play.

### Search for a section within a track / file

Press and hold **-|◀** / **▶|+** on the player (**◀◀◀|** / **▶▶▶▶|** on remote control) for about 1 second during playback and then release at the point you want.

### Skip to another track / file

Press **-|◀** / **▶|+** on the player (**◀◀◀|** / **▶▶▶▶|** on remote control.). To skip to previous track, press briefly **-|◀** within 3 seconds of playing time. Press **[#]** and a number you want to move on remote control to move the files/track.

### Intro scan

Press or press and hold **INT** on the player (**INT** on remote control). Each files in the current selected folder ( **INT**) or the first 10 seconds of each tracks/files (**INT**) on the disc are played. To cancel it, press the button again.

### Repeat

Press or press and hold **RPT** on the player (**RPT** on the remote control). The current selected tracks/files (**1 RPT**) or folder ( **RPT**) on the disc is played repeatedly. To cancel it, press the button again.

### Shuffle

Press or press and hold **SHF** on the player (**SHF** on the remote control). Each files in the current selected folder ( **SHF**) or all of the tracks/files (**SHF**) on the disc is played randomly. Press **SHF** again to cancel it.

#### Note

During random playback, if you press **-|◀**, you won't go back to the previous track.

### MP3/WMA Track -10 / +10

(If there is no folder or one folder.) During playback push the button down to **V/PS** to go back 10 tracks, and push it up to **▲/AS** to go forward 10 tracks.

### MP3/WMA Folder UP/DOWN

(If there are more than two folders.) During playback, push the button down to **V/PS** to go back to the previous folder, and push it up to **▲/AS** to go forward to the next folder.

### Checking information about your music

MP3/WMA files often come with tags. The tag gives the Title, Artist or Album. Press **DISP** repeatedly during MP3/WMA/CD TEXT file playback. If there is no information, "NO TEXT" will be shown in the display window.

#### Note

-  : The icon is displayed during MP3/WMA playback.
- **MP3/WMA Disc compatibility with this unit is limited as follows:**
  1. Sampling Frequency / 8 - 48kHz (MP3) 22.05 - 48kHz (WMA)
  2. Bit rate / within 8 - 320kbps (include VBR) (MP3) 32 -320kbps (WMA)
  3. CD-R/CD-RW file system should be "ISO 9660"
  4. If you record MP3/WMA files using software which cannot create a FILE SYSTEM, for example "Direct-CD" etc., it will not be possible to playback MP3/WMA files. We recommend that you use "Easy-CD Creator" which creates an ISO9660 file system.

**Customers should also note that permission is required in order to download MP3/WMA files and music from the Internet. Our company has no right to grant such permission. Permission should always be sought from the copyright owner.**

## Listening to the radio

	ON PLAYER	ON REMOTE
1. Select a source to tuner.	<b>SRC</b>	<b>SRC</b>
2. Select a band.	<b>BAND</b>	<b>BAND</b>
3. Auto seek. Manual seek.	- ◀ / ▶ + Press and hold - ◀ / ▶ +	◀◀◀/▶▶▶  Press and hold  ◀◀◀/▶▶▶

## Listening to the radio - more you can do

### Auto search memory

Push the button up to **▲/AS**. The six strongest broadcast frequencies will be stored under preset button 1-6 in the order of their signal strength. To cancel, push the button up to **▲/AS**.

### Storing and recalling broadcast frequencies

- 1 Press **BAND** to select desired band you want to store.
- 2 Select the desired frequency and press one of preset buttons 1-6 and hold until the beep sound.
- 3 Repeat steps 1-2 to preset other stations. The next time, you press the same preset button, the radio station frequency is recalled from the memory.

### To scan the preset stations

Push the button down to **▼/PS**. Each preset station appears. To cancel, push the button down to **▼/PS**.

### To tune in the preset stations

Press **BAND** to select the desired band and press the desired preset button 1-6 (preset button 1-6 on the remote control).

#### **Note**

When a station is stored on the preset numbers on which another station of the same band has already been preset, the previously preset station is automatically erased.

## Connecting USB device

	ON PLAYER	ON REMOTE
1. Open the USB cover.	-	-
2. Connect the USB device.	-	-
3. Adjust the volume.	Rotate PWR	VOLUME ^ v

### Moving to another drive

When connecting this unit to multi reader, press **BAND/DRIVE (BAND/DRV** on remote control) to go to the next drive. Each time you press the button, the driver modes changes.

#### **Note**

- If the USB device is already connected, press **SRC (SRC** on remote control.) to select a source to USB.
- Pause / Intro Scan / Repeat / Shuffle / ... functions are same with "Listening a CD - more you can do". Refer to the page 11.

## Connecting an Auxiliary Equipment

	ON PLAYER	ON REMOTE
1. Connect an auxiliary equipment to the AUX jack with line input cable.	-	-
2. Select a source to AUX.	SRC	SRC
3. Play the connected Auxiliary Equipment.	-	-
4. Adjust the volume.	Rotate PWR	VOLUME ^ v

## Changing settings

	ON PLAYER	ON REMOTE
1. Select one item.	Press and hold SEL/MENU	Press and hold SEL/MENU
2. Select a source.	Rotate PWR	VOLUME ^ v
3. Finish the setting.	Press and hold SEL/MENU	Press and hold SEL/MENU

- AUX (Auxiliary) ON / OFF  
It is possible to use auxiliary equipment with this unit. Activate the auxiliary setting when using auxiliary equipment connected to this unit.
- AUX (Auxiliary) 00dB / +6dB  
Only when you set AUX to ON as switching sources, you can adjust the volume level of each source to prevent radical changes in volume.  
You can set to 0 dB or +6 dB. You may be surprised at a loud sound when you change the source from the external component to another source.
- DEMO OFF/ ON  
You can change the initial indication on the display to information name (function name, EQ name, etc...) while listen to a source.
- LCD WHI / RED  
You can change the LCD window colour. WHI (white) <-> RED (red)
- LED BLU/RED/AUTO  
You can change the button color. BLU (Blue) <-> RED (Red) <-> AUTO

- COL TM (Color changing time)  
Only when you set LED to AUTO, you can set LED color changing time from 5 to 60 seconds.
- SW (Subwoofer) OFF / 55HZ / 85HZ / 120HZ  
You can enable the subwoofer.
- DIM (Dimmer) OFF / ON / AUTO  
You can change the brightness of the display window during the power-on status. When you set DIMMER to AUTO, the dimmer operates according to the car dimmer setting.
- DIM L (Dimmer Level)  
When you set DIM to ON/AUTO, you can adjust the dimmer level. (-2,-1,0,+1,+2)
- A-EQ (AUTO EQ) ON/OFF  
AUTO EQ operates only in the music file supported with Genre in the device. When you set AUTO EQ to ON, POP, CLASSIC or ROCK is automatically according to the music genre.
- BEEP 2ND / ALL  
BEEP 2ND : The beep is generated when a key is long pressed. (1 sec)  
BEEP ALL : The beep is generated when any key is pressed.

## Connecting a *Bluetooth* wireless technology

Before you start the pairing procedure, make sure the *Bluetooth* wireless technology is turned on in to your phone. Refer to your phone's user guide. Pairing links your unit and phone with *Bluetooth* wireless technology, and is required only once for the initial setup. If the connection is successful, the phone is registered (Device 1–5) and the flashing of indicator stops on the unit. The process of pairing may be different depend on the phones. The PIN CODE is 1234.

	ON PLAYER
1. Enter the menu.	<b>B/T</b>
2. Find the "CONNECTION" menu.	<b>Rotate PWR</b>
3. Search the phones supported Bluetooth wireless technology.	<b>Press PWR</b>
4. Select a phone you want to connect.	<b>Rotate PWR</b>
5. Connect the phone.	<b>Press PWR</b>
6. Select the "CONNECT" menu.	<b>Press PWR</b>

## Using a *Bluetooth* wireless technology - more you can do

### Disconnecting a phone.

Refer to page 16. Go to the menu (B/T -> CONNECTION -> Connected device name -> DISCONNECT)

### Answering and Ending a call.

When your unit rings, press **B/T** to answer a call. To end a call, press and hold **B/T**.

### Rejecting a call

When your unit rings, press and hold **B/T**.

### Making a call saved preset number

Press **B/T** and preset number (1~6).

### Missed call notification

When an incoming call is not answered, the missed call message is displayed on the display window (without headset profile). When the " ? " appears, go to the menu (B/T -> CALL -> MISSED). You can check the list of missed call. To place a call, press **B/T**. And to end the call and hang up the phone, press and hold **B/T**.

### Audio transfer

It is possible to switch the audio connection between your phone equipped with Bluetooth wireless technology and this unit.

1 Press **B/T** to answer the call.

2 Press **B/T** again. The "Private" is displayed.

If the private mode is selected on the unit, press **B/T** to return to the call to hands-free mode.

### Making a call from the latest call

The lists are sorted from newest to oldest entries. Your unit keeps recorded of your recently received and dialed on phone. Refer to the page 16.

#### Note

- When you want to make an international call, press **▶I+** to add "+" and to delete it press again.
- "+" can only be added when the detail list of Missed call, Dialed call or Received call is selected.
- Rejecting a call / Making a call saved preset number / Missed call notification (These features are only available on phones with Headset profile.)

### **Paring your unit and device with Bluetooth wireless technology (MP3 Player, MP3 Phone...)**

When you activate your Bluetooth device's linked unit, you can listen to MP3 with wireless connections. The method of use for a Bluetooth device is the same as when using a Bluetooth phone. Refer to the phone's user guide for using this function.

### **Playing MP3 files**

When you turn Bluetooth on, your device supported Bluetooth wireless technology displays "Bluetooth" on the home screen. The Bluetooth remains on until you turn the device off. Press **SRC** repeatedly to select "BT Music". To play an MP3 file stored on your device. Refer to the phone's user guide for using this function.

### **Storing a call number in last answered.**

You can easily store up to 6 phone numbers and later recall with the press the button. Refer to the page 14. Go to the menu (CALL -> RECEIVED -> Rotate **PWR** the phone number you want to save -> SAVE -> select 1~6).

### **Bluetooth wireless technology profiles information.**

In order to use Bluetooth wireless technology, devices must be able to interpret certain profiles. This unit is compatible with following profiles.

**GAP** (Generic Access Profile)

**HFP** (Hands Free Profile)

**HSP** (Hands Set Profile)

**GAVDP** (Generic Audio/Video Distribution Profile)

**A2DP** (Advanced Audio Distribution Profile)

**AVRCP** (Audio/Video Distribution Remote Control Profile)

**OPP** (Object Push Profile)

### **The buttons with bluetooth wireless technology**

**B/T** : Press it to enter B/T setting.

**▶|+** : When you write some words on the unit, press it to move next space on display.

• Press **PWR** : Go to the next contents of the setting.

• Rotate **PWR** : Move the contents vertically on the setting or choose a spell when you write the words on the unit.

**-|◀** : Press it to delete a spell or go back previous contents. Press more 1 second to delete all words entered on display when you write some words on the unit.

#### **★ Note**

The position of LAC7900N's B/T button is different with LAC8900N. But the features are same.

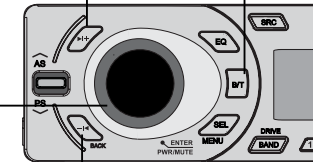

[LAC8900N]

## Adjusting the setting. (Bluetooth wireless technology)

**B/T**

<b>CALL</b>	<b>RECEIVED</b>	RECEIVED/DIALED/MISSED Phone number list.
	<b>DIALED</b>	To call the phone number, select the phone number and press <b>B/T</b> .
	<b>MISSED</b>	To save it, select the phone number and press <b>PWR</b> . "SAVE" will be shown. Press <b>PWR</b> again. Rotate <b>PWR</b> to select a preset number(1~6). Press <b>PWR</b> again. The phone number be saved.
	<b>PRESET</b>	PRESET : Checking and deleting the phone number saved preset number. To delete the phone number, select the preset number by rotating <b>PWR</b> . And then press <b>PWR</b> . Press <b>PWR</b> again when the "DELETE" is displayed.
	<b>REDIAL</b>	REDIAL : Adjusting the counts of redial. (1 TIME <-> 2 TIMES.)
	<b>DIAL</b>	DIAL : Entering the number directly on the unit. To select the 1~10 rotate the volume. Press <b>▶I+</b> to make the phone number. To call it, Press <b>B/T</b> .
<b>PHONEBOOK</b>	<b>LIST</b>	LIST : Checking the list of the phone numbers saved by phonebook.
	<b>SEARCH</b>	Searching the phone number in the list. (English and Russian only) Press <b>▶I+</b> more 1 second to change the languages between Russian and English.
	<b>GET (ADD)</b>	GET : Getting the Phonebook from the phone automatically. (This menu is only available with phones supported this function.) ADD (Under disconnection) : PHONEBOOK -> ADD-> Press <b>PWR</b> -> "000/500" will be displayed. Then send the phonebook data from your phone. Depend on your phone, the sending process is different. Refer to your phone's guide.
<b>CONNECTION</b>	<b>Connected Device Name</b>	Connected Device Name will be displayed. When the unit is not under connection, you can search the phones available to connect. Select the register in the Connection contents.
<b>SETUP</b>	<b>VISIBILITY</b>	VISIBILITY : You can make it is impossible to search this unit. (SHOWN <-> HIDDEN)
	<b>AUTO CONN</b>	AUTO CONN : Adjusting connection with automatically or not. (ON <-> OFF)
	<b>AUTO ANSWER</b>	AUTO ANSWER : You can adjust answering automatically or not. (ON <-> OFF)
	<b>MIC VOLUME</b>	MIC VOLUME : Adjusting microphone volume on the phone from 1 to 5. While you are on the phone with bluetooth wireless technology, rotate <b>PWR</b> to adjust the MIC volume.
<b>BT INFO</b>	<b>NAME</b>	NAME : Changing the name of this unit.
	<b>PIN-1234</b>	PIN code : Changing the PIN code. Default is 1234.
	<b>ADDRESS</b>	ADDRESS : Checking the address.



## Phone compatibility list (Bluetooth wireless technology)

Bluetooth list and manufacturing company applicable.

**H** : Handsfree

**A** : Audio Streaming (A2DP)

**P** : Phonebook Sync (GET)

**V** : Object Push(Vcard, ADD)

Company	List	H	A	P	V	Company	List	H	A	P	V	Company	List	H	A	P	V			
Nokia	3230	○			○	Nokia	N70	○			○	SONY	K610i	○	○	○	○			
	3250	○			○		N71	○			○		○	ERICSSON	K618i	○	○		○	
	3650	○		○	○		N73	○			○		○	K700i	○			○	○	
	5300	○	○	○	○		N77	○	○				○	K750i	○			○	○	
	6021	○		○	○		N80	○					○	K770i	○	○			○	○
	6103	○		○	○		N90	○					○	K800i	○	○		○	○	○
	6120	○	○		○		N91	○					○	M600i	○	○		○	○	○
	6131	○			○		N92	○					○	P990i	○	○		○	○	○
	6230	○			○		N93	○					○	S500i	○	○		○	○	○
	6270	○			○		N95	○	○				○	S700i	○			○	○	○
	6280	○	○		○	N-Gage	○				○	T610	○			○	○	○		
	6600	○			○	N-Gage QD	○				○	T618	○			○	○	○		
	6630	○			○	Motorola	A1000	○			○	T628	○			○	○	○		
	6650	○			○		A780	○				○	T68i	○			○	○	○	
	6670	○			○		E1000	○		○			V600	○			○	○	○	
	6680	○			○		E1070	○	○			○	V800	○			○	○	○	
	6681	○			○		E398	○		○		○	W550i	○			○	○	○	
	6820	○			○		E550	○		○		○	W710i	○	○		○	○	○	
	7370	○			○		E680	○				○	W800i	○			○	○	○	
	7380	○			○		E680i	○				○	W810i	○			○	○	○	
	7610	○			○		KRZR K1	○	○		○	○	W850i	○	○		○	○	○	
	7650	○			○		L72	○		○		○	Z1010	○			○	○	○	
	7600	○			○		RAZR V3	○			○		Z600	○			○	○	○	
	7610	○			○		RAZR V3i	○				○	Z608	○			○	○	○	
	7650	○			○		RIZR Z8	○	○			○	SAMSUNG	D500	○					
	8600	○	○		○		ROKR E2	○	○			○		D600	○	○			○	○
	8800	○	○	○	○		ROKR E6	○	○			○		D820	○	○		○	○	○
	9500	○			○		SLVR L7	○		○				D900	○	○			○	○
	3650 (Italy)	○			○	U6	○		○			E770		○	○		○	○	○	
	5500 SPORT	○			○	V195	○		○			E900		○	○		○	○	○	
	6230i	○			○	V360	○		○			i600		○	○					
	6820a	○			○	V3X	○	○			○	T509		○					○	
7500prism	○	○		○	V500	○			○	○	X820	○		○		○		○		
7650 (Italy)	○			○	V525	○			○	○	Z540V	○								
8910i	○			○	V600	○			○	○										
9300i	○			○																
E50	○			○																
E60	○			○																
E61	○			○																
E62	○			○																
E70	○			○																

Bluetooth list and manufacturing company applicable.

**H** : Handsfree

**A** : Audio Streaming (A2DP)

**P** : Phonebook Sync (GET)

**V** : Object Push(Vcard, ADD)

Company	List	H	A	P	V	Company	List	H	A	P	V	Company	List	H	A	P	V				
SIEMENS	EF81	○		○	○	LG	CU500	○	○		○	PHILIPS	KE770	○	○		○				
	S55	○			○		KE970	○	○		○		M4410	○				○			
	S65	○			○		KG245	○			○		O2 Xda Atom	○	○						
	S88	○			○		KG800	○			○								○		
	SK65	○			○		U880	○			○								○		
	SL75	○	○		○		U890	○	○											○	
	SX1	○			○		KF600	○	○				○							○	
	SXG75	○		○	○		KE850 PRADA	○	○				○							○	
BLACK BERRY	8100(PEARL)	○			○	KG290	○			○		PANTECH	PG6200	○	○			○			
	8800	○		○	○	KE500	○	○		○			NEC	N750	○						
	8707v	○			○	KM500	○	○		○			N930	○							
HP	HW6915	○		○	○	KU990 VIEWTY	○	○		○		SAGEM	MYX6-2	○							
PALM	Treo750v	○	○			KU580	○	○		○											
						KU970	○	○		○											
						KU960	○	○		○											
						U370	○	○		○											

**Note**

1. When the phone features <Bluetooth Power Save> function, you should make the function turned on to maintain connection.
2. When you switch the call mode from handsfree to phone, the connection may e disconnected.
3. Some phones don't support Reject function.
4. Low battery in phone may cause the problems.



“The *Bluetooth* word mark and logos are owned by the Bluetooth SIG, Inc. and any use of such marks by LG Electronics is under license. Other trademarks and trade names are those of their respective owners.”

*Bluetooth*® wireless technology is a system which allows radio contact between electronic devices within a max. range of 10 meters. Connecting individual devices under *Bluetooth*® wireless technology does not incur any charges. A mobile phone with *Bluetooth*® wireless technology can be operated via the Cascade if the connection was made via *Bluetooth*® wireless technology.

**Operating condition for using a *Bluetooth* wireless technology function**

- Close windscreen.
- Turn off the air conditioner/ heater.
- Stop the vehicle or drive at low speed.
- Make the call in a quiet location.
- There may be differences in call quality depending on phone type, road conditions weather, etc.
- Using the phone while driving may cause unexpected accidents.
- The *Bluetooth* wireless technology function may not operate properly with certain types of phones equipped with *Bluetooth* wireless technology.

## Troubleshooting

	Symptom	Cause	Correction
General	Power doesn't turn on / The unit doesn't operate.	Leads and connectors are not properly.	Confirm once more that all connections are correct.
		The fuse is blown.	Rectify the problem that caused the fuse to blow, and then replace it. Be very sure to install the correct fuse with the same rate.
		Noise and other factors are causing the built-in microprocessor to operate incorrectly.	Turn the unit off and then on.
	No sound is heard / The volume level will not rise.	Cables are not connected correctly.	Connect the cables correctly.
CD	There's audio skipping.	This unit is not firmly secured.	Secure this unit firmly.
	The playback is not possible.	The disc is dirty.	Clean disc.
		The loaded disc is of a type this unit cannot play.	Check what type the disc.
Radio	Radio stations cannot be tuned in.	The signal strength of the stations is too weak (when tuning in with automatic tuning.)	Tune in the stations manually.
		No station have been preset or preset stations have been cleared (when tuning by scanning preset stations.)	Preset the stations. (Refer to the page 12)
Remote control	The unit does not operate correctly even when the appropriate remote control buttons are pressed.	Battery power is low.	Load new battery.

## Specifications

### General

Output Power	53 W x 4 CH (Max.)
Power Source	DC 12V
Speaker impedance	4 $\Omega$
Ground System	Negative
Dimensions (W x H x D)	180 x 50 x 176 mm (Without Control Panel)
Net Weight	1.3 kg

### Tuner

#### FM

Frequency Range	87.5-107.9, 87.5-108
S/N Ratio	55 dB
Distortion	0.7 %
Usable Sensitivity	12 dB $\mu$ V

#### AM (MW)

Frequency Range	520-1720 or 522-1620 kHz
S/N Ratio	50 dB
Distortion	1.0 %
Usable Sensitivity	28 dB $\mu$ V

### CD

Frequency Response	20 Hz-20 kHz
S/N Ratio	80 dB
Distortion	0.12 %
Channel Separation (1kHz)	55 dB

### AUX

Frequency Response	20 Hz-20 kHz
S/N Ratio	80 dB
Distortion	0.1 %
Channel Separation (1kHz)	45 dB
Max Input Level (1kHz)	1.1 V

### Bluetooth

TX POWER	4 dBm
Frequency Range	2402 ~ 2480MHz
Version	Bluetooth Specification 2.0 + EDR

### USB

Version	USB 1.1
---------	---------

### Line OUT

Subwoofer (optional)	
Frequency Response	20 Hz - 120 Hz
Output Volatage	1.8 V (Max.)
Line out	
Frequency Response	20Hz - 20 KHz
Output Volatage	1.8 V (Max.)

Designs and specifications are subject to change without notice.