

Model	VC68**		
Language	English		
Page	27	Color(cover/body)	1/1
Material	Weight 100g	Size(W*H)	150×220(mm)
Date	2009.07.09	Designer	zhangdongyue
Part No.	MFL57903834	Description	Owners Manual

### Chage Record

No.	Change content	ECO No.	Date	Designer	Confirm
①					
②					
③					
④					
⑤					
⑥					
⑦					
⑧					
⑨					

# OWNER'S MANUAL

**VC6820NHAY**

## **New Type Cyclone Vacuum Cleaner**

This information contains important instructions for the safe use and maintenance of the vacuum cleaner.  
Especially, please read all of the information on page 4,5 for your safety.  
Please keep this manual in an easily accessible place and refer to it anytime.





# Table of contents

<b>Important safety instructions</b> .....	4~5
<b>How to use</b> .....	6
Assembling vacuum cleaner .....	6
Operating vacuum cleaner.....	8
Using carpet and floor nozzle .....	9
User's guide for sani punch .....	10
Using accessory nozzles .....	11
Emptying dust tank .....	12
Cleaning dust tank .....	13
Cleaning air filter and motor safety filter .....	14
Cleaning exhaust filter .....	15
What to do if your vacuum cleaner does not work .....	16
What to do when suction performance decreases .....	16

# IMPORTANT SAFETY INSTRUCTIONS

Read and follow all instructions before using your vacuum cleaner to prevent the risk of fire, electric shock, personal injury, or damage when using the vacuum cleaner. This guide does not cover all possible conditions that may occur. Always contact your service agent or manufacturer about problems that you do not understand. This appliance complies with the following EC Directives: -2006/95/EC Low Voltage Directive -2004/108/EC EMC Directive



This is the safety alert symbol.

This symbol alerts you to potential hazards that can kill or hurt you and others.

All safety messages will follow the safety alert symbol and either the word "WARNING" or "CAUTION."

These words mean:



**WARNING**

This symbol will alert you to hazards or unsafe practices which could cause serious bodily harm or death.



**CAUTION**

This symbol will alert you to hazards or unsafe practices which could cause bodily injury or property damage.



**WARNING**

• **Disconnect electrical supply before servicing or cleaning the unit or when cleaner is not in use.**  
Failure to do so could result in electrical shock or personal injury.

• **Do not use vacuum cleaner to pick up anything that is burning or smoking such as cigarettes, or hot ashes.**  
Doing so could result in death, fire or electrical shock.

• **Do not vacuum flammable or explosive substances such as gasoline, benzene, thinners, propane (liquids or gases).**  
The fumes from these substances can create a fire hazard or explosion. Doing so could result in death or personal injury.

• **Do not handle plug or vacuum cleaner with wet hands.**  
Doing so could result in death or electrical shock.

• **Do not unplug by pulling on cord.**  
Doing so could result in product damage or electrical shock. To unplug, grasp the plug, not the cord.

• **Keep hair, loose clothing, fingers, and all parts of the body away from openings and moving parts.**  
Failure to do so could result in electrical shock or personal injury.

• **Do not pull or carry by cord, use cord as a handle, close a door on cord, or pull cord around sharp edges or corners. Do not run vacuum cleaner over cord. Keep cord away from heated surfaces.**  
Failure to do so could result in electrical shock or personal injury or fire or product damage.

• **Do not allow to be used as toy. Close attention is necessary when used by or near children.**  
Personal injury or product damage could result.

• **Do not use the vacuum cleaner if the power cord or plug is damaged or faulty.**  
If the power cord is damaged, it must be replaced by an approved LG Electronics Service Agent to avoid a hazard.

• **Do not use vacuum cleaner if it has been under water.**  
Personal injury or product damage could result. In these cases, contact LG Electronics Service Agent to avoid hazard.

• **Do not continue to vacuum if any parts appear missing or damaged.**  
Personal injury or product damage could result. In these cases, contact LG Electronics Service Agent to avoid hazard.

• **Do not use an extension cord with this vacuum cleaner**  
Fire hazard or product damage could result.

• **Using proper voltage.**  
Using improper voltage may result in damage to the motor and possible injury to the user. Proper voltage is listed on the bottom of vacuum cleaner.

• **Turn off all controls before unplugging.**  
Failure to do so could result in electrical shock or personal injury.

• **Do not change the plug in any way.**  
Failure to do so could result in electrical shock or personal injury or product damage. Doing so result in death. If plug does not fit, contact a qualified electrician to install the proper outlet.

• **Repairs to electrical appliances may only be performed by qualified service engineers.**  
Improper repairs may lead to serious hazards for the user.

• **Do not plug in if control knob is not in OFF position.**  
Personal injury or product damage could result. (Depending on model)

• **Keep children away and beware of obstructions when rewinding the cord to prevent personal injury**  
The cord moves rapidly when rewinding. (Depending on model)

• **The hose contains electrical wires. Do not use it if it is damaged, cut or punctured.**  
Failure to do so could result in death, or electrical shock. (Depending on model)

# IMPORTANT SAFETY INSTRUCTIONS

## CAUTION

- **Do not put any objects into openings.**  
Failure to do so could result in product damage.
- **Do not use with any opening blocked: keep free of dust, lint, hair, and anything that may reduce air flow.**  
Failure to do so could result in product damage.
- **Do not use vacuum cleaner without dust tank and/or filters in place.**  
Failure to do so could result in product damage.
- **Do not use vacuum cleaner to pick up sharp hard objects, small toys, pins, paper clips, etc.**  
They may damage the cleaner or dust bin.
- **Store the vacuum cleaner indoors.**  
Put the vacuum cleaner away after use to prevent tripping over it.
- **This appliance is not intended for use by persons (including children) with reduced physical, sensory or mental capabilities, or lack of experience and knowledge, unless they have been given supervision or instruction concerning use of the appliance by a person responsible for their safety.**  
Children should be supervised to ensure that they do not play with the appliance.
- **Only use parts produced or recommended by LG Electronics Service Agents.**  
Failure to do so could result in product damage.
- **Use only as described in this manual. Use only with LG recommended or approved attachments and accessories.**  
Failure to do so could result in personal injury or product damage.
- **To avoid personal injury and to prevent the machine from falling when cleaning stairs, always place it at the bottom of stairs.**  
Failure to do so could result in personal injury or product damage.
- **Use accessory nozzles in sofa mode.**  
Failure to do so could result in product damage.
- **Make sure the filters (exhaust filter and motor safety filter) are completely dry before replacing in the machine.**  
Failure to do so could result in product damage.
- **Do not dry the filter in an oven or microwave.**  
Failure to do so could result in fire hazard.
- **Do not dry the filter in a clothes dryer.**  
Failure to do so could result in fire hazard.
- **Do not dry near an open flame.**  
Failure to do so could result in fire hazard.
- **Always clean the dust bin after vacuuming carpet cleaners or fresheners, powders and fine dust.**  
These products clog the filters, reduce airflow and can cause damage to the cleaner. Failure to clean the dust bin could cause permanent damage to the cleaner.  
(Depending on model)
- **Don't grasp the tank handle when you are moving the vacuum cleaner.**  
The vacuum cleaner's body may fall when separating tank and body. Personal injury or product damage could result. **You should grasp the carrier handle** when you are moving the vacuum cleaner. (Depending on model)
- **If after emptying the dust tank the indicator light is on (red), clean the dust tank.**  
Failure to do so could result in product damage.  
(Depending on model)

### Thermal protector :

This vacuum cleaner has a special thermostat that protects the vacuum cleaner in case of motor overheating. If the vacuum cleaner suddenly shuts off, turn off the switch and unplug the vacuum cleaner. Check the vacuum cleaner for possible source of overheating such as a full dust tank, a blocked hose or clogged filter. If these conditions are found, fix them and wait at least 30 minutes before attempting to use the vacuum cleaner. After the 30 minute period, plug the vacuum cleaner back in and turn on the switch. If the vacuum cleaner still does not run, contact a qualified LG authorised Service Agent.

# How to use Assembling vacuum cleaner

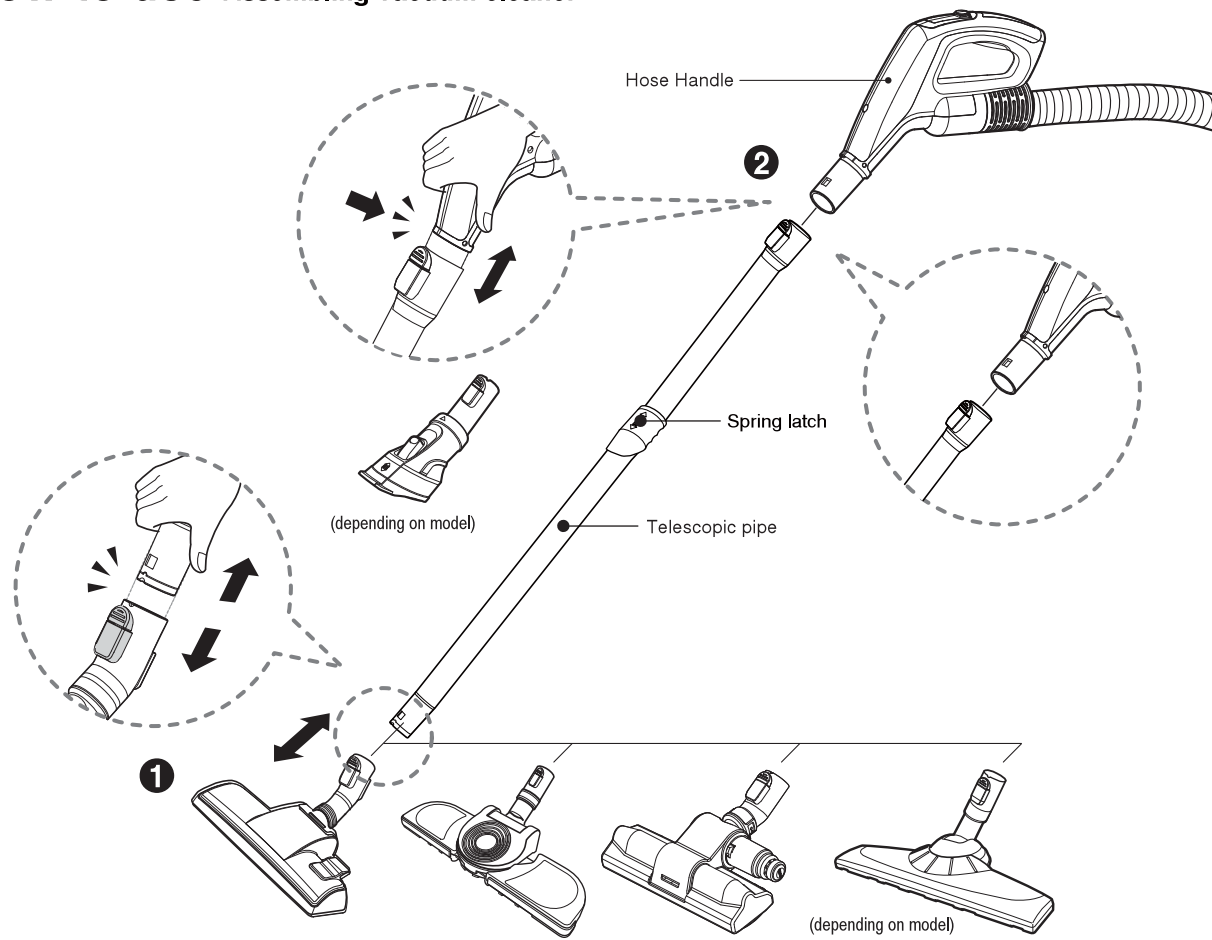

## 1 Carpet and floor nozzle

Push the nozzle into the telescopic pipe.

## 2 Telescopic pipe

- Push telescopic pipe firmly into hose handle.
- Grasp the spring latch to expand.
- Pull out the pipe to desired length.

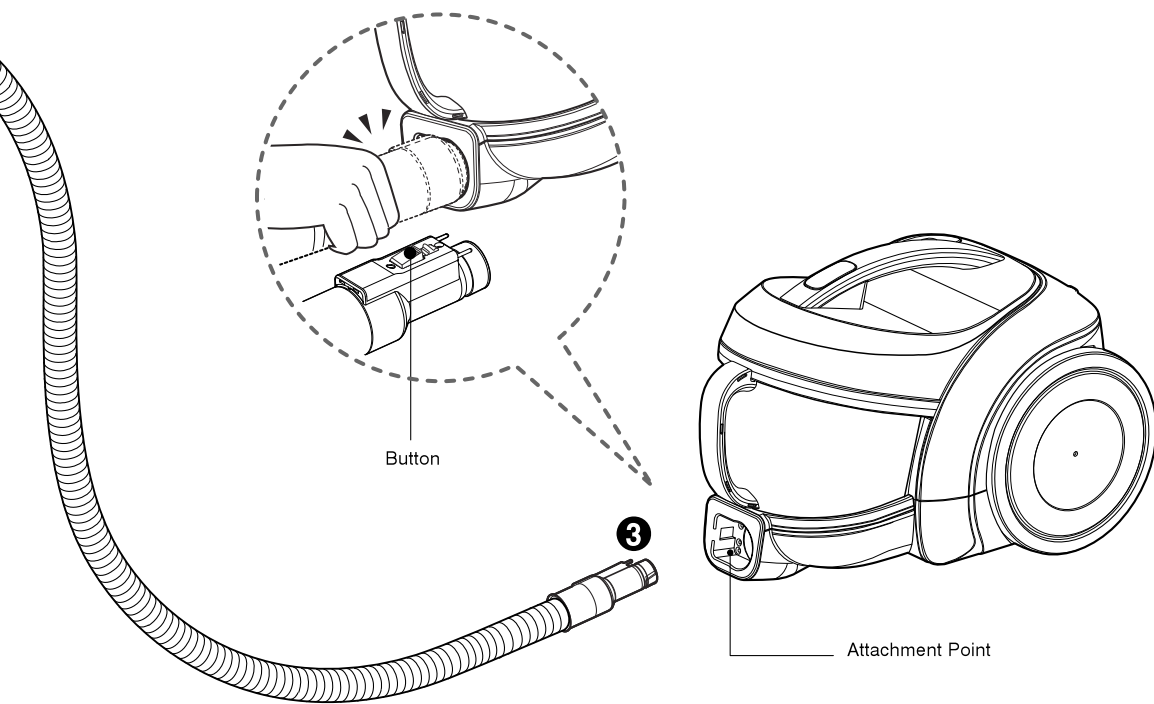

### 3 Connecting the hose to the vacuum cleaner

Push the fitting pipe on the flexible hose into the attachment point on the vacuum cleaner. To remove the flexible hose from the vacuum cleaner, press the button situated on the fitting pipe, then pull the fitting pipe out of the vacuum cleaner.



## How to use Operating vacuum cleaner

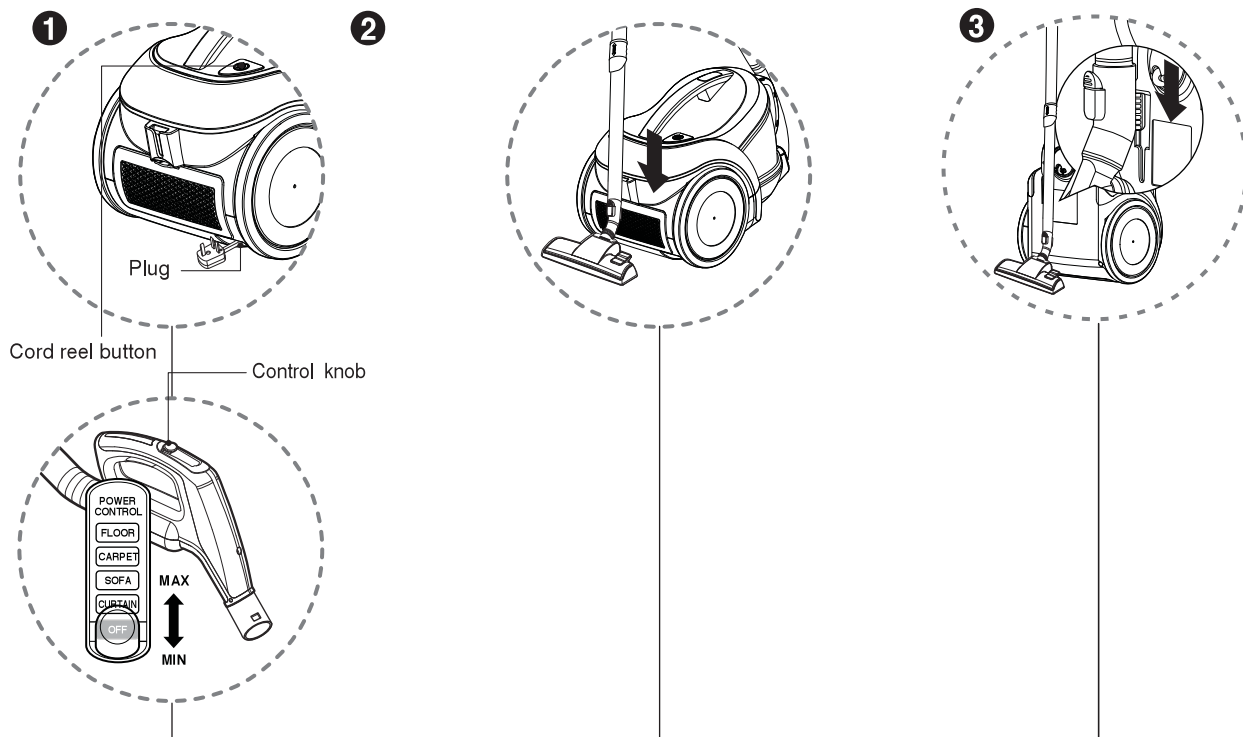

### 1 How to operate

- Pull out the power cord to the desired length and plug into the socket.
- Place the control knob of the hose handle to the required position.
- To turn off, slide control knob to OFF position.
- Press the cord reel button to rewind the power cord after use.

### 2 Park mode

- To store during vacuuming, for example to move a small piece of furniture or a rug, use park mode to support the flexible hose and nozzle.
  - Slide the hook on the nozzle into the slot on the side of vacuum cleaner.

### 3 Storage

- When you have switched off and unplugged the vacuum cleaner, press the cord reel button to automatically rewind the cord.
- You can store your vacuum cleaner in a vertical position by sliding the hook on the nozzle into the slot on the underside of the vacuum cleaner.

# How to use Using carpet and floor nozzle

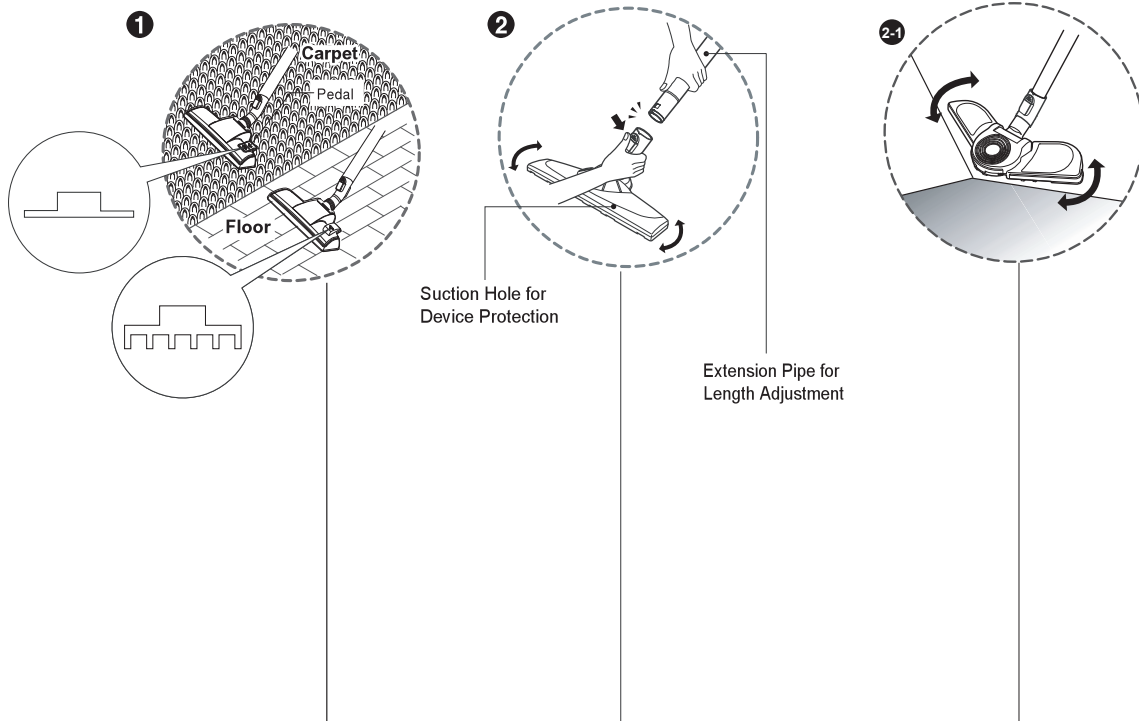

## 1 Carpet and floor nozzle (depend on model)

- **The 2 position nozzle**  
This is equipped with a pedal which allows you to alter its position according to the type of floor to be cleaned.
- **Carpet or rug position**  
Press the pedal to lift the brush up.
- **Hard floor position** (tiles, parquets floor)  
Press the pedal to lower brush.

## 2 Suction Hole for Device Protection (depend on model)

You can perform cleaning at any place like corner or crevice since revolution of the suction hole is free.

## 3 Corner Nozzle

- You can perform cleaning at any place such as corner or narrow crack by utilizing the structure that both sides of the suction hole are leaned back.

# How to use

## USER'S GUIDE FOR SANI PUNCH

Use it as shown in the diagram

Assembling

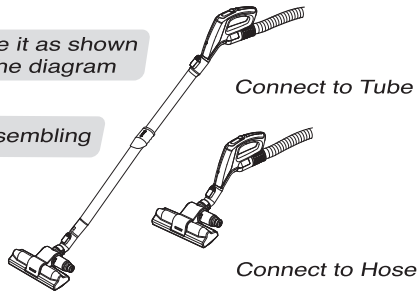

Using the CARPET mode



Effective cleaning

• bed, bedding, heavy blanket

• Light blanket & sheet

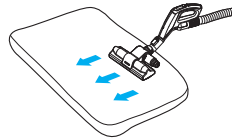
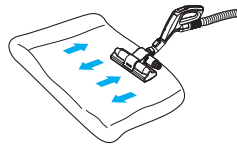

To increase cleaning efficiency for light blankets, lay on top of a bulky blanket and then clean.

### 3 SANI PUNCH(dependent on model)

#### • Cleaning Sani Punch

► The vibrator may break down due to the cleansing of the inhaler with water.

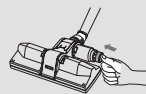

1 If the dust settles in the box while cleaning, press the button 2 or 3 times. (It will remove most of the dust.)

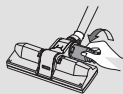

2 After the cleaning, if there are lots of dusts in the box, separate the box from the inhaler by turning it anticlockwise.



3 Empty the box.

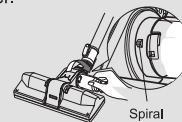

4 Aim at the Spiral, Fix the box into the inhaler by turning it clockwise.

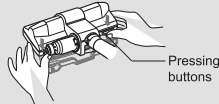

5 Separate the bottom plate by pressing the buttons in the back.

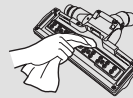

6 Clean the dirty body of the inhaler carefully with a cloth.



7 Wash the separated bottom plate and dry it in the shade.

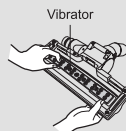

8 Arrange the vibrator in order.



9 Insert the joining spiral into the groove.

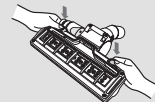

10 Attach the bottom plate properly by pressing down.

# How to use Using accessory nozzles

Upholstery nozzle  
(depending on model)

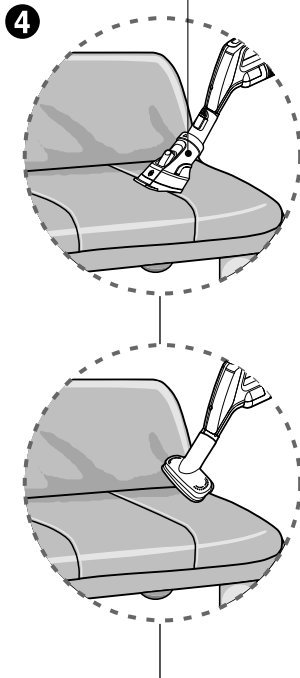

**4** Upholstery nozzle

Upholstery nozzle is for vacuuming upholstery, mattresses etc.

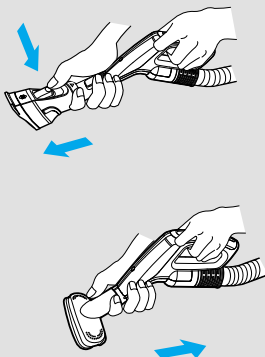

Dusting brush  
(depending on model)

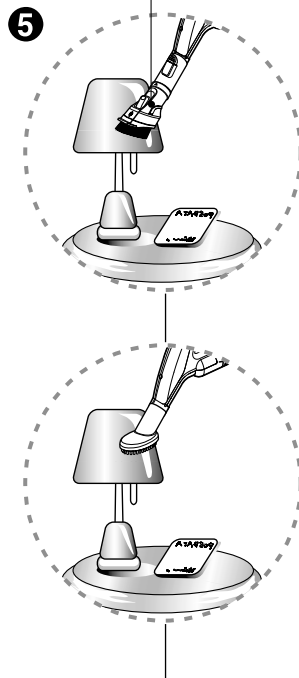

**5** Dusting brush

Dusting brush is for vacuuming picture frames, furniture frames, books and other irregular surfaces.

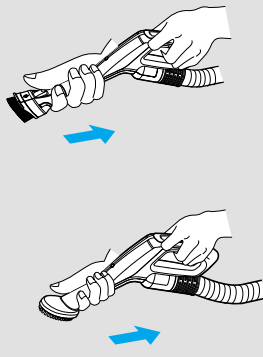

Crevice tool

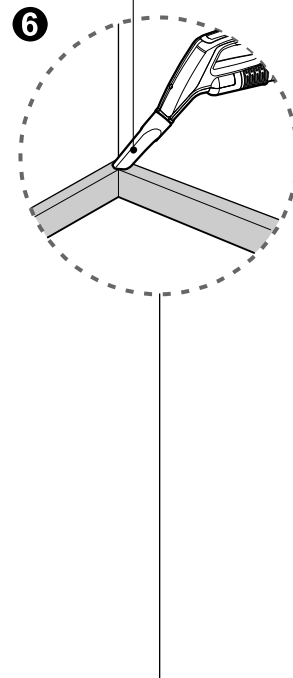

**6** Crevice tool

Crevice tool is for vacuuming in those normally hard-to-reach places such as reaching cobwebs or between the cushions of a sofa.



## NOTICE

Use accessory in the sofa mode



## How to use Emptying dust tank

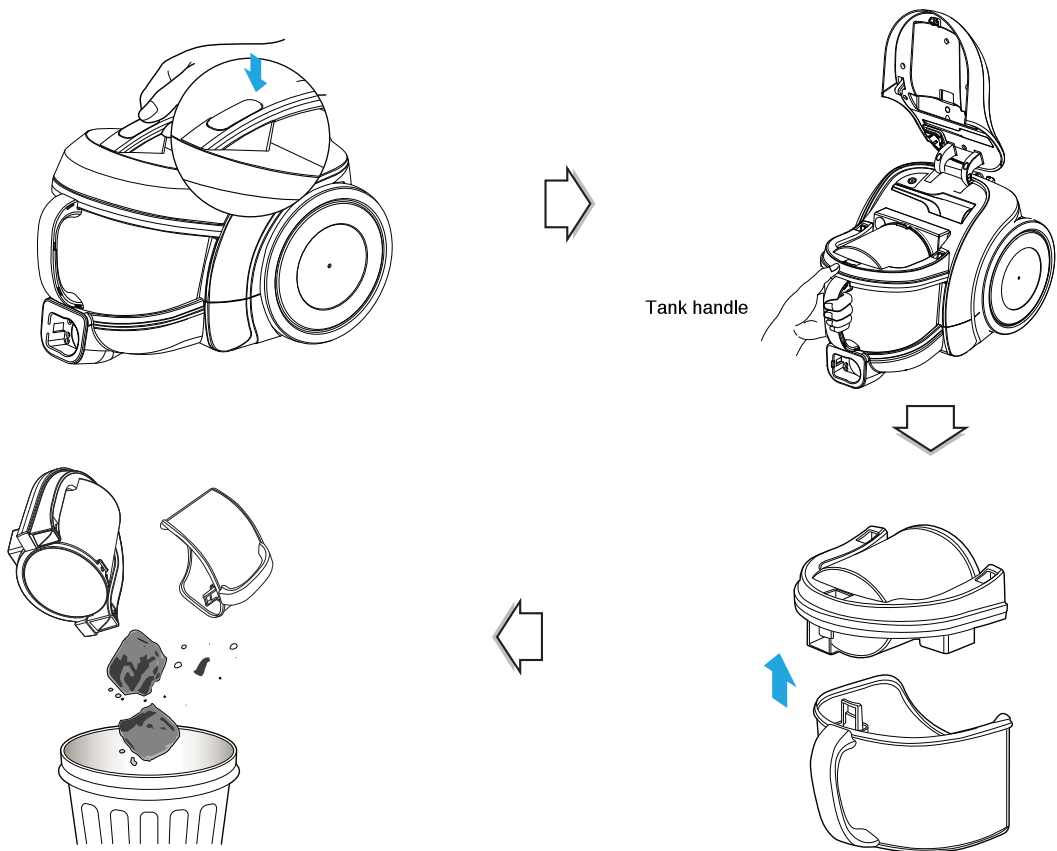

Cleaning the dust " tank".

- Open the tank cap.
  - Wash both parts with soft material.
- Gently rinse both parts under a cold running tap.

### **WARNING!**

Gently rinse both parts separately under a cold running tap until the water runs clear.  
**Do not use detergent or a washing machine or dishwasher.**

**Caution:** Do not push the cover open button when you carry the vacuum cleaner.  
If the cover opens, it is easy to detach the dust tank from the vacuum cleaner.

## How to use Cleaning dust tank

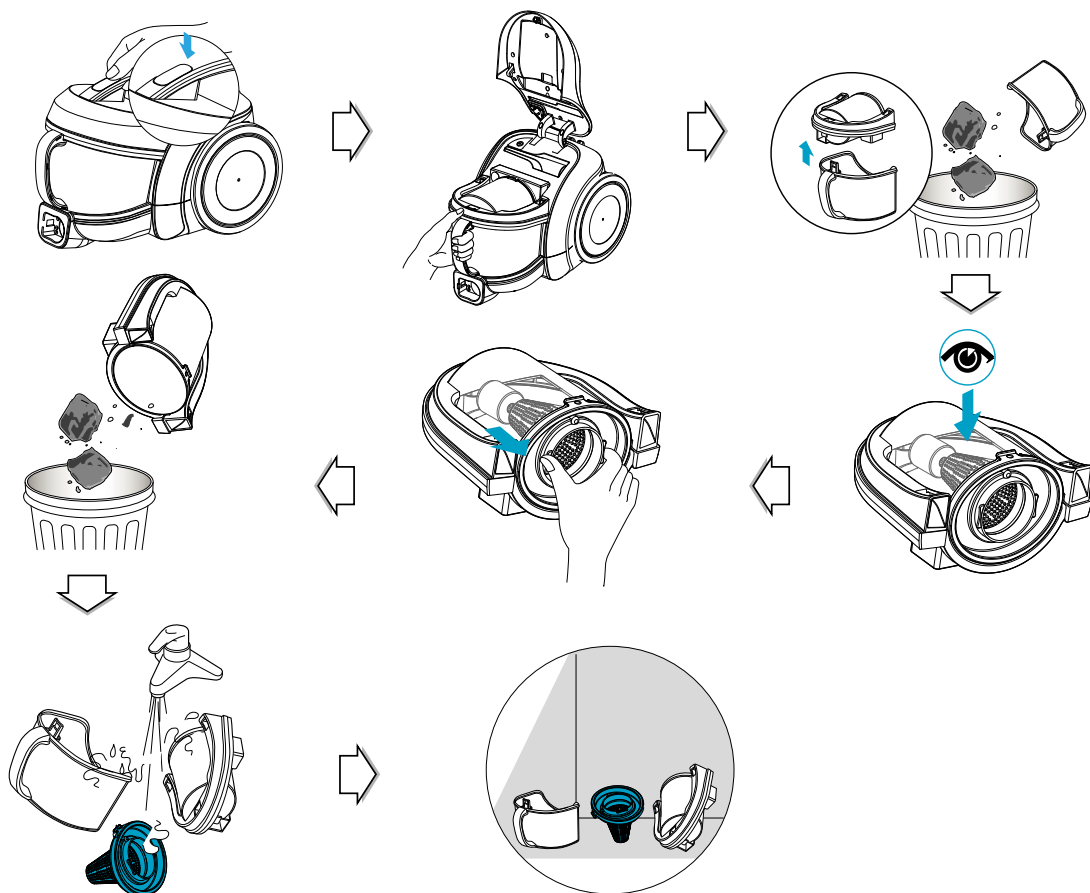

- Open cover with pushing button and pull out dust tank.
- Raise dust tank cap.
- Dry fully in shade so that moisture is entirely removed.

### NOTICE

If suction power decreases after cleaning dust tank, clean air filter and motor safety filter. ➔ Next page

## How to use **Cleaning air filter and motor safety filter**

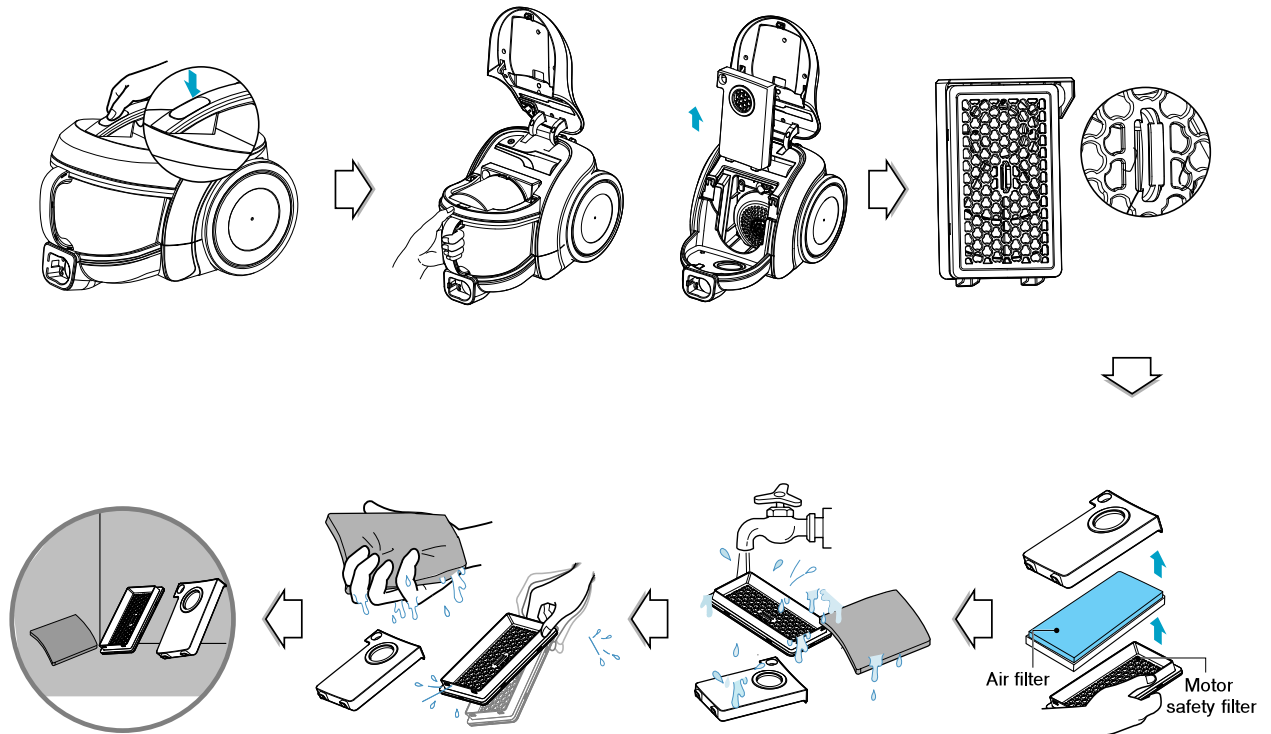

If suction power is decreased after cleaning dust tank, clean air filter and motor safety filter. Air filter and motor safety filter are located at the center of vacuum cleaner in the above figure.

- Open the air filter cover by pulling the air filter cover lever and take out air filter.
- Separate the parts
- Wash air filter and motor safety filter with water.
- Do not wash filters with hot water.
- Dry fully in shade so that moisture is entirely removed.
- Air filter and motor safety filter should be cleaned in the above case.

### NOTICE

If filters are damaged, do not use them.  
In this cases, contact LG Electronics Service Agent.

## How to use Cleaning exhaust filter

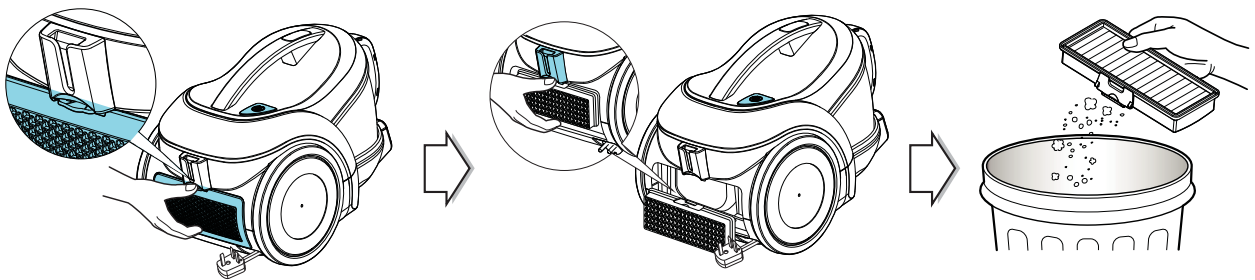

- The exhaust filter is a reusable HEPA filter.
- To change the exhaust filter, remove the filter cover on the body by release hook.
- Pull out the exhaust filter.
- Dust off filter. (Do not wash filter with water.)
- The exhaust filter should be cleaned at least once a year.





## What to do if your vacuum cleaner does not work

Check that the vacuum cleaner is plugged in correctly and that the electrical socket is working.

## What to do when suction performance decreases

- Turn off the vacuum cleaner and unplug it.
- Check the telescopic pipe, flexible hose and cleaning tool for blockages or obstructions.
- Check that the dust tank is not full. Empty if necessary.
- Check that the exhaust filter is not clogged. Clean the exhaust filter if necessary.
- Check that the air filter is not clogged. Clean the air filter if necessary.

# Note



