



## HOME THEATER SYSTEM

**Model : HT534TN (HT534TN-A2, SH54TN-F/S/C/W)  
HT534SN (HT534SN-A2, SH54SN-S/C/W)**

Portable In  
(Go to page 16)

USB Direct Recording  
(Go to page 17)

Before connecting, operating or adjusting this product,  
please read this instruction booklet carefully and completely.

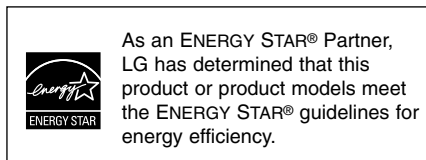

ENERGY STAR® is a U.S. registered mark.



P/NO : MFL61944535

## Safety Precaution



**CAUTION :** TO REDUCE THE RISK OF ELECTRIC SHOCK DO NOT REMOVE COVER (OR BACK) NO USER-SERVICEABLE PARTS INSIDE REFER SERVICING TO QUALIFIED SERVICE PERSONNEL.



This lightning flash with arrowhead symbol within an equilateral triangle is intended to alert the user to the presence of uninsulated dangerous voltage within the product's enclosure that may be of sufficient magnitude to constitute a risk of electric shock to persons.



The exclamation point within an equilateral triangle is intended to alert the user to the presence of important operating and maintenance (servicing) instructions in the literature accompanying the product.

**WARNING :** TO PREVENT FIRE OR ELECTRIC SHOCK HAZARD, DO NOT EXPOSE THIS PRODUCT TO RAIN OR MOISTURE.

**WARNING :** Do not install this equipment in a confined space such as a book case or similar unit.

**CAUTION:** Do not block any ventilation openings. Install in accordance with the manufacturer's instructions.

Slots and openings in the cabinet are provided for ventilation and to ensure reliable operation of the product and to protect it from over heating. The openings should be never be blocked by placing the product on a bed, sofa, rug or other similar surface. This product should not be placed in a built-in installation such as a bookcase or rack unless proper ventilation is provided or the manufacturer's instruction has been adhered to.

**CAUTION :** This product employs a Laser System.

To ensure proper use of this product, please read this owner's manual carefully and retain it for future reference. Should the unit require maintenance, contact an authorized service center.

Use of controls, adjustments or the performance of procedures other than those specified herein may result in hazardous radiation exposure.

To prevent direct exposure to laser beam, do not try to open the enclosure. Visible laser radiation when open. DO NOT STARE INTO BEAM.

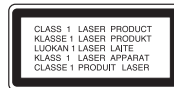

**CAUTION :** The apparatus should not be exposed to water (dripping or splashing) and no objects filled with liquids, such as vases, should be placed on the apparatus.

**CAUTION concerning the Power Cord**

**Most appliances recommend they be placed upon a dedicated circuit ;**

That is, a single outlet circuit which powers only that appliance and has no additional outlets or branch circuits. Check the specification page of this owner's manual to be certain.



Do not overload wall outlets. Overloaded wall outlets, loose or damaged wall outlets, extension cords, frayed power cords, or damaged or cracked wire insulation are dangerous. Any of these conditions could result in electric shock or fire. Periodically examine the cord of your appliance, and if its appearance indicates damage or deterioration, unplug it, discontinue use of the appliance, and have the cord replaced with an exact replacement part by an authorized service center.

Protect the power cord from physical or mechanical abuse, such as being twisted, kinked, pinched, closed in a door, or walked upon. Pay particular attention to plugs, wall outlets, and the point where the cord exits the appliance.

To disconnect power from the mains, pull out the mains cord plug. When installing the product, ensure that the plug is easily accessible.

# Welcome to your new DVD Receiver

## Contents

	Setting up . . . . .	4
	Main Unit . . . . .	5
	Hooking up the unit . . . . .	6-7
	Remote control . . . . .	8
	OSD Initial language settings - Optional . . . . .	9
	Initial Setting the Area Code - Optional . . . . .	9
	Adjusting the general settings . . . . .	9-11
	5.1 Speaker Setup . . . . .	10
	Enjoying a pre-programmed sound field . . . . .	11
	Displaying Disc Information . . . . .	12
	Playing a disc or file . . . . .	12-14
	Viewing photo files . . . . .	14
	Listening to the radio . . . . .	15
	Using an USB device . . . . .	16
	Listening to music from your portable player or external device . . . . .	16
	Recording to USB . . . . .	17
	Language Codes . . . . .	18
	Area Codes . . . . .	18
	Troubleshooting . . . . .	19
	Types of Playable Discs . . . . .	20
	Specifications . . . . .	21

## Setting up

The speakers are detached from the speaker stands.

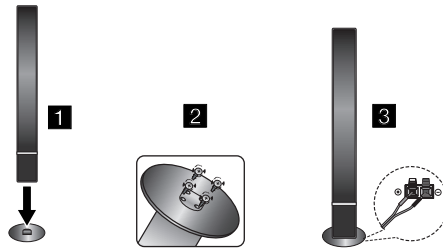

### Assembling the Speakers (HT534TN)

- 1 Set the speaker on the stand.**
- 2 Fix the speaker and the stand by inserting the 4 screws (4 mm) in the speaker hole.**
- 3 Connect the speaker cables to the appropriate terminal on the bottom of the round board.**

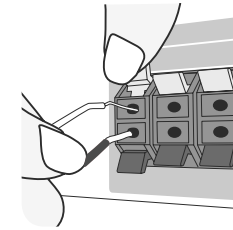

Connect the black end of each wire to the terminals marked -(minus) and the other end to the terminals marked + (plus).

Main Unit	SPEAKER	POSITION
REAR R	R.R	Behind you and to your right.
REAR L	R.L	Behind you and to your left.
CENTER	C	Above screen, directly in front of you.
SUB WOOFER	W	This can be placed in any front position.
FRONT R	F.R	In front of you, to the right of the screen.
FRONT L	F.L	In front of you, to the left of the screen.

## Attaching the speakers to the DVD receiver

- 1 You will have received six speaker cables.**  
Each one is colour-coded by a band near each end and connects one of the six speakers to the DVD receiver.
- 2 Connect the wires to the DVD receiver.**  
To connect the cable to the DVD receiver, press each plastic finger pad to open the connection terminal. Insert the wire and release the finger pad.

### Be careful of the following

- Be careful to make sure children do not put their hands or any objects into the \*speaker duct.
- \*Speaker duct: A holl for plentiful bass sound on speaker cabinet(enclosure).
- Use the rear speaker at least 30 CM away from either TV screen or PC monitor

## Main Unit

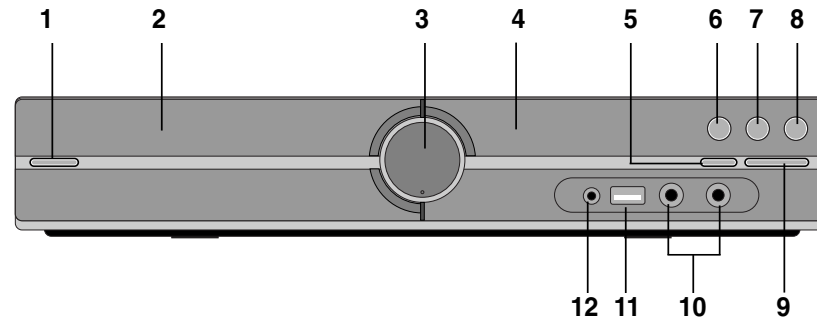

**1 Power (⏻)**

Turns the unit on and off.

**2 DVD/CD Disc Drawer**

**3 Volume (VOL.)**

Controls the volume when using any function.

**4 Display window**

**5 Open/Close (⏮)**

**6 Play/Pause (▶/⏸)**

**7 Stop (■)**

**8 Function (F)**

Selects the function and input source.  
(DVD/CD, USB, AUX, PORTABLE, FM, AM)

**9 TUNING (-/+), (◀▶),  
Skip/Search (press and hold)**

**10 MIC 1/ MIC 2**

Connect a microphone to MIC 1 or MIC 2 to both sockets.

You cannot use the microphone when DivX files playback.

**11 USB port**

You can play video, image and sound files by connecting the USB device.

**12 PORT.(Portable) IN port**

You can enjoy music from portable device on your unit.

## Hooking up the unit

- 1** Connect jacks on the unit and your TV (DVD player or Digital Device etc.) using the cables.  
Check the jacks of your TV, and choose the **A**, **B** or **C** connection. Picture quality improves in order from **A** to **C**.

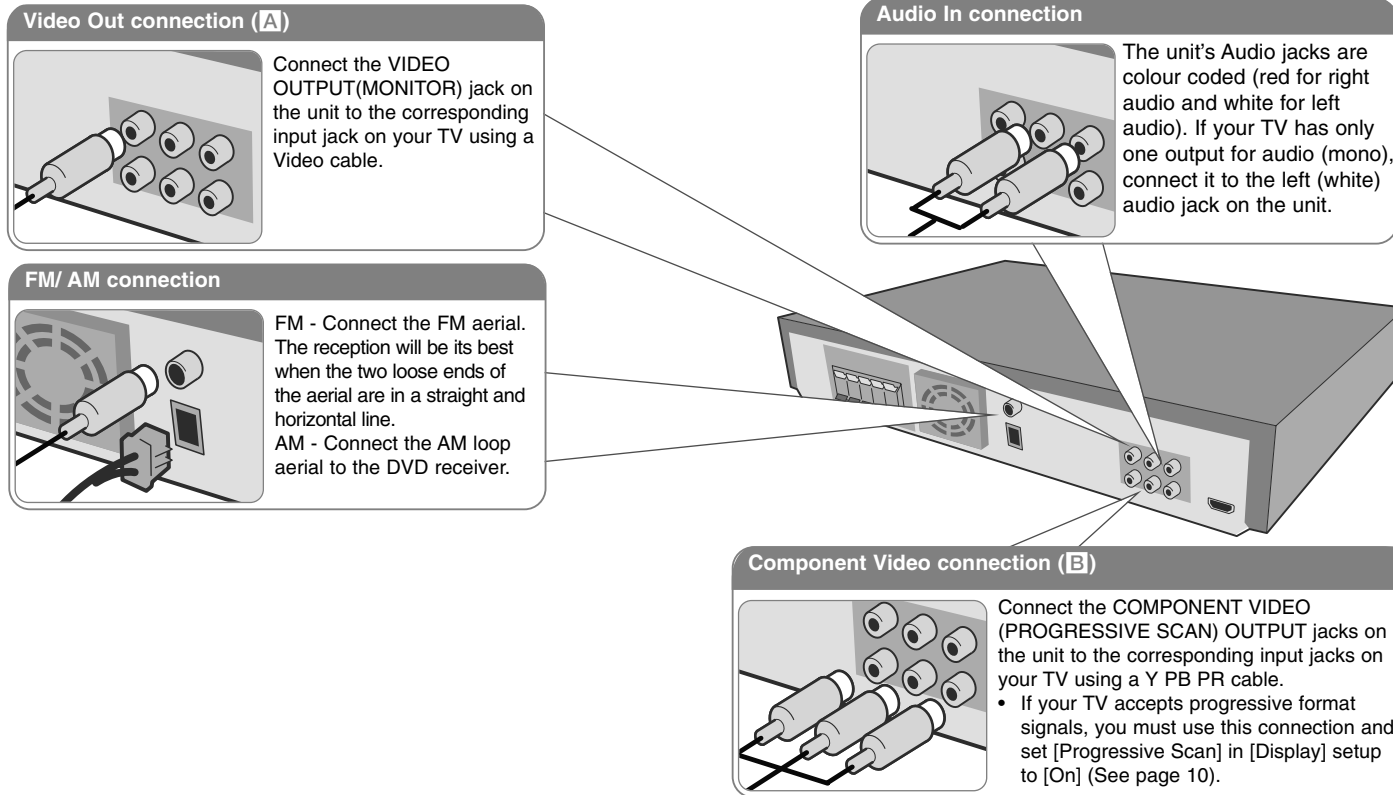

- 2** Plug the power cord into the power source.

## Hooking up the unit

### Resolution Setting

You can change the resolution for component video and HDMI output. Press **RESOLUTION** repeatedly to select the desired resolution - 480i (or 576i), 480p (or 576p), 720p, 1080i, 1080p

The resolution may not be selected depending on the connection or TV.

- Depending on your TV, some of the resolution settings may result in the picture disappearing or an abnormal picture appearing. In this case, press **RESOLUTION** repeatedly until the picture re-appears.

**You can set 1080p video resolution to enjoy Full HD picture quality. (Full HD up-scaling)**

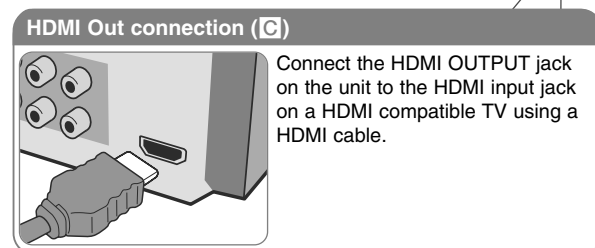

### Enjoying audio from an external source and selecting the function

You can enjoy audio from an external source through your unit. And You can select the function.

Press **FUNCTION** repeatedly to select the desired input source and the function (DVD/CD, USB, AUX, PORTABLE, FM, AM).

### Available resolution according to connection

Displayed resolution in display window and outputted resolution may different according to connection type.

[HDMI OUT] : 1080p, 1080i, 720p and 480p (or 576p), 480i(or 576i)

[COMPONENT VIDEO OUT] : 480p (or 576p) and 480i (or 576i)

[VIDEO OUT] : 480i (or 576i)

### Notes on HDMI Out connection

- If your TV does not accept your resolution setting, abnormal picture appears on the screen. ("TV do not support" will appears in screen)  
Please read owner's manual for TV, and then set the resolution that your TV can accept.
- Changing the resolution when the unit is connected with HDMI connector may result in malfunctions. To solve the problem, turn off the unit and then turn it on again.
- When you connect a HDMI or DVI compatible device make sure of the following :
  - Try switching off the HDMI/ DVI device and this unit. Next, switch on the HDMI/ DVI device and leave it for around 30 seconds, then switch on this unit.
  - The connected device's video input is set correctly for this unit.
  - The connected device is compatible with 720X576i(480i), 720X576p(480p), 1280X720p, 1920X1080i or 1920X1080p video input.
  - The 1080p, 720p and 576p(480p) resolutions are the progressive scan applied resolution.
- Not all HDCP-compatible DVI devices will work with this unit.
  - The picture will not be displayed properly with non-HDCP device.

## Remote control

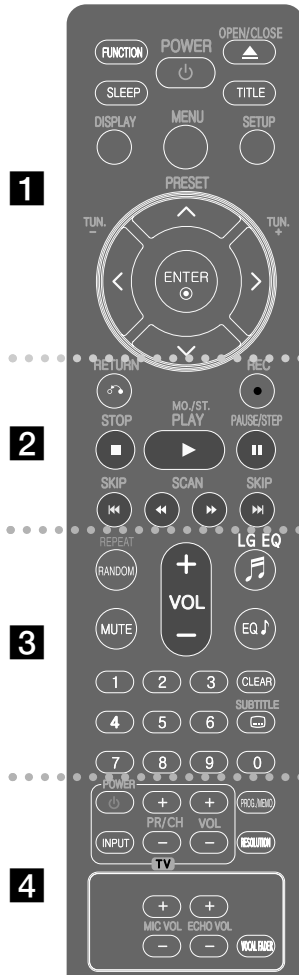

**1**

**FUNCTION** : Selects the function and input source. (DVD/CD, USB, AUX, PORTABLE, FM, AM)  
**SLEEP** : Sets the System to turn off automatically at a specified time. (Dimmer : Dims the LED (Light-emitting diode) of front panel by half in power-on status.)  
**POWER** : Switches the unit ON or OFF.  
**OPEN/CLOSE** : Opens and closes the disc Drawer.  
**TITLE** : If the current DVD title has a menu, the title menu appears on the screen. Otherwise, the disc menu may not appear.  
**DISPLAY** : Accesses On-Screen Display.  
**MENU** : Accesses the menu on a DVD disc.  
**SETUP** : Accesses or removes setup menu.  
**PRESET** (Λ V) : Selects programme of Radio.  
**TUN.** (-/+): Tunes in the desired radio station.  
**Λ V < > (up/ down/ left/ right)**: Used to navigate on-screen displays.  
**ENTER** : Acknowledges menu selection.

**2**

**RETURN** (↶) : moves backwards in the menu or exits the setup menu.  
**REC** (●) : USB Direct Recording.  
**STOP** (■) : Stops playback or recording.  
**PLAY** (▶), **MO./ST.** : Starts playback. Selects Mono/ Stereo  
**PAUSE/STEP** (⏸) : Pause playback.  
**SKIP** (⏮ / ⏭) : Go to next or previous chapter/ track/ file.  
**SCAN** (◀▶) : Search backward or forward.

### Put the battery into the remote control

Make sure for the + (plus) and - (minus) on the battery to be matched on the remote control.

**3**

**REPEAT/RANDOM** : To select a play mode. (Random, repeat)  
**MUTE** : To mute the sound.  
**VOL (Volume) (+/-)** : Adjusts speaker volume.  
**LGEQ** : You can select a Natural or Local Specialization equalizer effect by using LG EQ.  
**EQ (EQUALIZER effect)** : You can choose sound impressions.  
**CLEAR** : Removes a track number on the Program List.  
**SUBTITLE** : During playback, press SUBTITLE repeatedly to select a desired subtitle language .  
**0-9 numerical buttons** : Selects numbered options in a menu.

**4**

**TV Control buttons** : Controls the TV. (LG TV only)

**Controlling the TV.**  
 You can control the sound level, input source, and power switching of LG TVs as well. Hold **POWER** (TV) and press **PR/CH** (+/-) button repeatedly until the TV turns on or off.

**PROG./MEMO.** : Accesses or removes Program menu.  
**RESOLUTION** : Sets the output resolution for HDMI and COMPONENT VIDEO OUT jacks.  
**ECHO VOL.** : Adjusts echo volume.  
**MIC VOL.** : Adjusts microphone volume.  
**VOCAL FADER** : You can enjoy the function as karaoke, by reducing singer vocal of music in the various source.



### OSD Initial language settings - Optional

During the first use of this unit, the initial language setup menu appears on your TV screen. You must complete initial language selection before using the unit. English will be selected as the initial language.

	ON REMOTE
<b>1 Turn the power on</b> The language list appears	<b>POWER</b>
<b>2 Select the language</b>	<b>^ V &lt; &gt;</b>
<b>3 Press</b>	<b>ENTER</b>
<b>4 To confirm press</b>	<b>&lt; &gt; and ENTER</b>

### Initial Setting the Area Code - Optional

When you use this unit for the first time, you have to set the Area Code as shown below.

	ON REMOTE
<b>1 Display setup menu</b>	<b>SETUP</b>
<b>2 Select LOCK menu on the first level</b>	<b>^ V</b>
<b>3 Move to second level</b> The activated Area Code appears on the second level.	<b>&gt;</b>
<b>4 Move to the third level</b>	<b>&gt;</b>
<b>5 Enter a new password</b>	<b>numerical buttons (0-9) and ENTER</b>
<b>6 Recheck the entered new password</b>	<b>numerical buttons (0-9) and ENTER</b>
<b>7 Select a code for a geographic area</b> After select, Rating and Password will be activated. (page 18)	<b>^ V &lt; and ENTER</b>
<b>8 To confirm what you press</b> Make sure to finish setting the Area Code before leaving the setup menu if you cannot set the rating and Password	<b>ENTER</b>

### Adjusting the general settings

	ON REMOTE
<b>1 Display setup menu</b>	<b>SETUP</b>
<b>2 Select a desired option on the first level</b>	<b>^ V</b>
<b>3 Move to the second level</b>	<b>&gt;</b>
<b>4 Select a desired option on the second level</b>	<b>^ V</b>
<b>5 Move to the third level</b>	<b>&gt;</b>
<b>6 Change the setting</b>	<b>^ V, ENTER</b>

### Adjusting the general settings - more you can do

#### Adjusting the language settings

**Menu Language** – Select a language for the Setup menu and on-screen display.

**Disc Audio/ Disc Subtitle/ Disc Menu** – Select a language for the Disc Audio/ Disc Subtitle/ Disc Menu.

[Original] : Refers to the original language in which the disc was recorded.

[Other] : To select another language, press number buttons then **ENTER** to enter the corresponding 4-digit number according to the language code list in the reference chapter (see page 18). If you make a mistake before pressing **ENTER**, press **CLEAR**.

[Off] (for Disc Subtitle) : Turn off Subtitle.

### Adjusting the display settings

**TV Aspect** – Select which screen aspect to use based on the shape of your TV screen.

- [4:3] : Select when a standard 4:3 TV is connected.
- [16:9] : Select when a 16:9 wide TV is connected.

**Display Mode** – If you selected 4:3, you'll need to define how you would like wide screen programs and films to be displayed on your TV screen.

- [Letterbox] : This displays a wide screen picture with black bands at the top and bottom of the screen.
- [Panscan] : This fills the entire 4:3 screen, cropping the picture as necessary.

**Progressive Scan (For Component Video connections)** – Selects whether the COMPONENT/PROGRESSIVE SCAN OUTPUT jacks output progressive signal. If your TV accepts progressive format signals, you will enjoy accurate color reproduction and high quality image by selecting [On]. If your TV does not accept progressive format signals, select [Off].

If you set Progressive Scan to [On] in error, you must reset the unit. First, remove the disc in the unit. Next, press and hold STOP for five seconds. The video output will be restored to the standard setting, and a picture will be visible on your TV.

### Adjusting the audio settings

**DRC (Dynamic Range Control)** – Make the sound clear when the volume is turned down (Dolby Digital only). Set to [On] for this effect.

**Vocal** – Select [On] to mix karaoke channels into normal stereo. This function is effective for multi-channel karaoke DVDs only.

**Semi Karaoke** – When a chapter/ title/ track is fully finished, this function shows the score in the screen with a fanfare sound.

Available discs for the Semi Karaoke function: DVD discs/ DVD Karaoke Discs

[On] : When you finished singing a score will appear on the screen.

[Off] : Fanfare and score do not appears on the screen.

- This function operate on the DVD/CD mode.
- The Semi Karaoke function is available only when a microphone is connected.
- In case that a fanfare or score appears when a chapter of a movie file is changed during playback, set the Semi Karaoke to "Off" at the setup menu or disconnect the microphone.

## 5.1 Speaker Setup

	ON REMOTE
<b>1 Open the settings menu</b>	<b>SETUP</b>
<b>2 Select to the audio icon</b>	<b>^ V</b>
<b>3 Select right to enter the audio menu, then select 5.1 Speaker Setup</b>	<b>&gt; ^ V ENTER</b>
<b>4 Select the speaker you want to adjust</b>	<b>&lt; &gt;</b>
	
<b>5 Select a option and change the settings</b>	<b>^ V &lt; &gt;</b>
<b>6 Set the output level (volume) of a speaker</b> from -5dB to +5dB. The speaker size setting are fixed, so you cannot change the setting.	<b>&lt; &gt;</b>
<b>7 If you connect speakers to your unit, setting the Distance lets the speakers to know how far the sound has to travel to reach your set listening point. This allows the sound from each speaker to reach the listener at the same time.</b>	<b>&lt; &gt;</b>
<b>8 Test the signals of each speaker</b> Adjust the volume to your taste according to these signals.	<b>&lt; &gt;</b>
<b>9 Save your settings and exit the Setup menu</b>	<b>RETURN</b>

### Adjusting the lock settings

To access the lock options, you must enter the 4-digit password. If you have not yet entered a password you are prompted to do so. Enter a 4-digit password then press **ENTER**. Enter it again then press **ENTER** to verify. If you make a mistake while entering number, press **CLEAR** then correct it.

If you forget your password you can reset it. First, remove the disc in the unit. Press **SETUP** to display the Setup menu. Input '210499' and press **ENTER**. The password has now been cleared.

**Rating** – Select a rating level. The lower the level, the stricter the rating. Select [Unlock] to deactivate the rating.

**Password** – Sets or changes the password for lock settings.

[New] : Enter a new 4-digit password using the numerical buttons then press **ENTER**. Enter the password again to confirm.

[Change] : Enter the new password twice after entering the current password.

**Area Code** – Select a code for a geographic area as the playback rating level. This determines which area's standards are used to rate DVDs controlled by the parental lock. See the Area Codes on page 18.

### Adjusting the others settings

**DivX(R) VOD** – We provide you with the DivX® VOD (Video On Demand) registration code that allows you to rent and purchase videos using the DivX® VOD service.

For more information, visit [www.divx.com/vod](http://www.divx.com/vod).

Press **ENTER** when [DivX(R) VOD] is highlighted and you can view the registration code of the unit.

### Enjoying a pre-programmed sound field

This system has a number of pre-set surround sound fields. You can select a desired sound mode by using **EQ/ LG EQ**. You can change the **EQ/ LG EQ** using **< >** arrow key while the **EQ/ LG EQ** information is displayed on. The displayed items for the Equalizer may be different depending on sound sources and effects. If you connected mic, equalizer is not available.





ON DISPLAY	Description
NATURAL	You can enjoy comfortable and natural sound.
Local Specialization equalizer	Regionally optimized sound effect.(DANGDUT/ ARABIC/ PERSIAN/ INDIA/ REGUETON/ MERENGUE/ SALSA/ SAMBA)
AUTO EQ	Realizes the sound equalizer that is the most similar to the genre of which is included in the MP3 ID3 tag of song files.
POP CLASSIC JAZZ ROCK	This program lends an enthusiastic atmosphere to the sound, giving you the feeling you are at an actual rock pop, jazz or classic concert.
MP3 OPT	This function is optimized for compressible MP3 file. It improves the bass sound.
BASS	Reinforce the treble, bass and surround sound effect.
VIRTUAL	You can enjoy more virtual surround sound.
PLII MOVIE PLII MUSIC PLII MTRX(matrix)	Dolby Pro Logic II enables you to play stereo source on 5.1-channel.
NORMAL(OFF)	You can enjoy the sound without equalizer effect.

## Displaying Disc Information

	ON REMOTE
1 Press DISPLAY	DISPLAY
2 Select an item	▲ ▼
3 Adjust the Display menu settings	< >
4 To return the exit	DISPLAY

### Displaying Disc Information - more you can do

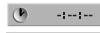
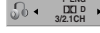
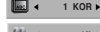
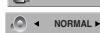
You can select an item by pressing ▲ ▼ and change or select the setting by pressing < >.

	Current title (or track/ file) number/ total number of titles (or tracks/ files)
	Current chapter number/ total number of chapters
	Elapsed playing time
	Selected audio language or channel
	Selected subtitle
	Selected angle/ total number of angles
	Selected sound mode

### Symbol Used in this Manual

All discs and file listed below	<b>ALL</b>	MP3 files	<b>MP3</b>
DVD and finalized DVD±R/RW	<b>DVD</b>	WMA files	<b>WMA</b>
DivX files	<b>DivX</b>	Audio CDs	<b>ACD</b>

## Playing a Disc or file

	ON REMOTE
1 Insert a disc on unit	▲ OPEN/CLOSE
2 Select a DVD/CD	FUNCTION
3 Adjust the menu settings or Select a file from the menu	▲ ▼ < > ▲ ▼
4 Start the Disc playing	▶ PLAY
5 To stop the Disc playing	■ STOP

### Playing a Disc or file - more you can do

#### Playing a DVD that has a menu **DVD**

Most DVDs now have menus which load first before the film begins to play. You can navigate these menu using ▲ ▼ < > to highlight an option. Press **PLAY** (▶) to select.

#### Skipping to the next/ previous chapter/ track/ file **ALL**

Press **SKIP** (▶▶) to move to the next chapter/ track/ file.  
Press **SKIP** (◀◀) to return to the beginning of the current chapter/ track/ file.  
Press **SKIP** (◀◀) twice briefly to step back to the previous chapter/ track/ file.

#### Pausing playback **ALL**

Press **PAUSE/STEP** (||) to pause playback. Press **PLAY** (▶) to continue playback.

#### Frame-by-Frame playback **DVD** **DivX**

Press **PAUSE/STEP** (||) repeatedly to play title Frame-by-Frame.

#### Playing repeatedly or randomly **ALL**

Press **REPEAT/RANDOM** repeatedly, and the current title, chapter or track will be played back repeatedly or randomly. To return to normal playback, press **REPEAT/RANDOM** repeatedly.

- Random play mode : only music files.

**Fast forward or fast reverse** **ALL**

Press **SCAN** (◀◀ or ▶▶) to play fast forward or fast reverse during playback. You can change the playback speed by pressing **SCAN** (◀◀ or ▶▶) repeatedly. Press **PLAY** (▶) to continue play at normal speed.

**Selecting a subtitle language** **DVD** **DivX**

During playback, press **SUBTITLE** (□) repeatedly to select a desired subtitle language.

**Slow down the playing speed** **DVD** **DivX**

While playback is paused, press **SCAN** (◀◀ or ▶▶) to slow down forward or reverse playback. You can change the various playback speed by pressing **SCAN** (◀◀ or ▶▶) repeatedly. Press **PLAY** (▶) to continue play at normal speed. The DivX file cannot be slow down reverse playback.

**1.5 times faster playback** **DVD**

Press **PLAY** (▶) when a DVD is already playing to watch and listen to a DVD 1.5 times faster than normal playback speed. "▶ x1.5" will appear in the screen. Press **PLAY** (▶) again to return to normal playback speed. If you insert the microphone during "x1.5" speed playback, it returns to the normal play mode. This function is not operated when the microphone is connected to the unit.

**Viewing the Title menu** **DVD**

Press **TITLE** to display the disc's title menu, if available.

**Starting play from selected time** **DVD** **DivX**

Searches for the starting point of entered time code. Press **DISPLAY** then select clock icon. Enter a time then press **ENTER**. For example, to find a scene at 1 hour, 10 minutes, and 20 seconds, enter "11020" by using numerical buttons and press **ENTER**. If you enter the wrong number, press **CLEAR** to enter again.

**Last Scene Memory** **DVD**

This unit memorizes the last scene from the last disc that is viewed. The last scene remains in memory even if you remove the disc from the player or switch off (Stand-by mode) the unit. If you load a disc that has the scene memorized, the scene is automatically recalled.

**Mixed disc or USB Flash Drive – DivX, MP3/ WMA and JPEG**

When playing a disc or USB Flash Drive containing with DivX, MP3/ WMA and JPEG files together, you can select menu of files which you would like to play by pressing **MENU**. If "This file has non-supported type on the player" pops up, select an appropriate file by pressing **MENU**.

**Viewing the DVD MENU** **DVD**

Press **MENU** to display the disc menu, if available.

**Changing the character set to display DivX® subtitle correctly** **DivX**

If the subtitle does not display properly during playback, press and hold **SUBTITLE** for about 3 seconds then press < > or **SUBTITLE** to select another language code until the subtitle is displayed properly and then press **ENTER**.

**DivX file requirement** **DivX**

**DivX disc compatibility with this player is limited as follows :**

- Available resolution: within 720x576 (W x H) pixels
- The file name of the DivX subtitle should be entered within 45 characters.
- If there is impossible code to express in the DivX file, it may be displayed as " \_ " mark on the display.
- Frame rate : less than 30 fps
- If the video and audio structure of recorded files is not interleaved, either video or audio is outputted.
- Playable DivX file : ".avi", ".mpg", ".mpeg", ".divx"
- Playable Subtitle format : SubRip (\*.srt/ \*.txt), SAMI (\*.smi), SubStation Alpha (\*.ssa/ \*.txt), MicroDVD (\*.sub/ \*.txt), SubViewer 2.0 (\*.sub/ \*.txt)
- Playable Codec format : "DIVX3.xx", "DIVX4.xx", "DIVX5.xx", "MP4V3", "3IVX".
- Playable Audio format : "AC3", "PCM", "MP3", "WMA".
- Sampling frequency : within 32 - 48 kHz (MP3), within 32 - 48kHz (WMA)
- Bit rate: within 32 - 320kb/s (MP3), 40 - 192kb/s (WMA)
- For Discs formatted in Live file system, you can not it on this player.
- If the name of movie file is different from that of the subtitle file, during playback of a DivX file, subtitle may not be display.
- If you play a DivX file differ from DivX spec, it may not operate normally.

**Fall asleep while listening to your player**

Press **SLEEP** one or more times to select delay time between 10 and 180 minutes, after the player will turn off.

To check the remaining time, press **SLEEP**. To cancel the sleep function, press **SLEEP** repeatedly until "SLEEP 10" appears, and then press **SLEEP** once again while "SLEEP 10" is displayed.

**DIMMER**

Press **SLEEP** once. The LED (Light-emitting diode) of front panel is turned off and the display window will be darkened by half. To cancel it, press **SLEEP** repeatedly until dim off.

### Creating your own program **ACD** **MP3** **WMA**

You can play the contents of a disc in the order you want by arranging the order of the musics on the disc. To add a music(s) on the program list, press **PROG./MEMO.** to enter the program edit mode (Ⓜ mark appears on the menu). Select a desired music on the [List] by using the **▲ ▼** then press **ENTER** to add the music to the program list. Select music from the program list then press **ENTER** to start programmed playback. To clear a music from the program list, select the music you want to clear by using the **▲ ▼** then press **CLEAR** in program edit mode. To clear all music from the program list, select [Clear All] then press **ENTER** in program edit mode. The program is cleared when the disc is removed or the unit is turned off.

### Displaying file information (ID3 TAG) **MP3**

While playing an MP3 file containing file information, you can display the information by pressing **DISPLAY** repeatedly.

### MP3/ WMA music file requirement

MP3/ WMA disc compatibility with this player is limited as follows :

- Sampling frequency : within 32 - 48 kHz (MP3), within 32 - 48kHz (WMA)
- Bit rate : within 32 - 320kb/s (MP3), 40 - 192kb/s (WMA)
- Support Version : v2, v7, v8, v9
- Maximum files : Under 999.
- File extensions : “.mp3”/ “.wma”
- CD-ROM file format : ISO9660/ JOLIET
- We recommend that you use Easy-CD Creator, which creates an ISO 9660 file system.

### Screen Saver

The screen saver appears when you leave the unit in Stop mode for about five minutes.

### System Select - Optional

You must select the appropriate system mode for your TV system. If “NO DISC” appears in the display window, press and hold **PAUSE/STEP (||)** for more than five seconds to be able to select a system. (**AUTO/ PAL/ NTSC**)

### VOCAL FADER

You can enjoy the function as karaoke, by reducing singer vocal of music in the various source. (MP3/ WMA/ CD) Press the **VOCAL FADER**, and “FADE ON” will appear in display window.

To cancel it, press **VOCAL FADER** again.

- This function is available to use only when a microphone is connected.
- The quality of the **VOCAL FADER** may be different depending on the recording conditions of music files.
- It is not available on the MONO source.

## Viewing photo files

	ON REMOTE
1 Insert a disc on unit	▲ OPEN/CLOSE
2 Select a DVD/CD	FUNCTION
3 Select a photo file	▲ ▼
4 Display the selected file in full screen	▶ PLAY
5 To return to the menu	■ STOP

## Viewing photo files - more you can do

### Viewing photo files as a slide show

Use **▲ ▼ < >** to highlight (🖼) icon then press **PLAY (▶)** to start slide Show.

You can change slide show speed using **< >** when (🖼) icon is highlighted.

Depending on the size and resolution of JPEG files, it may take longer for slider show to be set.

### Skipping to the next/ previous photo

Press **SKIP (◀◀ or ▶▶)** or **< >** to view the previous/ next photo.

### Rotating a photo

Use **▲ ▼** to rotate the photo in full screen counterclockwise or clockwise while viewing a photo in full screen.

### Pausing a slide show

Press **PAUSE/STEP (||)** to pause a slide show. Press **PLAY (▶)** or **PAUSE/STEP (||)** to continue the slide show.

### Listening to music during slide show

You can listen to music during slide show, if the disc contain music and photo files together. Use **▲ ▼ < >** to highlight (🎵🖼) icon then press **PLAY (▶)** to start slide show. This function is available only in disc.

### Photo file requirement

JPEG disc compatibility with this player is limited as follows :

- Max pixel in width : 2760 x 2048 pixel
- Maximum files : Under 999.
- Some discs may not operate due to a different recording format or the condition of disc.
- File extensions: “.jpg”
- CD-ROM file format : ISO9660/ JOLIET

## Listening to the radio

Be sure that both FM and AM aerials are connected.

	ON REMOTE
<b>1 Turn the power on</b>	<b>POWER</b>
<b>2 Select either FM or AM</b>	<b>FUNCTION</b>
<b>3 Select a radio station</b>	<b>TUN.-/+</b>
<b>4 To 'save' a radio station</b> A preset number will show in the display.	<b>PROG./MEMO.</b>
<b>5 Select the preset number</b> Up to 50 radio stations can be saved.	<b>PRESET ^ V</b>
<b>6 To confirm press</b>	<b>PROG./MEMO.</b>
<b>7 To select a 'saved' station input the preset number</b>	<b>PRESET ^ V</b>

## Listening to the radio - more you can do

### Looking for radio stations automatically

Press and hold **TUN.-/TUN.+** for more than a second. The tuner will scan automatically and stop when it finds a radio station.

### Deleting all the saved stations

Press and hold **PROG./MEMO.** for two seconds. ERASE ALL will flash up on the DVD receiver display. Press **PROG./MEMO.** to erase all saved radio stations.

### Improving poor FM reception

Press **PLAY (▶) (MO./ST.)** on the remote control. This will change the tuner from stereo to mono and usually improve the reception.

## Using an USB device

You can enjoy media files saved on an USB device by connecting the USB device to the USB port of the unit.  
If you want to operate other function, see the CD playback section.

	ON REMOTE
<b>1 Connect the USB device to the USB port of the unit.</b>	-
<b>2 Select the USB function</b>	<b>FUNCTION</b>
<b>3 Select a file you want to play</b>	<b>^ V</b>
<b>4 Start your media playing</b>	<b>▶ PLAY</b>
<b>5 To stop, press</b>	<b>■ STOP</b>
<b>6 Before disconnecting the portable USB device, change to any other function.</b>	<b>FUNCTION</b>

### Compatible USB Devices

- MP3 Player : Flash type MP3 player.
- USB Flash Drive : Devices that support USB2.0 or USB1.1.
- The USB function may not be available depending on device.

### USB device requirement

- Devices which require additional program installation when you have connected it to a computer, are not supported.

### Look out for the follows

- **Do not extract the USB device while in operation.**
- For a large capacity USB, it may take longer than a few minute to be searched
- To prevent data loss, back up all data.
- If you use a USB extension cable or USB hub, the USB device is not recognized.
- Using NTFS file system is not supported. (Only FAT(16/32) file system is supported.)
- This unit is not supported when the total number of files is 1 000 or more.
- External HDD, Card readers, Locked devices, or hard type usb devices are not supported.
- USB port of the unit cannot be connected to PC. The unit can not be used as a storage device.

## Listening to music from your portable player or external device

The unit can be used to play the music from many types of portable player or external device.

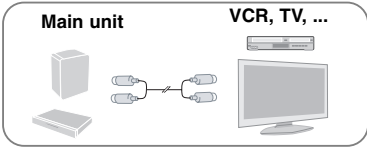
	ON REMOTE
<p><b>1 Connect the portable player to the PORT. IN(PORTABLE IN) connector of the unit.</b></p>  <p style="text-align: center;">Or</p> <p><b>Connect</b> the external device to the <b>AUX</b> connector of the unit. &gt; If your TV has only one output for audio(MONO), connect it to the left(white) audio jack on the unit.</p> 	
<b>2 Turn the power on</b>	<b>POWER</b>
<b>3 Select the PORTABLE or AUX function</b>	<b>FUNCTION</b>
<b>4 Turn the portable external device and start it playing</b>	-



Recording to USB	
	ON REMOTE
<b>1 Connect the USB device to the unit</b>	-
<b>2 Select a mode in which you want to record</b> (ex. CD/ TUNER....) Play back a sound source first If you want to record desired music file in Disc to USB, record after playing back the file.	<b>FUNCTION</b>
<b>3 Start the recording</b>	● <b>REC</b>
<b>4 To stop recording, press</b>	■ <b>STOP</b>

## Recording to USB - more you can do

### Recording Music file in disc source to USB

#### One track recording

If the USB recording is started during playback of the CD, the one track/ file would be recording into the USB.

#### All tracks recording

If the recording button is pressed at the CD stop, all tracks/ files would be recording.

- The files in the sub-folders are not recorded during all track recording.
- If you want to all tracks recording during playback, press stop twice. check the "■" on the screen.

#### Program list recording

USB records after creating your own program if you want to record the track you want (AUDIO CD Only).

### When you are recording, look out for the following

- You can check the recording percentage rate for the USB record on the screen during the recording.(AUDIO, MP3/ WMA CD only)
- During recording MP3/ WMA, there is no sound.
- When you stop recording during playback, the file that has been recorded at that time will be stored.(AUDIO CD Only)
- Do not remove the USB device or turn off the unit during USB recording. If not, an incomplete file may be made and not deleted on PC.
- Recording through microphones is not available.
- If USB recording does not work, the message like "NO USB", "ERROR", "USB FULL" or "NO REC" is displayed on the display window.
- Multi card reader device or External HDD can not be used for USB recording.
- A file is recorded by 128Mbyte when you record for a long term.
- when you stop recording during playback, the file will not be stored.
- In the state CD-G, DTS disc USB record is not operated.
- You may not record more than 999files.
- The numbering of the recording file is entered from the lowest number. So if you delete some of the recording files, the next recording file could be the lowest number among them.
- **It'll be stored as follows.**

AUDIO CD	MP3/ WMA	The other sources (Tuner, AUX, Portable, etc)
<pre> ■ CD_REC ├── TRK_001 ├── TRK_002 ├── ... └── ...                     </pre>	<pre> ■ FILE_REC ├── 001_ABC(File name) ├── 002_DEF(File name) ├── ... └── ...                     </pre>	<pre> ■ EXT_REC ├── AUDIO_001 ├── AUDIO_002 ├── ... └── ...                     </pre>

The making of unauthorized copies of copy-protected material, including computer programs, files, broadcasts and sound recordings, may be an infringement of copyrights and constitute a criminal offense. This equipment should not be used for such purposes.

**Be responsible  
Respect copyrights**

## Language Codes

Use this list to input your desired language for the following initial settings: Disc Audio, Disc Subtitle, Disc Menu.

Language	Code	Language	Code	Language	Code	Language	Code	Language	Code	Language	Code
Afar	6565	Croatian	7282	Hausa	7265	Lingala	7678	Quechua	8185	Tajik	8471
Afrikaans	6570	Czech	6783	Hebrew	7387	Lithuanian	7684	Rhaeto-Romance	8277	Tamil	8465
Albanian	8381	Danish	6865	Hindi	7273	Macedonian	7775	Rumanian	8279	Telugu	8469
Ameharic	6577	Dutch	7876	Hungarian	7285	Malagasy	7771	Russian	8285	Thai	8472
Arabic	6582	English	6978	Icelandic	7383	Malay	7783	Samoan	8377	Tonga	8479
Armenian	7289	Esperanto	6979	Indonesian	7378	Malayalam	7776	Sanskrit	8365	Turkish	8482
Assamese	6583	Estonian	6984	Interlingua	7365	Maori	7773	Scots Gaelic	7168	Turkmen	8475
Aymara	6588	Faroese	7079	Irish	7165	Marathi	7782	Serbian	8382	Twi	8487
Azerbaijani	6590	Fiji	7074	Italian	7384	Moldavian	7779	Serbo-Croatian	8372	Ukrainian	8575
Bashkir	6665	Finnish	7073	Japanese	7465	Mongolian	7778	Shona	8378	Urdu	8582
Basque	6985	French	7082	Kannada	7578	Nauru	7865	Sindhi	8368	Uzbek	8590
Bengali; Bangla	6678	Frisian	7089	Kashmiri	7583	Nepali	7869	Singhalese	8373	Vietnamese	8673
Bhutani	6890	Galician	7176	Kazakh	7575	Norwegian	7879	Slovak	8375	Volapük	8679
Bihari	6672	Georgian	7565	Kirghiz	7589	Oriya	7982	Slovenian	8376	Welsh	6789
Breton	6682	German	6869	Korean	7579	Panjabi	8065	Spanish	6983	Wolof	8779
Bulgarian	6671	Greek	6976	Kurdish	7585	Pashto, Pushto	8083	Sudanese	8385	Xhosa	8872
Burmese	7789	Greenlandic	7576	Laotian	7679	Persian	7065	Swahili	8387	Yiddish	7473
Byelorussian	6669	Guarani	7178	Latin	7665	Polish	8076	Swedish	8386	Yoruba	8979
Chinese	9072	Gujarati	7185	Latvian, Lettish	7686	Portuguese	8084	Tagalog	8476	Zulu	9085

## Area Codes







Choose a area code from this list.

Area	Code	Area	Code	Area	Code	Area	Code	Area	Code	Area	Code
Afghanistan	AF	Costa Rica	CR	Greenland	GL	Maldives	MV	Paraguay	PY	Sri Lanka	LK
Argentina	AR	Croatia	HR	Hong Kong	HK	Mexico	MX	Philippines	PH	Sweden	SE
Australia	AU	Czech Republic	CZ	Hungary	HU	Monaco	MC	Poland	PL	Switzerland	CH
Austria	AT	Denmark	DK	India	IN	Mongolia	MN	Portugal	PT	Taiwan	TW
Belgium	BE	Ecuador	EC	Indonesia	ID	Morocco	MA	Romania	RO	Thailand	TH
Bhutan	BT	Egypt	EG	Israel	IL	Nepal	NP	Russian Federation	RU	Turkey	TR
Bolivia	BO	El Salvador	SV	Italy	IT	Netherlands	NL	Saudi Arabia	SA	Uganda	UG
Brazil	BR	Ethiopia	ET	Jamaica	JM	Netherlands Antilles	AN	Senegal	SN	Ukraine	uaw
Cambodia	KH	Fiji	FJ	Japan	JP	New Zealand	NZ	Singapore	SG	United States	US
Canada	CA	Finland	FI	Kenya	KE	Nigeria	NG	Slovak Republic	SK	Uruguay	UY
Chile	CL	France	FR	Kuwait	KW	Norway	NO	Slovenia	SI	Uzbekistan	UZ
China	CN	Germany	DE	Libya	LY	Oman	OM	South Africa	ZA	Vietnam	VN
Colombia	CO	Great Britain	GB	Luxembourg	LU	Pakistan	PK	South Korea	KR	Zimbabwe	ZW
Congo	CG	Greece	GR	Malaysia	MY	Panama	PA	Spain	ES		

## Troubleshooting

PROBLEM	CAUSE	CORRECTION
No power	The power cord is disconnected.	Plug the power cord into the wall outlet securely.
No picture	The TV is not set to receive the DVD signal.	Select the appropriate video input mode on the TV so the picture from the DVD Receiver appears on the TV screen.
	The video cables are not connected securely.	Connect the video cables securely to both the TV and DVD Receiver.
There is little or no sound	Equipment connected via the audio cable is not set to receive DVD signal output.	Select the correct input mode of the audio receiver so you can hear the sound from the DVD receiver.
	The audio cables are not connected to the speakers or receiver securely.	Connect the audio cables into the connection terminals correctly.
	The audio cables are damaged.	Replace with a new audio cable.
The DVD picture quality is poor	The disc is dirty.	Clean the disc using a soft cloth with outward strokes.
A DVD/CD will not play	No disc is inserted.	Insert a disc
	An unplayable disc is inserted.	Insert a playable disc (check the disc type, colour system and regional code).
	The disc is inserted upside down.	Place the disc with the label or printed side facing upwards.
	The menu is open on screen.	Press SETUP to close the menu screen.
	There is a parental lock which prevents the playback of DVDs with a certain rating.	Enter your password or change the rating level.
Humming noise heard while a DVD or CD is playing	The disc is dirty.	Clean the disc using a soft cloth with outward strokes.
	The DVD receiver is located too close to the TV, causing feedback.	Move DVD receiver and audio components further away from your TV.
Radio stations can't be tuned in properly	The antenna is positioned or connected poorly.	Check the antenna connection and adjust its position. Attach an external aerial if necessary.
	The signal strength of the radio station is too weak.	Tune to the station manually.
	No stations have been preset or preset stations have been cleared (when tuning by scanning preset channels).	Preset some radio stations, see page 15 for details.
The remote control doesn't work well / at all	The remote is not pointed directly at the DVD receiver.	Point the remote directly at the unit.
	The remote is too far from the DVD receiver.	Use the remote within 23 feet (7m) of the DVD receiver.
	There is an obstacle in the path between the remote control and the unit.	Remove the obstacle.
	The battery in the remote control are flat.	Replace the batteries with new ones.

## Types of Playable Discs

Type	Logo
<b>DVD-VIDEO</b> : Discs such as movies that can be purchased or rented.	
<b>DVD-R</b> : Video mode and finalized only	
<b>DVD-RW</b> : Video mode and finalized only DVD VR format that have been finalized can not be played in this unit	
<b>DVD+R</b> : Video mode only Supports the double layer disc also	
<b>DVD+RW</b> : Video mode only	
<b>Audio CD</b> : Music CDs or CD-R/ CD-RW in music CD format that can be purchased.	
<p>This unit plays DVD±R/ RW and CD-R/ RW that contains audio titles, DivX, MP3, WMA and/ or JPEG files. Some DVD±RW/ DVD±R or CD-RW/ CD-R cannot be played on this unit due to the recording quality or physical condition of the disc, or the characteristics of the recording device and authoring software.</p>	

“Dolby”, “Pro Logic”, and the double-D symbol are trademarks of Dolby Laboratories.  
Manufactured under license from Dolby Laboratories.

HDMI, the HDMI logo and High-Definition Multimedia Interface are trademarks or registered trademarks of HDMI licensing LLC.

### About the Symbol Display

“” may appear on your TV display during operation and indicates that the function explained in this owner’s manual is not available on that specific DVD video disc.

### Regional Codes

This unit has a regional code printed on the rear of the unit. This unit can play only DVD discs labeled same as the rear of the unit or “ALL”.

- Most DVD discs have a globe with one or more numbers in it clearly visible on the cover. This number must match your unit’s regional code or the disc cannot play.
- If you try to play a DVD with a different regional code from your player, the message “Check Regional Code” appears on the TV screen.

### Copyrights

It is forbidden by law to copy, broadcast, show, broadcast via cable, play in public, or rent copyrighted material without permission. This product features the copy protection function developed by Macrovision. Copy protection signals are recorded on some discs. When recording and playing the pictures of these discs picture noise will appear. This product incorporates copyright protection technology that is protected by U.S. patents and other intellectual property rights. Use of this copyright protection technology must be authorized by Macrovision, and is intended for home and other limited viewing uses only unless otherwise authorized by Macrovision. Reverse engineering or disassembly is prohibited.

CONSUMERS SHOULD NOTE THAT NOT ALL HIGH DEFINITION TELEVISION SETS ARE FULLY COMPATIBLE WITH THIS PRODUCT AND MAY CAUSE ARTIFACTS TO BE DISPLAYED IN THE PICTURE. IN CASE OF 525 OR 625 PROGRESSIVE SCAN PICTURE PROBLEMS, IT IS RECOMMENDED THAT THE USER SWITCH THE CONNECTION TO THE ‘STANDARD DEFINITION’ OUTPUT. IF THERE ARE QUESTIONS REGARDING OUR TV SET COMPATIBILITY WITH THIS MODEL 525 AND 625 UNIT, PLEASE CONTACT OUR CUSTOMER SERVICE CENTER.

You have to set the disc format option to [Mastered] in order to make the discs compatible with the LG players when formatting rewritable discs. When setting the option to Live File System, you cannot use it on LG players.  
(Mastered/ Live File System : Disc format system for Windows Vista)

## Specifications

### General

Power supply	Refer to main label. (Mexico only : 120 V ~ 60 Hz)
Power consumption	70 W
Net Weight	2.5 kg
External dimensions (W x H x D)	360 x 62 x 305 mm
Operating conditions Temperature	5°C to 35°C Operation status: Horizontal
Operating humidity	5% to 85%
Laser	Semiconductor laser, wavelength 650 nm

### Tuner FM/AM [MW]

FM Tuning Range	87.5 - 108.0 MHz
FM Intermediate Frequency	128 kHz
AM Tuning Range	522 - 1 620 kHz, 520 - 1 710 kHz or 522 - 1 710kHz
AM Intermediate Frequency	45 kHz

### Amplifier

Stereo mode	70 W + 70 W (4Ω at 1 kHz, THD 10 %)
Surround mode Front	70 W + 70 W (THD 10 %)
Center*	70 W
Surround*	70 W + 70 W (4Ω at 1 kHz THD 10 %)
Subwoofer*	150 W (8Ω at 60 Hz THD 10 %)

## Specifications

### Speakers (HT534TN)

	Front/Rear Speaker	Center speaker	Passive Subwoofer
Type	2 Way 2 Speaker	2 Way 3 Speaker	1 Way 1 Speaker
Impedance	4 Ω	4 Ω	8 Ω
Rated Input Power	70 W	70 W	150 W
Max. Input Power	140 W	140 W	300 W
Net Dimensions (W x H x D)	270 x 1100 x 270 mm	330 x 86 x 121 mm	212 x 395 x 341 mm
Net Weight	3.0 kg	1.15 kg	6.0 kg

### Speakers (HT534SN)

	Front/Rear Speaker	Center speaker	Passive Subwoofer
Type	1 Way 1 Speaker	1 Way 1 Speaker	1 Way 1 Speaker
Impedance	4 Ω	4 Ω	8 Ω
Rated Input Power	70 W	70 W	150 W
Max. Input Power	140 W	140 W	300 W
Net Dimensions (W x H x D)	114 x 208.5 x 83 mm	330 x 86 x 121 mm	212 x 395 x 341 mm
Net Weight	0.55 kg	1.15 kg	6.0 kg

Designs and specifications are subject to change without prior notice.



**Atención al Cliente**

País	Teléfono	País	Teléfono
México	01-800-347-1919	Costa Rica	1-800-507-5454
Colombia	01-8000-910683	Rep. Dominicana	00-800-751-5454
Chile	800-26-1054	Guatemala	1-801-422-5454
Ecuador	1-800-545454	El Salvador	00-800-6309
Venezuela	800-5424477	Cuba	204-3333
Panamá	800-5454	Miami, USA	1-305-477-1882
Perú	0-800-1-2424	Bolivia, La Paz	800-100-545
Puerto Rico	001-800-510-9564	Nicaragua	001-800-507-0007
Argentina	0800-888-5454 (Capital y GBA) / 0810-555-5454 (Interior del país)		



[www.lgservice.com](http://www.lgservice.com)