



# LG

Life's Good

## LCD TV OWNER'S MANUAL

19LH20R	32LH30FR	19LU50R
22LH20R	37LH30FR	22LU50FR
26LH20R	42LH30FR	26LU50FR
32LH20R	47LH30FR	
37LH20R		32LH70YR
42LH20R	42LH50YR	42LH70YR
	47LH50YR	47LH70YR
32LF20FR	55LH50YR	
42LF20FR		42LH90QR
		47LH90QR

Please read this manual carefully before operating your set and retain it for future reference.

The model and serial number of the TV is located on the back and one side of the TV.

Record it below should you ever need service.

Model:

Serial:

P/NO : MFL58486305 (0904-REV06)

# WARNING / CAUTION



**WARNING / CAUTION**  
RISK OF ELECTRIC SHOCK  
DO NOT OPEN



TO REDUCE THE RISK OF ELECTRIC SHOCK  
DO NOT REMOVE COVER (OR BACK). NO  
USER SERVICEABLE PARTS INSIDE. REFER TO  
QUALIFIED SERVICE PERSONNEL.



The lightning flash with arrowhead symbol, within an equilateral triangle, is intended to alert the user to the presence of uninsulated “dangerous voltage” within the product’s enclosure that may be of sufficient magnitude to constitute a risk of electric shock to persons.



The exclamation point within an equilateral triangle is intended to alert the user to the presence of important operating and maintenance (servicing) instructions in the literature accompanying the appliance.

## WARNING/CAUTION

TO REDUCE THE RISK OF FIRE AND ELECTRIC SHOCK, DO NOT EXPOSE THIS PRODUCT TO RAIN OR MOISTURE.

# SAFETY INSTRUCTIONS

## IMPORTANT SAFETY INSTRUCTIONS

Read these instructions.

Keep these instructions.

Heed all warnings.

Follow all instructions.



- 1 Do not use this apparatus near water.



- 2 Clean only with dry cloth.



- 3 Do not block any ventilation openings. Install in accordance with the manufacturer's instructions.



- 4 Do not install near any heat sources such as radiators, heat registers, stoves, or other apparatus (including amplifiers) that produce heat.



- 5 Do not defeat the safety purpose of the polarized or grounding-type plug. A polarized plug has two blades with one wider than the other. A grounding type plug has two blades and a third grounding prong. The wide blade or the third prong are provided for your safety. If the provided plug does not fit into your outlet, consult an electrician for replacement of the obsolete outlet.



- 6 Protect the power cord from being walked on or pinched particularly at plugs, convenience receptacles, and the point where they exit from the apparatus.



- 7 Only use attachments/accessories specified by the manufacturer.



- 8 Use only with the cart, stand, tripod, bracket, or table specified by the manufacturer, or sold with the apparatus. When a cart is used, use caution when moving the cart/apparatus combination to avoid injury from tip-over.



- 9 Unplug this apparatus during lightning storms or when unused for long periods of time.

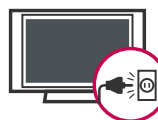

- 10 Refer all servicing to qualified service personnel. Servicing is required when the apparatus has been damaged in any way, such as power-supply cord or plug is damaged, liquid has been spilled or objects have fallen into the apparatus, the apparatus has been exposed to rain or moisture, does not operate normally, or has been dropped.

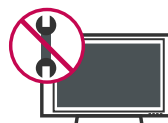

# SAFETY INSTRUCTIONS

**11** Never touch this apparatus or antenna during a thunder or lightning storm.

---

**12** When mounting a TV on the wall, make sure not to install the TV by the hanging power and signal cables on the back of the TV.

---

**13** Do not allow an impact shock or any objects to fall into the product, and do not drop onto the screen with something.

---

**14** CAUTION concerning the Power Cord:  
It is recommend that appliances be placed upon a dedicated circuit; that is, a single outlet circuit which powers only that appliance and has no additional outlets or branch circuits. Check the specification page of this owner's manual to be certain.

Do not connect too many appliances to the same AC power outlet as this could result in fire or electric shock.

Do not overload wall outlets. Overloaded wall outlets, loose or damaged wall outlets, extension cords, frayed power cords, or damaged or cracked wire insulation are dangerous. Any of these conditions could result in electric shock or fire. Periodically examine the cord of your appliance, and if its appearance indicates damage or deterioration, unplug it, discontinue use of the appliance, and have the cord replaced with an exact replacement part by an authorized servicer. Protect the power cord from physical or mechanical abuse, such as being twisted, kinked, pinched, closed in a door, or walked upon. Pay particular attention to plugs, wall outlets, and the point where the cord exits the appliance.

Do not make the TV with the power cord plugged in. Do not use a damaged or loose power cord. Be sure do grasp the plug when unplugging the power cord. Do not pull on the power cord to unplug the TV.

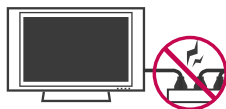

**15** WARNING - To reduce the risk of fire or electrical shock, do not expose this product to rain, moisture or other liquids. Do not touch the TV with wet hands. Do not install this product near flammable objects such as gasoline or candles or expose the TV to direct air conditioning.



**16** Do not expose to dripping or splashing and do not place objects filled with liquids, such as vases, cups, etc. on or over the apparatus (e.g. on shelves above the unit).



## **17** GROUNDING

Ensure that you connect the earth ground wire to prevent possible electric shock (i.e. a TV with a three-prong grounded AC plug must be connected to a three-prong grounded AC outlet). If grounding methods are not possible, have a qualified electrician install a separate circuit breaker.

Do not try to ground the unit by connecting it to telephone wires, lightning rods, or gas pipes.

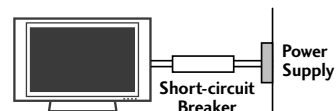

**18** DISCONNECTING DEVICE FROM MAINS  
Mains plug is the disconnecting device. The plug must remain readily operable.

---

**19** As long as this unit TV is connected to the AC wall outlet, it is not disconnected from the AC power source even if you turn off this unit by SWITCH.

**20** **Cleaning**

When cleaning, unplug the power cord and scrub gently with a soft cloth to prevent scratching. Do not spray water or other liquids directly on the TV as electric shock may occur. Do not clean with chemicals such as alcohol, thinners or benzene.

**21** **Moving**

Make sure the product is turned off, unplugged and all cables have been removed. It may take 2 or more people to carry larger TVs. Do not press against or put stress on the front panel of the TV.

**22** **Ventilation**

Install your TV where there is proper ventilation. Do not install in a confined space such as a bookcase. Do not cover the product with cloth or other materials (e.g.) plastic while plugged in. Do not install in excessively dusty places.

**23** If you smell smoke or other odors coming from the TV or hear strange sounds, unplug the power cord contact an authorized service center.

**24** Do not press strongly upon the panel with hand or sharp object such as nail, pencil or pen, or make a scratch on it.

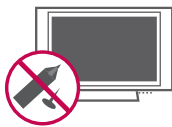

**25** Keep the product away from direct sunlight.

**26** **For LCD TV**

If the TV feels cold to the touch, there may be a small “flicker” when it is turned on. This is normal, there is nothing wrong with TV.

Some minute dot defects may be visible on the screen, appearing as tiny red, green, or blue spots. However, they have no adverse effect on the monitor’s performance.

Avoid touching the LCD screen or holding your finger(s) against it for long periods of time. Doing so may produce some temporary distortion effects on the screen.

**ON DISPOSAL (Some models)**  
**(Only Hg lamp used LCD TV)**

The fluorescent lamp used in this product contains a small amount of mercury. Do not dispose of this product with general household waste. Disposal of this product must be carried out in accordance to the regulations of your local authority.

# CONTENTS

<b>WARNING / CAUTION</b> .....	2
<b>SAFETY INSTRUCTIONS</b> .....	3
<b>FEATURE OF THIS TV</b> .....	8

## PREPARATION

Accessories .....	9
Front Panel Information .....	10
Back Panel Information .....	13
Stand Instruction .....	16
VESA Wall Mounting .....	21
Cable Arrangement .....	22
Desktop Pedestal Installation .....	24
Swivel Stand .....	24
Positioning your display .....	24
Attaching the tv to a desk .....	25
Kensington Security System .....	25
Securing the TV to the wall to prevent falling when the tv is used on a stand .....	26
Antenna or Cable Connection .....	27

## EXTERNAL EQUIPMENT SETUP

HD Receiver Setup .....	28
DVD Setup .....	31
VCR Setup .....	33
Other A/V Source Setup .....	35
PC Setup .....	36
USB Connection .....	42
Variable Out .....	43
Monitor Out .....	43

## WATCHING TV / CHANNEL CONTROL

Remote Control Functions .....	44
Turning On the TV .....	46
Channel Selection .....	46
Volume Adjustment .....	46
Initializing Setup (Mode Setting) .....	47
On-Screen Menus Selection .....	48
Quick Menu .....	49
Channel Setup	
- Auto Scan (Auto Tuning) .....	50

- Add / Delete Channel (Manual Tuning) .....	51
- Channel Editing .....	52
Channel List .....	53
Favorite Channel Setup .....	54
Favorite Channel List .....	55
Input List .....	56
Input Label .....	57
AV Mode .....	58
Key Lock .....	59
SIMPLINK .....	60

## BLUETOOTH

Bluetooth? .....	62
Setting the bluetooth .....	63
Set TV PIN .....	64
Bluetooth headset .....	65
Managing Registered Bluetooth device .....	67
My Bluetooth Information .....	68
Viewing the photos with Bluetooth device .....	69
Listening the Musics with Bluetooth device .....	69

## USB

Entry Modes .....	70
Photo List .....	71
Music List .....	75
Movie List .....	77
DivX Registration Code .....	80
Deactivation .....	81

## PICTURE CONTROL

Picture Size (Aspect Ratio) Control .....	82
Preset Picture Settings - Picture Mode .....	84
Manual Picture Adjustment - User Mode .....	85
Picture Improvement Technology .....	86
Expert Picture control .....	87
 Energy Saving .....	90
Picture Reset .....	91
Power Indicator .....	92
Demo Mode .....	93
Initial Setting (Factory Reset) .....	94

## SOUND & LANGUAGE CONTROL

Auto Volume Leveler (Auto Volume) .....	95
Clear Voice II .....	96
Preset Sound Setting (Sound Mode) .....	97
Sound Setting Adjustment - User Mode	
- SRS TruSurround XT .....	98
Balance .....	99
TV Speakers On/Off Setup .....	100
Selecting Audio Out .....	101
Audio Reset .....	102
Stereo/SAP Broadcast Setup .....	103
On-Screen Menus Language Selection .....	104
Closed Captions .....	105

## TIME SETTING

Clock Setting	
- Clock Setup .....	106
On/Off Time Setting .....	107
Sleep Timer Setting .....	108

## APPENDIX

Troubleshooting .....	109
Maintenance .....	111
Product Specifications .....	112
IR Codes .....	114
External Control Through RS-232C .....	116

# FEATURE OF THIS TV

- This feature is not available for all models.



SRS is a trademark of SRS Labs, Inc. TruSurround XT technology is incorporated under license from SRS Labs, Inc.



"DivX Certified to play DivX video, including premium content"

ABOUT DIVX VIDEO: DivX® is a digital video format created by DivX, Inc. This is an official DivX Certified device that plays DivX video. Visit [www.divx.com](http://www.divx.com) for more information and software tools to convert your files into DivX video.

ABOUT DIVX VIDEO-ON-DEMAND: This DivX Certified® device must be registered in order to play DivX Video-on-Demand (VOD) content. To generate the registration code, locate the DivX VOD section in the device setup menu. Go to [vod.divx.com](http://vod.divx.com) with this code to complete the registration process and learn more about DivX VOD.



Manufactured under license from Dolby Laboratories. "Dolby" and the double-D symbol are trademarks of Dolby Laboratories.



Listen to TV with wireless headset, or enjoy viewing your mobile phone photos on your TV.



Automatically enhances and amplifies the sound of human voice frequency range to help keep dialogue audible when background noise swells.



## IMPORTANT INFORMATION TO PREVENT "IMAGE BURN / BURN-IN" ON YOUR TV SCREEN

- When a fixed image (e.g. logos, screen menus, video game, and computer display) is displayed on the TV for an extended period, it can become permanently imprinted on the screen. This phenomenon is known as "image burn" or "burn-in." Image burn is not covered under the manufacturer's warranty.
- In order to prevent image burn, avoid displaying a fixed image on your TV screen for a prolonged period (2 or more hours for LCD, 1 or more hours for Plasma).
- Image burn can also occur on the letterboxed areas of your TV if you use the 4:3 aspect ratio setting for an extended period.

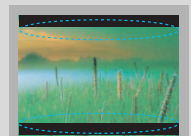
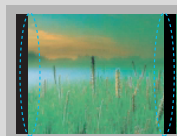



# PREPARATION

## ACCESSORIES

Ensure that the following accessories are included with your TV. If an accessory is missing, please contact the dealer where you purchased the TV.

The accessories included may differ from the images below.



Owner's Manual

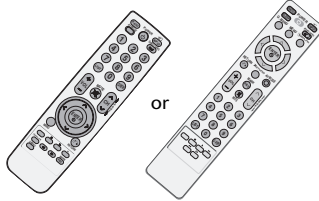

Remote Control

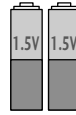

Batteries  
(Some models)



Power Cord

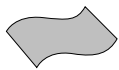

Polishing Cloth  
(Not included with all models.)

- \* Wipe spots on the exterior only with the polishing cloth.
- \* Do not wipe roughly when removing stain. Excessive pressure may cause scratch or discoloration.



RF Adapter  
(Some models)

You must connect it to the antenna wire after fixing in Antenna Input. This adapter is For supplied in **Argentina**.

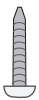

Screw for stand fixing  
(Refer to P.25)

(Except 19/22LH20R,  
47LH30FR, 47/55LH50YR,  
19LU50R, 22LU50FR,  
42/47LH70YR, 47LH90QR)

### For 19LU50R, 22/26LU50FR

(For 26LU50FR) (For 19LU50R, 22LU50FR)

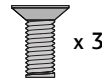

x 3



x 2



Bolts for stand assembly  
(Refer to P.19)

Cable Holder  
(Refer to P.23)

### For 19/22LH20R

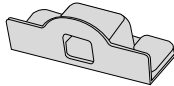

Cable Management Clip Protection Cover

### For 32/42LF20FR



x 4



x 4

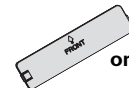

or



Bolts for stand assembly  
(Refer to P.18)

Protection Cover  
(Refer to P.18)

### For 26/32/37/42LH20R, 32/37/42/47LH30FR, 42/47/55LH50YR, 42/47LH90QR

(Except 55LH50YR)



x 4



or



Bolts for stand assembly  
(Refer to P.17)

Protection Cover

### For 32/42/47LH70YR

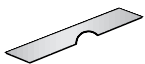

Protection cover  
(Refer to P.20)



Cable management clip  
(Refer to P.23)

(For 42/47LH70YR)



Stand rear cover  
(Refer to P.20)

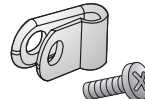

Protective Bracket and  
Screw for Power Cord  
(Refer to P.23)



USB Cable

(For 32LH70YR)



x 7

M4x20

(For 42LH70YR)



x 3

M4x20



x 4

M4x16

(For 47LH70YR)



x 8

M4x16

bolts for stand assembly (Refer to P.20)

(For 42/47LH70YR)

Use screws 12mm(±0.5) long on the TV assembly side.  
(sold separately)

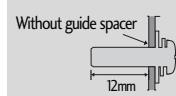
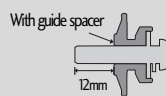

# PREPARATION

## FRONT PANEL INFORMATION

▪ Image shown may differ from your TV.

For 19/22/26/32/37/42LH20R, 32/37/42/47LH30FR

PREPARATION

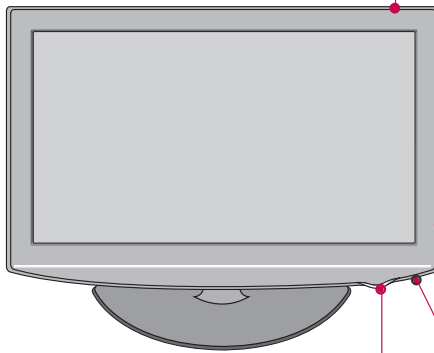
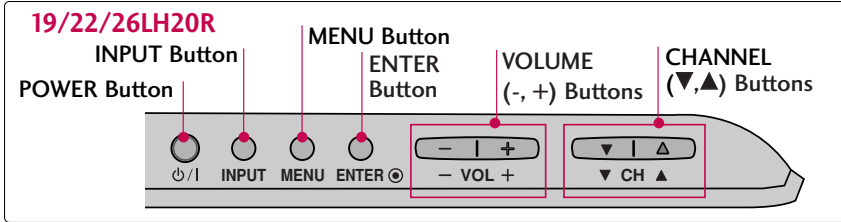

Remote Control Sensor,  
Power/Standby Indicator  
Illuminates red in standby mode.  
Illuminates blue when the TV is switched on.  
(Can be adjusted **Power Indicator** in the **OPTION** menu. ► p.92)

**32/37/42LH20R, 32/37/42/47LH30FR**

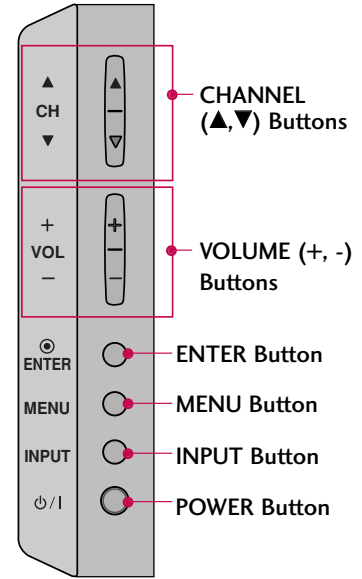

AC power control switch  
(Except 19/22LH20R)

For 32/42LF20FR

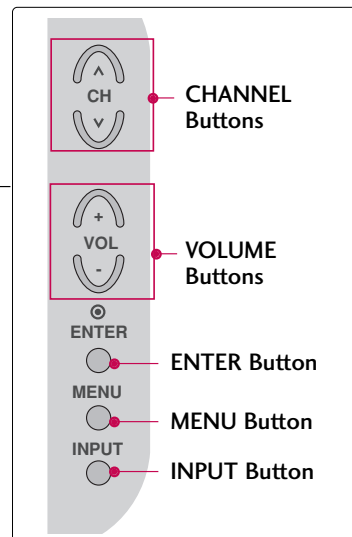
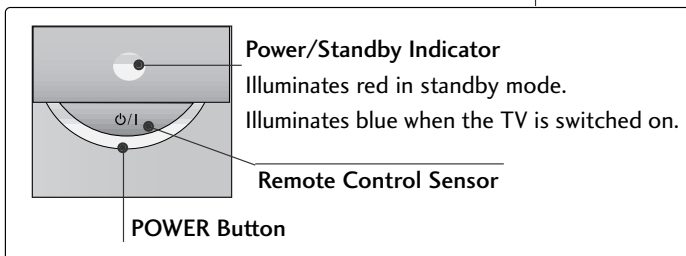
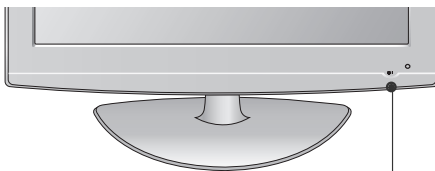

■ Image shown may differ from your TV.

### For 42/47/55LH50YR

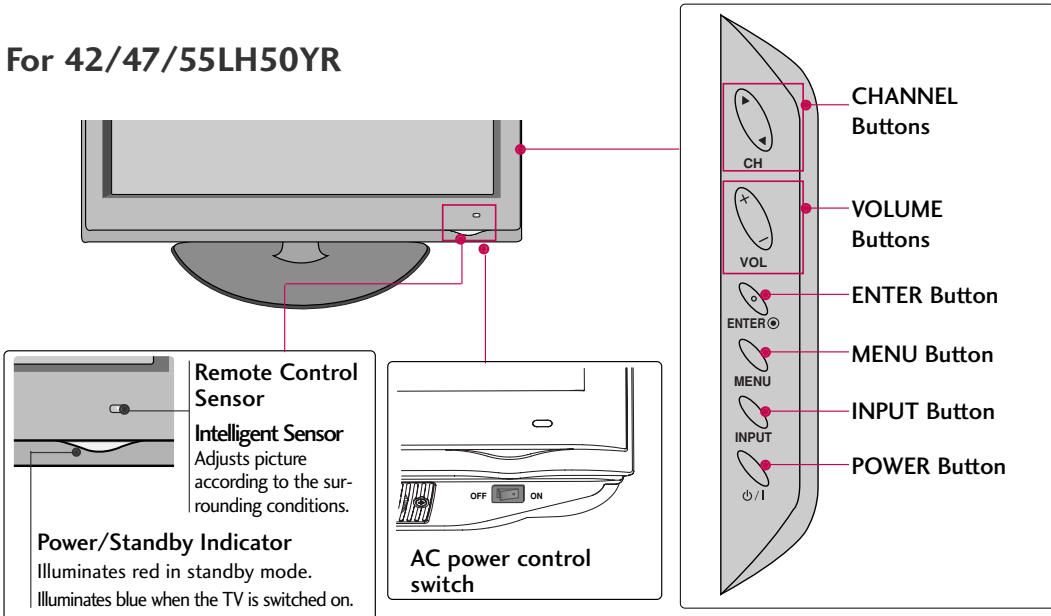

### For 19LU50R, 22LU50FR, 26LU50FR

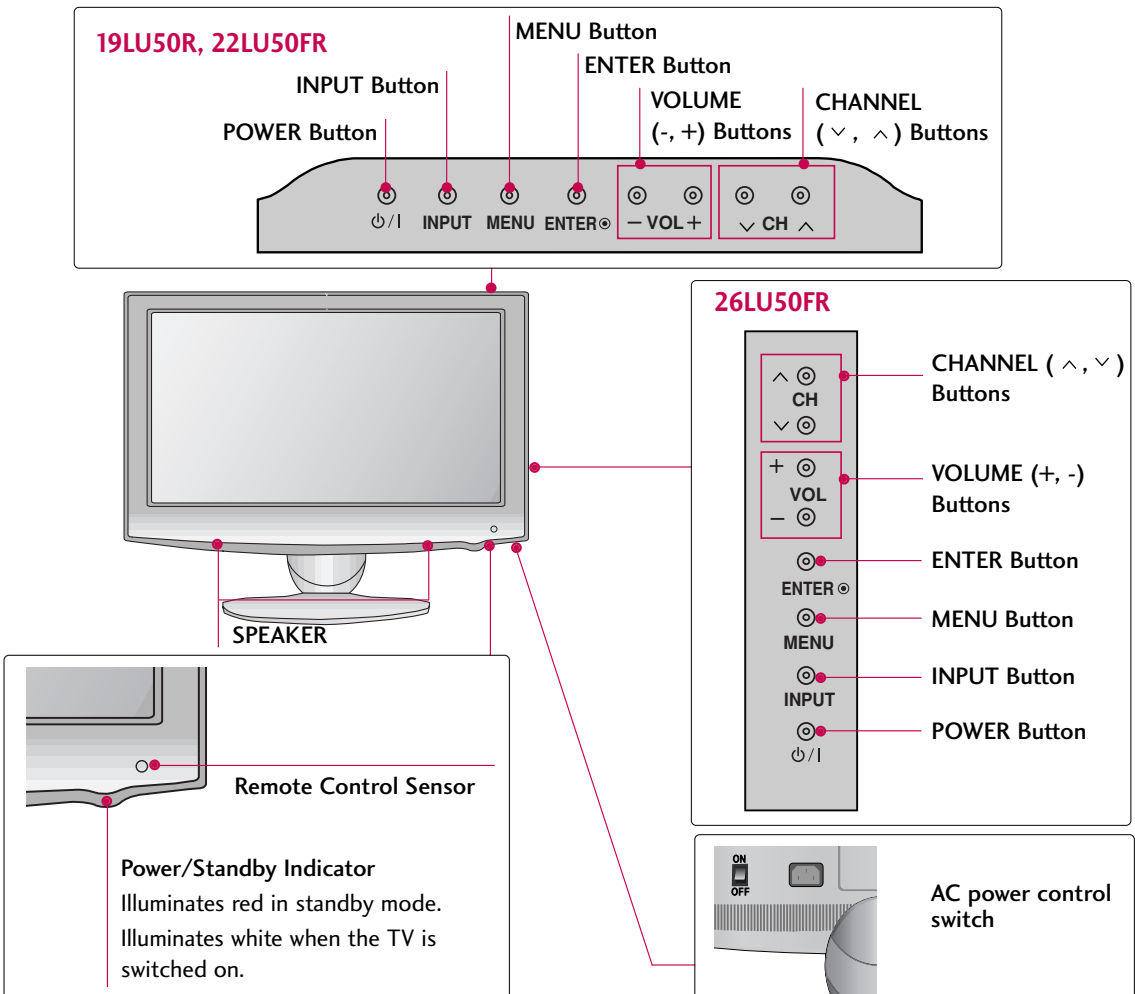

# PREPARATION

Image shown may differ from your TV.

## For 32/42/47LH70YR

PREPARATION

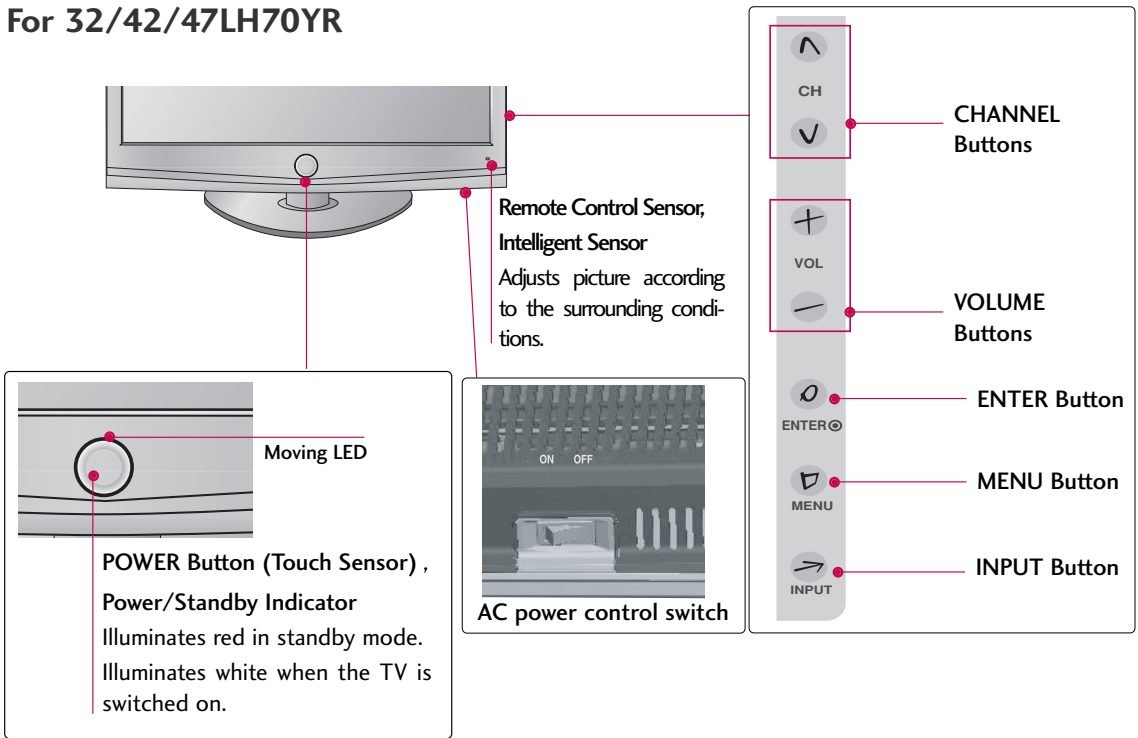

## For 42/47LH90QR

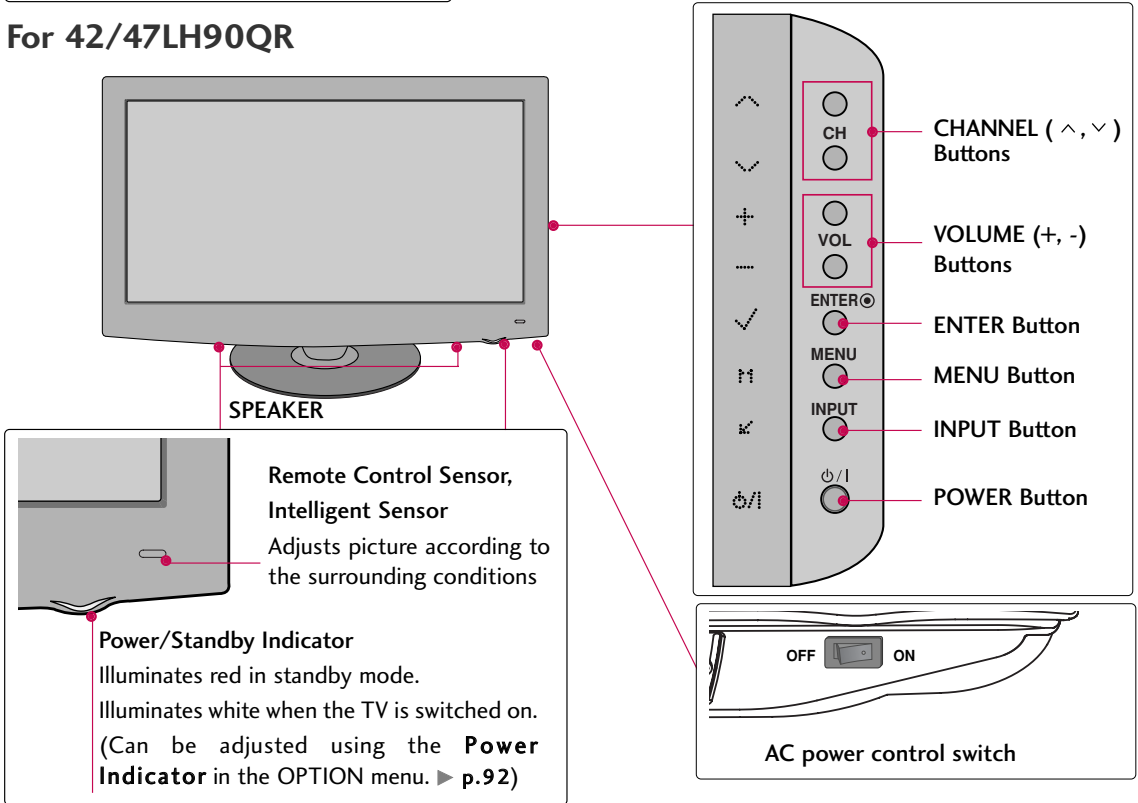

### ⚠ CAUTION

▶ When the TV cannot be turned on with the remote control, press the AC power control switch button on the TV. (The remote control will not work when the AC power control switch is switched off.)

# BACK PANEL INFORMATION

■ Image shown may differ from your TV.

## For 19/22LH20R

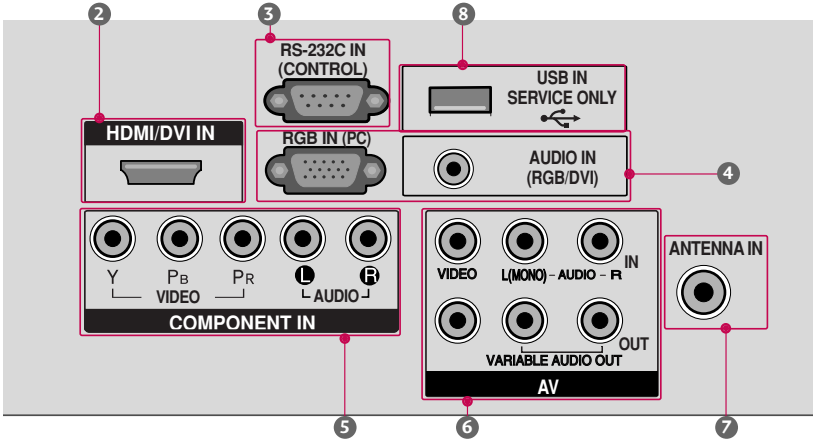

## For 26/32/37/42LH20R

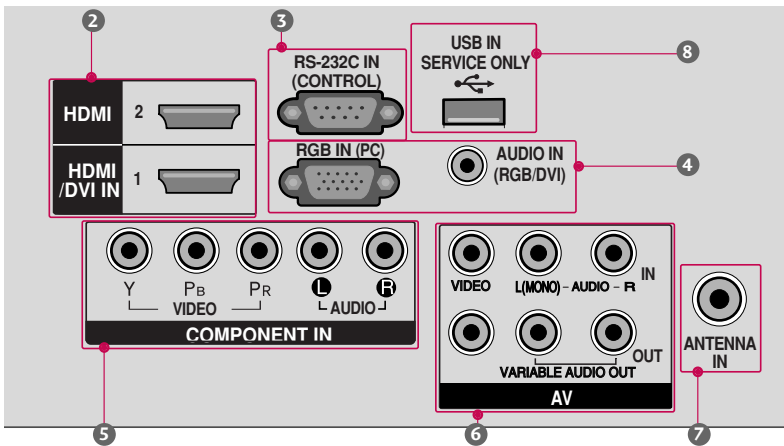

## For 32/42LF20FR

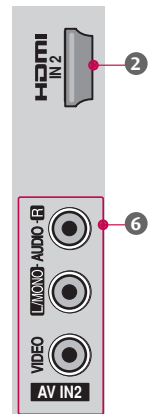
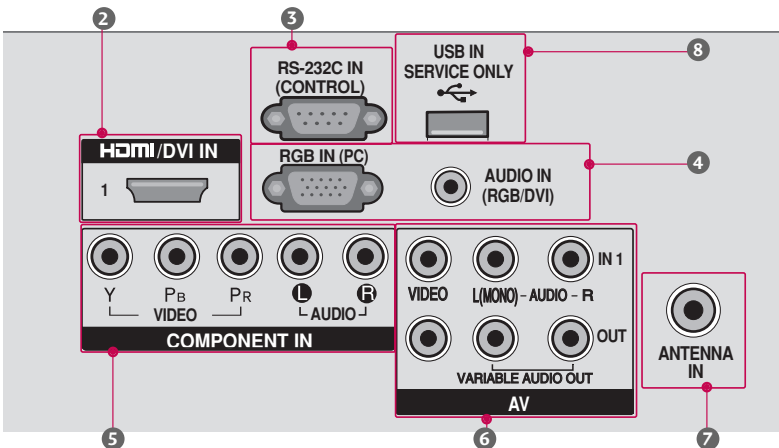

# PREPARATION

▪ Image shown may differ from your TV.

## For 32/37/42/47LH30FR

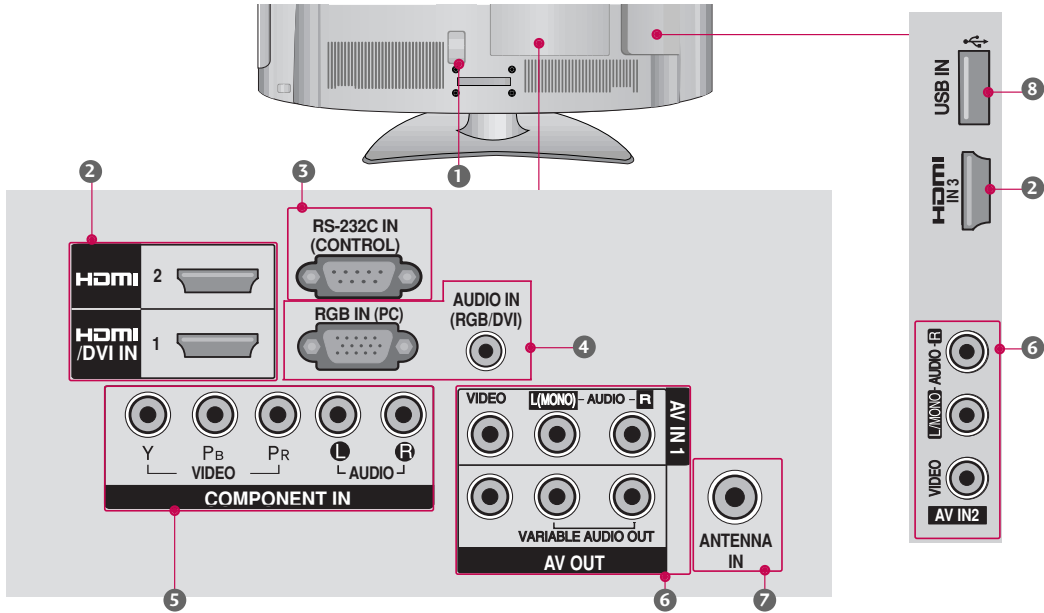

## For 19LU50R, 22LU50FR

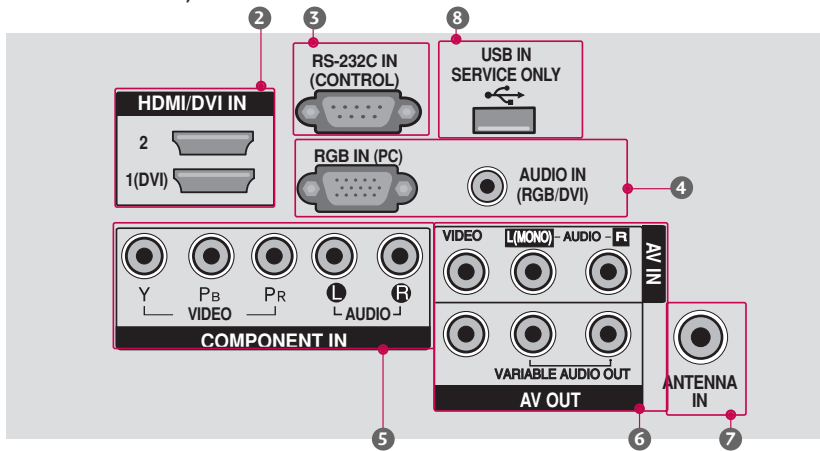

## For 26LU50FR

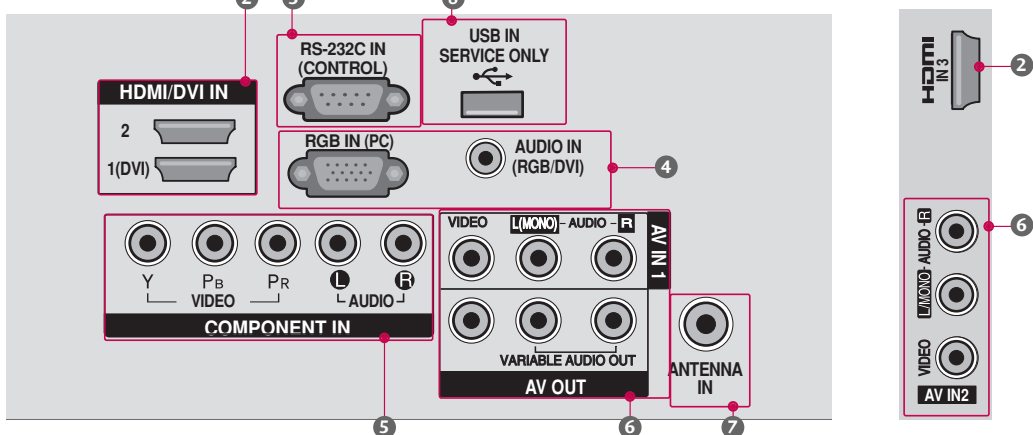

■ Image shown may differ from your TV.

## For 32/42/47LH70YR

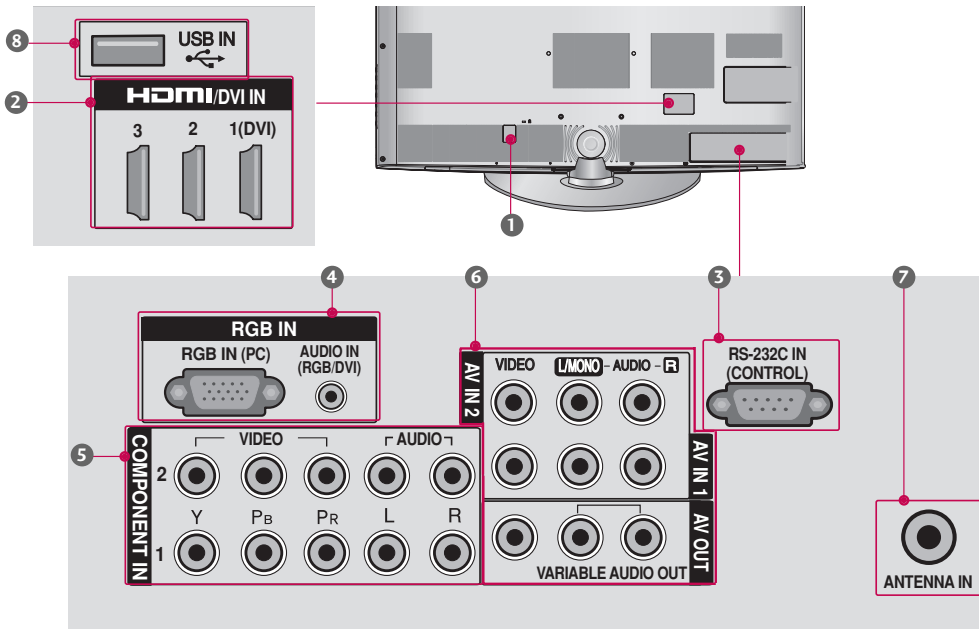

### 1 Power Cord Socket

For operation with AC power.

Caution: Never attempt to operate the TV on DC power.

### 2 HDMI/DVI IN, HDMI IN

Digital Connection.

Supports HD video and Digital audio. Doesn't support 480i/576i.

Accepts DVI video using an adapter or HDMI to DVI cable (not included).

### 3 RS-232C IN (CONTROL) PORT

Used by third party devices.

### 4 RGB IN

#### RGB IN(PC)

Analog PC Connection. Uses a D-sub 15 pin cable (VGA cable).

#### AUDIO IN (RGB/DVI)

1/8" (0.32 cm) headphone jack for analog PC audio input.

### 5 COMPONENT IN

Analog Connection.

Supports HD.

Uses a red, green, and blue cable for video & red and white for audio.

### 6 AV (Audio/Video) IN

Analog composite connection. Supports standard definition video only (480i).

#### AV Output

Connect second TV or monitor to the AV OUT socket on the TV.

#### Variable Audio Output

Connect an external amplifier or add a subwoofer to your surround sound system.

### 7 ANTENNA IN

Connect over-the air signals to this jack.

Connect cable signals to this jack.

### 8 USB IN

(For 32/37/42/47LH30FR, 32/42/47LH70YR)

Used for viewing photos/movies and listening to MP3.

#### USB IN SERVICE ONLY

(For 19/22/26/32/37/42LH20R, 32/42LF20FR, 19LU50R, 22/26LU50FR)

Used for software updates.

# PREPARATION

## STAND INSTRUCTION

▪ Image shown may differ from your TV.

For 19/22LH20R

## INSTALLATION

- 1 Carefully place the TV screen side down on a cushioned surface to protect the screen from damage.

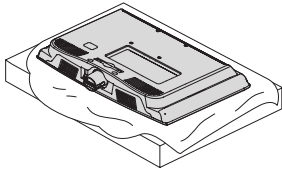

- 2 Assemble the TV as shown until you hear it click.

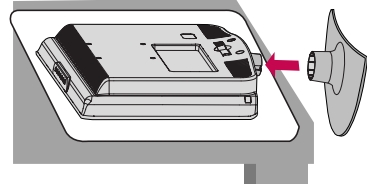

PREPARATION

## DETACHMENT

- 1 Carefully place the TV screen side down on a cushioned surface to protect the screen from damage.

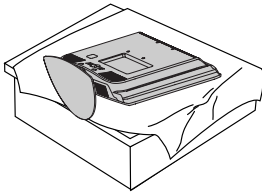

- 2 Loosen the bolts from the TV.

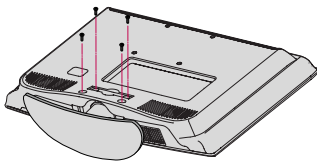

- 3 Detach the stand from the TV.

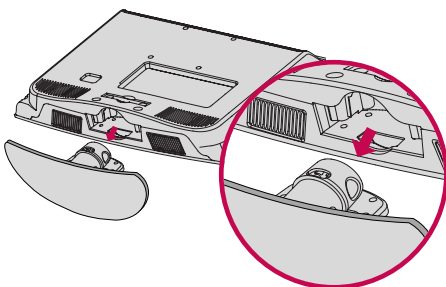

## PROTECTION COVER

- 4 Insert the PROTECTION COVER into the TV.

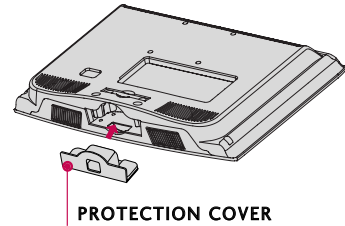

- 5 Fix the 4 bolts securely using the holes in the back of the TV.

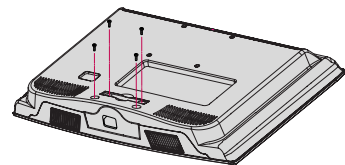



For 26/32/37/42LH20R, 32/37/42/47LH30FR, 42/47LH50YR, 42/47LH90QR

## INSTALLATION

- 1 Carefully place the TV screen side down on a cushioned surface to protect the screen from damage.

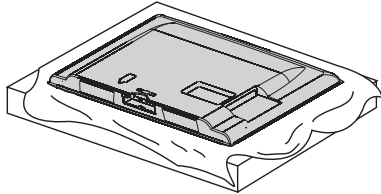

- 2 Assemble the TV as shown.

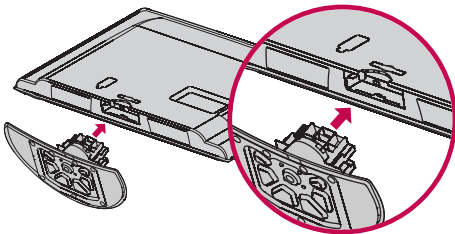

- 3 Fix the 4 bolts securely using the holes in the back of the TV.

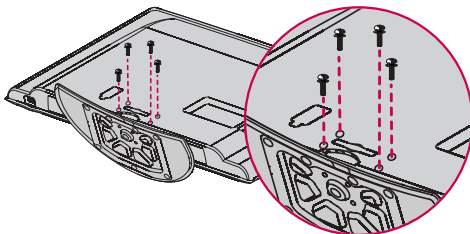

### NOTE

- ▶ When assembling the desk type stand, make sure the bolt is fully tightened (If not tightened fully, the TV can tilt forward after the product installation). Do not over tighten.

## DETACHMENT

- 1 Carefully place the TV screen side down on a cushioned surface to protect the screen from damage.

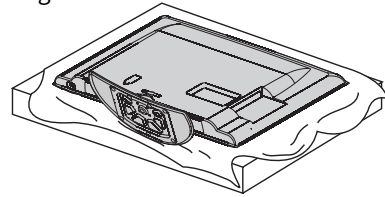

- 2 Loosen the bolts from the TV.

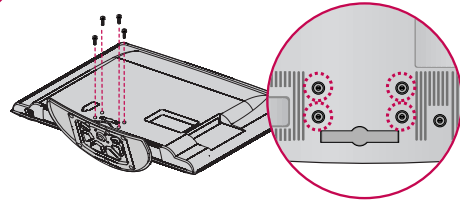

- 3 Detach the stand from the TV.

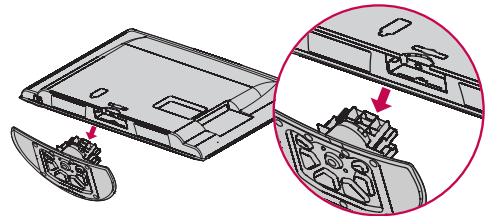

## PROTECTION COVER

For 26/32/37/42LH20R,  
32/37/42/47LH30FR, 42/47/55LH50YR

After removing the stand, install the included **protection cover** over the hole for the stand. Press the **PROTECTION COVER** into the TV until you hear it click.

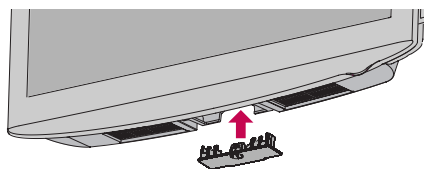

For 42/47LH90QR

Insert the **PROTECTION COVER** into the TV. After removing the protection paper from the protection cover, adhere it to the TV as shown.

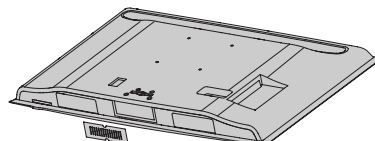

# PREPARATION

For 32/42LF20FR

## INSTALLATION

- 1 Carefully place the TV screen side down on a cushioned surface to protect the screen from damage.

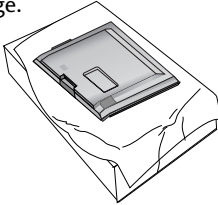

- 2 Assemble the **STAND BODY** to the **STAND BASE** with the included screws.

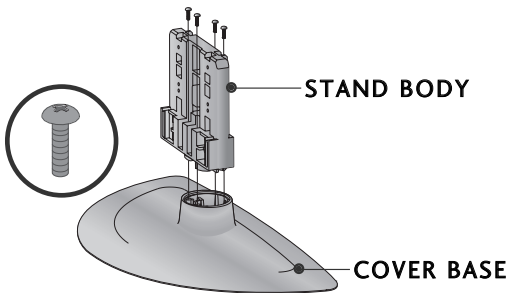

- 3 Assemble the TV as shown.

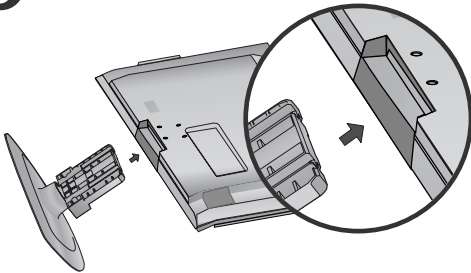

- 4 Fix the 4 bolts securely using the holes in the back of the TV.

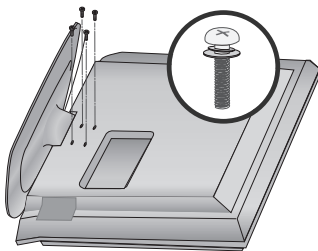

## DETACHMENT

- 1 Carefully place the TV screen side down on a cushioned surface to protect the screen from damage.

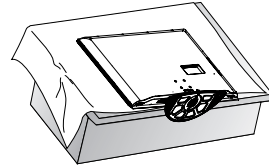

- 2 Loosen the bolts from the TV.

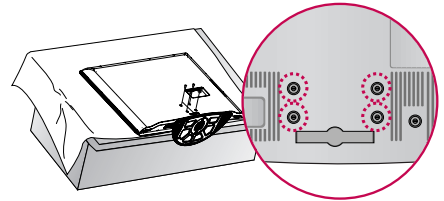

- 3 Detach the stand from the TV.

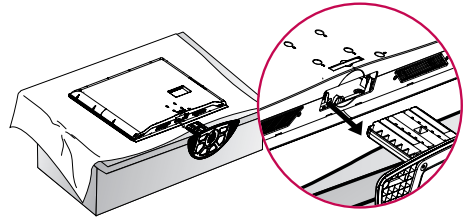

## PROTECTION COVER

After removing the stand, install the included **protection cover** over the hole for the stand.

Press the **PROTECTION COVER** into the TV until you hear it click.

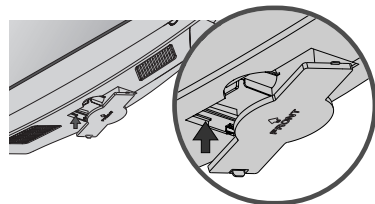

For 19LU50R, 22/26LU50FR

## INSTALLATION

- 1 Carefully place the TV screen side down on a cushioned surface to protect the screen from damage.

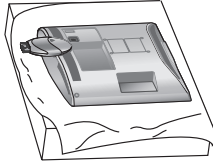

- 2 Fix the bolts securely using the holes.

19LU50R, 22LU50FR

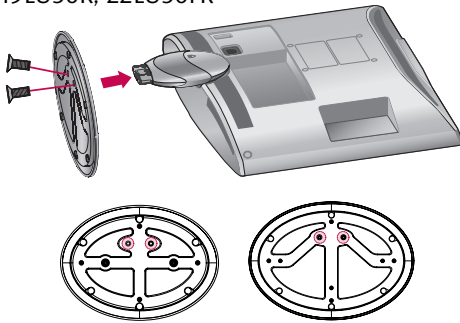

26LU50FR

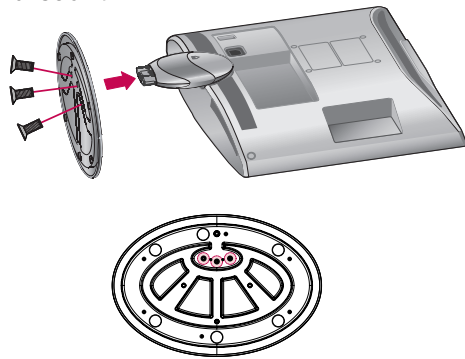

### NOTE

- ▶ When assembling the desk type stand, make sure the bolt is fully tightened (If not tightened fully, the TV can tilt forward after the product installation). Do not over tighten.

## DETACHMENT

- 1 Carefully place the TV screen side down on a cushioned surface to protect the screen from damage.

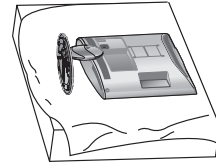

- 2 Loosen the bolts and then detach the stand from the TV.

19LU50R, 22LU50FR

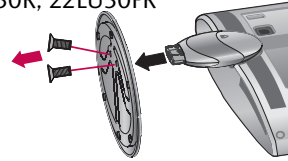

26LU50FR

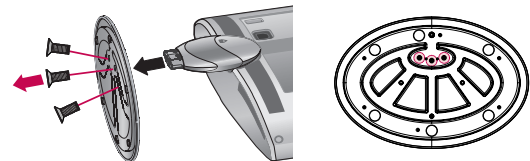

- 3 Loosen the bolts from the TV. And detach the **COVER BASE** from the TV.

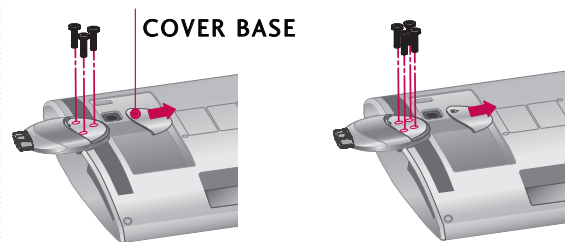

19LU50R, 22LU50FR

26LU50FR

- 4 Detach the **STAND BODY** from the TV.

**STAND BODY**

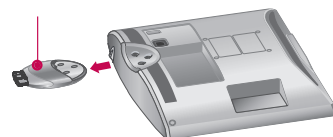

# PREPARATION

For 32/42/47LH70YR

■ Image shown may differ from your TV.

## INSTALLATION

- 1 Carefully place the TV screen side down on a cushioned surface to protect the screen from damage.

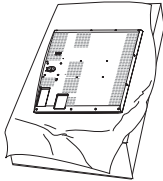

- 2 Assemble the **STAND BODY** to the **STAND BASE** with the included screws.

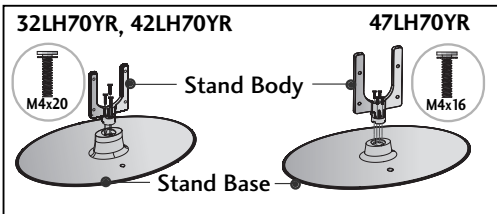

- 3 Assemble the TV as shown.

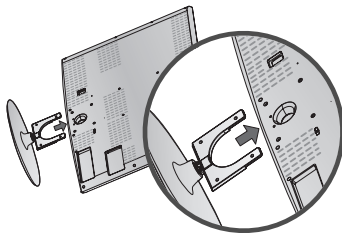

- 4 Fix the 4 bolts securely using the holes in the back of the TV.

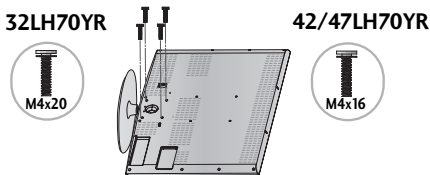

- 5 Install the **STAND REAR COVER** as shown. (For 42/47LH70YR)

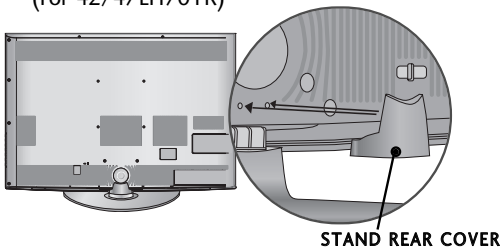

### NOTE

- ▶ When assembling the desk type stand, make sure the bolt is fully tightened (If not tightened fully, the TV can tilt forward after the product installation). Do not over tighten.

## DETACHMENT

- 1 Detach the **STAND REAR COVER** as shown. Grip the knob in your fingers and pull it.

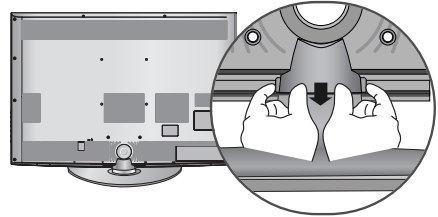

- 2 Carefully place the TV screen side down on a cushioned surface to protect the screen from damage.

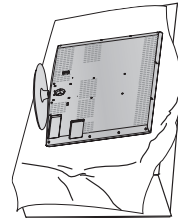

- 3 Loosen the bolts from the TV.

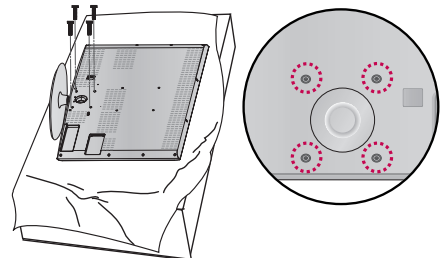

- 4 Detach the stand from the TV.

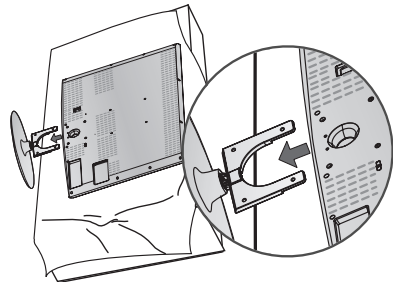

## PROTECTIVE COVER

After removing the protection paper from the protection cover, adhere it to the TV as shown.

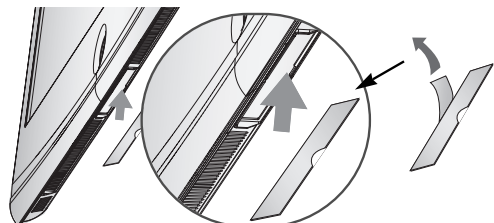

# VESA WALL MOUNTING



Install your wall mount on a solid wall perpendicular to the floor. When attaching to other building materials, please contact your nearest installer.

If installed on a ceiling or slanted wall, it may fall and result in severe personal injury.

We recommend that you use an LG brand wall mount when mounting the TV to a wall.

LG recommends that wall mounting be performed by a qualified professional installer.

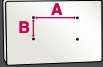
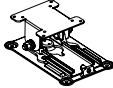
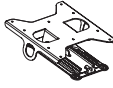
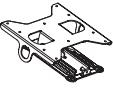
For 32/42/47LH70YR: First you connect the USB extension cable to the USB IN terminal, and then hang it on the wall.

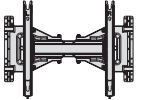
Model	VESA (A * B) 	Standard Screw	Quantity	Wall Mount Bracket (sold separately)
19/22LH20R, 19LU50R, 22LU50FR	100 * 100	M4	4	 RW120
26LH20R, 26LU50FR				 RW230
32LH20R, 32LF20FR, 32LH30FR, 32LH70YR	200 * 100	M4	4	  RW230 AW-47LG30M
37/42LH20R, 42LF20FR, 37/42/47LH30FR 42/47LH50YR, 42/47LH70YR, 42/47LH90QR	200 * 200	M6	4	 AW-47LG30M
55LH50YR	400 * 400	M6	4	 AW-55LH40M

## NOTE

- ▶ Screw length needed depends on the wall mount used. For further information, refer to the instructions included with the mount.
- ▶ Standard dimensions for wall mount kits are shown in the table.
- ▶ When purchasing our wall mount kit, a detailed installation manual and all parts necessary for assembly are provided.
- ▶ Do not use screws longer than the standard dimension, as they may cause damage to the inside to the TV.
- ▶ For wall mounts that do not comply with the VESA standard screw specifications, the length of the screws may differ depending on their specifications.
- ▶ Do not use screws that do not comply with the VESA standard screw specifications.  
Do not fasten the screws too tightly, this may damage the TV or cause the TV to a fall, leading to personal injury. LG is not liable for these kinds of accidents.
- ▶ LG is not liable for TV damage or personal injury when a non-VESA or non specified wall mount is used or the consumer fails to follow the TV installation instructions.

**CAUTION** ▶ Do not install your Wall Mount Bracket while your TV is turned on. It may result in personal injury due to electric shock.

# PREPARATION

## CABLE ARRANGEMENT

■ Image shown may differ from your TV.

For 19/22LH20R

- 1 Connect the cables as necessary.  
To connect additional equipment, see the **EXTERNAL EQUIPMENT SETUP** section.

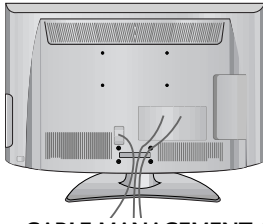

- 2 Install the **CABLE MANAGEMENT CLIP** as shown.

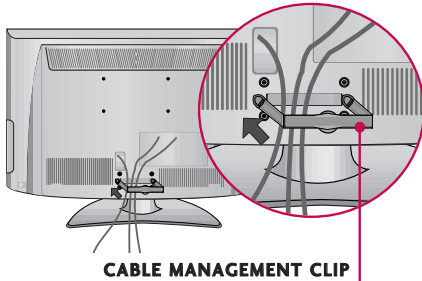

**CABLE MANAGEMENT CLIP**

- 3 Put the cables inside the **CABLE MANAGEMENT CLIP** and snap it closed.

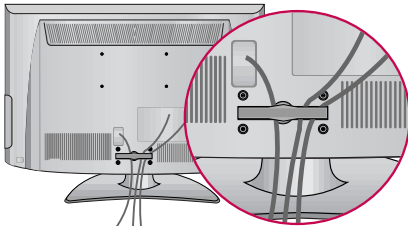

### How to remove the **CABLE MANAGEMENT CLIP**

- ▶ Hold the **CABLE MANAGEMENT CLIP** with both hands and pull it backward.

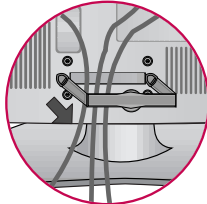

### ! NOTE

- ▶ Do not hold the **CABLE MANAGEMENT CLIP** when moving the TV.  
- If the TV is dropped, you may be injured or the product may be broken.

For 26/32/37/42LH20R, 32/42LF20FR,  
32/37/42/47LH30FR, 42/47/55LH50YR, 42/47LH90QR

- 1 Connect the cables as necessary.  
To connect additional equipment, see the **EXTERNAL EQUIPMENT SETUP** section.

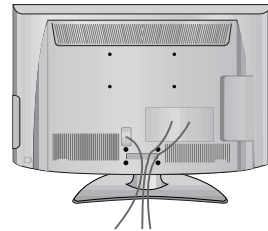

- 2 Install the **CABLE MANAGEMENT CLIP** as shown.

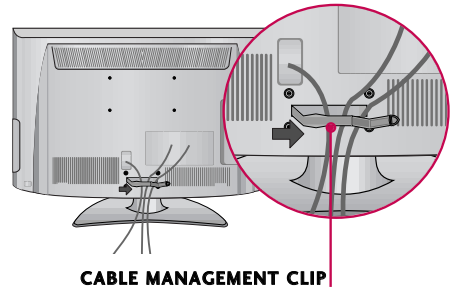

**CABLE MANAGEMENT CLIP**

- 3 Put the cables inside the **CABLE MANAGEMENT CLIP** and snap it closed.

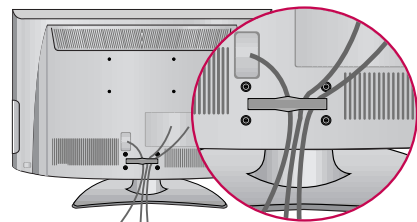

For 19LU50R, 22/26LU50FR

- 1 After connecting the cables as necessary, install **CABLE HOLDER** as shown and bundle the cables.

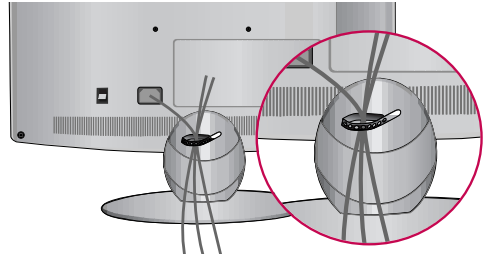

For 32/42/47LH70YR

- 1 Align the hole with the tab on the **CABLE MANAGEMENT CLIP**. Turn the **CABLE MANAGEMENT CLIP** as shown.  
Note: This cable management clip can be broken by excessive pressure.

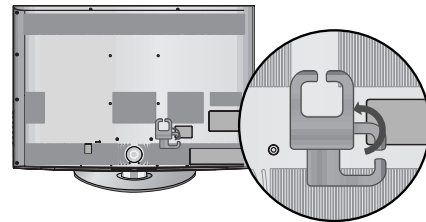
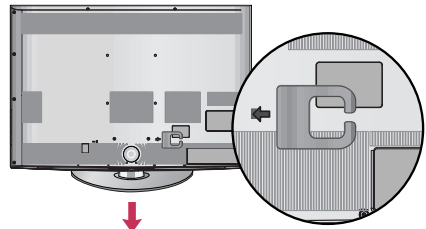

- 2 Connect the cables as necessary. To connect additional equipment, see the **EXTERNAL EQUIPMENT SETUP** section.

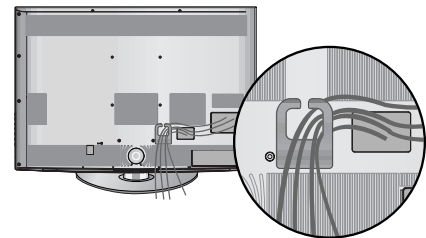

**HOW TO SECURE THE POWER CABLE**

Secure the power cable with the **PROTECTIVE BRACKET** and the bolt as shown. It will help prevent the power cable from being removed by accident.

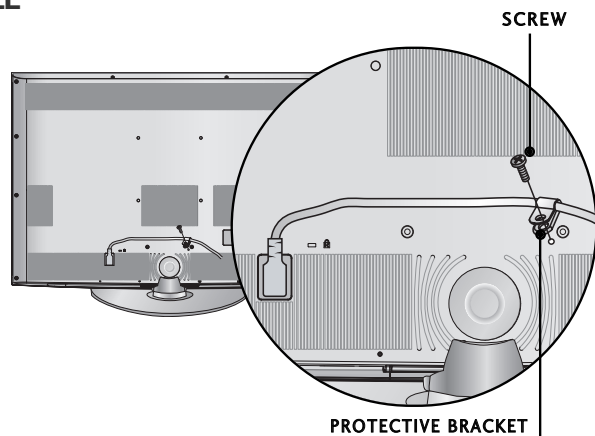

# PREPARATION

## DESKTOP PEDESTAL INSTALLATION

- Image shown may differ from your TV.

For proper ventilation, allow a clearance of 4 inches on all four sides from the wall.

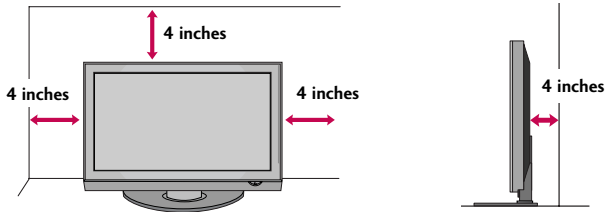

### ⚠ CAUTION

- ▶ Ensure adequate ventilation by following the clearance recommendations.
- ▶ Do not mount near or above any type of heat source.

## SWIVEL STAND (Except 19/22LH20R, 19LU50R, 22/26LU50FR)

After installing the TV, you can adjust the TV manually to the left or right direction by 20 degrees to suit your viewing position.

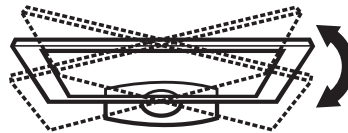

## POSITIONING YOUR DISPLAY (For 19/22LH20R)

- Here shown may be somewhat different from your TV.
- Adjust the position of the panel in various ways for maximum comfort.

### • Tilt range

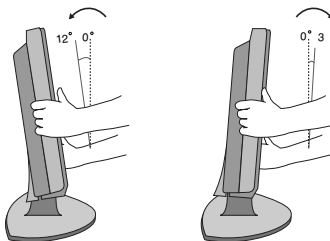

### ⓘ NOTE

- ▶ 19LU50R, 22/26LU50FR have a fixed stand type without the tilt and swivel features so excessive pressure may damage the TV.



# ATTACHING THE TV TO A DESK

(Except 19/22LH20R, 47LH30FR, 47/55LH50YR, 19LU50R, 22LU50FR, 42/47LH70YR, 47LH90QR)

The TV must be attached to a desk so it cannot be pulled in a forward/backward direction, potentially causing injury or damaging the product.

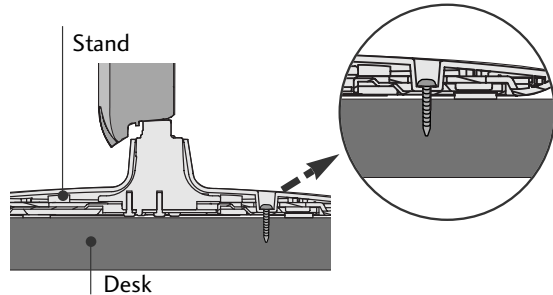
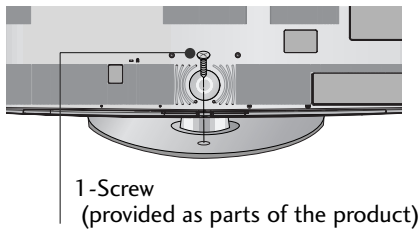
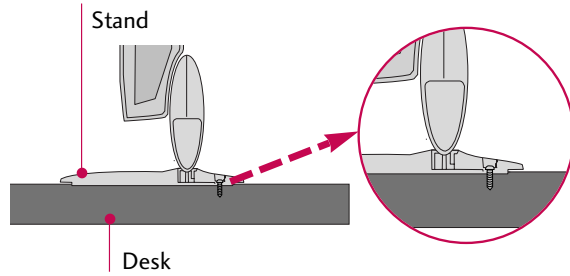
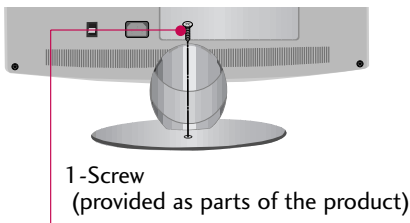
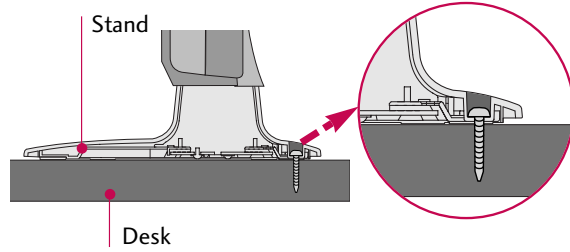
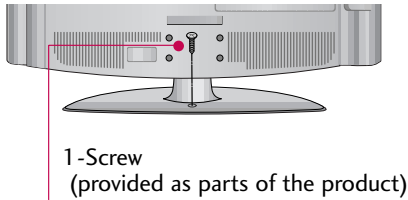

## ⚠ WARNING

- ▶ To prevent TV from falling over, the TV should be securely attached to the floor/wall per installation instructions. Tipping, shaking, or rocking the machine may cause injury.

## KENSINGTON SECURITY SYSTEM

- This feature is not available for all models.
- The TV is equipped with a Kensington Security System connector on the back panel. Connect the Kensington Security System cable as shown below.
- For the detailed installation and use of the Kensington Security System, refer to the user's guide provided with the Kensington Security System.

For further information, contact <http://www.kensington.com>, the internet homepage of the Kensington company. Kensington sells security systems for expensive electronic equipment such as notebook PCs and LCD projectors.

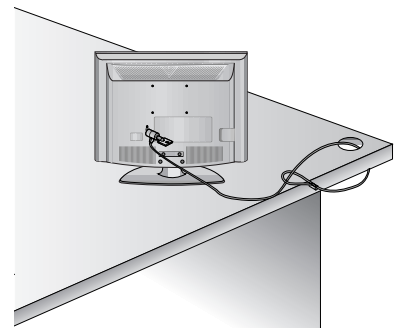

NOTE: The Kensington Security System is an optional accessory.

# PREPARATION

## SECURING THE TV TO THE WALL TO PREVENT FALLING WHEN THE TV IS USED ON A STAND

- You should purchase necessary components to prevent the TV from tipping over (when not using a wall mount).
- Image shown may differ from your TV.

We recommend that you set up the TV close to a wall so it cannot fall over if pushed backwards.

Additionally, we recommend that the TV be attached to a wall so it cannot be pulled in a forward direction, potentially causing injury or damaging the product.

Caution: Please make sure that children don't climb on or hang from the TV.

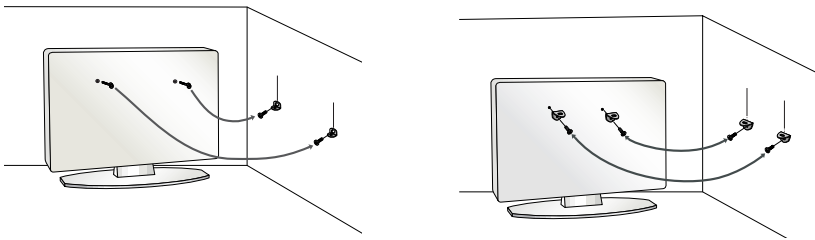

- Insert the eye-bolts (or TV brackets and bolts) to tighten the product to the wall as shown in the picture.

\* If your product has the bolts in the eye-bolts position before inserting the eye-bolts, loosen the bolts.

\* Insert the eye-bolts or TV brackets/bolts and tighten them securely in the upper holes.

Secure the wall brackets with the bolts (sold separately) to the wall. Match the height of the bracket that is mounted on the wall to the holes in the product.

Ensure the eye-bolts or brackets are tightened securely.

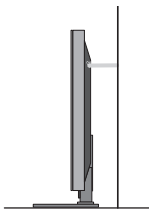

- Use a sturdy rope (sold separately) to tie the product. It is safer to tie the rope so it becomes horizontal between the wall and the product.

### ! NOTE

- ▶ Use a platform or cabinet strong enough and large enough to support the size and weight of the TV.
- ▶ To use the TV safely, make sure that the height of the bracket on the wall and the one on the TV are the same.

- To prevent damage do not connect to the power outlet until all connections are made between the devices.
- Image shown may differ from your TV.

## ANTENNA OR CABLE CONNECTION

### 1. Antenna (Analog)

Wall Antenna Socket or Outdoor Antenna without a Cable Box Connection.

For optimum picture quality, adjust antenna direction if needed.

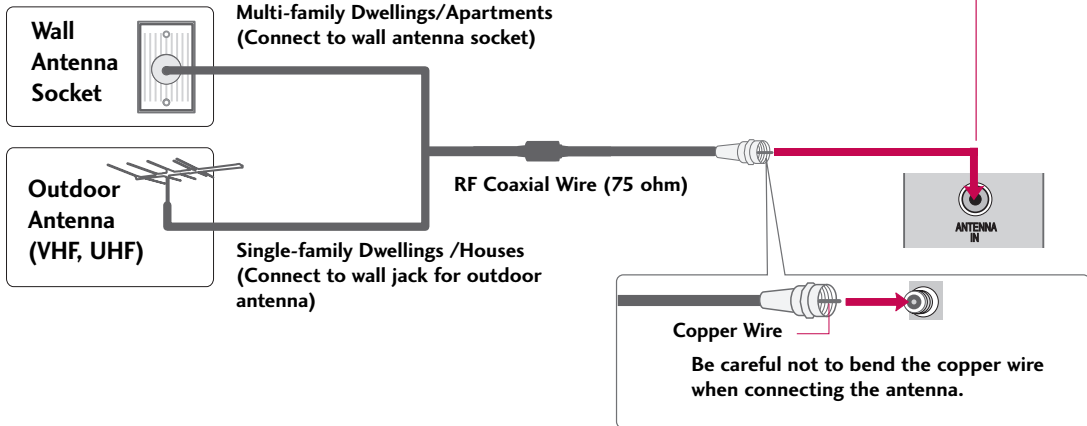

### 2. Cable

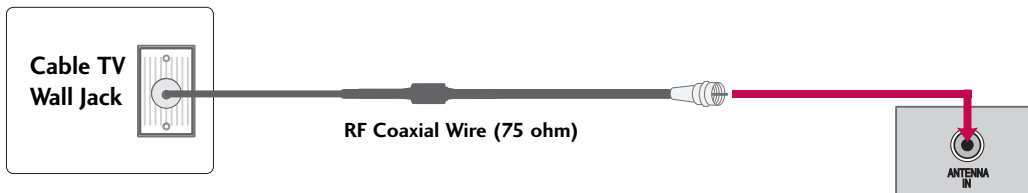

- To improve the picture quality in a poor signal area, please purchase a signal amplifier and install properly.
- If the antenna needs to be split for two TV's, install a 2-Way Signal Splitter.
- If the antenna is not installed properly, contact your dealer for assistance.

# EXTERNAL EQUIPMENT SETUP

- To prevent the equipment damage, never plug in any power cords until you have finished connecting all equipment.
- This part of EXTERNAL EQUIPMENT SETUP mainly use picture for **26/32/37/42LH20R**.

## HD RECEIVER SETUP

### Component Connection

#### 1. How to connect

- 1 Connect the video outputs (Y, Pb, Pr) of the digital set-top box to the **COMPONENT IN VIDEO\*** or **COMPONENT IN VIDEO 1\*/2\*** jacks on the TV. Match the jack colors (Y = green, Pb = blue, and Pr = red).
- 2 Connect the audio output of the digital set-top box to the **COMPONENT IN AUDIO\*** or **COMPONENT IN AUDIO 1\*/2\*** jacks on the TV.

#### \* COMPONENT IN VIDEO/AUDIO

: For 19/22/26/32/37/42LH20R, 32/42LF20FR, 32/37/42/47LH30FR, 19LU50R, 22/26LU50FR

#### \* COMPONENT IN VIDEO 1/AUDIO 1, COMPONENT IN VIDEO 2/AUDIO 2

: For 32/42/47LH70YR

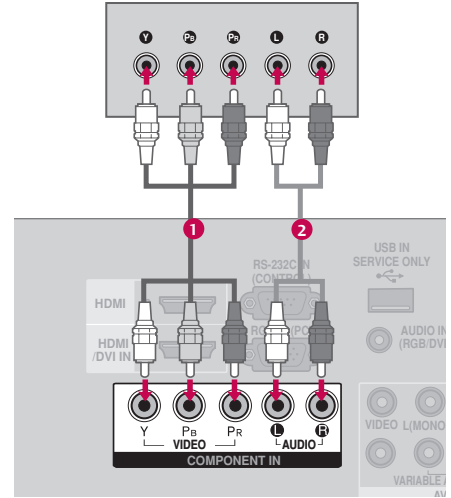

#### 2. How to use

- Turn on the digital set-top box.  
(Refer to the owner's manual for the digital set-top box operation.)
- Select the **Component\*** or **Component1\*/2\*** input source on the TV using the **INPUT** button on the remote control.

\* **Component:** For 19/22/26/32/37/42LH20R, 32/42LF20FR, 32/37/42/47LH30FR, 19LU50R, 22/26LU50FR

\* **Component1/2:** For 32/42/47LH70YR

#### Supported Resolutions

Signal	Component	HDMI
480i	Yes	No
480p	Yes	Yes
720p	Yes	Yes
1080i	Yes	Yes
1080p	Yes (50/60Hz only)	Yes (24/30/50/60Hz)

#### Y, Cb/Pb, Cr/Pr

Resolution	Horizontal Frequency(KHz)	Vertical Frequency(Hz)
720x480i	15.73	59.94
	15.75	60.00
720x480p	31.47	59.94
	31.50	60.00
720x576i	15.625	50.00
	31.25	50.00
		31.25
1280x720p	44.96	59.94
	45.00	60.00
	37.50	50.00
1920x1080i	28.125	50.00
	33.72	59.94
	33.75	60.00
1920x1080p	56.25	50.00
	67.432	59.94
	67.50	60.00

## HDMI Connection

### 1. How to connect

**1** Connect the digital set-top box to the **HDMI/DVI IN\***, **HDMI/DVI IN 1\*** or **HDMI/DVI IN 1 (DVI)\***, **HDMI 2\*** or **HDMI IN 2\*/3\*** jack on the TV.

**2** No separate audio connection is necessary. HDMI supports both audio and video.

\* **HDMI/DVI IN:** For 19/22LH20R

\* **HDMI/DVI IN 1, HDMI 2:** For 26/32/37/42LH20R, 32/37/42/47LH30FR, 19LU50R, 22/26LU50FR

\* **HDMI/DVI IN 1, HDMI IN 2:** For 32/42LF20FR

\* **HDMI IN 3:** For 32/37/42/47LH30FR, 26LU50FR

\* **HDMI/DVI IN 1 (DVI), HDMI IN 2/3:** For 32/42/47LH70YR

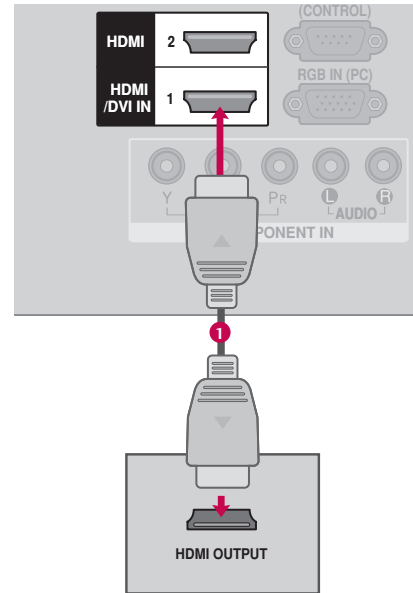

### 2. How to use

- Turn on the digital set-top box. (Refer to the owner's manual for the digital set-top box.)
- Select the **HDMI\*** or **HDMI1\*/2\*/3\*** input source on the TV using the **INPUT** button on the remote control.

\* **HDMI:** For 19/22LH20R

\* **HDMI1/2:** For 26/32/37/42LH20R, 32/42LF20FR, 32/37/42/47LH30FR, 19LU50R, 22/26LU50FR, 32/42/47LH70YR

\* **HDMI3:** For 32/37/42/47LH30FR, 26LU50FR, 32/42/47LH70YR

#### ! NOTE

- ▶ Check HDMI cable over version 1.3. If the HDMI cables don't support HDMI version 1.3, it can cause flickers or no screen display. In this case use the latest cables that support HDMI version 1.3.
- ▶ HDMI mode supports PCM audio format only.
- ▶ If the Audio setting is set to Dolby/DTS/Bitstream in some DVD/STB, make sure to change the setting to PCM.

#### HDMI-DTV mode

Resolution	Horizontal Frequency(kHz)	Vertical Frequency(Hz)
720x480	31.47	59.94
	31.50	60.00
720x576	31.25	50.00
1280x720	44.96	59.94
	45.00	60.00
	37.50	50.00
1920x1080i	33.72	59.94
	33.75	60.00
	28.125	50.00
1920x1080p	67.432	59.94
	67.50	60.00
	56.25	50.00
	27.00	24.00
	33.75	30.00

# EXTERNAL EQUIPMENT SETUP

## DVI to HDMI Connection

### 1. How to connect

- 1 Connect the DVI output of the digital set-top box to the **HDMI/DVI IN\***, **HDMI/DVI IN 1\***, or **HDMI/DVI IN 1 (DVI)\*** jack on the TV.
- 2 Connect the digital set-top box audio output to the **AUDIO IN (RGB/DVI)** jack on the TV.

- \* **HDMI/DVI IN:** For 19/22LH20R
- \* **HDMI/DVI IN 1:** For 26/32/37/42LH20R, 32/42LF20FR, 32/37/42/47LH30FR, 19LU50R, 22/26LU50FR
- \* **HDMI/DVI IN 1 (DVI):** For 32/42/47LH70YR

### 2. How to use

- Turn on the digital set-top box.  
(Refer to the owner's manual for the digital set-top box.)
- Select the **HDMI\***, or **HDMI1\*** input source on the TV using the **INPUT** button on the remote control.
- \* **HDMI:** For 19/22LH20R
- \* **HDMI1:** For 26/32/37/42LH20R, 32/42LF20FR, 32/37/42/47LH30FR, 32/42/47LH70YR, 19LU50R, 22/26LU50FR

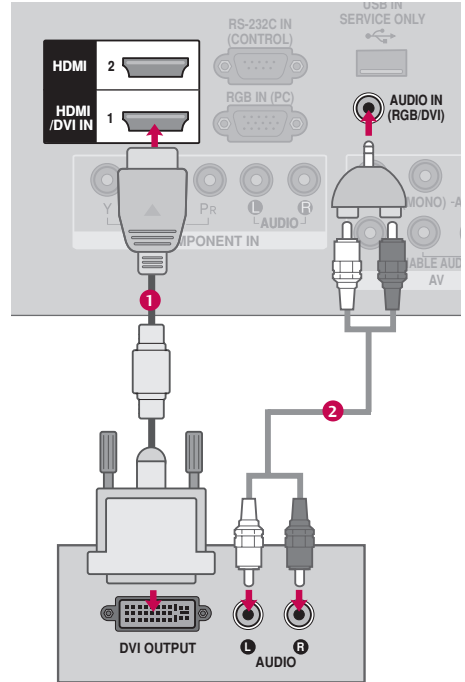

### NOTE

- ▶ A DVI to HDMI cable or adapter is required for this connection. DVI doesn't support audio, so a separate audio connection is necessary.
- ▶ HDMI mode supports PCM audio format only.
- ▶ If the Audio setting is set to Dolby/DTS/Bitstream in some DVD/STB, make sure to change the setting to PCM.

# DVD SETUP

## Component Connection

### 1. How to connect

- 1 Connect the video outputs (Y, Pb, Pr) of the DVD to the **COMPONENT IN VIDEO\*** or **COMPONENT IN VIDEO 1\*/2\*** jacks on the TV. Match the jack colors (Y = green, Pb = blue, and Pr = red).
- 2 Connect the audio outputs of the DVD to the **COMPONENT IN AUDIO\*** or **COMPONENT IN AUDIO 1\*/2\*** jacks on the TV.

- \* **COMPONENT IN VIDEO/AUDIO**  
: For 19/22/26/32/37/42LH20R, 32/42LF20FR, 32/37/42/47LH30FR, 19LU50R, 22/26LU50FR
- \* **COMPONENT IN VIDEO 1/AUDIO 1, COMPONENT IN VIDEO 2/AUDIO 2**  
: For 32/42/47LH70YR

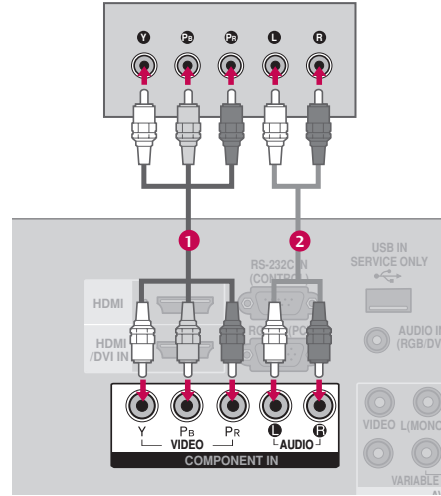

### 2. How to use

- Turn on the DVD player, insert a DVD.
- Select the **Component\*** or **Component 1\*/2\*** input source on the TV using the **INPUT** button on the remote control.
- Refer to the DVD player's manual for operating instructions.
- \* **Component:** For 19/22/26/32/37/42LH20R, 32/42LF20FR, 32/37/42/47LH30FR, 19LU50R, 22/26LU50FR
- \* **Component 1/2:** For 32/42/47LH70YR

### Component Input ports

To get better picture quality, connect a DVD player to the component input ports as shown below.

Component ports on the TV	Y	Pb	Pr
Video output ports on DVD player	Y	Pb	Pr
	Y	B-Y	R-Y
	Y	Cb	Cr
	Y	Pb	Pr

# EXTERNAL EQUIPMENT SETUP

## Composite (RCA) Connection

### 1. How to connect

- 1 Connect the **AUDIO/VIDEO** jacks between TV and DVD. Match the jack colors (Video = yellow, Audio Left = white, and Audio Right = red).

### 2. How to use

- Turn on the DVD player, insert a DVD.
- Select the **AV\*** or **AV1\*/2\*** input source on the TV using the **INPUT** button on the remote control.
- Refer to the DVD player's manual for operating instructions.

\* **AV:** For 19/22/26/32/37/42LH20R, 19LU50R, 22LU50FR

\* **AV1/2:** For 32/42LF20FR, 32/37/42/47LH30FR, 26LU50FR, 32/42/47LH70YR

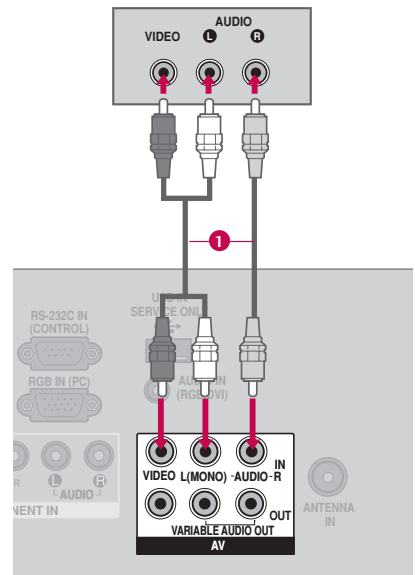

## HDMI Connection

### 1. How to connect

- 1 Connect the HDMI output of the DVD to the **HDMI/DVI IN\***, **HDMI/DVI IN 1\***, **HDMI/DVI IN 1 (DVI)\***, **HDMI 2\*** or **HDMI IN 2\*/3\*** jack on the TV.
- 2 No separated audio connection is necessary. HDMI supports both audio and video.

\* **HDMI/DVI IN:** For 19/22LH20R

\* **HDMI/DVI IN 1, HDMI 2:** For 26/32/37/42LH20R, 32/37/42/47LH30FR, 19LU50R, 22/26LU50FR

\* **HDMI/DVI IN 1, HDMI IN 2:** For 32/42LF20FR

\* **HDMI IN 3:** For 32/37/42/47LH30FR, 26LU50FR

\* **HDMI/DVI IN 1 (DVI), HDMI IN 2/3:** For 32/42/47LH70YR

### 2. How to use

- Select the **HDMI\*** or **HDMI1\*/2\*/3\*** input source on the TV using the **INPUT** button on the remote control.
- Refer to the DVD player's manual for operating instructions.

\* **HDMI:** For 19/22LH20R

\* **HDMI1/2:** For 26/32/37/42LH20R, 32/42LF20FR, 32/37/42/47LH30FR, 19LU50R, 22/26LU50FR, 32/42/47LH70YR

\* **HDMI3:** For 32/37/42/47LH30FR, 26LU50FR, 32/42/47LH70YR

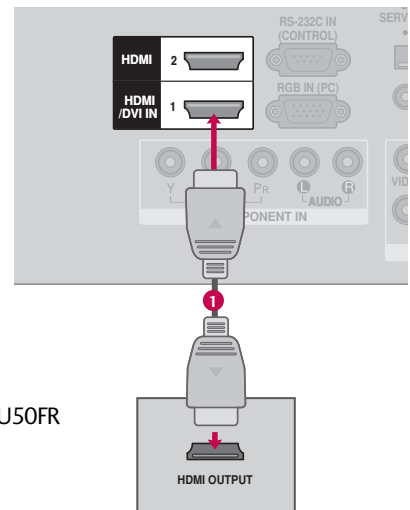

### NOTE

- ▶ Check HDMI cable over version 1.3. If the HDMI cables don't support HDMI version 1.3, it can cause flickers or no screen display. In this case use the latest cables that support HDMI version 1.3.
- ▶ HDMI mode supports PCM audio format only.
- ▶ If the Audio setting is set to Dolby/DTS/Bitstream in some DVD/STB, make sure to change the setting to PCM.



# VCR SETUP

## Antenna Connection

### 1. How to connect

- 1 Connect the RF antenna out socket of the VCR to the **ANTENNA IN** socket on the TV.
- 2 Connect the antenna cable to the RF antenna in socket of the VCR.

### 2. How to use

- Set VCR output switch to 3 or 4 and then tune TV to the same channel number.
- Insert a video tape into the VCR and press PLAY on the VCR. (Refer to the VCR owner's manual.)

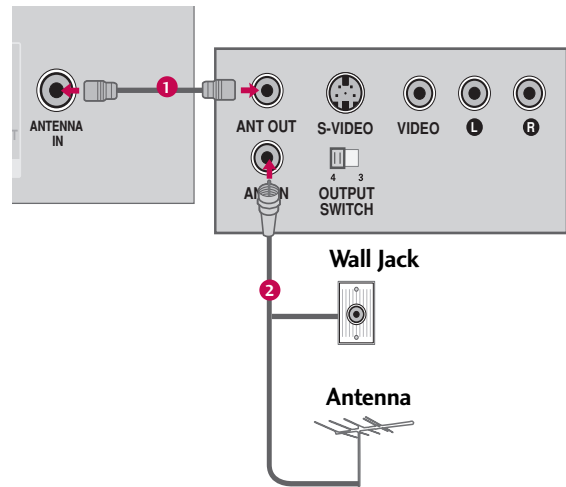

# EXTERNAL EQUIPMENT SETUP

## Composite (RCA) Connection

### 1. How to connect

- 1 Connect the **AUDIO/VIDEO** jacks between TV and VCR. Match the jack colors (Video = yellow, Audio Left = white, and Audio Right = red)

### 2. How to use

- Insert a video tape into the VCR and press PLAY on the VCR. (Refer to the VCR owner's manual.)
- Select the **AV\*** or **AV1\*/2\*** input source on the TV using the **INPUT** button on the remote control.

\* **AV**: For 19/22/26/32/37/42LH20R, 19LU50R, 22LU50FR

\* **AV1/2**: For 32/42LF20FR, 32/37/42/47LH30FR, 26LU50FR, 32/42/47LH70YR

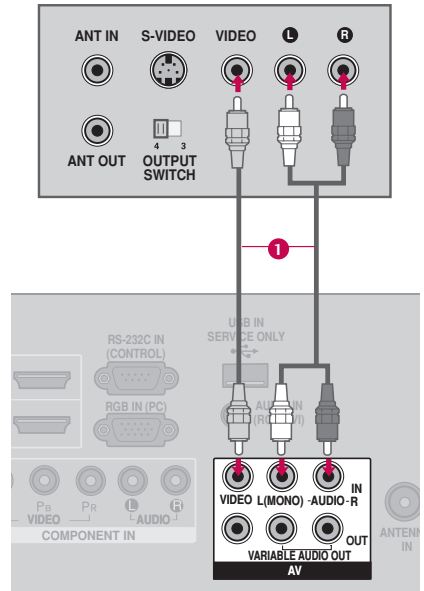

### ! NOTE

- ▶ If you have a mono VCR, connect the audio cable from the VCR to the **AUDIO L/(MONO)\*** or **AUDIO L/MONO\*** jack of the TV.

\* **AUDIO L/(MONO)**: For 19/22/26/32/37/42LH20R, 32/42LF20FR, 32/37/42/47LH30FR, 19LU50R, 22/26LU50FR

\* **AUDIO L/MONO**: For 32/42/47LH70YR

# OTHER A/V SOURCE SETUP

## 1. How to connect

- 1 Connect the **AUDIO/VIDEO** jacks between TV and external equipment. Match the jack colors. (Video = yellow, Audio Left = white, and Audio Right = red)

## 2. How to use

- Select the **AV\*** or **AV1\*/2\*** input source on the TV using the **INPUT** button on the remote control.
- Operate the corresponding external equipment.

\* **AV**: For 19/22/26/32/37/42LH20R, 19LU50R, 22LU50FR

\* **AV1/2**: For 32/42LF20FR, 32/37/42/47LH30FR, 26LU50FR, 32/42/47LH70YR

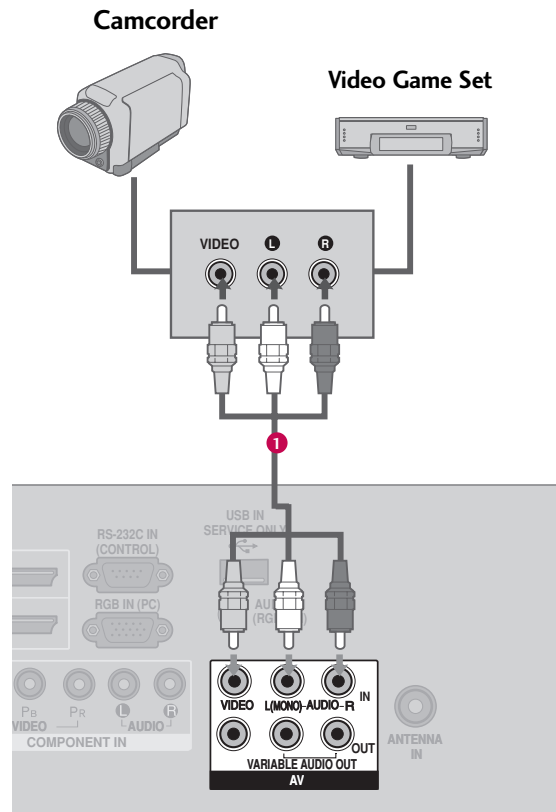

# EXTERNAL EQUIPMENT SETUP

## PC SETUP

This TV provides Plug and Play capability, meaning that the PC adjusts automatically to the TV's settings.

### VGA (D-Sub 15 pin) Connection

#### 1. How to connect

- 1 Connect the VGA output of the PC to the **RGB IN (PC)** jack on the TV.
- 2 Connect the PC audio output to the **AUDIO IN (RGB/DVI)** jack on the TV.

#### 2. How to use

- Turn on the PC and the TV.
- Select the **RGB-PC** input source on the TV using the **INPUT** button on the remote control.

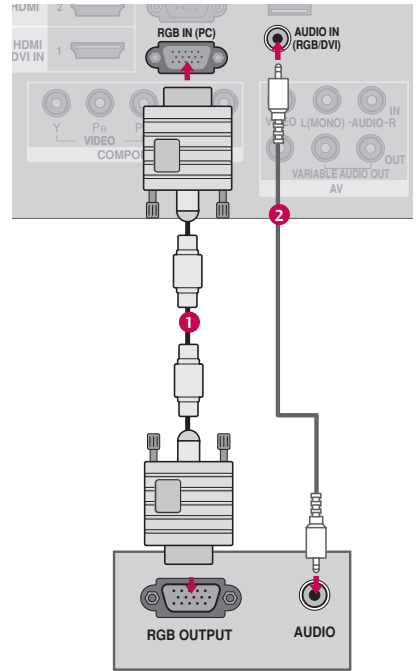

**NOTES**

- ▶ 19/22/26/32/37/42LH20R, 19LU50R: To get the best picture quality, adjust the PC graphics card to 1360x768.
- ▶ 32/42LF20FR, 32/37/42/47LH30FR, 22/26LU50FR, 32/42/47LH70YR: To get the best picture quality, adjust the PC graphics card to 1920x1080.
- ▶ In PC mode, there may be noise associated with the resolution, vertical pattern, contrast or brightness. If noise is present, change the PC output to another resolution, change the refresh rate to another rate or adjust the brightness and contrast on the PICTURE menu until the picture is clear.
- ▶ Avoid keeping a fixed image on the screen for a long period of time. The fixed image could become permanently imprinted on the screen.
- ▶ The synchronization input form for Horizontal and Vertical frequencies is separate.
- ▶ Depending on the graphics card, some resolution settings may not allow the image to be positioned on the screen properly.

**Supported Display Specifications****RGB-PC mode**

Resolution	Horizontal Frequency(KHz)	Vertical Frequency(Hz)
640x350	31.468	70.09
720x400	31.469	70.09
640x480	31.469	59.94
800x600	37.879	60.317
1024x768	48.363	60.004
1280x768	47.776	59.87
1360x768	47.72	59.799
1280x1024	63.668	59.895
1920x1080	66.587	59.934

Except 19/22/26/32/37/42LH20R.  
19LU50R







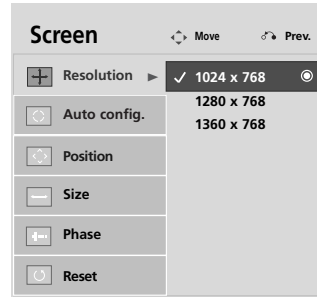
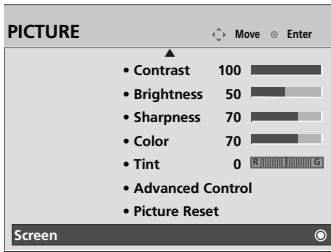

# EXTERNAL EQUIPMENT SETUP

## Screen Setup for PC mode

### Selecting Resolution

You can choose the resolution in RGB-PC mode.  
The **Position**, **Phase**, and **Size** can also be adjusted.



-   Select **PICTURE**.
-   Select **Screen**.
-   Select **Resolution**.
-   Select the desired resolution.
- 

## Auto Configure

Automatically adjusts picture position and minimizes image instability. After adjustment, if the image is still not correct, try using the manual settings or a different resolution or refresh rate on the PC.



1   Select **PICTURE**.

2   Select **Screen**.

3   Select **Auto config..**

4   Select **Yes**.

5  Start Auto Configuration.

- If the position of the image is still not correct, try Auto adjustment again.
- If picture needs to be adjusted again after Auto adjustment in RGB-PC, you can adjust the **Position**, **Size** or **Phase**.

# EXTERNAL EQUIPMENT SETUP









## Adjustment for screen Position, Size, and Phase

If the picture is not clear after auto adjustment and especially if characters are still trembling, adjust the picture phase manually.

**Position:** This feature operates only in Component(except 480i, 576i) and RGB-PC mode.

**Size, Phase:** This feature operates only in RGB-PC mode.



-   Select **PICTURE**.
-   Select **Screen**.
-   Select **Position, Size, or Phase**.
-   Make appropriate adjustments.
- 

- **Position:** This function is to adjust picture to left/right and up/down as you prefer.
- **Size:** This function is to minimize any vertical bars or stripes visible on the screen background. And the horizontal screen size will also change.
- **Phase:** This function allows you to remove any horizontal noise and clear or sharpen the image of characters.











## Screen Reset (Reset to original factory values)

Returns **Position**, **Size**, and **Phase** to the default factory settings.

This feature operates only in Component(except 480i, 576i) and RGB-PC mode.



- 1   Select **PICTURE**.
- 2   Select **Screen**.
- 3   Select **Reset**.
- 4   Select **Yes**.
- 5 

# EXTERNAL EQUIPMENT SETUP

## USB CONNECTION

Except 19/22/26/32/37/42LH20R, 32/42LF20FR, 19LU50R, 22/26LU50FR

- Image shown may differ from your TV.

For 32/37/42/47LH30FR

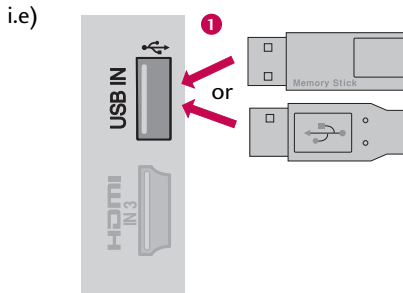

For 32/42/47LH70YR

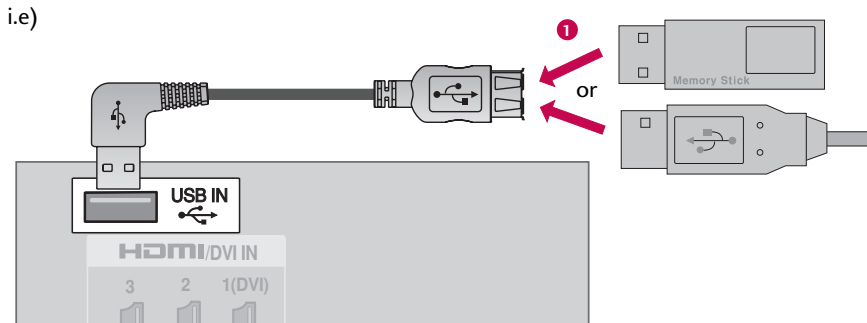

### 1. How to connect

- 1 Connect the USB device to the **USB IN** jack on the TV.

### 2. How to use

- After connecting the **USB IN** jack, you use the USB function.  
(▶ p. 70)

## VARIABLE OUT

Send the TV's audio to external audio equipment via the Audio Output port.

### 1. How to connect

- 1 Connect audio outputs to the TV's **VARIABLE AUDIO OUT** jacks.
- 2 Set up your speakers through your analog stereo amplifier, according to the instructions provided with the amplifier.

#### NOTE

- ▶ When connecting with external audio equipments, such as amplifiers or speakers, you can turn the TV speakers off in the menu. (▶ p.100)
- ▶ Select **Variable Out** in Audio menu to connect the **VARIABLE AUDIO OUT** jacks. (▶ p.101)

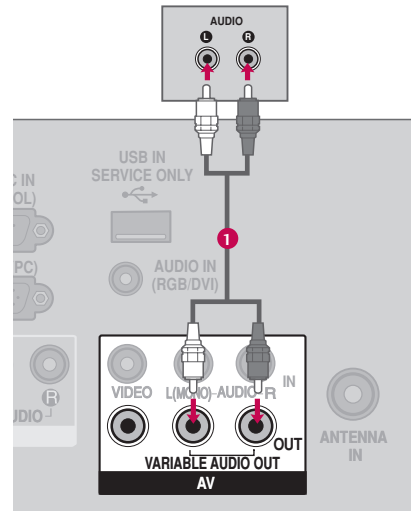

## MONITOR OUT

The TV has a special signal output capability which allows you to hook up the second TV or monitor.

### 1. How to connect

- 1 Connect the second TV or monitor to the TV's **AV OUT** jacks.
- 2 See the Operating Manual of the second TV or monitor for further details regarding that device's input settings.

#### NOTE

- ▶ Component, RGB, HDMI input sources cannot be used for AV out.
- ▶ We recommend to use the AV OUT jacks for VCR recording.

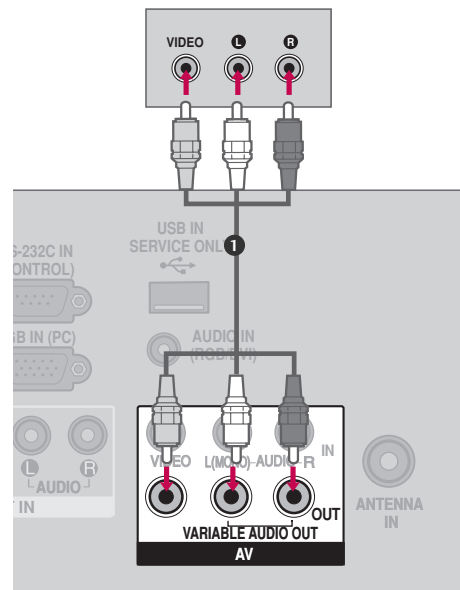

# WATCHING TV / CHANNEL CONTROL

## REMOTE CONTROL FUNCTIONS

When using the remote control, aim it at the remote control sensor on the TV.

- Image shown may differ from your TV.

### For 32/37/42/47LH30FR

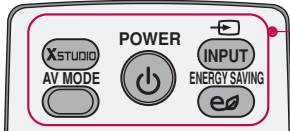

### For 19/22/26/32/37/42LH20R, 32/42LF20FR, 19LU50R, 22/26LU50FR

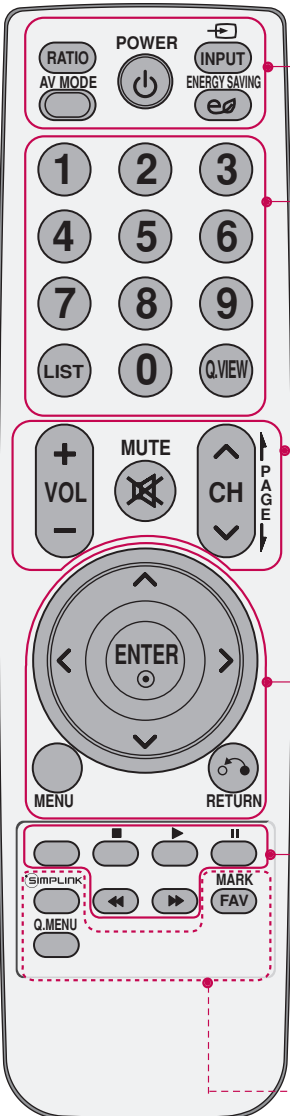

**X STUDIO** Select the Photo/Music/Movie list.  
(Except 19/22/26/32/37/42LH20R)

**RATIO** Changes the aspect ratio of the video. (Except 32/37/42/47LH30FR) ▶ p.82

**AV MODE** Toggles through preset Video and Audio modes. ▶ p.58

**POWER** Turns the TV on from standby or off to standby.

**INPUT** Rotates through inputs.  
Also switches the TV on from standby. ▶ p.56

**ENERGY SAVING** Adjusts the Energy Saving. ▶ p.90

**NUMBER button** Used to enter a program number for multiple program channels.

**LIST** Displays the channel list. ▶ p.53

**Q.VIEW** Tunes to the last channel viewed.

**VOLUME UP /DOWN** Adjusts the volume.

**MUTE** Switches the sound on or off. ▶ p.46

**CHANNEL UP/DOWN** Changes the channel.

**PAGE UP/DOWN** Moves from one full set of screen information to the next one.

**THUMBSTICK (Up/Down/Left Right/ENTER)** Navigates the on-screen menus and adjusts the system settings to your preference.

**MENU** Displays the main menu or clears all on-screen displays and return to TV viewing.

**RETURN** Allows the user to move return one step in an interactive application or other user interaction function.

**SIMPLINK Control buttons** Controls the SIMPLINK compatible devices.

**Q.MENU** Opens the list of Quick Menu options. ▶ p.49

**SIMPLINK** See a list of AV devices connected to TV.  
When you toggle this button, the SIMPLINK menu appears at the screen. ▶ p.60-61

**FAV** Scroll through the programmed Favorite channels. ▶ p.54

**MARK** Use to mark or unmark a photo/music/movie.

For 42/47/55LH50YR,  
32/42/47LH70YR



**RATIO** Changes the aspect ratio of the video. ▶ p.82

**POWER** Turns the TV on from standby or off to standby.

**INPUT** Rotates through inputs.  
Also switches the TV on from standby. ▶ p.56

**SLEEP** Select the amount of time before your TV turns off automatically. ▶ p.108

**ENERGY SAVING** Adjusts the Energy Saving. ▶ p.90

**SIMPLINK** See a list of AV devices connected to TV.  
When you toggle this button, the SIMPLINK menu appears at the screen. ▶ p.60-61

**Q.MENU** Opens the list of Quick Menu options. ▶ p.49

**MENU** Displays the main menu or clears all on-screen displays and return to TV viewing.

**THUMBSTICK** Navigates the on-screen menus and adjusts the system settings to your preference.  
(Up/Down/Left Right/ENTER)

**RETURN** Allows the user to move return one step in an interactive application or other user interaction function.

**X STUDIO** Select the Photo/Music/Movie list.

**AV MODE** Toggles through preset Video and Audio modes. ▶ p.58

**VOLUME UP /DOWN** Adjusts the volume.

**FAV** Scroll through the programmed Favorite channels. ▶ p.54

**MARK** Use to mark or unmark a photo/music/movie.

**MUTE** Switches the sound on or off. ▶ p.46

**CHANNEL UP/DOWN** Changes the channel.

**PAGE UP/DOWN** Moves from one full set of screen information to the next one.

**NUMBER button** Used to enter a program number for multiple program channels.

**LIST** Displays the channel list. ▶ p.53

**Q.VIEW** Tunes to the last channel viewed.

**USB, SIMPLINK Control buttons** ◦ Controls the SIMPLINK compatible devices.  
◦ Controls the USB menu.

## Installing Batteries

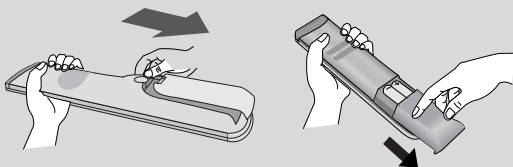

■ Open the battery compartment cover on the back side and install the batteries matching correct polarity.

■ Install two 1.5V AAA batteries. Don't mix old or used batteries with new ones.

■ Close cover.

# WATCHING TV / CHANNEL CONTROL

## TURNING ON THE TV

---

- 1** First, connect power cord correctly and switch the AC power control switch on TV. At this moment, the TV switches to standby mode.
    - In standby mode to turn TV on, press the **⏻/|**, **INPUT**, **CH (▲ ▼ or ^ ∨)** button on the TV or press the **POWER**, **INPUT**, **TV**, **CH (^ or ∨)**, **Number (0~9)** button on the remote control.
  - 2** Select the viewing source by using the **INPUT** button on the remote control.
    - This TV is programmed to remember which power state it was last set to, even if the power cord is out.
  - 3** When finished using the TV, press the **POWER** button on the remote control. The TV reverts to standby mode.
- 

### ! NOTE

- ▶ If you intend to be away on vacation, disconnect the power plug from the wall power outlet.
- ▶ If you do not complete the **Initial setting**, the it will appear whenever the TV is switched on until the **Initial setting** procedure is completed.
- ▶ If this TV is unplugged once or turn off with the AC power control switch on the TV, reset the **Clock** function.

## CHANNEL SELECTION

---

- 1** Press the **CH (^ or ∨)** or **NUMBER** buttons to select a channel number.
- 

## VOLUME ADJUSTMENT

Adjust the volume to suit your personal preference.

---

- 1** Press the **VOL (+ or -)** button to adjust the volume.
  - 2** If you want to switch the sound off, press the **MUTE** button.
  - 3** You can cancel the Mute function by pressing the **MUTE**, **VOL (+ or -)** or **AV MODE** button.
-

# INITIALIZING SETUP (MODE SETTING)

This Function guides the user to easily set the essential items for viewing the TV for the first time when purchasing the TV. It will be displayed on the screen when turning the TV on for the first time. It can also be activated from the user menus.

- Default selection is “**Home Use**”. We recommend setting the TV to “**Home Use**” mode for the best picture in your home environment.
- “**Store Demo**” mode is only intended for use in retail environments. Customers can adjust the “**Picture** menu - **Picture Mode**” manually while inspecting the TV, but the TV will automatically return to preset in-store mode after 5 minutes.
- “**Store Demo**” mode is an optimal setting for displaying at stores. “**Store Demo**” mode initializes the TV to set the image quality.
- You can also adjust **Mode Setting** in the **OPTION** menu.
- Factory defaults are set when you choose “**Home Use**”.

## Step1. Welcome

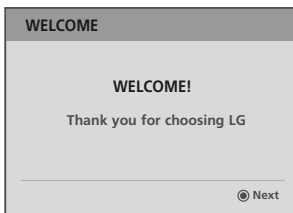

## Step3. Mode Setting



Select **Home Use** Mode.



## Step2. Selecting Language

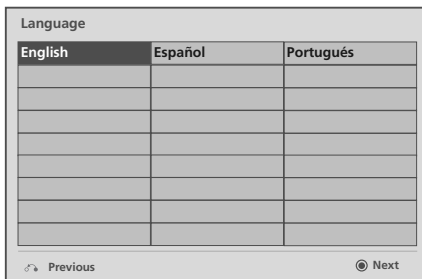

Select **Language**.



## Step4. Auto Tuning

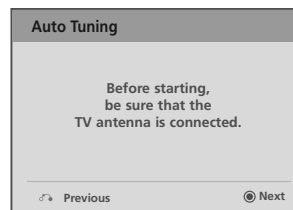





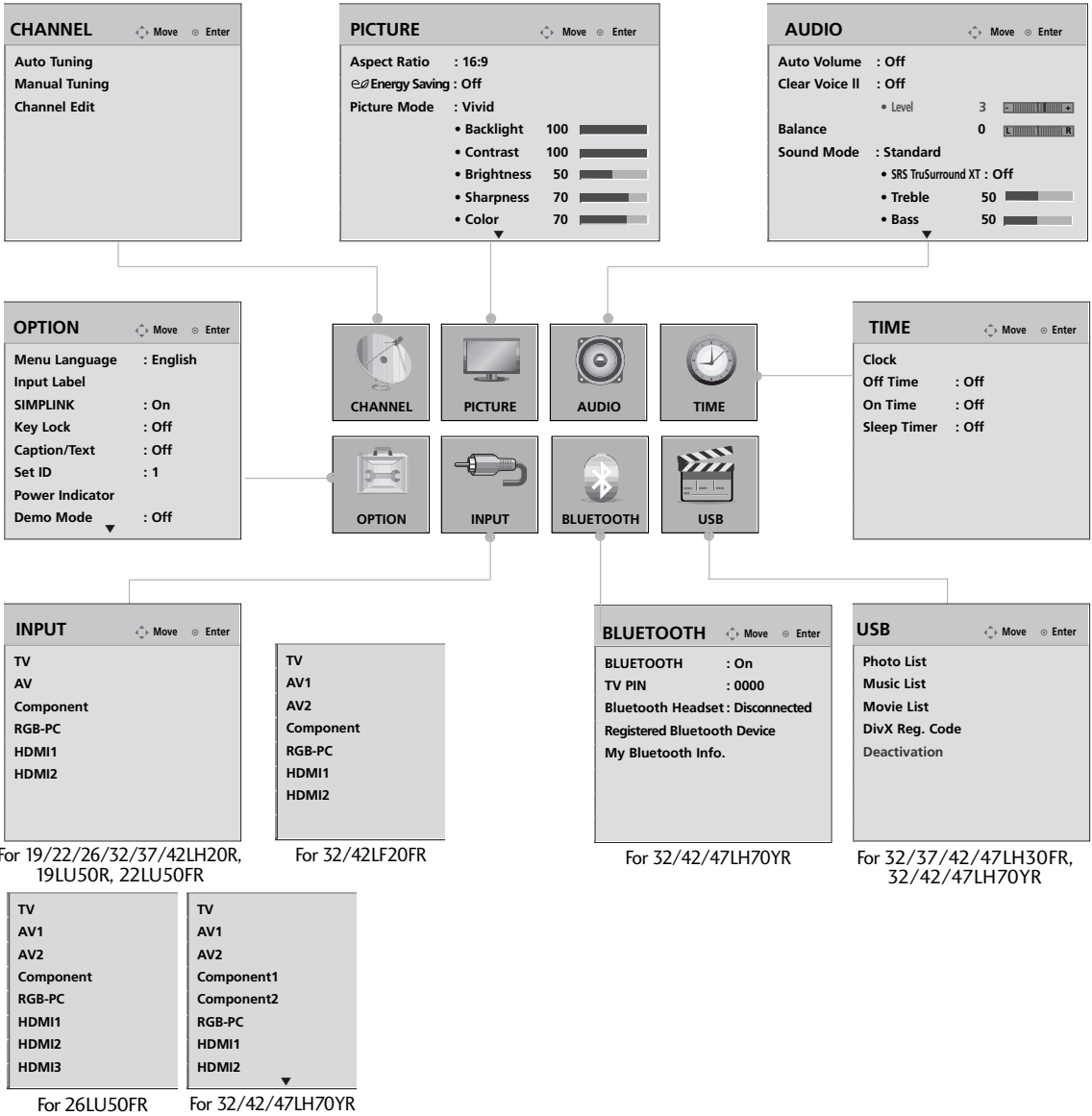

Start **Auto Tuning**.

# WATCHING TV / CHANNEL CONTROL

## ON-SCREEN MENUS SELECTION

Your TV's OSD (On Screen Display) may differ slightly from that shown in this manual.



- 1   Display each menu.
- 2   Select a menu item.
- 3  Accept the current selection.
- 4  Return to TV viewing.



## QUICK MENU

Your TV's OSD (On Screen Display) may differ slightly from what is shown in this manual.

Q.Menu (Quick Menu) is a menu of features which users might use frequently.

- **Aspect Ratio:** Selects your desired picture format.
- **Picture Mode:** Selects the factory preset picture depend on the viewing environment.
- **Sound Mode:** Selects the factory preset sound for type of program.
- **Caption/Text:** Select on or off.
- **SAP:** Selects MTS sound.
- **Sleep Timer:** Select the amount of time before your TV turns off automatically.
- **Del/Add/Fav:** Select channel you want to add/delete or add the channel to the Favorite List.
- **Energy Saving:** Selects the Energy saving mode.
- **USB Device:** Select "Eject" in order to eject a USB device.

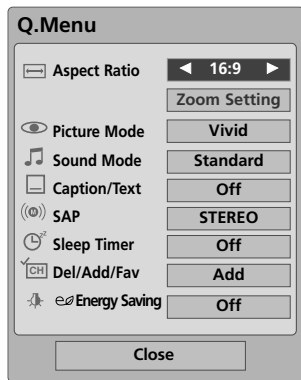

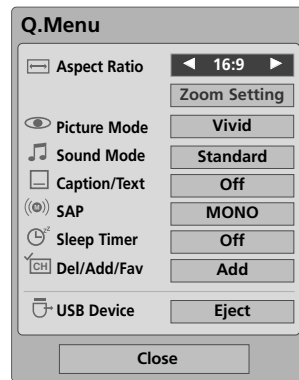

For 19/22/26/32/37/42LH20R,  
32/42LF20FR, 19LU50R,  
22/26LU50FR



For 32/37/42/47LH30FR,  
32/42/47LH70YR

1   Display each menu.

2  Make appropriate adjustments.

3  Return to TV viewing.







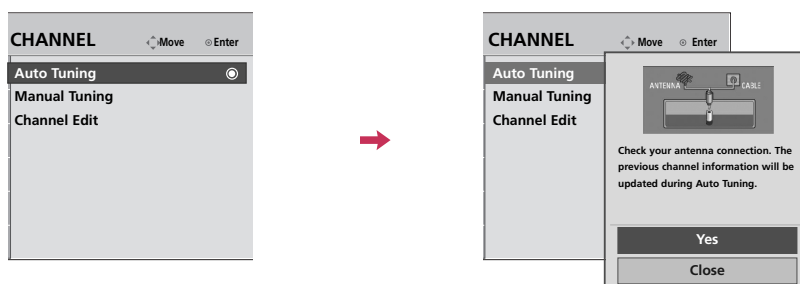

# WATCHING TV / CHANNEL CONTROL

## CHANNEL SETUP

### Auto Scan (Auto Tuning)









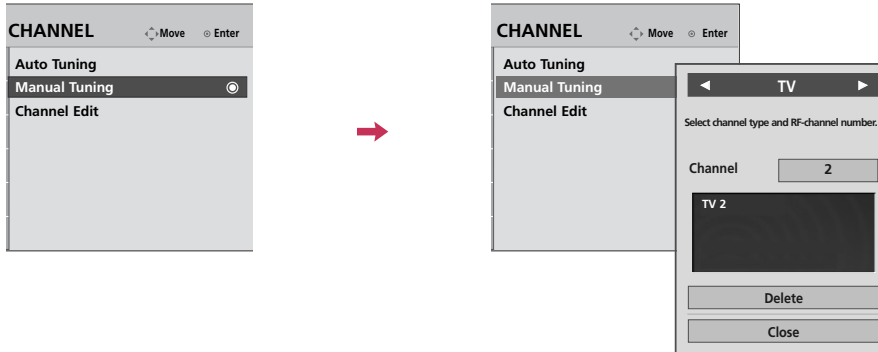



Automatically finds all channels available through antenna or cable inputs, and stores them in memory on the channel list.



-   Select **CHANNEL**.
-   Select **Auto Tuning**.
-   Select **Start**.
-  Run **Auto tuning**.
-  Return to the previous menu.
-  Return to TV viewing.

## Add/Delete Channel (Manual Tuning)



- 1   Select **CHANNEL**.
- 2   Select **Manual Tuning**.
- 3   Select **TV** or **CATV**.
- 4   Select channel you want to add or delete.
- 5   Select **Add** or **Delete**.
- 6  Return to the previous menu.
-  Return to TV viewing.

# WATCHING TV / CHANNEL CONTROL



## Channel Editing

The channels in the Channel Edit List are displayed in black and the channels deleted from the Channel Edit List are displayed in blue.

When a channel number is deleted, it means that you will be unable to select it using **CH** ^ v button during TV viewing.

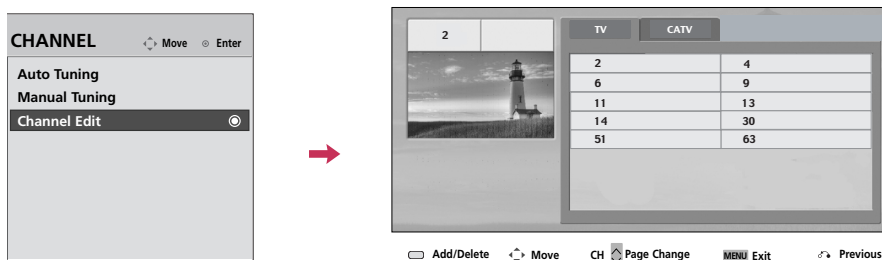
If you wish to select the deleted channel, directly enter the channel number with the NUMBER buttons or select it in the **Channel Edit** menu.



-   Select **CHANNEL**.
-   Select **Channel Edit**.
-   Select a channel.
-  Select channel you want to add or delete.
-  Return to the previous menu.
-  Return to TV viewing.

# CHANNEL LIST



You can check channels which are stored in the memory by displaying the channel list.





## Displaying channel list

- 1  Display the **Channel List**.

## Selecting a channel in the channel list

- 1  Select a channel.
- 2  Switch to the chosen channel number.

## Paging through a channel list

- 1  Turn the pages.
- 2  Return to TV viewing.

# WATCHING TV / CHANNEL CONTROL

## FAVORITE CHANNEL SETUP

Favorite Channels are a convenient feature that lets you quickly select channels to channels of your choice without waiting for the TV to select through all the in-between channels.

To tune to a favorite channel, press the **FAV** (favorite) button repeatedly.

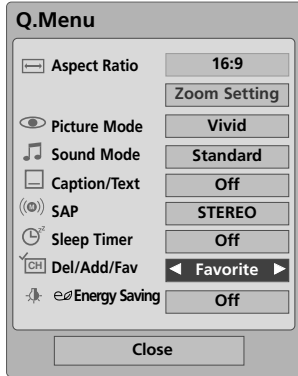

For 19/22/26/32/37/42LH20R,  
32/42LF20FR, 19LU50R,  
22/26LU50FR

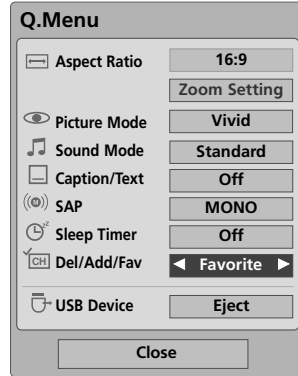

For 32/37/42/47LH30FR,  
32/42/47LH70YR

1 Select your desired channel.

2 Select **Del/Add/Fav**.

3 Select **Favorite**.

4 Return to TV viewing.

# FAVORITE CHANNEL LIST





---

## Displaying the favorite channel list

- 1  Display the Favorite Channel List.



---

## Selecting a channel in the favorite channel list

- 1  Select a channel.
- 2  Switch to the chosen channel number.

---

## Paging through a favorite channel list

- 1  Turn the pages.
- 2  Return to TV viewing.

# WATCHING TV / CHANNEL CONTROL

## INPUT LIST

■ Image shown may differ from your TV.

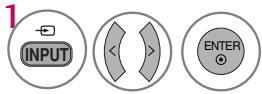

Select the desired input source.

19/22LH20R:

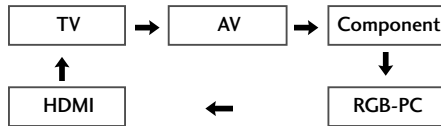

26/32/37/42LH20R,  
19LU50R, 22LU50FR:

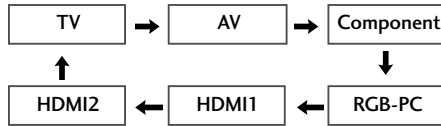

32/42LF20FR:

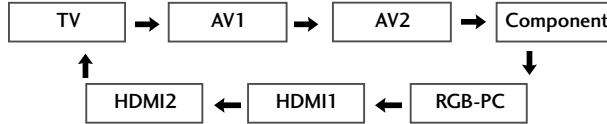

32/37/42/47LH30FR,  
26LU50FR:

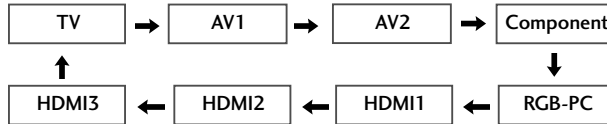

32/42/47LH70YR:

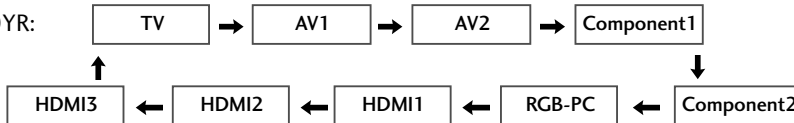

- **TV:** Select it to watch over-the-air and cable broadcasts.
- **AV:** Select them to watch a VCR or other external equipment.
- **Component:** Select them to watch DVD or a Digital set-top box.
- **RGB-PC:** Select it to view PC input.
- **HDMI:** Select them to watch high definition devices.







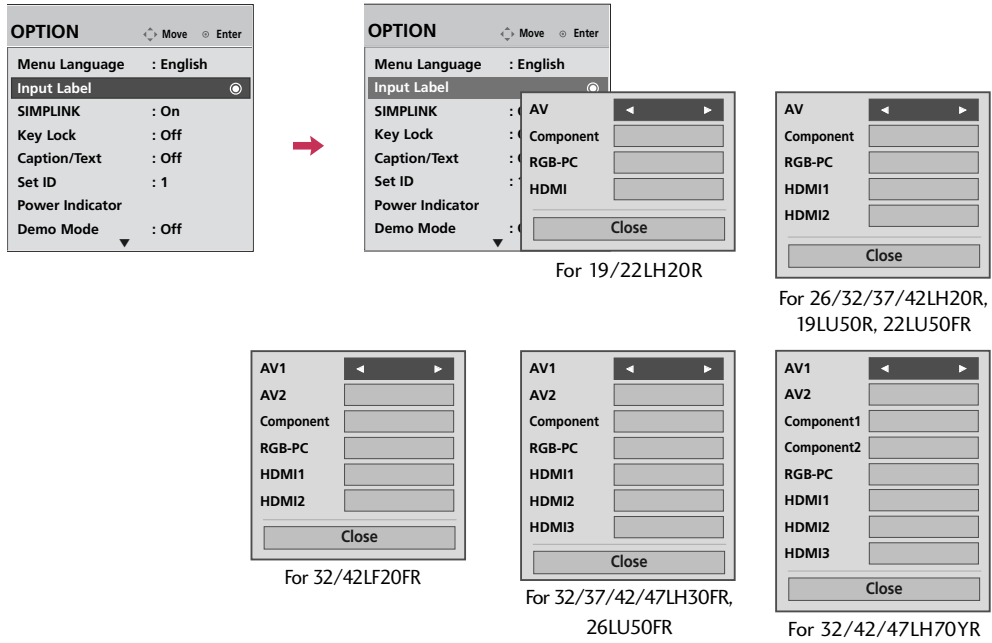



# INPUT LABEL

You can set a label for each input source when it's not in use.



## With using OPTION menu

- 1   Select **OPTION**.
- 2   Select **Input Label**.
- 3   Select the source.
- 4  Select the label.
- 5  Return to the previous menu.
-  Return to TV viewing

# WATCHING TV / CHANNEL CONTROL

## AV MODE

AV Mode toggles through preset Video and Audio settings.

- Off** Disables the AV MODE.
- Cinema** Optimizes video and audio for watching movies.
- Sport** Optimizes video and audio for watching sports events.
- Game** Optimizes video and audio for playing games.

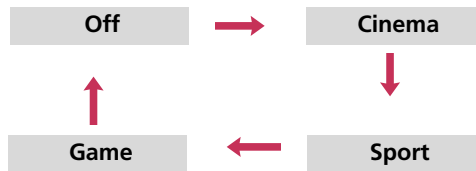

Press the **AV MODE** button repeatedly to select the desired source.



Return to TV viewing.

- If you select “**Cinema**” in AV mode, **Cinema** will be selected both for “**PICTURE** menu - Picture Mode” and “**AUDIO** menu - Sound Mode” respectively.
- If you select “**Off**” in AV mode, the “**Picture Mode**” and “**Sound Mode**” return to previous selected value.







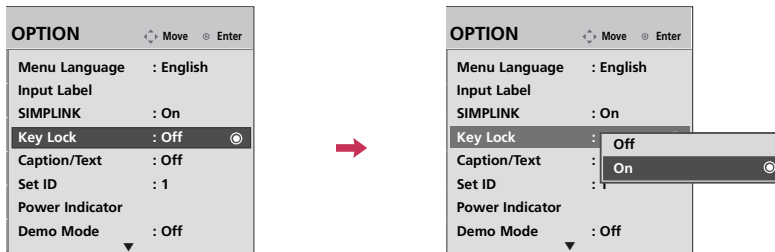

# KEY LOCK

The TV can be set up so that it can only be used with the remote control.

This feature can be used to prevent unauthorized viewing by locking out the front panel controls.

This TV is programmed to remember which option it was last set to even if you turn the TV off.



- 1   Select **OPTION**.
- 2   Select **Key Lock**.
- 3   Select **On** or **Off**.
- 4  Return to the previous menu.
-  Return to TV viewing.

- In **Key Lock 'On'**, if the TV is turned off, to turn on the TV, press the **INPUT**, **CH ▲ ▼** button on the TV or **POWER**, **INPUT**, **CH ^ v** or **NUMBER** buttons on the remote control.
- With the **Key Lock On**, the display '  **Key Lock** ' appears on the screen if any button on the front panel is pressed while viewing the TV (Except AC power control switch).







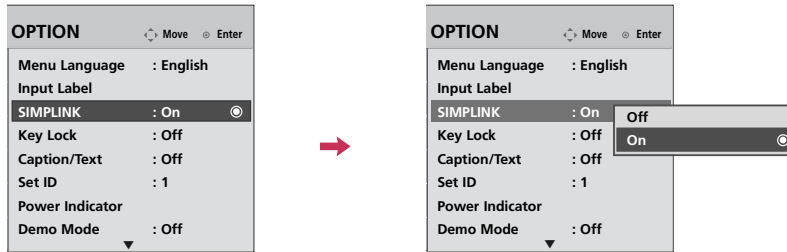

# WATCHING TV / CHANNEL CONTROL



Simplink allows you to control and play other AV devices connected with HDMI cable without additional cables and settings. This TV may work with devices with HDMI-CEC support, but only devices with the SIMPLINK logo are fully supported.

SIMPLINK can be turned on and off in the user menus.



- 1   Select **OPTION**.
- 2   Select **SIMPLINK**.
- 3   Select **On** or **Off**.
- 4  Return to the previous menu.
-  Return to TV viewing.

## NOTE

- ▶ Connect the HDMI/DVI IN or HDMI IN terminal of the TV to the rear terminal (HDMI terminal) of the SIMPLINK device with the HDMI cable.
- ▶ When you switch the Input source with the INPUT button on the remote control, the SIMPLINK device will stop.
- ▶ When you select a device with home theater functionality, the sound output automatically switches to the home theater speakers and the TV speakers are turned off.
- ▶ When the unit is connected to SIMPLINK Home Theater, set to Variable Out and turn off the TV Speaker to operate the Home Theater Speaker. At this time, the maximum volume of the Home Theater Speaker is set to the TV volume.

## SIMPLINK Functions

- **Direct Play:** After connecting AV devices to the TV, you can directly control the devices and play media without additional settings.
- **Select AV device:** Enables you to select one of the AV devices connected to TV.
- **Disc playback:** Control connected AV devices by pressing the  $\wedge$   $\vee$   $\lt$   $\gt$ , **ENTER**, **▶**, **■**, **||**, **◀◀** and **▶▶** buttons.
- **Power off all devices:** When you power off the TV, all connected devices are turned off.
- **Switch audio-out:** Offers an easy way to switch audio-out.
- **Sync Power on:** When you play the connected AV device, TV will automatically turn on.

(A device, which is connected to the TV through a HDMI cable but does not support SIMPLINK, does not provide this function)

Note: To operate SIMPLINK, an HDMI cable over Version 1.3 with \*CEC function should be used. (\*CEC: Consumer Electronics Control).

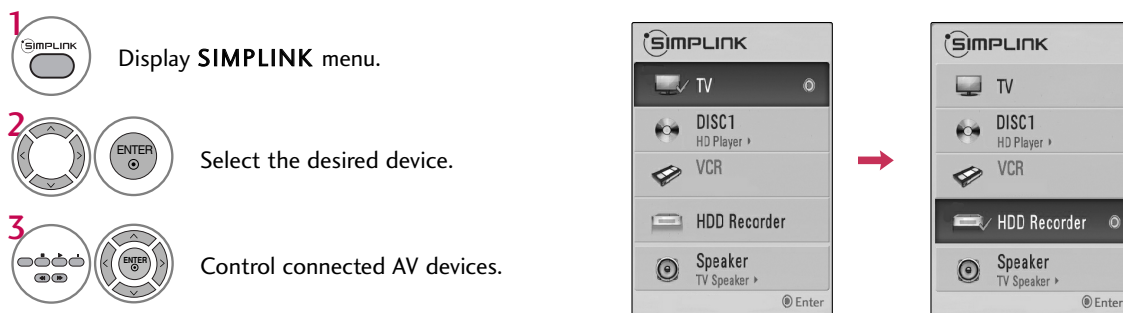

## SIMPLINK Menu

- 1 **TV viewing:** Switch to the previous TV channel regardless of the current mode.
- 2 **DISC playback:** Select and play discs. When multiple discs are available, the titles of discs are conveniently displayed at the bottom of the screen.
- 3 **VCR playback:** Control the connected VCR.
- 4 **HDD Recordings playback:** Control recordings stored in HDD.
- 5 **Audio Out to Home Theater speaker/Audio Out to TV:** Select Home Theater speaker or TV speaker for Audio Out.

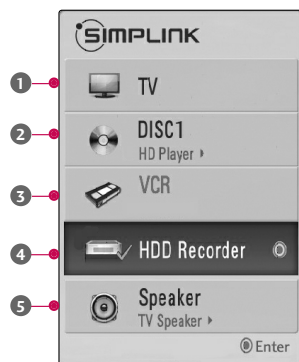

- ▶ When no device is connected (displayed in gray)
- ▶ Selected Device
- ▶ When a device is connected (displayed in bright color)

# BLUETOOTH For 32/42/47LH70YR

- Image shown may differ from your TV.

## Bluetooth?

Bluetooth is a short distance networking technology using 2.4 GHz frequency to connect various types of information devices such as computers, cell phones and PDAs, as well as digital appliances through wireless connection, without having to connect any cable, to enable data exchange.

With the Bluetooth communication function, you can connect the Bluetooth enabled wireless headset or receive images(only JPG), listen to music from the Bluetooth enabled cell phone using this TV.

- Communication Spec.: Bluetooth Specification version 2.0 + **EDR(Enhanced Data Rate)**
- Output: Bluetooth Specification Power Class 2
- Maximum Communication Range: Line of open sight approx. 10 m (30 ft)
- Frequency Band: 2.4 GHz band (2.4 GHz ~ 2.4835 GHz)
- Bluetooth Module: RBFS-C921A
- Compatible Bluetooth Profile: A2DP (Advanced Audio Distribution Profile)  
OPP (Object Push Profile)  
GAVDP (Generic Audio/Video Distribution Profile)  
HSP (Headset Profile)

CE0700

FCC ID: BEJRBFS-C921A

### Precautions when using the Bluetooth

- ▶ Use within 10m(-45° ~ 45°) range.  
If you use the device out of the range or within the range with obstacles, it can result in communication error.
- ▶ Communication error can occur depending on the surrounding devices.
- ▶ Products using the same frequency of 2.4 GHz (Wireless LAN, microwave oven etc.), can cause communication error by using the same frequency bandwidth.
- ▶ The device search time differs depending on the number of Bluetooth devices and the operating situation.
- ▶ The probability of search increases with less number of devices.
- ▶ Electromagnetic wave can be interfered with applicable wireless devices.
- ▶ Because applicable wireless devices have the possibility of electromagnetic wave interference, they cannot provide services related to human life.
- ▶ You can only connect one Bluetooth device at a time.
- ▶ You cannot receive the photos(only JPG) or listen to music from other Bluetooth devices while using the Bluetooth headset.
- ▶ For details of Bluetooth, refer to the user manual of the Bluetooth device.
- ▶ USB (Photo List, Music List, Movie List) and Bluetooth will not be supported at the same time.
- ▶ Operation is subject to the following two conditions: (1) This device may not cause (harmful) interference, and (2) this device must accept any interference received, including interference that may cause undesired operation (of the device).

QDID(Qualified Design Identity): B015112

# SETTING THE BLUETOOTH

The Bluetooth feature on this TV allows you to listen to the wireless audio using Bluetooth headphones. It will also connect with a Bluetooth equipped device to view phones.

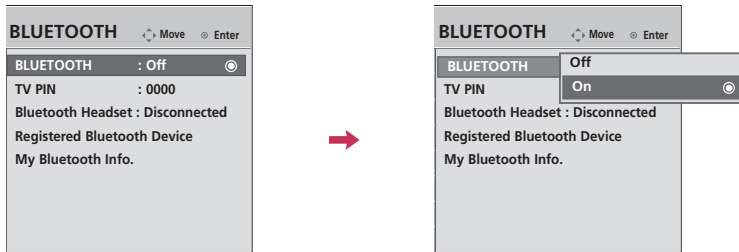



1   Select **BLUETOOTH**.

2   Select **BLUETOOTH**.

3   Select **On** or **Off**.

4  Start Bluetooth. 

5  Return to the previous menu.

 Return to TV viewing.

## NOTE

- ▶ With Bluetooth set to 'On', if any registered devices are turned on, the TV will switch to Bluetooth mode automatically even though you are watching in another input mode. In this case, set Bluetooth to Off.

# BLUETOOTH

## SET TV PIN

To accept a connection from an external Bluetooth device or to connect to an external Bluetooth device. For details on how to set the PIN of the external Bluetooth device, refer to the user manual of the applicable device.

The TV PIN must have more than 1 digit.

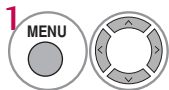
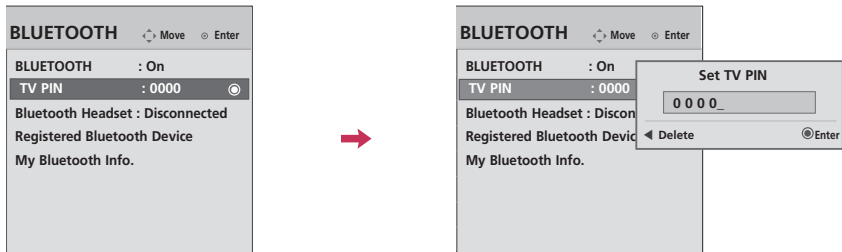

Select **BLUETOOTH**.

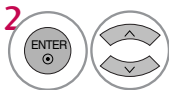

Select **TV PIN**.

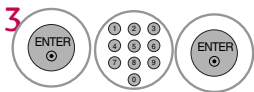

Select the desired PIN number.

PIN number can support up to maximum of 10 digits.



Return to the previous menu.



Return to TV viewing.

■ Press the < button to delete digits one by one.



# BLUETOOTH HEADSET

When you select the Bluetooth headset, you can listen to the TV audio in the Bluetooth headset through wireless communication.











You must pair it with any new Bluetooth device before the first use. For details, refer to the user manual of the applicable device. Maximum of 12 lists can be used.

## Connecting a new Bluetooth headset

You can only search for the new Bluetooth headset only when no headset is already connected.

When you run the search, it will show the list of all Bluetooth headsets responding.

After a new Bluetooth device is searched, the PIN number is validated to connect the device. For details, refer to the user manual of the applicable device.

- 1   Select **BLUETOOTH**.
- 2   Select **Bluetooth Headset**.
- 3   Search the Bluetooth headset.
  - If you want to stop, press the **ENTER** button.
- 4     Set the PIN number .

Set Headset PIN

0 0 0 0 \_

◀ Delete      Enter ▶

↓









Connect the Bluetooth headset.

Headset is connected.  
TV speaker will be turned off.

## Connecting the Bluetooth headset already registered

Bluetooth headsets are listed in the order most recently used with the headset currently in use listed at the top.

When connecting the Bluetooth device already registered, you can select and connect directly without any PIN validation.

- 1   Select **BLUETOOTH**.
- 2   Select **Bluetooth Headset**.
- 3   Select the Bluetooth headset in the list.
- 4    Select **Yes**.

? Do you want to connect your headset?

Yes      No

- 5  Connect the Bluetooth headset.

- ▶ After connecting/using the Bluetooth headset, the headset setting will be the **Disconnected** condition automatically when you turn off the power of the TV and then turn on.
- ▶ After connecting the Bluetooth headset, the TV speaker is switched to **Mute** condition and the sound will only be generated from the headset.

# BLUETOOTH

## Disconnecting the Bluetooth headset

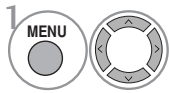

Select **BLUETOOTH**.

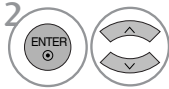

Select **Bluetooth Headset**.

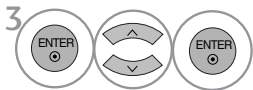

Disconnect the Bluetooth headset.

## When requesting to connect to TV from the Bluetooth headset

Even if it is not in the registered device list, depending on a headset, it works if connected as shown below when headset power off.

When the Bluetooth menu is "On" and there is a connection request from the headset, this message is displayed.

Not all headsets support this feature. (Refer to the user manual of the applicable Bluetooth headset.)

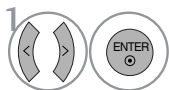
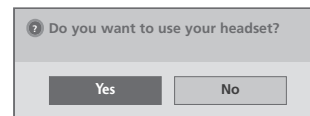

Select **Yes** or **No**.



### NOTE

- ▶ LG recommends the following headset models.
  - Sony Ericsson : HBH-DS980, Motorola : S9, Motorola : S605, Jabra : BT620S
- ▶ The stereo/mono headsets officially certified to be Bluetooth compatible can be searched and connected.
- ▶ The stereo/mono headsets that support A2DP or HSP functionality can be connected.
- ▶ If the surrounding environment of the TV is as follows, the device may not be searched or connected properly.
  - If there is strong electromagnetic interference.
  - If there are many Bluetooth devices in the area.
  - If the headset is turned off, not in place or has an error.
  - Because products such as microwave oven, wireless LAN, plasma light, gas range etc., use the same frequency range, they can cause communication errors.
- ▶ Only one Bluetooth device can be connected at a time.
- ▶ Connection that is lost due to the TV being turned off etc. will not be automatically recovered. Try connecting the applicable device again.
- ▶ Some operations can be slower while operating the headset.
- ▶ Even if you choose simplink Home Theater after using the headset during Simplink operation, the unit will not automatically switch to Home Theater speakers.
- ▶ When the headset connection continuously fails, pair the device one more time.
- ▶ The audio quality of mono headsets will not be as good as that for stereo headsets.
- ▶ Mono headsets may suffer from noise as the distance from the TV increases, because they use a different transmission method compared with stereo headsets.
- ▶ When a Bluetooth headset is in use, the Volume +/- and MUTE keys do not work, and the Audio menu returns to the default value and is disabled.



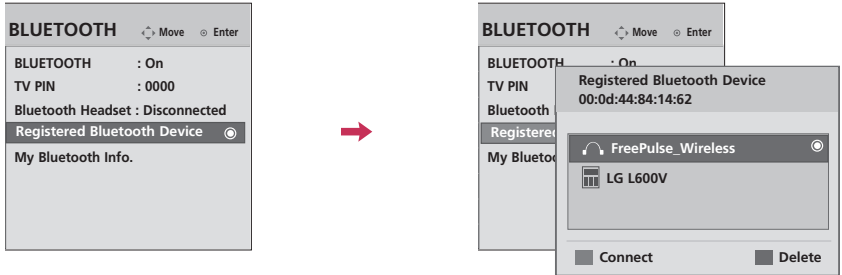

# MANAGING REGISTERED BLUETOOTH DEVICE

If there are no devices registered, Registered Bluetooth Device menu will be deactivated and cannot be used. An additional device after registration of 12 devices deletes the existing list as stored order. Bluetooth device names may be up to 14 characters long, the name will be truncated if more characters are used.





- 1   Select **BLUETOOTH**.
- 2   Select **Registered Bluetooth Device**.
- 3  Check the registered Bluetooth device.

## Connecting the registered Bluetooth device

- 1  Select the registered Bluetooth device you want.
- 2  Connect the bluetooth device.
- 3   Select **Yes**.

## Deleting the registered Bluetooth device

### ■ Disconnecting the registered Bluetooth device

- 1  Select the connected Bluetooth device.
- 2  Disconnect the bluetooth device.

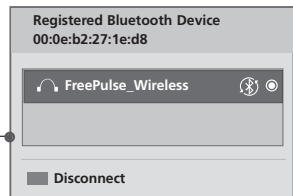

### ■ Deleting the registered Bluetooth device







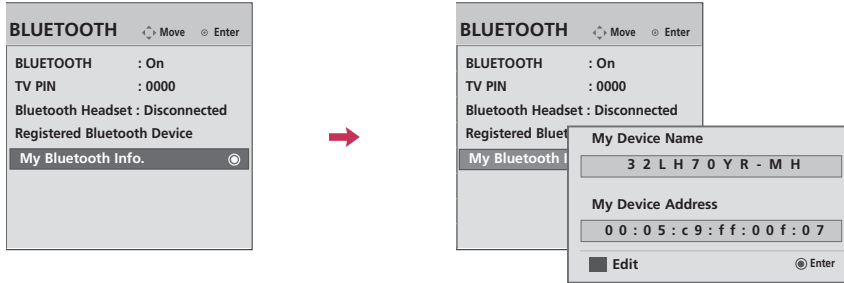

- 3    Select **Yes**.

# BLUETOOTH

## MY BLUETOOTH INFORMATION

This function provides the My Bluetooth Information to the user.  
"Edit" will be available when TV is not connected with any device.



-   Select **BLUETOOTH**.
-   Select **My Bluetooth Info..**
-    Edit the information.
-  Save.
-  Return to the previous menu.
-  Return to TV viewing.

## VIEWING THE PHOTOS WITH BLUETOOTH DEVICE

You can view the photos(\*.JPG) that were received from an external Bluetooth device to the TV.

To see the detailed information about connecting the external Bluetooth device, refer to the user manual of the applicable device.

Your TV's OSD (On Screen Display) may differ slightly from that shown in this manual.

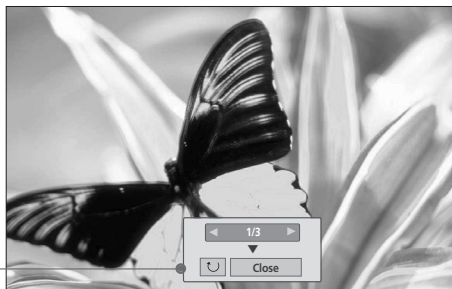
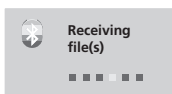

- ▶ **(Rotate)**: Rotate photos.
  - Every time you press **ENTER** button on **(Rotate)**, rotates the photo 90° clockwise.
- ▶ **Close** : Close the pop-up menu.
  - When you press the ENTER button, it will appear again.

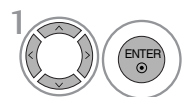

Select the each menu.

- Use < > button to select the previous or next photo.
- Use ^ v < > button to select and control the menu on the screen.

### NOTE

- ▶ When you send photos via Bluetooth, the memory capacity supports up to 8MB and 64 photos.
- ▶ You cannot receive the photos(only JPG) while using the Bluetooth headset or listening to music from Bluetooth device.
- ▶ On receiving the photos, press the **RETURN** button to stop. At this time, all photos received will be deleted.
- ▶ Some Bluetooth devices may not support sending the photos.

## LISTENING THE MUSICS WITH BLUETOOTH DEVICE

You can listen to the musics(A2DP) that were received from an external Bluetooth device to the TV.

To see the detailed information about connecting the external Bluetooth device, refer to the user manual of the applicable device.

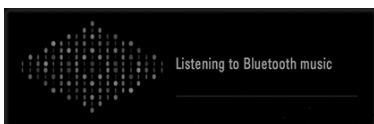

Adjust the volume.

- If you want to switch the sound off, press the **MUTE** button.



Return to TV viewing.

### NOTE

- ▶ You cannot listen to the musics while using the Bluetooth headset or receiving the photos.
- ▶ Some Bluetooth devices may not support listening the music via TV speaker system.
- ▶ When listening to music with Bluetooth, Variable/Monitor out which is an audio out of TV does not work.

# USB Except 19/22/26/32/37/42LH20R, 32/42LF20FR, 19LU50R, 22/26LU50FR

- Image shown may differ from your TV.
- This part of USB mainly use picture for **32/42/47LH70YR**.

## ENTRY MODES

When you connect a USB device, this pop up menu is displayed automatically.

In USB device, you can not add a new folder or delete the existing folder.

- 1 Connect the USB device to the **USB IN** jack on the TV.

For **32/42/47LH70YR**

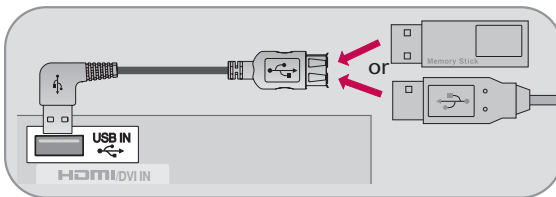

For **32/37/42/47LH30FR**

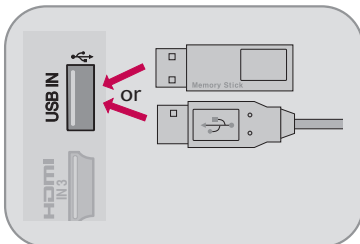

- 2 Select **PHOTO LIST**, **MUSIC LIST** or **MOVIE LIST**.



- 3

- This TV supports JPG, MP3 files and SD DivX.

### When removing the USB device

Select the **USB Device** menu before removing the USB device.

- 1 **Q. MENU** Select **USB Device**.
- 2 **ENTER** Select **Eject**.

## Precautions when using the USB device

- ▶ Only a USB storage device is recognizable.
- ▶ If the USB storage device is connected through a USB hub, the device is not recognizable.
- ▶ A USB storage device which uses its own driver may not be recognized.
- ▶ In case of a card reader, up to four memory cards are concurrently recognizable.
- ▶ The recognition speed of a USB storage device may depend on each device.
- ▶ Please do not turn off the TV or unplug the USB device when the connected USB storage device is working. When such device is suddenly separated or unplugged, the stored files or the USB storage device may be damaged.
- ▶ Please connect power to a USB storage device (over 0.5A) which requires an external power supply. If not, the device may not be recognized.
- ▶ Please connect a USB storage device with cable is offered by USB maker. If connected with cable is not offered by USB maker or an excessively long cable, the device may not be recognized.
- ▶ Some USB storage devices may not be supported or operate properly.
- ▶ Please backup important files because data on the USB device may be damaged. Data management is the consumer's responsibility and as a result, the manufacturer does not cover data damage.
- ▶ Maximum of 999 files and folders can be recognized.
- ▶ Please use only a USB storage device which was formatted as a FAT16, FAT32, NTFS file system provided with the Windows operating system. In case of a storage device formatted as a different utility programme which is not supported by Windows, it may not be recognized.
- ▶ Data in a USB storage device cannot be deleted in the NTFS file system.
- ▶ The TV will display up to 128 characters of a files name.
- ▶ The recommended capacity is 1TB or less for a USB external hard disk and 32GB or less for USB memory.
- ▶ Any device with more than the recommended capacity may not work properly.
- ▶ If a USB external hard disk with a "Energy Saving" function does not work, turn the hard disk off and on again to make it work properly. Refer to the user manual of the application USB external hard disk.
- ▶ When using a USB HDD via the USB extending cable, connect a support electric power source.

# PHOTO LIST

You can only view .JPG files from USB storage devices.  
The On Screen Display on your model may be slightly different.

**Supported photo file: \*.JPG**

Baseline: Max 4800 x no limit  
Min : 32 x 32 (progressive not supported)

- You can play JPG files only.
- Only baseline scan is supported among JPG. (SOF0, SOF1 only)
- Non-supported files are displayed in the form of bitmap.

## Screen Components

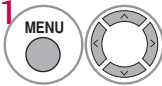
**1**  Select **USB**.

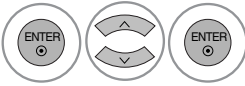
**2**  Select **Photo List**.

**1** Moves to upper level folder  
**2** Current page/Total pages  
**3** Total number of marked photos  
**4** Corresponding buttons on the remote control

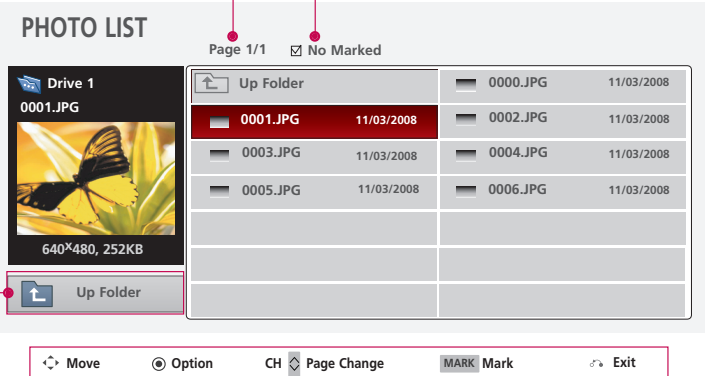

The screenshot shows the 'PHOTO LIST' interface. On the left, a preview of '0001.JPG' is shown with a butterfly image and dimensions '640x480, 252KB'. Below it is an 'Up Folder' button with an upward arrow icon, labeled '1'. The main area shows a list of files under 'Drive 1' and 'Up Folder'. The first file, '0001.JPG', is highlighted in red and has '11/03/2008' next to it. Other files listed are 0002.JPG through 0006.JPG, all with the same date. At the top right of the list area, it says 'Page 1/1' and 'No Marked', with '2' pointing to the page indicator and '3' pointing to the 'No Marked' text. At the bottom, a control bar contains buttons for 'Move', 'Option', 'CH', 'Page Change', 'MARK Mark', and 'Exit'. The 'Option' button is labeled '4'.



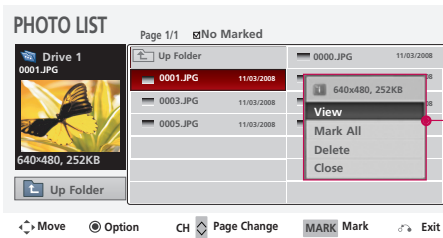
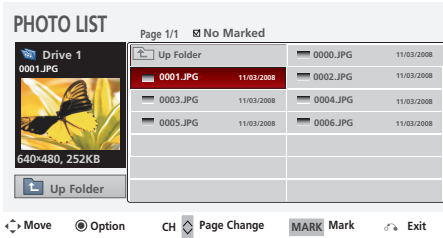

Folder/File	Date
Up Folder	
0001.JPG	11/03/2008
0002.JPG	11/03/2008
0003.JPG	11/03/2008
0004.JPG	11/03/2008
0005.JPG	11/03/2008
0006.JPG	11/03/2008

## Photo Selection and Popup Menu

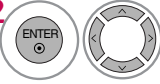

When you select a file(not folder), this PopUp menu is displayed.

- ▶ **View:** Display the selected item.
- ▶ **Mark All:** Mark all photos on the screen.
- ▶ **Unmark All:** Deselect all marked photos.
- ▶ **Delete:** Delete the selected photo item.
- ▶ **Close:** Close the pop-up menu.

- 1  Select the target folder or drive.
- 2  Select the desired photos.
- 3  Show the Popup menu.
- 4  Select the desired Popup menu.
- 5  Return to the previous menu.

- Use the **CH**  $\wedge$   $\vee$  button to navigate in the photo page.
- Use the **MARK** button to mark or unmark a photo. When one or more photos are marked, you can view individual photos or a slide show of the marked photos. If no photos are marked, you can view all photos individually or all photos in the folder in a slide show.







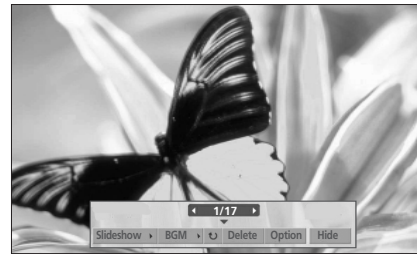
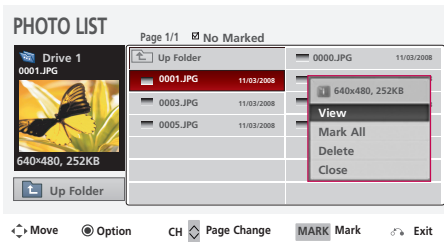
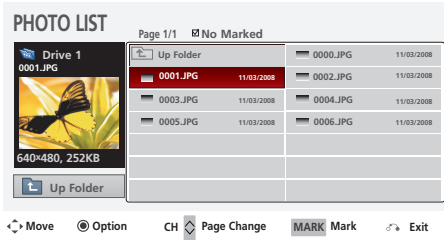

## Full Screen Menu

You can change the Photo List view so that it fills the screen. More operations are available in full screen mode.



The aspect ratio of a photo may change the size of the photo displayed on the screen in full size.

- 1  Select the target folder or drive.
- 2   Select the desired photos.
- 3  Show the Popup menu.
- 4  Select **View**.
- 5  The selected photo is displayed in full size.

■ Use the CH ^ v button to navigate in the photo page.

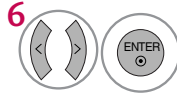
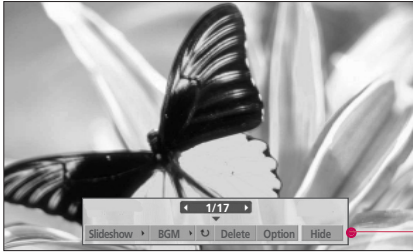

Select the **Slideshow**, **BGM**, **Rotate**, **Delete**, **Option**, or **Hide**.

- Use < > button to select the previous or next photo.
- Use ^ v < > button to select and control the menu on the full-sized screen.

- ▶ **Slideshow:** Selected photos are displayed during the slide show. If no photo is selected, all photos in the current folder are displayed during slide show.
  - Set the time interval of the slide show in **Option**.
- ▶ **BGM:** Listen to music while viewing photos in full size.
  - Set the BGM device and album in **Option**.
- ▶ **Rotate:** Rotate photos.
  - Rotates the photo 90°, 180°, 270°, 360° clockwise.
- ▶ **Delete:** Delete photos.
- ▶ **Option:** Set values for **Slide Speed** and **Music Album**.
  - Use ^ v < > button and **ENTER** button to set values. Then go to **Enter** and press **ENTER** to save the settings.
  - You cannot change **Music Album** while BGM is playing.
- ▶ **Hide :** Hide the menu on the full-sized screen.
  - To see the menu again on the full-sized screen, press **ENTER** button to display.

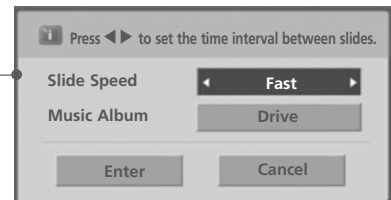

### ! NOTE

- ▶ This TV will not be able to decode most JPG images saved using the Progressive option.

# MUSIC LIST

You can use the Music List menu to play MP3 files from a USB storage device.  
This TV cannot play back copy-protected files.  
The On Screen Display on your model may be slightly different.

Supported music file: \*.MP3  
Bit rate range 32 kbps ~ 320 kbps  
• Sampling rate  
MPEG1 layer 3: 32 KHz ~ 48 KHz

USB

## Screen Components

**1** MENU Select **USB**.

**2** ENTER Select **Music List**.

**1** Moves to upper level folder  
**2** Current page/Total pages  
**3** Total number of marked music  
**4** Corresponding buttons on the remote control

**MUSIC LIST**  
Page 1/1  No Marked

Title	Duration
Up Folder	
Arirang	04:12
Good Bye	05:30

Drive 1  
Arirang  
3945 KB, 128 Kbps

Up Folder

Move Option CH Page Change MARK Mark Exit

## Music Selection and Popup Menu

Up to 6 music titles are listed per page.

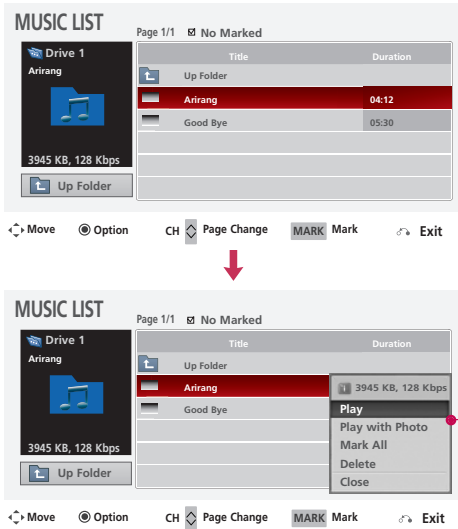

- ▶ **Play** (During stop): Play the selected music. Once a music finishes playing, the next selected one will be played. When there are no selected musics to play, the next one in the current folder will be played.
- ▶ **Play Marked**: Play the selected musics. Once a music finishes playing, the next selected one will be played automatically.
- ▶ **Stop Play** (During playback): Stop the playing musics.
- ▶ **Play with Photo**: Start playing the selected musics and then move to the Photo List.
- ▶ **Mark All**: Mark all musics in the folder.
- ▶ **Unmark All**: Deselect all marked musics.
- ▶ **Delete**: Delete the selected music.
- ▶ **Close**: Close the pop-up menu.

- 1 Select the target folder or drive.
- 2 Select the desired musics.
- 3 Show the Popup menu.
- 4 Select the desired Popup menu.
- 5 Return to the previous menu.

- Use the **CH** button to navigate in the music page.
- Use the **MARK** button to mark or unmark a music file. If no music is marked, all the music in the folder will be played in sequence. When one or more music files are marked, the marked music files will be played in sequence. If you want to listen to only one song repeatedly, just mark that one file and play.

- The play information box (as shown below) will automatically move across the screen when there is no user input to prevent a fixed image remaining on the screen for an extended period of time.

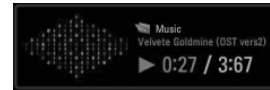

### NOTE

- ▶ When music is playing, is displayed in front of the music play time.
- ▶ A damaged or corrupted music file that does not play displays 00:00 as the play time.
- ▶ A music downloaded from a paid service with copyright protection does not start but displays inappropriate information in playtime.
- ▶ Press **ENTER**, or **RETURN** button to stop the screen saver.
- ▶ This TV can not play music files less than 32 Kbytes.

# MOVIE LIST

The movie list is activated once a USB drive is detected. It is used when playing movie files on TV.

Displays the movies in the USB folder and supports play.

Allows playback of all movies in the folder and user desired files.

Editing such as delete and add is not allowed.

It is a movie list that displays folder information and DivX file.

MOVIE(\*.avi/\*.divx) supporting file  
 Sampling frequency : within 32 KHz ~ 48 KHz(MP3)  
 Bit rate : within 32 kbps ~ 320 kbps(MP3)

Video Format	Audio Format	Subtitle format
MPEG1 , MPEG2, MPEG4(Doesn't support Microsoft MPEG4 V2, V3), DivX 3.xx , DivX 4.xx, DivX 5.xx , DivX VOD ( DRM ) , XviD, DivX 6.xx(Playback)	Mpeg, Mp3, PCM, Dolby D, AC3	*.smi/ *.srt/ *.sub(MicroDVD, SubViewer 2.0)/ *.ass/ *.ssa/*.txt(DVD Subtitle System)

Extension name	Video Codec	Audio Codec	Resolution
mpg, mpeg, mpe, vob, dat	MPEG1, MPEG2	AC3, MPEG, MP3, PCM	720x576@25p
Avi, divx, m4v	MPEG4-SP, MPEG4-ASP, DivX 3.xx, DivX 4.xx, DivX 5.xx, DivX 6.xx(Playback), Xvid	AC3, MPEG, MP3, PCM	720x480@30p

## Precautions when using the Movie List

- ▶ The video file and the subtitle file must be located in the same folder.
- ▶ The name of the video file and the subtitle file must be the same to view the subtitles normally.
- ▶ Time information in an external subtitle file should be arranged in ascending order to be played.
- ▶ DivX may not be played depending on its types or recording methods.
- ▶ If the video and audio structure of recorded file is not interleaved, either video or audio is outputted.
- ▶ Max bitrate of playable DivX file is 6 Mbps.
- ▶ Maximum FPS (Frame Per Second) can be reached only at SD level. FPS is 25 FPS (720\*576) or 30 FPS (720\*480) depending on Resolution.
- ▶ Files of 25 FPS or 30 FPS of higher may not be played properly.
- ▶ If the file is recorded with GMC, the unit supports only 1 point of recorded level. (GMC is the acronym for Global Motion Compensation, a technique used to compensate MPEG Video files.)
- ▶ Playing a video via a USB connection that does not support high speed may not work properly.
- ▶ USB storage devices below USB 2.0 are supported as well. But they may not work properly in the movie list.

## Screen Components

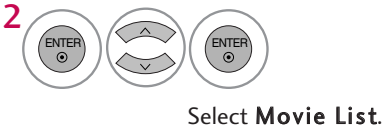

- 1 Moves to upper level folder
- 2 Current page/Total pages
- 3 Total number of marked movie
- 4 Corresponding buttons on the remote control

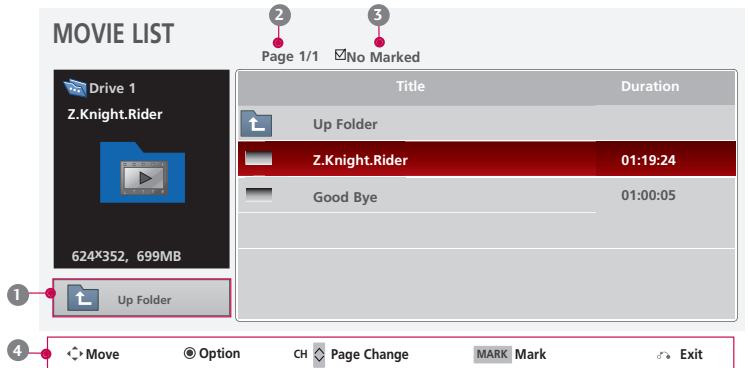

## Movie Selection and Popup Menu

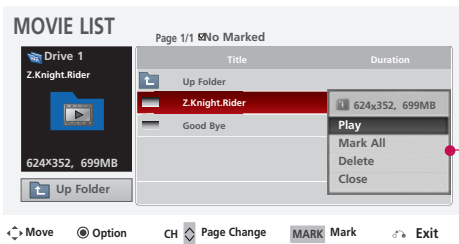
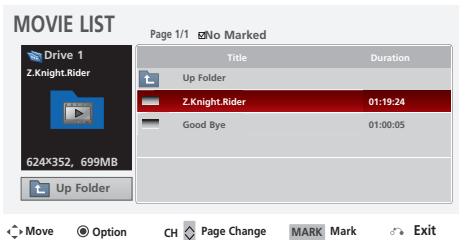

► **Play** (During stop): Play the selected movie. If you go to a different folder and press the **ENTER** button, the current movie in playback will stop.

On movie playing, display the current movie status progress bar in the bottom of the screen.



- **Play Marked**: Play the selected movie titles. Once a movie finishes playing, the next selected one will be played automatically.
- **Stop Play** (During playback): Stop the playing movies.
- **Mark All**: Mark all movies in the folder.
- **Unmark All**: Deselect all marked movies.
- **Delete**: Delete the selected movie.
- **Close**: Close the pop-up menu.

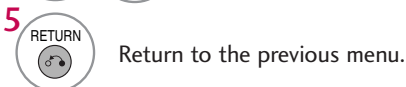
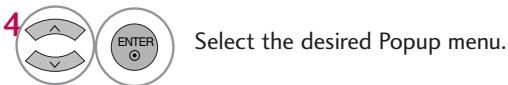
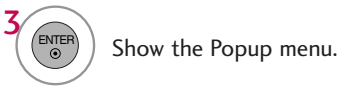
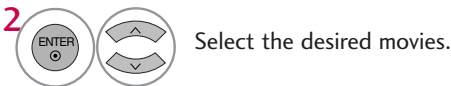
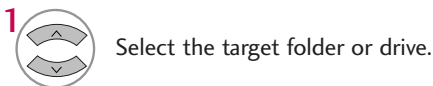

- Use the **CH** ^ v button to navigate in the movie page.
- Use the **MARK** button to mark or unmark a movie file. When one or more movie files are marked, the marked movie files will be played in sequence.

### ! NOTE

- Use the (< / >) buttons to move to a specific frame forward or backward while playing a movie. (The (< / >) buttons may not work properly for some files while playing a movie.)





## Using the remote control

You can adjust various method during movie play.

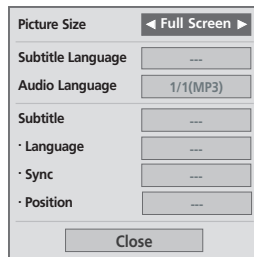
◀◀ / ▶▶	<p>When playing, repeatedly press the <b>REW(◀◀)</b> button to speed up ◀◀ -&gt; ◀◀◀◀ -&gt; ◀◀◀◀◀◀ -&gt; ◀◀◀◀◀◀◀◀ .</p> <p>Repeatedly press the <b>FF(▶▶)</b> button to speed up ▶▶-&gt; ▶▶▶▶ -&gt; ▶▶▶▶▶▶ -&gt; ▶▶▶▶▶▶▶▶ .</p> <ul style="list-style-type: none"> <li>Pressing these buttons repeatedly increases the fast forward/reverse speed.</li> </ul>
	<p>During playback, press the <b>Pause(  )</b> button.</p> <ul style="list-style-type: none"> <li>Still screen is displayed.</li> </ul>
< >	<ul style="list-style-type: none"> <li>When using the &lt; or &gt; button during playback a cursor indicating the position can be viewed on the screen.</li> </ul>
PLAY(▶)	<p>Press the <b>PLAY(▶)</b> button to return to normal playback.</p>

## DivX Audio Language & Subtitle Language



- 1  When DivX is playing, the **Option** menu is displayed.
- 2  Select the desired option.
- 3  Select **Picture Size, Subtitle Language, Audio Language, Subtitle, Language, Sync** or **Position**.
- 4  Return to the previous menu.
-  Return to TV viewing.

Subtitle Language	Support Language
Latin 1	French, Spanish, Catalan Basque, Portuguese, Italian, Albanian, Rhaeto-Romanic, Dutch, German, Danish, Swedish, Norwegian, Finnish, Faroese, Icelandic, Irish, Scottish, English
Latin 2	Czech, Hungarian, Polish, Romanian, Croatian, Slovak, Slovenian, Sorbian
Latin 4	Estonian, the Baltic languages Latvian(Lettish) and Lithuanian, Greenlandic and Lappish
Latin 5	English, Trukish
Cyrillic	Bulgarian, Byelorussian, Macedonian, Russian, Serbian and pre-1990 (no ghe with upturn) Ukrainian
Greek	English, Modern Greek
Hebrew	English, Modern Hebrew
Chinese	Chinese
Thai	Thai
Arabic	English, Arabic





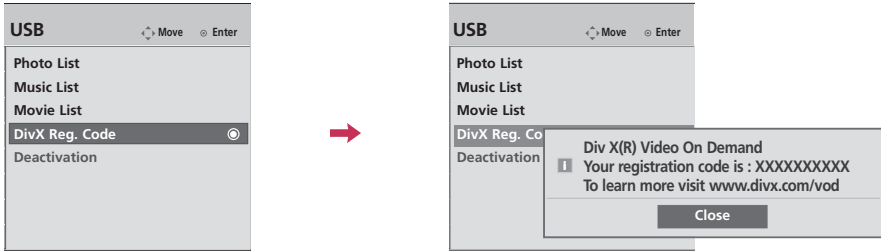

## DIVX REGISTRATION CODE

Confirm the DivX registration code number of the TV. Using the registration number, movies can be rented or purchased at [www.divx.com/vod](http://www.divx.com/vod).

With a DivX registration code from another TV, playback of rented or purchased DivX file is not allowed. (Only DivX files matched with the registration code of the purchased TV are playable.)



USB

- 1   Select **USB**.
- 2   Select **DivX Reg. Code**.
- 3  Display **DivX Reg. Code**.
- 4  Return to the previous menu.
-  Return to TV viewing.

**NOTE**







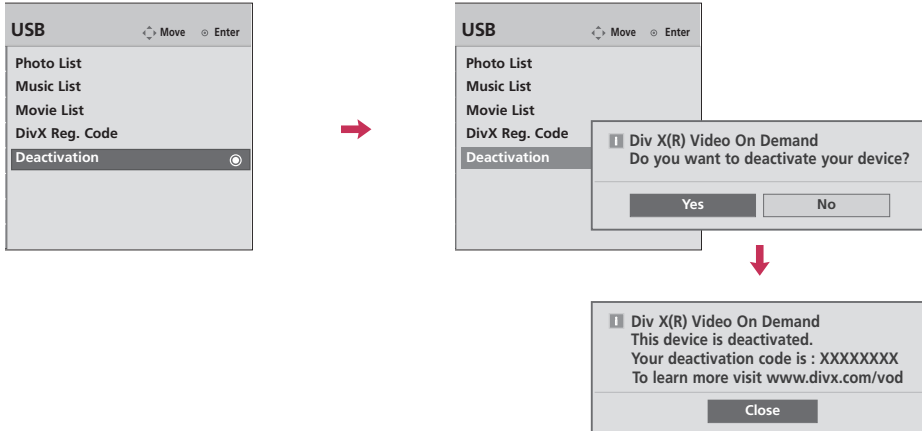

- ▶ When loading, some buttons may not be worked.
- ▶ If you use the DivX registration code of another device, the rented or purchased DivX file cannot be played. Therefore always use the DivX registration code assigned to this product.



# DEACTIVATION

Delete the existing authentication information to receive a new DivX user authentication for TV. Once this function is executed, a DivX user authentication is required again to see DivX DRM files.



-   Select **USB**.
-   Select **Deactivation**.
-   Select **Yes** or **No**.
- 
-  Return to the previous menu.
-  Return to TV viewing.







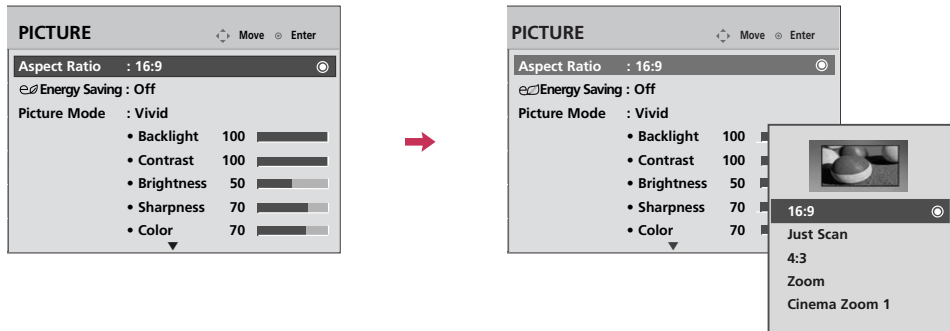

# PICTURE CONTROL

## PICTURE SIZE (ASPECT RATIO) CONTROL

This feature lets you choose the way an analog picture with a 4:3 aspect ratio is displayed on your TV.

- RGB-PC input source use 4:3 or 16:9 aspect ratio.



-   Select **PICTURE**.
-   Select **Aspect Ratio**.
-   Select the desired picture format.
-  Return to the previous menu.
-  Return to TV viewing.

- You can also adjust **Aspect Ratio** in the **Q.Menu**.
- Press the **RATIO** button repeatedly to select the desired picture format. (Except 32/37/42/47LH30FR)

## 16:9

Adjust the picture horizontally, in a linear proportion to fill the entire screen.



## Just Scan

Normally the edges of video signals are cropped 1-2%. Just Scan turns off this cropping and shows the complete video.

Notes: If there is noise on the edges of the original signal, it will be visible when Just Scan is activated.

**Just Scan** operates only in

Component/HDMI/DVI(720p/1080i/1080p)  
input source.



## 4:3

Choose 4:3 when you want to view a picture with an original 4:3 aspect ratio.



## Zoom

Choose Zoom when you want to view the picture without any alteration. However, the top and bottom portions of the picture will be cropped.

- When adjusting in Q.Menu menu,
  - a. < or > button: Adjust proportion of Zoom.
  - b. ^ or v button: Move the image on the screen.

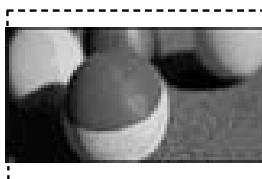

## Cinema Zoom1

Choose Cinema Zoom when you want to enlarge the picture in correct proportion.

Note: When enlarging or reducing the picture, the image may become distorted.

- a. < or > button: Adjust proportion of Cinema Zoom. The adjustment range is 1-16.
- b. ^ or v button: Move the image on the screen.

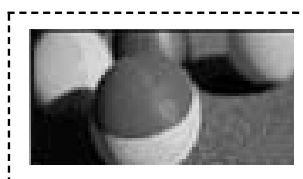







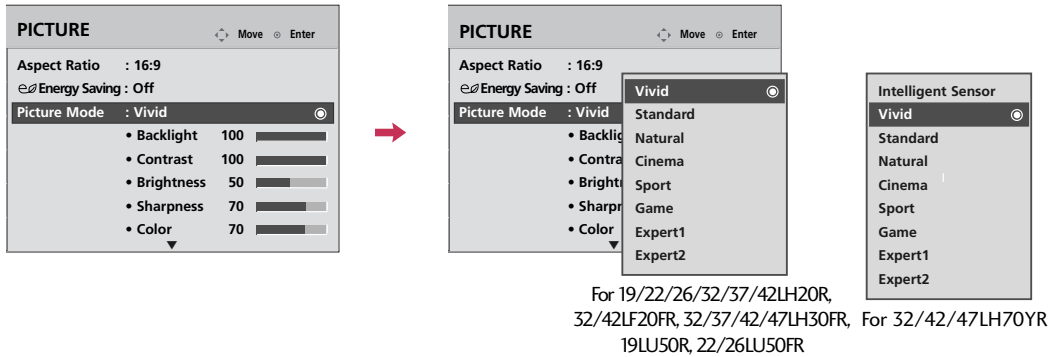

# PICTURE CONTROL

## PRESET PICTURE SETTINGS - PICTURE MODE

There are factory presets for picture settings available in the user menus. You can use a preset, change each setting manually, or use the Intelligent Sensor.





- 1   Select **PICTURE**.
- 2   Select **Picture Mode**.
- 3   Select **Intelligent Sensor**(For 32/42/47LH70YR), **Vivid, Standard, Natural, Cinema, Sport, or Game**.
- 4  Return to the previous menu.
-  Return to TV viewing.

- When selecting **Intelligent Sensor**, **Energy Saving** is changed to **Auto** automatically. (For 32/42/47LH70YR)
- When selecting **Intelligent Sensor**, it is changed contrast, brightness, sharpness, color and tint automatically. (For 32/42/47LH70YR)
- **Vivid, Standard, Natural, Cinema, Sport, and Game** Settings are preset for the optimum picture quality at the factory.
- **Intelligent Sensor**: The most suitable picture is automatically adjusted according to the surrounding conditions. (For 32/42/47LH70YR)
- **Vivid**: This is the mode to maximize the effect of the video in the retail store. Strengthen the contrast, brightness, color and sharpness for vivid picture.
- **Standard**: This is the mode to realize optimum viewing condition for the general user.
- **Natural**: This is the mode to display the most natural screen status.
- **Cinema**: This mode optimizes video for watching movies.
- **Sport**: This is the video mode to emphasize dynamic video and primary color (e.g. white, uniform, grass, sky blue etc.) by realizing the optimal screen for sports.
- **Game**: This is the mode to realize fast response speed in a fast gaming screen.
- **Expert**: This is the mode to adjust the video in detail for video quality expert and general user.
- You can also adjust **Picture Mode** in the **Q.Menu**.

# MANUAL PICTURE ADJUSTMENT - USER MODE

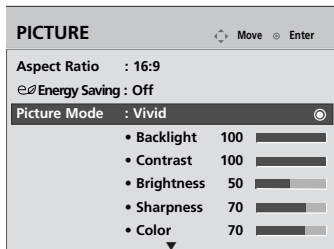
Adjust the picture appearance to suit your preference and viewing situations.



- 1   Select **PICTURE**.
- 2   Select **Picture Mode**.
- 3   Select **Vivid, Standard, Natural, Cinema, Sport, or Game**.
- 4   Select **Backlight, Contrast, Brightness, Sharpness, Color, or Tint**.
- 5   Make appropriate adjustments.
- 6  Return to the previous menu.
-  Return to TV viewing.

- When adjusting Energy Saving, **Backlight** function is disabled.
- **Backlight:** This function adjusts the brightness of LCD panel, to control the brightness of the screen. Adjusting the backlight is recommended when setting the brightness of the set. When decreasing the backlight, the brightness of the black becomes darker without any loss in video signal and the power consumption is reduced.
- **Contrast:** Increase or decrease the gradient of the video signal. You may use Contrast when the bright part of picture is saturated.
- **Brightness:** Adjusts the base level of the signal in the picture. You may use Brightness when the dark part of the picture is saturated.
- **Sharpness:** Adjusts the level of crispness in the edges between the light and dark areas of the picture. The lower the level, the softer the image.
- **Color:** Adjusts intensity of all colors.
- **Tint:** Adjusts the balance between red and green levels.

# PICTURE CONTROL

## PICTURE IMPROVEMENT TECHNOLOGY





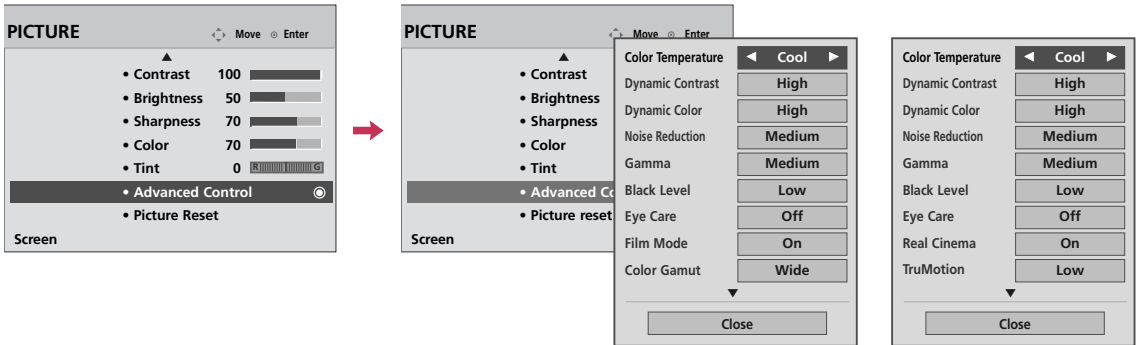



You can calibrate the screen for each Picture Mode or set the video value according to the special video screen. You can set the video seeing differently for each input.

To reset to the factory default after making adjustments to each input source, execute the **Picture Reset** function for each **Picture Mode**.



For 19/22/26/32/37/42LH20R,  
32/42LF20FR, 32/37/42/47LH30FR,  
19LU50R, 22/26LU50FR

For 32/42/47LH70YR

- 1   Select **PICTURE**.
- 2   Select **Advanced Control**.
- 3   Select your desired options.
- 4  Make appropriate adjustments.
- 5  Return to the previous menu.
-  Return to TV viewing.

# EXPERT PICTURE CONTROL





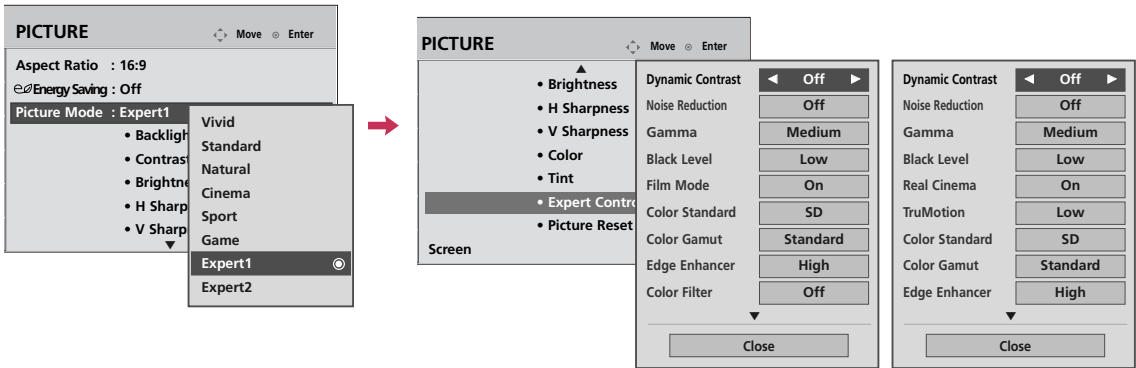







By segmenting categories, **Expert1** and **Expert2** provide more categories which users can set as they see fit, offering the optimal picture quality for users.

This may also be used by a professional to help optimize the TV performance in the environment the TV is in.



For 19/22/26/32/37/42LH20R,  
32/42LF20FR, 32/37/42/47LH30FR,  
19LU50R, 22/26LU50FR

For 32/42/47LH70YR

- 1   Select **PICTURE**.
- 2   Select **Picture Mode**.
- 3   Select **Expert1** or **Expert2**.
- 4   Select **Expert Control**.
- 5   Select your desired menu option.
- 6  Make appropriate adjustments.
- 7  Return to the previous menu.
-  Return to TV viewing.

# PICTURE CONTROL

Color Temperature	<ul style="list-style-type: none"> <li>Set to warm to enhance hotter colors such as red, or set to cool to make picture bluish.</li> </ul>
Dynamic Contrast	<ul style="list-style-type: none"> <li>Adjusts the contrast to keep it at the best level according to the brightness of the screen. The picture is improved by making bright parts brighter and dark parts darker.</li> </ul>
Dynamic Color	<ul style="list-style-type: none"> <li>Adjusts screen colors so that they look livelier, richer and clearer. This feature enhances hue, saturation and luminance so that red, blue, green and white look more vivid.</li> </ul>
Noise Reduction	<ul style="list-style-type: none"> <li>Reduces screen noise without compromising video quality.</li> </ul>
Gamma	<p><i>Low : Make dark and middle gray level area of the picture brighter.</i>  <i>Medium: Express original picture levels.</i>  <i>High: Make dark and middle gray level area of the picture darker.</i></p> <ul style="list-style-type: none"> <li>You can adjust brightness of dark area and middle gray level area of the picture.</li> </ul>
Black Level	<p><i>Low: The reflection of the screen gets darker.</i>  <i>High: The reflection of the screen gets brighter.</i>  <i>Auto: Realizing the black level of the screen and set it to High or Low automatically.</i></p> <ul style="list-style-type: none"> <li>Set black level of the screen to proper level.</li> <li>This function enables to select 'Low' or 'High' in the following mode: AV (NTSC-M), HDMI or Component. Otherwise, 'Black level' is set to 'Auto'.</li> </ul>
Eye Care	<ul style="list-style-type: none"> <li>Adjust the brightness of the screen to prevent the screen from being too bright. Dims extremely bright pictures.</li> <li>This feature is disabled in "<b>Picture Mode-Vivid, Cinema</b>".</li> </ul>
Film Mode	<ul style="list-style-type: none"> <li>Makes video clips recorded in film look more natural.</li> <li>DVD and Blu-ray movies are filmed at 24 frames per second.</li> </ul>
Real Cinema	<ul style="list-style-type: none"> <li>Makes video clips recorded in film look more natural by eliminating judder effect.</li> <li>DVD and Blu-ray movies are filmed at 24 frames per second. With LG Real Cinema, every frame is consistently processed 5 times in 1/24 of a second producing 120 fps with TruMotion or 2 times in 1/24 of a second producing 48 fps without TruMotion, thus totally eliminating the judder effect.</li> </ul>
TruMotion	<p><i>*This feature is not available for all models.</i>  <i>High: Provides smoother picture movement.</i>  <i>Low: Provides smooth picture movement. Use this setting for standard use.</i>  <i>Off: Use this setting when "High" and "Low" setting result in noise.</i></p> <ul style="list-style-type: none"> <li>TruMotion provides even better quality for movies than 3:2 Pull-Down conversions.</li> <li>TruMotion can reduce the perception of blur on fast moving scenes by displaying 120 images per second.</li> <li>It is used for the best picture quality without any motion blur or judder when you enter a quick image or Film Source.</li> <li>TruMotion works with all inputs except PC mode.</li> <li>If you enable "TruMotion", noise may appear on the screen.</li> <li>If this occurs, set "TruMotion" to "Off".</li> </ul>



Color Gamut	<p><i>Standard: Displays standard color area.</i></p> <p><i>Wide: Mode to use and set the rich color area of the display.</i></p> <ul style="list-style-type: none"> <li>■ Maximize the utilization of color to increase color quality.</li> </ul>
Edge Enhancer	<ul style="list-style-type: none"> <li>■ Show clearer and distinctive yet natural corners of the video.</li> </ul>
Color Standard	<ul style="list-style-type: none"> <li>■ Convert the color of a different video to HD color.</li> </ul>
Color Filter	<ul style="list-style-type: none"> <li>■ This is the function to filter the specific colors of the video. You can use the RGB filter to set color saturation and hue accurately.</li> </ul>
White Balance	<ul style="list-style-type: none"> <li>■ This is the function to adjust the overall color of the screen to the feeling you want.</li> </ul> <p>- Red/Green/Blue Contrast, Red/Green/Blue Brightness: The adjustment range is -50 - +50.</p>
Color Management System	<ul style="list-style-type: none"> <li>■ As the tool used by the experts to make adjustments by using the test patterns, this does not affect other colors but can be used to selectively adjust the 6 color areas (Red/Green/Blue/Yellow/Cyan/Magenta). Color difference may not be distinctive even when you make the adjustments for the general video.</li> </ul> <p>Adjusts Red/Green/Blue/Yellow/Cyan/Magenta.</p> <p>- Red/Green/Blue/Yellow/Cyan, Magenta Color: The adjustment range is -30 - +30. - Red/Green/Blue/Yellow/Cyan, Magenta Tint: The adjustment range is -30 - +30. - This feature is disable in RGB-PC mode.</p>
OPC	<p><i>*This feature is not available for all models.</i></p> <ul style="list-style-type: none"> <li>■ As the technology to reduce the power consumption while keeping the same brightness, this has the effect of reducing power consumption, improvement in contrast.</li> </ul>







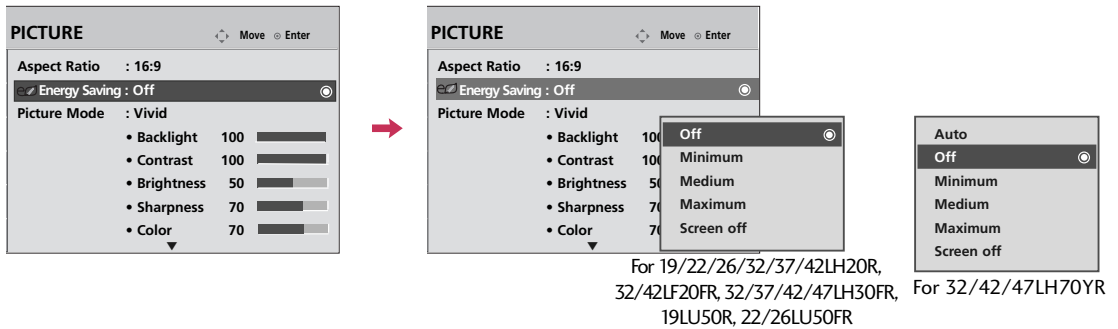

# PICTURE CONTROL

## e ENERGY SAVING

It reduces the TV's power consumption by lowering the backlight level.

You can increase the brightness of your screen by adjusting the **Energy Saving** level or by setting the **Picture Mode**.



- 1   Select **PICTURE**.
- 2   Select **Energy Saving**.
- 3   Select **Auto**(For 32/42/47LH70YR), **Off**, **Minimum**, **Medium**, **Maximum**, or **Screen Off**.
- 4  Return to the previous menu.
-  Return to TV viewing.

- When selecting **Screen off**, TV turned off after 3 seconds.
- If you adjust "**Energy Saving- Auto**(For 32/42/47LH70YR), **Minimum**, **Medium**, **Maximum**", **Backlight** feature will not work.
- When selecting **Auto**, **Backlight** is automatically adjusted through **Intelligent sensor** according to the surrounding conditions.(For 32/42/47LH70YR)
- You can also adjust **Energy Saving** in the **Q.Menu**.  
(For 19/22/26/32/37/42LH20R, 32/42LF20FR,19LU50R, 22/26LU50FR)
- Press the **ENERGY SAVING** button repeatedly to select the appropriate Energy Saving setup.

# PICTURE RESET

Settings of the selected picture modes return to the default factory settings.

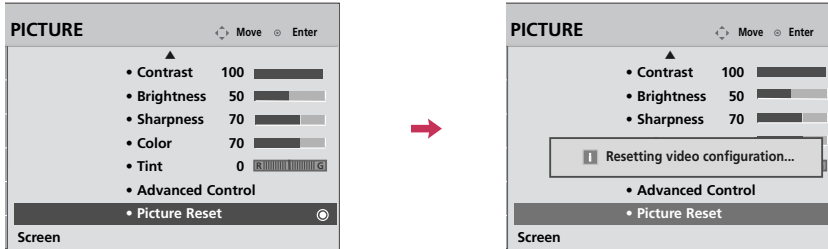

1   Select **PICTURE**.

2   Select **Picture Reset**.

3  Initialize the adjusted value.







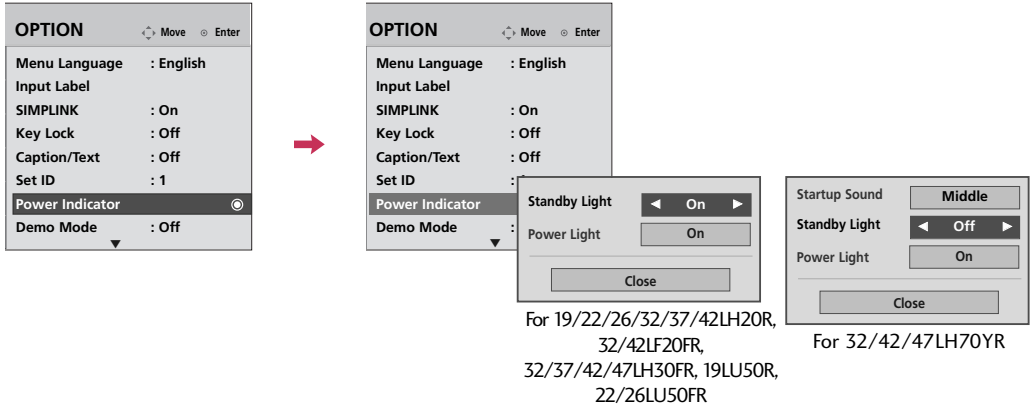

4  Return to TV viewing.

# PICTURE CONTROL

## POWER INDICATOR

Adjust the power/standby indicator light of TV front.









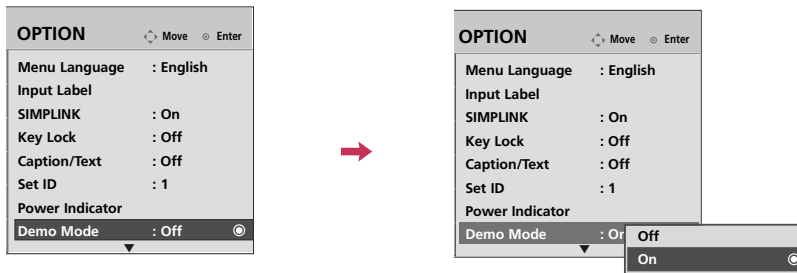

- 1   Select **OPTION**.
- 2   Select **Power Indicator**.
- 3   Select **Startup Sound**(For 32/42/47LH70YR), **Standby Light** or **Power Light**.
- 4  Select your desired options.
- 5  Return to the previous menu.
-  Return to TV viewing.

- **Startup Sound** (For 32/42/47LH70YR)  
You can turn off the starting sound of the TV or set the volume.
- **Standby Light**: Determines whether to set the indicator light on the front of the TV to **On\***, **Off\***, **Low\*** or **High\*** in standby mode.  
\* **Off, Low or High**: For 32/42/47LH70YR  
\* **Off or On**: For 19/22/26/32/37/42LH20R, 32/42LF20FR, 32/37/42/47LH30FR, 19LU50R, 22/26LU50FR
- **Power Light**: Determines whether to set the indicator light on the front of the TV to **On** or **Off** when the power turns on.

# DEMO MODE

Displays a slide show to explain the various feature of this TV.



- 1   Select **OPTION**.
- 2   Select **Demo Mode**.
- 3   Select **On** to show the various feature of the TV.
- 4  Return to TV viewing.  
After a while, **Demo Mode** starts.  
If you want to stop the demo, press any button (Except VOL +, - and MUTE button).







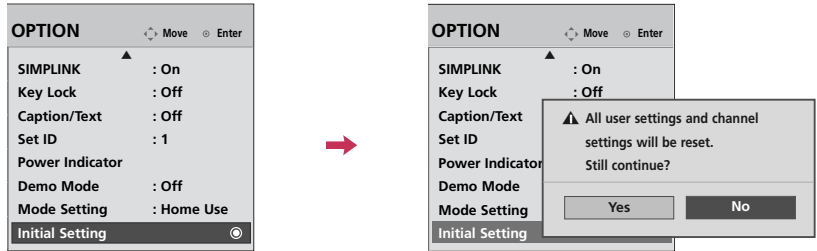

■ This feature is disabled in “Initial Setting-Home Use”.

# PICTURE CONTROL

## INITIAL SETTING (FACTORY RESET)

Use to quickly reset all the menu options to their original factory preset values. All user settings and channel settings will be reset.



-   Select **OPTION**.
-   Select **Initial Setting**.
-   Select **Yes** or **No**.
-  Return to the previous menu.
-  Return to TV viewing.







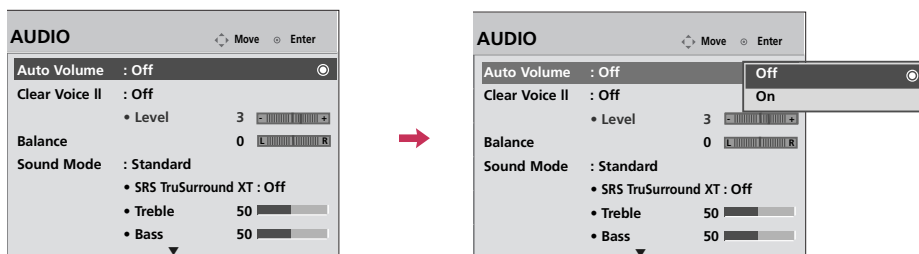

# SOUND & LANGUAGE CONTROL

## AUTO VOLUME LEVELER (AUTO VOLUME)

Auto Volume makes sure that the volume level remains consistent whether you are watching a commercial or a regular TV program.

Because each broadcasting station has its own signal conditions, volume adjustment may be needed every time the channel is changed. This feature allows users to enjoy stable volume levels by making automatic adjustments for each program.



-   Select **AUDIO**.
-   Select **Auto Volume**.
-   Select **On** or **Off**.
-  Return to the previous menu.
-  Return to TV viewing.

# SOUND & LANGUAGE CONTROL

## CLEAR VOICE II

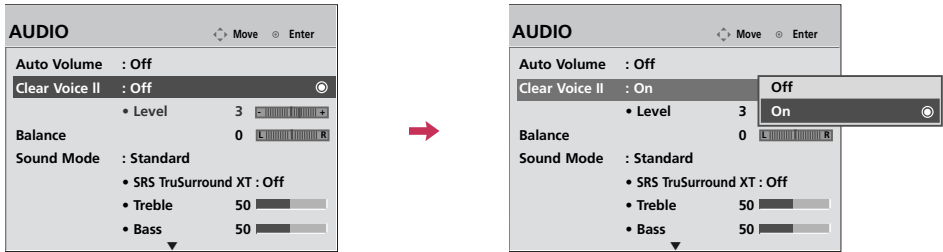

By differentiating the human sound range from others, it improves the sound quality of voices.

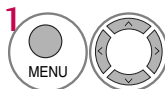
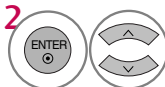
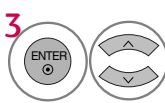

-  Select **AUDIO**.
-  Select **Clear Voice II**.
-  Select **On** or **Off**.

### Adjustment for Clear Voice Level With selecting On

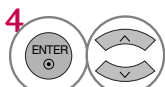
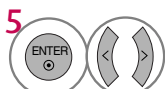
This feature adjusts the voice level.

-  Select **Level**.
-  Make appropriate adjustments.
-  Return to the previous menu.
-  Return to TV viewing.









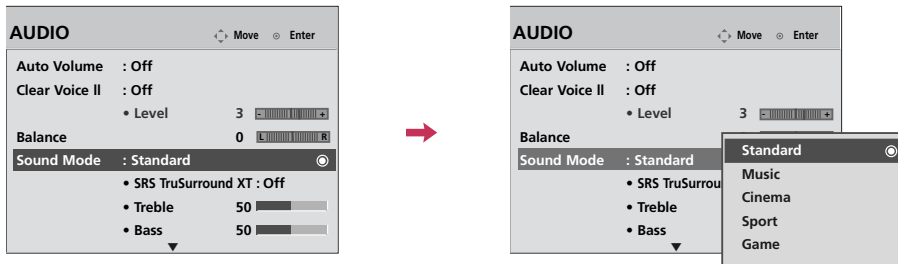

# PRESET SOUND SETTINGS (SOUND MODE)

Sound Mode lets you enjoy the best sound without any special adjustment as the TV sets the appropriate sound options based on the program content.

**Standard, Music, Cinema, Sport, and Game** are preset for optimum sound quality at the factory and are not adjustable.



- 1   Select **AUDIO**.
- 2   Select **Sound Mode**.
- 3   Select **Standard, Music, Cinema, Sport, or Game**.
- 4  Return to the previous menu.
-  Return to TV viewing.







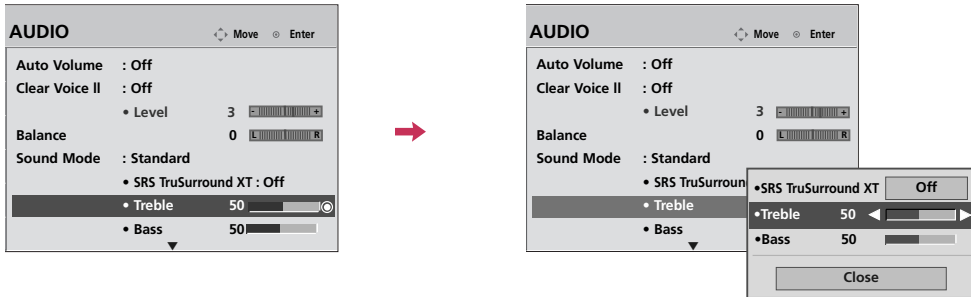

- You can also adjust **Sound Mode** in the **Q.Menu**.
- **Standard:** Offers standard-quality sound.
- **Music:** Optimizes sound for listening to music.
- **Cinema:** Optimizes sound for watching movies.
- **Sport:** Optimizes sound for watching sports events.
- **Game:** Optimizes sound for playing games.





# SOUND & LANGUAGE CONTROL

## SOUND SETTING ADJUSTMENT - USER MODE

Adjust the sound to suit your taste and room situations.











- 1   Select **AUDIO**.
- 2   Select **Sound Mode**.
- 3   Select **Standard, Music, Cinema, Sport, or Game**.
- 4   Select **Treble or Bass**.

- 5   Make appropriate adjustments.
- 6  Return to the previous menu.
-  Return to TV viewing.

## SRS TRUSURROUND XT

Select this option to sound realistic.







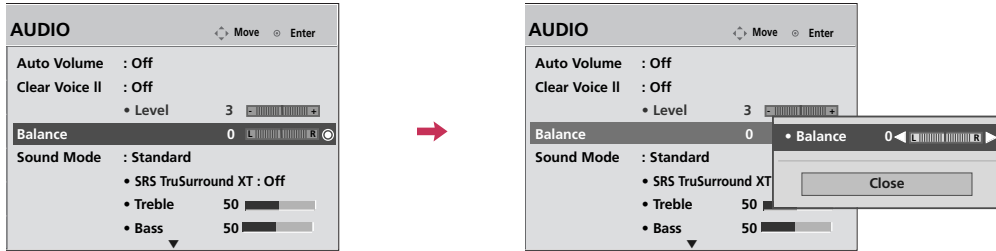

- 1   Select **AUDIO**.
- 2   Select **SRS TruSurround XT**.
- 3   Select **On or Off**.
- 4  Return to the previous menu.
-  Return to TV viewing.

- If sound quality or volume is not at the level you want, it is recommended to use a separate home theater system or amp to cope with different user environments.
- If you select “**Clear Voice II-On**”, **SRS TruSurround XT** feature will not work.
- **SRS TruSurround XT**: TruSurround XT is a patented SRS technology that solves the problem of playing 5.1 multichannel content over two speakers.

# BALANCE

Adjust the left/right sound of speaker to suit your taste and room situations.



-   Select **AUDIO**.
-   Select **Balance**.
-   Make appropriate adjustments.
-  Return to the previous menu.
-  Return to TV viewing.

# SOUND & LANGUAGE CONTROL







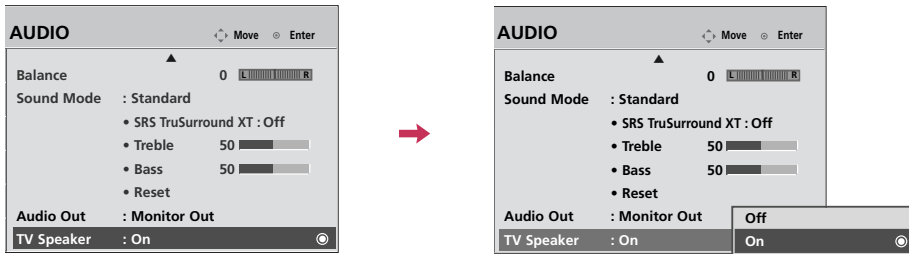

## TV SPEAKERS ON/OFF SETUP

Turn the TV speakers off if using external audio equipment.

In **AV**, **Component**, **RGB** and **HDMI** with HDMI to DVI cable, the TV speaker can be operational even when there is no video signal.

If you wish to use an external Hi-Fi system or a SRS System, turn off the TV's internal speakers.



-   Select **AUDIO**.
-   Select **TV Speaker**.
-   Select **On** or **Off**.
-  Return to the previous menu.
-  Return to TV viewing.







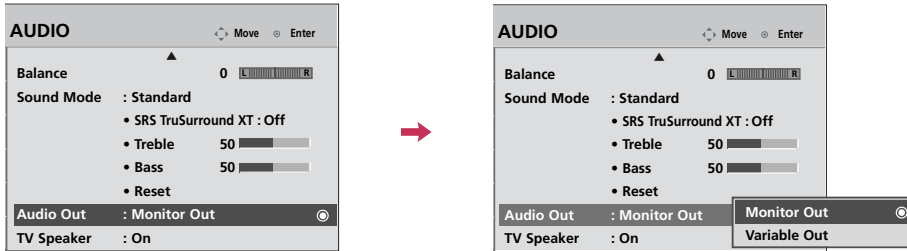

### NOTE

- ▶ When the TV speaker is turned off while the Simplink home theater is operating, the sound output automatically switches to the home theater speaker, but when the TV speaker is turned on, the sound output the TV speaker.

# SELECTING AUDIO OUT

Select **Monitor Out** or **Variable Out** to connect the audio outputs.







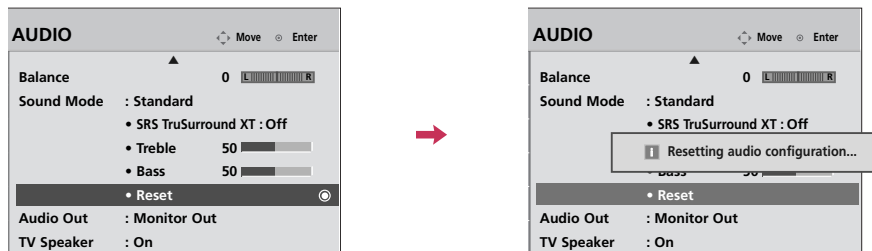

- 1   Select **AUDIO**.
- 2   Select **Audio Out**.
- 3   Select **Monitor Out** or **Variable Out**.  
▶ P. 43
- 4  Return to the previous menu.
-  Return to TV viewing.

# SOUND & LANGUAGE CONTROL

## AUDIO RESET

Settings of the selected Sound Mode return to the default factory settings.



-   Select **AUDIO**.
-   Select **Reset**.
-  Initialize the adjusted value.
-  Return to TV viewing.

# STEREO/SAP BROADCAST SETUP



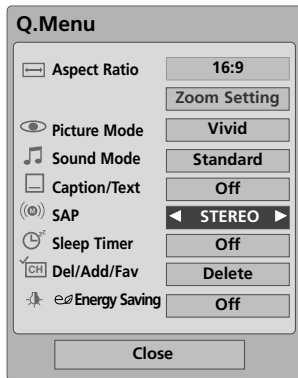

For Analog only: This TV can receive MTS stereo programs and any SAP (Secondary Audio Program) that accompanies the stereo program if the station transmits an additional sound signal. Mono sound is automatically used if the broadcast is only in Mono.

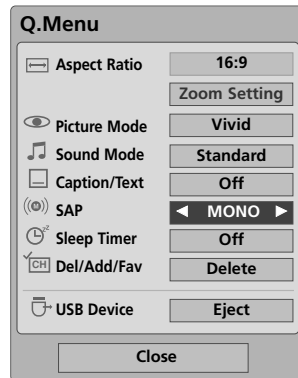

For 19/22/26/32/37/42LH20R,  
32/42LF20FR, 19LU50R,  
22/26LU50FR



For 32/37/42/47LH30FR,  
32/42/47LH70YR







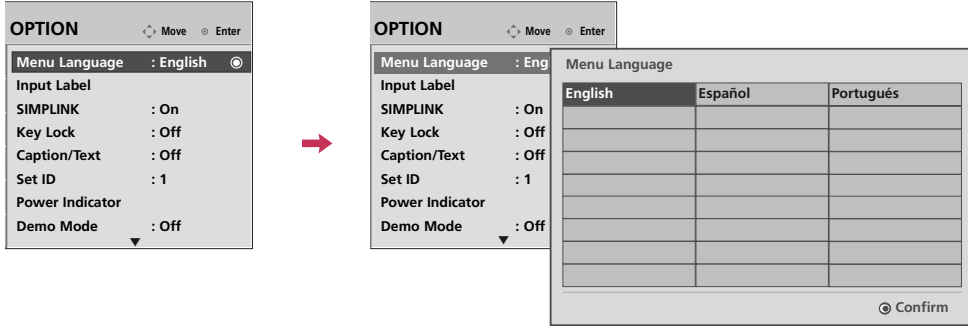

- 1   Select **SAP**.
- 2  Select **MONO, STEREO**, or **SAP**.
- 3  Return to TV viewing.

# SOUND & LANGUAGE CONTROL

## ON-SCREEN MENUS LANGUAGE SELECTION

The menus can be shown on the screen in the selected language.



-   Select **OPTION**.
-   Select **Menu Language**.
-   Select your desired language.  
From this point on, the on-screen menus will be shown in the selected language.
-  Return to the previous menu.
-  Return to TV viewing.



# CLOSED CAPTIONS

Closed captioning is a process which converts the audio portion of a television program into written words which then appear as subtitles on the television screen. Closed captions allow viewers to read the dialogue and narration of television programs.

## Using Closed Captions

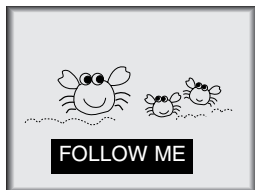

Captions are the subtitles of the dialogue and narration of television programs. For pre-recorded programs, program dialogue can be arranged into captions in advance. Its possible to caption a live program by using a process called real-time captioning, which creates captions instantly. Real-time captioning is normally done by professional reporters using a machine shorthand system and computer for translation into English. Captioning is an effective system for the hearing-impaired, and it can also aid in teaching language skills.

- The picture at left shows a typical caption.

## Caption Tips

- Not all TV broadcasts include closed caption signals.
- Sometimes TV stations broadcast four different caption signals on the same channel. By selecting Mode1 to Mode2, you can choose which signal you view. Mode1 is usually the signal with the captions, while another mode might show demonstration or programming information.
- Your TV might not receive caption signals normally in the following situations.

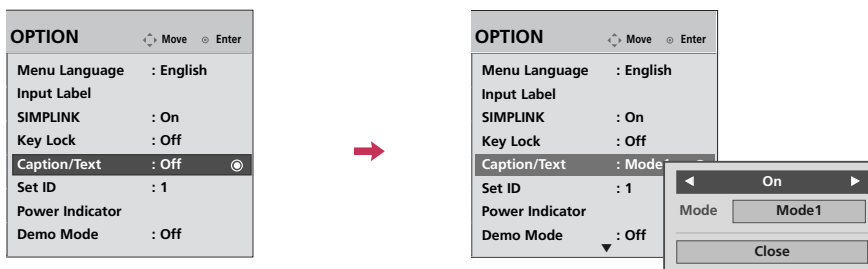

1 Select **OPTION**.

2 Select **Caption**.

3 Select **On** or **Off**.

4 Select **Mode1-2** or **Text1-2**.

5 Return to the previous menu.

Return to TV viewing.







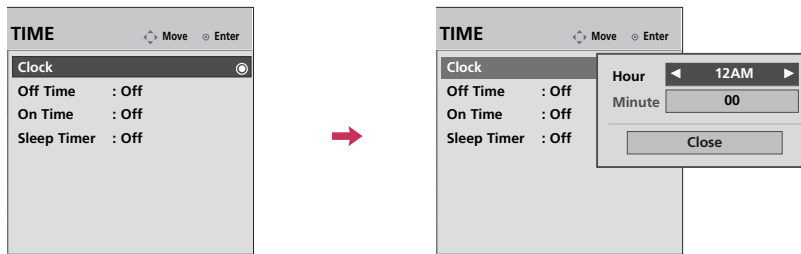

# TIME SETTING

## CLOCK SETTING

### Clock Setup

You must set the time correctly before using on/off timer function.



-   Select **TIME**.
-   Select **Clock**.
-   Select and set **Hour** or **Minute**.
-  Return to the previous menu.
-  Return to TV viewing.

■ If the TV is unplugged once or turn off with the AC power control switch on the TV, reset the **Clock** function.

# ON/OFF TIME SETTING





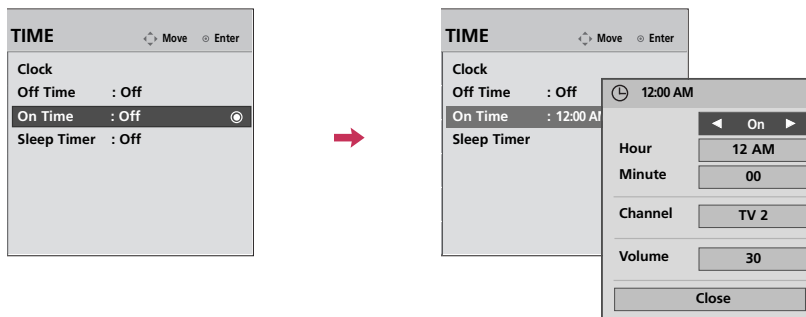

This function operates only if the current time has been set.

The **Off Time** function overrides the **On Time** function if they are both set to the same time.

The TV must be in standby mode for the **On Time** to work.





If you do not press any button within 2 hours after the TV turns on with the **On Time** function, the TV will automatically revert to standby mode.



- 1   Select **TIME**.
- 2   Select **Off time** or **On time**.
- 3    Select and set **Hour** or **Minute**.

■ To cancel **On/Off Time** function, select **Off**.

■ Only for On Time function

- 4    Select and set **Channel** or **Volume**.
- 5  Return to the previous menu.
-  Return to TV viewing.







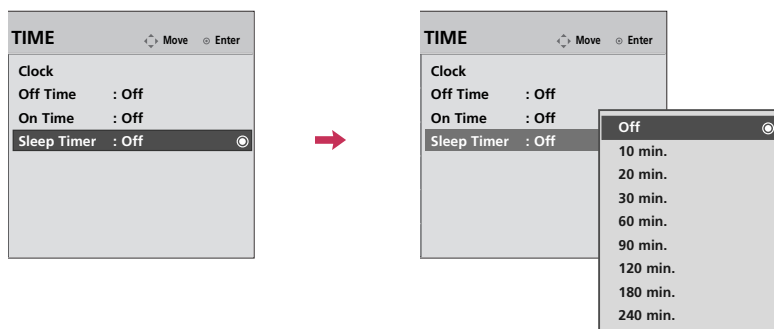

# TIME SETTING

## SLEEP TIMER SETTING

The Sleep Time turns the TV off at the preset time.

Note that this setting is cleared when the TV is turned off.



-   Select **TIME**.
-   Select **Sleep Timer**.
-   Make appropriate adjustments.
-  Return to the previous menu.
-  Return to TV viewing.

- You can also adjust **Sleep Timer** in the **Q.Menu**.
- Press the **SLEEP** button repeatedly to select the number of minutes. (For 32/42/47LH70YR)

# APPENDIX

## TROUBLESHOOTING

The operation does not work normally.	
The remote control doesn't work	<ul style="list-style-type: none"> <li>Check to see if there is any object between the product and the remote control causing obstruction. Ensure you are pointing the remote control directly at the TV.</li> <li>Ensure that the batteries are installed with correct polarity (+ to +, - to -).</li> <li>Ensure that the correct remote operating mode is set: TV, VCR etc.</li> <li>Install new batteries. <small>*This feature is not available for all models.</small></li> </ul>
Power is suddenly turned off	<ul style="list-style-type: none"> <li>Is the sleep timer set?</li> <li>Check the power control settings. Power interrupted.</li> <li>TV will be automatically turned off, in case of no signal for 15 minutes.</li> </ul>

The video does not work.	
No picture & No sound	<ul style="list-style-type: none"> <li>Check whether the product is turned on.</li> <li>Try another channel. The problem may be with the broadcast.</li> <li>Is the power cord inserted into wall power outlet?</li> <li>Check your antenna direction and/or location.</li> <li>Test the wall power outlet, plug another product's power cord into the outlet where the product's power cord was plugged in.</li> </ul>
Picture appears slowly after switching on	<ul style="list-style-type: none"> <li>This is normal, the image is muted during the product startup process. Please contact your service center, if the picture has not appeared after five minutes.</li> </ul>
No or poor color or poor picture	<ul style="list-style-type: none"> <li>Adjust Color in menu option.</li> <li>Keep a sufficient distance between the product and a VCR.</li> <li>Try another channel. The problem may be with the broadcast.</li> <li>Are the video cables installed properly?</li> <li>Activate any function to restore the brightness of the picture.</li> </ul>
Horizontal/vertical bars or picture shaking	<ul style="list-style-type: none"> <li>Check for local interference such as an electrical appliance or power tool.</li> </ul>
Poor reception on some channels	<ul style="list-style-type: none"> <li>Station or cable product experiencing problems, tune to another station.</li> <li>Station signal is weak, reorient antenna to receive weaker station.</li> <li>Check for sources of possible interference.</li> </ul>
Lines or streaks in pictures	<ul style="list-style-type: none"> <li>Check antenna (Change the direction of the antenna).</li> </ul>
No picture when connecting HDMI	<ul style="list-style-type: none"> <li>Check HDMI cable over version 1.3. The HDMI cables don't support HDMI version 1.3, it cause flickers or no screen display. In this case use the latest cables that support HDMI version 1.3.</li> </ul>

# APPENDIX

## The audio does not work.

Picture OK & No sound	<ul style="list-style-type: none"><li>■ Press the VOL or VOLUME button.</li><li>■ Sound muted? Press MUTE button.</li><li>■ Try another channel. The problem may be with the broadcast.</li><li>■ Are the audio cables installed properly?</li></ul>
No output from one of the speakers	<ul style="list-style-type: none"><li>■ Adjust Balance in menu option.</li></ul>
Unusual sound from inside the product	<ul style="list-style-type: none"><li>■ A change in ambient humidity or temperature may result in an unusual noise when the product is turned on or off and does not indicate a fault with the product.</li></ul>
No sound when connecting HDMI or USB	<ul style="list-style-type: none"><li>■ Check HDMI cable over version 1.3.</li><li>■ Check USB cable over version 2.0.</li><li>■ Use normal MP3 file.</li></ul>

\*This feature is not available for all models.

## There is a problem in PC mode. (Only PC mode applied)

The signal is out of range	<ul style="list-style-type: none"><li>■ Adjust resolution, horizontal frequency, or vertical frequency.</li><li>■ Check the input source.</li></ul>
Vertical bar or stripe on background & Horizontal Noise & Incorrect position	<ul style="list-style-type: none"><li>■ Work the Auto configure or adjust size, phase, or H/V position. (Option)</li></ul>
Screen color is unstable or single color	<ul style="list-style-type: none"><li>■ Check the signal cable.</li><li>■ Reinstall the PC video card.</li></ul>

# MAINTENANCE

Early malfunctions can be prevented. Careful and regular cleaning can extend the amount of time you can enjoy your new TV.

Caution: Be sure to turn the power off and unplug the power cord before you begin any cleaning.

## Cleaning the Screen

- 1 Here's a great way to keep the dust off your screen for a while. Wet a soft cloth in a mixture of lukewarm water and a little fabric softener or dish washing detergent. Wring the cloth until it's almost dry, and then use it to wipe the screen.
- 2 Make sure the excess water is off the screen, and then let it air-dry before you turn on your TV.

## Cleaning the Cabinet

- To remove dirt or dust, wipe the cabinet with a soft, dry, lint-free cloth.
- Please be sure not to use a wet cloth.

## Extended Absence

### CAUTION

- ▶ If you expect to leave your TV dormant for a long time (such as a vacation), it's a good idea to unplug the power cord to protect against possible damage from lightning or power surges.

# APPENDIX

## PRODUCT SPECIFICATIONS

MODELS		19LH20R (19LH20R-MA)	22LH20R (22LH20R-MA)	26LH20R (26LH20R-MA)
Dimensions (Width x Height x Depth)	With stand	18.2 x 13.8 x 6.7 inches 462.4 x 353.0 x 171.0 mm	21.0 x 15.6 x 6.7 inches 533.4 x 397.0 x 171.0 mm	26.2 x 19.8 x 8.8 inches 667.0 x 504.0 x 224.0 mm
	Without stand	18.2 x 12.1 x 2.5 inches 462.4 x 308.0 x 65.0 mm	21.0 x 13.8 x 2.5 inches 533.4 x 351.4 x 65.0 mm	26.2 x 17.5 x 3.1 inches 667.0 x 446.2 x 80.0 mm
Weight	With stand	8.3 lbs / 3.8 kg	10.5 lbs / 4.8 kg	19.6 lbs / 8.9 kg
	Without stand	7.9 lbs / 3.6 kg	10.1 lbs / 4.6 kg	17.1 lbs / 7.8 kg
MODELS		32LH20R (32LH20R-MA)	37LH20R (37LH20R-MA)	42LH20R (42LH20R-MA)
Dimensions (Width x Height x Depth)	With stand	31.6 x 22.9 x 8.8 inches 805.0 x 583.0 x 224.0 mm	36.2 x 25.9 x 11.6 inches 922.0 x 659.0 x 297.0 mm	40.4 x 28.1 x 11.6 inches 1028.0 x 715.4 x 297.0 mm
	Without stand	31.6 x 20.7 x 3.1 inches 805.0 x 528.0 x 79.9 mm	36.2 x 23.4 x 3.4 inches 922.0 x 595.0 x 88.0 mm	40.4 x 25.7 x 3.4 inches 1028.0 x 655.0 x 88.7 mm
Weight	With stand	25.3 lbs / 11.5 kg	32.6 lbs / 14.8 kg	39.6 lbs / 18.0 kg
	Without stand	22.7 lbs / 10.3 kg	28.6 lbs / 13.0 kg	35.7 lbs / 16.2 kg
MODELS		32LF20FR (32LF20FR-MA)	42LF20FR (42LF20FR-MA)	
Dimensions (Width x Height x Depth)	With stand	31.5 x 23.7 x 8.9 inches 801.8 x 604.2 x 227.3 mm	40.6 x 29.2 x 11.5 inches 1032.8 x 742.3 x 293.8 mm	
	Without stand	31.5 x 21.4 x 3.1 inches 801.8 x 544.1 x 79.0 mm	40.6 x 26.3 x 3.6 inches 1032.8 x 670.1 x 92.0 mm	
Weight	With stand	26.4 lbs / 12.0 kg	44.9 lbs / 20.4 kg	
	Without stand	23.1 lbs / 10.5 kg	39.0 lbs / 17.7 kg	
Power requirement		AC100-240V ~ 50/60Hz		
Television System		NTSC, PAL-M/N		
Program Coverage		VHF 2-13, UHF 14-69, CATV 1-125		
External Antenna Impedance		75 ohm		
Environment condition	Operating Temperature	32 ~ 104°F (0 ~ 40°C)		
	Operating Humidity	Less than 80%		
Environment condition	Storage Temperature	-4 ~ 140°F (-20 ~ 60°C)		
	Storage Humidity	Less than 85%		

■ The specifications shown above may be changed without prior notice for quality improvement.



MODELS		32LH30FR (32LH30FR-MA)	37LH30FR (37LH30FR-MA)	42LH30FR (42LH30FR-MA)	47LH30FR (47LH30FR-MA)
Dimensions (Width x Height x Depth)	With stand	31.6 x 22.9 x 8.8 inches 805.0 x 583.0 x 224.0 mm	36.2 x 25.9 x 11.6 inches 922.0 x 659.0 x 297.0 mm	40.4 x 28.1 x 11.6 inches 1028.0 x 715.4 x 297.0 mm	44.9 x 30.8 x 13.2 inches 1140.6 x 784.8 x 337.4 mm
	Without stand	31.6 x 20.9 x 3.1 inches 805.0 x 531.0 x 79.9 mm	36.2 x 23.4 x 3.4 inches 922.0 x 595.0 x 88.0 mm	40.4 x 25.9 x 3.4 inches 1028.0 x 658.6 x 88.7 mm	44.9 x 28.4 x 3.8 inches 1140.6 x 722.9 x 99.0 mm
Weight	With stand	26.6 lbs / 12.1 kg	32.8 lbs / 14.9 kg	39.6 lbs / 18.0 kg	49.6 lbs / 22.5 kg
	Without stand	24.2 lbs / 11.0 kg	28.8 lbs / 13.1 kg	35.7 lbs / 16.2 kg	43.8 lbs / 19.9 kg
MODELS		19LU50R (19LU50R-MA/MB)	22LU50FR (22LU50FR-MA/MB)	26LU50FR (26LU50FR-MA/MB)	
Dimensions (Width x Height x Depth)	With stand	18.2 x 14.7 x 7.2 inches 462.0 x 373.0 x 182.0 mm	20.9 x 16.4 x 7.7 inches 529.1 x 416.6 x 196.0 mm	26.2 x 21.1 x 9.3 inches 668.0 x 538.3 x 236 mm	
	Without stand	18.2 x 12.0 x 2.6 inches 462.0 x 305.0 x 65.0 mm	20.9 x 13.5 x 2.6 inches 529.1 x 342.3 x 65.0 mm	26.3 x 17.9 x 3.1 inches 668.0 x 456 x 81.0 mm	
Weight	With stand	9.7 lbs / 4.4 kg	11.9 lbs / 5.4 kg	19.6 lbs / 8.9 kg	
	Without stand	8.2 lbs / 3.7 kg	10.2 lbs / 4.6 kg	16.9 lbs / 7.7 kg	
MODELS		42LH50YR (42LH50YR-MA)	47LH50YR (47LH50YR-MA)	55LH50YR (55LH50YR-MA)	
Dimensions (Width x Height x Depth)	With stand	41.5x 28.3 x 11.7 inches 1052.2 x 719.1 x 296.2mm	46.2x 31.1 x 13.3 inches 1173.4 x 789.7x 337.4mm	53.4 x 35.5 x 16.7 inches 1357.0 x 901.0 x 423.0 mm	
	Without stand	41.5 x 25.9 x 3.6 inches 1052.2 x 657.3 x 90.8mm	46.2x 28.5 x 4.0 inches 1173.4x 723.4x 100.8mm	53.4 x 32.9 x 4.3 inches 1357.0 x 835.4 x 109.6 mm	
Weight	With stand	41.9 lbs / 19.0 kg	51.6 lbs / 23.4 kg	80.2 lbs / 36.4 kg	
	Without stand	37.9 lbs / 17.2 kg	45.9 lbs / 20.8 kg	72.5 lbs / 32.9 kg	
MODELS		32LH70YR (32LH70YR-MH)	42LH70YR (42LH70YR-ME)	47LH70YR (47LH70YR-ME)	
Dimensions (Width x Height x Depth)	With stand	31.6 x 24.9 x 11.2 inches 803.0 x 632.9 x 284.8 mm	39.7 x 29.6x 13.1 inches 1009.7 x 753.6 x 334.4 mm	44.2 x 32.4 x 14.6 inches 1123.5 x 823.4x 372.8 mm	
	Without stand	31.6 x 23 x 2.9 inches 803.0 x 584.2 x 75.0mm	39.7 x 27.3 x 1.5inches 1009.7 x 695.4 x 39.7 mm	44.2 x 30.1 x 1.6inches 1123.5 x 765.4x 40.9 mm	
Weight	With stand	29.7 lbs / 13.5kg	43.6 lbs / 19.8 kg	58.2 lbs / 26.4 kg	
	Without stand	25.5 lbs / 11.6kg	37.9lbs / 17.2 kg	50.2 lbs / 22.8 kg	
Power requirement Television System Program Coverage External Antenna Impedance		AC100-240V ~ 50/60Hz NTSC, PAL-M/N VHF 2-13, UHF 14-69, CATV 1-125 75 ohm			
Environment condition	Operating Temperature Operating Humidity	32 ~ 104°F (0 ~ 40°C) Less than 80%			
	Storage Temperature Storage Humidity	-4 ~ 140°F (-20 ~ 60°C) Less than 85%			

■ The specifications shown above may be changed without prior notice for quality improvement.

## IR CODES

### 1. How to Connect

- Connect your wired remote control to the Remote Control port on the TV.

### 2. Remote Control IR Codes

#### ■ Output waveform

Single pulse, modulated with 37.917KHz signal at 455KHz

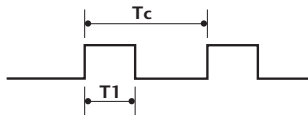

Carrier frequency  
 $FCAR = 1/T_c = f_{OSC}/12$   
 Duty ratio =  $T_1/T_c = 1/3$

#### ■ Configuration of frame

1st frame

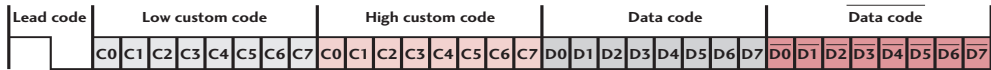

Repeat frame

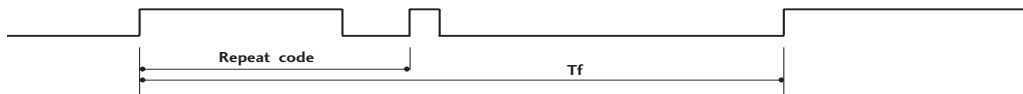

#### ■ Lead code

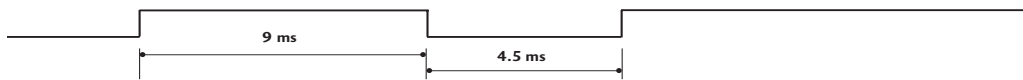

#### ■ Repeat code

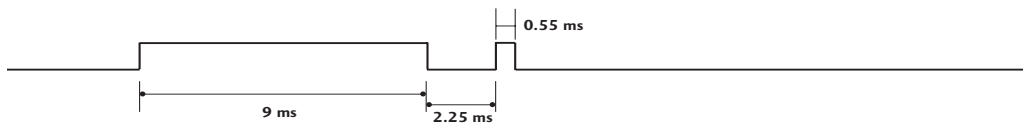

#### ■ Bit description



#### ■ Frame interval: $T_f$

The waveform is transmitted as long as a key is depressed.

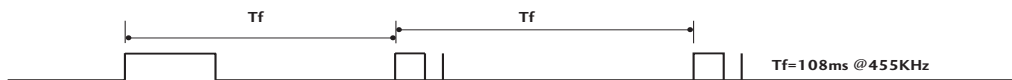

Code (Hexa)	Function	Note
08	POWER	Remote control Button (Power On/Off)
45	Q.MENU	Remote control Button
43	MENU	Remote control Button
0B	INPUT	Remote control Button
10-19	Number Key 0-9	Remote control Button
09	MUTE	Remote control Button
02	VOL +	Remote control Button
03	VOL -	Remote control Button
00	CH ^	Remote control Button
01	CH v	Remote control Button
1E	FAV/MARK	Remote control Button
40	^	Remote control Button
41	v	Remote control Button
07	<	Remote control Button
06	>	Remote control Button
7C	X STUDIO	Remote control Button
44	ENTER	Remote control Button
28	RETURN	Remote control Button
7E	SIMPLINK	Remote control Button
0E	SLEEP	Remote control Button
30	AV MODE	Remote control Button
79	RATIO	Remote control Button
95	ENERGY SAVING	Remote control Button
53	LIST	Remote control Button
1A	Q.VIEW	Remote control Button
72	RED	Remote control Button
63	YELLOW (▶)	Remote control Button
61	BLUE (◀)	Remote control Button
71	GREEN (■)	Remote control Button
8F	◀◀	Remote control Button
8E	▶▶	Remote control Button

● — Except 19/22/26/32/37/42LH20R,  
32/42LF20FR, 19LU50R,  
22/26LU50FR

● — For 32/42/47LH70YR

● — Except 32/37/42/47LH30FR

● — Except 19/22/26/32/37/42LH20R,  
32/42LF20FR, 19LU50R,  
22/26LU50FR

# APPENDIX

## EXTERNAL CONTROL THROUGH RS-232C

The RS-232C port allows you connect the RS-232C input jack to an external control device (such as a computer or an A/V control system) to control the TV's functions externally.

- Note: RS-232C on this unit is intended to be used with third party RS-232C control hardware and software. The instructions below are provided to help with programming software or to test functionality using telenet software.
- Image shown may differ from your TV.

### RS-232C Setup

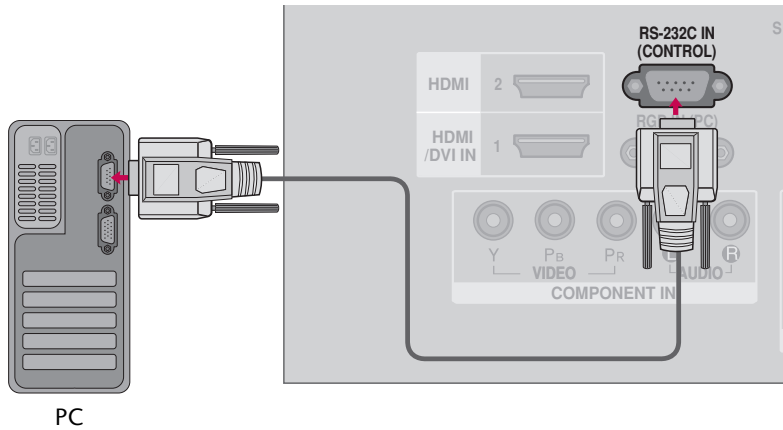

#### Type of Connector; D-Sub 9-Pin Male

No.	Pin Name
1	No connection
2	RXD (Receive data)
3	TXD (Transmit data)
4	DTR (DTE side ready)
5	GND
6	DSR (DCE side ready)
7	RTS (Ready to send)
8	CTS (Clear to send)
9	No Connection

#### Communication Parameters

- Baud rate : 9600 bps (UART)
- Data length : 8 bits
- Parity : None
- Stop bit : 1 bit
- Communication code : ASCII code
- Use a crossed (reverse) cable.

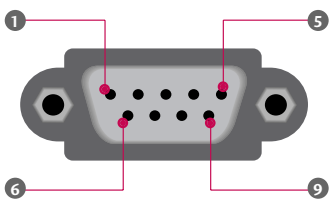

APPENDIX

## RS-232C Configurations

Either cable below can be used.

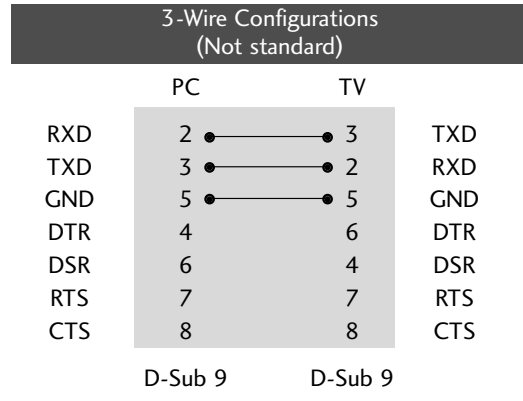
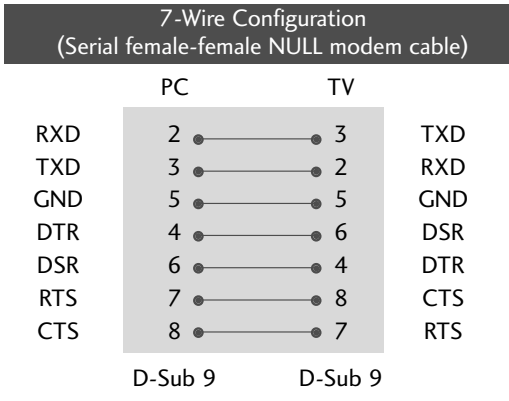

## Set ID

Use this function to specify a TV ID number.  
Refer to 'Real Data Mapping'.

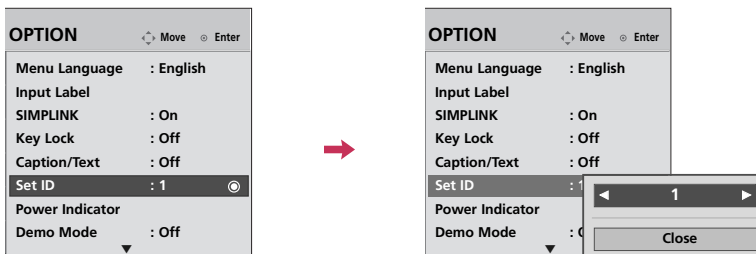

- 1 Select **OPTION**.
- 2 Select **Set ID**.
- 3 Choose the desired TV ID number.  
The adjustment range of **Set ID** is 1~99.
- 4 Return to the previous menu.
- Return to TV viewing.

### \* Real data mapping

00 : Step 0  
 .....  
 A : Step 10  
 .....  
 F : Step 15  
 10 : Step 16  
 .....  
 64 : Step 100  
 .....  
 6E : Step 110  
 .....  
 73 : Step 115  
 74 : Step 116  
 .....  
 C7 : Step 199  
 .....  
 FE : Step 254  
 FF : Step 255

## Command Reference List

	COMMAND1	COMMAND2	DATA (Hexadecimal)		COMMAND1	COMMAND2	DATA (Hexadecimal)
01. Power	k	a	00 ~ 01	13. Balance	k	t	00 ~ 64
02. Aspect Ratio	k	c	▶ p.119	14. Color Temperature	k	u	00 ~ 02
03. Screen Mute	k	d	▶ p.119	15. Treble	k	r	00 ~ 64
04. Volume Mute	k	e	00 ~ 01	16. Bass	k	s	00 ~ 64
05. Volume Control	k	f	00 ~ 64	17. Abnormal State	k	z	FF
06. Contrast	k	g	00 ~ 64	18. Auto Configure	j	u	01
07. Brightness	k	h	00 ~ 64	19. Energy Saving	j	q	▶ p.120
08. Color	k	i	00 ~ 64	21. Channel Add/Del	m	b	00 ~ 01
09. Tint	k	j	00 ~ 64	22. Key	m	c	▶ p.121
10. Sharpness	k	k	00 ~ 64	23. Input select (Main)	x	b	▶ p.121
11. OSD Select	k	l	00 ~ 01	24. Backlight	m	g	00 ~ 64
12. Remote Control Lock Mode	k	m	00 ~ 01				

	COMMAND1	COMMAND2	DATA00 (Hexadecimal)	DATA01 (Hexadecimal)	DATA02 (Hexadecimal)	DATA03 (Hexadecimal)	DATA04 (Hexadecimal)	DATA05 (Hexadecimal)
20. Channel Tuning	m	a	physical program high	major program low	major low	minor high	minor low	attribute

## Transmission / Receiving Protocol

### Transmission

**[Command1][Command2][ ][Set ID][ ][Data][Cr]**

[Command 1] : First command to control the set.(j, k, m or x)

[Command 2] : Second command to control the set.

[Set ID] : You can adjust the set ID to choose desired TV ID number in Setup menu. Adjustment range is 1 ~ 99. When selecting Set ID '0', every connected the TV is controlled. Set ID is indicated as decimal (1 ~ 99) on menu and as Hexa decimal (0x0~0x63) on transmission /receiving protocol.

[DATA] : To transmit the command data.

Transmit the 'FF' data to read status of command.

[Cr] : Carriage Return

ASCII code '0x0D'

[ ] : ASCII code 'space (0x20)'

\* In this model, TV will not send the status during the standby mode.

### OK Acknowledgement

**[Command2][ ][Set ID][ ][OK][Data][x]**

The TV transmits ACK (acknowledgement) based on this format when receiving normal data. At this time, if the data is data read mode, it indicates present status data. If the data is data write mode, it returns the data of the PC computer.

\* In this model, TV will not send the status during the standby mode.

\* Data Format

[Command 2] : Use as command.

[Set ID] : Use the small character, if set ID is 10, it will send the '0'; 'a'.

[DATA] : Use the small character, if data is 0 x ab, it will send the 'a', 'b'.

[OK] : Use the large character.

### Error Acknowledgement

**[Command2][ ][Set ID][ ][NG][Data][x]**

The TV transmits ACK (acknowledgement) based on this format when receiving abnormal data from non-viable functions or communication errors.

Data1: Illegal Code

Data2: Not supported function

Data3: Wait more time

\* In this model, TV will not send the status during the standby mode.

\* Data Format

[Command 2] : Use as command.

[Set ID] : Use the small character, if set ID is 10, it will send the '0'; 'a'.

[DATA] : Use the small character, if data is 0 x ab, it will send the 'a', 'b'.

[NG] : Use the large character

**01. Power (Command: k a)**

To control Power On/Off of the TV.

*Transmission* [k][a][ ][Set ID][ ][Data][Cr]

Data 00 : Power Off      Data 01 : Power On

*Acknowledgement* [a][ ][Set ID][ ][OK/NG][Data][x]

To show Power On/Off.

*Transmission* [k][a][ ][Set ID][ ][FF][Cr]

*Acknowledgement* [a][ ][Set ID][ ][OK/NG][Data][x]

\* If there is the time delay between command and ack message during power on sequence, It should be described like "Note: In this model, TV will send the Acknowledge after power on processing completion. There might be a time delay between command and acknowledge."

**02. Aspect Ratio (Command: k c)**

To adjust the screen format. (Main picture format)

You can adjust the screen format using the Aspect Ratio in the Picture menu.

*Transmission* [k][c][ ][Set ID][ ][Data][Cr]

Data 01: 4:3	04: Zoom
02: 16:9	10: Cinema Zoom1
09: Just Scan	⋮
	1F: Cinema Zoom 16

*Acknowledgement* [c][ ][Set ID][ ][OK/NG][Data][x]

\* Using the RGB input, you select either 16:9 or 4:3 screen aspect ratio.

\* Just Scan operates only in Component/HDMI(720p/1080i/1080p) input source.

**03. Screen Mute (Command: k d)**

To select screen mute on/off.

*Transmission* [k][d][ ][Set ID][ ][Data][Cr]

Data 00 : Screen mute off (Picture on)

Data 01 : Screen mute on (Picture off)

Data 00 : Video mute off

Data 10 : Video mute on

*Acknowledgement* [d][ ][Set ID][ ][OK/NG][Data][x]

\* In case of Video mute on only, TV will display On Screen Display(OSD). But, in case of Screen mute on, TV will not display OSD.

**04. Volume Mute (Command: k e)**

To control volume mute on/off.

You can also adjust mute using the MUTE button on remote control.

*Transmission* [k][e][ ][Set ID][ ][Data][Cr]

Data 00 : Volume mute on (Volume off)

Data 01 : Volume mute off (Volume on)

*Acknowledgement* [e][ ][Set ID][ ][OK/NG][Data][x]

**05. Volume Control (Command: k f)**

To adjust volume.

You can also adjust volume with the volume buttons on remote control.

*Transmission* [k][f][ ][Set ID][ ][Data][Cr]

Data Min : 00 ~ Max : 64

Refer to 'Real data mapping'.

*Acknowledgement* [f][ ][Set ID][ ][OK/NG][Data][x]

**06. Contrast (Command: k g)**

To adjust screen contrast.

You can also adjust contrast in the Picture menu.

*Transmission* [k][g][ ][Set ID][ ][Data][Cr]

Data Min : 00 ~ Max : 64

Refer to 'Real data mapping'.

*Acknowledgement* [g][ ][Set ID][ ][OK][Data][x]

**07. Brightness (Command: k h)**

To adjust screen brightness.

You can also adjust brightness in the Picture menu.

*Transmission* [k][h][ ][Set ID][ ][Data][Cr]

Data Min : 00 ~ Max : 64

Refer to 'Real data mapping'.

*Acknowledgement* [h][ ][Set ID][ ][OK/NG][Data][x]

**08. Color (Command: k i)**

To adjust the screen color.

You can also adjust color in the Picture menu.

*Transmission* [k][i][ ][Set ID][ ][Data][Cr]

Data Min : 00 ~ Max : 64

Refer to 'Real data mapping'.

*Acknowledgement* [i][ ][Set ID][ ][OK/NG][Data][x]

**09. Tint (Command: k j)**

To adjust the screen tint.

You can also adjust tint in the Picture menu.

*Transmission* [k][j][ ][Set ID][ ][Data][Cr]

Data Red : 00 ~ Green : 64

Refer to 'Real data mapping'.

*Acknowledgement* [j][ ][Set ID][ ][OK/NG][Data][x]

## 10. Sharpness (Command: k k)

To adjust the screen sharpness.

You can also adjust sharpness in the Picture menu.

*Transmission* [k][k][ ][Set ID][ ][Data][Cr]

Data Min: 00 ~ Max: 64

Refer to 'Real data mapping'.

*Acknowledgement* [k][ ][Set ID][ ][OK/NG][Data][x]

## 11. OSD Select (Command: k l)

To select OSD (On Screen Display) on/off when controlling remotely.

*Transmission* [k][l][ ][Set ID][ ][Data][Cr]

Data 00: OSD off

Data 01: OSD on

*Acknowledgement* [l][ ][Set ID][ ][OK][Data][x]

## 12. Remote Control Lock Mode (Command: k m)

To lock the remote control and the front panel controls on the set.

(If you're not using the remote control and front panel controls on the TV, use this mode. When main power is on/off, remote control lock is released.)

*Transmission* [k][m][ ][Set ID][ ][Data][Cr]

Data 00: Lock off

Data 01: Lock on

*Acknowledgement* [m][ ][Set ID][ ][OK/NG][Data][x]

## 13. Balance (Command: k t)

To adjust balance.

You can also adjust balance in the Audio menu.

*Transmission* [k][t][ ][Set ID][ ][Data][Cr]

Data Min: 00 ~ Max: 64

Refer to 'Real data mapping'.

*Acknowledgement* [t][ ][Set ID][ ][OK/NG][Data][x]

## 14. Color Temperature (Command: k u)

To adjust color temperature.

You can also adjust Color Temperature in the Picture menu.

*Transmission* [k][u][ ][Set ID][ ][Data][Cr]

Data 00: Medium 01: Cool 02: Warm

*Acknowledgement* [u][ ][Set ID][ ][OK/NG][Data][x]

## 15. Treble (Command: k r)

To adjust treble.

You can also adjust treble in the Audio menu.

*Transmission* [k][r][ ][Set ID][ ][Data][Cr]

Data Min: 00 ~ Max: 64

Refer to 'Real data mapping'.

*Acknowledgement* [r][ ][Set ID][ ][OK/NG][Data][x]

## 16. Bass (Command: k s)

To adjust bass.

You can also adjust bass in the Audio menu.

*Transmission* [k][s][ ][Set ID][ ][Data][Cr]

Data Min: 00 ~ Max: 64

Refer to 'Real data mapping'.

*Acknowledgement* [s][ ][Set ID][ ][OK/NG][Data][x]

## 17. Abnormal State (Command: k z)

To recognize an abnormal state.

*Transmission* [k][z][ ][Set ID][ ][FF][Cr]

Data FF: Read

*Acknowledgement* [z][ ][Set ID][ ][OK/NG][Data][x]

Data 00: Normal (Power on and signal exist)

Data 01: No signal (Power on)

Data 02: Turn the TV off by remote control

Data 03: Turn the TV off by sleep time function

Data 04: Turn the TV off by RS-232C function

Data 08: Turn the TV off by Off time function

Data 09: Turn the TV off by Auto off function

\* This function is "read only".

## 18. Auto Configure (Command: j u)

To adjust picture position and minimize image shaking automatically. It works only in RGB-PC mode.

*Transmission* [j][u][ ][Set ID][ ][Data][Cr]

Data 01: To set

*Acknowledgement* [u][ ][Set ID][ ][OK/NG][Data][x]

## 19. Energy Saving (Command: j q)

To reduce the power consumption of the TV.

*Transmission* [j][q][ ][Set ID][ ][Data][ ][Cr]

Data 00: Energy Saving: off

Data 01: Energy Saving: Minimum

Data 02: Energy Saving: Medium

Data 03: Energy Saving: Maximum

Data 04: Auto (For 32/42/47LH70YR)

Data 05: Screen off

*Acknowledgement* [q][ ][Set ID][ ][OK/NG][Data][x]



## 20 . Channel Tuning (Command: m a)

Tune Channel to following Physical/major/minor number

```
Transmission [m][a][ ][Set ID][ ][Data0][ ][Data1][ ][Data2][Cr]
```

Data 0: Physical Channel Number(Transmit by Hexadecimal code)

NTSC air: 02~45

NTSC cable: 01 , 0e~7d

Data1 , Data2: Major Channel Number(two part) or Channel Number(one part)

Data1: High byte

Data2: Low byte

Two part channel number: Major number-Minor number

One part channel number:

In case of using one part channel number, minor channel does not need.

Data3, Data4: Minor Channel Number

Not needed for NTSC.

Data3: High byte

Data4: Low byte

Data5:

Attribute

7	Main/Sub Picture	6	Two/One Part Channel	5	Using Physical Channel	4	Reserved	3	2	1	0	Step
0	Main	0	Two	0	Use	x		0	0	0	0	NTSC air
1	Sub	1	One	1	No Use	x		0	0	0	1	NTSC cable

### \* Two/One part Channel: 6<sup>th</sup> bit

This bit is used in a cable-ready system.

### \* Using physical channel: 5<sup>th</sup> bit

If the channel band is NTSC air or NTSC cable, channel tuning can be done by only physical channel. In this case, using physical channel bit must be low(0).

## 21. Channel Add/Del(Command: m b)

To add and delete the channels.

```
Transmission [m][b][ ][Set ID][ ][Data][Cr]
```

Data 00 : Channel Delete      01 : Channel Add

```
Acknowledgement [b][ ][Set ID][ ][OK/NG][Data][x]
```

## 22. Key (Command: m c)

To send IR remote key code.

```
Transmission [m][c][ ][Set ID][ ][Data][Cr]
```

Data: Key code - Refer to page 115.

```
Acknowledgement [c][ ][Set ID][ ][OK/NG][Data][x]
```

Example)

1. Analog channel: NTSC cable, channel number(35), main picture

Command: ma 00 23 xx xx xx xx 01

attribute(0x01): main picture, two part(it's not mandatory), using physical channel, NTSC cable 'data: don't care major and minor channel number in case analog channel tuning

```
Acknowledgement[a][ ][Set ID][ ][OK][Data0][Data1][Data2][Data3][Data4][Data5][x][a][ ][Set ID][ ][NG][Data0][x]
```

## 23. Input Select (Command: x b)

To select input source for TV.

```
Transmission [x][b][ ][Set ID][ ][Data][Cr]
```

Data 10: TV

Data 20: AV/AV1                      Data 21: AV2

Data 40: Component/Component1

Data 41: Component 2

Data 60: RGB-PC                      Data 90: HDMI/HDMI1

Data 91: HDMI2                      Data 92: HDMI3

```
Acknowledgement [b][ ][Set ID][ ][OK/NG][Data][x]
```

## 24. Backlight (Command: m g)

To adjust screen backlight.

```
Transmission [m][g][ ][Set ID][ ][Data][Cr]
```

Data Min:00 ~ Max:64 (\*transmit by Hexadecimal code)

\*Refer to 'Real data mapping'.

```
Acknowledgement [g][ ][Set ID][ ][OK/NG][Data][x]
```

**LG Electronics Inc.**