

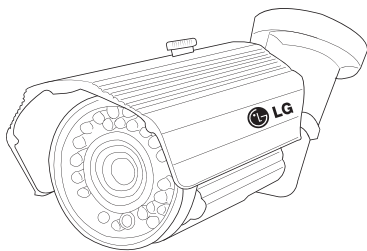

# Color IR Camera

Owner's Manual

Model : LSR300



\*\* Before installing or adjusting please read installation guide that accompany this product. Failure to follow warning notices and instructions may result in property damage. Improper installation and/or operation will void the warranty.

## Before Using or Installing.

---

Please do not make any attempt to disassemble the camera.

Do not attempt to open camera.

There is no space for consumers to construct or execute.

Please consult to professional installer.

Please do not use strong chemicals or detergent.

Use dry towel to wipe off the camera, to clean off the stain use weak cleaning detergent.

Before operation please check the temperature, humidity, and level of the power.

Please operate camera between temperature levels of  $-10^{\circ}\text{C}$  ~  $50^{\circ}\text{C}$ .

Please do not disclose the camera, if there is lot of smoke or gas.

Please do not disclose the camera under direct sunlight.

Do not aim camera directly at bright object.

By doing so, this action will cause blooming or smear.

Please handle camera with care.

Do not put camera near fire, as this may cause fire.

Please do not hit, or shake the camera.

This could cause camera to malfunction. Improper care or use of the camera could damage the camera.

Please do not make childrens handle or operate camera. It may cause children's accidents or camera's malfunction.

# Table of Contents

---

Feature.....	4
How to use the product & Warnings on Installation.....	4
Product composition & Parts names.....	5
Installation & Connection.....	7
Trouble shooting.....	8
Product Specification.....	9

## Features

---

- Sony 1/3" SUPER HAD COLOR CCD
- Resolution 540TVL(Color), 570TVL(B/W)
- DAY & NIGHT Auto Change
- Varifocal DC AUTO IRIS 6~50mm F1.4
- 34 IR LED
- Max. 30m IR LED Valid Distance
- Min. Illumination 0LUX (LED ON)
- 3 AXIS BRACKET
- Zoom & Focus adjustment Levers
- DC IRIS adjustment Lever
- DIP SWITCH CONTROL
- Water / Dust Proof (IP 66)DC IRIS LEVEL
- Use of DC 12V

## How to Use & Installations Warnings

---

Use of DC 12V. ( Use DC12V, 700mA adapter)

Using improper power supply could lead to fire, electronic shock, and malfunction of camera.

Prevent water, liquid, metal or foreign object getting inside the Camera.

Use dry towel to clean camera instead of the abrasive.

(This could bring low quality screen view of camera.)

Do not misplace the camera. And prevent any malfunction.

Do not use camera in humid or wet area.

Do not disclose camera to direct sunlight

Do not expose camera to massive electric wave.

Do not install camera location with lot of vibration.

Do not install product near very high temperature or very low temperature area.

( Please refer to our operation manual on operation temperature & storage temperature.)

# Product composition & Parts names

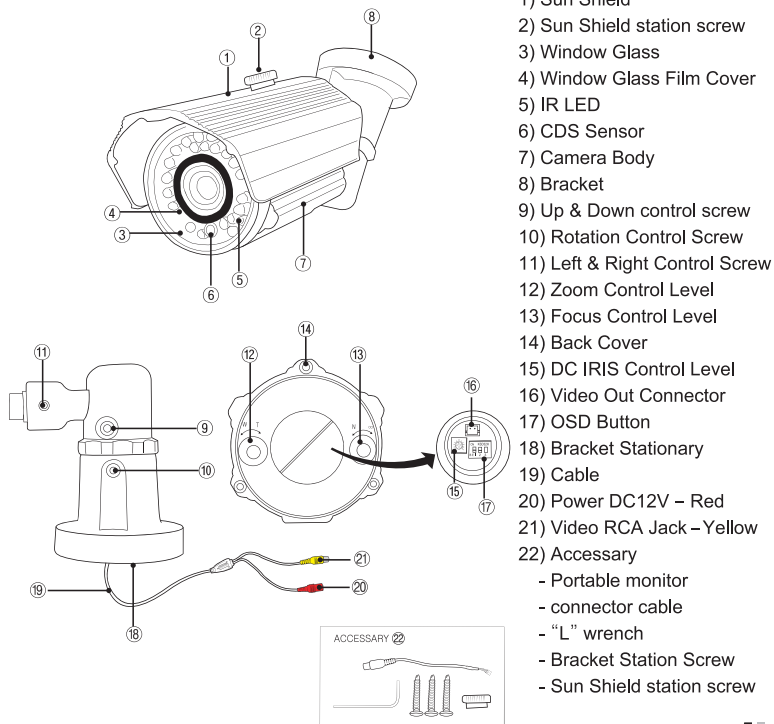

# Product composition & Parts names

## 3 Axis adjust bracket

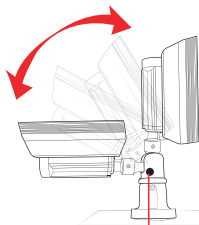

⑨ Up & Down  
Control Screw

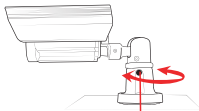

⑩ ROTATION  
Control Screw

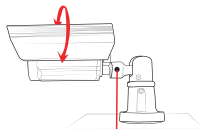

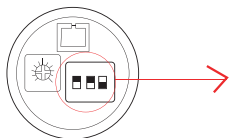

⑪ Left & Right  
Control Screw

## Dip Switch Function



### Factory Setting

AE MODE FIXED	BLC OFF	AGC OFF
		
AE MODE AUTO	BLC ON	AGC ON

### 1. 1st Dip Switch

- \* AE MODE FIXED(ALC): You can adjust brightness ~ darkness to use DC IRIS VR switch (Shutter speed: 1/50-PAL, 1/60-NTSC)
- \* AE MODE AUTO(ELC): Automatically adjusting brightness ~ darkness (Shutter speed: 1/50~1/100,000-PAL, 1/60~1/100,000-NTSC)

# Dip Switch Function

---

## 2. 2nd Dip Switch

BLC ON/OFF

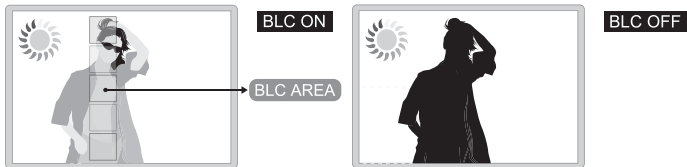

- On: Allows you to control Gamma & Back Light Compensation. If there is a strong light behind an objective, With Back Light Compensation it provide you clear image.
- Off: Back Light Compensation is not effective.

## 3. 3rd Dip Switch

AGC ON/OFF

- On: it's possible to control AGC. It can help to maintain it after raising the settled level at low light.
- Off: When AGC function is off, Day/Night & IR on/off functions do not operate.

# INSTALLATION & CONNECTION

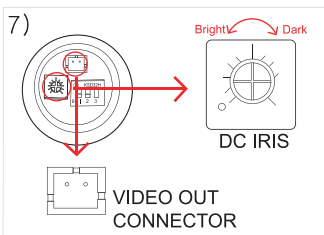
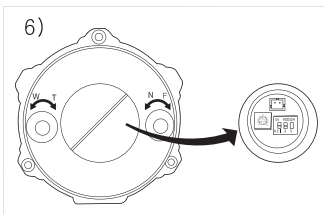
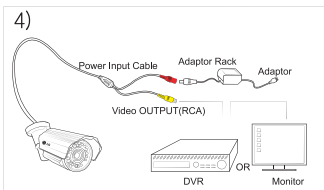

1. Station Bracket on the wall or ceiling with the screw give to your desire area.
2. Loosen up the joint on the bracket using "L" wrench and set the bracket to the direction you want to monitor and tighten the joint. ( Check Bracket Feature )
3. Use Sunshield screw to station it to the camera housing
4. Input DC12V power adapter to Power Input Socket as directed in the picture.  
With Video Output connect them to Monitor or DVR.
5. Manually turn the level behind camera and set camera view to close range or distanced range, as well as setting up the camera focus (For Zoom-out turn the knob to W direction, to Zoom-in turn the knob to T direction. / Until the camera focus is clear turn the focus level to N (close range) or  $\infty$  (distanced range).
6. Using a flat driver open the cover behind camera. (DC-IRIS Volume Switch: To clear view of screen turn the switch to clockwise direction using a screw driver. / Also to see the darker drive turn the switch counter-clockwise.
7. Button function behind the camera are as following.  
\*\* DC-IRIS VOLUME SWITCH : To see bright screen view twist the level counter-clockwise and to see the screen darker twist the level clock wise.  
\*\* With Dip Switch option you could configure your desire screen configure.  
\*\* Service port : You can use this port with portable monitor to configure the setting easily.
8. After the configuration close the back cover tightly to prevent any water smear.



# Trouble Shooting

---

## **If you are not able to view anything from the screen.**

Check power, video, strength of signal.

Check monitor input/output.

Check camera connection number with monitor.

## **For Fuzzy Screen**

Check camera lens for dust or dirt. If so wipe them off with dry towel or brush.

Check cover to see if it's clean. If so wipe them off with dry towel or brush.

Check for direct sunlight exposure towards camera.

Check if protection film from camera cover is removed

Check for camera focus.

## **For Dark Screen**

Check for Monitor Brightness.

## **Unbalanced Black & White on the Monitor.**

-Check Monitor

-Adjust the cameras position or angle of lens when screen is bright

-Turn BLC off.

## **When screen is not clear with IR LED functioning.**

-Check glass cover for dust : If there is dust clean them with dry towel or brush.

If problem still remains please contact our Technical Support Department.

# Product Specification

Specification	NTSC	PAL
Image Sensor	1/3" INTERLINE Color CCD(Super HAD)	
Picture Elements	768(H) x 494(V)/380K	752(H) x 582(V)/440K
Scanning System	525Lines, 2:1 Interlace	625 Lines, 2:1 Interlace
Electronic Frequency	15.834KHz(H),59.94Hz(V)	15.625KHz(H), 50Hz(V)
Horizontal Resolution	540TVL(Color), 570TVL(B/W)	
Shutter Speed	1/60~1/100,000	1/50~1/100,000
S/N Ratio	More Than 48dB (AGC Off)	
Sync System	Internal	
Minimum Lux	0Lux(AGC High), IR LED 34ea	
White Balance	ATW	
Video Output	CVBS 1Vp-p (75 $\Omega$ )	
LENS	2.8~12mm Day &Night Varifocal, DC Auto Iris Lens(F:1.2)	
Power Consumption	DC12V $\pm$ 10%	
Used Electronicity	Max 100mA(IR Off), Max 350mA(IR ON)	
Operation Temperature	-10 $^{\circ}$ C~50 $^{\circ}$ C,0%RH~80%RH	
Storage Temperature	-20 $^{\circ}$ C~60 $^{\circ}$ C,0%RH~80%RH	
Size	$\phi$ 74 x 151mm	
Weight	940g	

# WARRANTY

Product Name : \_\_\_\_\_

Model Name : \_\_\_\_\_

Purchase Date : \_\_\_\_\_

Customer Name : \_\_\_\_\_ Tel : \_\_\_\_\_ Address : \_\_\_\_\_

Store Name : \_\_\_\_\_ Tel : \_\_\_\_\_ Address : \_\_\_\_\_



Please keep this warranty document until your service requirement for LG Electronics

1. This product will receive its warranty under the warranty policy
2. Warranty service will start as of the purchase date. Please acquire purchase date from the store. ( If the product purchase date is unavailable, warranty date will start 3month after the manufacture date.)
3. If house supply is used for commercial purpose or if it's a commercial product the warranty date will be decrease down to 1/2. ( Major parts included )
4. This warranty document will not be reissued.
5. If sub-part were supply and under condition of other contract, the warranty will be effected under flexible warranty condition.

#### Major Supply Storage Term.

*Refrigerator, TV, Audio, Microwave, Room Air-condition, Commercial Refrigerator, Fan	----- 7 years,
*Car set -----	5 years,
*VTR, Video Camera, DVD Player, MP3 Player, Gas Oven, Pan Heater, Fan, Air Refresher	----- 5 years,
*Rice Cooker, PC and other accessory -----	4 years,
*Cell Phone, Gas Stove -----	3 years,
**And all the similar above product.	

#### Major Supply Warranty Term.

*Refrigerator, Air condition compressor, TV CPT, Monitor CDT -----	4 years,
*Wash Machine Motor, Micro Wave Magnetron, VTR Head Drum, Fan Heater, Rotary Heater, Burner, PC Main Board ( Mother Board) -----	3 years,
*LCD TV, PDP TV, LCD Monitor Panel ( Notebook Monitor is excluded)	----- 2 years,

\*\* Even though Product Warranty still exist if the use time of 10,000 hours for MONITOR CDT exceed warranty is voided, For LCD TV, PDP TV, LCD Monitor panel exceed use time of 5,000 will void the warranty

## **Consumer Right**

Consumer has the valuable right to 2 years warranty. If the product is defective or malfunction.

However, if the malfunction was caused by consumer the warranty will not be free of charge.

### **Customers Responsibility on Paid Warranty**

If warranty service is requested, under these terms you will not be cover under warranty.

1. If substance is submitted into the product ( water, coffee, liquid, toys) and cause product to malfunction
2. If product is damaged or no longer works due to consumers mistake. ( Dropping and etc)
3. If the outside of the product is damage due to use of chemical product.
4. Any other part that is not from LG (Adapter, Battery, Filter, earphone, etc) LG Electronic original part could be purchased at nearby LG Store.
5. Malfunction due to irregular electronic voltage
6. If consumer disassemble product on their own
7. If product was serviced by non-authorized technician.
8. Malfunction or Damage by Natural disaster ( Earth quake, flood, fire, gas, etc)
9. Malfunction by not following LG products ““Safety manual””
10. Other malfunction or damage cause by consumer.

## **LG ELECTRONICS SERICE INSTRUCTION**

For service request, customer service please contact our LG Electronics

# OSD(Screen Control) Menu

## -AGC ( Auto Gain Control)

with OSD function you could control UP&DOWN to select your desire mode.



\* ON

-AGC controls brightness from 0 ~ 255 Range

\* OFF

-When AGC function is off, Day/Night & IR on/off functions do not operate.

# MEMO

---

A large, empty rectangular box with rounded corners, designed for writing. It contains 12 horizontal lines spaced evenly down the page, providing a structured area for notes or a memo.

# MEMO

---

A large, vertically oriented rounded rectangle with a thin black border. Inside the rectangle, there are 12 horizontal lines spaced evenly, providing a template for writing a memo. The lines are thin and black, and the corners of the rectangle are smoothly rounded.

