



User Guide

XB14 (XB14-D0U, XBS14V)



As an ENERGY STAR® Partner, LG has determined that this product or product models meet the ENERGY STAR® guidelines for energy efficiency.

ENERGY STAR® is a U.S. registered mark.

ENGLISH

SVENSKA

DANSK

NORSK

SUOMI

LATVIEŠU

LIETUVIŲ

EESTI

РУССКИЙ

P/NO: MFL62886107

Safety Precaution



CAUTION
RISK OF ELECTRIC SHOCK
DO NOT OPEN



CAUTION : TO REDUCE THE RISK OF ELECTRIC SHOCK DO NOT REMOVE COVER (OR BACK) NO USER-SERVICEABLE PARTS INSIDE REFER SERVICING TO QUALIFIED SERVICE PERSONNEL.



This lightning flash with arrowhead symbol within an equilateral triangle is intended to alert the user to the presence of uninsulated dangerous voltage within the product's enclosure that may be of sufficient magnitude to constitute a risk of electric shock to persons.



The exclamation point within an equilateral triangle is intended to alert the user to the presence of important operating and maintenance (servicing) instructions in the literature accompanying the product.

WARNING : TO PREVENT FIRE OR ELECTRIC SHOCK HAZARD, DO NOT EXPOSE THIS PRODUCT TO RAIN OR MOISTURE.

WARNING : Do not install this equipment in a confined space such as a book case or similar unit.

CAUTION: Do not block any ventilation openings. Install in accordance with the manufacturer's instructions. Slots and openings in the cabinet are provided for ventilation and to ensure reliable operation of the product and to protect it from over heating. The openings shall be never be blocked by placing the product on a bed, sofa, rug or other similar surface. This product shall not be placed in a built-in installation such as a bookcase or rack unless proper ventilation is provided or the manufacturer's instruction has been adhered to.

CAUTION : This product employs a Laser System.

To ensure proper use of this product, please read this owner's manual carefully and retain it for future reference. Shall the unit require maintenance, contact an authorized service center. Use of controls, adjustments or the performance of procedures other than those specified herein may result in hazardous radiation exposure.

To prevent direct exposure to laser beam, do not try to open the enclosure. Visible laser radiation when open. DO NOT STARE INTO BEAM.

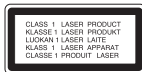

CAUTION : The apparatus shall not be exposed to water (dripping or splashing) and no objects filled with liquids, such as vases, shall be placed on the apparatus.

CAUTION : concerning the Power Cord

Most appliances recommend they be placed upon a dedicated circuit ;

That is, a single outlet circuit which powers only that appliance and has no additional outlets or branch circuits. Check the specification page of this owner's manual to be certain.

Do not overload wall outlets. Overloaded wall outlets, loose or damaged wall outlets, extension cords, frayed power cords, or damaged or cracked wire insulation are dangerous. Any of these conditions could result in electric shock or fire. Periodically examine the cord of your appliance, and if its appearance indicates damage or deterioration, unplug it, discontinue use of the appliance, and have the cord replaced with an exact replacement part by an authorized service center.

Protect the power cord from physical or mechanical abuse, such as being twisted, kinked, pinched, closed in a door, or walked upon. Pay particular attention to plugs, wall outlets, and the point where the cord exits the appliance.

To disconnect power from the mains, pull out the mains cord plug. When installing the product, ensure that the plug is easily accessible.

"This device is equipped with a portable battery or accumulator.

Safe way to remove the battery or the battery from the equipment:

Remove the old battery or battery pack, follow the steps in reverse order than the assembly. To prevent contamination of the environment and bring on possible threat to human and animal health, the old battery or the battery put it in the appropriate container at designated collection points. Do not dispose of batteries or battery together with other waste. It is recommended that you use local, free reimbursement systems batteries and accumulators."

The battery shall not be exposed to excessive heat such as sunshine, fire or the like.



Disposal of your old appliance

1. When this crossed-out wheeled bin symbol is attached to a product it means the product is covered by the European Directive 2002/96/EC.
2. All electrical and electronic products should be disposed of separately from the municipal waste stream via designated collection facilities appointed by the government or the local authorities.
3. The correct disposal of your old appliance will help prevent potential negative consequences for the environment and human health.
4. For more detailed information about disposal of your old appliance, please contact your city office, waste disposal service or the shop where you purchased the product.



This product is manufactured to comply with EMC Directive 2004/108/EC and Low Voltage Directive 2006/95/EC.

European representative:

LG Electronics Service Europe B.V.
Veluwezoom 15, 1327 AE Almere, The Netherlands
(Tel : +31-036-547-8940)

Welcome to your New DVD MICRO Hi-Fi SYSTEM

Contents

Setting up	4
Main unit	5
Remote control	6
OSD initial language settings - Optional	7
Initial settings of the Area Code	7
Adjusting the general settings	8-9
Displaying Disc information	9
Playing a Disc or file	10-11
Using an USB device	12
Listening to music from your portable player	12
Recording to USB	13
Listening to the radio	14
Language Codes	15
Area Codes	15
Troubleshooting	16
Types of Playable Discs	17
Specifications	18

Setting up

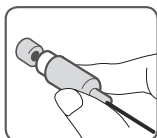

1 Video Out connection

Connect the VIDEO OUTPUT(MONITOR) jack on the unit to the corresponding input jack on your TV using a Video cable.

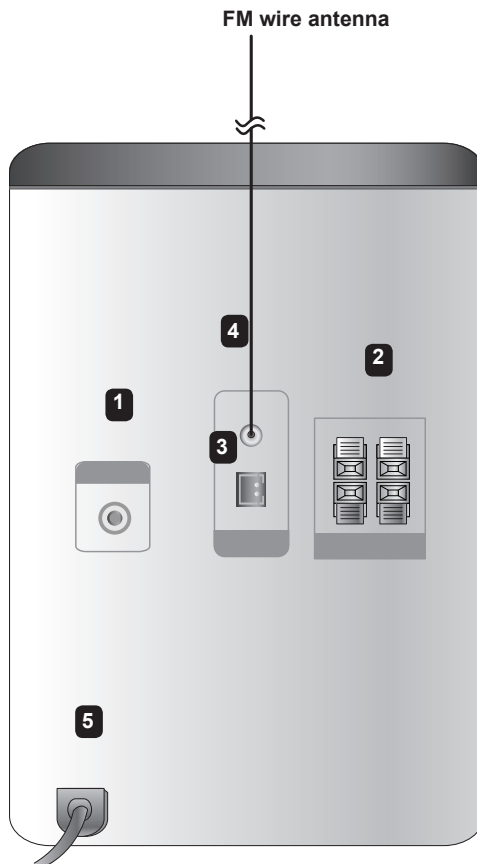

2 Connect the wires to the unit.

Match each wire's coloured band to the same coloured connection terminal on the reverse of the unit. To connect the cable to the unit, press each plastic finger pad to open the connection terminal. Insert the wire and release the finger pad.

Notes

- If TV screen becomes discolored do not place front speakers within 30cm from TV.
- Be sure to match the speaker cord to the appropriate terminal on the components: + to + and - to -. If the cords are reversed, the sound will be distorted and will lack base.

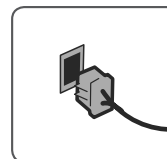

3 Fit the AM loop aerial to its stand (Optional)

Connect the AM loop aerial to the unit. Then unfold and install the aerial as below.

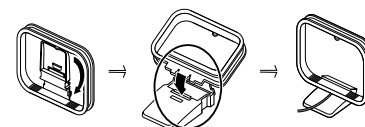

4 Stretch the FM aerial.

The reception will be at its best when the end of the aerial is stretched to be in a straight line and horizontal.

Main unit

Screen Saver

The screen saver appears when you leave the unit in Stop mode for about five minutes.

 **Power on/ off**

FUNCTION
Change the functions between DVD/CD, USB, PORTABLE, FM, AM (OPTIONAL).

VOLUME
Control the volume when using any function

PROGRAM/MEMORY

- On the CD/USB mode, you can make your own playlist.
- On FM/AM mode, you can save radio stations.

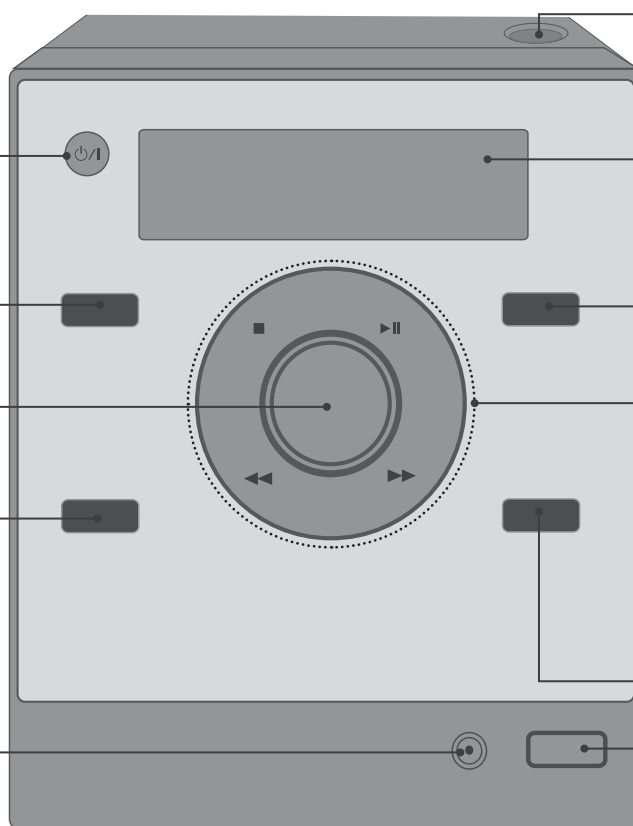

PORT.IN
The player can be used to play the music from many types of portable player.



OPEN
You can use it when inserting or removing CDs.

DISPLAY WINDOW.

EQ.: Sound quality adjustment
You can choose sound impressions.

 Stop
 Play/Pause
 Searches backward or forward
Skips to the previous/next track
TUN. (-)/ (+)
Selects the radio station
PRE. (-)/ (+)
Selects preset numbers

REC.
Recording to USB

USB Connector

Remote control

FUNCTION : Selects the function and input source.
SLEEP : You can select delay time between 10 and 180 minutes, after the unit will turn off. To check the remaining time, press **SLEEP**.

POWER : Switches the unit ON or OFF.
 * : The button is not available.

TITLE : If the current DVD title has a menu, the title menu appears on the screen. Otherwise, the disc menu may not appear.

DISPLAY : Accesses On-Screen Display.
MENU : Accesses the menu on a DVD disc.
SETUP : Accesses or removes setup menu.

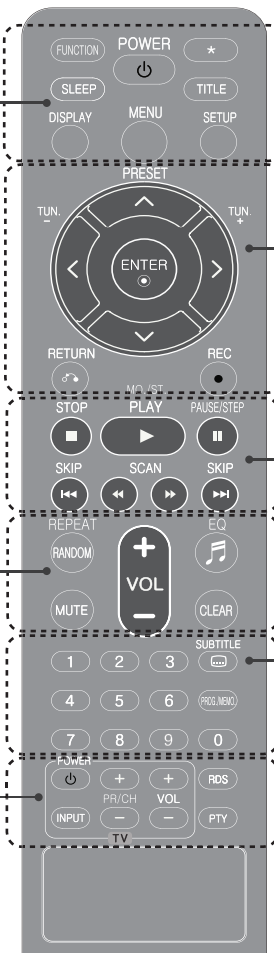

PRESET (Λ V) : Selects programme of Radio.

TUN. (-/+): Tunes in the desired radio station.

< > ^ v (left/ right/ up/ down): Navigates on-screen displays.

ENTER : Acknowledges menu selection.

RETURN (↶) : Moves backwards in the menu or exited the setup menu.

REC (●) : Recording to USB

STOP (■) : Stops playback or recording.

PLAY (▶): Starts playback.

MO./ST. : Improves radio signal reception.

PAUSE/STEP (||) : Pauses playback.

SKIP (◀◀ / ▶▶) : Goes to next or previous chapter/ track/ file.

SCAN (◀◀/▶▶) : Searches backward or forward.

REPEAT/RANDOM : To select a play mode. (Random/ Repeat)

MUTE: Temporarily stop the sound.

EQ(Equalizer effect) : You can choose sound impressions.

CLEAR : Removes a track number on the program List.

VOL : Adjusts spaker volume.

0-9 numerical buttons : Selects numbered options in a menu.

SUBTITLE :

During playback, you can select a desired subtitle language .

PROG./MEMO. :

Saves radio stations in FM/AM mode.

Creates your own playlist for playback

TV Control buttons : Controls the TV. (LG TV only)

Controlling the TV.

You can control the sound level, input source, and power switching of LG TVs as well. Hold **POWER** (TV) and press **PR/CH**(+/-) button repeatedly until the TV turns on or off.

RDS/PTY(Optional): Radio Data System
 Searches radio stations by radio type.

Put the batteries into the remote control.

Make sure that the + (plus) and - (minus) on the batteries match those on the remote control. Battery shall not be exposed to excessive heat such as sunshine, fire or the like.

OSD initial language settings - Optional

During the first use of this unit, the initial language setup menu appears on your TV screen. You must complete initial language selection before using the unit.

	ON REMOTE
1 Turn the power on: The language list appears.	⏻ POWER
2 Select the language:	< > ^ v
3 Press:	ENTER
4 To confirm press:	< > ENTER

Initial settings of the Area Code

When you use this unit for the first time, you have to set the Area Code as shown below. Refer to page 15 for code list.

	ON REMOTE
1 Display setup menu:	SETUP
2 Select LOCK menu on the first level:	^ v
3 Move to second level: The activated Area Code appears on the second level.	>
4 Move to the third level:	>
5 Enter a new password:	Numeric (0-9) and ENTER
6 Recheck the entered new password:	
7 Select a code for a geographic area: After select, Rating and Password will be activated.	< > ^ v
8 To confirm what you press : Make sure to finish setting the Area Code.	ENTER

Adjusting the general settings

	ON REMOTE
1 Display setup menu:	SETUP
2 Select a desired option on the first level:	^ v
3 Move to the second level:	>
4 Select a desired option on the second level:	^ v
5 Move to the third level:	>
6 Change the setting:	^ v, ENTER

Adjusting the general settings - more you can do

Adjusting the language settings

OSD (Menu Language) – Select a language for the Setup menu and on-screen display.

Disc Audio/ Disc Subtitle/ Disc Menu – Select a language for the Disc Audio/ Disc Subtitle/ Disc Menu.

[Original] Refers to the original language in which the disc was recorded.
[Other] To select another language, press number buttons then **ENTER** to enter the corresponding 4-digit number according to the language code list in the reference chapter (**Page 15**). If you make a mistake before pressing **ENTER**, press **CLEAR**.

[Off] Turn off Subtitle.
 (for Disc Subtitle)

Adjusting the display settings

TV Aspect – Select which screen aspect to use based on the shape of your TV screen.

[4:3] Select when a standard 4:3 TV is connected.

[16:9] Select when a 16:9 wide TV is connected.

Display Mode – If you selected 4:3, you'll need to define how you would like wide screen programs and films to be displayed on your TV screen.

[Letterbox] This displays a wide screen picture with black bands at the top and bottom of the screen.

[Panscan] This fills the entire 4:3 screen, cropping the picture as necessary.

Adjusting the audio settings

DRC (Dynamic Range Control) – Make the sound clear when the volume is turned down (Dolby Digital only). Set to [On] for this effect.

Vocal – Select [On] to mix karaoke channels into normal stereo. This function is effective for multi-channel karaoke DVDs only.

Adjusting the lock settings

To access the lock options, you must enter the 4-digit password. If you have not yet entered a password you are prompted to do so.

1 Enter a 4-digit password then press **ENTER**.

2 Enter it again then press **ENTER** to verify. If you make a mistake while entering number, press **CLEAR** then correct it.

Rating – Select a rating level. The lower the level, the stricter the rating. Select [Unlock] to deactivate the rating.

Password – Sets or changes the password for lock settings.

[New] Enter a new 4-digit password using the numerical buttons then press **ENTER**. Enter the password again to confirm.

[Change] Enter the new password twice after entering the current password.

If you forget your password you can reset it.

1 Remove the disc in the unit.

2 Press **SETUP** to display the Setup menu. Input '210499' and press **ENTER**. The password has now been cleared.

Area Code – Select a code for a geographic area as the playback rating level. This determines which area's standards are used to rate DVDs controlled by the parental lock. See the Area Codes on **page 15**.

Adjusting the others settings

DivX(R) Registration – We provide you with the DivX® VOD (Video On Demand) registration code that allows you to rent and purchase videos using the DivX® VOD service.

For more information, visit www.divx.com/vod.

Press **ENTER** and you can view the registration code of the unit.

Sytem select - OPTIONAL

You must select the appropate system mode for your TV system. If "NO DISC" appears in the display window, press and hold **PAUSE/STEP (II)** for more than five seconds to be able to select a system. (NTSC/ AUTO/ PAL)

Enjoying a pre-programmed sound field

The system has a number of pre-set surround sound fields. You can select a desired sound mode by using **EQ**. The displayed items for the Equalizer may be different depending on sound sources and effects.







- | | |
|---------------------------------|--|
| AUTO EQ | Realizes the sound equalizer that is the most similar to the genre of which is included in the MP3 ID3 tag of song files. |
| ROCK
POP
CLASSIC | This program lends an enthusiastic atmosphere to the sound, giving you the feeling you are at an actual rock, pop, or classic concert. |
| XDSS ON | Reinforce the treble, bass and surround sound effect. |
| NORMAL | You can enjoy the sound without equalizer effect. |

Displaying Disc information

	ON REMOTE
1 Press:	DISPLAY
2 Select an item:	^ v
3 Adjust the display menu settings:	< >
4 To return the exit:	↶ RETURN

Displaying Disc Information - more you can do

You can select an item by pressing ^ v and change or select the setting by pressing < >.

 1/23	Current title (or track/ file) number/ total number of titles (or tracks/ files)
 1/7	Current chapter number/ total number of chapters
 0:03:24	Elapsed playing time
 1 ENG	Selected audio language or channel
 Off	Selected subtitle
 1/1	Selected angle/ total number of angles
 NORMAL	Selected sound mode

Symbol Used in this Manual

All discs and file listed below
DVD and finalized DVD±R/RW
DivX files
JPEG files



MP3 files
WMA files
Audio CDs



Playing a Disc or file

	ON REMOTE
1 Insert a disc on unit:	
2 Select DVD/CD:	FUNCTION
3 Adjust the menu settings: / Select a file from the menu:	^ v < >
4 Start the disc playing:	▶ PLAY or ENTER
5 To stop the disc playing:	■ STOP

Notes:

Put a disc on the disc tray with the disc hole on it matched and press it until you hear a click. If not, the disc cannot be read.

Playing a Disc or file - more you can do

Playing a DVD that has a menu **DVD**

Most DVDs now have menus which load first before the film begins to play.

- 1 You can navigate these menus using ^ v < > to highlight an option.
- 2 Press ENTER to select.

Mixed disc or USB Flash Drive – DivX, MP3/ WMA and JPEG

When playing a disc or USB Flash Drive containing with DivX, MP3/ WMA and JPEG files together, you can select menu of files which you would like to play by pressing MENU.

Skipping to the next/ previous chapter/ track/ file

MP3 DVD WMA DivX ACD

Press SKIP (▶▶) to move to the next chapter/ track/ file.
Press SKIP (◀◀) to return to the beginning of the current chapter/ track/ file.
Press SKIP (◀◀) twice briefly to step back to the previous chapter/ track/ file.

Pausing playback **ALL**

- 1 Press PAUSE/STEP (II) to pause playback.
- 2 Press PLAY (▶) to continue playback.

Frame-by-Frame playback **DVD DivX**

Press PAUSE/STEP (II) repeatedly to play title Frame-by-Frame.

Playing repeatedly or randomly

MP3 DVD WMA DivX ACD

Press REPEAT/RANDOM repeatedly, and the current title, chapter or track will be played back repeatedly or randomly.
To return to normal playback, press REPEAT/RANDOM repeatedly.
- Random play mode: only music files.

Fast forward or fast reverse **MP3 DVD WMA DivX ACD**

Press SCAN (◀◀ or ▶▶) to play fast forward or fast reverse during playback.
You can change the playback speed by pressing SCAN (◀◀ or ▶▶) repeatedly.
Press PLAY (▶) to continue play at normal speed.

1.5 times faster playback **DVD**

Press PLAY when a DVD is already playing to watch and listen to a DVD 1.5 times faster than normal playback speed. "▶ x1.5" will appear in the screen. Press ▶ PLAY again to return to normal playback speed.

Slowing down the playing speed **DVD**

- 1 While playback is paused, press ◀◀/▶▶ on the remote control.
- 2 You can change the various playback speed by pressing ◀◀/▶▶ repeatedly.
- 3 Press ▶ to continue play at normal speed.

Selecting a subtitle language **DVD DivX**

During playback, press SUBTITLE repeatedly to select a desired subtitle language.

Changing the character set to display DivX® subtitle correctly - Optional **DivX**

- 1 If the subtitle does not display properly during playback, press and hold SUBTITLE for about 3 seconds to display the language code menu.
- 2 Press SUBTITLE repeatedly to change the language code until the subtitle is displayed properly.

Viewing the Title menu **DVD**

Press TITLE to display the disc's title menu, if available.

Starting play from selected time **DVD** **DivX**

Searches for the starting point of entered time code.

- 1 Press **DISPLAY** then select clock icon.
- 2 Enter a time then press **ENTER**.

For example, to find a scene at 1 hour, 10 minutes, and 20 seconds, enter "11020" by using numerical buttons and press **ENTER**. If you enter the wrong number, press **CLEAR** to enter again.

Last Scene Memory **DVD**

This unit memorizes the last scene from the last disc that is viewed. The last scene remains in memory even if you remove the disc from the unit or switch off (Stand-by mode) the unit. If you load a disc that has the scene memorized, the scene is automatically recalled.

Creating your own program **MP3** **WMA** **ACD**

You can play the contents of a disc in the order you want by arranging the order of the musics on the disc. The program is cleared when the disc is removed.

- 1 Select a desired music then press **PROG./MEMO**. or select "↵" and then press **ENTER** to add the music to the program list.
- 2 To add all music in the disc, select "↵" and then press **ENTER**.
- 3 Select a music from the program list then press **ENTER** to start programmed playback.
- 4 To clear a music from the program list, select the music you want to clear then press **CLEAR** or select "⏏" icon and then press **ENTER**.
To clear all music from the program list, select "⏏" then press **ENTER**.

Displaying file information **MP3**

You can check the ID3 Tag information of MP3 files only in discs by pressing **DISPLAY** repeatedly.

Viewing photo files as a slide show **JPG**

- 1 Use \wedge \vee $<$ $>$ to highlight (⏏) icon then press **ENTER** to start slide Show.
- 2 You can change slide show speed using $<$ $>$ when (⏏) icon is highlighted.

Skipping to the next/ previous photo **JPG**

Press **SKIP** (⏏ or ⏏) or $<$ $>$ to view the previous/ next photo.

Rotating a photo **JPG**

Use \wedge \vee to rotate the photo in full screen counterclockwise or clockwise while viewing a photo in full screen.

Playable file requirement

DivX

- Available resolution: within 800x600 (W x H) pixels
- The file name of the DivX subtitle should be entered within 45 characters.
- If there is impossible code to express in the DivX file, it may be displayed as " _ " mark on the display.
- If the video and audio structure of recorded files is not interleaved, either video or audio is outputted.
- Playable DivX file : ".avi", ".mpg", ".mpeg", ".divx"
- Playable Subtitle format : SubRip (*.srt/ *.txt), SAMI (*.smi), SubStation Alpha (*.ssa/ *.txt), MicroDVD (*.sub/ *.txt), SubViewer 2.0 (*.sub/ *.txt).
- Playable Codec format : "DIVX3.xx", "DIVX4.xx", "DIVX5.xx", "MP4V3", "3IVX".
- Playable Audio format : "AC3", "PCM", "MP3", "WMA".
- For discs formatted in Live file system, you cannot play it on the player.
- If the name of movie file is different from that of the subtitle file, during playback of a DivX file, subtitle may not be displayed.

MP3/ WMA

- Sampling frequency : within 32 - 48 kHz (MP3/ WMA)
- Bit rate : within 32 - 320 kbps (MP3), 40 - 192 kbps (WMA)
- File extensions : ".mp3"/ ".wma"
- CD-ROM file format : ISO 9660 LEVEL 1 / JOLIET
- We recommend that you use Easy-CD Creator, which creates an ISO 9660 file system.

JPG

- Normal: 5120 x 3840, Progressive jpeg: 2043 x 1536
- Recording condition: ISO9660 LEVEL 1/ JOLIET
- Maximum files : Under 999.
- Some discs may not operate due to a different recording format or the condition of disc.
- File extensions: ".jpg"

Using an USB device

You can enjoy media files saved on an USB device by connecting it to the USB port of the unit. If you want to operate other function, see the DISC playback section.

	ON REMOTE
1 Connect the USB device to the USB port of the unit.	
2 Select the function:	FUNCTION
3 Select a file you want to play:	^ v
4 Start your media playing:	▶ PLAY or ENTER
5 To stop, press:	■ STOP
6 Before disconnecting, you have to change to any other function:	FUNCTION

Compatible USB Devices

- MP3 Player : Flash type MP3 player.
- USB Flash Drive : Devices that supports USB 2.0 or USB 1.1.
- The USB function of this unit does not support all USB devices.

USB device requirement

- Devices which require additional program installation when you have connected it to a computer, are not supported.

Look out for the following.

- Do not extract the USB device while in operation.
- For a large capacity USB, it may take longer than a few minute to be searched.
- To prevent data loss, back up all data.
- If you use a USB extension cable or USB hub, the USB device is not recognized.
- Using NTFS file system is not supported. (Only FAT(16/32) file system is supported.)
- This unit is not supported when the total number of files is 1000 or more.
- External HDD, Card readers, Locked devices, or hard type USB devices are not supported.
- USB port of the unit cannot be connected to PC.
- The unit can not be used as a storage device.

Listening to music from your portable player

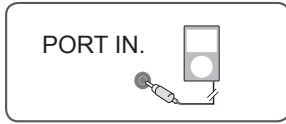
	ON REMOTE
1. Connect the portable player to the PORTABLE IN connector of the unit. <div style="border: 1px solid black; padding: 10px; margin: 10px 0; text-align: center;">  <p>PORT IN.</p> </div>	
2. Turn the power on.	POWER
3 Select the PORTABEL function.	FUNCTION
4 Turn on the portable player and start it playing	-

Recording to USB

	ON REMOTE
1 Connect the USB device to the USB port of the unit.	
2 Select a mode in which you want to record: (ex. CD/ TUNER/ ...) Play a sound source first If you want to record desired music file in disc to USB, play a file before starting the recording.	FUNCTION
3 Start the recording:	● REC
4 To stop, press:	■ STOP

Recording to USB - more you can do

Recording Music file in disc source to USB

One track recording

If the USB recording is started during playback of the CD, the one track/ file would be recording into the USB.

All tracks recording

If the ● **REC** is pressed at the CD stop, all tracks/ files would be recording. The files in the sub-folders are not recorded during all track recording.

Program list recording

USB records after creating your own program if you want to record the track you want (AUDIO CD Only).

When you are recording, look out for the following

- You can check the recording percentage rate for the USB record on the screen during the recording.
- During recording MP3/ WMA, there is no sound.
- When you stop recording, the file that has been recorded at that time will be stored. (AUDIO CD Only)
- Do not remove the USB device during USB recording. If not, an incomplete file may be made and not deleted on PC.
- If USB recording does not work, the message like "NO USB", "ERROR", "USB FULL" or "NO REC" is displayed on the display window.
- Multi card reader device or External HDD can not be used for USB recording.
- A file is recorded by 2 hours (about 128 Mbytes) when you record for a long term.
- In the state CD-G disc, USB record is not operated.
- You may not record more than 999 files.
- The file number is saved automatically.
- **It'll be stored as follows.**

AUDIO CD	MP3/ WMA	The other sources.
<ul style="list-style-type: none"> └ CD_REC └ TRK-001 └ TRK-002 └ - └ - 	<ul style="list-style-type: none"> └ FILE_REC └ 001_ABC(File name) └ 002_DEF(File name) └ - └ - 	<ul style="list-style-type: none"> └ EXT_REC └ AUD-001 └ AUD-002 └ - └ -

The making of unauthorized copies of copy-protected material, including computer programs, files, broadcasts and sound recordings, may be an infringement of copyrights and constitute a criminal offense.

This equipment should not be used for such purposes.

**Be responsible
Respect copyrights**

Listening to the radio

Make sure both for the FM and AM(Optional) aerials to be stretched to the most.

	ON UNIT	ON REMOTE
1 Select FM or AM(Optional):	FUNCTION	FUNCTION
2 Select a radio station:	◀◀ / ▶▶	TUN. - / +
3 To save a radio station: A preset number will show in the display.	PROGRAM/ MEMORY	PROG./MEMO.
4 Select the preset number: Up to 50 radio stations can be saved.	PRE. (-) / (+)	PRESET ^ / v
5 To confirm press:	PROGRAM/ MEMORY	PROG./MEMO.

Listening to the radio - more you can do

Looking for radio stations automatically

Press and hold **TUN.- / TUN.+** for more than a second. The tuner will scan automatically and stop when it finds a radio station.

Deleting all the saved stations

- 1 Press and hold **PROG./MEMO.** for two seconds.
- "ERASE ALL" will flash up on the display.
- 2 Press **PROG./MEMO.**.

Improving poor FM reception

Press **▶ MO./ST.** on the remote control. This will change the tuner from stereo to mono and usually improve the reception.

Seeing the information about your radio stations - OPTIONAL

The FM tuner is supplied with the Radio Data System (RDS) facility. This shows the letters RDS on the display, plus information about the radio station being listened to. Press RDS on the remote control several times to view the information.

PTY - Program Type, such as News, Sport, Jazz.

RT - Radio Text, the name of the radio station.

CT - Time Control, the time at the location of the radio station.

PS - Program Service name, the name of channel.

You can search the radio stations by program type by pressing RDS. The display will show the last PTY in use. Press PTY one or more times to select your preferred program type. Press and hold **</>** on the remote control. The tuner will search automatically. When a station is found the search will stop.

Language Codes

Use this list to input your desired language for the following initial settings: Disc Audio, Disc Subtitle, Disc Menu.

Language	Code	Language	Code	Language	Code	Language	Code	Language	Code
Afar	6565	Croatian	7282	Hausa	7265	Lingala	7678	Quechua	8185
Afrikaans	6570	Czech	6783	Hebrew	7387	Lithuanian	7684	Rhaeto-Romance	8277
Albanian	8381	Danish	6865	Hindi	7273	Macedonian	7775	Rumanian	8279
Ameharic	6577	Dutch	7876	Hungarian	7285	Malagasy	7771	Russian	8285
Arabic	6582	English	6978	Icelandic	7383	Malay	7783	Samoa	8377
Armenian	7289	Esperanto	6979	Indonesian	7378	Malayalam	7776	Sanskrit	8365
Assamese	6583	Estonian	6984	Interlingua	7365	Maori	7773	Scots Gaelic	7168
Aymara	6588	Faroese	7079	Irish	7165	Marathi	7782	Serbian	8382
Azerbaijani	6590	Fiji	7074	Italian	7384	Moldavian	7779	Serbo-Croatian	8372
Bashkir	6665	Finnish	7073	Japanese	7465	Mongolian	7778	Shona	8378
Basque	6985	French	7082	Kannada	7578	Nauru	7865	Sindhi	8368
Bengali; Bangla	6678	Frisian	7089	Kashmiri	7583	Nepali	7869	Singhalese	8373
Bhutani	6890	Galician	7176	Kazakh	7575	Norwegian	7879	Slovak	8375
Bihari	6672	Georgian	7565	Kirghiz	7589	Oriya	7982	Slovenian	8376
Breton	6682	German	6869	Korean	7579	Panjabi	8065	Spanish	6983
Bulgarian	6671	Greek	6976	Kurdish	7585	Pashto, Pushto	8083	Sudanese	8385
Burmese	7789	Greenlandic	7576	Laothian	7679	Persian	7065	Swahili	8387
Byelorussian	6669	Guarani	7178	Latin	7665	Polish	8076	Swedish	8386
Chinese	9072	Gujarati	7185	Latvian, Lettish	7686	Portuguese	8084	Tagalog	8476
								Tajik	8471
								Tamil	8465
								Telugu	8469
								Thai	8472
								Tonga	8479
								Turkish	8482
								Turkmen	8475
								Twi	8487
								Ukrainian	8575
								Urdu	8582
								Uzbek	8590
								Vietnamese	8673
								Volapük	8679
								Welsh	6789
								Wolof	8779
								Xhosa	8872
								Yiddish	7473
								Yoruba	8979
								Zulu	9085

Area Codes







Choose an area code from this list.

Area	Code	Area	Code	Area	Code	Area	Code	Area	Code
Afghanistan	AF	Costa Rica	CR	Greenland	GL	Maldives	MV	Paraguay	PY
Argentina	AR	Croatia	HR	Hong Kong	HK	Mexico	MX	Philippines	PH
Australia	AU	Czech Republic	CZ	Hungary	HU	Monaco	MC	Poland	PL
Austria	AT	Denmark	DK	India	IN	Mongolia	MN	Portugal	PT
Belgium	BE	Ecuador	EC	Indonesia	ID	Morocco	MA	Romania	RO
Bhutan	BT	Egypt	EG	Israel	IL	Nepal	NP	Russian Federation	RU
Bolivia	BO	El Salvador	SV	Italy	IT	Netherlands	NL	Saudi Arabia	SA
Brazil	BR	Ethiopia	ET	Jamaica	JM	Netherlands Antilles	AN	Senegal	SN
Cambodia	KH	Fiji	FJ	Japan	JP	New Zealand	NZ	Singapore	SG
Canada	CA	Finland	FI	Kenya	KE	Nigeria	NG	Slovak Republic	SK
Chile	CL	France	FR	Kuwait	KW	Norway	NO	Slovenia	SI
China	CN	Germany	DE	Libya	LY	Oman	OM	South Africa	ZA
Colombia	CO	Great Britain	GB	Luxembourg	LU	Pakistan	PK	South Korea	KR
Congo	CG	Greece	GR	Malaysia	MY	Panama	PA	Spain	ES
								Sri Lanka	LK
								Sweden	SE
								Switzerland	CH
								Taiwan	TW
								Thailand	TH
								Turkey	TR
								Uganda	UG
								Ukraine	UA
								United States	US
								Uruguay	UY
								Uzbekistan	UZ
								Vietnam	VN
								Zimbabwe	ZW

Troubleshooting

PROBLEM	CAUSE	CORRECTION
No Power	The power cord is disconnected.	Plug the power cord into the wall outlet securely.
No Picture	The TV is not set to receive the DVD signal.	Select the appropriate video input mode on the TV so the picture from the unit appears on the TV screen.
	The video cables are not connected securely.	Connect the video cables securely to both the TV and unit.
A DVD/CD will not play.	No disc is inserted.	Insert a disc.
	An unplayable disc is inserted.	Insert a playable disc (check the disc type, colour system and regional code).
	The disc is inserted upside down.	Place the disc the side you can see the printed side.
	The setup menu is open on screen.	Press SETUP to close the menu screen.
	There is a parental lock which prevents the playback of DVDs with a certain rating.	Enter your password or change the rating level.
Humming noise heard while a DVD or CD is playing.	The disc is dirty.	Clean the disc using a soft cloth with outward strokes.
	The unit is located too close to the TV, causing feedback.	Move the unit and audio components further away from your TV.
Radio stations can't be tuned in properly.	The antenna is positioned poorly.	Attach an external aerial if necessary.
	The signal strength of the radio station is too weak.	Tune to the station manually.
	No stations have been preset or preset stations have been cleared (when tuning by scanning preset channels).	Preset some radio stations.
The remote control doesn't work well / at all	The remote is not pointed directly at the unit.	Point the remote directly at the unit.
	The remote is too far from the unit.	Use the remote within 23 feet (7m) of the unit.
	There is an obstacle in the path between the remote control and the unit.	Remove the obstacle.
	The batteries in the remote control is flat.	Replace the batteries with new one.

Types of Playable Discs

Type	LOGO
DVD-VIDEO : Discs such as movies that can be purchased or rented.	
DVD-R : Video mode and finalized only	
DVD-RW : Video mode and finalized only DVD VR format that have been finalized can not be played in this unit.	
DVD+R : Video mode only Supports the double layer disc also	
DVD+RW : Video mode only	
Audio CD : Music CDs or CD-R/ CD-RW in music CD format that can be purchased.	

This unit plays DVD±R/ RW and CD-R/ RW that contains audio titles, DivX, MP3, WMA and JPEG files. Some DVD±RW/ DVD±R or CD-RW/ CD-R cannot be played on this unit due to the recording quality or physical condition of the disc, or the characteristics of the recording device and authoring software.

“Dolby” and the double-D symbol are trademarks of Dolby Laboratories. Manufactured under license from Dolby Laboratories.

About the “⊗” Symbol Display

“⊗” may appear on your TV display during operation and indicates that the function explained in this owner’s manual is not available on that specific DVD video disc.

Regional Codes

This unit has a regional code printed on the rear of the unit. This unit can play only DVD discs labeled same as the rear of the unit or “ALL”.

- Most DVD discs have a globe with one or more numbers in it clearly visible on the cover. This number must match your unit’s regional code or the disc cannot play.
- If you try to play a DVD with a different regional code from your player, the message “Check Regional Code” appears on the TV screen.

Copyrights

It is forbidden by law to copy, broadcast, show, broadcast via cable, play in public, or rent copyrighted material without permission. This product features the copy protection function developed by Macrovision. Copy protection signals are recorded on some discs. When recording and playing the pictures of these discs picture noise will appear. This product incorporates copyright protection technology that is protected by U.S. patents and other intellectual property rights. Use of this copyright protection technology must be authorized by Macrovision, and is intended for home and other limited viewing uses only unless otherwise authorized by Macrovision. Reverse engineering or disassembly is prohibited.

CONSUMERS SHOULD NOTE THAT NOT ALL HIGH DEFINITION TELEVISION SETS ARE FULLY COMPATIBLE WITH THIS PRODUCT AND MAY CAUSE ARTIFACTS TO BE DISPLAYED IN THE PICTURE. IN CASE OF 525 OR 625 PROGRESSIVE SCAN PICTURE PROBLEMS, IT IS RECOMMENDED THAT THE USER SWITCH THE CONNECTION TO THE ‘STANDARD DEFINITION’ OUTPUT. IF THERE ARE QUESTIONS REGARDING OUR TV SET COMPATIBILITY WITH THIS MODEL 525p AND 625p UNIT, PLEASE CONTACT OUR CUSTOMER SERVICE CENTER.

You have to set the disc format option to [Mastered] in order to make the discs compatible with the LG players when formatting rewritable discs. When setting the option to Live File System, you cannot use it on LG players.
(Mastered/ Live File System : Disc format system for Windows Vista)

Specifications

General

Power supply	Refer to main label
Power consumption	Refer to main label
Net Weight	1.68 kg
External dimensions (WxHxD)	150 x 205 x 212 mm
Bus power supply (USB)	DC 5 V $\overline{---}$ 500 mA
Operating temperature	5 °C - 35 °C
Operating humidity	5% - 85%
Output power	5 W + 5 W
T.H.D	0.5 %

Tuner

FM Tuning Range	87.5 - 108.0 MHz or 87.50 - 108.00 MHz
AM Tuning Range(Optional)	522-1620kHz or 520-1710kHz

DVD/CD

Frequency response	100 Hz - 18 kHz
Signal-to-noise ratio	60 dB
Dynamic range	55 dB

Speaker (XBS14V)

Type	1 Way 1 Speaker
Impedance	6 Ω
Rated Input Power	5 W
Max. Input Power	10 W
Net Dimensions (WxHxD)	130 x 205 x 156 mm
Net Weight (1EA)	0.9 kg

Designs and specifications are subject to change without prior notice.