





CAUTION: TO REDUCE THE RISK OF ELECTRIC SHOCK DO NOT REMOVE COVER (OR BACK) NO USER-SERVICEABLE PARTS INSIDE REFER SERVICING TO QUALIFIED SERVICE PERSONNEL.

 This lightning flash with arrowhead symbol within an equilateral triangle is intended to alert the user to the presence of uninsulated dangerous voltage within the product's enclosure that may be of sufficient magnitude to constitute a risk of electric shock to persons.

 The exclamation point within an equilateral triangle is intended to alert the user to the presence of important operating and maintenance (servicing) instructions in the literature accompanying the product.

WARNING: TO PREVENT FIRE OR ELECTRIC SHOCK HAZARD, DO NOT EXPOSE THIS PRODUCT TO RAIN OR MOISTURE.

WARNING: Do not install this equipment in a confined space such as a book case or similar unit.

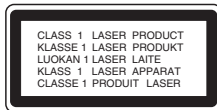

CAUTION:
This product employs a Laser System.
To ensure proper use of this product, please read this owner's manual carefully and retain it for future reference. Should the unit require maintenance, contact an authorized service center.
Use of controls, adjustments or the performance of procedures other than those specified herein may result in hazardous radiation exposure.
To prevent direct exposure to laser beam, do not try to open the enclosure. Visible laser radiation when open.
DO NOT STARE INTO BEAM.

Note:
The marking of product shall be on the exterior of the apparatus

CAUTION: The apparatus should not be exposed to water (dripping or splashing) and no objects filled with liquids, such as vases, should be placed on the apparatus.

CAUTION concerning the Power Cord

Most appliances recommend they be placed upon a dedicated circuit;
That is, a single outlet circuit which powers only that appliance and has no additional outlets or branch circuits. Check the specification page of this owner's manual to be certain.

Do not overload wall outlets. Overloaded wall outlets, loose or damaged wall outlets, extension cords, frayed power cords, or damaged or cracked wire insulation are dangerous. Any of these conditions could result in electric shock or fire. Periodically examine the cord of your appliance, and if its appearance indicates damage or deterioration, unplug it, discontinue use of the appliance, and have the cord replaced with an exact replacement part by an authorized servicer.

Protect the power cord from physical or mechanical abuse, such as being twisted, kinked, pinched, closed in a door, or walked upon. Pay particular attention to plugs, wall outlets, and the point where the cord exits the appliance.

To disconnect power from the mains, pull out the mains cord plug. When installing the product, ensure that the plug is easily accessible.

This device is equipped with a portable battery or accumulator.

Safe way to remove the battery or the battery from the equipment:

Remove the old battery or battery pack, follow the steps in reverse order than the assembly. To prevent contamination of the environment and bring on possible threat to human and animal health, the old battery or the battery put it in the appropriate container at designated collection points. Do not dispose of batteries or battery together with other waste. It is recommended that you use local, free reimbursement systems batteries and accumulators.

The battery shall not be exposed to excessive heat such as sunshine, fire or the like.



Disposal of your old appliance

1. When this crossed-out wheeled bin symbol is attached to a product it means the product is covered by the European Directive 2002/96/EC.
2. All electrical and electronic products should be disposed of separately from the municipal waste stream via designated collection facilities appointed by the government or the local authorities.
3. The correct disposal of your old appliance will help prevent potential negative consequences for the environment and human health.
4. For more detailed information about disposal of your old appliance, please contact your city office, waste disposal service or the shop where you purchased the product.

ENGLISH

QUICK SETUP GUIDE

Speaker System Connection

Connect the speaker wires to the speaker terminals. To obtain the best possible surround sound, adjust the speaker parameters (volume, distance, etc.).

Notes:

- Be sure to match the speaker wires to the appropriate terminal on the components, + to + and - to -. If the cables are reversed, the sound will be distorted and will lack bass.
- If you use front speakers with low maximum input rating, adjust the volume carefully to avoid excessive output on the speakers.

Be careful of the following

Be careful to make sure children not to put their hands or any objects into the *speaker duct.
*Speaker duct: A hall for plentiful bass sound on speaker cabinet(enclosure).

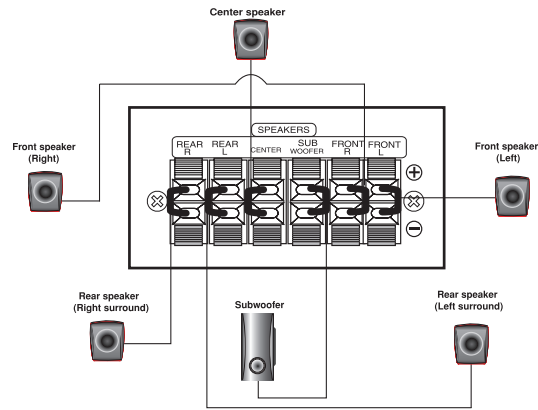

5.1 Speaker Setup

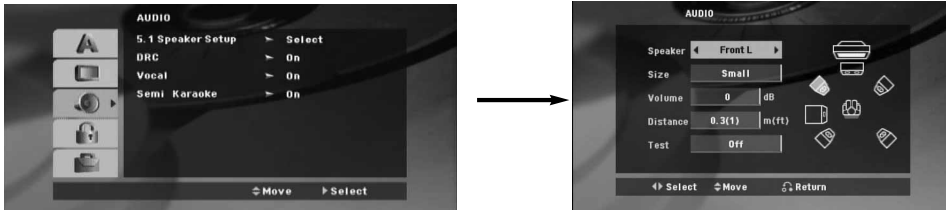

Make the following settings for the built-in 5.1 channel surround decoder.

1. Press ENTER and 5.1 Speaker Setup menu appears.
2. Use ◀ / ▶ to select the desired speaker.
3. Adjust options using ▲ / ▼ / ◀ / ▶ buttons.
4. After setting, returns to the previous menu by pressing RETURN button.

Speaker selection

Select a speaker that you want to adjust. [Front speaker (Front L), Front speaker (Front R), Center Speaker (Center), Subwoofer (SubWoofer), Rear speaker (Rear L), Rear speaker (Rear R)]

Note:

Certain speaker settings are prohibited by the Dolby Digital licensing agreement.

Size

Since the speaker settings are fixed, you cannot change the settings.

Volume

Press ◀ / ▶ to adjust the output level of the selected speaker. (-6dB ~ 6dB)

Distance

If you connected speakers to your DVD/CD Receiver, setting the Distance lets the speakers know how far the sound has to travel to reach your set listening point. This allows the sound from each speaker to reach the listener at the same time.

Press ◀ / ▶ to adjust the Distance of the selected speaker.

Test

Press ◀ / ▶ to test the signals of each speaker. Adjust the volume to match the volume of test signals memorized in the system.

Front Left (L) → Center → Front Right (R) → Rear Right (R) → Rear Left (L) → SubWoofer

Introduction

Installation

Before Use	.3
TV Connection	.4
Antenna Connection	.4
Speaker System Connection	.4
Optional Equipment Connection	.4

Operation

Operate using the Front Panel	.5
Operate using the Remote Control	.5-7

Setup

Initial Settings	.7
General Operation	.7
Language	.7
Display	.7
Audio	.7-8
Lock (Parental Control)	.8
Others	.8
Presetting the Radio Stations	.9

Playing an Audio CD or MP3/WMA/JPEG/DivX file

Playing an Audio CD or MP3/WMA file	.9
Programmed playback	.9
Viewing a JPEG file	.9-10
Playing a DivX Movie file	.10
Additional features	.10

Reference

Language Codes	.11
Area Codes	.11
Troubleshooting	.12
Specifications	.13







Before Use

About the Symbol Display

" " may appear on your TV display during operation and indicates that the function explained in this owner's manual is not available on that specific DVD video disc.

Symbol Used in this Manual

A section whose title has one of the following symbols is applicable only to the disc represented by the symbol.

-  DVD and finalized DVD±R/RW
-  Audio CDs  MP3 files
-  WMA files  JPEG files  DivX files

Types of Playable Discs

In addition, this unit can play a DVD-RW, DVD+RW, CD-G and CD-R or CD-RW that contains audio titles, MP3, WMA, JPEG or DivX files.

Notes:

- Depending on the conditions of the recording equipment or the CD-R/RW (or DVD-RW, DVD+RW) disc itself, some CD-R/RW (or DVD-RW, DVD+RW) discs may not be played on the unit.
- For DVD-R/RW Discs, only ones rewritten in video mode and finalized are supported on this player.
- When there are a lot of data in a disc, it may take longer to be read on this player than on other model.
- Do not attach any seal or label to either side (the labeled side or the recorded side) of a disc.
- Do not use irregularly shaped CDs (e.g., heart-shaped or octagonal). It may result in malfunctions.

Regional Code

This unit has a regional code printed on the rear of the unit. This unit can play only DVD discs labelled as the same as the rear of the unit or "ALL".

Notes on Regional Codes

If you try to play a DVD with a different regional code from your player, the message "Check Regional Code" appears on the TV screen.

ENGLISH

"Dolby", "Pro Logic", and the double-D symbol are trademarks of Dolby Laboratories.

Manufactured under license from Dolby Laboratories. Please ensure that the proper above notice is included in the owner's manual.

Manufactured under license under U.S. Patent #'s: 5,451,942; 5,956,674; 5,974,380; 5,978,762; 6,487,535 & other U.S. and worldwide patents issued & pending. DTS and DTS Digital Surround are registered trademarks and the DTS logos and Symbol are trademarks of DTS, Inc. © 1996-2007 DTS, Inc. All Rights Reserved.

The making of unauthorized copies of copy-protected material, including computer programs, files, broadcasts and sound recordings, may be an infringement of copyrights and constitute a criminal offence. This equipment should not be used for such purposes.

Be responsible respect copyrights

Installation



Do not touch the inner pins of the jacks on the rear panel. Electrostatic discharge may cause permanent damage to the unit.

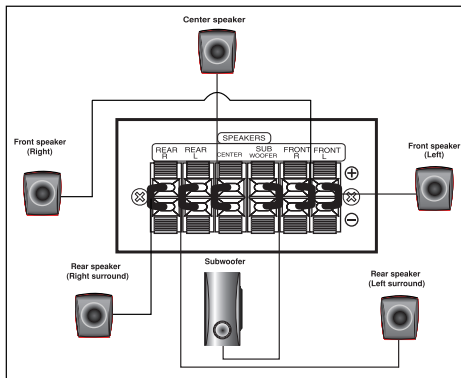

Be careful of the following

Be careful to make sure children not to put their hands or any objects into the *speaker duct.

*Speaker duct: A hall for plentiful bass sound on speaker cabinet(enclosure).

TV Connection

Make one of the following connections, depending on the capabilities of your existing equipment.

Tips:

- Depending on your TV and other equipment you wish to connect, there are various ways you could connect the DVD/CD Receiver. Use one of the connections described below.
- Please refer to the manuals of your TV, VCR, Stereo System or other devices as necessary to make the best connections.

Caution:

- Make sure the DVD/CD Receiver is connected directly to the TV. Select the correct AV input on your TV.
- Do not connect your DVD/CD Receiver to the TV via your VCR. The DVD image could be distorted by the copy protection system.

SCART connection

Connect the EURO AV OUTPUT (TO TV) socket on the DVD/CD Receiver to the corresponding jacks on the TV using the scart cable (T).

Component Video connection

Connect the COMPONENT VIDEO OUT jacks from the DVD/CD Receiver to the corresponding jacks on the TV using a Y PB PR cable (C).

- If your television is a high-definition or "digital ready" television, you may take advantage of the DVD/CD Receiver's progressive scan output for higher video resolution.
- If your TV does not accept your resolution setting, abnormal picture appears on the screen. Please read owner's manual for TV then set the resolution that your TV can accept.

4

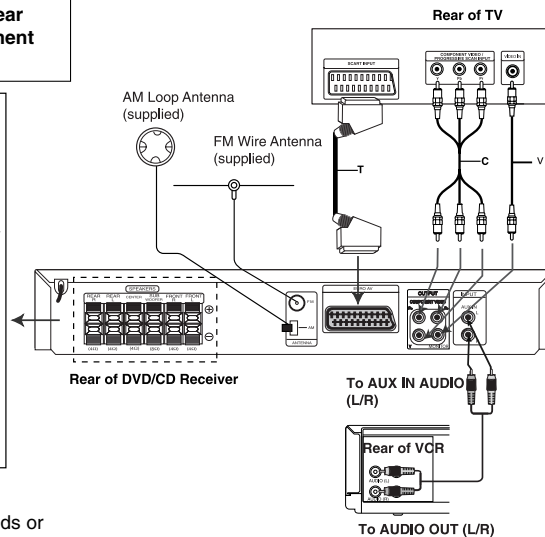

Composit Video connection

Connect the MONITOR jack from the DVD/CD Receiver to the Video IN jack on the TV using the video cable supplied (V).

Antenna Connection

Connect the supplied FM/AM antenna for listening to the radio.

- Connect the AM Loop aerial to the AM aerial connector.
- Connect the FM Wire aerial to the FM aerial connector.

Notes:

- To prevent noise pickup, keep the AM Loop aerial away from the DVD/CD Receiver and other components.
- Be sure to fully extend the FM wire aerial.
- After connecting the FM Wire aerial, keep it as horizontal as possible.

Speaker System Connection

Connect the speaker wires the speaker terminals.

To obtain the best possible surround sound, adjust the speaker parameters (volume, distance, etc.).

Notes:

- Be sure to match the speaker wires to the appropriate terminal on the components, + to + and - to -. If the cables are reversed, the sound will be distorted and will lack bass.
- If you use front speakers with low maximum input rating, adjust the volume carefully to avoid excessive output on the speakers.

Optional Equipment Connection

Connect a VCR to the AUX IN connectors.

Operation

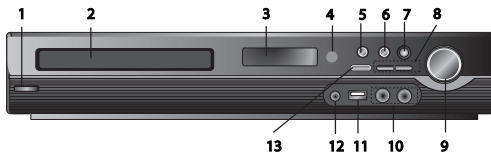

Operate using the Front Panel

1. **(POWER) POWER button**
Lights red when the receiver is in Standby mode (off)
2. **DISC Tray**
3. **DISPLAY Window**
4. **Remote Sensor: Remote Control Operation Range**
Distance: About 23 ft (7 m) from the front of the Remote Sensor
Angle: About 30° in each direction in front of the Remote Sensor
5. **OPEN/CLOSE** Opens and closes the disc tray.
6. **(PLAY/PAUSE) PLAY/PAUSE**
 - **FUNC.(-)** Press and hold down this button about 3 seconds, then press repeatedly to select other function. (DVD/CD → USB → AUX → TV -AUDIO → PORTABLE → FM → AM)
7. **VSM** Press VSM to set the VIRTUAL sound.
- **3D STEREO** Realtime 3D positioned sound rendering technology with stereo sources, optimized for stereo speakers. Listeners may experience amazing virtual surround effects with their own multimedia players.
- **Multichannel sound** The Multichannel sound changes the sound in 5.1 ch into a virtual one in the 10.1 ch so that it provides such a feeling that you listen to the sound simultaneously from the right and left speakers and center speaker.
8. **TUNING(-/+)/SKIP/SCAN(◀◀/▶▶)**
For manual tuning, press TUNING (-/+) repeatedly.
For automatic tuning, press and hold TUNING (-/+) for about two seconds on the front panel.
9. **VOLUME controller** Adjusts speaker volume.
10. **MIC 1/MIC 2** Connect a microphone to MIC 1 or MIC 2 or to both sockets.(ø6.3mm)

- If you connect a MIC into the unit during play the DTS source , sound output will be decrease.
- MIC function support in DVD/CD or USB mode.
- MIC connecting state, sound is outputted to all channel speakers.

-When you play a DivX file, voice of Microphone is not inputted.

11. USB Port Connect the USB port of a USB Memory (or MP3 player, etc.) to the USB port on the front of the unit.

Removing the USB Device from the unit

1. Choose a different function mode or press STOP (■) twice in a row.
2. Remove the USB device from the unit.

- Don't extract the USB device while operating.
- Music files (MP3/WMA), image files (JPEG) and Video files can be played.
- This unit cannot use a USB HUB.
- Recommended Memory Cards.
Compact Flash Card (CFC), Micro Drive (MD), Smart Media Card (SMC), Memory Stick (MS), Secure Digital Card (SD), Multimedia Card (MMC), Memory Stick Pro (MS-Pro)
- Compatible with: FAT16, FAT32
- Only use the memory cards recommended.
- Devices which require additional program installation when you have connected the unit to a computer are not supported.
- In case of a USB HDD, make sure to connect an auxiliary power cord to the USB HDD for proper operation. Up to 2 primary partitions of a drive are supported. If there is an extension partition, up to four partitions are supported.
- If the drive of USB device is two or more, a drive folder is displayed on the screen. If you want to move to the initial menu after you select a folder, press RETURN.
- Digital cameras and mobile phones are not supported.
- Only USB 1.0/ 1.1 supported. (In case USB 2.0 is inserted in to the player, it operates at the same speed as that of USB 1.1.)

ENGLISH

12. PORT. IN Jack Using PORTABLE device

When you connect a portable music playing device to the PORT. IN jack on this device by using a (ø3.5mm) mini stereo cable (not supplied), you can here the sound being outputted from the portable device through the speaker.

13. STOP

Operate using the Remote Control

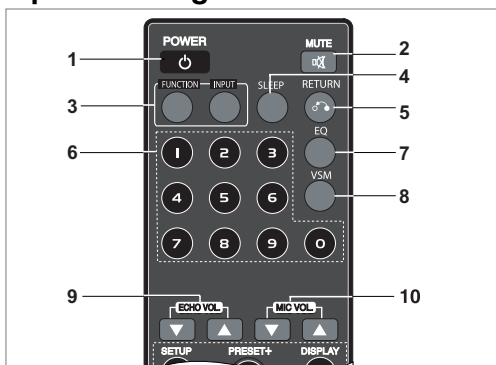

1. **POWER**
2. **MUTE** Press MUTE to mute your unit. You can mute your unit in order, for example, to answer the telephone.
3. **FUNCTION : (DVD/CD → FM → AM)**
 - **INPUT : (USB → AUX → TV -AUDIO → PORTABLE)**
4. **SLEEP** You can set the DVD/CD Receiver to turn off automatically at a specified time.
 1. Press SLEEP to set the desired sleep time. The sleep time appears in the display window.
 2. Each time you press SLEEP the setting changes in the following order.
(DIMMER ON) → SLEEP 180 → 150 → 120 → 90 → 80 → 70 → 60 → 50 → 40 → 30 → 20 → 10 → (DIMMER OFF)

Note: You can check the remaining time before the DVD/CD Receiver turns off.
Press SLEEP. The remaining time appears in the display window.
5. **RETURN** Removes the setup menu.
6. **0-9 numerical buttons** Selects a service, program number directly or selects numbered options in a menu.

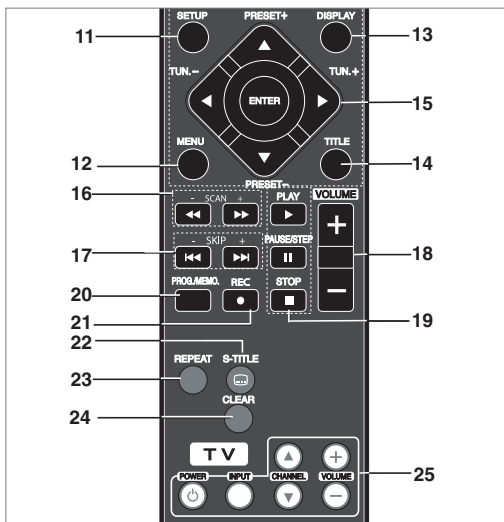

7. EQ (EQUALIZER Effect)

You can choose 7 fixed sound impressions. Each time you press the button the setting changes in the display window as shown below.

- **AUTO EQ** : AUTO EQ operates only in the MP3 files which include the Tag information in the DVD or USB function. (ID3 Tag is operated.ver.1 only.)
- WMA file operates to Normal EQ regardless of Tag information.
- NORMAL → NATURAL →(AUTO EQ) → POP → CLASSIC → ROCK → JAZZ → NORMAL..

8. VSM Press **VSM** to set the VIRTUAL sound. You can enjoy surround sound simply by selecting one of the pre-programmed sound fields according to the program you want to listen to. Press **VSM** button repeatedly.

- **2 Ch Source** : BYPASS →VIRTUAL → ON STAGE →PLII MOVIE → PLII MUSIC → PLII MTRX → BYPASS...
- **5.1Ch Source**: BYPASS →VIRTUAL → BYPASS

9. ECHO VOL.(▼ / ▲) Adjusts echo volume
10.MIC VOL.(▼ / ▲) Adjusts microphone volume
 - When you connect MIC the sound will be output into all channel

11. SETUP Accesses or removes setup menu

12. MENU Accesses the menu on a DVD disc.

13. DISPLAY
 1. Press DISPLAY to show various information about the disc loaded on-screen. The displayed items differ depending on the disc type or playing status.
 2. You can select an item by pressing ▲ / ▼ and change or select the setting by pressing ◀ / ▶.

14. TITLE If the current DVD title has a menu, the title menu appears on the screen. Otherwise, the disc menu may appear.

- Title (Track) –Current title (or track) number/total number of titles (or tracks).
- Chapter –Current chapter number/ total number of chapters.
- Time – Elapsed playing time.
- Audio – Selected audio language or channel.
- Subtitle – Selected subtitle.
- Angle – Selected angle/ total number of angles.
- Sound – Selected sound mode.

Note: If a button is not pressed for a few seconds, the on-screen display disappears.

15. ◀/▶/▲/▼ (left/right/up/down) Selects an option in the menu.

ENTER Acknowledges the menu selection.
PRESET(▲/▼) Press PRESET +/- repeatedly to select the preset station you want.

Each time you press the button, the DVD/CD Receiver tunes in one preset station at a time.

Preset radio stations in the DVD/CD Receiver's memory first (see "Presetting radio stations")

TUN.(-/+) (◀/▶) For manual tuning, press TUN (-/+) repeatedly.

For automatic tuning, press and hold TUN. (-/+) for about two seconds on the front panel.

16. SCAN(◀◀/▶▶) During playback, press **SCAN** (◀◀ or ▶▶) repeatedly to select the required scan speed.

DVD, DivX : ◀◀, ◀◀◀, ◀◀◀◀, ◀◀◀◀◀, or ▶▶, ▶▶▶, ▶▶▶▶

WMA/MP3, Audio CD : ◀◀(X2, X4, X8) or ▶▶(X2, X4, X8)

• **SLOW**(◀◀/▶▶) In the pause mode, press **SLOW** (◀◀ or ▶▶) to select required speed.

DVD : ◀ (1/2, 1/4, 1/8, 1/16) or ▶ (1/2, 1/4, 1/8, 1/16)
 DivX : ▶ (1/2, 1/4, 1/8, 1/16)

17. ● SKIP (◀◀ / ▶▶) During playback, press **SKIP** (◀◀ or ▶▶) to go to the next chapter/track or to return to the beginning of the current chapter/track. Press **SKIP** ◀◀ twice briefly to step back to the previous chapter/track.

18. VOLUME (+/-) Adjusts speaker volume.

19. ● PLAY(▶) - To Play disc and file
 - **1.5 speed playback** **DVD MP3 WMA AC3**

You can quickly enjoy a movie and music. The 1.5 speed allows you to watch the pictures and listen to the sound quicker than playing at a normal speed on the disc.

1. Press the PLAY button during the normal playback. The screen will appear at 1.5 speed with sound.
2. To return to normal PLAY, press PLAY
 - If you insert MIC to unit during 1.5 speed playback, it will be return to normal speed or when a MIC is connected into the unit 1.5 speed playback not operate.

- **FM mode state, selects MONO or STEREO by pressing on the remote control PLAY button**

• **PAUSE/STEP** (||) During playback, press || to pause playback. **ALL**
 Press || repeatedly to play Frame-by-Frame.
DVD DivX

• **STOP** (■)
20. PROG./MEMO. Accesses or removes Program menu. Enter a radio station's frequency into the tuner.

21. REC (●) - **USB direct recording**
This function enable you to record music to a connected USB storage device from AUDIO CD .

Before USB recordings, read the notes on the page 13.

1. Insert a USB device sufficient free space to the USB port on the unit.
2. Select DVD/CD to record from by pressing FUNCTION button on the remote control.
 AUDIO CD - Press ▲ / ▼ to select the track/file you want
3. Press REC (●) on the remote control to start record.
 "USB REC" will start flashing on the display.
 - When you start the USB recording, Recording percentage rate will be appear on the display window during the recording.
4. File will be stored to CD_REC in a format "TRK_001.mp3"
5. To stop the recording press STOP.

Record AUDIO CD source to USB

One track recording : If the usb recording is played during playback of the cd, the only track would be recording into the USB.

All track recording: If the USB Rec. button is pressed at the CD stop, all track would be recording.

Program list recording: USB Records after selectig the tracks pressing the PROG./MEMO. button if you want to record the tracks you want.

22. SUBTITLE **DVD DivX**

During playback ,S-TITLE repeatedly to select a desired subtitle language .

23. REPEAT

During playback, press REPEAT repeatedly to select a desired repeat mode.

DVD Video discs: Chapter/Title/Off

Audio CD, DivX/MP3/WMA discs: Track/All/Off

24. CLEAR

Removes a track number on the program menu.

25. TV - Controlling the TV

Your remote control is capable of operating your DVD/CD Receiver as well as limited functions of LG TV.

Follow the instructions below to operate your LG TV.

Setting Remote Control Codes for LG TV

1. Hold **POWER (TV)** and press **CHANNEL(▲/▼)** button repeatedly until the TV on or off.
2. The **POWER (TV), CHANNEL(▲/▼), VOLUME (+/-),** and **INPUT** buttons on remote control are used to operate the LG TV.

Note: If the remote control does not operate your particular TV, try the other code or use the remote control originally supplied with the LG TV. (LG and Gold Star)Due to the variety of codes used by manufacturers, OUR COMPANY cannot guarantee that the remote control will operate every LG TV model.

Setup

Initial Settings

By using the Setup menu, you can make various adjustments to items such as picture and sound. You can also set a language for the subtitles and the Setup menu, among other things. For details on each Setup menu item, see the pages 8 to 9.



1 LANGUAGE - Menu Language/ Disc Audio / Subtitle / Menu

2 DISPLAY - TV Aspect / Display Mode / Progressive Scan / TV output select

3 AUDIO - 5.1 Speaker Setup/ Dynamic Range Control (DRC)/ Vocal / Semi Karaoke

4 LOCK (Parental Control) - Rating / Password / Area Code

5 OTHERS - PBC / DivX(R) VOD / REC Bitrate

To display and exit the Menu: Press SETUP to display the menu. A second press of SETUP will take you back to initial screen.

To go to the next level: Press ► on the Remote Control.

To go back to the previous level: Press ◀ on the Remote Control.

GENERAL OPERATION

1. Press SETUP. The Setup menu appears.

2. Use ▲ / ▼ to select the desired option then press ► to move to the second level. The screen shows the current setting for the selected item, as well as alternate setting(s).

3. Use ▲ / ▼ to select the second desired option and then press ► to move to the third level.

4. Use ▲ / ▼ to select the desired setting then press ENTER to confirm your selection. Some items require additional steps.

5. Press SETUP or PLAY to exit the Setup menu.

LANGUAGE

Menu Language: Select a language for the Setup menu and the on-screen display.

Disc Audio / Subtitle / Menu:

Select the language you prefer for the audio track (disc audio), subtitles, and the disc menu.

Original – Refers to the original language in which the disc was recorded.

Other – To select another language, press numeric buttons and then ENTER to enter the corresponding 4-digit number according to the language code list on the page 11. If you enter the wrong language code, press CLEAR.

DISPLAY

TV Aspect

4:3 – Select when a standard 4:3 TV is connected.

16:9 – Select when a 16:9 wide TV is connected.

Display Mode: The display Mode setting works only when the TV Aspect mode is set to "4:3".

Letterbox – Displays a wide picture with bands on the upper and lower portions of the screen.

Panscan – Automatically displays the wide picture on the entire screen and cuts off the portions that do not fit.

Progressive Scan

Progressive Scan Video provides the high quality pictures with less flickering. If you are using the Component Video jacks for connection to a TV or monitor that is compatible with a progressive scan signal, set [Progressive Scan] to [On]. Press ENTER.

- If you not press ENTER within 10 seconds it will be [OFF].

- If you have no progressive scan TV ,in the state progressive scan [on] will not appear the screen.

(so then,press and hold STOP button on the remote control 5seconds. it will be change [OFF].)

TV Output Select – Select an option according to the TV connection type. [YPbPr]: When your TV is connected with the COMPONENT/PROGRESSIVE SCAN jacks on the unit. [RGB]: When your TV is connected with the SCART jack.

- When connected by RGB, COMPONENT OUT not operate.

- In Progressive scan [on] state, TV Output select mode is inactivate.

AUDIO

Each DVD disc has a variety of audio output options. Set the receiver's AUDIO options according to the type of audio system you use.

5.1 Speaker Setup

Make the following settings for the built-in 5.1 channel surround decoder.

1. Press ENTER and 5.1 Speaker Setup menu appears.

2. Use ◀ / ▶ to select the desired speaker.

3. Adjust options using ▲ / ▼ / ◀ / ▶ buttons.
4. After setting, returns to the previous menu by pressing RETURN button.

Speaker selection

Select a speaker that you want to adjust. [Front speaker (Front L), Front speaker (Front R), Center Speaker (Center), Subwoofer (SubWoofer), Rear speaker (Rear L), Rear speaker (Rear R)]

Note: Certain speaker settings are prohibited by the Dolby Digital licensing agreement.

Size: Since the speaker settings are fixed, you cannot change the settings.

Volume: Press ◀ / ▶ to adjust the output level of the selected speaker. (-6dB ~ 6dB)

Distance: If you connected speakers to your DVD/CD Receiver, setting the Distance lets the speakers know how far the sound has to travel to reach your set listening point. This allows the sound from each speaker to reach the listener at the same time. Press ◀ / ▶ to adjust the Distance of the selected speaker.

Test : Press ◀ / ▶ to test the signals of each speaker. Adjust the volume to match the volume of test signals memorized in the system.

Front Left (L) → Center → Front Right (R) → Rear Right (R)
→ Rear Left (L) → SubWoofer

DRC (Dynamic Range Control)

Make the sound clear when the volume is turned down (Dolby Digital only). Set to [On] for this effect.

Vocal

Set Vocal to [On] only when a multi-channel karaoke DVD is playing. The karaoke channels on the disc will mix into normal stereo sound.

Semi Karaoke

When a chapter/ title / track is fully finished, this function shows the score in the screen with a fanfare sound.

Semi Karaoke on :

- Turn the "Semi Karaoke" function on.
- When you finished singing a score will appear on the screen.

Semi Karaoke off :

- Turn the "Semi Karaoke" function off.
- Fanfare and score do not appears on the screen

Available discs for the Semi Karaoke function:

- DVD discs
- DVD Karaoke discs

Note:

- This function operate on the DVD/CD mode.
- The Semi Karaoke function is available only when a microphone is connected.
- When you watching movies, "off" the Semi Karaoke at the SETUP menu and enjoy it without connecting the MIC if the fanfare or score appears during changing a chapter.
- In case the chapter length of disc, is not longer than 1 minute, scoring does not appear on the display window.

LOCK (Parental Control)

Rating: Blocks playback of rated DVDs based on their contents. Not all discs are rated.

1. Select "Rating" on the LOCK menu then press ▶.
2. To access the LOCK options, you must input the password you have created. If you have not yet entered password, you are prompted to do so.

Input a password and press ENTER. Enter it again and press ENTER to verify. If you make a mistake before pressing ENTER, press CLEAR.

3. Select a rating from 1 to 8 using the ▲ / ▼ buttons.

Rating 1-8: Rating one (1) has the most restrictions and rating eight (8) is the least restrictive.

Unlock: If you select unlock, parental control is not active and the disc plays in full.

4. Press ENTER to confirm your rating selection, then press SETUP to exit the menu.

Password: You can enter or change password.

1. Select Password on the LOCK menu and then press ▶.
2. Follow the step 2 as shown above (Rating).

To change the password, press ENTER when the "Change" option is highlighted. Input a password and press ENTER. Enter it again and press ENTER to verify.

3. Press SETUP to exit the menu.

If you forget your password

If you forget your password, you can clear it using the following steps:

1. Press SETUP to display the Setup menu.
2. Input the 6-digit number "210499" and press ENTER. The password is cleared.

Area Code

Enter the code of the area whose standards were used to rate the DVD video disc, based on the list on page 11.

1. Select "Area Code" on the LOCK menu then press ▶.
2. Follow step 2 as shown in rating section.
3. Select the first character using ▲ / ▼ buttons.
4. Press ▶ and select the second character using ▲ / ▼ buttons.
5. Press ENTER to confirm your Area code selection.

OTHERS

PBC (Playback Control) – Playback control provides special navigation features that are available on some disc. Select [On] to use this feature.

DivX(R) VOD Registration

We provide you the DivX® VOD (Video On Demand) registration code that allows you to rent and purchase videos based on the DivX® VOD service. For more information, visit www.divx.com/vod.

1. Select "DivX(R) VOD" option and then press ▶.
2. Press ENTER while "Select" is selected and the registration code will appear.
Use the registration code to purchase or rent the videos from DivX® VOD service at www.divx.com/vod. Follow the instructions and download the video onto a disc for playback on this unit.
3. Press ENTER to exit.

Note: All the downloaded videos from DivX® VOD can only be played back on this unit.

REC Bitrate : Set USB record Bitrate to 96kbps or 128kbps (see page 7)

Presetting the Radio Stations

You can preset 50 stations for FM and AM (MW). Before tuning, make sure that you have turned down the volume.

1. Press **FUNCTION** on the Remote Control until FM or AM (MW) appears in the display window.
2. And then every time you press **FUNCTION**, FM and AM (MW) changes alternately.
3. Press and hold TUN.(-/+) for about two seconds until the frequency indication starts to change, then release. Scanning stops when the DVD/CD Receiver tunes in a station.
4. Press PROG./MEMO. on the Remote Control. A preset number will flash in the display window.
5. Press PRESET +/- on the Remote Control to select the preset number you want.
6. Press PROG./MEMO. on the Remote Control again. The station is stored.

7. Repeat steps 3 to 6 to store other stations.

To tune in a station with a weak signal

Press TUN.(-/+) repeatedly in step 3 to tune in the station manually.

To clear all the stored stations

Press and hold PROG./MEMO. for about two seconds and "ERASE ALL" appears in the display window and then press PROG./MEMO. again, the stations are cleared.

- If you have accidentally entered into the "ERASE ALL" mode and you do not wish to clear the memory, do not press any key. After a few seconds, the "ERASE ALL" will go off by itself and change to normal mode.

Note: If all stations have already been entered, the FULL message will appear in the display window for a moment and then a preset number will flash. To change the preset number, follow steps 5-6 as above.

Playing an Audio CD or MP3/WMA/JPEG/ DivX file

Playing an Audio CD or MP3/WMA file

This unit can play Audio CDs or MP3/WMA files.

MP3/ WMA/ Audio CD

Once you insert a cd with MP3/WMA files or Audio, a menu appears on the TV screen.

Press ▲ / ▼ to select a track/file and then press PLAY or ENTER, and playback starts. You can use variable playback functions. Refer to the page 5,6 or 7.

ID3 TAG

When playing a file containing information such as track titles, you can see the information by pressing DISPLAY.

[Song, Title, Artist, Album, Year, Comment]

-ID3 Tag will be operate in the MP3 file.

Tips:

- Press MENU to move to the next page.
- On a CD with MP3/WMA and JPEG, you can switch MP3/WMA and JPEG. Press TITLE, and MUSIC or PHOTO top of the menu is highlighted.
- AUTO EQ is set for WMA/ MP3 file in the DVD/CD,USB function.

Programmed Playback

The program function enables you to store your favorite tracks from any disc in the receiver memory. A program can contain 30 tracks.

1. Insert a disc. Audio CD and MP3/WMA Discs:
2. Select a track on the "List", and then press PROG./MEMO. " " icon appears on the display window and then press ENTER to place the selected track on the "Program" list. Repeat to place additional tracks on the list.
3. Select the track you want to start playing on the "Program" list. Press MENU to move to the next page.
4. Press PLAY or ENTER to start. Playback begins in the order in which you programmed the tracks. Playback stops after all of the tracks on the "Program" list have played once.
5. To resume normal playback from programmed playback, select a track of AUDIO CD (or MP3/WMA) list and then press PLAY.

Repeat Programmed Tracks

1. Press REPEAT when playing a disc. The repeat icon appears.

2. Press REPEAT to select a desired repeat mode.

- TRACK: repeats the current track.
- ALL: repeats all the tracks on programmed list.
- Off(No display): does not play repeatedly.

Erasing a Track from "Program" List

1. Use ▲ ▼ to select the track that you wish to erase from the Program list.
2. Press CLEAR. Repeat to erase additional tracks on the list.

Erasing the Complete Program List

Press PROG./MEMO. and then, " " icon will appear.

Use ▲ / ▼ to select " Clear All" icon and then press ENTER.

Note:

- The programs are also cleared when the disc is removed.
- During playback,AUTO skip is not supported.

Viewing a JPEG file

This unit can play discs with JPEG files.

Before playing JPEG recordings, read the notes on JPEG Recordings page 13.

1. Insert a disc and close the tray. The PHOTO menu appears on the TV screen.
2. Press ▲ / ▼ to select a folder, and then press ENTER. A list of files in the folder appears. If you are in a file list and want to return to the previous Folder list, use the ▲ / ▼ buttons on the Remote to highlight [] and press ENTER.
3. If you want to view a particular file, press ▲ / ▼ to highlight a file and press ENTER or PLAY. While viewing a file, you can press STOP to move to the previous menu (JPEG menu).

Tip:

There are three Slide Speed options [] : > (Slow), >> (Normal), >>> (Fast). Use ▲ /▼ /◀ /▶ to highlight the Speed. Then, use ◀ / ▶ to select the option you want to use and then press ENTER.

Slide Show : Use ▲ ▼ ◀ ▶ to highlight the [] (Slide Show) then press ENTER.

Still Picture :

1. Press PAUSE/STEP during the slide show. The DVD/CD Receiver will now go into the PAUSE mode.
2. To return to the slide show, press PLAY or press PAUSE/STEP again.

Listening to the music during slide show :

You can listen to music during slide show, if the disc contain music and photo files together. Use ▲/▼/◀/▶ to highlight  icon then press ENTER to start slide show.

- You can not adjust sound mode and VIRTUAL sound [VSM]during the Music PHOTO ALBUM playing.

Moving to another File

Press SKIP (◀◀ or ▶▶) once during viewing a picture to advance to the next or previous file.

Rotating the picture

Press ▲/▼ during showing a picture to rotate the picture clockwise or counter-clockwise.

Playing a DivX Movie file

You can play DivX file in USB device and DivX disc. in the DVD/CD Receiver

1. Insert a disc and close the tray. The MOVIE menu appears on the TV screen.
2. Press ▲ / ▼ to select a folder and then press ENTER. A list of files in the folder appears. If you are in a file list and want to return to the Folder list, use the ▲ / ▼ buttons on the remote to highlight  and press ENTER.
3. If you want to view a particular file, press ▲ / ▼ to highlight a file and press ENTER or PLAY.
4. Press STOP to exit.

Tips:

- Press MENU to move to the next page.
- On a CD with MP3/WMA, JPEG and MOVIE file, you can switch MUSIC, PHOTO and MOVIE menu. Press TITLE and MUSIC, PHOTO and MOVIE word on top of the menu is highlighted.

Notes:

- Be sure to select "SUBTITLE ON" mode by pressing the subtitle file every time before playing a DivX file .
- When the subtitle has more than two languages in the file, original subtitle is only available.
- You can not adjust sound mode and VIRTUAL sound [VSM]during the DivX file playing.

Notice for displaying the Divx subtitle

If the subtitle does not display properly during playback, press and hold S-TITLE for about 3 seconds then press S-TITLE to select another language code until the subtitle is displayed properly

Additional features

Time Search

To start playing at any chosen time on the disc:

1. Press DISPLAY during playback.
2. Press ▲ / ▼ to select the time clock icon and "--:--:--" appears.
3. Input the required start time in hours, minutes, and seconds from left to right. If you enter the wrong numbers, press CLEAR to remove the numbers you entered. Then input the correct numbers.
4. Press ENTER to confirm. Playback starts from the selected time.

Screen Saver The screen saver appears when you leave the unit in Stop mode for about five minutes.

Last Scene Memory

This receiver memorizes the last scene from the last disc that is viewed. The last scene remains in the memory even if you remove the disc from the receiver or switch off the receiver.

If you load a disc that has the scene memorized, the scene is automatically recalled.

Note: This receiver does not memorize the scene of a disc if you switch off the receiver before commencing to play the disc.

System Select

You must select an appropriate system mode for your TV system. If NO DISC appears in the display window, press and hold PAUSE/STEP on the remote control for more than 5 seconds to be able to select a system (PAL, NTSC or AUTO).

- When the selected system is not compatible with the system of your TV, normal colour picture may not be displayed.

NTSC: Select when DVD/CD Receiver is connected with NTSC-TV.

PAL: Select when DVD/CD Receiver is connected with PAL-TV.

AUTO: Select when DVD/CD Receiver is connected with Multi system TV.

Reference

Language Codes

Use this list to input your desired language for the following initial settings: Disc Audio, Disc Subtitle, Disc Menu.

Language	Code	Language	Code	Language	Code	Language	Code
Abkhazian	6566	Fiji	7074	Lingala	7678	Singhalese	8373
Afar	6565	Finnish	7073	Lithuanian	7684	Slovak	8375
Afrikaans	6570	French	7082	Macedonian	7775	Slovenian	8376
Albanian	8381	Frisian	7089	Malagasy	7771	Somali	8379
Ameharic	6577	Galician	7176	Malay	7783	Spanish	6983
Arabic	6582	Georgian	7565	Malayalam	7776	Sudanese	8385
Armenian	7289	German	6869	Maltese	7784	Swahili	8387
Assamese	6583	Greek	6976	Maori	7773	Swedish	8386
Aymara	6588	Greenlandic	7576	Marathi	7782	Tagalog	8476
Azerbaijani	6590	Guarani	7178	Moldavian	7779	Tajik	8471
Bashkir	6665	Gujarati	7185	Mongolian	7778	Tamil	8465
Basque	6985	Hausa	7265	Nauru	7865	Tatar	8484
Bengali; Bangla	6678	Hebrew	7387	Nepali	7869	Telugu	8469
Bhutani	6890	Hindi	7273	Norwegian	7879	Thai	8472
Bihari	6672	Hungarian	7285	Oriya	7982	Tibetan	6679
Breton	6682	Icelandic	7383	Panjabi	8065	Tigrinya	8473
Bulgarian	6671	Indonesian	7378	Pashto, Pushto	8083	Tonga	8479
Burmese	7789	Interlingua	7365	Persian	7065	Turkish	8482
Byelorussian	6669	Irish	7165	Polish	8076	Turkmen	8475
Cambodian	7577	Italian	7384	Portuguese	8084	Twi	8487
Catalan	6765	Japanese	7465	Quechua	8185	Ukrainian	8575
Chinese	9072	Javanese	7487	Rhaeto-Romance	8277	Urdu	8582
Corsican	6779	Kannada	7578	Rumanian	8279	Uzbek	8590
Croatian	7282	Kashmiri	7583	Russian	8285	Vietnamese	8673
Czech	6783	Kazakh	7575	Samoan	8377	Volapük	8679
Danish	6865	Kirghiz	7589	Sanskrit	8365	Welsh	6789
Dutch	7876	Korean	7579	Scots Gaelic	7168	Wolof	8779
English	6978	Kurdish	7585	Serbian	8382	Xhosa	8872
Esperanto	6979	Laothian	7679	Serbo-Croatian	8372	Yiddish	7473
Estonian	6984	Latin	7665	Shona	8378	Yoruba	8979
Faroese	7079	Latvian, Lettish	7686	Sindhi	8368	Zulu	9085

Area Codes

Choose a area code from this list.

Area	Code	Area	Code	Area	Code	Area	Code
Afghanistan	AF	Ethiopia	ET	Malaysia	MY	Saudi Arabia	SA
Argentina	AR	Fiji	FJ	Maldives	MV	Senegal	SN
Australia	AU	Finland	FI	Mexico	MX	Singapore	SG
Austria	AT	France	FR	Monaco	MC	Slovak Republic	SK
Belgium	BE	Germany	DE	Mongolia	MN	Slovenia	SI
Bhutan	BT	Great Britain	GB	Morocco	MA	South Africa	ZA
Bolivia	BO	Greece	GR	Nepal	NP	South Korea	KR
Brazil	BR	Greenland	GL	Netherlands	NL	Spain	ES
Cambodia	KH	Heard and McDonald Islands	HM	Netherlands Antilles	AN	Sri Lanka	LK
Canada	CA	Hong Kong	HK	New Zealand	NZ	Sweden	SE
Chile	CL	Hungary	HU	Nigeria	NG	Switzerland	CH
China	CN	India	IN	Norway	NO	Taiwan	TW
Colombia	CO	Indonesia	ID	Oman	OM	Thailand	TH
Congo	CG	Israel	IL	Pakistan	PK	Turkey	TR
Costa Rica	CR	Italy	IT	Panama	PA	Uganda	UG
Croatia	HR	Jamaica	JM	Paraguay	PY	Ukraine	UA
Czech Republic	CZ	Japan	JP	Philippines	PH	United States	US
Denmark	DK	Kenya	KE	Poland	PL	Uruguay	UY
Ecuador	EC	Kuwait	KW	Portugal	PT	Uzbekistan	UZ
Egypt	EG	Libya	LY	Romania	RO	Vietnam	VN
El Salvador	SV	Luxembourg	LU	Russian Federation	RU	Zimbabwe	ZW

Troubleshooting

Check the following guide for the possible cause of a problem before contacting service.

Symptom	Cause	Correction
No power.	<ul style="list-style-type: none"> The power cord is disconnected. 	<ul style="list-style-type: none"> Plug the power cord securely into the wall outlet.
The power is on, but the DVD/CD Receiver does not work.	<ul style="list-style-type: none"> No disc is inserted. 	<ul style="list-style-type: none"> Insert a disc. (Check that the DVD or audio CD indicator in the DVD display is lit.)
No picture.	<ul style="list-style-type: none"> The TV is not set to receive DVD signal output. 	<ul style="list-style-type: none"> Select the appropriate video input mode on the TV so the picture from the DVD/CD Receiver appears on the TV screen.
	<ul style="list-style-type: none"> The video cable is not connected securely. 	<ul style="list-style-type: none"> Connect the video cable into the jacks securely.
	<ul style="list-style-type: none"> The connected TV power is turned off. 	<ul style="list-style-type: none"> Turn on the TV.
There is no sound or only a very low-level sound is heard.	<ul style="list-style-type: none"> The equipment connected with the audio cable is not set to receive DVD signal output. 	<ul style="list-style-type: none"> Select the correct input mode of the audio receiver so you can hear the sound from the DVD/CD Receiver.
	<ul style="list-style-type: none"> The audio cables are not connected securely. 	<ul style="list-style-type: none"> Connect the audio cable into the jacks securely.
	<ul style="list-style-type: none"> The power of the equipment connected with the audio cable is turned off. 	<ul style="list-style-type: none"> Turn on the equipment connected with the audio cable.
	<ul style="list-style-type: none"> The audio connecting cable is damaged. 	<ul style="list-style-type: none"> Replace it with new one.
The playback picture is poor.	<ul style="list-style-type: none"> The disc is dirty. 	<ul style="list-style-type: none"> Clean the disc.
The DVD/CD Receiver does not start playback.	<ul style="list-style-type: none"> No disc is inserted. 	<ul style="list-style-type: none"> Insert a disc. (Check that the DVD, or audio CD indicator in the DVD display is lit.)
	<ul style="list-style-type: none"> An unplayable disc is inserted. 	<ul style="list-style-type: none"> Insert a playable disc. (Check the disc type, colour system and Regional code.)
	<ul style="list-style-type: none"> The disc is placed upside down. 	<ul style="list-style-type: none"> Place the disc with the playback side down.
	<ul style="list-style-type: none"> The disc is not placed within the guide. 	<ul style="list-style-type: none"> Place the disc on the disc tray correctly inside the guide.
	<ul style="list-style-type: none"> The disc is dirty. 	<ul style="list-style-type: none"> Clean the disc.
	<ul style="list-style-type: none"> A menu is on the TV screen. 	<ul style="list-style-type: none"> Press the SETUP button to turn off the menu screen.
	<ul style="list-style-type: none"> The Rating level is set. 	<ul style="list-style-type: none"> Cancel the Rating function or change the rating level.
Loud hum or noise is heard.	<ul style="list-style-type: none"> The disc is dirty. 	<ul style="list-style-type: none"> Clean the disc.
	<ul style="list-style-type: none"> The speakers and components are connected poorly. 	<ul style="list-style-type: none"> Connect the speakers and components securely.
	<ul style="list-style-type: none"> The DVD/CD Receiver is located too close to the TV. 	<ul style="list-style-type: none"> Move your TV away from the audio components.
Radio stations cannot be tuned in.	<ul style="list-style-type: none"> The antenna is positioned or connected poorly. 	<ul style="list-style-type: none"> Connect the antenna securely. Adjust the antennas and connect an external antenna if necessary.
	<ul style="list-style-type: none"> The signal strength of the stations is too weak (when tuning in with automatic tuning). 	<ul style="list-style-type: none"> Tune in the station manually.
	<ul style="list-style-type: none"> No stations have been preset or preset stations have been cleared (when tuning by scanning preset stations). 	<ul style="list-style-type: none"> Preset the stations (page 9).
The remote control does not work properly.	<ul style="list-style-type: none"> The remote control is not pointed at the remote sensor of the DVD/CD Receiver. 	<ul style="list-style-type: none"> Point the remote control at the remote sensor of the DVD/CD Receiver.
	<ul style="list-style-type: none"> The remote control is too far from the DVD/CD Receiver. 	<ul style="list-style-type: none"> Use the remote control within about 23 ft (7 m).
	<ul style="list-style-type: none"> There is an obstacle in the path of the remote control and the DVD/CD Receiver. 	<ul style="list-style-type: none"> Remove the obstacle.
	<ul style="list-style-type: none"> The batteries in the remote control are flat. 	<ul style="list-style-type: none"> Replace the batteries with new ones.
The front panel display is too dim.	<ul style="list-style-type: none"> Nothing is displayed on the front panel display. 	<ul style="list-style-type: none"> Press SLEEP(Dimmer) on the remote control.

MP3 / WMA disc compatibility with this player is limited as follows:

- Sampling frequency: within 8 - 48 kHz (MP3), within 22.05 - 48kHz (WMA)
- Bit rate: within 8 - 320kbps (MP3), 32 - 256kbps (WMA)
- Support Ver : v2 , v7, v8, v9
- File extensions: ".mp3" / ".wma"
- CD-ROM file format: ISO9660
- We recommend that you use Easy-CD Creator, which creates an ISO 9660 file system.
- The total number of characters for file name: maximum 8 characters (excluding file extensions like mp3/wma)
- They should not contain special letters such as / ? * : " < > | etc.
- The total number of files on the disc should be less than 650.
- This player can not support files with such as extension s as bmp,zip.
- In case of spec.out file will be skip to the next file automatically,while playing of file in order.

Customers should note that permission is required in order to download MP3 / WMA files and music from the Internet. Our company has no right to grant such permission. Permission should always be sought from the copyright owner.

JPEG disc compatibility with this player is limited as follows:

- Normal JPEG - Max pixel in width : 8902 pixel
- Progressive JPEG - Max pixel in width : 1609 pixel
- Maximum files : Under 650.
- Some discs may not operate due to a different recording format or the condition of disc.
- File extensions: ".jpg"

DivX disc compatibility with this player is limited as follows:

- Available resolution: within 720x576 (W x H) pixels
- The file name of the DivX subtitle is available by 45 characters.
- If there is impossible code to express in the DivX file, it may be displayed as " _ " mark on the display.
- **Frame rate : less than 30 fps**
- **If the video and audio structure of recorded files is not interleaved, either video or audio is outputted.**

- **Playable DivX file:** ".avi ", ".mpg ", ".mpeg ", ".divx"
- **Playable Subtitle format:** SubRip(*.srt/*.txt), SAMI(*.smi), SubStation Alpha(*.ssa/*.txt), MicroDVD(*.sub/*.txt), SubViewer 2.0(*.sub/*.txt), VobSub(*.sub)
- **Playable Codec format:** DIVX3.xx ", "DIVX4.xx ", "DIVX5.xx ", "MP43 ", "3IVX "
- **Playable Audio format:** "AC3 ", "DTS ", "PCM ", "MP3 ", "WMA "
- Sampling frequency: within 32 - 48 kHz (MP3), within 24 - 48kHz (WMA)
- Bit rate: within 32 - 320kbps (MP3), 40 - 192kbps (WMA)
- Max bitrate : USB: 4Mbps , CD: 4Mbps, DVD: 7Mbps
- For Discs formatted in Live file system ,you can not it on this player.
- If the name of movie file is different from that of the subtitle file,during playback of a DivX file, subtitle may not be display.
- If you play a DivX file differ from DivXspec ,it may not operate normally.
- When you play a DivX file,voice of Microphone is not inputted.

USB Recording with this player is limited as follow notes:

Note:

- When you stop recording during playback ,the file that has been recorded at that time will be stored.
- External HDD, Multi Card reader ,Locked device and MP3 player is not supported.
- If you record more 648 files on CD_REC folder appears "ERROR" on the display.
- In the state SACD,CD-G ,DTS disc USB Record is not operated.
- During USB recording, is no sound of music and some keys except for POWER, STOP and SLEEP key not operate.
- When you extract the device or power off while recording, stored MP3 file can not playback or not may be formed a file.
- USB recording time can be difference according to the writing speed of device
- During the record ,can not change any function and volume.
- When you press the Rec button on the remote control in all function appointed sound mode return to BYPASS.
- USB port of the unit can not be connected to PC. The unit can not be used as a storage device.
- USB record is available to within 20hz~ 16khz.

Specifications

General

Power supply	Refer to the back panel of the unit.
Power consumption	Refer to the back panel of the unit.
Net Weight	2.5 kg
External dimensions (WxHxD)	360 x 62 x 305 mm
Operating conditions	Temperature: 5°C to 35°C, Operation status: Horizontal
Operating humidity	5% to 85%

Amplifier

Output Power	Front: 45 W + 45 W (Rated Output Power 30 W, THD 10 %)
	Centre*: 45 W
	Surround*: 45 W + 45 W (Rated Output Power 30 W, 4 Ω at 1 kHz, THD 10 %)
	Subwoofer*: 75 W (Rated Output Power 60 W, 8 Ω at 30 Hz, THD 10 %)

Speakers

	SH33SU-S	SH33SU-W
Impedance	4 Ω	8 Ω
Net Dimensions (WxHxD)	99 x 114 x 86 mm	156 x 325 x 320 mm
Net Weight (1EA)	0.5 kg	3.5 kg

Designs and specifications are subject to change without notice.



	Web site	Telephone
Россия	ru.lgservice.com	8-800-200-7676
Україна	ua.lgservice.com	8-800-303-0000
Қазақстан	kz.lgservice.com	8-8000-805-805
Беларус	ru.lgservice.com	8-820-0071-1111
Latvija	lv.lgservice.com	8-0003-271
Lietuva	lt.lgservice.com	8-800-30-800
Eesti	ee.lgservice.com	800-9990