

OWNER'S MANUAL

AIR CONDITIONER

Please read this manual carefully before operating your set and retain it for future reference.

TYPE : WALL MOUNTED

MODELS

VA123HL NB0

VA123HL UB0

TABLE OF CONTENTS

A. Safety Precautions	3
B. Electrical Safety	6
Temporary Use of an Adapter	6
Temporary Use of an Extension Cord	6
Symbols used in this Manual	6
C. Product Introduction	7
Indoor Units	7
Operation Indication Lamps	7
Outdoor Unit	7
D. Operating Instructions	8
How to insert the Batteries	8
Wireless Remote Controller Maintenance	8
Operating Method	8
Wireless Remote Controller	9
Operation Mode	11
Auto Changeover Operation (Optional)	12
Auto Operation (Optional)	12
Healthy Dehumidification Operation	12
Air Circulation Operation	13
Auto Clean Operation	13
NEO PLASMA Purification Operation (Optional)	13
Energy-Saving Cooling Mode (Optional)	14
Display Luminosity (Optional)	14
Setting the Current Time	14
Timer Setting	15
To cancel the timer setting	15
Sleep Mode	15
Horizontal Vane Control	16
Vertical Louver Control (Optional)	16
Jet Cool Operation	16
Moisture Cooling Operation (Optional)	17
Eco Eye Operation (Optional)	18
Forced operation	20
Auto Restart Function	21
E. Maintenance and Service	22
Indoor Unit	22
Outdoor Unit	23
Operation Tips!	23
Self-Diagnosis Function	23
Troubleshooting Tips! Save time and money!	24
Call the service immediately in the following situations	24



FOR YOUR RECORDS

Write the model and serial numbers here:

Model # _____

Serial # _____

You can find them on a label on the side of each unit.

Dealer's Name _____

Date Purchased _____

■ Staple your receipt to this page in the event you need it to prove date of purchase or for warranty issues.



READ THIS MANUAL

Inside you will find many helpful hints on how to use and maintain your air conditioner properly. Just a little preventive care on your part can save you a great deal of time and money over the life of your air conditioner.

You'll find many answers to common problems in the chart of troubleshooting tips. If you review our chart of

Troubleshooting Tips first, you may not need to call for service at all.



PRECAUTION

- **Contact the authorized service technician for repair or maintenance of this unit.**
- **Contact the installer for installation of this unit.**
- **The air conditioner is not intended for use by young children or invalids without supervision.**
- **Young children should be supervised to ensure that they do not play with the air conditioner.**
- **When the power cord is to be replaced, replacement work shall be performed by authorized personnel only using only genuine replacement parts.**



Safety Precautions



To prevent injury to the user or other people and property damage, the following instructions must be followed.

- Incorrect operation due to ignoring instruction will cause harm or damage. The seriousness is classified by the following indications.

⚠ WARNING This symbol indicates the possibility of death or serious injury.

⚠ CAUTION This symbol indicates the possibility of injury or damage.

- Meanings of symbols used in this manual are as shown below.

	Be sure not to do.
	Be sure to follow the instruction.

⚠ WARNING

Always use a power plug and socket with a ground terminal.

- There is a risk of electric shock.

For electrical work, contact the dealer, seller, a qualified electrician, or an Authorized Service Center. Do not disassemble or repair the product by yourself.

- There is risk of fire or electric shock.

Use the correctly rated breaker or fuse.

- There is risk of fire or electric shock.

Do not install the product on a defective installation stand. Be sure that the installation area does not deteriorate with age.

- It may cause product to fall.

In outdoor unit the step-up capacitor supplies high voltage electricity to the electrical components. Be sure to discharge the capacitor completely before conducting the repair work.

- An charged capacitor can cause electrical shock.

Do not use a defective or underrated circuit breaker. Use the correctly rated breaker and fuse.

- There is risk of fire or electric shock .

Always ground the product as per the wiring diagram. Do not connect the ground wire to gas or water pipes lightning rod or telephone ground wire.

- There is risk of fire or electric shock.

Do not modify or extend the power cable. If the power cable or cord has scratches or skin peeled off or deteriorated then it must be replaced.

- There is risk of fire or electric shock.

Never install the outdoor unit on a moving base or a place from where it can fall down.

- The falling outdoor unit can cause damage or injury or even death of a person.

When installing the unit, use the installation kit provided with the product.

- Otherwise the unit may fall and cause severe injury.

Do not use a multi consent. Always use this appliance on a dedicated circuit breaker.

- Otherwise it can cause electric shock or fire.

Install the panel and the cover of control box securely.

- There is risk of fire or electric shock due to dust , water etc.

For installation, removal or reinstall , always contact the dealer or an Authorized Service Center.

- There is risk of fire, electric shock, explosion, or injury.

When the product is soaked (flooded or submerged) in water , contact an Authorized Service Center for repair before using it again.

- There is risk of fire or electric shock.

Be sure to use only those parts which are listed in the svc parts list. Never attempt to modify the equipment.

- The use of inappropriate parts can cause an electrical shock, excessive heat generation or fire.

Safety Precautions

Indoor/outdoor wiring connections must be secured tightly and the cable should be routed properly so that there is no force pulling the cable from the connection terminals.

- Improper or loose connections can cause heat generation or fire.

Be sure to check the refrigerant to be used. Please read the label on the product.

- Incorrect refrigerant used can prevent the normal operation of the unit.

Do not place a heater or other heating appliances near the power cable.

- There is risk of fire and electric shock.

Do not use the product in a tightly closed space for a long time. Perform ventilation regularly.

- Oxygen deficiency could occur and hence harm your health.

Ventilate the product room from time to time when operating it together with a stove, or heating element etc.

- Oxygen deficiency can occur and hence harm your health.

Take care to ensure that nobody especially kids could step on or fall onto the outdoor unit.

- This could result in personal injury and product damage.

Do not plug or unplug the power supply plug to turn the unit ON/OFF .

- There is risk of fire or electric shock.

Safely dispose off the packing materials. Like screws, nails, batteries, broken things etc after installation or svc and then tear away and throw away the plastic packaging bags.

- Children may play with them and cause injury.

Don't use a power cord, a plug or a loose socket which is damaged.

- Otherwise it may cause a fire or electrical shock.

Do not allow water to run into electric parts. Install the unit away from water sources.

- There is risk of fire, failure of the product, or electric shock.

Do not open the front grille of the product during operation. (Do not touch the electrostatic filter, if the unit is so equipped.)

- There is risk of physical injury, electric shock, or product failure.

Turn the main power off and unplug the unit when cleaning or repairing the product.

- There is risk of electric shock.

Take care to ensure that power cable could not be pulled out or damaged during operation.

- There is risk of fire or electric shock.

Make sure to check that the power cable plug is not dirty, loose or broken and then only insert the plug completely.

- Dirty, loose or broken power plug can cause electric shock or fire.

Do not touch , operate, or repair the product with wet hands. Hold the plug by hand when taking out

- There is risk of electric shock or fire.

Do not store or use or even allow flammable gas or combustibles near the product.

- There is risk of fire.

If strange sound, smell or smoke comes from product.Immediately turn the breaker off or disconnect the power supply cable.

- There is risk of electric shock or fire.

When the product is not to be used for a long time, disconnect the power supply plug or turn off the breaker.

- There is risk of product damage or failure, or unintended operation.

Do not place ANYTHING on the power cable.

- There is risk of fire or electric shock.

When flammable gas leaks, turn off the gas and open a window for ventilation before turning on the product.

- Do not use the telephone or turn switches on or off. There is risk of explosion or fire.

CAUTION

Two or more people must lift and transport the product.

- Avoid personal injury.

Keep level even when installing the product.

- To avoid vibration or noise.

Do not install the product where it will be exposed to sea wind (salt spray) directly.

- It may cause corrosion on the product.

Do not install the product where the noise or hot air from the outdoor unit could damage or disturb the neighborhoods.

- It may cause a problem for your neighbors and hence dispute.

Install the drain hose to ensure that the condensed water is drained away properly.

- A bad connection may cause water leakage.

Always check for gas (refrigerant) leakage after installation or repair of product.

- Low refrigerant levels may cause failure of product.

Do not use the product for special purposes, such as preserving foods, works of art, etc. It is a consumer air conditioner, not a precision refrigeration system.

- There is risk of damage or loss of property.

Do not block the inlet or outlet of air flow.

- It may cause product failure.

Use a soft cloth to clean. Do not use harsh detergents, solvents or splashing water etc .

- There is risk of fire, electric shock, or damage to the plastic parts of the product.

Do not touch the metal parts of the product when removing the air filter.

- There is risk of personal injury.

Do not step on or put anything on the product. (outdoor units)

- There is risk of personal injury and failure of product.

Always insert the filter securely after cleaning. Clean the filter every two weeks or more often if necessary.

- A dirty filter reduces the efficiency.

Do not insert hands or other objects through the air inlet or outlet while the product is operating.

- There are sharp and moving parts that could cause personal injury.

Be cautious when unpacking and installing the product.

- Sharp edges could cause injury.

If the refrigerant gas leaks during the repair, do not touch the leaking refrigerant gas.

- The refrigerant gas can cause frostbite (cold burn)

Do not tilt the unit when removing or uninstalling it.

- The condensed water inside can spill .

Do not mix air or gas other than the specified refrigerant used in the system .

- If air enters the refrigerant system, an excessively high pressure results, causing equipment damage or injury.

If the refrigerant gas leaks during the installation, ventilate the area immediately.

- Otherwise it can be harmful for your health.

Dismantling the unit, treatment of the refrigerant oil and eventual parts should be done in accordance with local and national standards.

Replace the all batteries in the remote control with new ones of the same type. Do not mix old and new batteries or different types of batteries.

- There is risk of fire or product failure.

Do not recharge or disassemble the batteries. Do not dispose off batteries in a fire.

- They may burn or explode.

If the liquid from the batteries gets onto your skin or clothes, wash it well with clean water. Do not use the remote if the batteries have leaked.

- The chemicals in batteries could cause burns or other health hazards.

If you eat the liquid from the batteries, brush your teeth and see doctor. Do not use the remote if the batteries have leaked.

- The chemicals in batteries could cause burns or other health hazards.

Do not let the air conditioner run for a long time when the humidity is very high and a door or a window is left open.

- Moisture may condense and wet or damage furniture.

Do not expose your skin or kids or plants to the cool or hot air draft.

- This could harm to your health.

Do not drink the water drained from the product.

- It is not sanitary and could cause serious health issues.

Use a firm stool or ladder when cleaning, maintaining or repairing the product at an height.

- Be careful and avoid personal injury.

Electrical Safety

⚠ WARNING

- This appliance must be properly grounded.
To minimize the risk of electric shock, you must always plug into a grounded outlet.
- Do not cut or remove the grounding prong from the power plug.
- Attaching the adapter ground terminal to the wall receptacle cover screw does not ground the appliance unless the cover screw is metal and not insulated, and the wall receptacle is grounded through the house wiring.
- If you have any doubt whether the air conditioner is properly grounded, have the wall receptacle and circuit checked by a qualified electrician.

Temporary Use of an Adapter

We strongly discourage the use of an adapter due to potential safety hazards. For temporary connections, use only a genuine adapter, available from most local hardware stores. Ensure that the large slot in the adapter is aligned with the large slot in the receptacle for a proper polarity connection.

To disconnect the power cord from the adapter, use one hand on each to avoid damaging the ground terminal. Avoid frequently unplugging the power cord as this can lead to eventual ground terminal damage.

⚠ WARNING

- Never use the appliance with a broken adapter.

Temporary Use of an Extension Cord

We strongly discourage the use of an extension cord due to potential safety hazards.

⚠ WARNING

This appliance should be installed in accordance with national wiring regulations. This manual acts as a guide to explaining product features.

Symbols used in this Manual



This symbol alerts you to the risk of electric shock.



This symbol alerts you to hazards that may cause harm to the air conditioner.

NOTE

This symbol indicates special notes.

Product Introduction

Here is a brief introduction of the indoor and outdoor units.

Indoor Units

Premium type

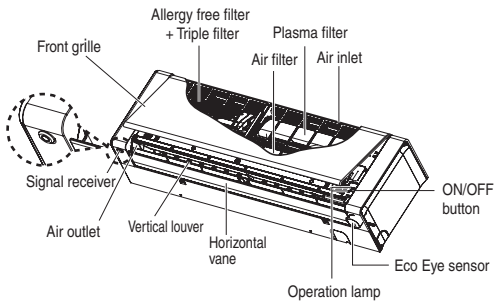

Rational type

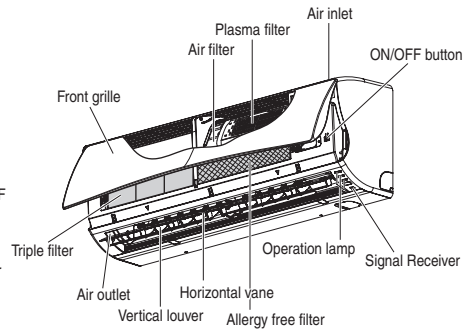

Operation Indication Lamps

- Cooling : 'Cooling' lamp lights up during Cooling Operation
- Heating : 'Heating' lamp lights up during Heating Operation
- Plasma : 'Plasma' lamp lights up during Plasma Purification Operation
- ※ During Air Circulation Operation, 'Cooling' lamp lights up.
- ※ While Plasma Purification operates with Air Circulation Operation, 'Cooling' lamp and 'Plasma' lamp lights up at the same time.
- ※ Premium type doesn't have 'Plasma' lamp.

Outdoor Unit

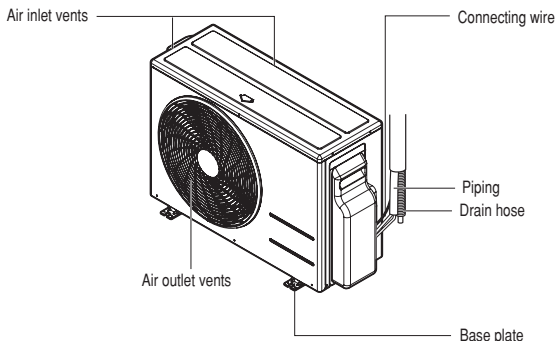

Operating Instructions

How to insert the Batteries

1. Remove the battery cover by pulling it according to the arrow direction.
2. Insert new batteries making sure that the (+) and (-) of battery are installed correctly.
3. Reattach the cover by sliding it back into position.

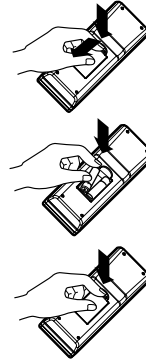

NOTE

1. Always use/replace both batteries of same type.
2. If the system is not to be used for a long time, remove the batteries to save their working life.
3. If the display screen of remote controller starts, fading replace both of the batteries.
4. Use 2 AAA(1.5 Vcc) batteries.

Wireless Remote Controller Maintenance

1. Choose a suitable place where its safe & easy to reach.
2. Fix the holder to wall etc with the supplied screws firmly.
3. Slide the remote controller inside the holder.

NOTE

1. Remote controller should never be exposed to direct sunlight.
2. Signal transmitter & receiver should always be clean for proper communication. Use a soft cloth to clean them.
3. In case some other appliances also get operated with remote control, change their position or consult your serviceman.

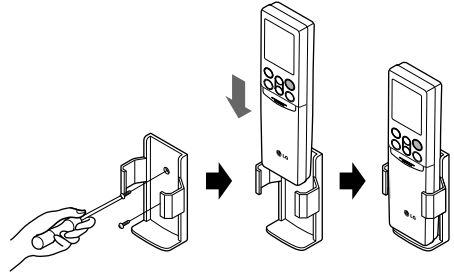

Operating Method

1. The signal receiver is inside the unit.
2. Aim the remote controller towards the unit to operate it. There should not be any blockage in between.

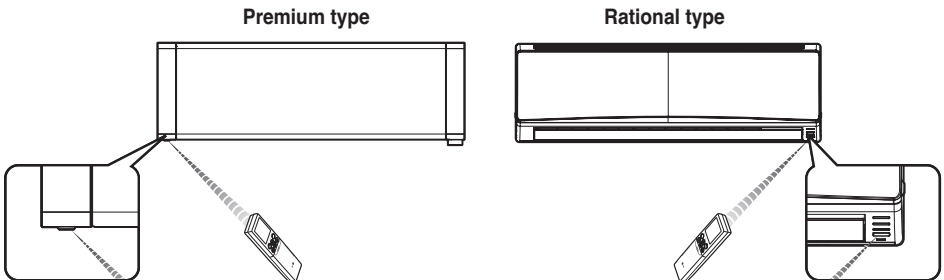





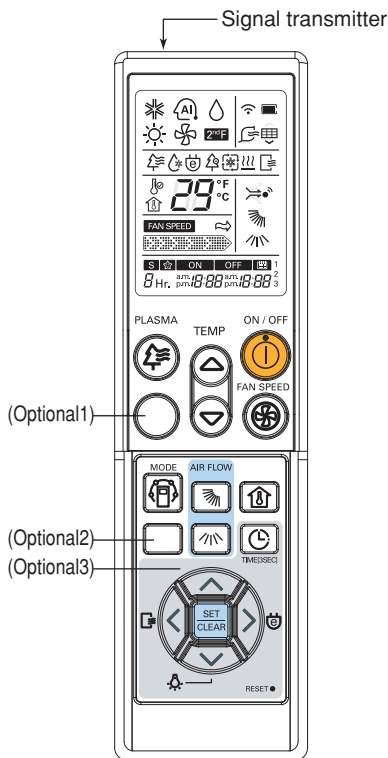



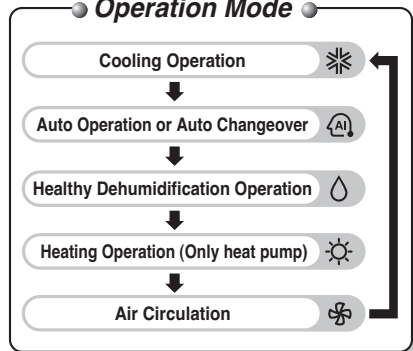







Wireless Remote Controller

The controls will look like the following.



Operation Mode



- 
ON/OFF BUTTON
 Used to turn off/on the unit.
- 
OPERATION MODE SELECTION BUTTON
 Used to select the operation mode.
- 
ROOM TEMPERATURE SETTING BUTTONS
 Used to select the room temperature.
- 
INDOOR FAN SPEED SELECTION BUTTON
 Used to select fan speed in six steps low, medium-low, medium, medium-high, high and natural wind.
- 
HORIZONTAL VANE CONTROL BUTTON
 Used to set the desired vertical airflow direction.
- 
VERTICAL LOUVER CONTROL BUTTON(Optional)
 Used to set the desired horizontal airflow direction.
- 
AUTO CLEAN BUTTON
 Used to set auto clean.
- 
ENERGY SAVING COOLING BUTTON
 Used to save Energy.
- 
ROOM TEMPERATURE CHECKING BUTTON
 Used to check the room temperature.
- 
TIMER BUTTON(before adjusting)
 Used to set the current time and the time of starting / stopping.
- 
TIME ADJUSTING BUTTONS
 Used to adjust the time.
- 
TIMER SET/CLEAR BUTTON(after adjusting)
 Used to set and to cancel the timer operation.
- 
RESET BUTTON
 Used prior to resetting time.
- 
PLASMA BUTTON(Optional)
 Used to start or stop the plasma-purification.
- 
LED LUMINOSITY BUTTON(Optional)
 Used to adjust LED luminosity.

The controls will look like the following.

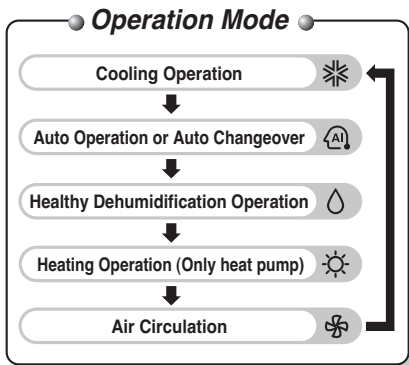
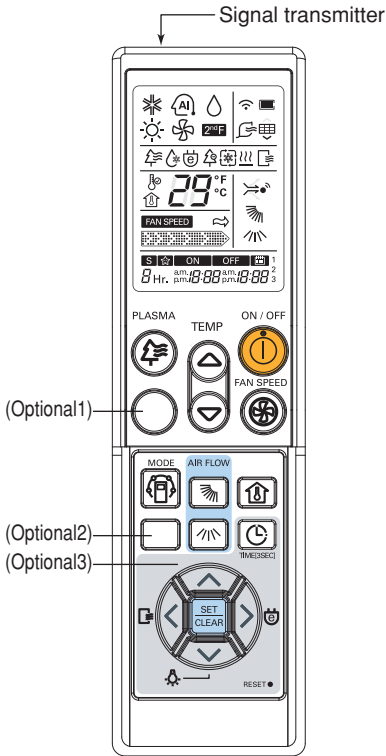

★ **Premium type :**

- Optional1



ECO EYE BUTTON

Used to set and to cancel the timer operation.

- Optional2



JET COOL / MOISTURE COOLING BUTTON

Used to start or stop the speed cooling and Moisture Cooling. The Jet Cool operates fan in super high speed in cooling mode.

- Optional3



SLEEP MODE AUTO BUTTON

Used to set sleep mode auto operation.

★ **Rational type :**

- Optional1



SLEEP MODE AUTO BUTTON

Used to set sleep mode auto operation.

- Optional2



JET COOL BUTTON

Used to start or stop the speed cooling. The Jet Cool operates fan in super high speed in cooling mode.

Operation Mode

- 1** Press the ON/OFF BUTTON to turn the unit on.
The unit will respond with a beep.



- 2** Open the cover of the remote controller and press the operation mode button. Each time the button is pressed, the operation mode is shifted in the direction of the arrow.

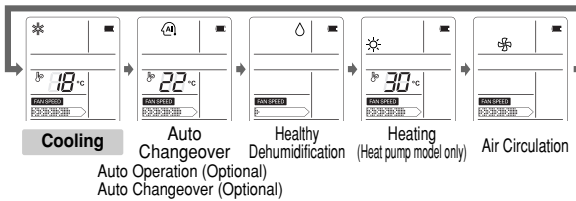

- 3** For cooling or heating operation set the desired indoor temperature by pressing the ROOM TEMPERATURE SETTING BUTTONS.
For cooling the temperature can be set within 18°C~30°C and for heating the temperature range is 16°C~30°C.



- 4** Set the fan speed with the remote controller. You can select the fan speed in six steps : low, medium-low, medium, medium-high, high and natural wind by pressing the INDOOR FAN SPEED SELECTION BUTTON.
Each time the button is pressed, the fan speed mode is shifted in the direction of the arrow.

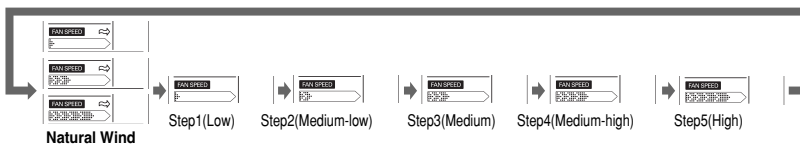

Natural wind

- For fresher feeling, press the INDOOR FAN SPEED SELECTION BUTTON and set to Natural wind mode.
In this mode, the wind blows like a natural breeze by automatically changing fan speed.

Auto Changeover Operation (Optional)

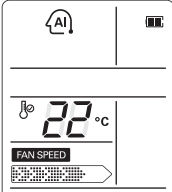

This operation is basically heating or cooling function of the air conditioner. But during this operation the controller changes the operation mode automatically to keep the temperature within $\pm 2^{\circ}\text{C}$ with respect to the setting temperature.



Auto Operation(Optional)

<For Cooling Model>

The temperature and fan speed are automatically set by the electronic controls based on the actual room temperature.

If you feel hot or cold, press TEMPERATURE SETTING buttons for more cooling or heating effect. You cannot switch the indoor fan speed. It has already been set by the Auto Operation Mode rule.

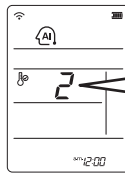

* Please select the code as per your requirement.

Code	Feel
2	Cold
1	Slightly cool
0	Neutral
-1	Slightly warm
-2	Warm

<For Heating Model>

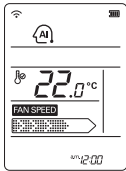

You can set desired temperature and indoor fan speed.
Setting Temp. Range : 18~30°C.

NOTE

: You can not set the actual setting temperature and the fan speed in this operation mode ,But you can use the Auto swing in this operation. If the system is not operating as desired,switch manually to another mode

Healthy Dehumidification Operation

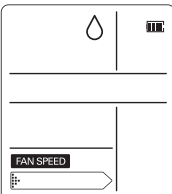

During Healthy Dehumidification Operation

- If you select the dehumidification mode on the OPERATION MODE SELECTION BUTTON, the product starts to run the dehumidification function. It automatically sets the room temperature and airflow volume to the best condition for dehumidification, based on the sensed current room temperature. In this case, however, the setting temperature is not displayed on the remote controller and you are not able to control the room temperature either.
- During the healthy dehumidification function, the fan speed is automatically set according to the optimization algorithm responding to the current room temperature status, so that the room condition is kept healthy and comfortable even in the very humid season.



Air Circulation Operation

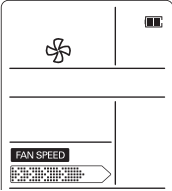

This operation circulates the air without cooling or heating. It can be activated by pressing the OPERATION MODE SELECTION BUTTON. Once the air circulation is activated you can select the fan speed by pressing the INDOOR FAN SPEED SELECTION BUTTON.



NOTE : During this operation, 'Cooling' lamp lights up.

Auto Clean Operation

- During Auto Clean Operation, moistures left in indoor units after cooling operation or healthy dehumidification operation can be removed.

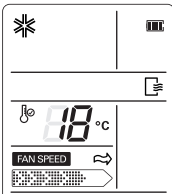

Select Auto Clean Operation by the function setting button (). Now whenever the unit is turned off, the indoor fan is still running for about 30 minutes internally without cooling or dehumidification operation. This function dries up any remains of moisture & cleans the unit internally. If you push the Auto Clean button again, this function is cancelled.



NOTE

- During Auto Clean function, only ON/OFF button, Plasma button, Auto Clean button is used. During this operation, 'Cooling' lamp lights up.

PLASMA Purification Operation(Optional)

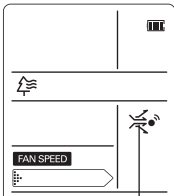

(Optional)

Plasma filter is a technology developed by LG to get rid of microscopic contaminants in the intake air by generating a plasma of high charge electrons. This plasma kills and destroys the contaminants completely to provide clean and hygienic air.

Plasma purification operation can be started by pressing the PLASMA BUTTON on the remote controller.
Repressing it will deactivate the operation.

PLASMA





NOTE

- This features can be used in any operation mode and fan speed by pressing the plasma button.
- Separate plasma purification operation is possible in stop condition. It is cancelled by pressing plasma button or on/off button.

Energy-Saving Cooling Mode (Optional)

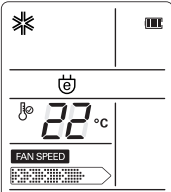
Energy-saving cooling mode can save energy in cooling operation, because it can operate efficiently by setting body-adaptation time according to the change of time and temperature and adjusting desired temperature automatically.



1. Press the ON/OFF BUTTON to start the unit.
2. Open the cover of the remote controller.
Select cooling operation. 
3. Press the ENERGY-SAVING COOLING MODE BUTTON.
4. To cancel the energy-saving cooling mode, press the ENERGY-SAVING COOLING MODE BUTTON again and unit will operate in previous mode(Cooling mode).

Display Luminosity (Optional)

The unit display Luminosity can be adjusted by using the remote controller.
Open the cover of the remote controller and press the LED LUMINOSITY button.
Display LED will be dark. Press the button again to set bright display.
(The order of 100% → 50% LUMINOSITY is repeated whenever you press the button.)



Setting the Current Time

- 1** Press the TIMER BUTTON For 3 seconds.

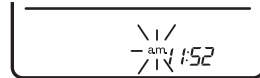

- 2** Press the TIMER SETTING BUTTONS until the desired time is set.
- The order of a.m. and p.m. -> hour ->minute is repeated whenever you press the <> button.
- By pressing the ^ v button, you can set the current time.









- 3** Press the SET/CLEAR button.



NOTE

Check the indicator for a.m. and p.m.

Timer Setting

Description	Button on the Remote Controller	Indication on the LCD Display
1 Press the Timer button once to set on the Reserved 'On' (Press the Timer button twice to set the Reserved 'Off')		
2 Press the Time Setting buttons until the desired time is set. - The order of a.m. and p.m. -> hour ->minute is repeated whenever you press the <> button. - By pressing the ^v^ button, you can set the desired time.		
3 Press the SET/CLEAR BUTTON (Press the SET/CLEAR BUTTON once more to cancel)		

To cancel the timer setting

- If you wish to cancel all timer setting, press the SET/CLEAR button.
- In order to cancel the timer settings individually, press the Timer button to select Reserved 'On' or Reserved 'Off'. And then press the Set/Clear button aiming the remote controller at the signal receiver. (the timer lamp on the display will go off)

Sleep Mode Operation

Press the SLEEP MODE AUTO BUTTON to set the time when you want the unit to stop automatically. The timer is programmed in one-hour increments by pressing the SLEEP MODE AUTO BUTTON 1 to 7 times. The sleep mode is available for 1 to 7 hours.



NOTE

- The sleep mode will operate indoor fan at super low speed in cooling mode and at low speed in heating mode for pleasant sleep.

In cooling mode or healthy dehumidification mode:

The setting temperature will rise automatically two times by 1°C over next consecutive 30 minutes (Maximum 2°C) for a comfortable sleep. This will be the final setting temperature as long as sleep mode is functioning.

Horizontal Vane Control

The Horizontal Vane can be adjusted by using the remote controller.

1. Press the ON/OFF BUTTON to start the unit.
2. Press the vertical airflow direction button.



Each time the button is pressed, the air-flow direction is changed in the direction of the arrow.



※ Press the Vertical Airflow Direction button once more during Auto Swing at the direction of airflow you want.

Vertical Louver Control (Optional)

The Vertical Louvers can be adjusted by using the remote controller.

1. Press the ON/OFF BUTTON to start the unit.
2. Press the horizontal airflow direction button. Each time the button is pressed, the airflow direction is changed in the direction of the arrow.



※ Press the Horizontal Airflow Direction button once more during Full Auto Swing at the direction of airflow you want.

NOTE

- Manually moving the Horizontal Vane or Vertical Louvers by hand could damage the mechanism. When the unit is shut off, the Horizontal Vane and Vertical Louvers will close the air outlet vent of the product.
- Air Conditioner memorizes the last operated angle. So there is possibility of difference in the angle of Remote Controller and the unit after reoperation. In that case, angle can be adjusted by pressing the Vane Control Button on the Remote Controller.
- When connected to the Multi Outdoor unit, the vertical louvers may automatically move for a specific temperature zone at the cooling mode.
ex) 1 Step → 2 Step, 5 Step → 4 Step

Jet Cool/Heat Operation

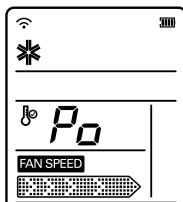

Jet cool function can be used to cool the room quickly in hot summer. When this function is turned on, the air conditioner runs in cooling operation mode with super high fan speed and 18°C setting temperature for 30 minutes for fast and effective cooling.

Similarly, jet heat function (available only in some models) warms up the room quickly by operating at super high fan speed and 30°C setting temperature for 30 minutes.

You can activate this operation by pressing the JET COOL BUTTON.

To change from jet cool mode to high fan speed cooling mode, press the JET COOL BUTTON or INDOOR FAN SPEED SELECTOR BUTTON or the ROOM TEMPERATURE SETTING BUTTON again.



NOTE

- Jet Cool/Heat operation cannot be activated during Air Circulation operation and auto changeover operation.
- In case of Cooling only model, Jet Cool cannot be activated during Heating.
- In case of Inverter you can use jet heat function by pressing JET COOL BUTTON for heating operation.
- Each time the JET COOL / MOISTURE COOLING BUTTON is pressed, the operation mode is shifted in the direction of the arrow.
 - Cooling
Jet cool → Moisture cooling operation → cooling
 - Heating
Jet heat → heating



Moisture Cooling Operation (Optional)

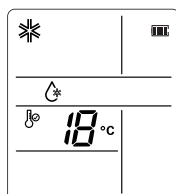

The moisture cooling operation is to prevent the room from excessive dryness by logic control so that the room humidity is kept up.



NOTE

- Push the JET COOL/MOISTURE COOLING BUTTON twice to activate Moisture Cooling Operation.
- Push the button again, then the mode goes to cooling mode.
- Moisture Cooling may not be activated at high temperature.
- Moisture cooling may not be activated during heating.
- Fan Speed Selection button is not activated during Moisture Cooling operation.
- It prevents excessive dryness, but doesn't moisturize.

Eco Eye Operation (Optional)

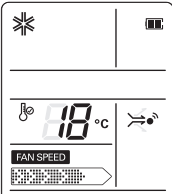

Eco Eye operation controls airflow by sensing the position of residents.



Each time the button is pressed, the mode is shifted in the direction of the arrow.



NOTE

- Pushing the horizontal vane control or vertical louver control button make to cancel the Eco Eye Operation
- Eco Eye operation is not activated during Moisture Cooling and Sleep Mode.
- Sensor detection sensitivity is different according to the position of indoor unit, movement of objects, temperature range etc.(The object very different from the surrounding temperature can be mistakenly detected.)
- Heat emitting objects such as TV, monitor can be mistakenly detected as people. Pets, fluttering curtains, sunlight, reflected light etc are also mistakenly detected.
- Energy Saving mode can be occurred because of sensing incorrectly depending on the thickness of clothes.
- It goes into Energy Saving mode if there are no people in the detecting area for 20 minutes.
- Energy Saving mode set setting temperature maximum +2°C during cooling, and maximum -2°C during heating.
- When surrounding temperature is high(approximately over 28°C), Eco Eye Operation and Eco Eye Energy Saving Mode is not activated.
- While Energy Saving Cooling mode operate, Eco Eye Energy Saving mode isn't activated. While Eco Eye at heating mode operates, horizontal vane will be stopped at the angle of maximum airflow.

CAUTION

- Do not locate large objects, heating units, or humidifiers near the "Eco Eye Sensor". It can make the "Eco Eye Sensor" detect objects incorrectly.
- Do not hit the "Eco Eye Sensor". The "Eco Eye Sensor" can be damaged or malfunction.

Detecting Range

Vertical angle 90°
(Side View)

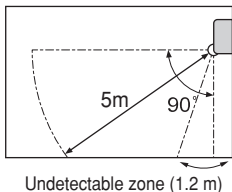

Horizontal angle 120°
(Top View)

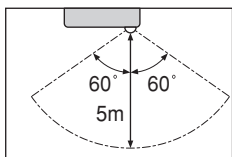

Maximum 5m of detection is possible on 2.3m height of installation standard (when people are seated). According to installation height, there is a possibility the detecting range change.

Direct Airflow

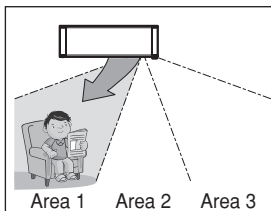

A person is detected in area 1.

Indirect Airflow

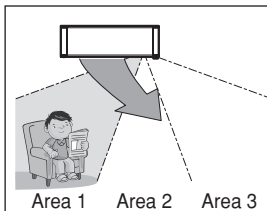

A person is detected in area 1.

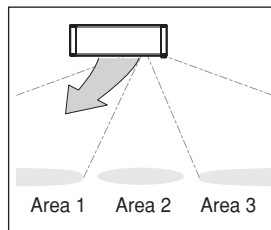

Energy Saving mode

The air conditioner will go into Energy-saving mode after 20 minutes the air conditioner doesn't detect people

NOTE

- In case two or more people are detected in the different area it changes auto swing mode
- People are detected in the boundary between Area1 and Area2 it changes auto swing mode

For example

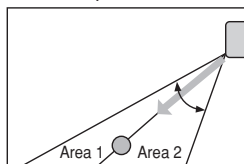

- People on the border of sensing area can be detected incorrectly by Eco Eye Sensor.
- The reaching range of airflow has about 30°s left and right angle (depending on Asherae airflow testing standard)

Forced operation

Forced operation is used when the remote controller can't be used. The operation will be started if the ON/OFF button is pressed. If you want to stop the operation, re-press the button.

Premium type

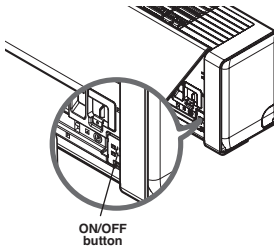

Rational type

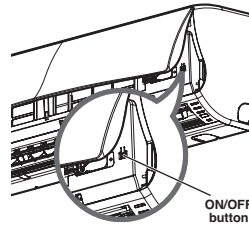

	Cooling Model	Heat pump Model		
		Room Temp. $\geq 24^{\circ}\text{C}$	$21^{\circ}\text{C} \leq$ Room Temp. $< 24^{\circ}\text{C}$	Room Temp. $< 21^{\circ}\text{C}$
Operating mode	Cooling	Cooling	Healthy Dehumidification	Heating
Indoor FAN Speed	High	High	High	High
Setting Temperature	22°C	22°C	23°C	24°C

Test operation

During the TEST OPERATION, the unit operates in cooling mode at high speed fan, regardless of room temperature and resets in 18 minutes. During test operation, if remote controller signal is received, the unit operates as remote controller sets. If you want to use this operation, Press and hold the ON/OFF button for 3~5 seconds, then the buzzer sound 1 'beep'. If you want to stop the operation, re-press the button.

NOTE

If you do not have the remote controller around here, you can start to operate the forced operation. If you force to close the front panel, some parts may be damaged. So you must follow the below step. (Only premium type)

• In case of turning ON

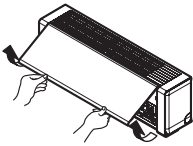

Open the front panel.

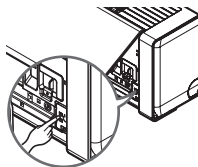

Press the ON/OFF button. So you can operate the air conditioner.

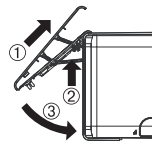

- ① Lift up the front panel after approximately 25 seconds.
- ② Fold the supporter.
- ③ Close the front panel.

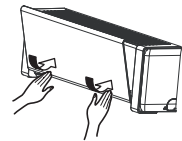

Press the front panel as shown until hearing "clicking" sounds.

• In case of turning OFF



Open the front panel.

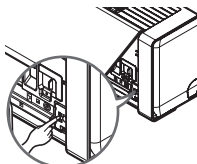

Press the ON/OFF button. So you can turn off the air conditioner.

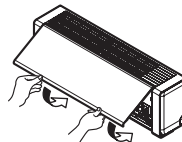

Fold the supporter after approximately 25 seconds. Close the front panel.

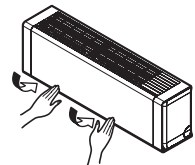

Press the front panel as shown until hearing "clicking" sounds.

Auto Restart Function

This function is useful in the situation of power failure. When power regains after a failure this feature restore the previous operating condition and the air conditioner will run in the same settings.

NOTE

This feature is enabled by factory default setting, but you can disable it by pressing the ON/OFF button for 6 seconds. The unit will beep twice and the lamp will blink 6 times. To enable it, press the button again for 6 seconds. The unit will beep twice and the blue lamp will blink 4 times.

Premium type

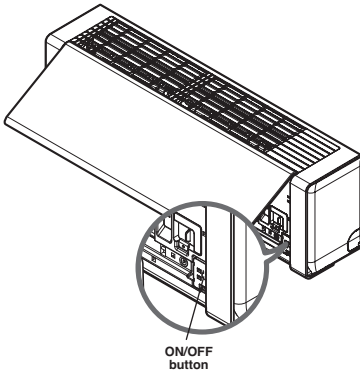

Rational type

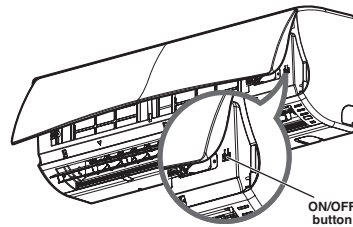

Maintenance and Service

⚠ CAUTION

Before performing any maintenance, turn off the main power to the system, disconnect the circuit breaker and unplug the power cord.

Indoor Unit

Clean the unit with a soft dry cloth. Do not use bleach or abrasives.

⚠ CAUTION

Never use any of these

- Water hotter than 40°C. It may cause deformation and discoloration.
- Volatile substances. They may damage the surface of the air conditioner.

Air Filters

The air filters behind the front panel / grill should be checked and cleaned once in every 2 weeks or more often if necessary. To remove the filters see the self explanatory diagrams for each model type. Clean the filters with a vacuum cleaner or warm soapy water. If dirt is not easily removed, wash with a solution of detergent in luke warm water. Dry well in shade after washing and reinstall the filters back in place.

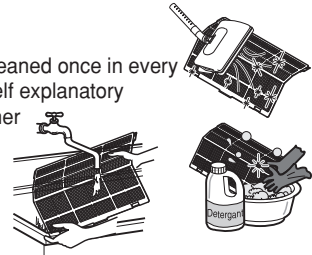

Plasma Filter

The plasma filters behind the air filter should be checked and cleaned once in every 3 months or more often if necessary. To remove the filters see the self explanatory diagrams for each model type. Clean the filters with a vacuum cleaner. If it is dirty wash it with water and dry well in shade and install back in place.

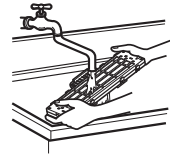

Allergy Free Filter + Triple Filter

Remove the Allergy Free Filter + Triple Filter behind the air filter and expose them in direct sunlight for 2 hours. And then insert these filters into original position.

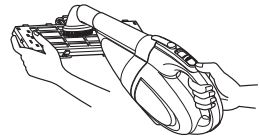

Removal of Filters

Open the front panel as shown.

Then pull the filter tab slightly forward to remove the air filter.

After removing the air filter remove the plasma and Allergy Free Filter by slightly pulling downwards.

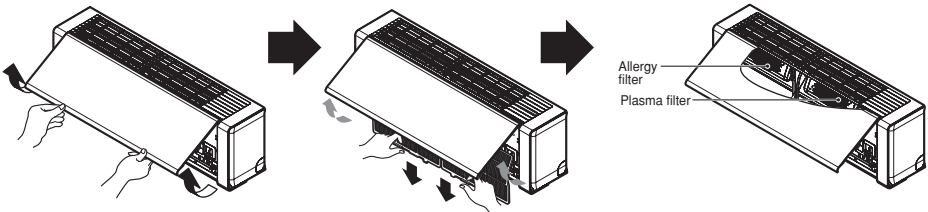

⚠ CAUTION

Don't touch this plasma filter within 10 seconds after opening the inlet grille, it may cause an electric shock.

Outdoor Unit

The heat exchanger coils and panel vents of the outdoor unit should be checked regularly. If clogged with dirt or soot, the heat exchanger and panel vents may be professionally steam cleaned.

NOTE

Dirty or clogged coils will reduce the operating efficiency of the system and cause higher operating costs.

Operation Tips!

Do not overcool the room.

This is not good for the health and wastes electricity.

Keep blinds or curtains closed.

Do not let direct sunshine enter the room when the air conditioner is in operation.

Keep the room temperature uniform.

Adjust the vertical and horizontal airflow direction to ensure a uniform temperature in the room.

Make sure that the doors and windows are shut tight.

Avoid opening doors and windows as much as possible to keep the cool air in the room.

Clean the air filter regularly.

Blockages in the air filter reduce the airflow and lower cooling and dehumidifying effects. Clean at least once every two weeks.

Ventilate the room occasionally.

Since windows are kept closed, it is a good idea to open them and ventilate the room now and then.

Use high fan speed for effective and fast cooling.

The unit gives its rated cooling capacity when the fan speed is high.

Self-Diagnosis Function

This unit has an inbuilt error diagnosis capability. Unit LED will blink in case if thermistor fails. Please contact your serviceman/dealer in such a situation

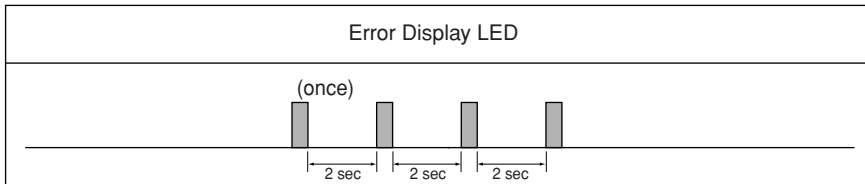

Troubleshooting Tips! Save time and money!

The air conditioner may be operating abnormally when:

<i>Problem</i>	<i>Possible Causes</i>	<i>What To Do</i>
Air conditioner does not start	■ The air conditioner is unplugged.	• Make sure the air conditioner plug is pushed completely into the outlet.
	■ The fuse is blown/circuit breaker is tripped.	• Check the house fuse/circuit breaker box and replace the fuse or reset the breaker.
	■ Power failure.	• If power failure occurs, turn the mode control to OFF. When power is restored, wait 3 minutes to restart the air conditioner to prevent tripping of the compressor overload.
	■ High voltage.	• If the voltage is unusually very high or low the circuit Breaker will trip.
Air conditioner does not cool as it should	■ Airflow is restricted.	• Make sure there are no curtains, blinds, or furniture blocking the front of the air conditioner.
	■ The air filter is dirty.	• Clean the filter at least every 2 weeks. See the Maintenance and Service section.
	■ The room may have been hot.	• When the air conditioner is first turned on, you need to allow time for the room to cool down.
	■ Cold air is escaping.	• Check for open furnace floor registers and cold air returns.
	■ Check the temperature settings.	• Make sure they are correct.
	■ There might be any heating source in the room.	• Check and remove such source or turn it off while using the air conditioner.

Call the service immediately in the following situations

1. Anything abnormal such as burning smell, loud noise etc. happen. Stop the unit and turn the breaker off. Never try to repair by yourself or restart the system in such cases.
2. Main power cord is too hot or damaged.
3. Error code is generated by self diagnosis.
4. Water leaks from indoor unit even if the humidity is low.
5. Any switch, breaker (safety, earth) or fuse fails to work properly

User must carry routine checkup & cleaning to avoid unit's poor performance. In case of special situation, the job must be carried out by service person only.

ELECTRICAL SPECIFICATIONS:

220 V ~ 60 Hz Since this manual refers to different models, you are invited to pay special attention to the sticker placed on your product to check the consumption of your model.



LG Electronics México, S.A de C.V

Av. Sor Juana Inés de la Cruz No. 555

Col. San Lorenzo

Tlalnepantla, Estado de México C.P. 54033

Tel. 5321 1919

Teléfono sin costo 01 800 347 1919

Página web <http://www.lg.com.mx>

