

User's Guide Specification

담당

관리자

JMJ
08.03.06

KIM JONG OK
08.03.06

1. Model Description

MODEL	22/26/32/ 37/42LG300C-ZA	BRAND	LG	Part No.	MFL34441619 (0810-REV03)
SUFFIX	EU	Product Name	22/26/32/37/42LG300C-ZA		

2. Printing Specification

1. Trim Size (Format) : 185mm x 260 mm
2. Printing Colors
 - Cover : 1 COLOR (BLACK)
 - Inside : 1 COLOR (BLACK)
3. Stock (Paper)
 - Cover : Coated paper, S/W 150 g/m²
 - Inside : Uncoated paper , 백상지 60 g/m²
4. Printing Method : Off-set
5. Bindery : Perfect bind
6. Language : English (1)
7. Number of pages : 96

NOTES

“This part contain Eco-hazardous substances (Pb, Cd, Hg, Cr6+, PBB, PBDE, etc.) within LG standard level, Details should be followed Eco-SCM management standard[LG(56)-A-2524]. Especially, Part should be followed and controlled the following specification.
 (1)Eco-hazardous substances test report should be submitted when Part certification test and First Mass Production.
 (2) Especially, Don't use or contain lead(Pb) and cadmium(Cd) in ink.

3. Special Instructions

(1) Origin Notification

- * LGEIN : Printed in Indonesia
- * LGEWA : Printed in U.K.
- * LGESP : Printed in Brazil
- * LGEMX : Printed in Mexico
- * LGEND : Printed in China
- * LGEIL : Printed in India
- * LGEMA : Printed in Poland

4. Changes

10				
9				
8				
7				
6				
5				
4				
3	Oct. 21.08	Jeon Mi Jeong	S8-32796	Added the Protective Bracket and Bolt for Power Cord
2	Sep.23.08	Jeon Mi Jeong	S8-30668	Added Screw for stand fixing(37LG300C-ZA)
1	May.23.08	Jeon Mi Jeong	S8-20892	Applied the result of PQ testing.
REV. NO.	MM/DD/YY	SIGNATURE	CHANGE NO.	CHANGE CONTENTS

Pagination sheet

P/NO. **MFL34441619**
Total pages : 96 pages

Front cover

<en>

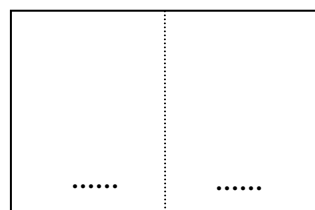
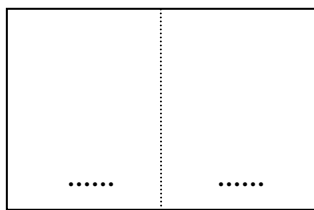
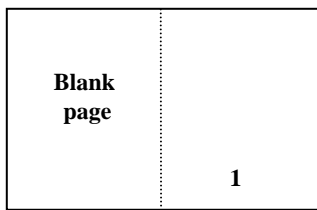

Back cover

<en>

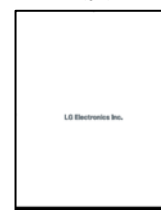
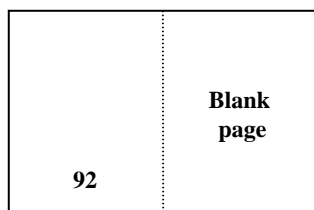
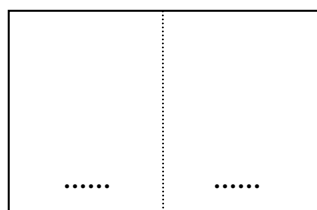



LCD TV OWNER'S MANUAL

LCD TV MODELS

- 22LG30**
- 26LG30**
- 32LG30**
- 37LG30**
- 42LG30**

Please read this manual carefully before operating your TV.
Retain it for future reference.
Record model number and serial number of the TV.
Refer to the label on the back cover and quote this information.
To your dealer when requiring service.



Trade Mark of the DVB Digital Video Broadcasting Project (1991 to 1996)

ID Number(s): 5243: 22LG300C-ZA
5242: 26LG300C-ZA
5382: 32LG300C-ZA
5383: 37LG300C-ZA
5384: 42LG300C-ZA

P/NO: MFL34441619 (0810-REV03)
Printed in Korea

ACCESSORIES

Ensure that the following accessories are included with your TV. If an accessory is missing, please contact the dealer where you purchased the TV.

The accessories included may differ from the images below.



Owner's Manual



Batteries

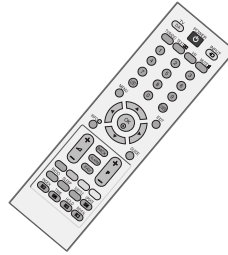

Remote Control

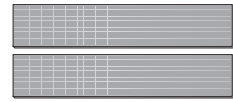

Dual Lock™
(This feature is not available for all models.)
(Refer to P.11)



Power Cord

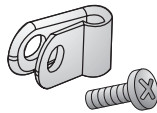

Protective Bracket and Bolt for Power Cord
(This feature is not available for all models.)
(Refer to P.10)

This feature is not available for all models.



Polishing Cloth

Polishing cloth for use on the screen.

Lightly wipe any stains or fingerprints on the surface of the TV with the polishing cloth.

Do not use excessive force. This may cause scratching or discolouration.

Only 22LG30**



Cable Management Clip

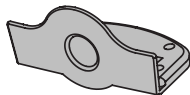

Protection Cover

Only 26/32/37/42LG30**

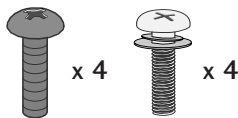

Bolts for stand assembly
(Refer to P.8)

(Only 26/32/37/42LG30**)



Screw for stand fixing
(Refer to P.11)

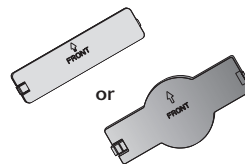

Protection Cover
(Refer to P.13)

CONTENTS

ACCESSORIES 1

PREPARATION

Front Panel Controls	4
Back Panel Information	6
Stand Installation	8
Please set it up carefully so the product does not fall over	9
Back Cover for Wire Arrangement	10
Attaching the TV to a desk	11
Swivel Stand	11
Positioning your display	12
Location	12
Kensington Security System	12
Protection cover	13
Desktop Pedestal Installation	14
Wall Mount: Horizontal installation	14
Antenna Connection	15

EXTERNAL EQUIPMENT SETUP

HD Receiver Setup	16
DVD Setup	18
VCR Setup	20
Other A/V Source Setup	22
Insertion of CI Module	22
PC Setup	23
- Screen Setup for PC Mode	26

WATCHING TV / PROGRAMME CONTROL

Remote Control Key Functions	30
Turning on the TV	32
Programme Selection	32
Volume Adjustment	32
On-Screen Menus Selection and Adjustment	33
Auto Programme Tuning	34
Manual Programme Tuning (In Digital Mode)	35
Manual Programme Tuning (In Analogue Mode) ..	36
Programme Edit	38
Booster	41
Software Update	42

Diagnostics	43
CI Information	44
Selecting the Programme Table	45
Input Label	46

EPG (ELECTRONIC PROGRAMME GUIDE) (IN DIGITAL MODE)

Switch On/ Off EPG	47
Select Programme	47
Button Function in NOW/NEXT Guide Mode	47
Button Function in 8 Day Guide Mode	48
Button Function in Date Change Mode	48

PICTURE CONTROL

Picture Size (Aspect Ratio) Control	49
Preset Picture Settings	
- Picture Mode-Preset	51
- Auto Colour Tone Control (Warm/Medium/Cool)	52
Manual Picture Adjustment	
- Picture Mode-User option	53
Picture Improvement Technology	54
Advanced - Film Mode	55
Advanced - Black(Darkness) Level	56
Eye Care	57
Picture Reset	58

SOUND & LANGUAGE CONTROL

Auto Volume Leveler	59
Preset Sound Settings - Sound Mode	60
Sound Setting Adjustment - User Mode	61
Balance	62
Audio Reset	63
I/II	
- Stereo/Dual Reception (In Analogue Mode Only)	64
- NICAM Reception (In Analogue Mode Only)	65
- Speaker Sound Output Selection	65
On-Screen Menu Language/Country Selection	66
Language selection (In Digital Mode only)	67

TIME SETTING

Clock Setup	68
Auto On/ Off Timer Setting	69
Auto Shut-off Setting	70
Time Zone Setup	70
Sleep Timer Setting	71
Alarm setting	71

PARENTAL CONTROL / RATINGS

Set Password & Lock System	72
Block Programme	73
Parental Control	74
Key Lock	75

TELETEXT

Switch On/ Off	76
SIMPLE Text	76
TOP Text	76
FASTEXT	77
Special Teletext Functions	77

DIGITAL TELETEXT

Teletext within Digital Service	78
Teletext in Digital Service	78

APPENDIX

Initializing (Reset to original factory setting)	79
Troubleshooting	80
Maintenance	82
Product Specifications	83
IR Codes	84
External Control Device Setup	86

PREPARATION

FRONT PANEL CONTROLS

- Image shown may differ from your TV.
- If your TV has a protection film attached, remove the film and then wipe the TV with a polishing cloth.

PREPARATION

22LG30**

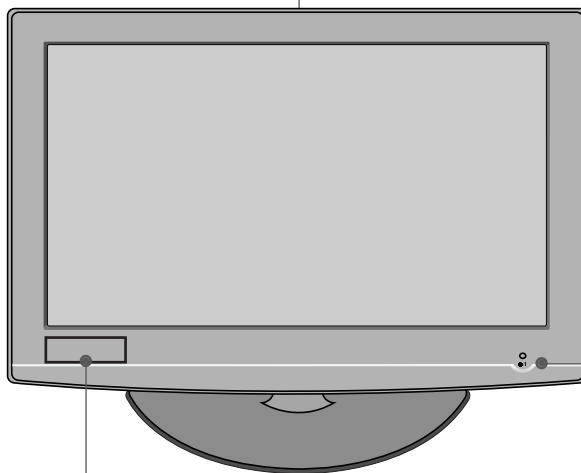
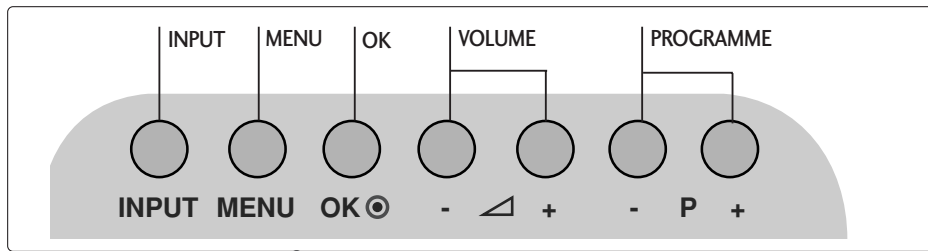

Clock LED

POWER

Remote Control Sensor

Power/Standby Indicator

- illuminates red in standby mode.
- illuminates blue when the TV is switched on.

Note: You can adjust **Power Indicator** in the **OPTION** menu.

26/32/37/42LG30**

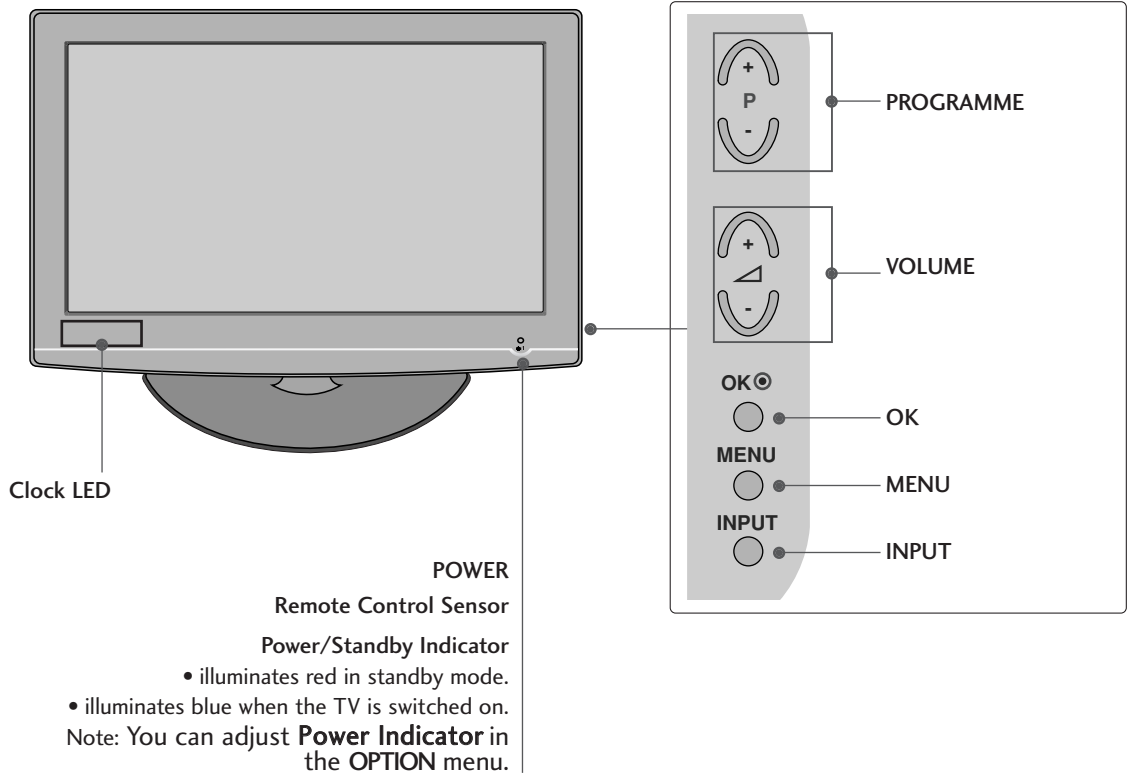

PREPARATION

BACK PANEL INFORMATION

■ Image shown may differ from your TV.

22LG30**

PREPARATION

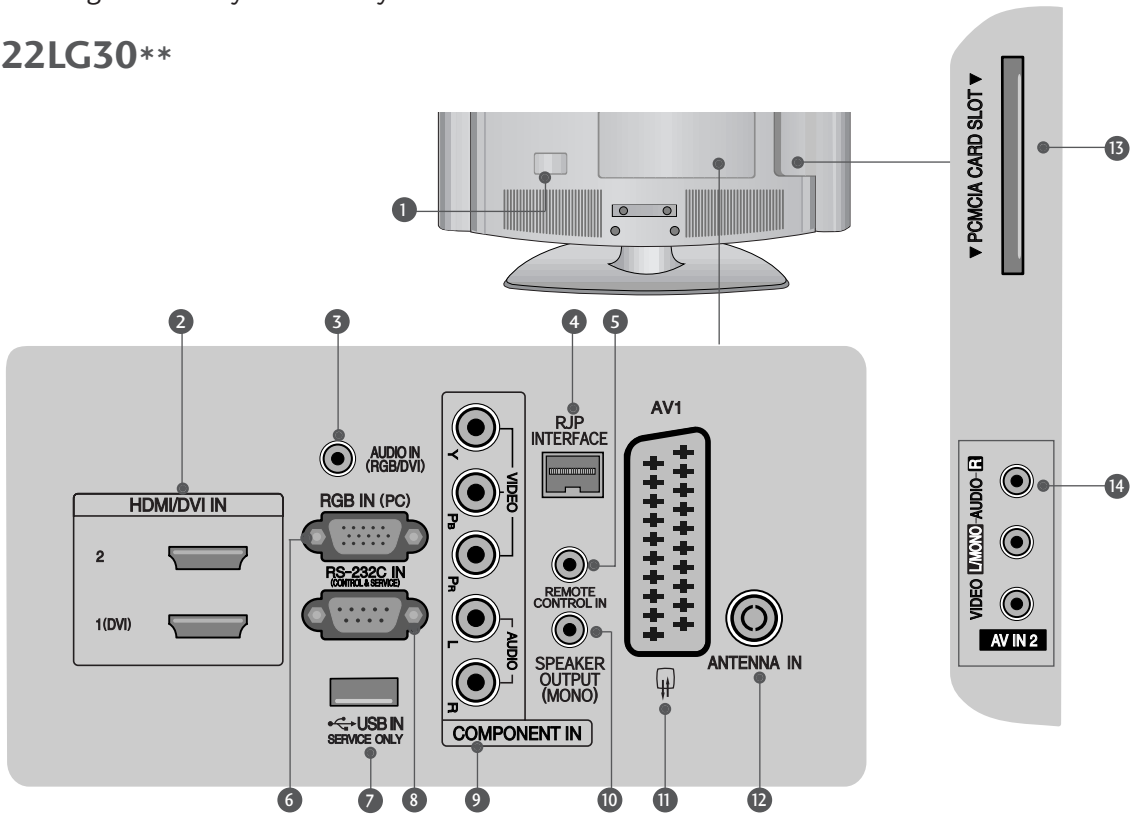

- 1 Power Cord Socket**
This TV operates on an AC power. The voltage is indicated on the Specifications page. Never attempt to operate the TV on DC power.
- 2 HDMI Input**
Connect a HDMI signal to HDMI IN. Or DVI (VIDEO) signal to HDMI/DVI port with DVI to HDMI cable.
- 3 RGB/DVI Audio Input**
Connect the audio from a PC or STB with DVI output.
- 4 RJP INTERFACE**
Connect control line (RJ45) for RJP(Remote Jack pack)
- 5 Remote Control Port**
- 6 RGB Input**
Connect the output from a PC.
- 7 SERVICE ONLY PORT**
- 8 RS-232C IN (CONTROL & SERVICE) PORT**
Connect to the RS-232C port on a PC.
- 9 Component Input**
Connect a component video/audio input to these jacks.
- 10 SPEAKER OUTPUT(MONO)**
The phone socket for external speaker is on this jack.
- 11 Euro Scart Socket (AV1)**
Connect scart socket from an external device to this jack.
- 12 Antenna Input**
Connect RF antenna to this jack.
- 13 PCMCIA (Personal Computer Memory Card International Association) Card Slot**
(This feature is not available in all countries.)
- 14 Audio/Video Input(AV2)**
Connect audio/video output from an external device to these jacks.

26/32/37/42LG30**

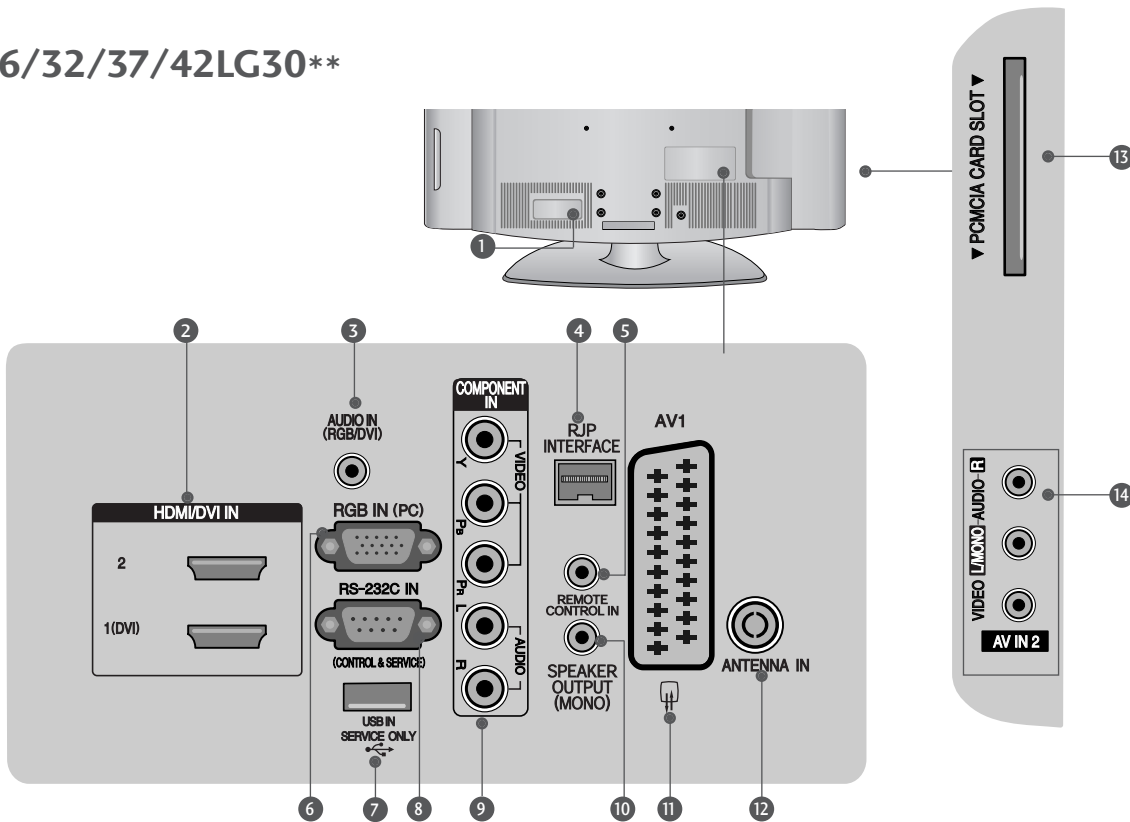

- 1 Power Cord Socket**
This TV operates on an AC power. The voltage is indicated on the Specifications page. Never attempt to operate the TV on DC power.
- 2 HDMI Input**
Connect a HDMI signal to HDMI IN. Or DVI (VIDEO) signal to HDMI/DVI port with DVI to HDMI cable.
- 3 RGB/DVI Audio Input**
Connect the audio from a PC or STB with DVI output.
- 4 RJP INTERFACE**
Connect control line (RJ45) for RJP(Remote Jack pack)
- 5 Remote Control Port**
- 6 RGB Input**
Connect the output from a PC.
- 7 SERVICE ONLY PORT**
- 8 RS-232C IN (CONTROL & SERVICE) PORT**
Connect to the RS-232C port on a PC.
- 9 Component Input**
Connect a component video/audio input to these jacks.
- 10 SPEAKER OUTPUT(MONO)**
The phone socket for external speaker is on this jack.
- 11 Euro Scart Socket (AV1)**
Connect scart socket from an external device to this jack.
- 12 Antenna Input**
Connect RF antenna to this jack.
- 13 PCMCIA (Personal Computer Memory Card International Association) Card Slot**
(This feature is not available in all countries.)
- 14 Audio/Video Input(AV2)**
Connect audio/video output from an external device to these jacks.

Stand installation

■ Image shown may differ from your TV.

For 22LG30**

- 1 Carefully place the TV screen side down on a cushioned surface to protect the screen from damage.

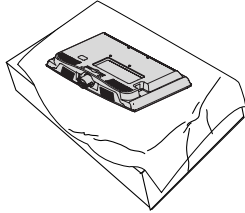

- 2 Assemble the parts of the **STAND BODY** with **COVER BASE** of the TV. Insert the **STAND BODY** into a **COVER BASE** until clicking sound.

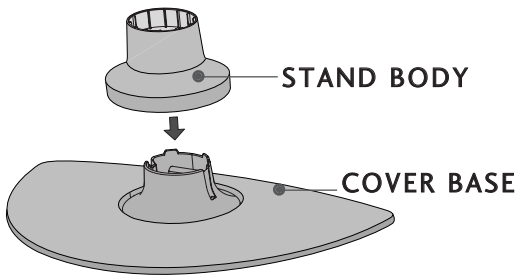

- 3 Assemble the TV as shown.

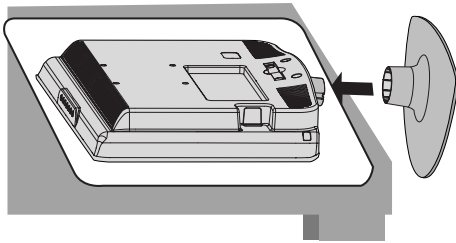

For 26/32/37/42LG30**

- 1 Carefully place the TV screen side down on a cushioned surface to protect the screen from damage.

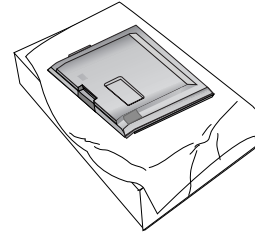

- 2 Assemble the parts of the **STAND BODY** with **COVER BASE** of the TV.

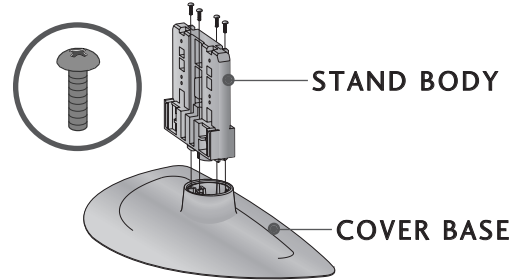

- 3 Assemble the TV as shown.

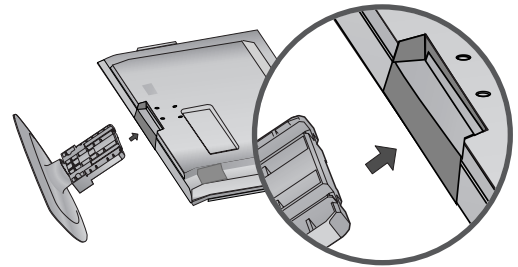

- 4 Fix the 4 bolts securely using the holes in the back of the TV.

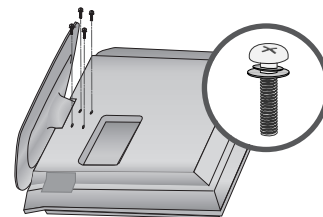

PLEASE SET IT UP CAREFULLY SO THE PRODUCT DOES NOT FALL OVER.

- You should purchase necessary components to fix the TV to the wall on the market.
- Position the TV close to the wall to avoid the possibility of it falling when pushed.
- The instructions shown below are a safer way to set up the TV, which is to fix it to the wall, avoiding the possibility of it falling forwards if pulled. This will prevent the TV from falling forward and causing injury. This will also prevent the TV from damage. Ensure that children do not climb or hang from the TV.

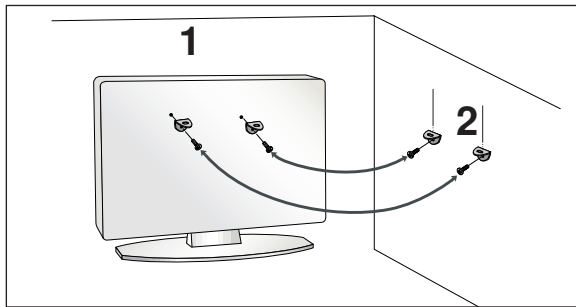

- 1 Use the eye-bolts or TV brackets/bolts to fix the TV to the wall as shown in the picture. (If your TV has bolts in the eyebolts, loosen these bolts.)
* Insert the eye-bolts or TV brackets/bolts and tighten them securely in the upper holes.
- 2 Secure the wall brackets with the bolts on the wall. Match the height of the bracket that is mounted on the wall.

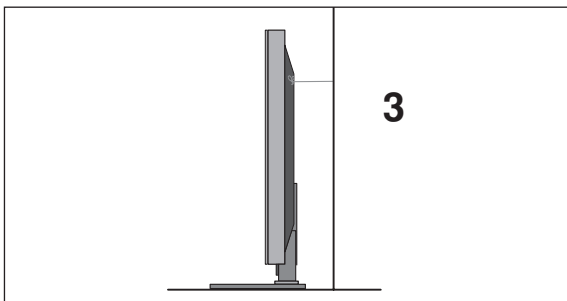

- 3 Use a sturdy rope to tie the TV. It is safer to tie the rope so it becomes horizontal between the wall and the TV.

! NOTE

- ▶ When moving the TV undo the cords first.
- ▶ Use a platform or cabinet strong and large enough to support the size and weight of the TV.
- ▶ To use the TV safely make sure that the height of the bracket on the wall and on the TV is the same.

PREPARATION

BACK COVER FOR WIRE ARRANGEMENT

■ Image shown may differ from your TV.

For 22LG30**

- 1 Connect the cables as necessary.
To connect additional equipment, see the **EXTERNAL EQUIPMENT SETUP** section.
Secure the power cable with the **PROTECTIVE BRACKET** and the screw as shown. It will help prevent the power cable from being removed by accident.

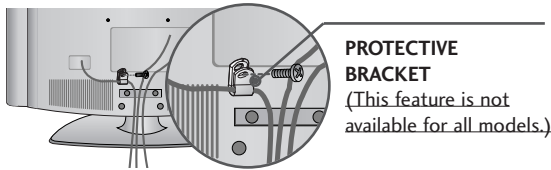

- 2 Install the **CABLE MANAGEMENT CLIP** as shown.

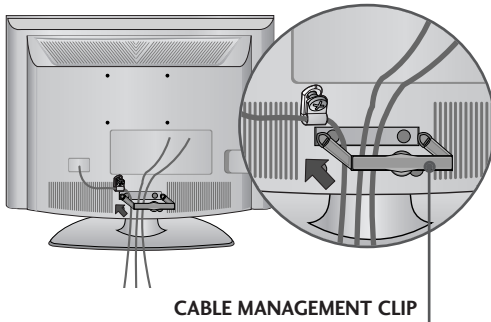

- 3 Fit the **CABLE MANAGEMENT CLIP** as shown.

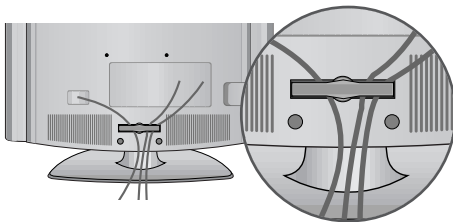

How to remove the CABLE MANAGEMENT CLIP

- ▶ Hold the **CABLE MANAGEMENT CLIP** with both hands and pull it backward.

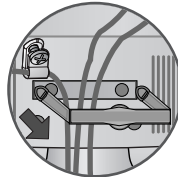

For 26/32/37/42LG30**

- 1 Connect the cables as necessary.
To connect additional equipment, see the **EXTERNAL EQUIPMENT SETUP** section.
Secure the power cable with the **PROTECTIVE BRACKET** and the screw as shown. It will help prevent the power cable from being removed by accident.

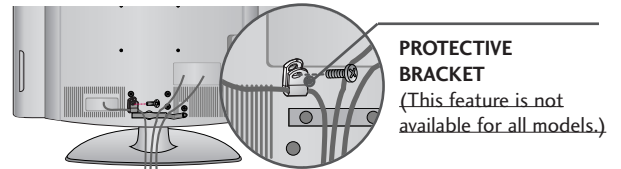

- 2 Install the **CABLE MANAGEMENT CLIP** as shown.

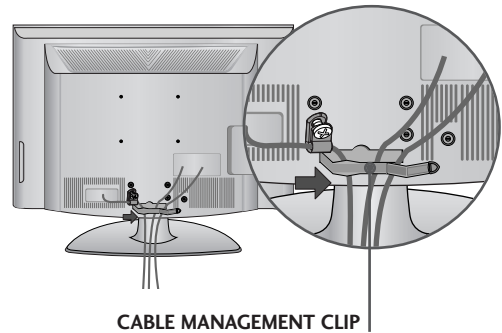

- 3 Put the cables inside the **CABLE MANAGEMENT CLIP** and snap it closed.

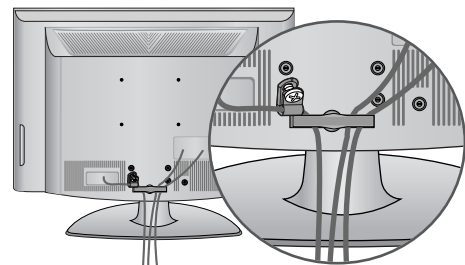

! NOTE

- ▶ Do not hold the **CABLE MANAGEMENT CLIP** when moving the TV.
- If the TV is dropped, you may be injured or the product may be broken.

Attaching the TV to a desk (Only 26/32/37/42LG30**)

The TV must be attached to desk so it cannot be pulled in a forward/backward direction, potentially causing injury or damaging the product. Use only an attached screw.

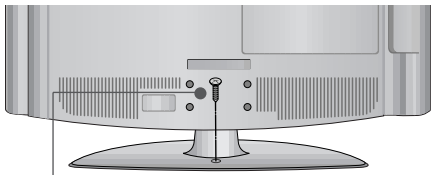

1-Screw
(provided as parts of the product)

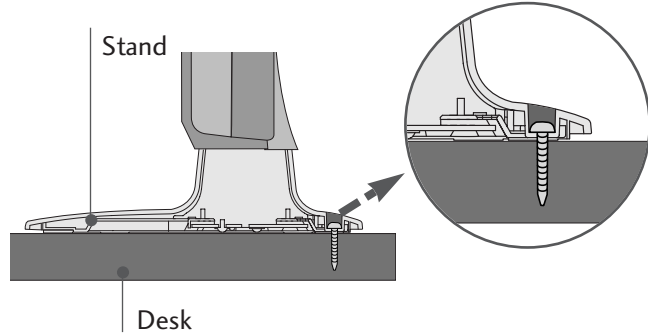

! WARNING

- ▶ To prevent TV from falling over, the TV should be securely attached to the floor/wall per installation instructions. Tipping, shaking, or rocking the machine may cause injury.

Swivel Stand (Only 26/32/37/42LG30**)

After installing the TV, you can adjust the TV manually to the left or right direction by 20 degrees to suit your viewing position.

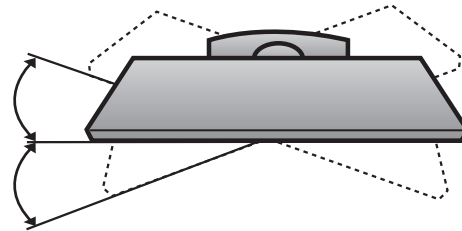

How to use Dual Lock™ (This feature is not available for all models.)

Fix the set-top box to the TV and use it when you want to.

- 1 After removing the protection paper from the Dual Lock, stick it to the TV and the set-top box as shown.

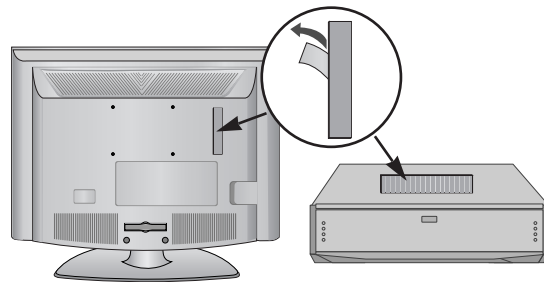

- 2 Attach the set-top box to the TV by pressing the Velcro strips together.

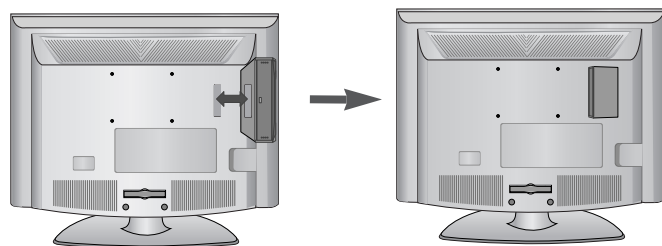

PREPARATION

POSITIONING YOUR DISPLAY (Only 22LG30**)

- Image shown may differ from your TV.
- Adjust the position of the panel in various ways for maximum comfort.

• Tilt range

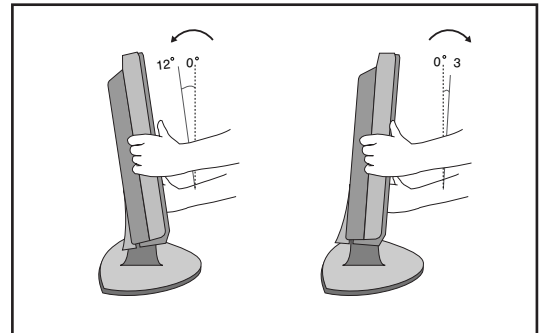

LOCATION (Only 22LG30**)

Position your TV so that no bright light or sunlight falls directly onto the screen. Care should be taken not to expose the tv to any unnecessary vibration, moisture, dust or heat. Also ensure that the TV is placed in a position to allow a free flow of air. Do not cover the ventilation openings on the back cover.

If you intend to mount the TV to a wall, attach VESA standard mounting interface (optional parts) to the back of the TV.

When you install the TV to use the wall mounting bracket (optional parts), fix it carefully so as not to drop.

KENSINGTON SECURITY SYSTEM (Only 22LG30**)

The TV is equipped with a Kensington Security System connector on the back panel. Connect the Kensington Security System cable as shown below.

For the detailed installation and use of the Kensington Security System, refer to the user's guide provided with the Kensington Security System.

For further information, contact <http://www.kensington.com>, the internet homepage of the Kensington company. Kensington sells security systems for expensive electronic equipment such as notebook PCs and LCD projectors.

NOTE

- The Kensington Security System is an optional accessory.

NOTES

- If the TV feels cold to the touch, there may be a small "flicker" when it is turned on.
This is normal, there is nothing wrong with TV.
- Some minute dot defects may be visible on the screen, appearing as tiny red, green, or blue spots. However, they have no adverse effect on the monitor's performance.
- Avoid touching the LCD screen or holding your finger(s) against it for long periods of time.
Doing so may produce some temporary distortion effects on the screen.

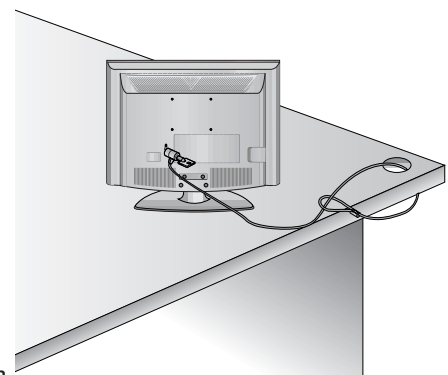

PROTECTION COVER

▪ Image shown may differ from your TV.

For 22LG30**

- 1 Loosen the bolts from TV.

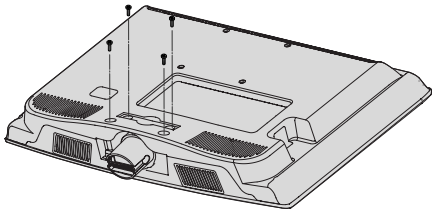

- 2 Bend the **HINGE BODY** and pull it backward.

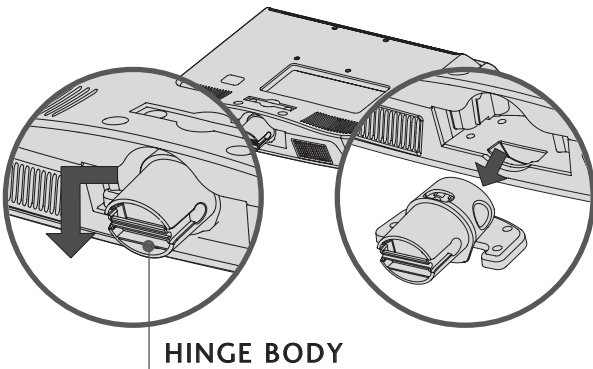

- 3 Insert the **PROTECTION COVER** into the TV.

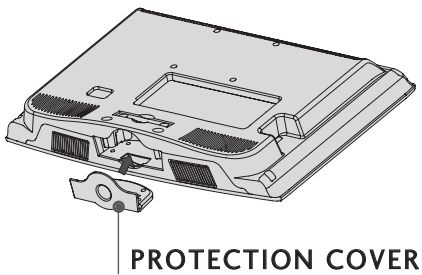

- 4 Fix the 4 bolts securely using the holes in the back of the TV.

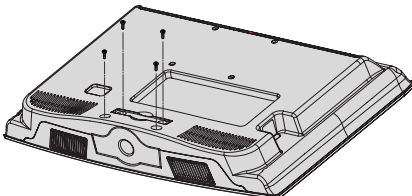

For 26/32/37/42LG30**

When installing the wall-mounted unit, use the protection cover for desk-type stand installation. Insert the **PROTECTION COVER** into the TV until clicking sound.

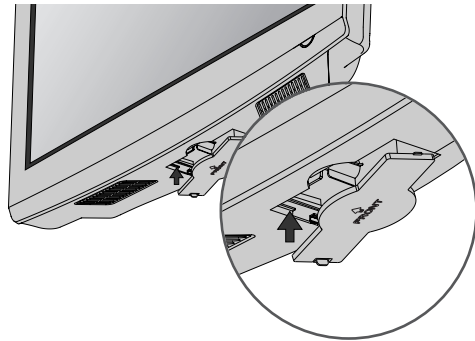

or

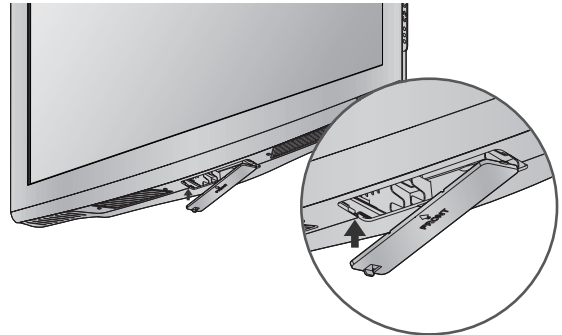

- The TV can be installed in various ways such as on a wall, or on a desktop etc.
- The TV is designed to be mounted horizontally.

EARTHING

Ensure that you connect the earth wire to prevent possible electric shock. If grounding methods are not possible, have a qualified electrician install a separate circuit breaker.

Do not try to earth the TV by connecting it to telephone wires, lightening rods or gas pipes.

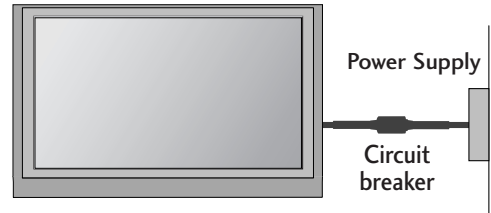

DESKTOP PEDESTAL INSTALLATION

For adequate ventilation allow a clearance of 4" (10cm) all around the TV.

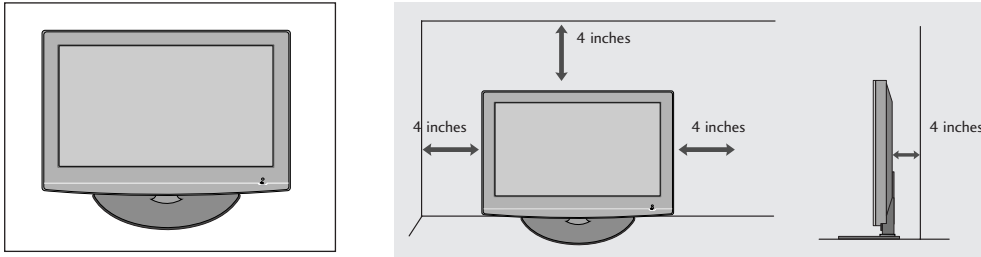

WALL MOUNT: HORIZONTAL INSTALLATION

For adequate ventilation allow a clearance of 4" (10cm) all around the TV. We recommend that you use a wall mounting bracket of LG brand when mounting the TV to a wall.

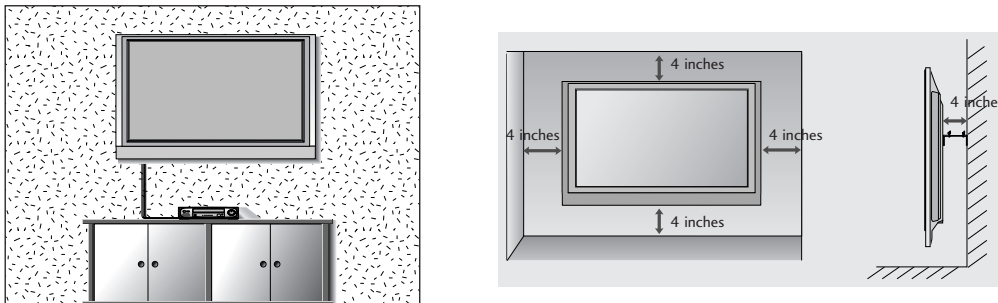

- To prevent damage do not connect to the mains outlet until all connections are made between the devices.

ANTENNA CONNECTION

- For optimum picture quality, adjust antenna direction.
- An antenna cable and converter are not supplied.

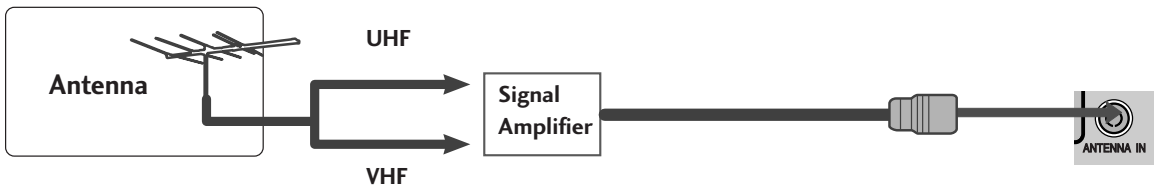
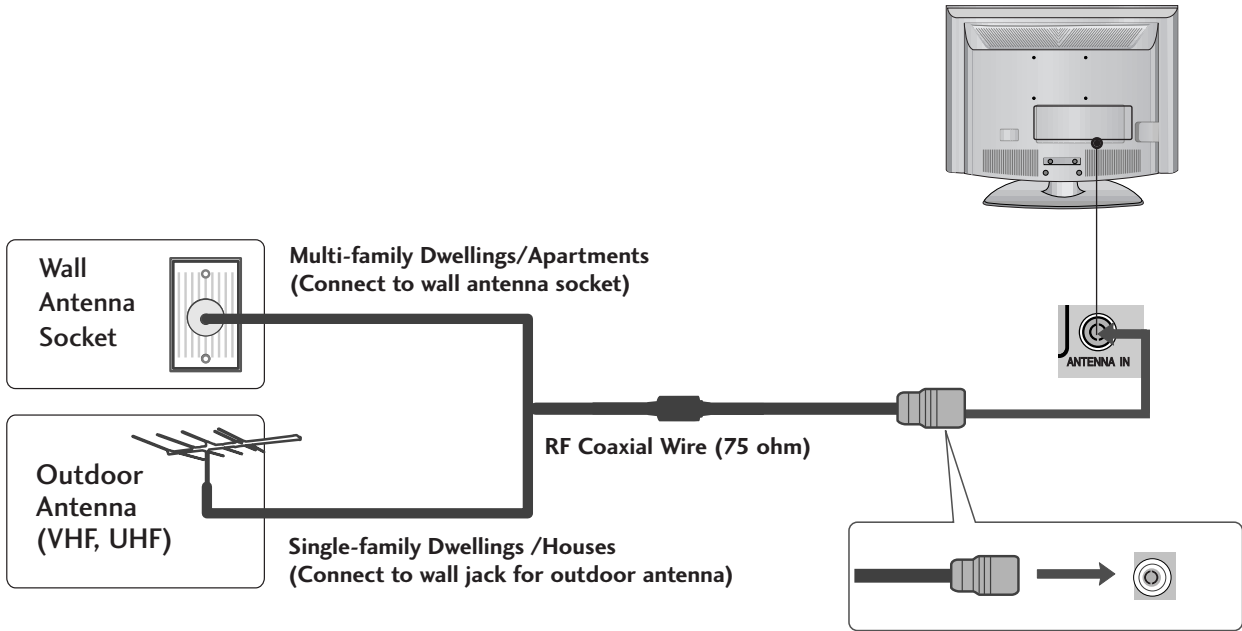

- In poor signal areas, to achieve better picture quality it may be necessary to install a signal amplifier to the antenna as shown above.
- If signal needs to be split for two TVs, use an antenna signal splitter for connection.

EXTERNAL EQUIPMENT SETUP

- To avoid damaging any equipment, never plug in any power cords until you have finished connecting all equipment.
- This section on EXTERNAL EQUIPMENT SETUP mainly uses diagrams for the 26LG30** models.

HD RECEIVER SETUP

- This TV can receive Digital RF/Cable signals without an external digital set-top box. However, if you do receive Digital signals from a digital set-top box or other digital external device, refer to the diagram as shown below.

Connecting with a component cable

- 1 Connect the video outputs (Y, PB, PR) of the digital set top box to the **COMPONENT IN VIDEO** jacks on the TV.
- 2 Connect the audio output of the digital set-top box to the **COMPONENT IN AUDIO** jacks on the TV.
- 3 Turn on the digital set-top box.
(Refer to the owner's manual for the digital set-top box.)
- 4 Select **Component** input source using the **INPUT** button on the remote control.

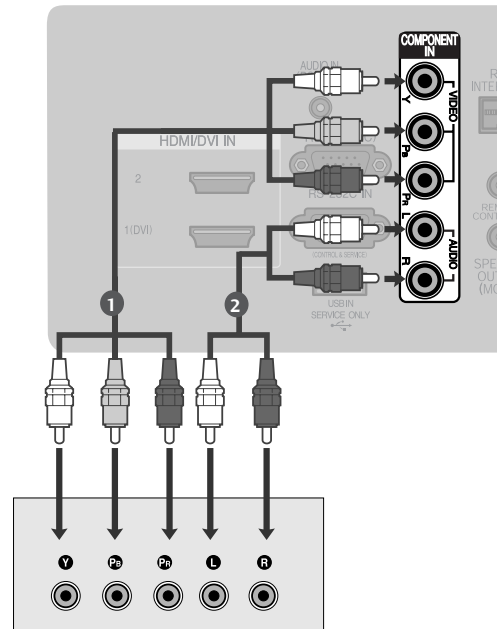

Signal	Component	HDMI
480i/576i	Yes	No
480p/576p	Yes	Yes
720p/1080i	Yes	Yes
1080p	Yes	Yes

Connecting a set-top box with an HDMI cable

- 1 Connect the HDMI output of the digital set-top box to the **HDMI/DVI IN 1 (DVI)** or **HDMI/DVI IN 2** jack on the TV.
- 2 Turn on the digital set-top box.
(Refer to the owner's manual for the digital set-top box.)
- 3 Select **HDMI1** or **HDMI2** input source using the **INPUT** button on the remote control.

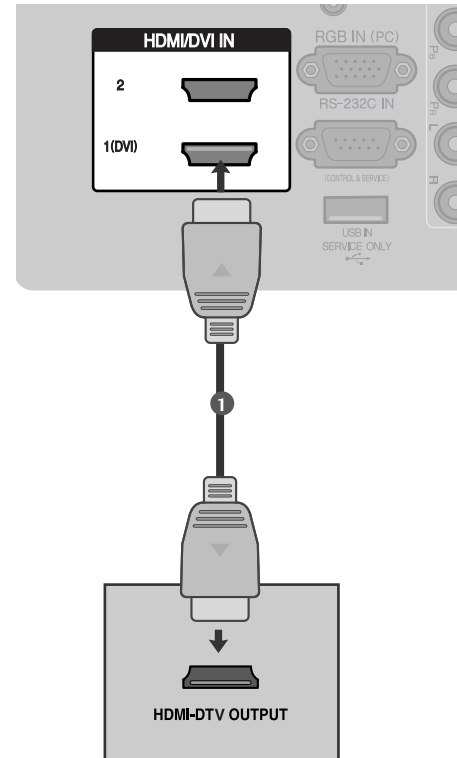

Connecting with a HDMI to DVI cable

- 1 Connect the digital set-top box to **HDMI/DVI IN 1 (DVI)** jack on the TV.
- 2 Connect the audio output of the digital set-top box to the **AUDIO IN (RGB/DVI)** jack on the TV.
- 3 Turn on the digital set-top box. (Refer to the owner's manual for the digital set-top box.)
- 4 Select **HDMI 1** input source using the **INPUT** button on the remote control.

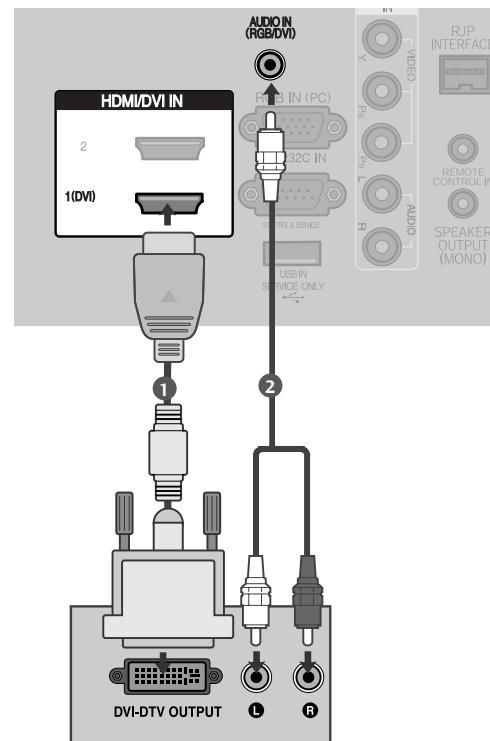

EXTERNAL EQUIPMENT SETUP

DVD SETUP

When connecting with a component cable

- 1 Connect the video outputs (Y, PB, PR) of the DVD to the **COMPONENT IN VIDEO** jacks on the TV.
- 2 Connect the audio outputs of the DVD to the **COMPONENT IN AUDIO** jacks on the TV.
- 3 Turn on the DVD player, insert a DVD.
- 4 Select **Component** input source using the **INPUT** button on the remote control.
- 5 Refer to the DVD player's manual for operating instructions.

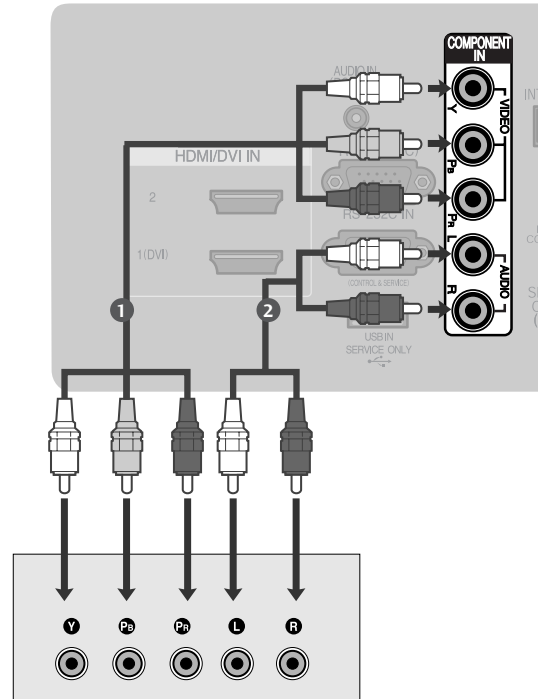

Component Input ports

To achieve better picture quality, connect a DVD player to the component input ports as shown below.

Component ports on the TV	Y	P _B	P _R
Video output ports on DVD player	Y	P _B	P _R
	Y	B-Y	R-Y
	Y	C _b	C _r
	Y	P _b	P _r

Connecting with a Euro Scart cable

- 1 Connect the Euro scart socket of the DVD to the **AV1** Euro scart socket on the TV.
- 2 Turn on the DVD player, insert a DVD.
- 3 Select **AV1** input source using the **INPUT** button on the remote control.
- 4 Refer to the DVD player's manual for operating instructions.

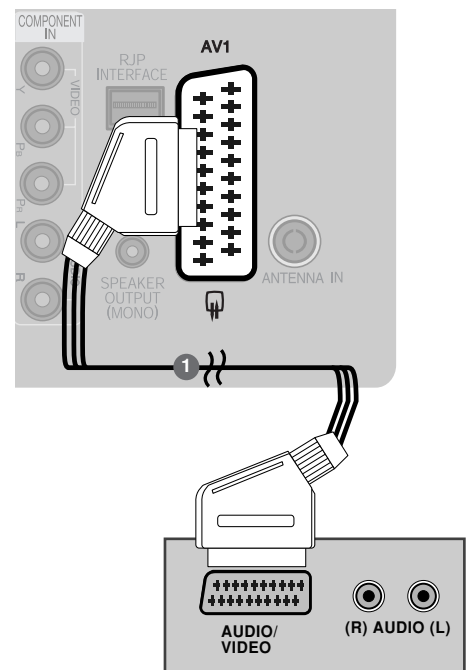

! NOTE

▶ Any Euro scart cable used must be signal shielded.

Connecting the HDMI cable

- 1 Connect the HDMI output of the DVD to the **HDMI/DVI IN 1 (DVI)** or **HDMI/DVI IN 2** jack on the TV.
- 2 Select **HDMI1** or **HDMI2** input source using the **INPUT** button on the remote control.
- 3 Refer to the DVD player's manual for operating instructions.

! NOTE

- ▶ The TV can receive video and audio signals simultaneously when using a HDMI cable.
- ▶ If the DVD does not support Auto HDMI, you must set the output resolution appropriately.

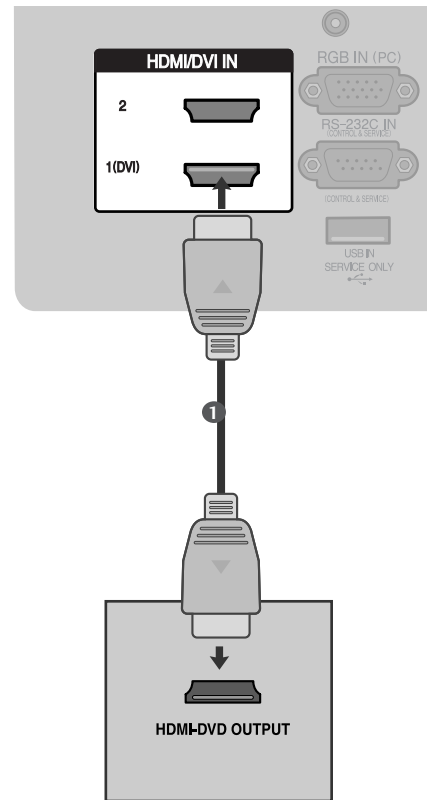

SPEAKER OUTPUT SETUP

- 1 Connect the external speaker to the **Speaker output(MONO)** jack on the TV.
- 2 Refer to the 'Speaker & Speaker Stand' manual for operating instructions.

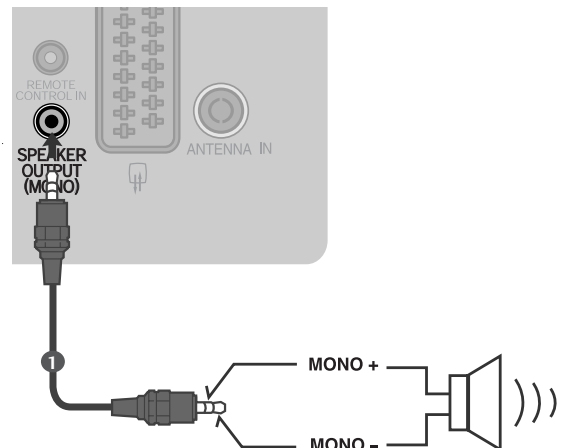

EXTERNAL EQUIPMENT SETUP

VCR SETUP

- To avoid picture noise (interference), allow adequate distance between the VCR and TV.
- If 4:3 picture format is used for an extended period the fixed images on the sides of the screen may remain visible.

When connecting with a RF Cable

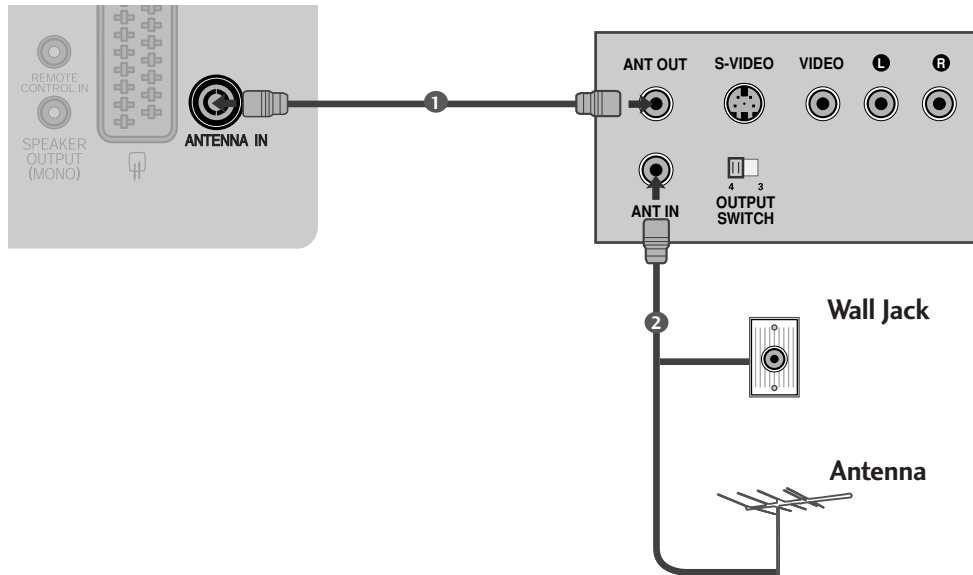

- 1 Connect the **ANT OUT** socket of the VCR to the **ANTENNA IN** socket on the TV.
- 2 Connect the antenna cable to the **ANT IN** socket of the VCR.
- 3 Press the **PLAY** button on the VCR and match the appropriate channel between the TV and VCR for viewing.

Connecting with a Euro Scart cable

- 1 Connect the Euro scart socket of the VCR to the **AV1** Euro scart socket on the TV.
- 2 Insert a video tape into the VCR and press **PLAY** on the VCR. (Refer to the VCR owner's manual.)
- 3 Select **AV1** input source using the **INPUT** button on the remote control.

! NOTE

- ▶ Any Euro scart cable used must be signal shielded.

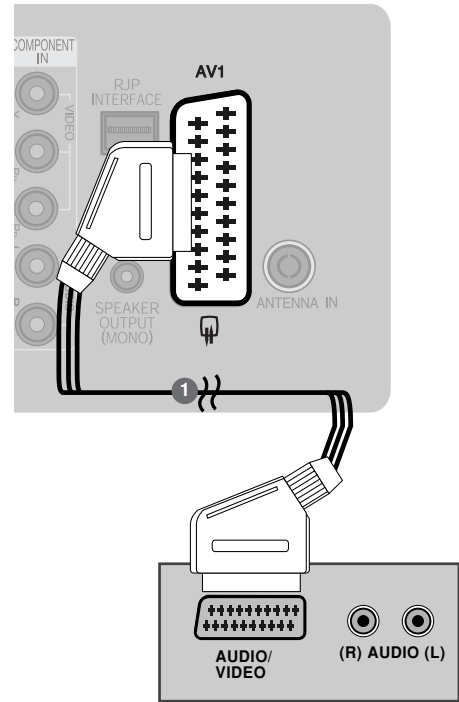

Connecting with a RCA cable

- 1 Connect the **AUDIO/VIDEO** jacks between TV and VCR. Match the jack colours (Video = yellow, Audio Left = white, and Audio Right = red)
- 2 Insert a video tape into the VCR and press **PLAY** on the VCR. (Refer to the VCR owner's manual.)
- 3 Select **AV2** input source using the **INPUT** button on the remote control.

! NOTE

- ▶ If you have a mono VCR, connect the audio cable from the VCR to the **AUDIO L/MONO** jack of the TV.

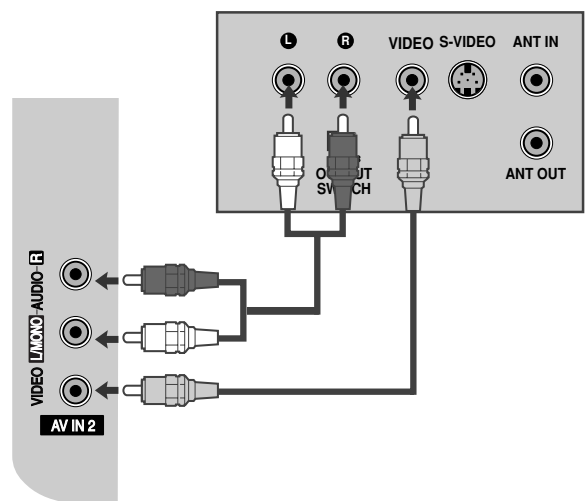

EXTERNAL EQUIPMENT SETUP

OTHER A/V SOURCE SETUP

- 1 Connect the **AUDIO/VIDEO** jacks between TV and external equipment. Match the jack colours. (Video = yellow, Audio Left = white, and Audio Right = red)
- 2 Select **AV2** input source using the **INPUT** button on the remote control.
- 3 Operate the corresponding external equipment. Refer to external equipment operating guide.

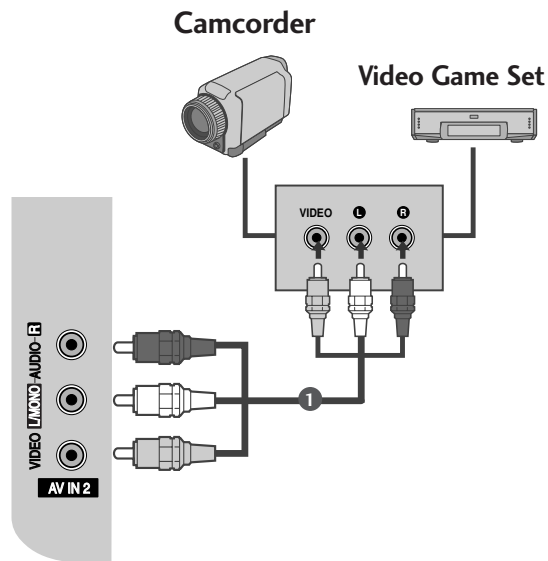

INSERTION OF CI MODULE

- To view the encrypted (pay) services in digital TV mode.
- This feature is not available in all countries.

- 1 Insert the CI Module to **PCMCIA** (Personal Computer Memory Card International Association) **CARD SLOT** of TV as shown.

For further information, see p.44

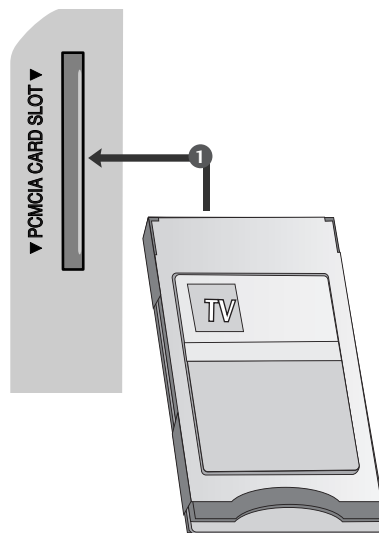

PC SETUP

This TV provides Plug and Play capability, meaning that the PC adjusts automatically to the TV's settings.

Connecting with a D-sub 15 pin cable

- 1 Connect the RGB output of the PC to the **RGB IN (PC)** jack on the TV.
- 2 Connect the PC audio output to the **AUDIO IN (RGB/DVI)** jack on the TV.
- 3 Turn on the PC and the TV
- 4 Select **RGB** input source using the **INPUT** button on the remote control.

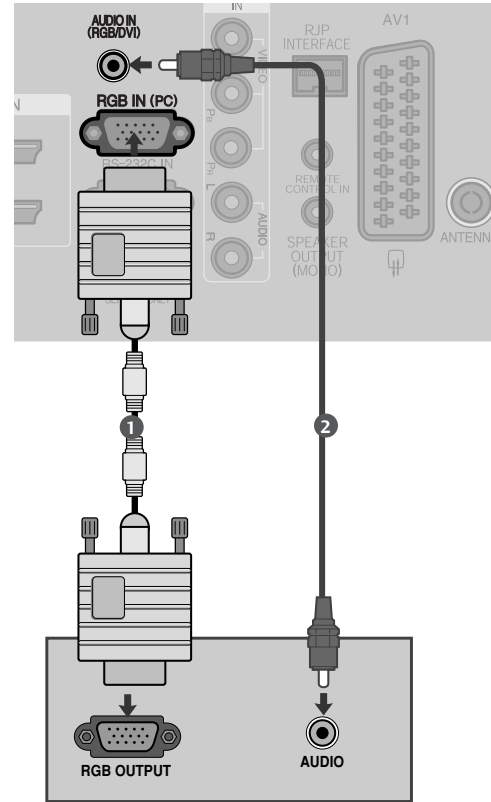

Connecting with a HDMI to DVI cable

- 1 Connect the DVI output of the PC to the **HDMI/DVI IN 1 (DVI)** jack on the TV.
- 2 Connect the PC audio output to the **AUDIO IN (RGB/DVI)** jack on the TV.
- 3 Turn on the PC and the TV.
- 4 Select **HDMI 1** input source using the **INPUT** button on the remote control.

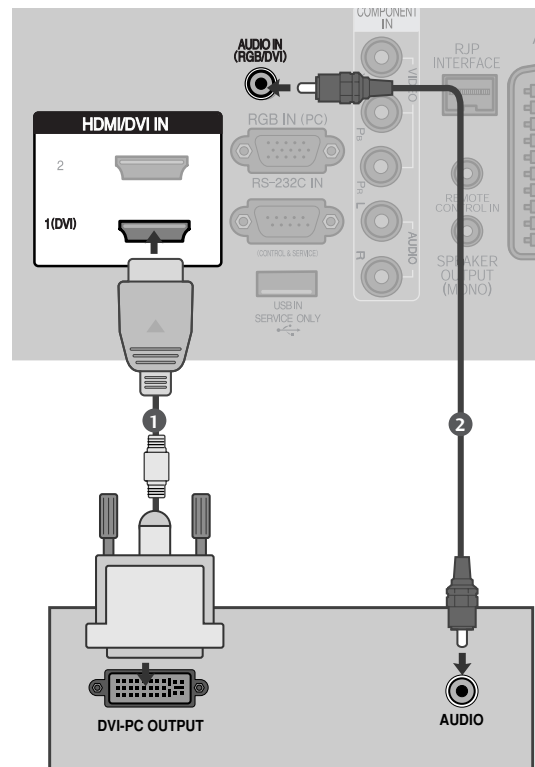

EXTERNAL EQUIPMENT SETUP

Supported Display Resolution

RGB[PC], HDMI[PC] mode

Resolution	Horizontal Frequency(kHz)	Vertical Frequency(Hz)
720x400	31.469	70.08
640x480	31.469	59.94
	37.684	75.00
800x600	37.879	60.31
	46.875	75.00
832x624	49.725	74.55
	48.363	60.00
1024x768	56.470	70.00
	60.123	75.029
	60.123	75.029
1280x768	47.78	59.87
1360x768	47.72	59.8
1366x768	47.56	59.6
1400x1050	64.744	59.948
1680x1050	62.290	59.954

* Only 22LG30**

HDMI[DTV] mode

Resolution	Horizontal Frequency(kHz)	Vertical Frequency(Hz)
640x480	31.469	59.94
	31.469	60.00
720x480	31.47	59.94
	31.50	60.00
720x576	31.25	50.00
1280x720	37.500	50
	44.96	59.94
	45.00	60.00
1920x1080	33.72	59.94
	33.75	60.00
	28.12	50.00
	27.000	24.00
	33.75	30.00
	56.25	50.00
	67.43	59.94
	67.5	60.00

! NOTE

- ▶ To enjoy vivid picture and sound, connect a PC to the TV.
- ▶ Avoid keeping a fixed image on the TV's screen for prolonged periods of time. The fixed image may become permanently imprinted on the screen; use a screen saver when possible.
- ▶ Connect the PC to the RGB (PC) or HDMI/DVI IN port of the TV; change the resolution.
- ▶ There may be interference relating to resolution, vertical pattern, contrast or brightness in PC mode. Change the PC mode to another resolution or change the refresh rate to another rate or adjust the brightness and contrast on the menu until the picture is clear. If the refresh rate of the PC graphic card can not be changed, change the PC graphic card or consult the manufacturer of the PC graphic card.
- ▶ The synchronization input waveform for Horizontal and Vertical frequencies are separate.
- ▶ Connect the signal cable from the monitor output port of the PC to the RGB (PC) port of the TV or the signal cable from the HDMI output port of the PC to the HDMI/DVI IN port on the TV.
- ▶ Connect the audio cable from the PC to the Audio input on the TV. (Audio cables are not included with the TV).
- ▶ If using a sound card, adjust PC sound as required.
- ▶ This TV uses a VESA Plug and Play Solution. The TV provides EDID data to the PC system with a DDC protocol. The PC adjusts automatically when using this TV.
- ▶ DDC protocol is preset for RGB (Analog RGB), HDMI (Digital RGB) mode.
- ▶ If required, adjust the settings for Plug and Play functionality.
- ▶ If the graphic card on the PC does not output analogue and digital RGB simultaneously, connect only one of either RGB or HDMI IN (or HDMI/DVI IN) to display the PC output on the TV.
- ▶ If the graphic card on the PC does output analogue and digital RGB simultaneously, switch the TV to either RGB or HDMI; (the other mode is set to Plug and Play automatically by the TV.)
- ▶ DOS mode may not work depending on the video card if you use a HDMI to DVI cable.
- ▶ If you use too long an RGB-PC cable, there may be interference on the screen. We recommend using under 5m of cable. This provides the best picture quality.

EXTERNAL EQUIPMENT SETUP





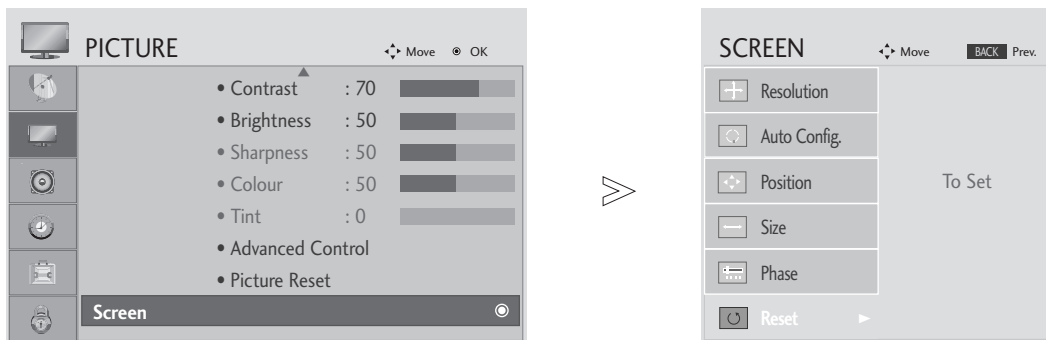

Screen Setup for PC mode

Screen Reset

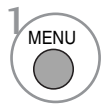
Returns to the default settings Position, Size and Phase at the factory.

This function works in the following mode : RGB[PC].

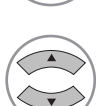

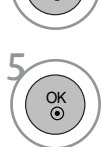
-   Select **PICTURE**.
-   Select **SCREEN**.
-   Select **Reset**.
-   Select **Yes**.
-  Run **Reset**.







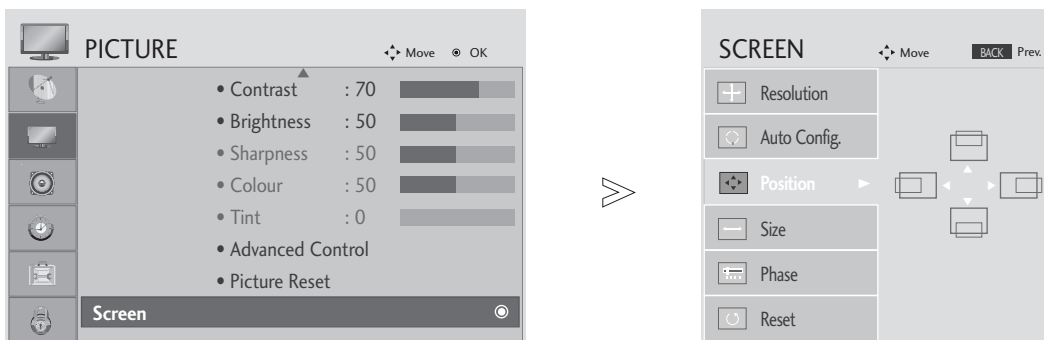

- Press the **MENU** or **EXIT** button to return to normal TV viewing.
- Press the **BACK** button to move to the previous menu screen.

Adjustment for screen Position, Size, Phase

If the picture is not clear after auto adjustment and especially if characters are still trembling, adjust the picture phase manually.

This function works in the following mode : RGB[PC].



- 1   Select **PICTURE**.
- 2   Select **SCREEN**.
- 3   Select **Position, Size or Phase**.
- 4    Make appropriate adjustments.

- Press the **MENU** or **EXIT** button to return to normal TV viewing.
- Press the **BACK** button to move to the previous menu screen.







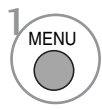

EXTERNAL EQUIPMENT SETUP

Selecting Resolution

To view a normal picture, match the resolution of RGB mode and selection of PC mode.

This function works in the following mode: RGB[PC] mode.



- 1   Select **PICTURE**.
- 2   Select **SCREEN**.
- 3   Select **Resolution**.
- 4   Select the desired resolution.

- Press the **MENU** or **EXIT** button to return to normal TV viewing.
- Press the **BACK** button to move to the previous menu screen.

Auto Configure (RGB [PC] mode only)

Automatically adjusts picture position and minimizes image instability. After adjustment, if the image is still not correct, your TV is functioning properly but needs further adjustment.

Auto configure

This function is for automatic adjustment of the screen position, clock, and phase. The displayed image will be unstable for a few seconds while the auto configuration is in progress.

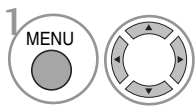
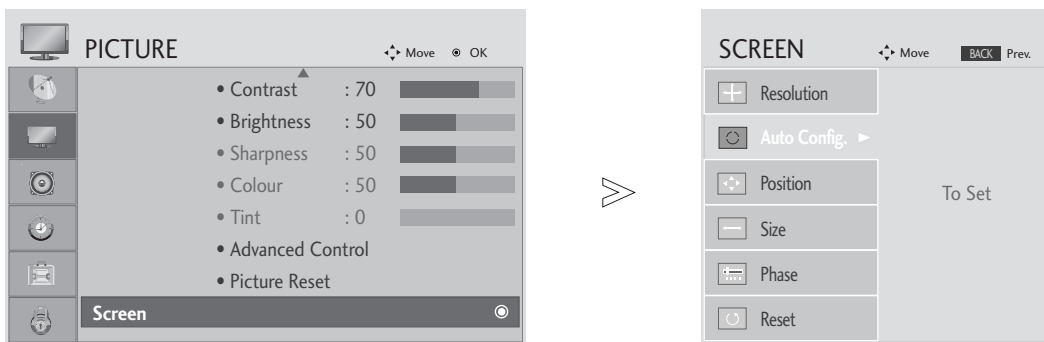

Select **PICTURE**.

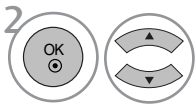

Select **SCREEN**.

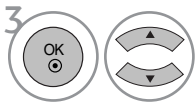

Select **Auto Config..**

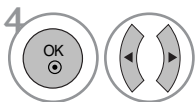

Select **Yes**.



Run **Auto Config..**

- If the position of the image is still not correct, try Auto adjustment again.
- If picture needs to be adjusted again after Auto adjustment in RGB (PC), you can adjust the **Position, Size or Phase**.

- Press the **MENU** or **EXIT** button to return to normal TV viewing.
- Press the **BACK** button to move to the previous menu screen.

WATCHING TV / PROGRAMME CONTROL

REMOTE CONTROL KEY FUNCTIONS

When using the remote control, aim it at the remote control sensor on the TV.

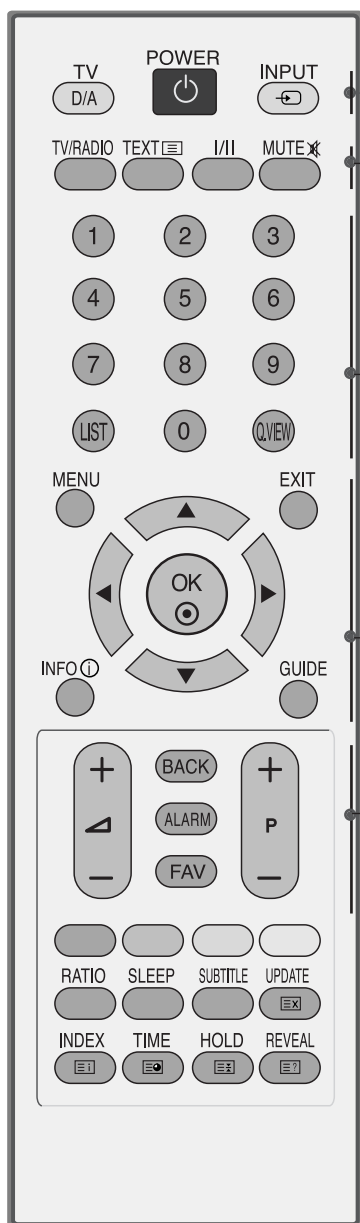

WATCHING TV / PROGRAMME CONTROL

POWER Switches the TV on from standby or off to standby.

D/A TV Selects digital or analogue mode.
Switches the TV on from standby.

INPUT External input mode rotate in regular sequence.
Switches the TV on from standby.

TV/RADIO Selects Radio or TV channel in digital mode.

I/II Selects the sound output.

MUTE Switches the sound on or off.

0~9 number button Selects a programme.
Selects numbered items in a menu.

LIST Displays the programme table.

Q.VIEW Returns to the previously viewed programme.

MENU Selects a menu.

EXIT Clears all on-screen displays and returns to TV viewing from any menu.

INFO ⓘ Shows the present screen information.

GUIDE Shows programme schedule.

THUMBSTICK (Up/Down/Left Right) Allows you to navigate the on-screen menus and adjust the system settings to your preference.

OK Accepts your selection or displays the current mode.

VOLUME UP /DOWN Adjusts the volume.

BACK Allows the user to move back one step in an interactive application, EPG or other user interaction function.

ALARM Sets the alarm function.

FAV Displays the selected favourite programme.

Programme UP/DOWN Selects a programme.



1 TELETEXT BUTTONS These buttons are used for teletext. For further details, see the 'Teletext' section.

Coloured buttons These buttons are used for teletext (on **TELETEXT** models only) or **Programme edit**.

RATIO Selects your desired picture format.
SLEEP Sets the sleep timer.
SUBTITLE Recalls your preferred subtitle in digital mode.

Installing Batteries

- Open the battery compartment cover on the back and install the batteries matching correct polarity (+with +,-with -).
- Install two 1.5V AAA batteries. Do not mix old or used batteries with new ones.
- Close cover.

WATCHING TV / PROGRAMME CONTROL

TURNING ON THE TV

- When your TV is turned on, you will be able to use its features.

- 1 Firstly, connect the power cord correctly.
At this stage, the TV switches to standby mode.
- 2 In standby mode to turn TV on, press the \odot / I, INPUT or P + - button on the TV or press the POWER, INPUT, P + - or NUMBER button on the remote control and the TV will switch on.

Initializing setup.

If the OSD (On Screen Display) is displayed on the screen after turning on the TV, you can adjust the **Language, Country, Time Zone, Auto programme tuning.**

Note:

- a. It will automatically disappear after approx. 40 seconds unless a button is pressed.
- b. Press the BACK button to change the current OSD to the previous OSD.
- c. For those countries without confirmed DTV broadcasting standards, some DTV features might not work, depending on the DTV broadcasting environment.

PROGRAMME SELECTION

- 1 Press the P + - or NUMBER buttons to select a programme number.

VOLUME ADJUSTMENT

- 1 Press the \triangleleft + - button to adjust the volume.





If you wish to switch the sound off, press the MUTE button.

You can cancel this function by pressing the MUTE, \triangleleft + -, or I/II button.

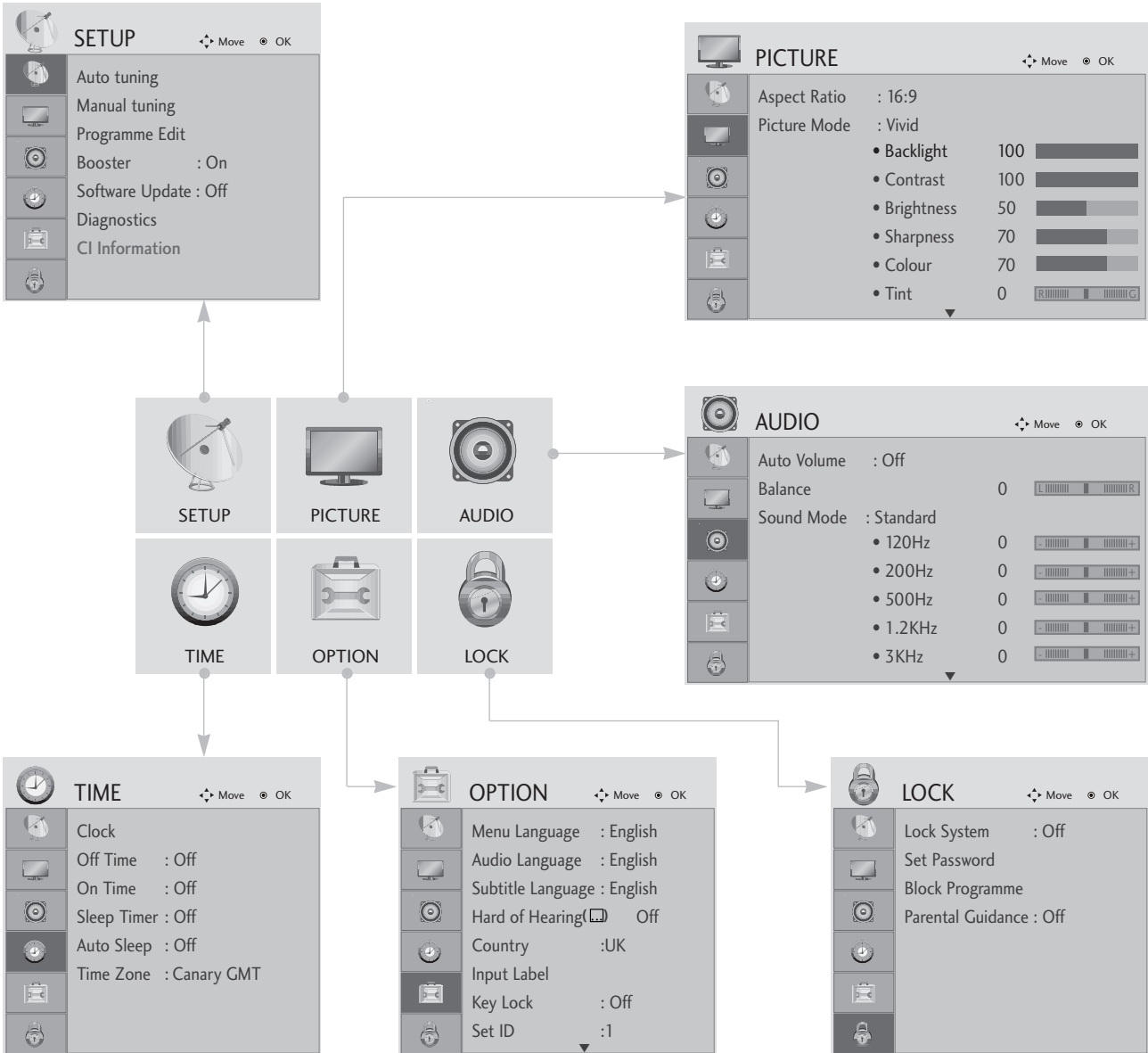
ON SCREEN MENUS SELECTION AND ADJUSTMENT

Your TV's OSD (On Screen Display) may differ slightly from what is shown in this manual.



- 1   Display each menu.
- 2   Select a menu item.
- 3  Move to the pop up menu.

- Press the **MENU** or **EXIT** button to return to normal TV viewing.
- Press the **BACK** button to move to the previous menu screen.

WATCHING TV / PROGRAMME CONTROL

AUTO PROGRAMME TUNING

Use this to automatically find and store all available programmes.

When you start auto programming in digital mode, all previously stored service information will be deleted.

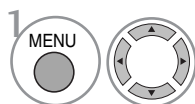
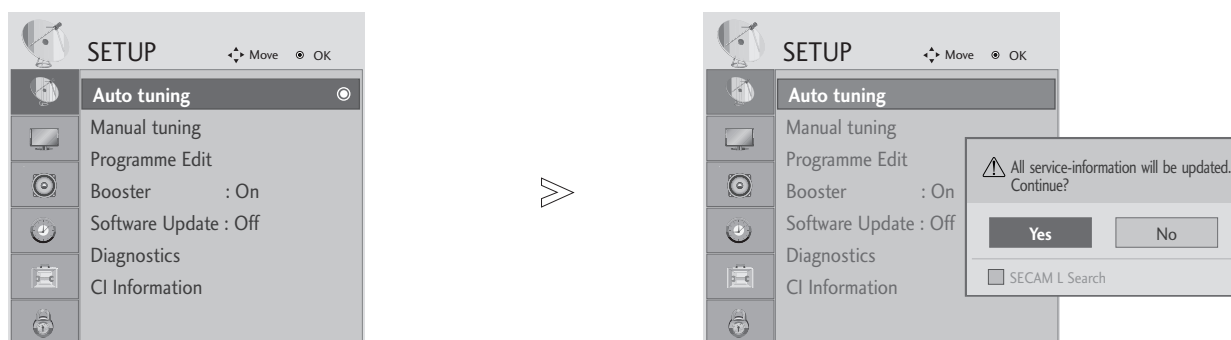

Select **SETUP**.

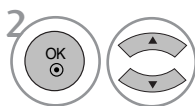

Select **Auto Tuning**.

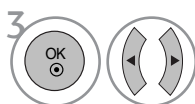

Select **Yes**.



Run **Auto tuning**.

- Use **NUMBER** buttons to input a 4-digit password in **Lock System 'On'**.
- If you wish to keep on auto tuning select **YES** using the ◀ ▶ button. Then, press the **OK** button. Otherwise select **NO**.

- Press the **MENU** or **EXIT** button to return to normal TV viewing.
- Press the **BACK** button to move to the previous menu screen.

MANUAL PROGRAMME TUNING (IN DIGITAL MODE)

Manual Tuning lets you manually add a programme to your programme list.

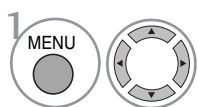
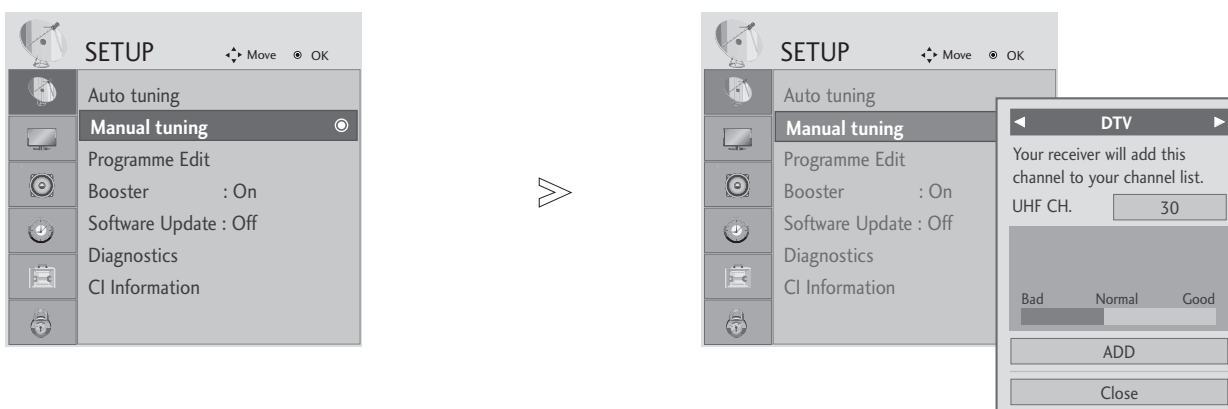

1 Select **SETUP**.

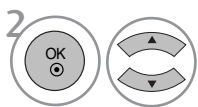

2 Select **Manual Tuning**.

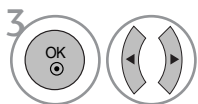

3 Select **DTV**.

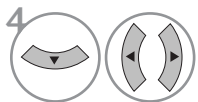

4 Select the desired channel number.

- Use **NUMBER** buttons to input a 4-digit password in **Lock System 'On'**.

- Press the **MENU** or **EXIT** button to return to normal TV viewing.
- Press the **BACK** button to move to the previous menu screen.

WATCHING TV / PROGRAMME CONTROL

MANUAL PROGRAMME TUNING (IN ANALOGUE MODE)

Manual Tuning lets you manually tune and arrange the stations in whatever order you desire.

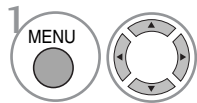
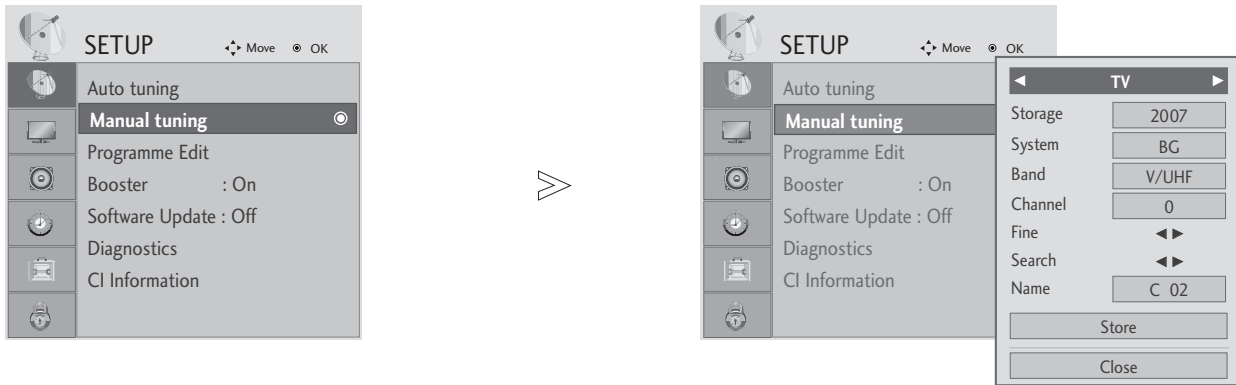

Select **SETUP**.

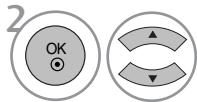

Select **Manual Tuning**.

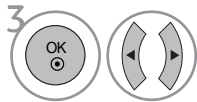

Select **TV**.

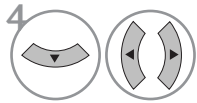

or  Select the desired programme number on.

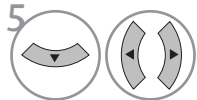

Select a TV system.

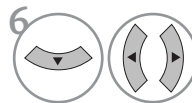

Select **V/UHF** or **Cable**.

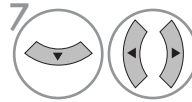

or  Select the desired channel number.

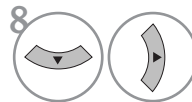

Commence searching.

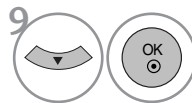















Select **Store**.

- Press the **MENU** or **EXIT** button to return to normal TV viewing.
- Press the **BACK** button to move to the previous menu screen.

- Use **NUMBER** buttons to input a 4-digit password in Lock System 'On'.
- **L** : SECAM L/L' (France)
- **BG** : PAL B/G, SECAM B/G (Europe / East Europe / Asia / New Zealand / M.East / Africa / Australia)
- **I** : PAL I/II (U.K. / Ireland / Hong Kong / South Africa)
- **DK** : PAL D/K, SECAM D/K (East Europe / China / Africa / CIS)
- To store another channel, repeat steps 4 to 9.











■ Assigning a station name

You can assign a station name with five characters to each programme number.

- | | |
|---|---|
| <p>1   Select SETUP.</p> | <p>5   Select the position and make your choice of the second character, and so on.
You can use the alphabet A to Z, the number 0 to 9, +/ -, and blank.</p> |
| <p>2   Select Manual Tuning.</p> | <p>6   Select Close.</p> |
| <p>3   Select TV.</p> | <p>7   Select Store.</p> |
| <p>4   Select Name.</p> | |

■ Fine Tuning

Normally fine tuning is only necessary if reception is poor.

- | | |
|---|--|
| <p>1   Select SETUP.</p> | <p>4  Select Fine.</p> |
| <p>2   Select Manual Tuning.</p> | <p>5  Fine tune for the best picture and sound.</p> |
| <p>3   Select TV.</p> | <p>6   Select Store.</p> |

- Press the **MENU** or **EXIT** button to return to normal TV viewing.
- Press the **BACK** button to move to the previous menu screen.

WATCHING TV / PROGRAMME CONTROL

PROGRAMME EDIT

When a programme number is skipped, it means that you will be unable to select it using P + / - button during TV viewing.

If you wish to select the skipped programme, directly enter the programme number with the NUMBER buttons or select it in the Programme edit menu

This function enables you to skip the stored programmes.

In some countries it is possible to move a programme number by using the YELLOW button only.

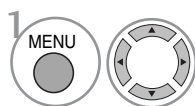
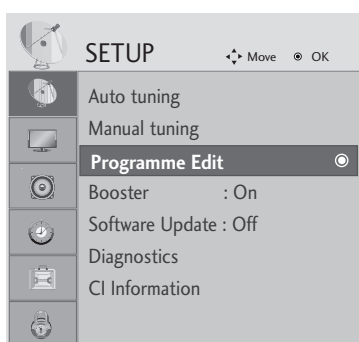

Select **SETUP**.

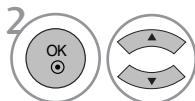

Select **Programme Edit**.



Enter the **Programme Edit**.



Select a programme to be stored or skipped.

- Use NUMBER buttons to input a 4-digit password in Lock System 'On'.

- Press the **MENU** or **EXIT** button to return to normal TV viewing.
- Press the **BACK** button to move to the previous menu screen.

(IN DTV/RADIO MODE)

■ Skipping a programme number



Select a programme number to be skipped.



Turn the skipped programme number to blue.



Release the skipped programme.

- When a programme number is skipped it means that you will be unable to select it using the P + / - button during normal TV viewing.
- If you wish to select a skipped programme, directly enter the programme number with the NUMBER buttons or select it in the programme edit or EPG.

■ Selecting favourite programme



Select your favourite programme number.

- It will automatically include the selected programme into your favourite programme list.

WATCHING TV / PROGRAMME CONTROL

IN TV MODE

This function enables you to delete or skip the stored programmes. You can also move some channels to other programme numbers.

■ Auto Sort



Start Auto Sort.

- After activating Auto Sort once, you can no longer edit programmes.

■ Deleting a programme



Select a programme number to be deleted.

- The selected programme is deleted, all the following programmes are shifted up one



Turn the deleted programme number to red.



Release the deleted programme.

■ Moving a programme



Select a programme number to be moved.



Turn the moved programme number to YELLOW.



Release the moved programme.

■ Skipping a programme number



Select a programme number to be skipped.



Turn the skipped programme number to blue.



Release the skipped programme.

- When a programme number is skipped it means that you will be unable to select it using the P + / - button during normal TV viewing.
- If you wish to select a skipped programme, directly enter the programme number with the NUMBER buttons or select it in the programme edit or EPG.

■ Selecting a Favourite Programme









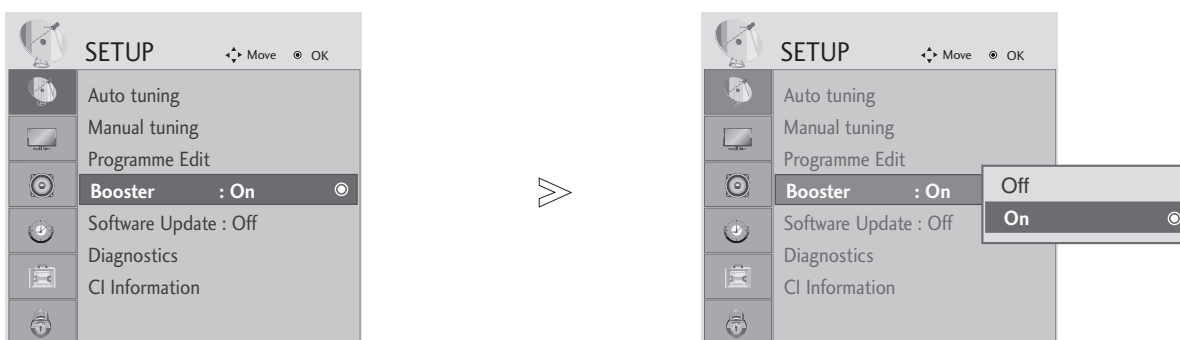

Select your favourite programme number.

- The selected programme will be added to the favourite programme list.

BOOSTER (IN DIGITAL MODE ONLY)

If reception is poor, select **Booster** to **On**.
When the signal is strong, select "Off".

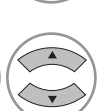

-   Select **SETUP**.
-   Select **Booster**.
-   Select **On** or **Off**.
-  Save.

- Press the **MENU** or **EXIT** button to return to normal TV viewing.
- Press the **BACK** button to move to the previous menu screen.

WATCHING TV / PROGRAMME CONTROL

SOFTWARE UPDATE

Software Update means software can be downloaded through the digital terrestrial broadcasting system.

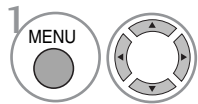
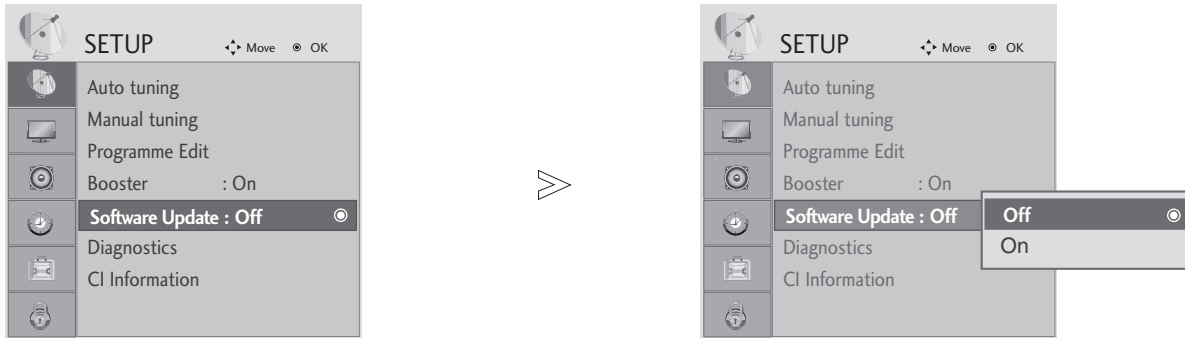

Select SETUP.

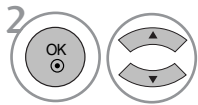

Select Software Update.

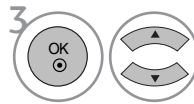

Select On or Off.

• If you select On, a user confirm message box will be displayed to notify that new software is found.



Save.

* When setting “Software Update”

Occasionally, a transmission of updated digital software information will result in the following menu on the TV screen.



Select the YES using the ◀▶ button and when you see the following picture.



After Software Update is completed, the System takes about one minute to restart.

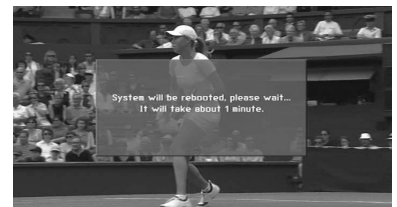

- During Progress of a Software Update, please note the following:

- Power to the TV must not be interrupted.
- The TV must not be switched off.
- The antenna must not be disconnected.
- After Software Update, you can confirm the updated software version in Diagnostics menu.





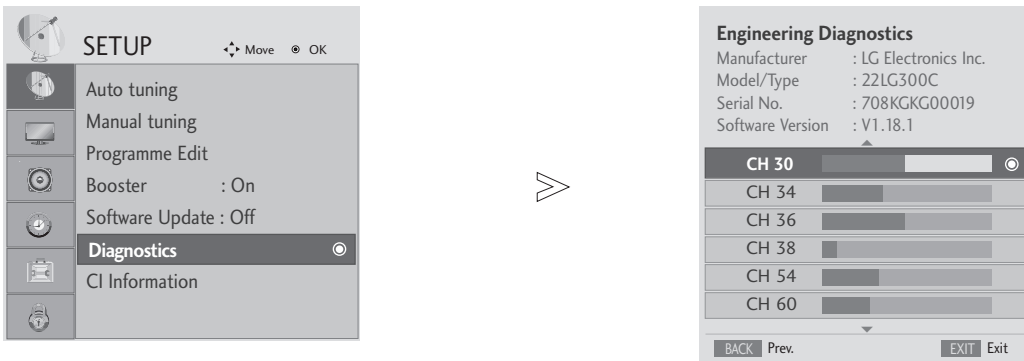

DIAGNOSTICS (IN DIGITAL MODE ONLY)

This function enables you to view information on the Manufacturer, Model/Type, Serial Number and Software Version.

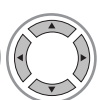
This displays the information and signal strength of the tuned MUX.

This displays the signal information and service name of the selected MUX.



-   Select **SETUP**.
-   Select **Diagnostics**.
-  Display Manufacturer, Model/Type, Serial Number and Software Version.
-   Display the information of Channel.

- Press the **MENU** or **EXIT** button to return to normal TV viewing.
- Press the **BACK** button to move to the previous menu screen.

WATCHING TV / PROGRAMME CONTROL

CI [COMMON INTERFACE] INFORMATION

This function enables you to watch some encrypted services (pay services). If you remove the CI Module, you cannot watch pay services.

When the module is inserted into the CI slot, you can access the module menu.

To purchase a module and smart card, contact your dealer. Do not repeatedly insert or remove a CAM module from the TV. This may cause a malfunction. When the TV is turned on after inserting a CI Module, you may not have any sound output.

This may be incompatible with the CI module and smart card.

CI (Common Interface) functions may not be possible depending upon the country broadcasting circumstances.

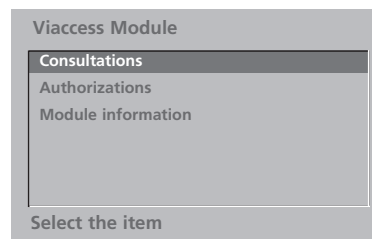
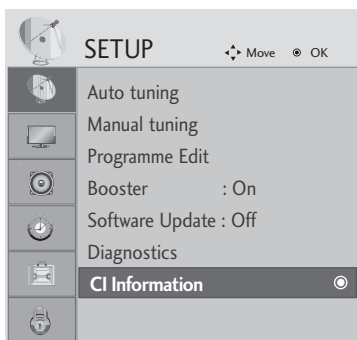

- This OSD is only for illustration and the menu options and screen format will vary according to the Digital pay services provider.
- It is possible for you to change CI (Common Interface) menu screen and service by consulting your dealer.



Select **SETUP**.



Select **CI Information**.



Select the desired item: Module information, smart card information, language, or software download etc.



Save.

- Press the **MENU** or **EXIT** button to return to normal TV viewing.
- Press the **BACK** button to move to the previous menu screen.

SELECTING THE PROGRAMME TABLE

You can check which programmes are stored in the memory by displaying the programme table.

 Displayed when the Locked Programme.

■ Displaying programme LIST



display the PROGRAMME LIST.

- You may find some blue programmes. These have been set up to be skipped by auto programming or in the programme edit mode.
- Some programmes with the channel number shown in the programme LIST indicate there is no station name assigned.

■ Selecting a programme in the programme list



Select a programme.



Switch to the chosen programme number.



From the programme you are currently watching, the mode will change from TV to DTV to Radio.

■ Displaying the favourite programme table









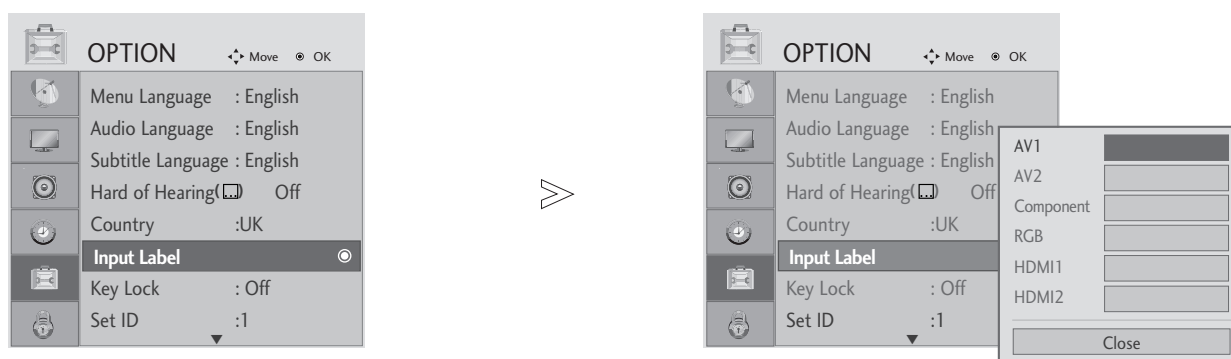

Display the Favourite Programme table.

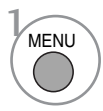
WATCHING TV / PROGRAMME CONTROL

INPUT LABEL

Selects a label for each input source.



-   Select **OPTION**.
-    Select **Input Label**.
-   Select the source.
-  Select the label.

- Press the **MENU** or **EXIT** button to return to normal TV viewing.
- Press the **BACK** button to move to the previous menu screen.

EPG (ELECTRONIC PROGRAMME GUIDE) (IN DIGITAL MODE)

This system has an Electronic Programme Guide (EPG) to help your navigation through all the possible viewing options.

The EPG supplies information such as programme listings, start and end times for all available services. In addition, detailed information about the programme is often available in the EPG (the availability and amount of these programme details will vary, depending on the particular broadcaster).

This function can be used only when the EPG information is broadcasted by broadcasting companies.

The EPG displays the programme description for next 8 days.

Switch on/off EPG



1 Switch on or off EPG.

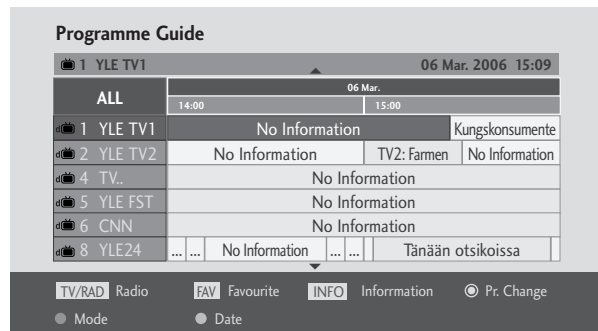

Select a programme



1 or Select desired programme.



2 Display the selected programme.

Button Function in NOW/NEXT Guide Mode



Change EPG mode.



Change to the selected programme.



Select NOW or NEXT Programme.



Select the Broadcast Programme.

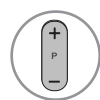

Page Up/Down.



or Switch off EPG.

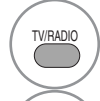



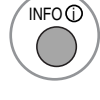





Select TV or RADIO Programme.





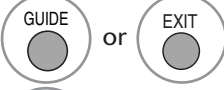

The detail information on or off.

EPG (ELECTRONIC PROGRAMME GUIDE) (IN DIGITAL MODE)

Button Function in 8 Day Guide Mode

- | | |
|---|---|
|  RED Change EPG mode. |  Select the Broadcast Programme. |
|  GREEN Enter Date setting mode. |  Page Up/Down. |
|  OK Change to the selected programme. |  GUIDE or EXIT Switch off EPG. |
|  Select NOW or NEXT Programme. |  TV/RADIO Select TV or RADIO Programme. |
| |  INFO The detail information on or off. |

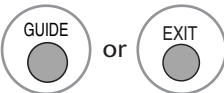
Button Function in Date Change Mode

- | | |
|--|--|
|  GREEN Switch off Date setting mode. |  Switch off Date setting mode. |
|  OK Change to the selected date. |  GUIDE or EXIT Switch off EPG. |
|  Select a date. | |

PICTURE CONTROL

PICTURE SIZE (ASPECT RATIO) CONTROL

You can watch the screen in various picture formats; 16:9, Just Scan, Original, 4:3, 14:9 and Zoom1/2.

If a fixed image is displayed on the screen for a long time, that fixed image may become imprinted on the screen and remain visible.

You can adjust the enlarge proportion using ▲▼ button.

This function works in the following signal.

-
- 1 Press the **RATIO** button repeatedly to select the desired picture format.
You can also adjust **Aspect Ratio** in the **PICTURE** menu.
-

• 16:9

The following selection will allow you to adjust the picture horizontally, in linear proportion, to fill the entire screen (useful for viewing 4:3 formatted DVDs).



• 4:3

The following selection will allow you to view a picture with an original 4:3 aspect ratio, grey bars will appear on both the left and right of the screen.



PICTURE CONTROL

- **Original**

When your TV receives a wide screen signal it will automatically change to the picture format broadcast.



- **14:9**

You can view a picture format of 14:9 or a general TV programme in the 14:9 mode. The 14:9 screen is viewed in the same way as in 4:3, but is magnified to the left and right.



- **Zoom 1**

The following selection will allow you to view the picture without any alteration, while filling the entire screen. However, the top and bottom of the picture will be cropped.



- **Zoom 2**

Choose Zoom 2 when you wish the picture to be altered, both horizontally extended and vertically cropped. The picture adopting a compromise between alteration and screen coverage.



- **Just Scan**

Following Selection will lead to you view the picture of best quality without loss of original picture in high resolution image.

Note: If there are interference in original picture, you can view interference at the edge.



! NOTE

- ▶ You can only select 16:9 (Wide), Original, 4:3, 14:9, Zoom 1/2 in Component (under 720p) mode.
- ▶ You can only select 4:3, 16:9 (Wide) in RGB/HDMI[PC] mode only.
- ▶ In HDMI/Component (over 720p) mode, Just Scan is available.
- ▶ You can only select Original in UK digital teletext (MHEG-5).

PRESET PICTURE SETTINGS

Picture Mode-Preset

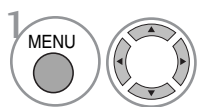
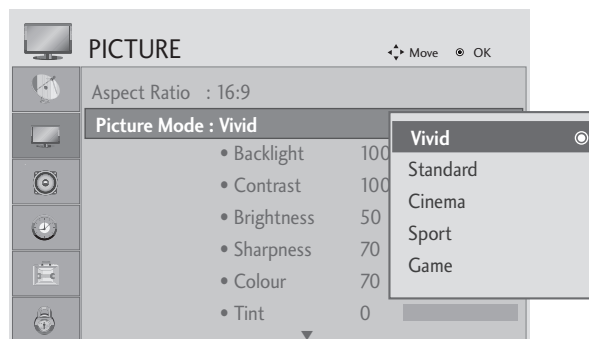
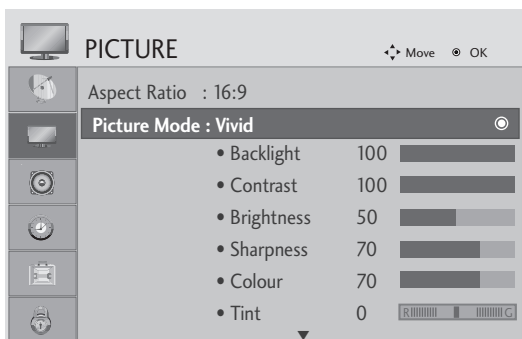

Select **PICTURE**.

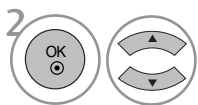

Select **Picture Mode**.

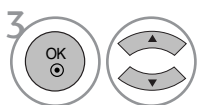

Select desired picture value.



• **Picture Mode** adjusts the TV for the best picture appearance. Select the preset value in the **Picture Mode** menu based on the programme category.





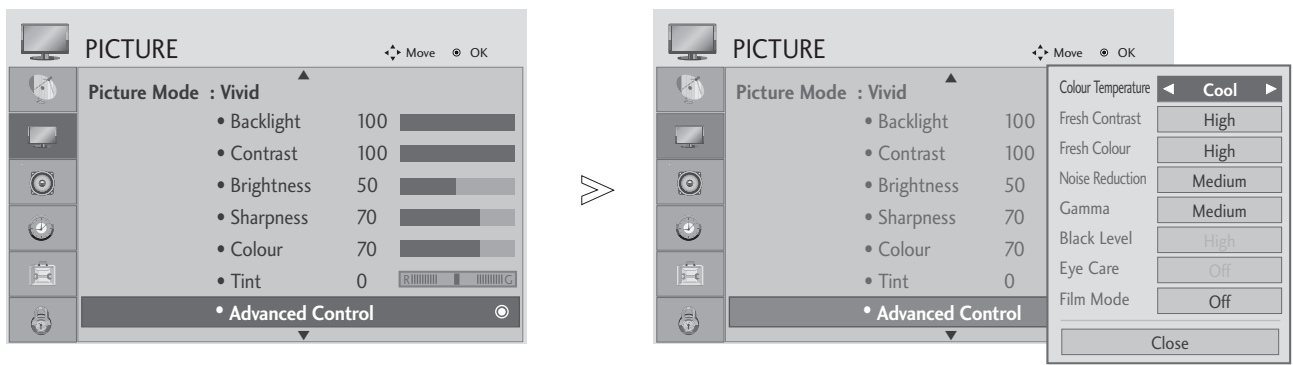

- Press the **MENU** or **EXIT** button to return to normal TV viewing.
- Press the **BACK** button to move to the previous menu screen.

PICTURE CONTROL

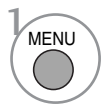
Auto Colour Tone Control (Warm/Medium/Cool)

Choose one of three automatic colour adjustments. Set to warm to enhance hotter colours such as red, or set to cool to see less intense colours with more blue.











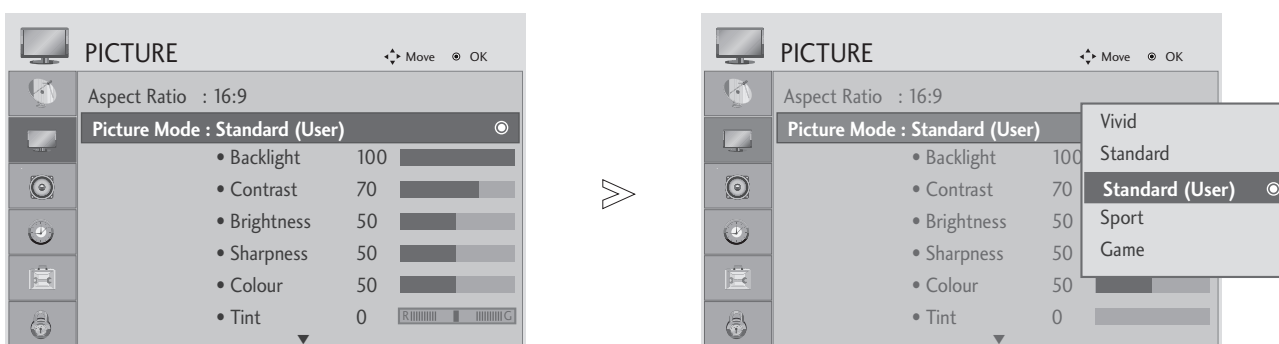

-   Select **PICTURE**.
-   Select **Advanced Control**.
-   Select **Colour Temperature**.
-  Select either **Cool, Medium or Warm**.

- Press the **MENU** or **EXIT** button to return to normal TV viewing.
- Press the **BACK** button to move to the previous menu screen.

MANUAL PICTURE ADJUSTMENT

Picture Mode-User option



-   Select **PICTURE**.
-   Select **Picture Mode**.
-   Select desired picture value.
-   Select **Backlight, Contrast, Brightness, Sharpness, Clolour or Tint**.
-   Make appropriate adjustments.

- Press the **MENU** or **EXIT** button to return to normal TV viewing.
- Press the **BACK** button to move to the previous menu screen.

! NOTE

- ▶ You can not adjust colour, sharpness and tint in the RGB-PC mode.

PICTURE CONTROL

PICTURE IMPROVEMENT TECHNOLOGY

Fresh Contrast

Optimizes the contrast automatically according to the brightness of the reflection.

Fresh Colour

Adjusts the colour of the reflection automatically to reproduce as close as possible natural colours.





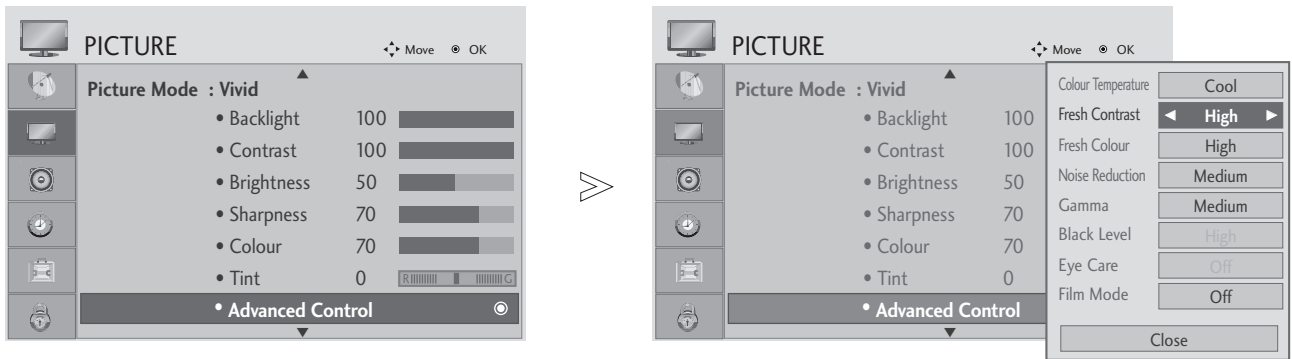

Noise Reduction

Removes interference up to the point where it does not damage the original picture.

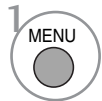
Gamma

High gamma values display whitish images and low gamma values display high contrast images.



-   Select PICTURE.
-   Select Advanced Control.
-   Select Fresh Contrast, Fresh Colour, Noise Reduction or Gamma.
-  Select your desired Source.





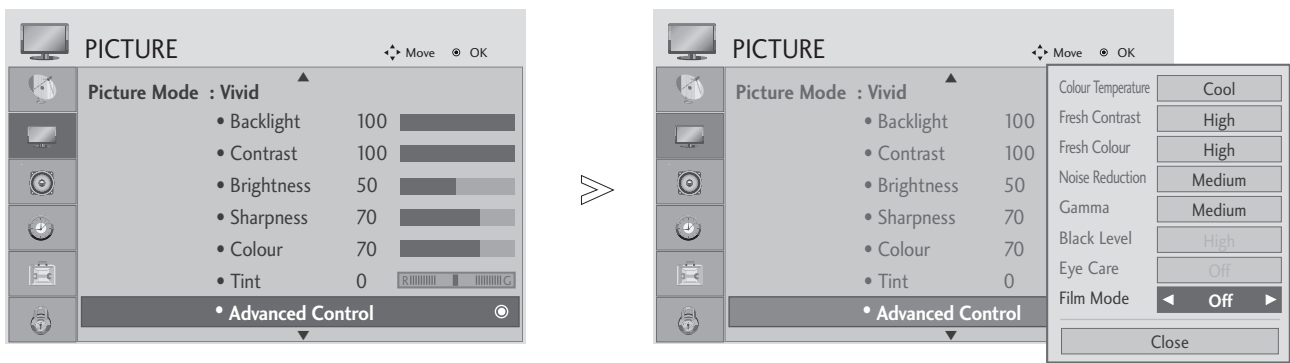

- Press the MENU or EXIT button to return to normal TV viewing.
- Press the BACK button to move to the previous menu screen.

ADVANCED - FILM MODE

To set the TV up for the best picture quality for viewing films.

This feature operates only in TV, AV and Component 480i/576i/1080i mode.



- 1   Select **PICTURE**.
- 2   Select **Advanced Control**.
- 3   Select **Film Mode**.
- 4  Select **On or Off**.

- Press the **MENU** or **EXIT** button to return to normal TV viewing.
- Press the **BACK** button to move to the previous menu screen.





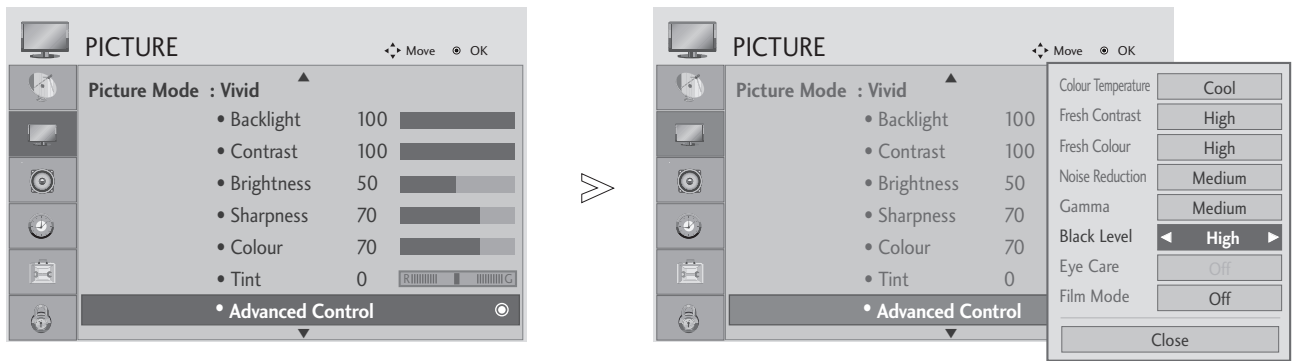

PICTURE CONTROL

ADVANCED - BLACK(DARKNESS) LEVEL

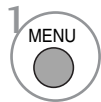
When you view a film this function adjusts the TV to best picture quality.

This function works in the following mode: AV (NTSC-M), HDMI or Component.



- 1   Select **PICTURE**.
- 2   Select **Advanced Control**.
- 3   Select **Black Level**.
- 4  Select **Low or High**.





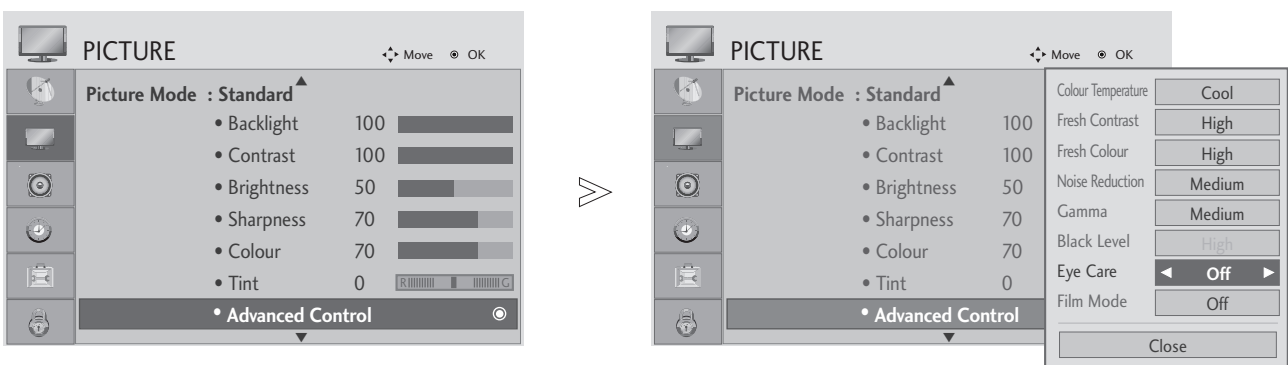

- **Low** : The reflection of the screen gets darker.
- **High** : The reflection of the screen gets brighter.
- **Auto** : Realizing the black level of the screen and set it to High or Low automatically.

- Press the **MENU** or **EXIT** button to return to normal TV viewing.
- Press the **BACK** button to move to the previous menu screen.

EYE CARE

It helps you adjust brightness to prevent dazzling when the screen is too bright.



- 1   Select **PICTURE**.
- 2   Select **Advanced Control**.
- 3   Select **Eye Care**.
- 4  Select **On or Off**.





- Press the **MENU** or **EXIT** button to return to normal TV viewing.
- Press the **BACK** button to move to the previous menu screen.

PICTURE CONTROL

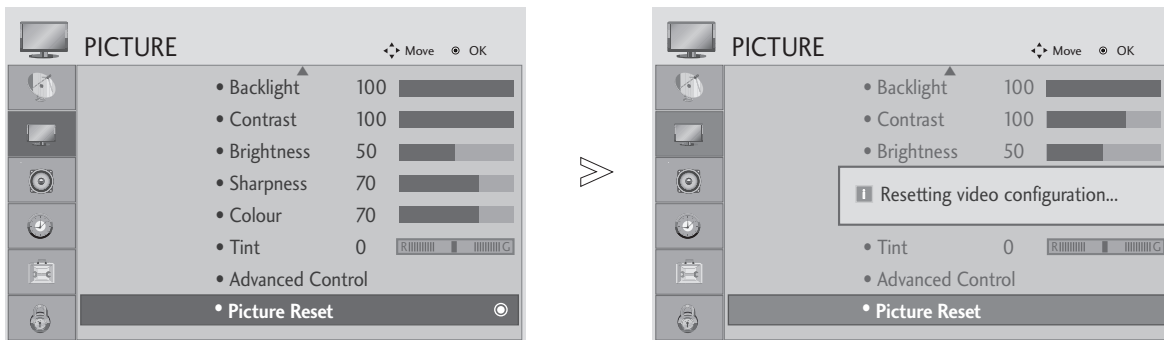
PICTURE RESET

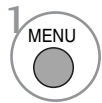
Settings of the selected picture modes return to the default factory settings.



-   Select **PICTURE**.
-   Select **Picture Reset**.
-  Initialize the adjusted value.





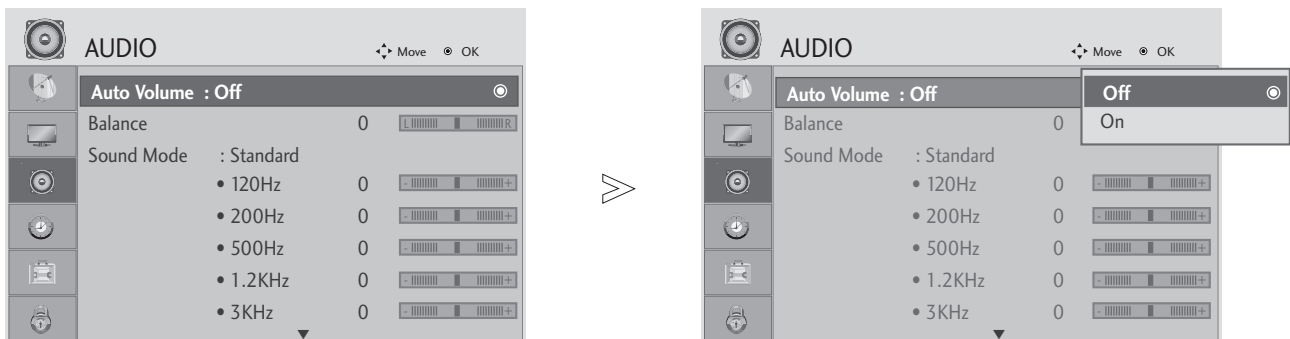

- Press the **MENU** or **EXIT** button to return to normal TV viewing.
- Press the **BACK** button to move to the previous menu screen.

SOUND & LANGUAGE CONTROL

AUTO VOLUME LEVELER

AVL automatically remains on the same level of volume if you change programmes.



-   Select **AUDIO**.
-   Select **Auto Volume**.
-   Select **On** or **Off**.

- Press the **MENU** or **EXIT** button to return to normal TV viewing.
- Press the **BACK** button to move to the previous menu screen.

SOUND & LANGUAGE CONTROL

PRESET SOUND SETTINGS-SOUND MODE

You can select your preferred sound setting; SRS TruSurround XT or Clear Voice, Standard, Music, Cinema, Sport or Game and you can also adjust the frequency of the equalizer.

Sound Mode lets you enjoy the best sound without any Special adjustment as the TV sets the appropriate sound options based on the programme content.

SRS TruSurround XT or Clear Voice, Standard, Music, Cinema, Sport and Game are preset for optimum sound quality at the factory.

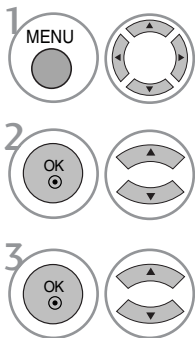
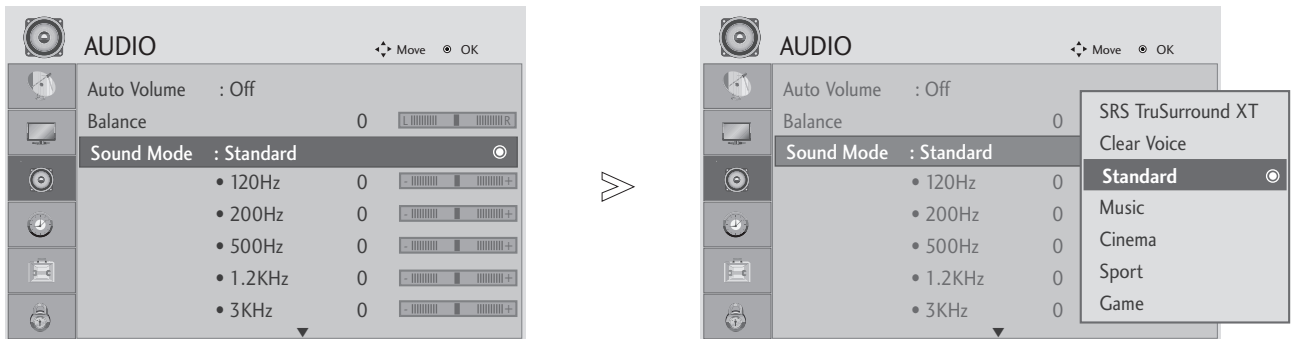

1 Select **AUDIO**.

2 Select **Sound Mode**.

3 Select **SRS TruSurround XT** or **Clear Voice**, **Standard**, **Music**, **Cinema**, **Sport** or **Game**.

• If you select **Clear Voice**, **SRS TruSurround XT** feature will not work.

- Press the **MENU** or **EXIT** button to return to normal TV viewing.
- Press the **BACK** button to move to the previous menu screen.



are a trademark of SRS Labs, Inc.

▶ TruSurround XT and TruSurround HD technology is incorporated under license from SRS Labs, Inc.

SOUND SETTING ADJUSTMENT -USER MODE

Adjusting the audio equalizer.

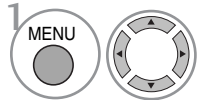
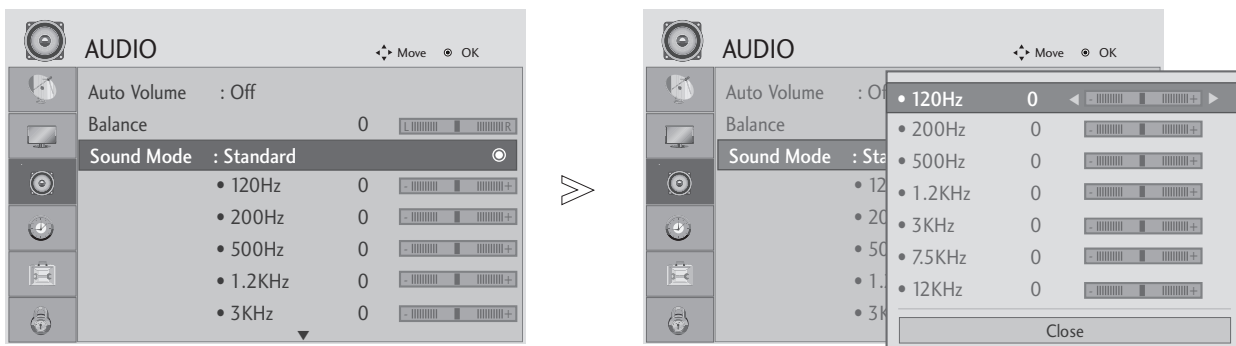

1 Select **AUDIO**.

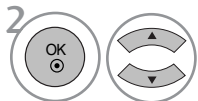

2 Select **Sound Mode**.

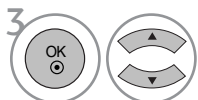

3 Select **SRS TruSurround XT or Clear Voice, Standard, Music, Cinema, Sport or Game**.

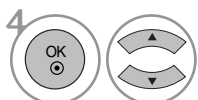

4 Select a frequency band.

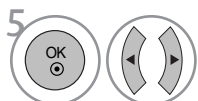

5 Set the desired sound level.





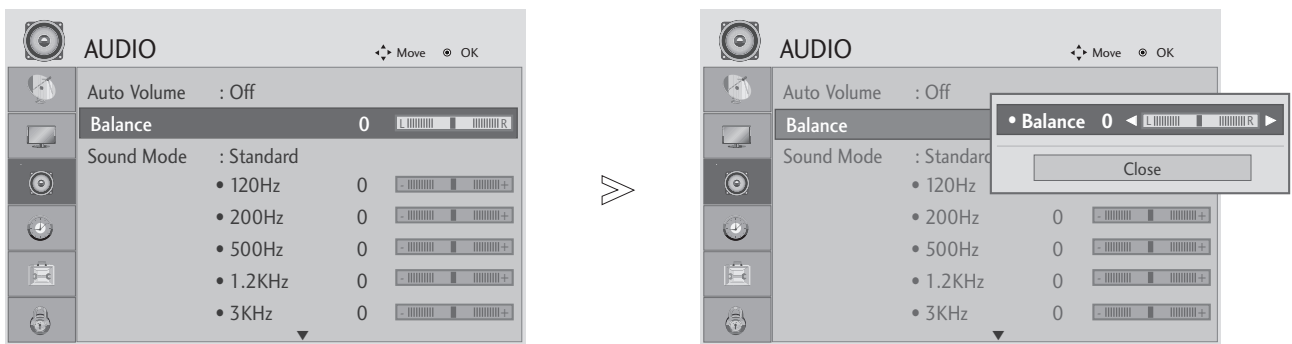

- Press the **MENU** or **EXIT** button to return to normal TV viewing.
- Press the **BACK** button to move to the previous menu screen.

SOUND & LANGUAGE CONTROL

BALANCE

You can adjust the sound balance of the speakers to preferred levels.







-   Select **AUDIO**.
-   Select **Balance**.
-   Make desired adjustment.

- Press the **MENU** or **EXIT** button to return to normal TV viewing.
- Press the **BACK** button to move to the previous menu screen.

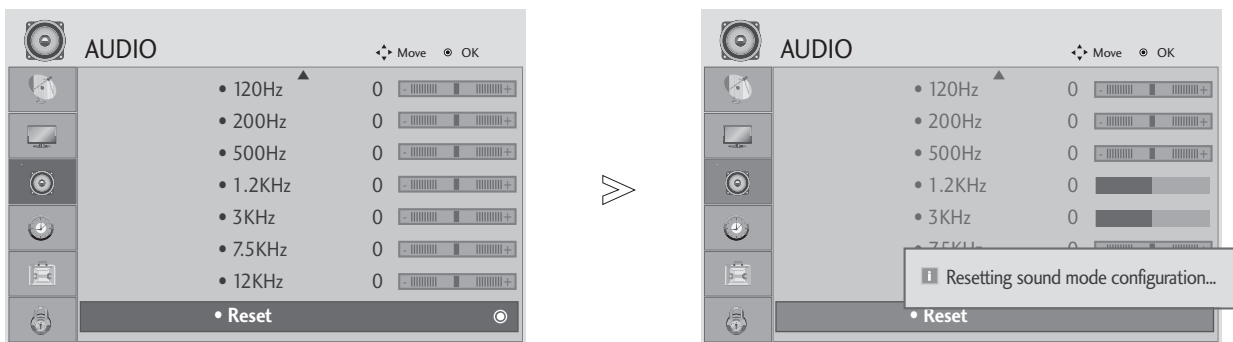
AUDIO RESET

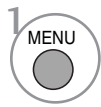
Settings of the selected Sound Mode return to the default factory settings.

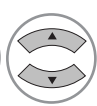

-   Select **AUDIO**.
-   Select **Reset**.
-  Initialize the adjusted value.

- Press the **MENU** or **EXIT** button to return to normal TV viewing.
- Press the **BACK** button to move to the previous menu screen.

SOUND & LANGUAGE CONTROL

I/II

Stereo/Dual Reception (In Analogue Mode Only)

When a programme is selected, the sound information for the station appears after the programme number and station name disappear.

Broadcast	On Screen Display
Mono	MONO
Stereo	STEREO
Dual	DUAL I, DUAL II, DUAL I+II

■ Mono sound selection

If the stereo signal is weak in stereo reception, you can switch to mono by pressing the I/II button twice. In mono reception, the depth of sound is improved. To switch back to stereo, press the I/II button twice again.

■ Language selection for dual language broadcast

If a programme can be received in two languages (dual language), you can switch to DUAL I, DUAL II or DUAL I+II by pressing the I/II button repeatedly..

- DUAL I Sends the primary broadcast language to the loudspeakers.
- DUAL II Sends the secondary broadcast language to the loudspeakers.
- DUAL I+II Sends a separate language to each loudspeaker.

NICAM Reception (In Analogue Mode Only)

If the TV is equipped with a receiver for NICAM reception, high quality NICAM (Near Instantaneous Companding Audio Multiplex) digital sound can be received.

Sound output can be selected according to the type of received broadcast as follows by pressing the I/II button repeatedly.

-
- 1 When **NICAM mono** is received, you can select **NICAM MONO** or **FM MONO**.
 - 2 When **NICAM stereo** is received, you can select **NICAM STEREO** or **FM MONO**.
If the stereo signal is weak, switch to **FM mono**.
 - 3 When **NICAM dual** is received, you can select **NICAM DUAL I**, **NICAM DUAL II** or **NICAM DUAL I+II** or **FM MONO**.
-

Speaker Sound Output Selection

In AV, Component, RGB and HDMI mode, you can select output sound for the left and right loudspeakers.

Repeatedly press the I/II button to select the sound output.

L+R: Audio signal from audio L input is sent to the left loudspeaker and audio signal from audio R input is sent to the right loudspeaker.

L+L: Audio signal from audio L input is sent to left and right loudspeakers.

R+R: Audio signal from audio R input is sent to left and right loudspeakers.

SOUND & LANGUAGE CONTROL

ON-SCREEN MENU LANGUAGE / COUNTRY SELECTION

The installation guide menu appears on the TV screen when it is switched on for the first time.

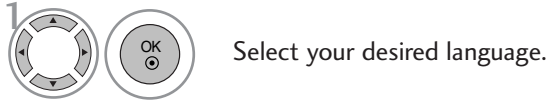

* If you want to change Language/ Country selection

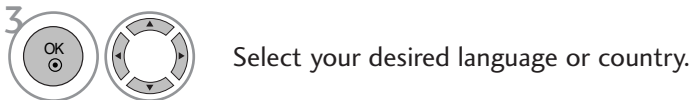

- Press the **MENU** or **EXIT** button to return to normal TV viewing.
- Press the **BACK** button to move to the previous menu screen.

! NOTE

- ▶ If you do not finish the set-up Installation Guide by pressing **EXIT** or **BACK** or if you time out on the OSD (On Screen Display) the installation menu will continuously appear until the set up is completed whenever the TV is switched on
- ▶ If you select the wrong local country, teletext may not appear correctly on the screen and some problems may occur during teletext operation.
- ▶ The CI (Common Interface) function may not be applied based on country broadcasting circumstances.
- ▶ DTV mode control buttons may not function based on country broadcasting circumstances.
- ▶ In country that Digital broadcasting regulation isn't fixed, some DTV function may not work depending on digital broadcasting circumstances.

LANGUAGE SELECTION (IN DIGITAL MODE ONLY)

The Audio function allows selection of a preferred language.

If audio data in a selected language is not broadcast, the default language audio will be played.

Use the Subtitle function when two or more subtitle languages are broadcast. If subtitle data in a selected language is not broadcast, the default language subtitle will be displayed.

When the languages you selected as the primary for Audio Language and Subtitle Language are not supported, you can select language in secondary category.

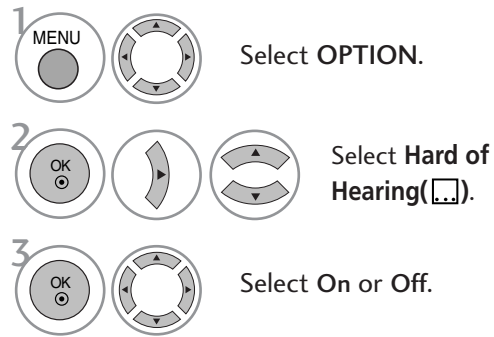
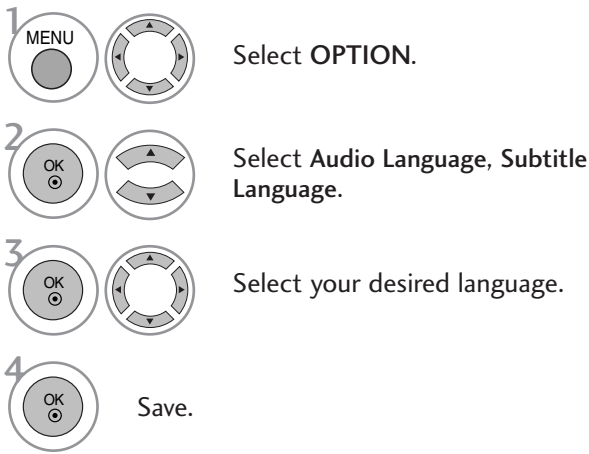

- Press the **BACK** button to move to the previous menu screen.

< Audio Language Selection >

- ▶ When two or more audio languages are broadcast, you can select the audio language.

< Subtitle Language Selection >

- ▶ When two or more subtitle languages are broadcast, you can select the subtitle language with the **SUBTITLE** button on the remote control.
- ▶ Press the **▲ ▼ ◀ ▶** button to select a subtitle language.

- The audio/subtitles can be displayed in a simpler form with 1 to 3 characters broadcast by the service provider.
- When you select supplementary Audio (Audio for “Visual/Hearing Impaired”) the TV may output a part of the Main audio.

Audio Language OSD Information

Display	Status
N.A	Not Available
	MPEG Audio
	Dolby Digital Audio
	Audio for “Visual Impaired”
	Audio for “Hearing Impaired”

Subtitle Language OSD Information

Display	Status
N.A	Not Available
	Teletext Subtitle
	Subtitle for “Hard of Hearing”

TIME SETTING

CLOCK SETUP





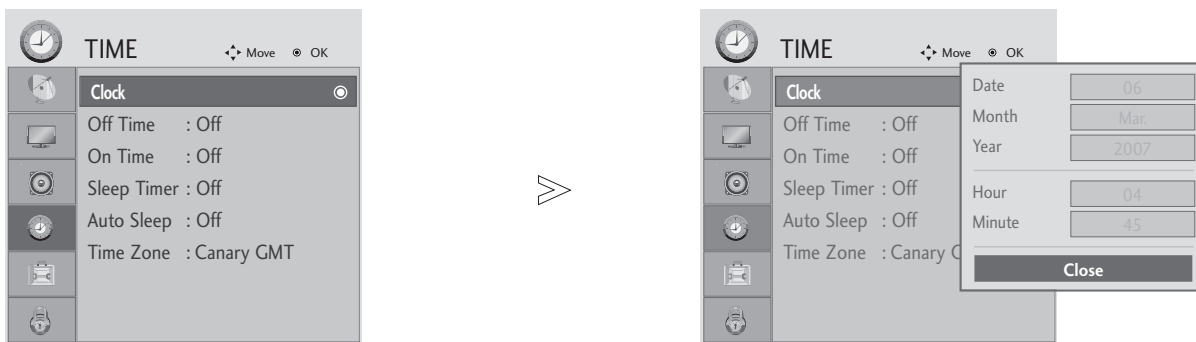

When you enter '1105' as password while the Clock Setup OSD is displayed, the OSD is enabled to set manually. If it is not manually set as shown above, the clock is set automatically when receiving a digital signal.

This auto set-time function is not available anymore after you set time manually once. You have to do 'Factory Reset' if you want to use this function again.

However, when the TV operates connected to the Interactive system, it is preemptively set with the time information sent from the system, and the manual setting and the automatic DTV setting cannot be done.

You must set the time correctly before using on/off timer function.



-   Select **TIME**.
-   Select **Clock**.
-   Select either the year, date, or time option.
-  Set the year, date, and time options.

- Press the **MENU** or **EXIT** button to return to normal TV viewing.
- Press the **BACK** button to move to the previous menu screen.

AUTO ON/OFF TIMER SETTING

The Off time function automatically switches the TV to standby at a preset time. Two hours after the TV is switched on by the on time function it will automatically switch back to standby mode unless a button has been pressed.

The Off time function overrides the On timer function if both are set to the same time. The TV must be in standby mode for the On timer to work.

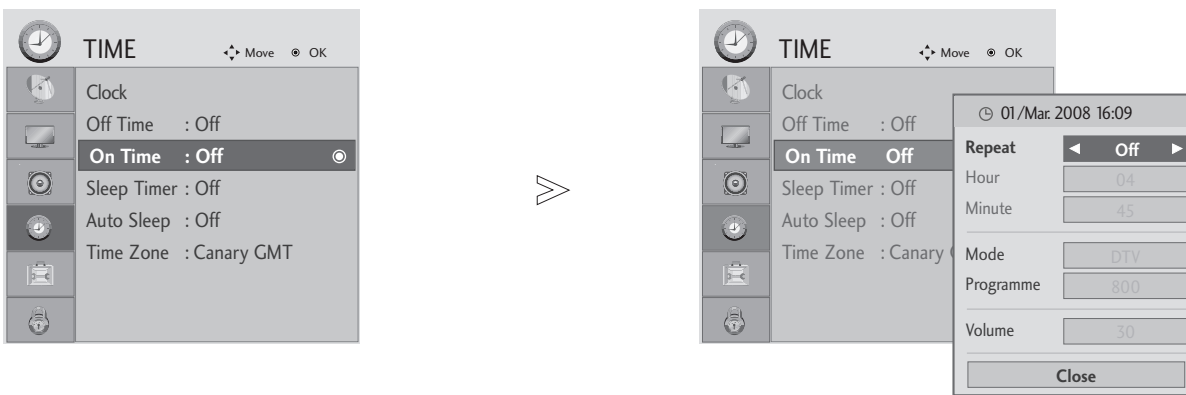

- 1 Select TIME.
- 2 Select Off time or On time.
- 3 Select Repeat.
- 4 Select Off, Once, Daily, Mon ~ Fri, Mon ~ Sat, Sat ~ Sun or Sun.
- 5 Set the hour.
- 6 Set the minutes.

- To cancel On/Off Time function, select Off.
 - For On Time function only
- 1 Select Mode.
 - 2 Select TV, DTV or Radio.
 - 3 Set the programme.
 - 4 Adjust volume level at switch-on.





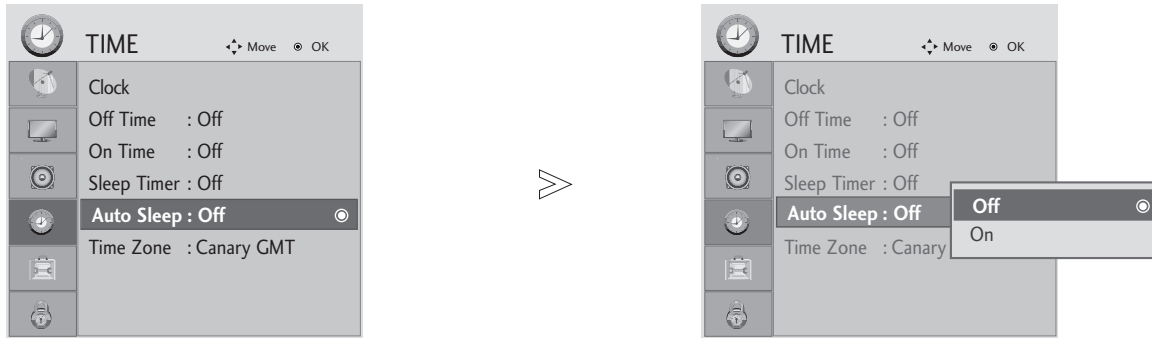

- Press the MENU or EXIT button to return to normal TV viewing.
- Press the BACK button to move to the previous menu screen.

TIME SETTING

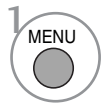
AUTO SHUT-OFF SETTING

If the TV is switched on and there is no input signal, it will switch off automatically after 10 minutes.







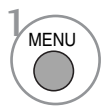

-   Select **TIME**.
-   Select **Auto Sleep**.
-   Select **Off** or **On**.

- Press the **MENU** or **EXIT** button to return to normal TV viewing.
- Press the **BACK** button to move to the previous menu screen.

TIME ZONE SETUP

When you select a Time Zone city, the TV time is set by the time offset information based on Time Zone and GMT (Greenwich Mean Time) which is received with the broadcast signal and the time is set automatically by a digital signal.

-   Select **TIME**.
-   Select **Time Zone**.
-   Select your viewing area time zone.
-  Confirm it.

SLEEP TIMER SETTING

You do not have to remember to switch the TV off before you go to sleep. The sleep timer automatically switches the TV to standby after the preset time has elapsed. You can also adjust Sleep Timer in the TIME menu.

- 1 Press the **SLEEP** button repeatedly to select the number of minutes. The display 'Sleep Timer : Off' will appear on the screen, followed by 10, 20, 30, 60, 90, 120, 180 and 240.
- 2 When the number of minutes you want is displayed on the screen, the timer begins to count down from the number of minutes selected.

! NOTE

- ▶ To view the remaining sleep time, press the **SLEEP** button once.
- ▶ To cancel the sleep time, repeatedly press the **SLEEP** button until the display 'Sleep Timer : Off' appears.
- ▶ When you switch the set off, the set releases the preset sleep time.

ALARM SETTING

The alarm sound will go off when the designated time passes. When 60 seconds pass, the alarm sound will stop.

If you do not want Alarm Function, select "Off".

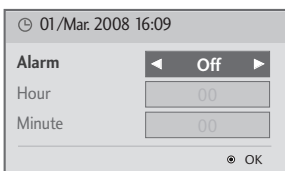

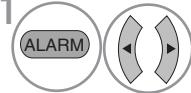
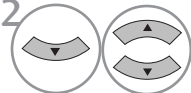
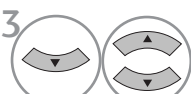
- 1  Select **On**.
- 2  Set the hour.
- 3  Set the minutes.

- Press the **MENU** or **EXIT** button to return to normal TV viewing.

- When the alarm is set to "On" with the power on, alarm icon will be displayed on the clock LED on the front of the TV.
- When the time reaches the alarm time when the power is turned on, the screen to notify the alarm time will be displayed on the TV and the TV volume will be muted for 60 seconds to generate the alarm sound. When you press the OK button, the alarm will be dismissed.
- When the time reaches the alarm time in standby mode, the alarm will go off for 60 seconds keeping the standby mode. When you press any button on the remote controller, the alarm will stop.







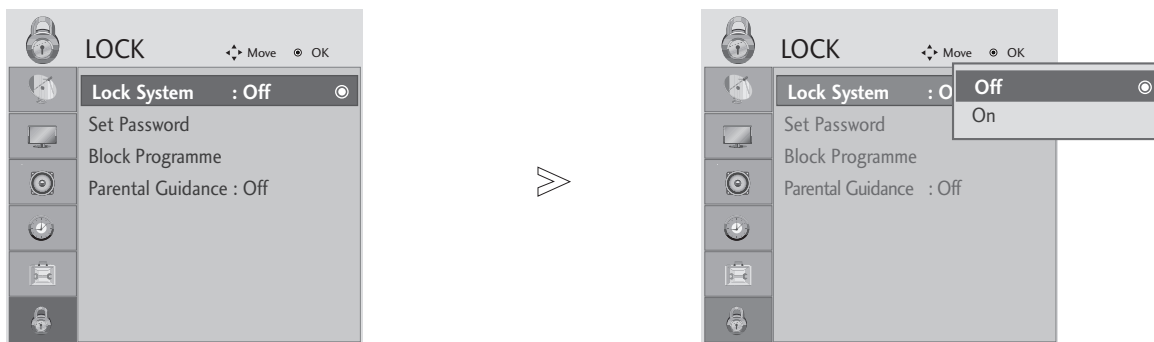

PARENTAL CONTROL / RATINGS

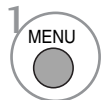
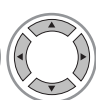
SET PASSWORD & LOCK SYSTEM

Enter the password, press '0', '0', '0', '0' on the remote control handset.



TIME SETTING

-   Select LOCK.
-   Select Lock System.
-   Select On.
-    Set the password.
-  Input a 4-digit password.
Be sure to remember this number!
Re-enter new password for confirm.

• If you forget your password, press '7', '7', '7', '7' on the remote control handset.





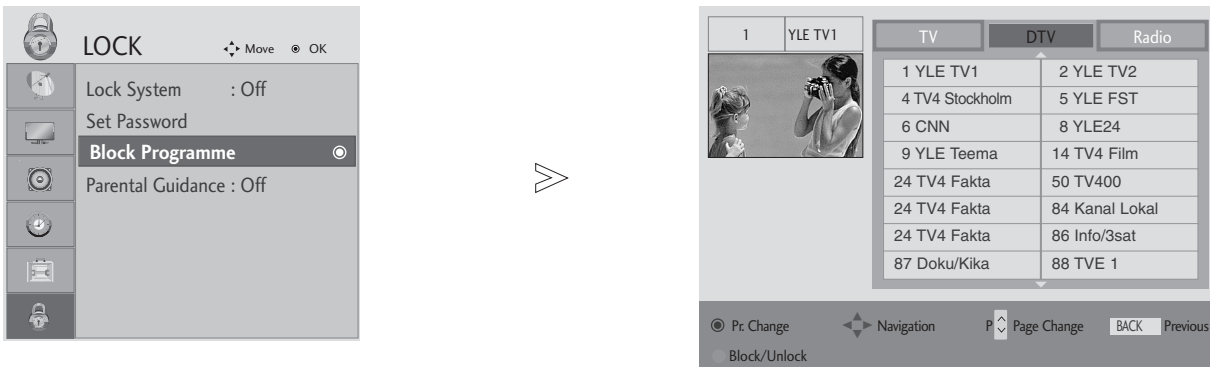

- Press the MENU or EXIT button to return to normal TV viewing.
- Press the BACK button to move to the previous menu screen.

BLOCK PROGRAMME

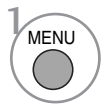
Blocks any programmes that you do not want to watch or that you do not want your children to watch.

It is available to use this function in Lock System “On”.



-   Select **LOCK**.
-   Select **Block Programme**.
-  Enter the **Block Programme**.
-   Select a programme to be locked.

- Press the **MENU** or **EXIT** button to return to normal TV viewing.
- Press the **BACK** button to move to the previous menu screen.

PARENTAL CONTROL / RATINGS

PARENTAL CONTROL (IN DIGITAL MODE ONLY)





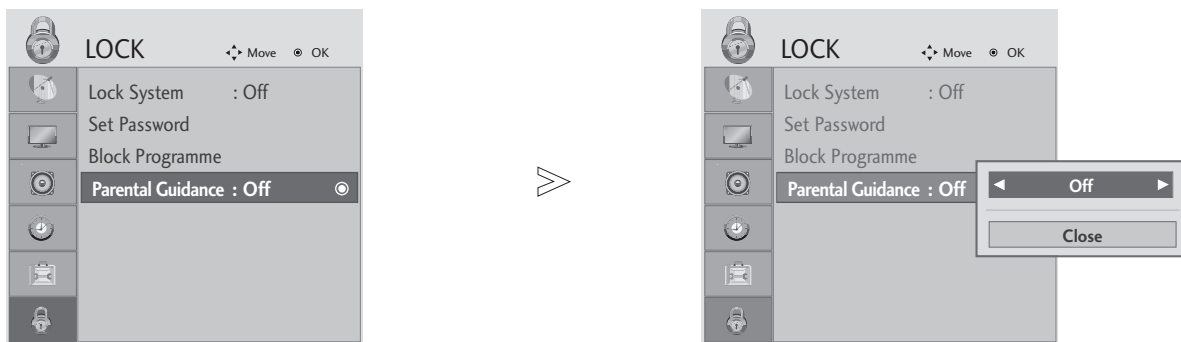

This function operates according to information from the broadcasting station. Therefore if the signal has incorrect information, this function does not operate.

A password is required to gain access to this menu.

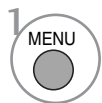
This TV is programmed to remember which option it was last set to even if you switch the TV off.

Prevents children from watching certain adult's TV programmes, according to the ratings limit set.







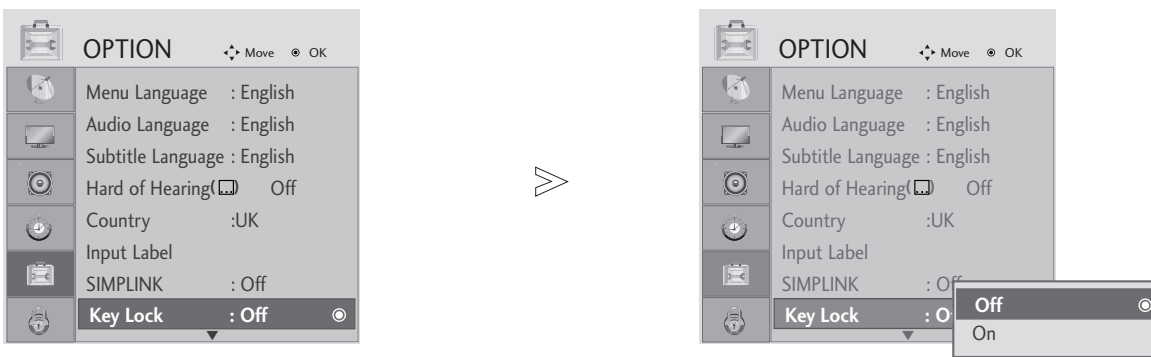

-   Select **LOCK**.
-   Select **Parental Guidance**.
-   Make appropriate adjustments.
-  Save.

- Press the **MENU** or **EXIT** button to return to normal TV viewing.
- Press the **BACK** button to move to the previous menu screen.

KEY LOCK

The TV can be set so that the remote control is required to control it. This feature can be used to prevent unauthorized viewing.

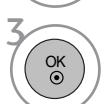

- 1   Select **OPTION**.
- 2   Select **Key Lock**.
- 3   Select **On** or **Off**.
- 4  Save.

- In **Key Lock 'On'**, if the TV is turned off, press the **⏻ / I**, **INPUT**, **P + -** button on the TV or **POWER**, **INPUT**, **P + -** or **NUMBER** buttons on the remote control.
- With the **Key Lock On**, the display '**Key Lock On**' appears on the screen if any button on the front panel is pressed while viewing the TV.

- Press the **MENU** or **EXIT** button to return to normal TV viewing.
- Press the **BACK** button to move to the previous menu screen.

TELETEXT

This feature is not available in all countries.

Teletext is a free service broadcast by most TV stations which gives up-to-the-minute information on news, weather, television programmes, share prices and many other topics.

The teletext decoder of this TV can support the SIMPLE, TOP and FASTEXT systems. SIMPLE (standard teletext) consists of a number of pages which are selected by directly entering the corresponding page number. TOP and FASTEXT are more modern methods allowing quick and easy selection of teletext information.

SWITCH ON/OFF

Press the **TEXT** button to switch to teletext. The initial page or last page viewed appears on the screen.

Two page numbers, TV station name, date and time are displayed on the screen headline. The first page number indicates your selection, while the second shows the current page displayed.

Press the **TEXT** or **EXIT** button to switch off teletext. The previous mode reappears.

SIMPLE TEXT

■ Page selection

- 1 Enter the desired page number as a three digit number with the **NUMBER** buttons. If during selection you press a wrong number, you must complete the three digit number and then re-enter the correct page number.
- 2 The **P + -** button can be used to select the preceding or following page.

TOP TEXT

The user guide displays four fields-red, green, yellow and blue at the bottom of the screen. The yellow field denotes the next group and the blue field indicates the next block.

■ Block / group / page selection

- 1 With the blue button you can progress from block to block.
- 2 Use the yellow button to proceed to the next group with automatic overflow to the next block.
- 3 With the green button you can proceed to the next existing page with automatic overflow to the next group. Alternatively the **P +** button can be used.
- 4 The red button returns to the previous selection. Alternatively the **P-** button can be used.

■ Direct page selection

As with SIMPLE teletext mode, you can select a page by entering it as a three digit number using the **NUMBER** buttons in TOP mode.

FASTEXT

The teletext pages are colour coded along the bottom of the screen and are selected by pressing the corresponding coloured button.

■ Page selection

- ① Press the  button to select the index menu.
- ② You can select the pages which are colour coded along the bottom line with corresponding coloured buttons.
- ③ AS with SIMPLE teletext mode, you can select a page by entering its three digit page number with the NUMBER buttons in FASTEXT mode.
- ④ The P + - button can be used to select the preceding or following page.

SPECIAL TELETEXT FUNCTIONS



■ REVEAL

Select this menu to display concealed information, such as solutions to riddles or puzzles.



■ UPDATE

Displays the TV picture on the screen while waiting for a new teletext page. The display will appear at the top left hand corner of the screen. When the updated page is available then display will change to the page number. Select this menu again to view the updated teletext page.



■ TIME

When viewing a TV programme, Select this menu to display the time at the top right hand corner of the screen. In the teletext mode, press this button to select a sub page number. The sub page number is displayed at the bottom of the screen. To hold or change the sub page, press the RED/GREEN, ◀ ▶ or NUMBER buttons.



■ HOLD

Stops the automatic page change which will occur if a teletext page consists of 2 or more sub pages. The number of sub pages and the sub page displayed is, usually, shown on the screen below the time. When this menu is selected the stop symbol is displayed at the top left-hand corner of the screen and the automatic page change is inactive.

DIGITAL TELETEXT

*This function works in UK only.

The TV gives you access to digital teletext which is greatly improved in various aspects such as text, graphics etc. This digital teletext can access special digital teletext services and specific services which broadcast digital teletext.

You should select off in the subtitle language menu to display teletext by pressing the **SUBTITLE** button.

TELETEXT WITHIN DIGITAL SERVICE

- 1 Press the numeric or **P + -** button to select a digital service which broadcasts digital teletext. To know which are digital teletext services, refer to the EPG service list.
- 2 Follow the indications on digital teletext and move onto the next step by pressing **TEXT**, **OK**, **▼ ▲ ◀ ▶**, **RED**, **GREEN**, **YELLOW**, **BLUE** or **NUMBER** buttons and etc..
- 3 To change digital teletext service, select a different service by the numeric or **P + -** button.



TELETEXT IN DIGITAL SERVICE

- 1 Press the numeric or **P + -** button to select a certain service which broadcasts digital teletext.
- 2 Press the **TEXT** or coloured button to switch on teletext.
- 3 Follow the indications on digital teletext and move onto the next step by pressing **OK**, **▼ ▲ ◀ ▶**, **RED**, **GREEN**, **YELLOW**, **BLUE** or **NUMBER** buttons and so on.
- 4 Press the **TEXT** or colour button to switch off digital teletext and return to TV viewing.

Some services may allow you to access text services by pressing the **RED** button.



APPENDIX

Initializing (Reset to original factory settings)

This function operates in current mode.
To initialize the adjusted value.

When the Lock System menu is “On”, the message to enter the password appears.

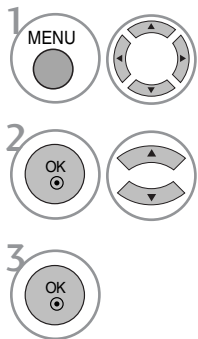
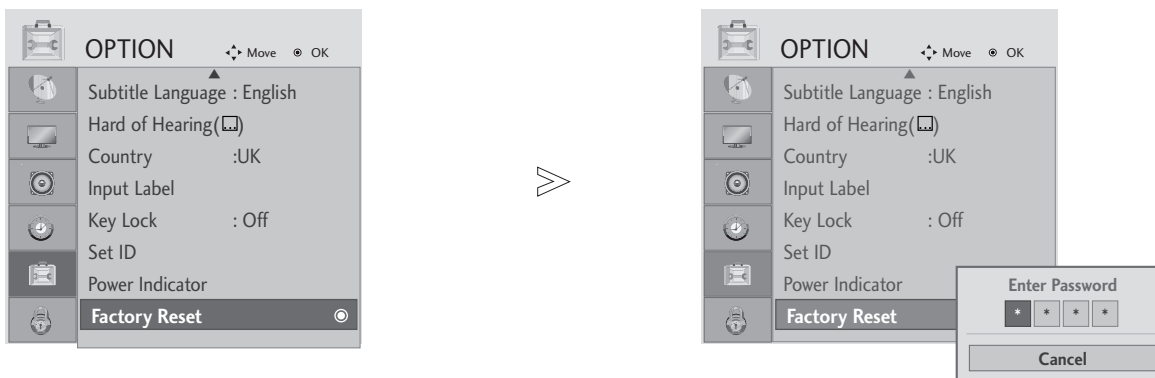

Select **OPTION**.

Select **Factory Reset**.

• In Lock System “On”, if you forget your password, press ‘7’, ‘7’, ‘7’, ‘7’ on the remote control handset.

- Press the **MENU** or **EXIT** button to return to normal TV viewing.
- Press the **BACK** button to move to the previous menu screen.

APPENDIX

TROUBLESHOOTING

The TV does not operate properly.	
The remote control does not work	<ul style="list-style-type: none"> ■ Check to see if there is any object between the TV and the remote control causing an obstruction. Ensure you are pointing the remote control directly at the TV. ■ Ensure that the batteries are installed with correct polarity (+ to +, - to -). ■ Install new batteries.
Power is suddenly turned off	<ul style="list-style-type: none"> ■ Is the sleep timer set? ■ Check the power control settings. Has the Power supply been interrupted. ■ Is Auto sleep activated on this station?

The video function does not work.	
No picture & No sound	<ul style="list-style-type: none"> ■ Check whether the TV is switched on. ■ Try another channel. The problem may be with the broadcast. ■ Is the power cord inserted correctly into the mains? ■ Check your antenna direction and/or location. ■ Test the mains outlet by plugging another TV into the same outlet.
Picture appears slowly after switching on	<ul style="list-style-type: none"> ■ This is normal, the image is muted during the TV startup process. Please contact your service centre, if the picture has not appeared after five minutes.
No or poor colour or poor picture	<ul style="list-style-type: none"> ■ Adjust Colour in menu option. ■ Allow a sufficient distance between the TV and the VCR. ■ Try another channel. The problem may be with the broadcast. ■ Are the video cables installed properly? ■ Activate any function to restore the brightness of the picture.
Horizontal/vertical bars or picture shaking	<ul style="list-style-type: none"> ■ Check for local interference such as an electrical appliance or power tool.
Poor reception on some channels	<ul style="list-style-type: none"> ■ Station or cable channel experiencing problems, tune to another station. ■ Station signal is weak, reposition the antenna to receive weaker stations. ■ Check for sources of possible interference.
Lines or streaks in pictures	<ul style="list-style-type: none"> ■ Check antenna (Change the position of the antenna).

The audio function does not work.

Picture OK & No sound	<ul style="list-style-type: none">■ Press the VOLUME button.■ Sound muted? Press MUTE button.■ Try another channel. The problem may be with the broadcast.■ Are the audio cables installed properly?
No output from one of the speakers	<ul style="list-style-type: none">■ Adjust Balance in menu option.
Unusual sound from inside the TV	<ul style="list-style-type: none">■ A change in ambient humidity or temperature may result in an unusual noise when the TV is switched on or off and does not indicate a fault with the TV.

There is a problem in PC mode. (Only PC mode applied)

The signal is out of range (Invalid format)	<ul style="list-style-type: none">■ Adjust resolution, horizontal frequency, or vertical frequency.■ Check the input source.
Vertical bar or stripe on background & Horizontal Noise & Incorrect position	<ul style="list-style-type: none">■ Use Auto configure or adjust clock, phase, or H/V position. (Option)
Screen colour is unstable or single colour	<ul style="list-style-type: none">■ Check the signal cable.■ Reinstall the PC video card.

APPENDIX

MAINTENANCE

Early malfunctions can be prevented. Careful and regular cleaning can prolong the life of your new TV.

Caution: Be sure to switch the power off and unplug the power cord before you begin any cleaning.

Cleaning the Screen

- 1 A good way to keep the dust off your screen for a while is to wet a soft cloth in a mixture of lukewarm water and a little fabric softener or dish washing detergent. Wring the cloth until it is almost dry, and then use it to wipe the screen.
- 2 Ensure there is no excess water on the screen. Allow any water or dampness to evaporate before switching on.

Cleaning the Cabinet

- To remove dirt or dust, wipe the cabinet with a soft, dry, lint-free cloth.
- Do not to use a wet cloth.

Extended Absence

CAUTION

- ▶ If you expect to leave your TV dormant for prolonged periods (such as a holiday), unplug the power cord to protect against possible damage from lightning or power surges.

PRODUCT SPECIFICATIONS

MODELS		22LG30**	26LG30**	
		22LG300C-ZA	26LG300C-ZA	
Dimensions (Width x Height x Depth)	with stand	522.2 x 431.5 x 189.0 mm 20.6 x 17.0 x 7.5 inches	663.3 x 508.2 x 227.3 mm 26.1 x 20.1 x 9.0 inches	
	without stand	522.2 x 384.2 x 69.0 mm 20.6 x 15.2 x 2.7 inches	663.3 x 449.8 x 80.0 mm 26.1 x 17.8 x 3.2 inches	
Weight	with stand	5.6 kg / 12.4 lbs	10.1 kg / 22.3 lbs	
	without stand	5.34 kg / 11.8 lbs	8.6 kg / 19.0 lbs	
Power requirement		AC100-240V~ 50/60Hz		AC100-240V~ 50/60Hz
Power Consumption		55W		120W
MODELS		32LG30**	37LG30**	42LG30**
		32LG300C-ZA	37LG300C-ZA	42LG300C-ZA
Dimensions (Width x Height x Depth)	with stand	801.8 x 604.2 x 227.3 mm 31.6 x 23.8 x 9.0 inches	919.6 x 682.3 x 293.8 mm 36.2 x 26.9 x 11.6 inches	1032.8 x 742.3 x 293.8 mm 40.7 x 29.3 x 11.6 inches
	without stand	801.8 x 544.1 x 79.0 mm 31.6 x 21.5 x 3.2 inches	919.6 x 610.3 x 89.0 mm 36.2 x 24.0 x 3.5 inches	1032.8 x 670.1 x 92.0 mm 40.7 x 26.4 x 3.7 inches
Weight	with stand	13.4 kg / 29.6 lbs	18.8 kg / 41.5 lbs	23.6 kg / 52.1 lbs
	without stand	11.9 kg / 26.3 lbs	16.2 kg / 35.7 lbs	21.0 kg / 46.3 lbs
Power requirement		AC100-240V~ 50/60Hz	AC100-240V~ 50/60Hz	AC100-240V~ 50/60Hz
Power Consumption		150W	180W	230W
Television System		PAL/SECAM B/G/D/K, PAL I/II, SECAM L/L'		
Programme Coverage		VHF: E2 ~ E12, UHF: E21 ~ E69, CATV: S1 ~ S20, HYPER: S21 ~ S47		
External Antenna Impedance		75 Ω		
Environment condition	Operating Temperature	0 ~ 40°C / 32 ~ 104°F		
	Operating Humidity	Less than 80%		
	Storage Temperature	-20 ~ 60°C / -4 ~ 140°F		
	Storage Humidity	Less than 85%		

■ The specifications shown above may be changed without prior notice for quality improvement.

APPENDIX

IR CODES

1. How to Connect

- Connect your wired remote control to the Remote Control port on the TV.

2. Remote Control IR Codes

■ Output waveform

Single pulse, modulated with 37.917KHz signal at 455KHz

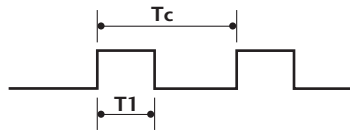

Carrier frequency
 $FCAR = 1/TC = fOSC/12$
 Duty ratio = $T1/TC = 1/3$

■ Configuration of frame

1st frame

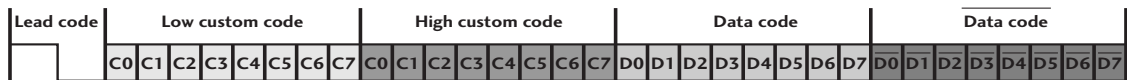

Repeat frame

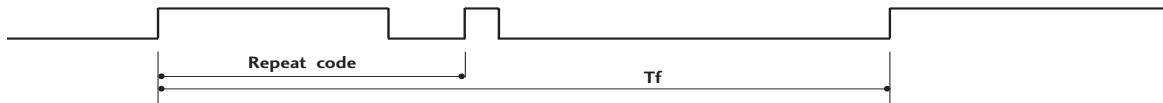

■ Lead code

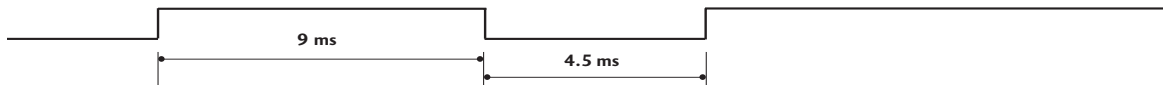

■ Repeat code

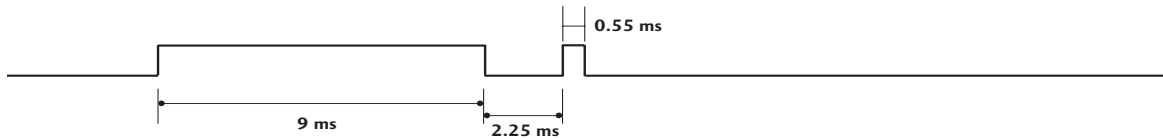

■ Bit description



■ Frame interval: Tf

The waveform is transmitted as long as a key is depressed.

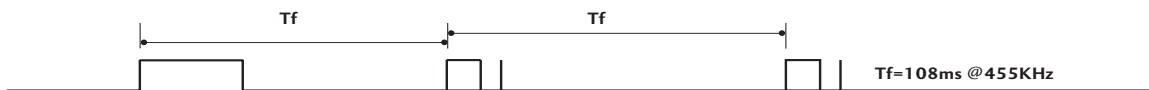

Code (Hexa)	Function	Note
08	POWER	R/C BUTTON (POWER ON/OFF)
0B	INPUT	R/C BUTTON
f0	TV/RADIO	R/C BUTTON
43	MENU	R/C BUTTON
AB	GUIDE	R/C BUTTON
07	Left (◀)	R/C BUTTON
06	Right (▶)	R/C BUTTON
40	Up (▲)	R/C BUTTON
41	Down (▼)	R/C BUTTON
44	OK(⊙)	R/C BUTTON
28	BACK	R/C BUTTON
AA	INFO ⓘ	R/C BUTTON
02	⏪ +	R/C BUTTON
03	⏪ -	R/C BUTTON
00	P +	R/C BUTTON
01	P -	R/C BUTTON
1E	FAV	R/C BUTTON
09	MUTE	R/C BUTTON
10 ~19	Number Key 0~9	R/C BUTTON
53	LIST	R/C BUTTON
1A	Q.VIEW	R/C BUTTON
72	RED Key	R/C BUTTON
71	GREEN Key	R/C BUTTON
63	YELLOW Key	R/C BUTTON
61	BLUE Key	R/C BUTTON
20	TEXT	R/C BUTTON
39	SUBTITLE	R/C BUTTON
5B	EXIT	R/C BUTTON
E8	ALARM	R/C BUTTON

APPENDIX

EXTERNAL CONTROL DEVICE SETUP

RS-232C Setup

Connect the RS-232C (serial port) input jack to an external control device (such as a computer or an A/V control system) to control the TV's functions externally.

Connect the serial port of the control device to the RS-232C jack on the TV back panel.

Note: RS-232C connection cables are not supplied with the TV.

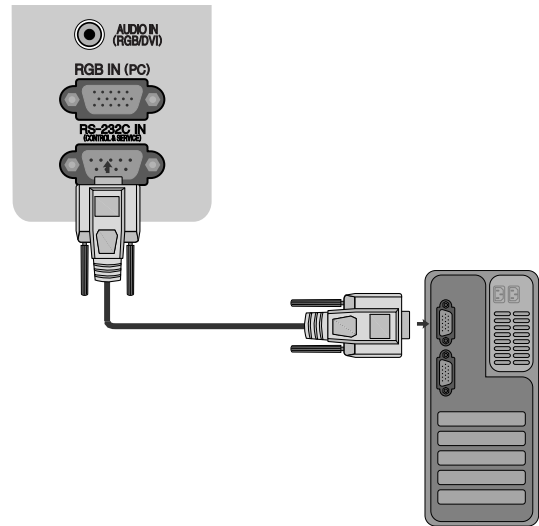

Type of Connector: D-Sub 9-Pin Male

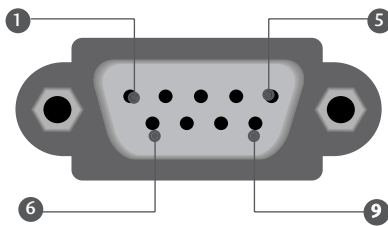

Male connector on box, viewed towards connector.

No.	Signal	Signal requirements
1	VCC	
2	RX RS232	Standard RS232 specification
3	TX RS232	Standard RS232 specification
4	IR from TV	
5	GND	Power ground
6, 8	Not connected	
7	+5V	1A 5VDC 10%, max 100mV ripple, (note A)
9	+12V	1A 12VDC 10%, max 100mV ripple, (note A)

Set ID

Use this function to specify a set ID number.

Refer to 'Real Data Mapping' ► p.91

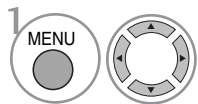
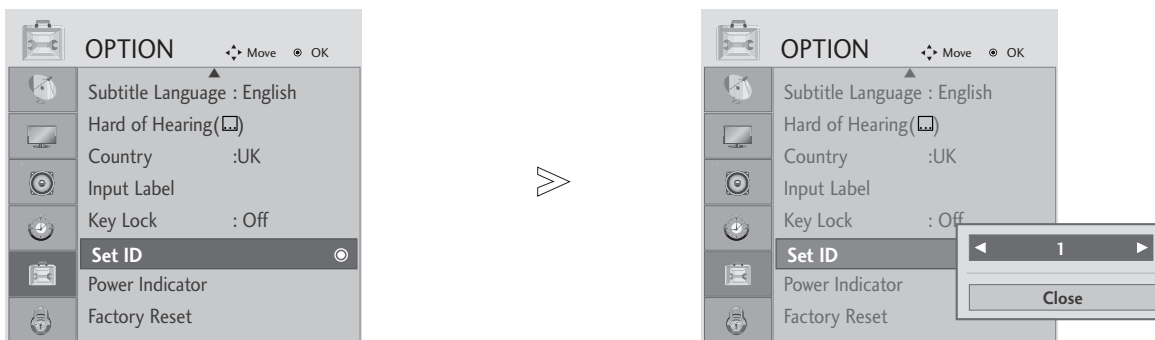

Select **OPTION**.

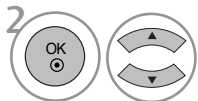

Select **Set ID**.

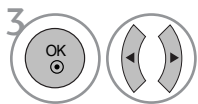

adjust **Set ID** to choose the desired TV ID number.
The adjustment range of SET ID is 1~99.

- Press the **BACK** button to move to the previous menu screen.

APPENDIX

Communication Parameters

- Baud rate : 9600 bps (UART)
- Data length : 8 bits
- Parity : None
- Stop bit : 1 bit
- Communication code : ASCII code
- Use a crossed (reverse) cable.

Command Reference List

	COMMAND 1	COMMAND 2	DATA (Hexadecimal)
01. Power	k	a	00 ~ 01
02. Aspect Ratio	k	c	Refer to p. 89
03. Screen Mute	k	d	00 ~ 01
04. Volume Mute	k	e	00 ~ 01
05. Volume Control	k	f	00 ~ 64
06. Contrast	k	g	00 ~ 64
07. Brightness	k	h	00 ~ 64
08. Colour	k	i	00 ~ 64
09. Tint	k	j	00 ~ 64
10. Sharpness	k	k	00 ~ 64
11. OSD Select	k	l	00 ~ 01
12. Remote control lock mode	k	m	00 ~ 01
13. Balance	k	t	00 ~ 64
14. Colour Temperature	k	u	00 ~ 02
15. Abnormal Status	k	z	FF
16. Auto Configure	j	u	01
17. Equalize	j	v	Refer to p. 91
18. Tune Command	m	a	Refer to p. 91
19. Channel Memory/Skip	m	b	00 ~ 01
20. Key	m	c	Key Code
21. Control Back Light	m	g	00 ~ 64
22. Input select (Main)	x	b	Refer to p. 92

* When setting the 15 ~ 22, a menu does not appear on screen.

Transmission / Receiving Protocol

Transmission

[Command1][Command2][][Set ID][][Data][Cr]

- * [Command 1] : First command to control the TV.
(j, k, m or x)
- * [Command 2] : Second command to control the TV.
- * [Set ID] : You can adjust the set ID to choose desired monitor ID number in option menu. Adjustment range is 1 ~ 99. When selecting Set ID '0'; every connected set is controlled. Set ID is indicated as decimal (1~99) on menu and as Hexa decimal (0x0~0x63) on transmission/receiving protocol.
- * [DATA] : To transmit command data. Transmit 'FF' data to read status of command.
- * [Cr] : Carriage Return
ASCII code '0x0D'
- * [] : ASCII code 'space (0x20)'

OK Acknowledgement

[Command2][][Set ID][][OK][Data][x]

- * The TV transmits ACK (acknowledgement) based on this format when receiving normal data. At this time, if the data is data read mode, it indicates present status data. If the data is data write mode, it returns the data of the PC computer.

Error Acknowledgement

[Command2][][Set ID][][NG][Data][x]

- * The TV transmits ACK (acknowledgement) based on this format when receiving abnormal data from nonviable functions or communication errors.

01. Power (Command: k a)

- ▶ To control Power On/Off of the TV.

Transmission

```
[k][a][ ][Set ID][ ][Data][Cr]
```

Data 00 : Power Off 01 : Power On

Ack

```
[a][ ][Set ID][ ][OK/NG][Data][x]
```

- ▶ To show Power On/Off.

Transmission

```
[k][a][ ][Set ID][ ][FF][Cr]
```

Ack

```
[a][ ][Set ID][ ][OK/NG][Data][x]
```

* Similarly, if other functions transmit '0xFF' data based on this format, Acknowledgement data feed back presents status about each function.

* OK Ack, Error Ack, and other message maybe display on the screen when TV is power On.

02. Aspect Ratio (Command: k c) (Main Picture Size)

- ▶ To adjust the screen format. (Main picture format)
You can also adjust the screen format using the **Aspect Ratio** in the PICTURE menu.

Transmission

```
[k][c][ ][Set ID][ ][Data][Cr]
```

Data 01 : Normal screen (4:3) 06 : Original
02 : Wide screen (16:9) 07 : 14:9
04 : Zoom1
05 : Zoom2 09 : Just Scan

Ack

```
[c][ ][Set ID][ ][OK/NG][Data][x]
```

* Using the PC input, you select either 16:9 or 4:3 screen aspect ratio.

* In HDMI/Component (over 720p) mode, Just Scan is available.

* You can only select Original in UK digital teletext (MHEG-5).

03. Screen Mute (Command: k d)

- ▶ To select screen mute on/off.

Transmission

```
[k][d][ ][Set ID][ ][Data][Cr]
```

Data 00 : Screen mute off (Picture on)
01 : Screen mute on (Picture off)

Ack

```
[d][ ][Set ID][ ][OK/NG][Data][x]
```

04. Volume Mute (Command: k e)

- ▶ To control volume mute on/off.
You can also adjust mute using the MUTE button on remote control.

Transmission

```
[k][e][ ][Set ID][ ][Data][Cr]
```

Data 00 : Volume mute on (Volume off)
01 : Volume mute off (Volume on)

Ack

```
[e][ ][Set ID][ ][OK/NG][Data][x]
```

05. Volume Control (Command: k f)

- ▶ To adjust volume.
You can also adjust volume with the VOLUME buttons on remote control.

Transmission

```
[k][f][ ][Set ID][ ][Data][Cr]
```

Data Min : 00 ~ Max : 64

* Refer to 'Real data mapping 1'. See page 91.

Ack

```
[f][ ][Set ID][ ][OK/NG][Data][x]
```

06. Contrast (Command: k g)

- ▶ To adjust screen contrast.
You can also adjust contrast in the PICTURE menu.

Transmission

```
[k][g][ ][Set ID][ ][Data][Cr]
```

Data Min : 00 ~ Max : 64

* Refer to 'Real data mapping 1'. See page 91.

Ack

```
[g][ ][Set ID][ ][OK/NG][Data][x]
```

07. Brightness (Command: k h)

- ▶ To adjust screen brightness.
You can also adjust brightness in the PICTURE menu.

Transmission

```
[k][h][ ][Set ID][ ][Data][Cr]
```

Data Min : 00 ~ Max : 64

* Refer to 'Real data mapping 1'. See page 91.

Ack

```
[h][ ][Set ID][ ][OK/NG][Data][x]
```

08. Colour (Command: k i)

- ▶ To adjust the screen colour.
You can also adjust colour in the PICTURE menu.

Transmission

```
[k][i][ ][Set ID][ ][Data][Cr]
```

Data Min : 00 ~ Max : 64

* Refer to 'Real data mapping 1'. See page 91.

Ack

```
[i][ ][Set ID][ ][OK/NG][Data][x]
```

APPENDIX

09. Tint (Command: k j)

- ▶ To adjust the screen tint.
You can also adjust tint in the PICTURE menu.

Transmission

[k][j][][Set ID][][Data][Cr]

Data Red : 00 ~ Green : 64
* Refer to 'Real data mapping 1'. See page 91.

Ack

[j][][Set ID][][OK/NG][Data][x]

10. Sharpness (Command: k k)

- ▶ To adjust the screen sharpness.
You can also adjust sharpness in the PICTURE menu.

Transmission

[k][k][][Set ID][][Data][Cr]

Data Min : 00 ~ Max : 64
* Refer to 'Real data mapping 1'. See page 91.

Ack

[k][][Set ID][][OK/NG][Data][x]

11. OSD Select (Command: k l)

- ▶ To select OSD (On Screen Display) on/off when controlling remotely.

Transmission

[k][l][][Set ID][][Data][Cr]

Data 00 : OSD off 01 : OSD on

Ack

[l][][Set ID][][OK/NG][Data][x]

12. Remote control lock mode (Command: k m)

- ▶ To lock the front panel controls on the monitor and remote control.

Transmission

[k][m][][Set ID][][Data][Cr]

Data 00 : Lock off 01 : Lock on

Ack

[m][][Set ID][][OK/NG][Data][x]

- * If you are not using the remote control, use this mode.
When main power is on/off, external control lock is released.

13. Balance (Command: k t)

- ▶ To adjust balance.
You can also adjust balance in the AUDIO menu.

Transmission

[k][t][][Set ID][][Data][Cr]

Data Min : 00 ~ Max : 64
* Refer to 'Real data mapping 1'. See page 112.

Ack

[t][][Set ID][][OK/NG][Data][x]

14. Colour Temperature (Command: k u)

- ▶ To adjust colour temperature. You can also adjust Colour Temperature in the PICTURE menu.

Transmission

[k][u][][Set ID][][Data][Cr]

Data 00: Medium 01: Cool 02: Warm

Ack

[u][][Set ID][][OK/NG][Data][x]

15. Abnormal State (Command: k z)

- ▶ To recognize an abnormal state.

Transmission

[k][z][][Set ID][][FF][][Cr]

Data FF : Read

Ack

[z][][Set ID][][OK/NG][Data][x]

Data 00: Normal (Power on and signal exist)
01: No signal (Power on)
02: Turn the monitor off by remote control
03: Turn the monitor off by sleep time function
04: Turn the monitor off by RS-232C function
05: 5V down
06: AC down
07: Turn the monitor off by Fan Alarm function
08: Turn the monitor off by Off time function
09: Turn the monitor off by Auto sleep function
a: Turn the monitor off by AV Board detect

- * This function is "read only".

16. Auto Configure (Command: j u)

- ▶ To adjust picture position and minimize image shaking automatically. It works only in RGB (PC) mode.

Transmission

[j][u][][Set ID][][Data][Cr]

Data 01: To set

Ack

[u][][Set ID][][OK/NG][Data][x]

17. Equalize (Command : j v)

► To adjust equalize.

Transmission



Frequency :	0	120Hz
	1	200Hz
	2	500Hz
	3	1.2kHz
	4	3kHz
	5	7.5kHz
	6	12kHz

Step (Frequency data):
Refer to 'Real data mapping 3'. See page 91.

Ack

[v][][Set ID][][OK/NG][Data][x]

* Equalize command expression

7	6	5	4	3	2	1	0	Frequency
0	0	0						120Hz
0	0	1						200Hz
0	1	0						500Hz
0	1	1						1.2KHz
1	0	0						3KHz
1	0	1						7.5KHz
1	1	0						12KHz

7	6	5	Step					OSD Value
			4	3	2	1	0	
			0	0	0	0	0	-24
		
			0	1	1	1	1	0
		
			1	1	1	1	1	24

Ex) If you wish to set frequency 500Hz and -20 value on menu OSD, refer to 'Real data mapping 3' and then find Step value for -20.

010 (500Hz) 00011 (Step 3) => 01000011 => 43 (Hexadecimal) : [j][v][][Set ID][][43][Cr]

* 3 bits of Frequency and 5 bits of Step makes 8 bits (1 byte). Change 8 bits to Hexadecimal code.

18. Tune Command (Command: m a)

► Select channel to following physical number.

Transmission

[m][a][][Set ID][][Data0][][Data1][][Data2][Cr]

Data 00 : High channel data
Data 01 : Low channel data
ex. No. 47 -> 00 2F (2FH)
No. 394 -> 01 88 (188H),
DTV No. 0 -> Don't care
Data 02 : 0x00 : ATV, 0x10 : DTV, 0x20 : Radio

Channel data range
Analogue - Min: 00 ~ Max: 63 (0~99)
Digital - Min: 00 ~ Max: 3E7 (0~999)

Ack

[a][][Set ID][][OK/NG][Data][x]

Data Min: 00 ~ Max: 7DH

19. Channel Memory/Skip (Command: m b)

► To set skip status for the current Programme.

Transmission

[m][b][][Set ID][][Data][Cr]

Data 00 : Skip
01 : No Skip

Ack

[b][][Set ID][][OK/NG][Data][x]

* Real data mapping 1

00 : Step 0
...
A : Step 10 (Set ID 10)
...
F : Step 15 (Set ID 15)
10 : Step 16 (Set ID 16)
...
64 : Step 100
6E : Step 110
...
73 : Step 115
74 : Step 116
...
C7 : Step 199
...
FE : Step 254
FF : Step 255

* Real data mapping 2

00 :-40
01 :-39
02 :-38
...
28 : 0
...
4E : +38
4F : +39
50 : +40

* Real data mapping 3 (Equalize)

Step:	OSD	Step:	OSD
00	:-24	16	: 1
01	:-23	17	: 3
02	:-21	18	: 4
03	:-20	19	: 6
04	:-18	20	: 7
05	:-16	21	: 9
06	:-15	22	: 10
07	:-13	23	: 12
08	:-12	24	: 13
09	:-10	25	: 15
10	:-8	26	: 16
11	:-7	27	: 18
12	:-5	28	: 19
13	:-4	29	: 21
14	:-2	30	: 22
15	: 0	31	: 24

APPENDIX

20. Key (Command : m c)

► To send IR remote key code.

Transmission

[m][c][][Set ID][][Data][Cr]

Data Key code - Refer to page 85.

Ack

[c][][Set ID][][OK/NG][Data][x]

21. Control Back Light (Command: m g)

► To Control the back light.

Transmission

[m][g][][Set ID][][Data][Cr]

Data : Min: 00 ~ Max: 64 (*transmit by hexadecimal code)

Ack

[g][][Set ID][][OK/NG][Data][x]

22. Input select (Command: x b) (Main Picture Input)

► To select input source for main picture.

Transmission

[x][b][][Set ID][][Data][Cr]

Data Structure

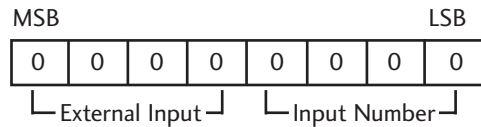

External Input				Data
0	0	0	0	DTV
0	0	0	1	Analogue
0	0	1	0	AV
0	1	0	0	Component
0	1	1	0	RGB
1	0	0	1	HDMI

Input Number				Data
0	0	0	0	Input1
0	0	0	1	Input2
0	0	1	0	Input3

Ack

[b][][Set ID][][OK/NG][Data][x]

LG Electronics Inc.