

User's Guide

M4715C

Make sure to read the Safety Precautions before using the product.
Keep the User's Guide(CD) in an accessible place for future reference.

See the label attached on the product and give the information to your dealer when you ask for service.





Temporary noise is normal when powering ON or OFF this device.

Connecting the stand

- Only on some models.

1. Take the parts for the stand out of the box and assemble them as shown in the picture.

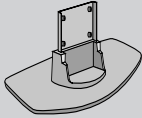
Parts First, check if the following parts are all present.

		
Screws (4)	Stand (1)	Cable management (1)

2. Place a soft cloth on the table and put the product with the screen facing downward. Connect the stand as shown in the following picture.

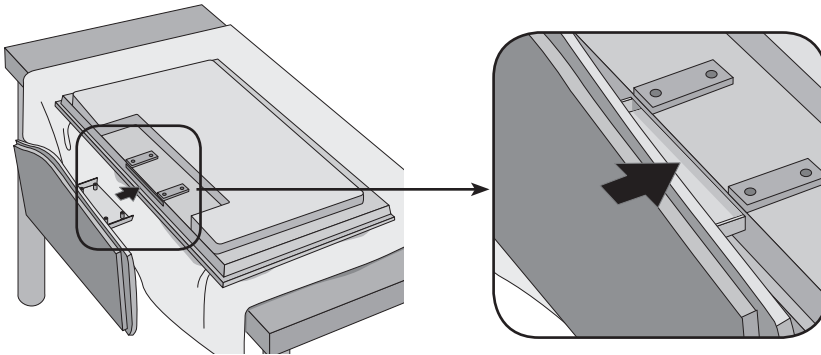

3. Use the screws to secure the stand on the rear side of the product as shown in the diagram.

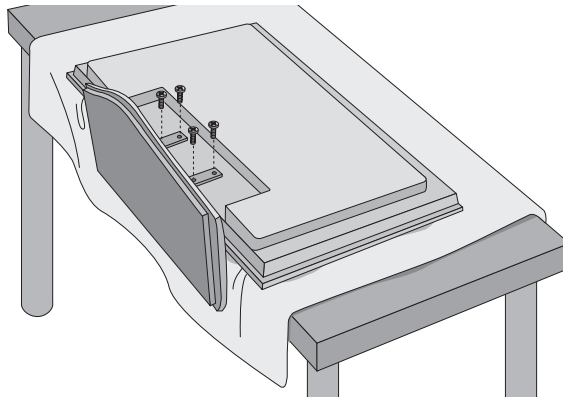

Connecting the Speakers

- Only on some models.

Mount the product onto the speaker by using a screw as shown in the following connect the speaker cable.

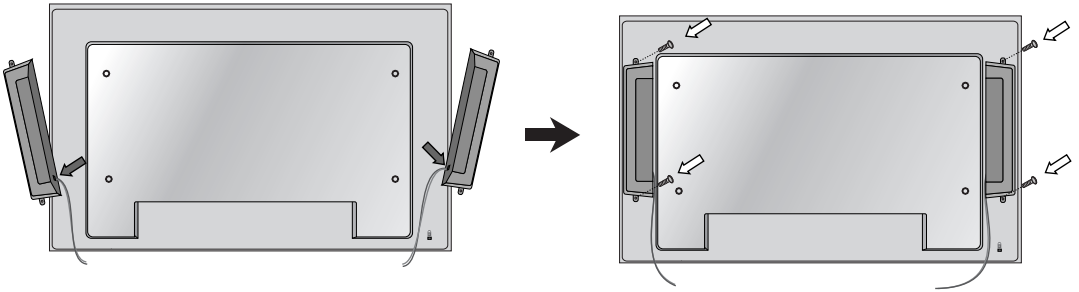

After installing your speakers, use holders and cable ties to organize the speaker cables.

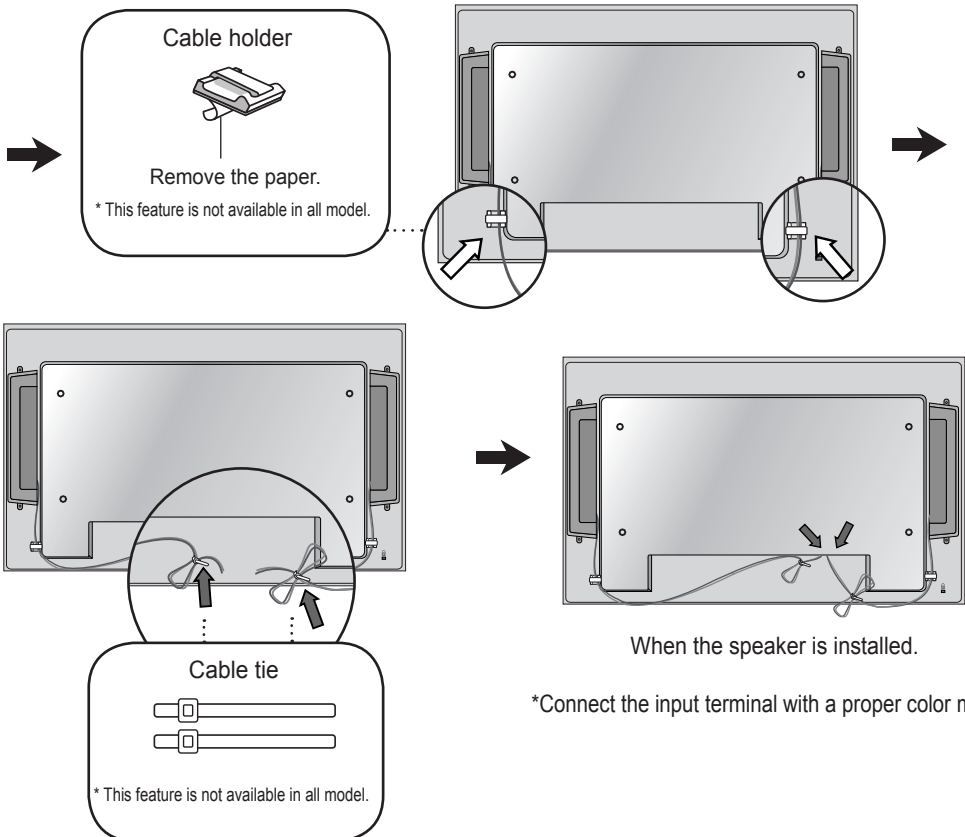

To install Portrait

- Only on some models.

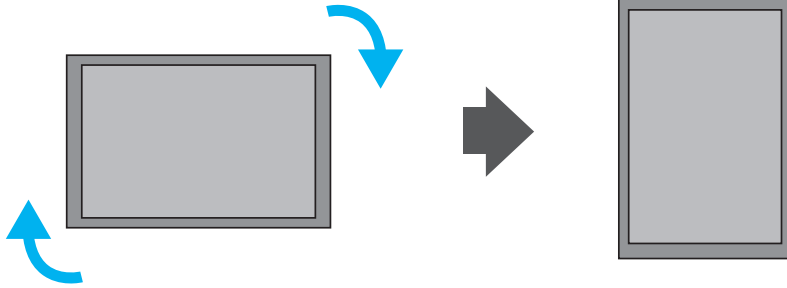

"When installing Portrait, rotate it clockwise based on its front."

Using the Remote Control

● Name of the Remote Control Buttons

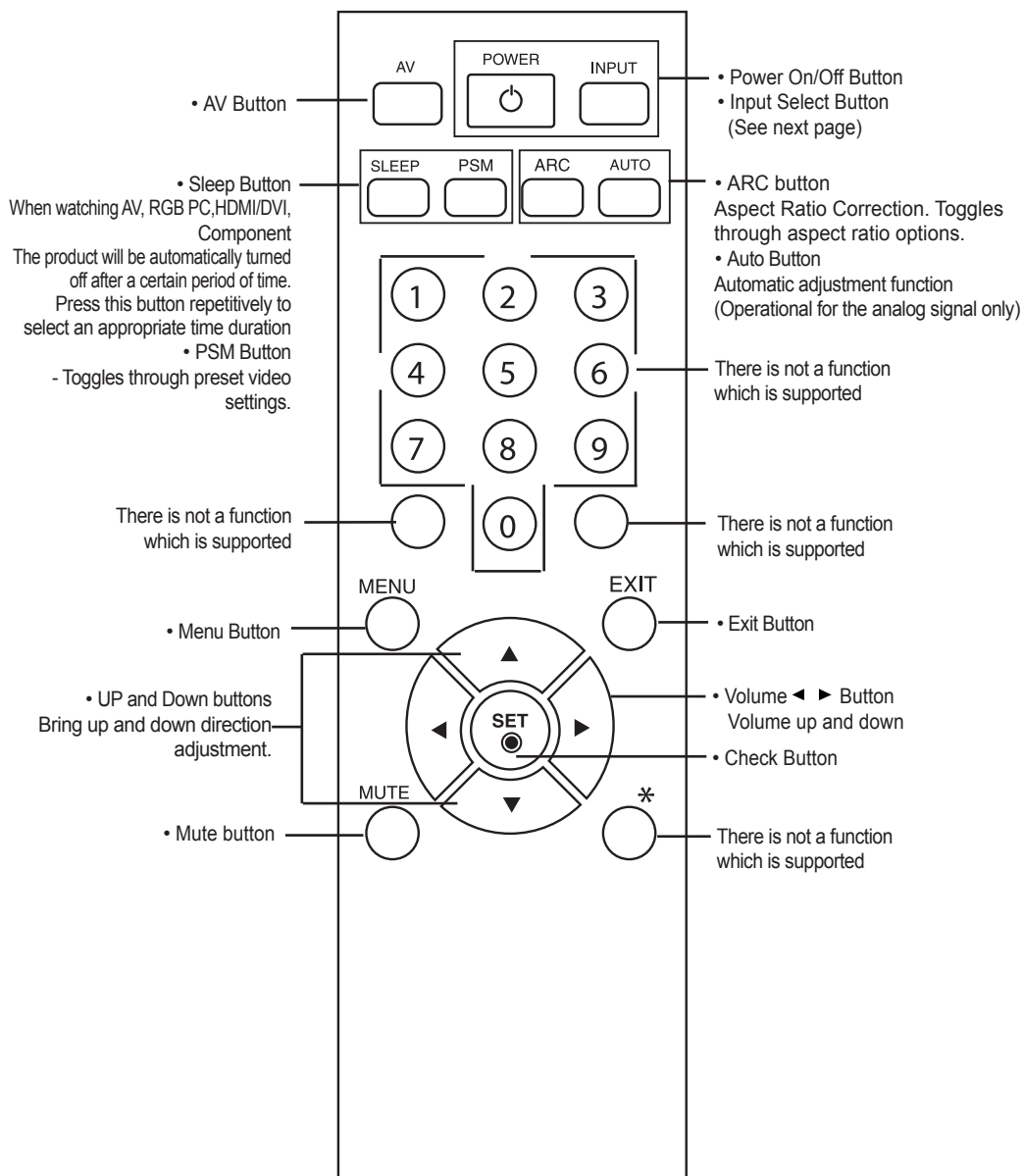

Using the Remote Control

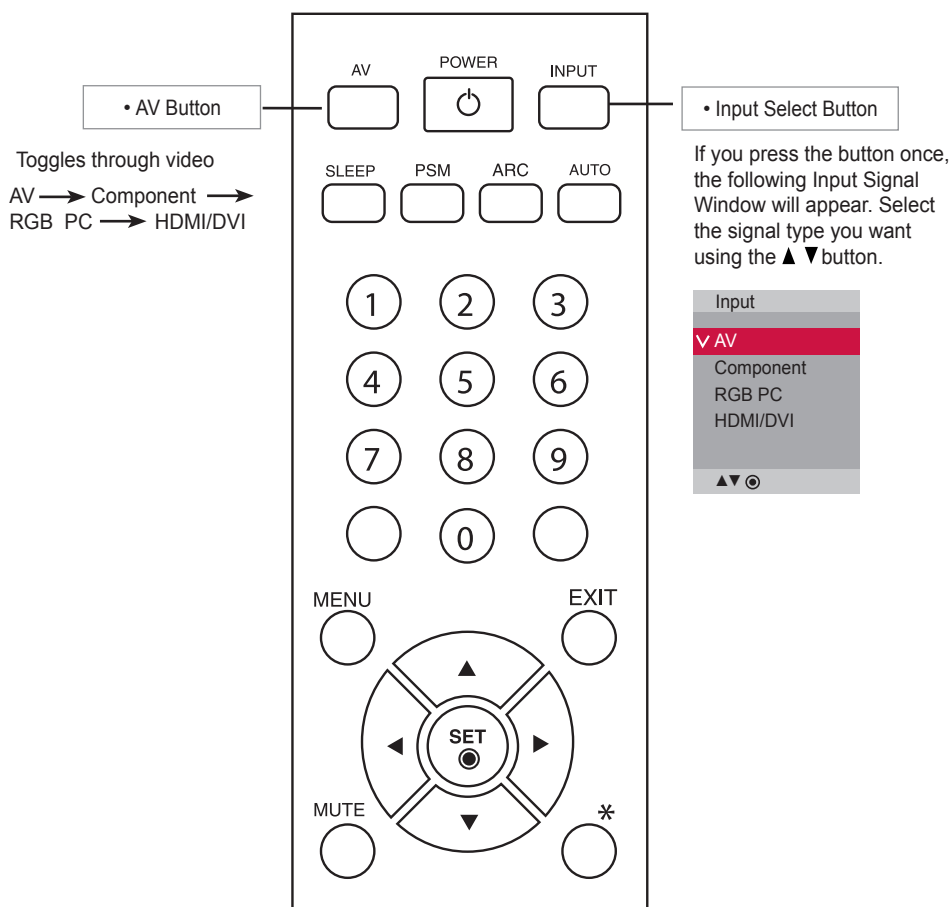

Inserting batteries into remote control.

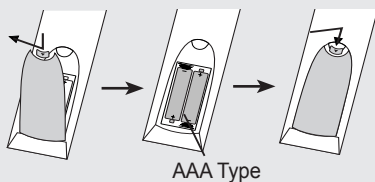

1. Slide off the battery cover.
2. Insert the batteries with correct polarity (+/-).
3. Close the battery cover.
 - Dispose of used batteries in the recycle bin to prevent environmental pollution.

Name and Function of the Parts

* The product image in the user's guide could be different from the actual image.

Rear View

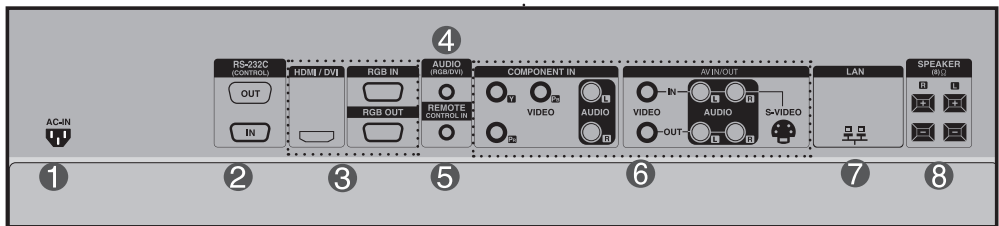
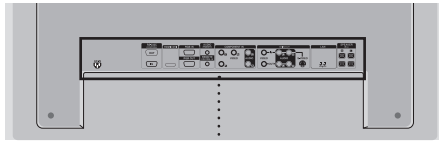

- 1 Power Connector : Connect the power cord
- 2 RS-232C Serial Ports
- 3 RGB PC, HDMI/DVI Ports
-HDMI Supports High Definition input and HDCP (High-bandwidth Digital Content Protection). Some devices require HDCP in order to display HD signals.
- 4 PC Sound Jack
: Connect the audio cable to the *LINE OUT jack of the PC sound card.
- 5 Wired Remote Control Port
- 6 AV Ports
- 7 LAN Port
- 8 Speaker Ports

*LINE OUT

A terminal used to connect to the speaker including a built-in amplifier (Amp). Make sure that the connecting terminal of the PC sound card is checked before connecting. If the Audio Out of PC sound card has only Speaker Out, reduce the PC volume.

If the Audio Out of the PC sound card supports both Speaker Out and Line Out, convert to Line Out using the card jumper of the program (Refer to the Sound Card Manual).

Connecting to External Devices

1 When Connecting to your PC

1 First of all, see if the computer, product and the peripherals are turned off. Then, connect the signal input cable.

- A When connecting with the D-Sub signal input cable.
- B When connecting with the HDMI to DVI signal input cable (not included).
* When HDMI PC is used, a compatibility problem might occur.

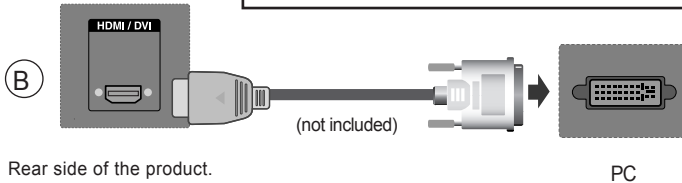
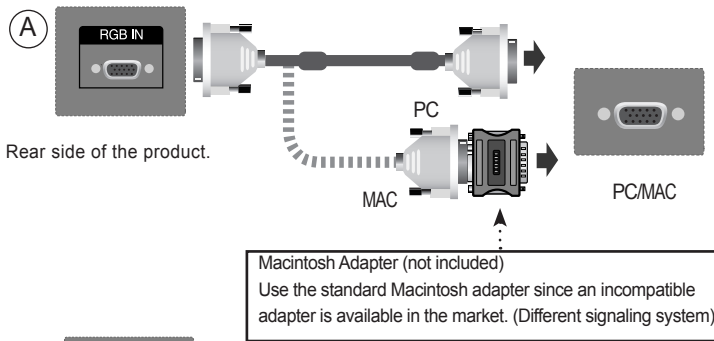

* User must use shielded signal interface cables (D-sub 15 pin cable, DVI cable) with ferrite cores to maintain standard compliance for the product.

2 Connect the Audio cable.

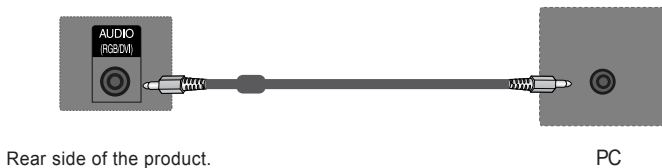

3 Connect the power cord.

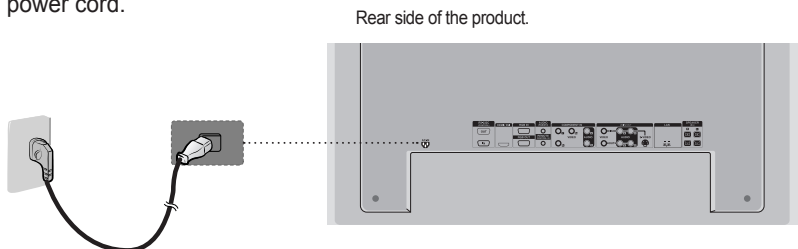

Connecting to External Devices

- 4 ① Turn on power by pressing the power button on the product.

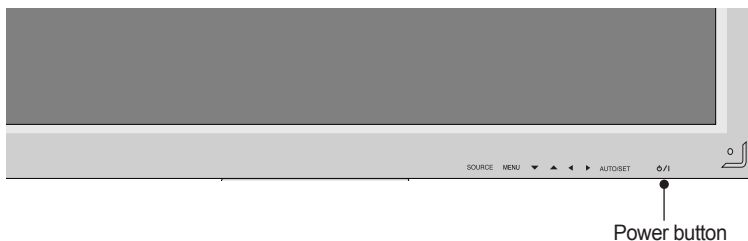

- ② Turn on the PC.

- 5 Select an input signal.
Press the INPUT button on the remote control to select the input signal.

INPUT → ▼▲ → SET

Or, press the SOURCE button on the back of the product.

SOURCE → ▼▲ → AUTO/SET

- A When connecting with a D-Sub signal input cable.
• Select RGB PC : 15-pin D-Sub analog signal.
- B When connecting with a HDMI to DVI signal input cable.
• Select HDMI/DVI : HDMI to DVI Digital signal.

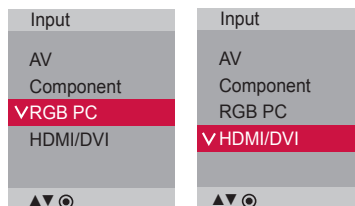

Note

- How to connect to two computers.
Connect the signal cables (HDMI to DVI and D-Sub) to each computer.
Press the INPUT button on the remote control to select the computer to use.
- Directly connect to a grounded power outlet on the wall or a power bar with a ground wire.

Connecting to External Devices

● When using the LAN

1 Connect the LAN cable as shown in the below figure .

A Connect PC to Monitor directly.

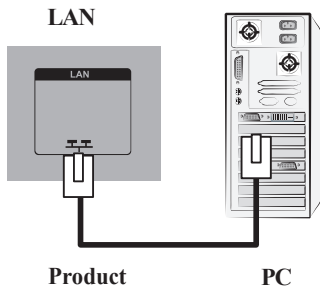

B Using a router(Switch)

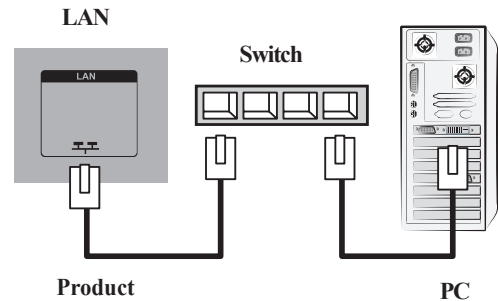

C Using the Internet.

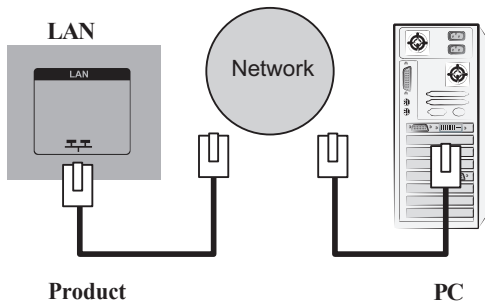

2 Connect the LAN cable and install the eZ-Net Manager program on the CD-ROM. For more information about the program, please refer to eZ-Net Guide in the enclosed CD-ROM.



Note

- Using LAN establishes communication between your PC and the monitor and enables to use the OSD menus on the PC as well as on the monitor.

Connecting to External Devices

● Daisy Chain Monitors

Use this function when displaying ANALOG RGB inputs of a PC to the other product.

- To use different products connected to each other Connect one end of the signal input cable(15-pin D-Sub Signal Cable) to the RGB OUT connector of product 1 and connect the other end to the RGB IN connector of other products.

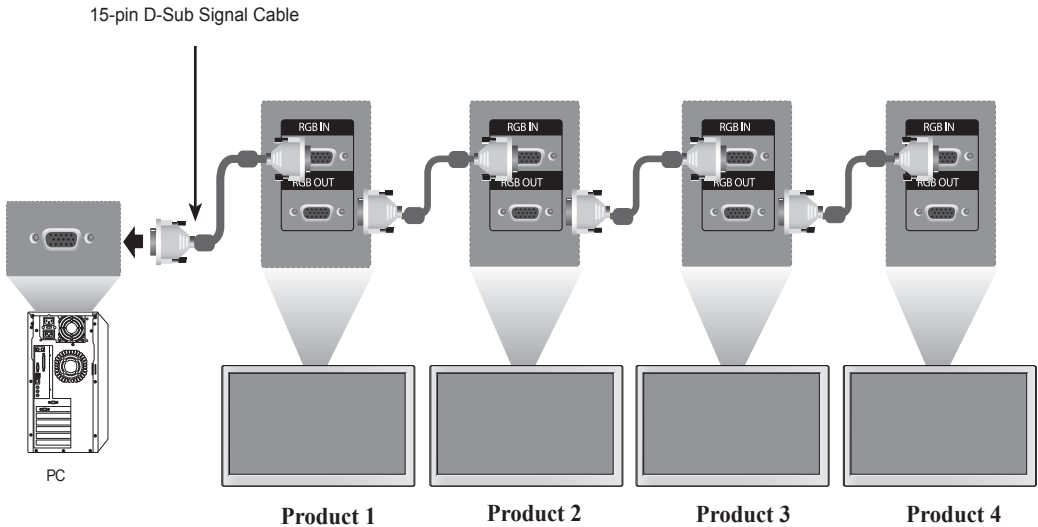

Note

- When multi-connecting in/out cascade format, no loss cables are recommended. We recommend that you should use cable distributor.

Connecting to External Devices

● VESA FDMI wall Mounting

This product supports a VESA FDMI compliant mounting interface. These mounts are purchased separately and not available from LG. Refer to the instructions included with wall mount for more info.

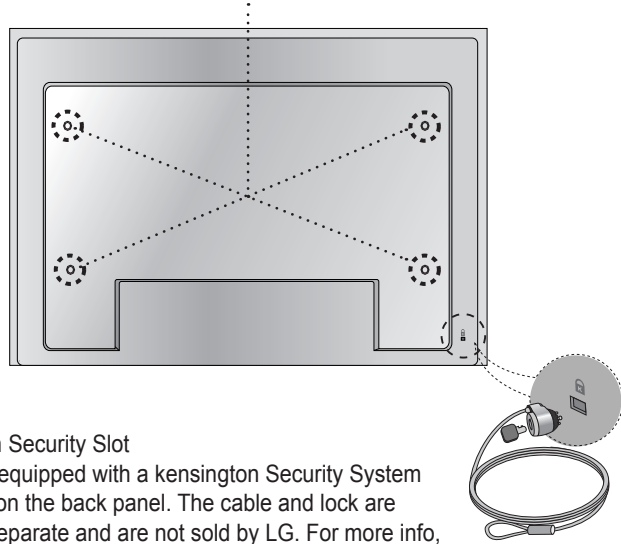

Kensington Security Slot

The Set is equipped with a Kensington Security System connector on the back panel. The cable and lock are available separately and are not sold by LG. For more info, visit <http://www.kensington.com>, the internet home page of the Kensington company.

Connecting to External Devices

Video Input

1 Connect the video cable as shown in the below figure and then connect the power cord (See page 7).

- (A) When connecting with a BNC cable.
- Connect the input terminal with a proper color match.

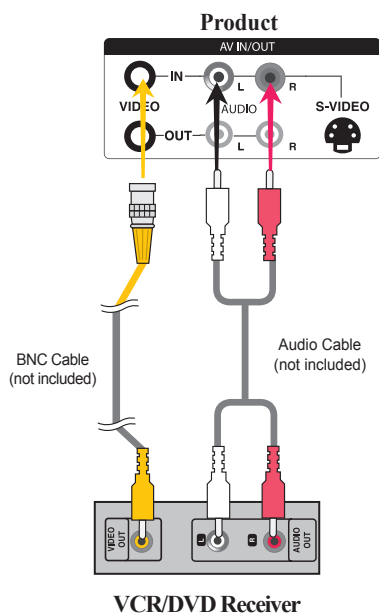

- (B) When connecting with a S-Video cable.
- Connect to the S-Video input terminal to watch high image quality movies.

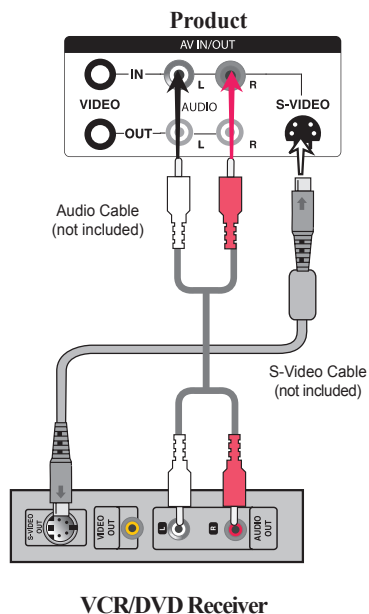

2 Select an input signal.
Press the INPUT button on the remote control to select the input signal.

INPUT → ▼▲ → SET

Or, press the SOURCE button on the back of the product.

SOURCE → ▼▲ → AUTO/SET

- (A) When connecting with an BNC cable.
- Select AV.
- (B) When connecting with an S-Video cable.
- Select AV.

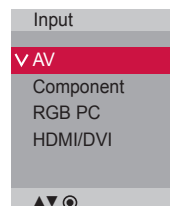

• When the BNC cable is connected simultaneously with S-Video cable, S-Video input has a priority.

Connecting to External Devices

● Component Input (480p/576p/720p/1080p/1080i/480i/576i)

1 Connect the video/audio cable as shown in the below figure and then, connect the power cord (See page 7).

- Connect the input terminal with a proper color match.

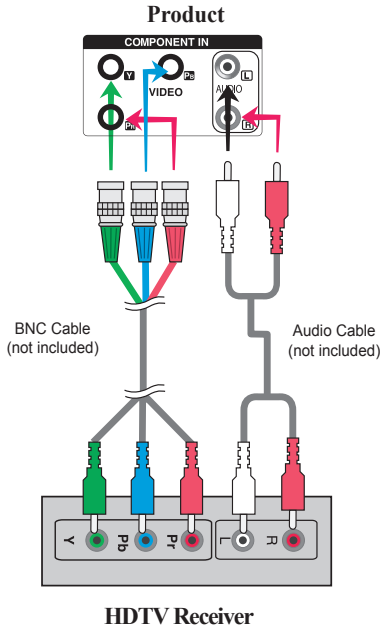

Note

- Some devices may require HDCP in order to display HD signals.
- Component doesn't support HDCP.

2 Select an input signal.
Press the INPUT button on the remote control to select the input signal.

INPUT → ▼ ▲ → SET

Or, press the SOURCE button on the back of the product.

SOURCE → ▼ ▲ → AUTO/SET

- Select Component

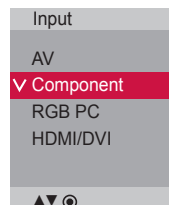

Connecting to External Devices

HDMI Input (480p/576p/720p/1080i/1080p)

- HDMI Supports High Definition input and HDCP (High-bandwidth Digital Content Protection). Some devices require HDCP in order to display HD signals.

- 1 Connect the video/audio cable as shown in the below figure and then connect the power cord (See page 7).

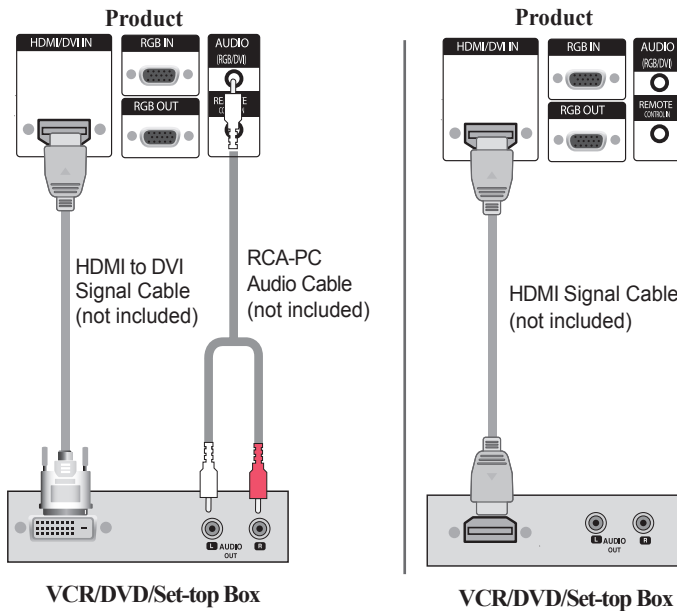

Note : Dolby Digital is not supported.

- 2 Select an input signal.
Press the INPUT button on the remote control to select the input signal.

INPUT → ▼ ▲ → SET

Or, press the SOURCE button on the back of the product.

SOURCE → ▼ ▲ → AUTO/SET

When connecting with a HDMI to DVI signal input cable.

When connecting with a HDMI signal input cable.

- Select HDMI/DVI

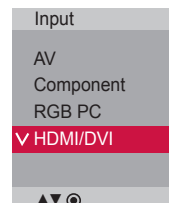

Connecting to External Devices

● Watching AV Outputs

- When using AV input, you can connect the AV Out to other monitors.

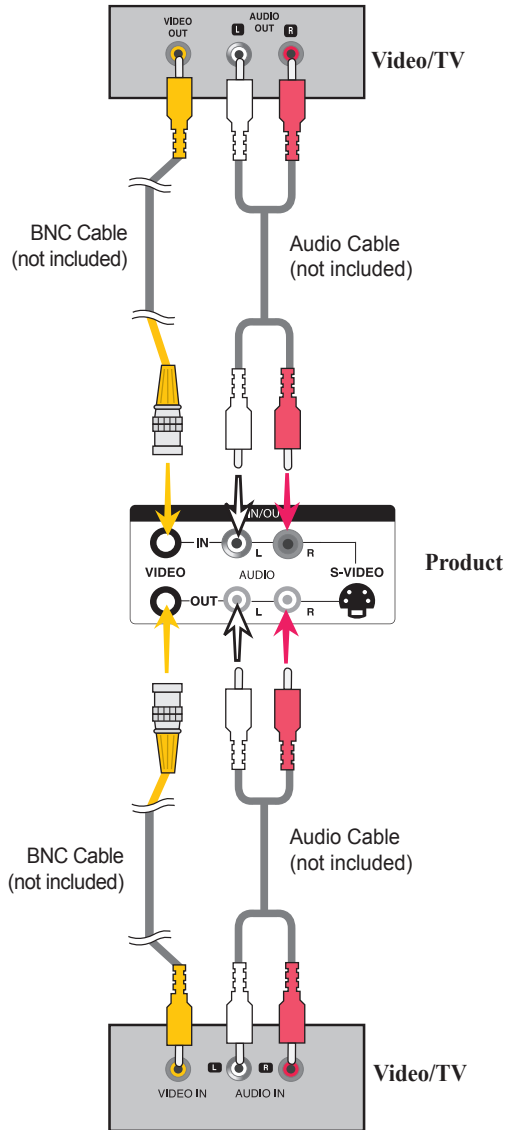

Note

- When multi-connecting in/out cascade format, no loss cables are recommended. We recommend that you should use cable distributor.

Cable Management

- Only on some models.

1. Arrange the cables in the center as shown in the following picture.

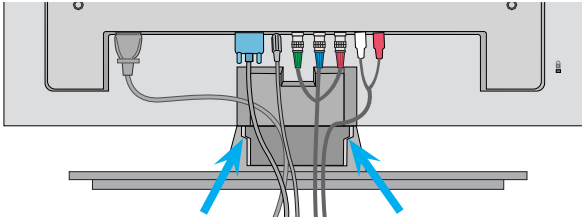

2. Fit the cable guide to the back to help manage the cables.

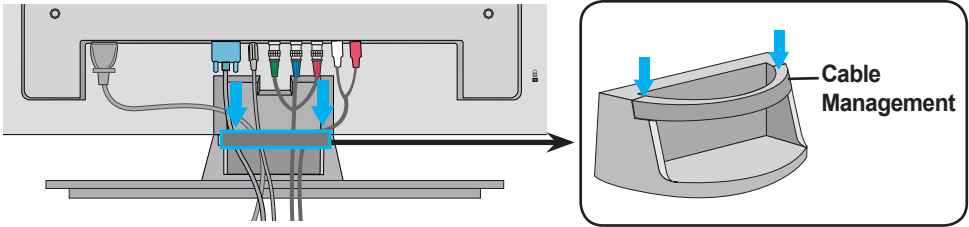

Removing the cable guide.

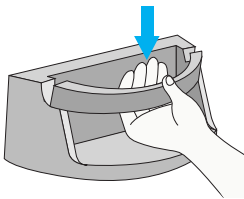

Hold the Cable management with both hands and pull it downward.

Warning

- Do not use the cable management as a handle for the Monitor.

User Menus

● Screen Adjustment options

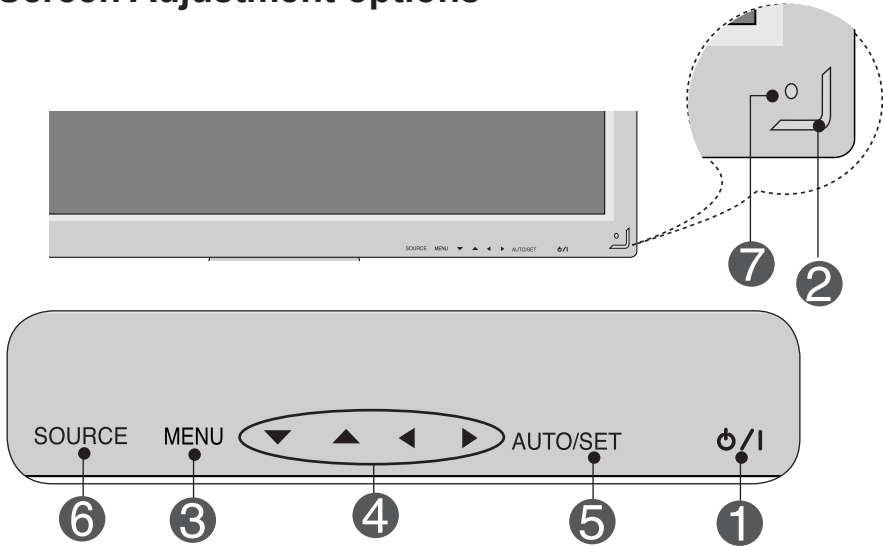

1

Power Button

• Press this button to turn on the power. Press this button again to turn it off.

2

Power Indicator

• This Indicator lights up blue when the display operates normally (on mode). If the display is in sleep (Energy Saving) mode, this indicator color changes to amber.

3

MENU Button

• Use this button to show/hide the OSD (On Screen Display) menu screen.

4

OSD Select / Adjust Button

• Use this button to select an icon or adjust the setting in the OSD screen.

▼▲ • Adjust the up and down.

◀▶ • Adjust the volume.



User Menus

● Screen Adjustment options

5

AUTO/SET Button

[For PC Analog signal]

Auto in progress
For optimal display change
resolution to 1920x1080

[When Full HD Mode is active
and 1920 X 1080 is selected]

Auto in progress

6

SOURCE Button

SOURCE → ▼▲ → AUTO/SET

- Toggles between inputs

AV	Composite Video, Separate Video
Component	HDTV, DVD
RGBPC	15-pin D-Sub analog signal
HDMI/DVI	Digital signal

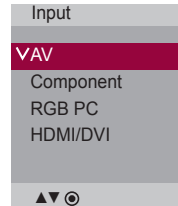





7

IR Receiver

• This is where the unit receives signals from the remote control.

User Menus

● OSD Menu

Icon	Function Description
 Picture	Adjusts screen brightness, contrast and color that you prefer.
 Audio	Adjusts the audio options.
 Time	Adjusts the timer options.
 Option	Adjusts the screen status according to the circumstances.
 Information	Adjust Set ID and check Serial No. and SW version and IP address



Note

OSD(On Screen Display)

The OSD function enables you to adjust the screen status conveniently since it provides graphical presentation.

User Menus

● How to adjust the OSD (On Screen Display) screen

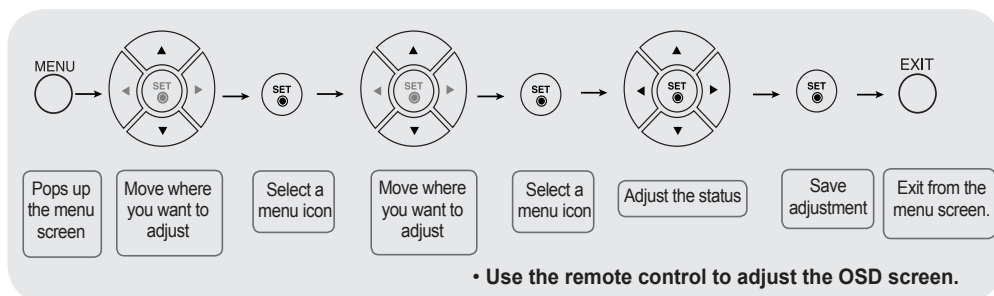

- 1 Press the **MENU** Button, then the main menu of the OSD appears.
- 2 To access a control, use the ▼ ▲ Buttons.
- 3 When the icon you want becomes highlighted, press the **SET** Button.
- 4 Use the ▼ ▲ ◀ ▶ Buttons to adjust the item to the desired level.
- 5 Accept the changes by pressing the **SET** Button.
- 6 Exit the OSD by pressing the **EXIT** Button.

● How to adjust the screen automatically

Press the AUTO/SET button (AUTO button on a remote Control) in the PC analog signal. Then optimal screen settings will be selected that fit into the current mode. If adjustment is not satisfactory, you can adjust the screen manually.

[When Full HD Mode is active and 1920 X 1080 is selected]

Auto in progress

User Menus



Adjusting Screen Color

Picture Mode

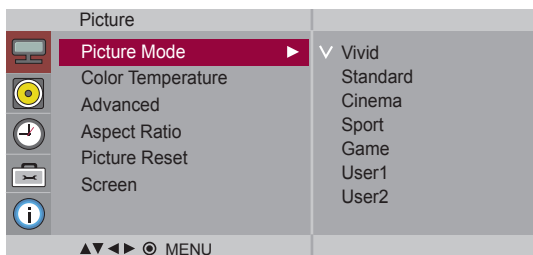

Toggles between screen presets.

- **Vivid** : Select this option to display with a sharp image.
- **Standard** : The most general and natural screen display status.
- **Cinema** : Select this option to lower brightness by one level.
- **Sport** : Select this option to display with a soft image.
- **Game** : To enjoy dynamic image when playing a game.
- **User1,2** : Select this option to use the user-defined settings.

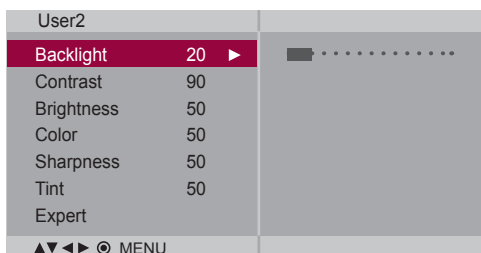

Backlight : To control the brightness of the screen, adjust the brightness of LCD panel.

Contrast : Adjust the difference between the light and dark levels in the picture.

Brightness : To adjust the brightness of the screen.

Color : To adjust the color to desired level.

Sharpness : To adjust the clearness of the screen.

Tint : To adjust the tint to desired level.

Expert : To compensate for each image mode, or adjust image values according to a particular image. (Applied only to User2 menu.)



Note

If the 'Picture Mode' setting in the **Picture** menu is set to **Vivid**, **Standard**, **Cinema**, **Sport** or **Game** the subsequent menus will be automatically set.

User Menus



Adjusting Screen Color

Color Temperature

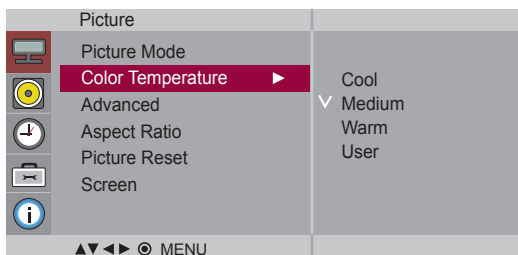

Color Settings

- **Cool** : Slightly purplish white.
- **Medium** : Slightly bluish white.
- **Warm** : Slightly reddish white.
- **User** : Select this option to use the user-defined settings.

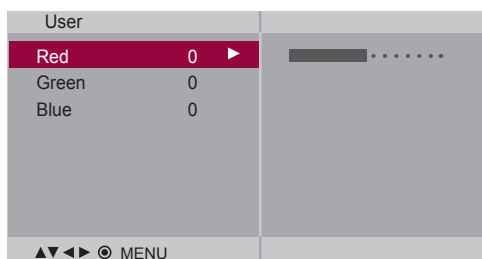

Red / Green / Blue

Set your own color levels.

User Menus



Adjusting Screen Color

Advanced

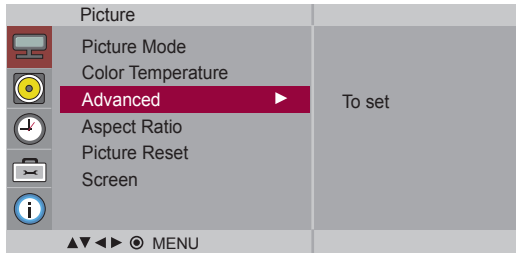

- **Gamma** : Set your own gamma value. : -50/0/50
On the monitor, high gamma values display whitish images and low gamma values display high contrast images.
- **Film Mode** : (Function works in the following mode - AV, Component 480i/576i)
When you watch a movie, this function adjusts the set to the best picture appearance.
- **Black Level** : (Function works in the following mode - AV(NTSC), HDMI/DVI)
adjusts the contrast and the brightness of the screen using the black level of the screen.

- **Low** : The reflection of the screen gets brighter.
- **High** : The reflection of the screen gets darker.

- **NR** : Removing the noise up to the point where it does not damage the original picture.

User Menus



Adjusting Screen Color

Aspect Ratio To select the image size of the screen.

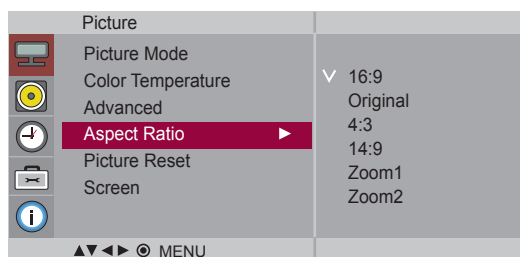

<AV>

16:9 Widescreen mode.

Just Scan Allows you to enjoy the transmitted data fully without any images cut off.
(* This menu is activated only in 720p, 1080p and 1080i in Component mode.)

Original The aspect ratio is not adjusted from the original. It is set by the program being watched.

4:3 This picture format is 4:3 aspect ratio.

1:1 The aspect ratio is not adjusted from the original. Used in PC mode.
(Only HDMI/ DVI PC, RGB PC)

14:9 14:9 programs are viewed normally in 14:9 with black bars added to the top and bottom. 4:3 programs are magnified on the top/bottom and left/right sides.

Zoom1, 2 4:3 programs are magnified until they fill the 16:9 screen. The top and bottom will be cut off.

ARC	MODE	AV	Component	HDMI/DVI		RGB
				DTV	PC	PC
16:9		●	●	●	●	●
Just Scan		×	●	●	×	×
Original		●	×	×	×	×
4:3		●	●	●	●	●
1:1		×	×	×	●	●
14:9		●	×	×	×	×
Zoom1		●	×	×	×	×
Zoom2		●	×	×	×	×

User Menus



Adjusting Screen Color

Picture Reset Return **Picture Mode, Color Temperature, Advanced, Aspect Ratio** to the default factory settings.

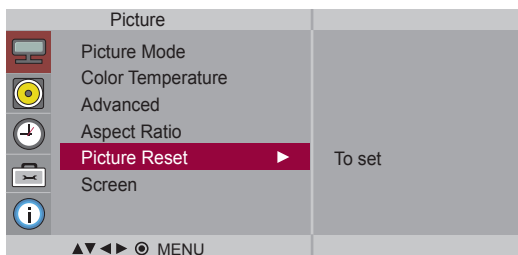

Screen Adjust the screen video.

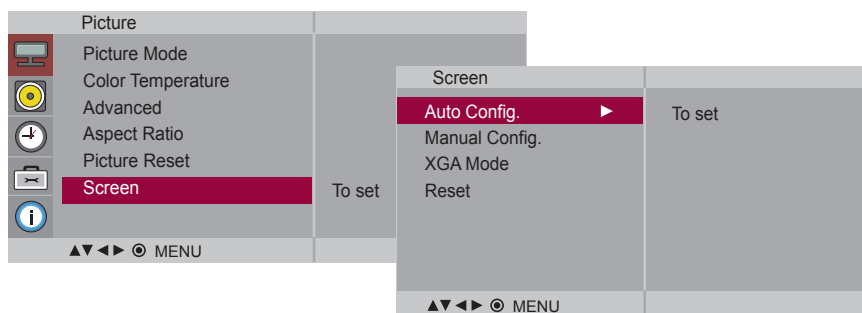

Auto Config. (RGB PC input only) : This button is for the automatic adjustment of the screen position, clock and phase. This function is available for analog signals only.

Manual Config. : If the picture isn't clear after auto adjustment and characters are still trembling, adjust the picture phase manually.

* Phase, Clock function are not available in Component, HDMI/DVI DTV.)

Phase : To adjust the focus of the display. This item allows you to remove any horizontal noise and clear or sharpen the image of characters. This function is available for analog signals only.

Clock : To minimize any vertical bars or stripes visible on the screen background. The horizontal screen size will also change. This function is available for analog signals only.

H-Position : Moving the screen position horizontally.

V-Position : Moving the screen position vertically.

H-Size : Adjust the horizontal size of the screen.

V-Size : Adjust the vertical size of the screen.

XGA Mode (RGB-PC only) . : For more improved or better picture quality, select the same mode corresponding to computer resolution.

Reset: Return **Manual config.** to the default factory settings.

User Menus



Adjusting the audio function

Sound Mode

The best sound tone quality will be selected automatically depending on the video type that you're currently watching.

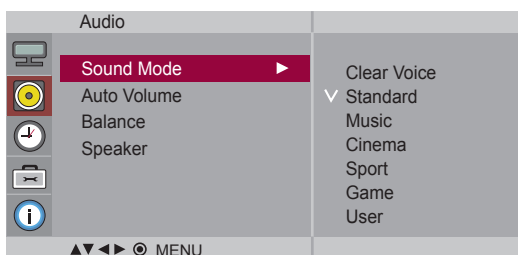

- **Clear Voice** : By differentiating the human sound range from others, it helps users listen to human voices better.
- **Standard** : The most commanding and natural audio.
- **Music** : Select this option to enjoy the original sound when listening to the music.
- **Cinema** : Select this option to enjoy sublime sound.
- **Sport** : Select this option to watch sports broadcasting.
- **Game** : To enjoy dynamic sound when playing a game.
- **User** : Select this option to use the user-defined audio settings.



Auto Volume To adjust uneven sound volumes across all channels or signals automatically to the most appropriate level. To use this feature, select On.

Balance Use this function to balance sound from the left and right speakers.

Speaker You can adjust internal speaker status.
If you want to use your external hi-fi stereo system, turn off the internal speakers of the set.



Note

When connected to your computer and the 'Sound Mode' setting in the audio menu is **Clear Voice**, **Standard**, **Music**, **Cinema** or **Sport**, the available menus are **Balance**, **Auto Volume**, **Speaker**.

User Menus



Adjusting the timer function

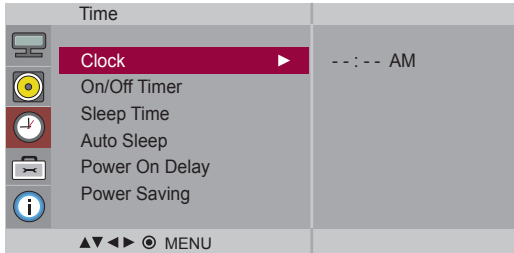

Clock

If the current time is incorrect, reset the clock manually.

- 1) Press the **MENU** button and then use **▼▲** button to select the **Time** menu.
- 2) Press the **▶** button and then use **▼▲** button to select the **Clock** menu.
- 3) Press the **▶** button and then use **▼▲** button to set the hour(00~23).
- 4) Press the **▶** button and then use **▼▲** button to set the minutes(00~59).

On/Off Timer

The off time automatically switches the set to standby at the pre-set time.

- 1) Press the **MENU** button and then use **▼▲** button to select the **Time** menu.
- 2) Press the **▶** button and then use **▼▲** button to select **On/Off Timer**.
- 3) Press the **▶** button and then use **▼▲** button to set the hour(00~23).
- 4) Press the **▶** button and then use **▼▲** button to set the minutes(00~59).
- 5) Press the **▶** button and then use **▼▲** button to select **On** or **Off**.
- 6) Press the **▶** button and then use **▼▲** button to select **Select input** or **On Timer**

Sleep Time

The power is automatically turned off when the time set by a user is passed.

- 1) Press the **MENU** button and then use **▼▲** button to select the **Sleep Time** menu.
- 2) Press the **▶** button and then use **▼▲** button to set the hour(00~23).
- 3) Press the **▶** button and then use **▼▲** button to set the minutes(00~59).

Auto Sleep

If **Auto Sleep** is active and there is no input signal, the set switches to off mode automatically after 10 minutes.

- 1) Press the **MENU** button and then use **▼▲** button to select the **Auto Sleep** menu.
- 2) Press the **▶** button and then use **▼▲** button to select **On** or **Off**.

Power On Delay

When connecting multiple monitors and turning the power on, the monitors are turned on individually to prevent overload.

Note



- In the event of power interruption (disconnection or power failure), the clock must be reset.
- Once the on or off time is set, these functions operate daily at the preset time.
- Off time function overrides On time function if they are set to the same time.
- When On time is operated, input screen is turned on as it was turned off.

User Menus



Adjusting the timer function

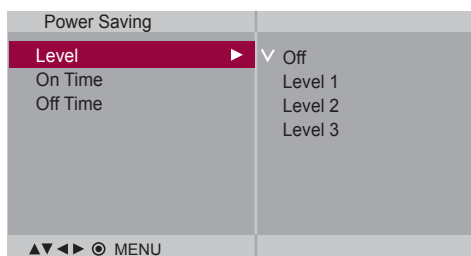
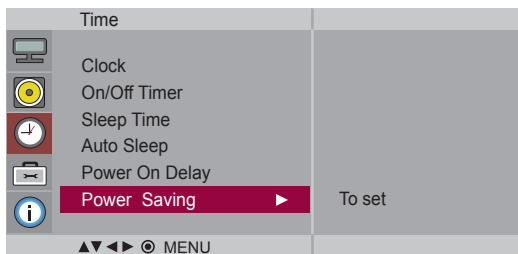

Power Saving

This screen brightness adjusting menu helps you save energy.

- **Level:** Total 4 screen brightness levels are provided.
 - Off: 100% light
 - Level 1: 80% light
 - Level 2: 60% light
 - Level 3: 40% light
- **On Time :** Enables to automatically turn on the Power Saving option at a scheduled time.
- **Off Time :** Enables to automatically turn off the Power Saving option at a scheduled time.

*The Power Saving option becomes in effect only during the scheduled time frame.
The On Time and Off Time menus become disabled if Level Off is selected.

User Menus



Selecting the options

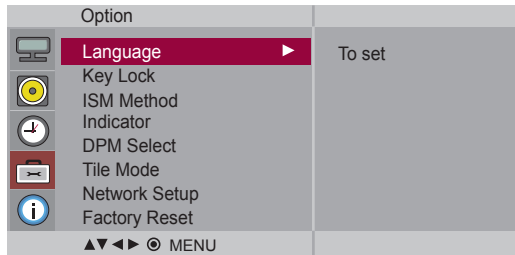

Language

To choose the language in which the control names are displayed.

Key Lock

Use the **▼ ▲** buttons to select **On** or **Off**. The monitor can be set up so that it can only be used with the remote control. This feature can prevent unauthorized viewing.

In order to lock the OSD screen adjustment, set the **Key Lock** tab to the **'On'** position.

In order to unlock it, do the following :

- Push the **MENU** button on the remote control and set **Key Lock** to the **'Off'** position.

ISM Method

A frozen or still picture from a PC/Video game displayed on the screen for prolonged periods could result in a ghost image remaining even when you change the image. Avoid allowing a fixed image to remain on the screen for a long period of time.

Normal : Leave on normal if you don't foresee image burn in being a problem.

White wash : White wash fills the screen with solid white. This helps removes permanent images burned into the screen. A permanent image may be impossible to clear entirely with white wash.

Orbiter : May help prevent ghost images. However, it is best not to allow any fixed image to remain on the screen. To avoid a permanent image on the screen, the screen will move every 2 minutes.

Inversion : This function inverts the panel color of the screen. The panel color is automatically inverted every 30 minutes.

Dot Wash : This function moves the black dots of the screen. The black dots is automatically moved every 5 second.

User Menus



Selecting the options

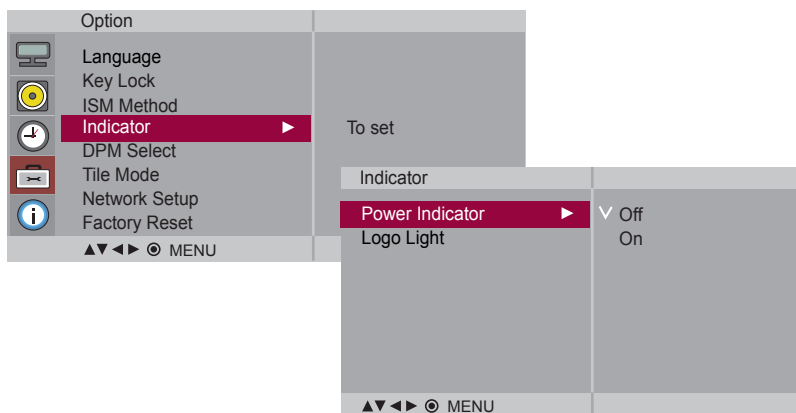

Indicator

You can set the Power Indicator and Logo Light.

Power Indicator

Use this function to set the power indicator on the front side of the product to On or Off. If you set Off, it will go Off. If you set On at any time, the power indicator will automatically be turned on.

Logo Light

Use this function to reset the Logo Display Lamp On the front side of the product to On or Off. If you set On, the lamp will automatically be turned on.

DPM Select

A user can choose to turn the power saving mode on / off.

User Menus



Selecting the options

• To use this function

- Must be displayed with various other products.
- Must be in a function that can be connected to RS-232C or RGB Out

Tile mode

Option			
	Language	Tile Mode	Off
	Key Lock	H-Size	0
	ISM Method	V-Size	0
	Indicator	H-Position	<>
	DPM Select	V-Position	<>
	Tile Mode	Reset	
	Network Setup	Tile ID	1
	Factory Reset	Natural	Off
▲▼◀▶⊙ MENU			

It is used to enlarge the screen and also used with several products to view screen.

• Tile Mode

Tile mode and choose Tile alignment and set the ID of the current product to set location.

* Only after pressing the SET button the adjustments made to the settings will be saved.

- Tile mode : column x row (c = 1, 2, 3, 4,5 r = 1, 2, 3, 4,5)
- 5 x 5 available.
- Configuration of an integration screen is also available as well as configuration of One by one Display.



- Tile mode (product 1 ~ 4) : c(2) x r(2)

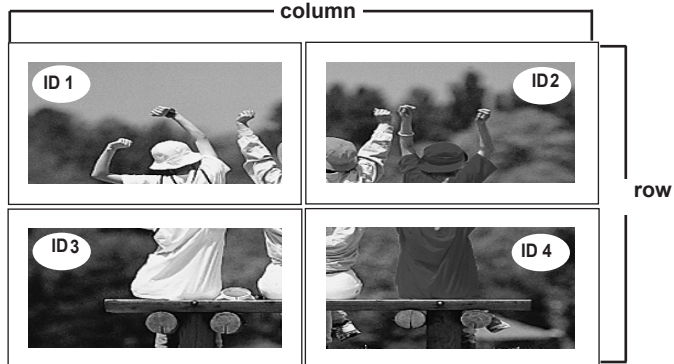

User Menus



Selecting the options

- Tile mode (product 1 ~ 9) : c(3) x r(3)

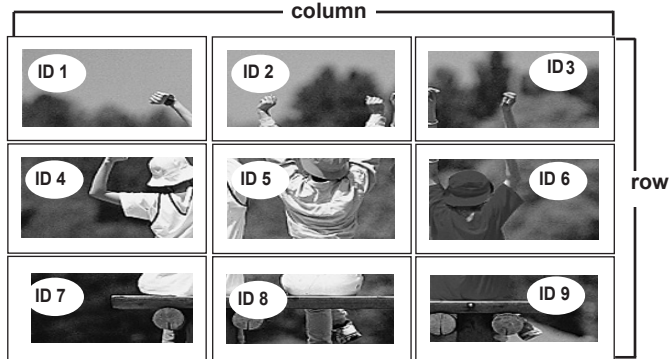

- Tile mode (product 1 ~ 2) : c(2) x r(1)

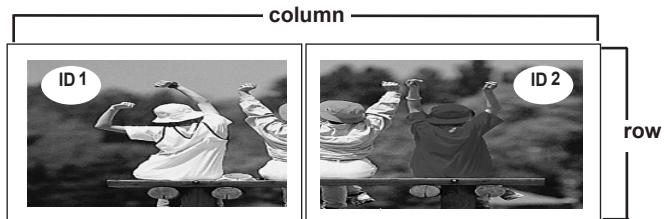

- Tile mode (product 1 ~16) : c(4) x r(4)

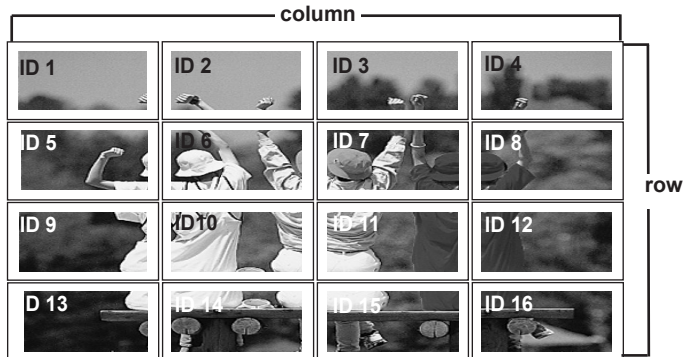









User Menus



Selecting the options

Tile mode

Option	
	Language
	Key Lock
	ISM Method
	Indicator
	DPM Select
	Tile Mode ▶
	Network Setup
	Factory Reset
▲▼◀▶⊙ MENU	

Tile Mode	Off
H-Size	0
V-Size	0
H-Position	<>
V-Position	<>
Reset	
Tile ID	1
Natural	Off

- **H-Size** Adjust the horizontal size of the screen taking into account the size of the bezel.
- **V-Size** Adjust the vertical size of the screen taking into account the size of the bezel.
- **H-Position** Moving the screen position horizontally.
- **V-Position** Moving the screen position vertically.
- **Reset** Function to initialize and release Tile.
All Tile setting are released when selecting Tile recall and the screen returns to Full screen.
- **Tile ID** Select the location of the Tile by setting an ID.
- **Natural** The image is omitted by the distance between the screens to be naturally shown.

User Menus



Selecting the options

Network Setup Sets up network information.

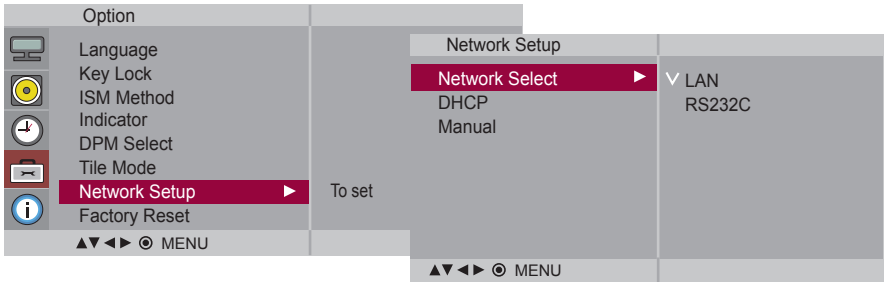

- **Network Select** Sets up network connections.
 - LAN : Enables communication via Ethernet.
 - RS232C : Enables communication via Serial.
- **DHCP** Allocates and sets up IP automatically.
- **Manual** Sets up IP address, Gateway, Subnet Mask, Primary DNS and Secondary DNS. The setup process is complete when you select Execute, and **"IP Setup Completed"** is displayed at the bottom of the screen. While **"Wait for IP Setup"** is displayed, you cannot use the local keys and remote control. **"Wait for IP Setup"** is displayed for up to 40 seconds.

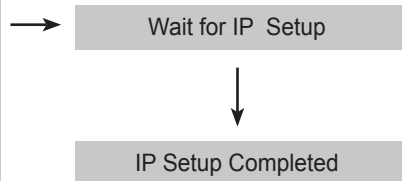
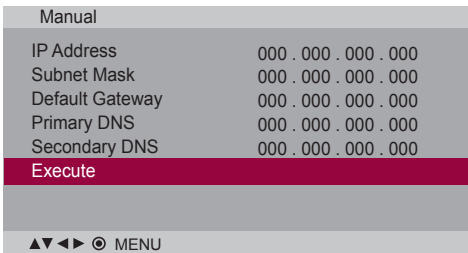

*If Network Select is set to Serial, DHCP and Manual are disabled.

Factory Reset Select this option to return to the default factory settings.

User Menus



Adjust Set ID and check Serial No. and SW version.

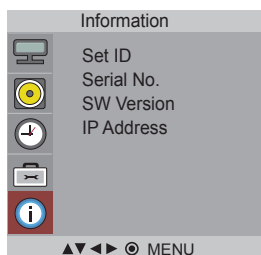

- Set ID** You can assign a unique **Set ID** NO (name assignment) to each product when several products are connected for display. Specify the number (01H~63H) using the ▼▲ button and exit. Use the assigned **Set ID** to individually control each product using the Product Control Program.
- Serial No.** This menu shows the serial number of the product.
- SW Version** This menu shows the software version.
- IP Address** Displays a selected network's IP address.

Troubleshooting

No image is displayed

- Is the product power cord connected?
 - Is the power indicator light on?
 - Power is on, power indicator is blue but the screen appears extremely dark.
 - The power indicator amber?
 - Does the 'Out of range' message appear?
 - Does the 'Check signal cable' message appear?
- See if the power cord is properly connected to the outlet.
 - See if the power switch is turned on.
 - May need service.
 - Adjust brightness and contrast again.
 - Backlight may need repair.
 - If the product is in power saving mode, move the mouse or press any key.
 - Turn both devices off and then back on.
 - The signal from the PC (video card) is out of the vertical or horizontal frequency range of the product. Adjust the frequency range by referring to the Specifications in this manual.
 - * **Maximum resolution**
 - RGB : 1920 x 1080 @60Hz
 - HDMI/DVI : 1920 x 1080 @60Hz
 - The signal cable between PC and product is not connected. Check the signal cable.
 - Press the 'INPUT' menu in the remote Control to check the input signal.

'UnknownProduct'messageappearswhentheproductisconnected.

- Did you install the driver?
- Install the product driver, which is provided with the product, or download it from the web site. (<http://www.lge.com>)
 - See if the plug&play function is supported by referring to the video card user manual.

'Key Lock On' message appears.

- The 'Key Lock On' message appears when pressing the Menu button.
- The control locking function prevents unintentional OSD setting change due to careless usage. To unlock the controls, simultaneously press the Menu button and ► button for several seconds. (You cannot set this function using the remote control buttons. You can set this function in the product only.)

Note



- * **Vertical frequency:** To enable the user to watch the product display, screen image should be changed tens of times every second like a fluorescent lamp. The vertical frequency or refresh rate is the times of image display per second. The unit is Hz.
- * **Horizontal frequency:** The horizontal interval is the time to display one vertical line. When 1 is divided by the horizontal interval, the number of horizontal lines displayed every second can be tabulated as the horizontal frequency. The unit is kHz.

Troubleshooting

The screen image looks abnormal.

- **Is the screen position wrong?**
 - D-Sub analog signal - Press the "AUTO" button in the remote control to automatically select the optimal screen status that fits into the current mode. If adjustment is not satisfactory, use the Position OSD menu.
 - See if the video card resolution and frequency are supported by the product. If the frequency is out of range, set to the recommended resolution in the Control Panel "Display" Setting menu.
- **Do thin lines appear on the background screen?**
 - D-Sub analog signal - Press the "AUTO" button in the remote control to automatically select an optimal screen status that fits into the current mode. If adjustment is not satisfactory, use the Clock OSD menu.
- **Horizontal noise appears or the characters look blurred.**
 - D-Sub analog signal - Press the "AUTO" button in the remote control to automatically select an optimal screen status that fits into the current mode. If adjustment is not satisfactory, use the Phase OSD menu.
- **The screen is displayed abnormally.**
 - The proper input signal is not connected to the signal port. Connect the signal cable that matches with the source input signal.

After-image appears on the product.

- **After-image appears when the product is turned off.**
 - If you use a fixed image for a long time, the pixels may be damaged quickly. Use the screen-saver function.

Troubleshooting

The audio function does not work.

- **No sound?**
 - See if the audio cable is connected properly.
 - Adjust the volume.
 - See if the sound is set properly.
- **Sound is too dull.**
 - Select the appropriate equalize sound.
- **Sound is too low.**
 - Adjust the volume.

Screen color is abnormal.

- **Screen has poor color resolution (16 colors).**
 - Set the number of colors to more than 24 bits (true color)
Select Control Panel - Display - Settings - Color Table menu in Windows.
- **Screen color is unstable or mono-colored.**
 - Check the connection status of the signal cable.
Or, re-insert the PC video card.
- **Do black spots appear on the screen?**
 - Several pixels (red, green, white or black color) may appear on the screen, which can be attributable to the unique characteristics of the LCD panel. It is not a malfunction of the LCD.

The operation does not work normally.

- **The power suddenly turned off.**
 - Is the sleep timer set?
 - Check the power control settings.
Power interrupted.
 - "CAUTION! FAN STOP!"
If the power is turned off after this message appears, it means that the fan is out of order. In this case, contact your local service center.



Specifications

The product specifications can change without prior notice for product improvement.

Video Signal	Max. Resolution	RGB : 1920 X 1080 @60Hz HDMI/DVI : 1920 X 1080 @60Hz - It may not be supported depending on the OS or video card type.
	Recommended Resolution	RGB : 1920 X 1080 @60Hz HDMI/DVI : 1920 X 1080 @60Hz - It may not be supported depending on the OS or video card type.
	Horizontal Frequency	RGB : 30 - 83 kHz HDMI/DVI : 30 - 83 kHz
	Vertical Frequency	RGB : 56 - 75 Hz HDMI/DVI : 56 - 60 Hz
	Synchronization Type	Composite/Separate/Digital
Input Connector	15-pin D-Sub type, HDMI (digital), S-Video, Composite Video, Component, RS-232C, LAN	
Environmental Conditions	Operational Condition	Temperature: 0°C~ 40°C , Humidity: 10% ~ 80%
	Storage Condition	Temperature: -20°C ~ 60°C , Humidity: 5% ~ 90%

* Applicable only for models that support the speakers

Audio	RMS Audio Output	10W+10W(R+L)
	Input Sensitivity	0.7Vrms
	Speaker Impedance	8Ω

NOTE

- Information in this document is subject to change without notice.

Specifications

● PC Mode - Preset Mode

Preset mode		Horizontal Frequency (kHz)	Vertical Frequency (Hz)	Preset mode		Horizontal Frequency (kHz)	Vertical Frequency (Hz)
1	640 x 350	31.469	70.8	*11	1280 x 768	47.7	60
2	720 x 400	31.468	70.8	*12	1360 x 768	47.72	59.799
*3	640 x 480	31.469	59.94	*13	1366 x 768	47.7	60
4	640 x 480	37.5	75	*14	1280 x 1024	63.981	60.02
*5	800 x 600	37.879	60.317	15	1280 x 1024	79.98	75.02
6	800 x 600	46.875	75	*16	1680 x 1050	65.290	59.954
7	832 x 624	49.725	74.55	*17	1920 x 1080	67.5	60
*8	1024 x 768	48.363	60				
9	1024 x 768	60.123	75.029				
*10	1280 x 720	44.772	59.855				

1~17: RGB Mode
* : HDMI/DVI mode

● DTV Mode

	Component	HDMI/DVI(DTV)
480i	o	x
576i	o	x
480p	o	o
576p	o	o
720p	o	o
1080i	o	o
1080p	o	o

● Power Indicator

Mode	Product
On Mode	Blue
Sleep Mode	Amber
Off Mode	-

NOTE

- DTV/PC selection on RGB and HDMI/DVI inputs is available for PC resolutions : 640 X 480/60Hz, 1280 X 720/60Hz, 1920 X 1080/60Hz and DTV resolutions : 480p, 720p, 1080p.

**Use this method to connect several products to a single PC.
You can control several products at a time by connecting them to a single PC.**

Connecting the cable

Connect the RS-232C cable as shown in the picture.

* The RS-232C protocol is used for communication between the PC and product. You can turn the product on/off, select an input source or adjust the OSD menu from your PC.

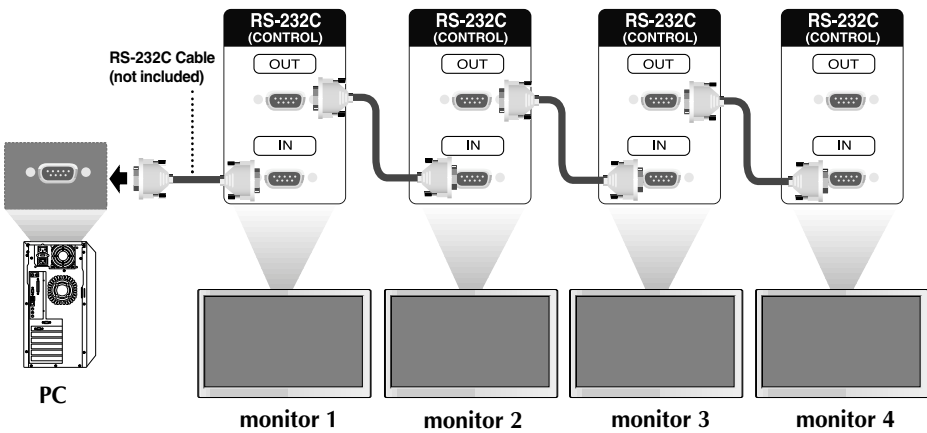

RS-232C Configurations

7-Wire Configurations (Standard RS-232C cable)

	PC	Monitor	
RXD	2	3	TXD
TXD	3	2	RXD
GND	5	5	GND
DTR	4	6	DSR
DSR	6	4	DTR
RTS	7	8	CTS
CTS	8	7	RTS

D-Sub 9 (Female) D-Sub 9 (Female)

3-Wire Configurations (Not Standard)

	PC	Monitor	
RXD	2	3	TXD
TXD	3	2	RXD
GND	5	5	GND
DTR	4	6	DTR
DSR	6	4	DSR
RTS	7	7	RTS
CTS	8	8	CTS

D-Sub 9 (Female) D-Sub 9 (Female)

Communication Parameter

- ▶ Baud Rate : 9600baud Rate (UART)
- ▶ Data Length : 8bits
- ▶ Parity Bit : None
- ▶ Stop Bit : 1bit
- ▶ Flow Control : None
- ▶ Communication Code : ASCII code
- ▶ Use a crossed (reverse) cable

 Command Reference List

	COMMAND1	COMMAND2	DATA1	DATA2	DATA3
01. Power	k	a	00H - 01H		
02. Input Select	k	b	02H - 09H		
03. Aspect Ratio	k	c	01H - 09H		
04. Screen Mute	k	d	00H - 01H		
05. Volume Mute	k	e	00H - 01H		
06. Volume Control	k	f	00H - 64H		
07. Contrast	k	g	00H - 64H		
08. Brightness	k	h	00H - 64H		
09. Color	k	i	00H - 64H		
10. Tint	k	j	00H - 64H		
11. Sharpness	k	k	00H - 64H		
12. OSD Select	k	l	00H - 01H		
13. Remote Lock/ key Lock	k	m	00H - 01H		
14. Balance	k	t	00H - 64H		
15. Color Temperature	k	u	00H - 03H		
16. Abnormal state	k	z	FFH		
17. ISM mode	j	p	00H - 10H		
18. Auto configuration	j	u	01H		
19. Key	m	c	Key Code		
20. Tile Mode	d	d	00H - 55H		
21. Tile H Position	d	e	00H - 64H		
22. Tile V Position	d	f	00H - 64H		
23. Tile H Size	d	g	00H - 64H		
24. Tile V Size	d	h	00H - 64H		
25. Tile ID Set	d	i	00H - 19H		
26. Natural Mode (In Tile mode)	d	j	00H - 01H		
27. Picture mode(PSM)	d	x	00H - 06H		
28. Sound mode	d	y	00H - 06H		
29. Fan Fault check	d	w	FFH		
30. Elapsed time return	d	l	FFH		
31. Temperature value	d	n	FFH		
32. Lamp fault check	d	p	FFH		
33. Auto Volume	d	u	00H - 01H		
34. Speaker	d	v	00H - 01H		
35. Time	f	a	00H - 06H	00H - 17H	00 - 3BH
36. On Timer (On/Off Timer) On, Off	f	b	00H, FFH	00H - FFH	
37. Off Timer (On/Off Timer) On, Off	f	c	00H, FFH	00H - FFH	
38. On Timer (On/Off Timer) Time	f	d	00H - 07H	00H - 17H	00 - 3BH
39. Off Timer (On/Off Timer) Time	f	e	00H - 07H	00H - 17H	00 - 3BH
40. Sleep Time	f	f	00H - 08H		
41. Auto Sleep	f	g	00H - 01H		
42. Power On Delay	f	h	00H - 64H		
43. Language	f	i	00H - 09H		
44. DPM Select	f	j	00H - 01H		
45. Reset	f	k	00H - 02H		

Controlling the Multiple Product

	COMMAND1	COMMAND2	DATA1	DATA2	DATA3
46. Power Saving	f	l	00H - 03H		
47. Power Indicator	f	o	00H - 01H		
48. H Position	f	q	00H - 64H		
49. V Position	f	r	00H - 64H		
50. H Size	f	s	00H - 64H		
51. V Size	f	t	00H - 64H		
52. Scheduling input select	f	u	00H - 07H	00H - FEH	
53. Serial no.	f	y	FFH		
54. S/W Version	f	z	FFH		
55. Input Select	x	b	20H - A0H		

● Transmission / Receiving Protocol

Transmission

[Command1][Command2][][Set ID][][Data][Cr]

- * [Command 1]: First command. (k, j, m, d, f,x)
- * [Command 2]: Second command.(a ~ u)
- * [Set ID]: Set up the Set ID number of product.
range : 01H~63H. by setting '0', server can control all products.
* In case of operating with more than 2 sets using set ID as '0' at the same time, it should not be checked the ack message.
Because all sets will send the ack message, so it's impossible the check the whole ack messages.
- * [DATA]: To transmit command data.
Transmit 'FF' data to read status of command.
- * [Cr]: Carriage Return
ASCII code '0x0D'
- * []: ASCII code Space (0x20)

OK Acknowledgement

[Command2][][Set ID][][OK][Data][x]

- * The Product transmits ACK (acknowledgement) based on this format when receiving normal data. At this time, if the data is data read mode, it indicates present status data.
If the data is data write mode, it returns the data of the PC computer.

Error Acknowledgement

[Command2][][Set ID][][NG][Data][x]

- * If there is error, it returns NG

● Transmission / Receiving Protocol

01. Power(Command : a)

- ▶ To control Power On/Off of the Set.

Transmission

```
[k][a][ ][Set ID][ ][Data][Cr]
```

Data 0 : Power Off 1 : Power On

Acknowledgement

```
[a][ ][Set ID][ ][OK][Data][x]
```

- ▶ To show the status of Power On/Off.

Transmission

```
[k][a][ ][Set ID][ ][FF][Cr]
```

Acknowledgement

```
[a][ ][Set ID][ ][OK][Data][x]
```

Data 0 : Power Off 1 : Power On

02. Input Select (Command : b) (Main Picture Input)

- ▶ To select input source for the Set.
You can also select an input source using the INPUT button on the remote control.

Transmission

```
[k][b][ ][Set ID][ ][Data][Cr]
```

Data 2 : AV
4 : Component
7 : RGB (PC)
8 : HDMI (DTV)
9 : HDMI (PC)

Acknowledgement

```
[b][ ][Set ID][ ][OK][Data][x]
```

Data 2 : AV
4 : Component
7 : RGB (PC)
8 : HDMI (DTV)
9 : HDMI (PC)

● Transmission / Receiving Protocol

03. Aspect Ratio(Command : c) (Main picture format)

- ▶ To adjust the screen format.

You can also adjust the screen format using the ARC (Aspect Ratio Control) button on remote control or in the Screen menu.

Transmission

```
[k][c][ ][Set ID][ ][Data][Cr]
```

Data 1 : Normal Screen (4:3)

2 : Wide Screen (16 :9)

4 : Zoom1 (AV)

5 : Zoom2 (AV)

6 : Original (AV)

7 :14:9 (AV)

9 : Just Scan(HD DTV), 1:1 (RGB PC, HDMI/DVI PC)

Acknowledgement

```
[c][ ][Set ID][ ][OK][Data][x]
```

04. Screen Mute(Command : d)

- ▶ To select screen mute on/off.

Transmission

```
[k][d][ ][Set ID][ ][Data][Cr]
```

Data 0 : Screen mute off (Picture on)

1 : Screen mute on (Picture off)

Acknowledgement

```
[d][ ][Set ID][ ][OK][Data][x]
```

Transmission / Receiving Protocol

05. Volume Mute(Command : e)

- ▶ To control On/Off of the Volume Mute.

Transmission

```
[k][e][ ][Set ID][ ][Data][Cr]
```

Data 0 : Volume Mute On (Volume Off)
1 : Volume Mute Off (Volume On)

Acknowledgement

```
[e][ ][Set ID][ ][OK][Data][x]
```

Data 0 : Volume Mute On (Volume Off)
1 : Volume Mute Off (Volume On)

06. Volume Control(Command : f)

- ▶ To adjust Volume .

Transmission

```
[k][f][ ][Set ID][ ][Data][Cr]
```

Data Min : 00H ~ Max : 64H
(Hexadecimal code)

Acknowledgement

```
[f][ ][Set ID][ ][OK][Data][x]
```

Data Min : 00H ~ Max : 64H

- Refer to 'Real data mapping' page A8.

● Transmission / Receiving Protocol

07. Contrast(Command : g)

- ▶ To adjust screen contrast.
You can also adjust the contrast in the Picture menu.

Transmission

```
[k][g][ ][Set ID][ ][Data][Cr]
```

Data Min : 00H ~ Max : 64H

- Refer to 'Real data mapping' as shown below.

Acknowledgement

```
[g][ ][Set ID][ ][OK][Data][x]
```

* Real data mapping

0 : Step 0

:

A : Step 10

:

F : Step 15

10 : Step 16

:

64 : Step 100

08. Brightness(Command : h)

- ▶ To adjust screen brightness.
You can also adjust the brightness in the Picture menu.

Transmission

```
[k][h][ ][Set ID][ ][Data][Cr]
```

Data Min : 00H ~ Max : 64H

- Refer to 'Real data mapping' as shown below.

Acknowledgement

```
[h][ ][Set ID][ ][OK][Data][x]
```

* Real data mapping

0 : Step

:

A : Step 10

:

F : Step 15

10 : Step 16

:

64 : Step 100

● Transmission / Receiving Protocol

09. Color(Command : i) (Video Timing only)

▶ To adjust the screen color.

You can also adjust the color in the Picture menu.

Transmission

```
[k][i][ ][Set ID][ ][Data][Cr]
```

Data Min : 00H ~ Max : 64H
(Hexadecimal code)

- Refer to 'Real data mapping' page A8.

Acknowledgement

```
[l][ ][Set ID][ ][OK][Data][x]
```

Data Min : 00H ~ Max : 64H

10. Tint(Command : j) (Video Timing only)

▶ To adjust the screen tint.

You can also adjust the tint in the Picture menu.

Transmission

```
[k][j][ ][Set ID][ ][Data][Cr]
```

Data Red: 00H ~ Green: 64H
(Hexadecimal code)

- Refer to 'Real data mapping' page A8.

Acknowledgement

```
[l][ ][Set ID][ ][OK][Data][x]
```

Data Red: 00H ~ Green: 64H

* Tint Real data mapping

0 : Step 0 - Red

:

64 : Step 100 - Green

● Transmission / Receiving Protocol

11. Sharpness(Command : k) (Video Timing only)

- ▶ To adjust the screen Sharpness.
You can also adjust the sharpness in the Picture menu.

Transmission

```
[k][k][ ][Set ID][ ][Data][Cr]
```

Data Min : 00H ~ Max : 64H
(Hexadecimal code)

- Refer to 'Real data mapping' page A8.

Acknowledgement

```
[k][ ][Set ID][ ][OK][Data][x]
```

Data Min : 00H ~ Max : 64H

12. OSD Select(Command : l)

- ▶ To control OSD on/off to the set.

Transmission

```
[k][l][ ][Set ID][ ][Data][Cr]
```

Data 0 : OSD Off 1 : OSD On

Acknowledgement

```
[l][ ][Set ID][ ][OK][Data][x]
```

Data 0 : OSD Off 1 : OSD On

13. Remote Lock /Key Lock (Command : m)

- ▶ To control Remote Lock on/off to the set.
This function, when controlling RS-232C, locks the remote control and the local keys.

Transmission

```
[k][m][ ][Set ID][ ][Data][Cr]
```

Data 0 : Off 1 : On

Acknowledgement

```
[m][ ][Set ID][ ][OK][Data][x]
```

Data 0 : Off 1 : On

● Transmission / Receiving Protocol

14 Balance(Command : t)

▶ To adjust the sound balance.

Transmission

```
[k][t][ ][Set ID][ ][Data][Cr]
```

Data Min : 00H ~ Max : 64H

(Hexadecimal code)

- Refer to 'Real data mapping' page A8.

Acknowledgement

```
[t][ ][Set ID][ ][OK][Data][x]
```

Data Min : 00H ~ Max : 64H

* Balance : L50 ~ R50

15. Color Temperature (Command : u)

▶ To adjust the screen color temperature.

Transmission

```
[k][u][ ][Set ID][ ][Data][Cr]
```

Data 0 : Medium

1 : Cool

2 : Warm

3 : User

Acknowledgement

```
[u][ ][Set ID][ ][OK][Data][x]
```

Data 0 : Medium

1 : Cool

2 : Warm

3 : User

- Running the Color Temperature command changes the Picture Mode settings to User1.

● Transmission / Receiving Protocol

16. Abnormal state (Command : z)

▶ Abnormal State : Used to Read the power off status when Stand-by mode.

Transmission

```
[k][z][ ][Set ID][ ][Data][Cr]
```

Data FF : Read

- 0 : Normal (Power on and signal exist)
- 1 : No signal (Power on)
- 2 : Turn the monitor off by remote control
- 3 : Turn the monitor off by sleep time function
- 4 : Turn the monitor off by RS-232C function
- 8 : Turn the monitor off by off time function
- 9 : Turn the monitor off by auto off function

Acknowledgement

```
[z][ ][Set ID][ ][OK][Data][x]
```

17. ISM mode(Command: j p)

▶ Used to select the afterimage preventing function.

Transmission

```
[j][p][ ][Set ID][ ][Data][Cr]
```

- Data
- 1H : Inversion
 - 2H : Orbiter
 - 4H : White Wash
 - 8H : Normal
 - 10H : Dot Wash

Acknowledgement

```
[p][ ][Set ID][ ][OK][Data][x]
```

● Transmission / Receiving Protocol

18. Auto Configure(Command: j u)

- ▶ To adjust picture position and minimize image shaking automatically. it works only in RGB(PC) mode.

Transmission

```
[j][u][ ][Set ID][ ][Data][Cr]
```

Data 1 : To set

Acknowledgement

```
[u][ ][Set ID][ ][OK][Data][x]
```

19. Key(Command : m c)

- ▶ To send IR remote key code.

Transmission

```
[m][c][ ][Set ID][ ][Data][Cr]
```

Data Key code : Refer to page A34.

Acknowledgement

```
[c][ ][Set ID][ ][OK][Data][x]
```

● Transmission / Receiving Protocol

20. Tile Mode(Command : d d)

▶ Change a Tile Mode.

Transmission

```
[d][d][Set ID][Data][x]
```

Data	Description
00 or 11	Tile mode is off.
12	1 x 2 mode(column x row)
13	1 x 3 mode
14	1 x 4 mode
...	...
55	5 x 5 mode

* The data can not be set to 0X or X0 except 00.

Acknowledgement

```
[d][00][OK/NG][Data][x]
```

● Transmission / Receiving Protocol

21. Tile H Position(Command : d e)

▶To set the Horizontal position.

Transmission

```
[d][e][ ][Set ID][ ][Data][x]
```

Data Min : 00H ~ Max : 64H

• Refer to 'Real data mapping' page A8.

Acknowledgement

```
[e][ ][Set ID][ ][OK/NG][Data][x]
```

22. Tile V Position(Command : d f)

▶To set the Vertical position.

Transmission

```
[d][f][ ][Set ID][ ][Data][x]
```

Data Min : 00H ~ Max : 64H

• Refer to 'Real data mapping' page A8.

Acknowledgement

```
[f][ ][Set ID][ ][OK/NG][Data][x]
```

● Transmission / Receiving Protocol

23. Tile H Size(Command : d g)

▶ To set the Horizontal size.

Transmission

```
[d][g][ ][Set ID][ ][Data][x]
```

Data Min : 00H ~ Max : 64H

• Refer to 'Real data mapping' page A8.

Acknowledgement

```
[g][ ][Set ID][ ][OK/NG][Data][x]
```

24. Tile V Size(Command : d h)

▶ To set the Vertical size.

Transmission

```
[d][h][ ][Set ID][ ][Data][x]
```

Data Min : 00H ~ Max : 64H

• Refer to 'Real data mapping' page A8.

Acknowledgement

```
[h][ ][Set ID][ ][OK/NG][Data][x]
```

● Transmission / Receiving Protocol

25. Tile ID Set(Command : d i)

- ▶ To assign the Tile ID for Tiling function .

Transmission

```
[d][i][Set ID][Data][x]
```

Data Min : 00H ~ Max : 19H
(Hexadecimal code)

Acknowledgement

```
[i][Set ID][OK/NG][Data][x]
```

26 Natural Mode (In Tile mode) (Command : d j)

- ▶ To assign the Tile Natural mode for Tiling function .

Transmission

```
[d][j][Set ID][Data][x]
```

Data 0 : Natural Off
1 : Natural On
ff : Read Status

Acknowledgement

```
[j][Set ID][OK/NG][Data][x]
```

27. Picture Mode (Command : d x)

- ▶ To adjust the picture mode.

Transmission

```
[d][x][Set ID][Data][x]
```

Data Structure

Data(Hex)	MODE
00	Vivid
01	Standard
02	Cinema
03	Sport
04	Game
05	User1
06	User2

Acknowledgement

```
[x][Set ID][OK/NG][Data][x]
```

● Transmission / Receiving Protocol

28. Sound Mode (Command : d y)

▶ To adjust the Sound mode.

Transmission

```
[d][y][Set ID][Data][x]
```

Data Structure

Data(Hex)	Mode
00	Clear Voice
01	Standard
02	Music
03	Cinema
04	sport
05	Game
06	User

Acknowledgement

```
[y][Set ID][OK/NG][Data][x]
```

29. Fan Fault check (Command : d w)

▶ To check the Fan fault of the TV.

Transmission

```
[d][w][Set ID][Data][x]
```

* The data is always FF(in Hex).

Data ff: Read Status

Acknowledgement

```
[w][Set ID][OK/NG][Data][x]
```

* Data is the status value of the Fan fault.

Data 0: Fan fault

1: Fan OK

2: N/A(Not Available)

● Transmission / Receiving Protocol

30. Elapsed time return(Command : d l)

- ▶ To read the elapsed time.

Transmission

```
[d][l][Set ID][Data][x]
```

- * The data is always FF(in Hex).

Acknowledgement

```
[l][Set ID][OK/NG][Data][x]
```

- * The data means used hours.
(Hexadecimal code)

31. Temperature value (Command : d n)

- ▶ To read the inside temperature value.

Transmission

```
[d][n][Set ID][Data][x]
```

- * The data is always FF(in Hex).

Acknowledgement

```
[n][Set ID][OK/NG][Data][x]
```

- * The data is 1 byte long in Hexadecimal.

32. Lamp fault Check(Command : d p)

- ▶ To check lamp fault.

Transmission

```
[d][p][Set ID][Data][x]
```

- * The data is always FF(in Hex).

Acknowledgement

```
[p][Set ID][OK/NG][Data][x]
```

- Data 0 : Lamp Fault
- 1: Lamp OK

 Transmission / Receiving Protocol**33. Auto volume (Command : d u)**

- ▶ Automatically adjust the volume level.

Transmission

[d][u][Set ID][Data][x]

Data 0 : Off
1 : On

Acknowledgement

[u][Set ID][OK/NG][Data][x]

34. Speaker (Command : d v)

- ▶ Turn the speaker on or off.

Transmission

[d][v][Set ID][Data][x]

Data 0 : Off
1 : On

Acknowledgement

[v][Set ID][OK/NG][Data][x]

 Transmission / Receiving Protocol
35. Time (Command : f a)

▶ Set the current time.

Transmission

```
[f][a][Set ID][Data1][Data2][Data3][Cr]
```

[Data1]

0 : Monday

1 : Tuesday

2 : Wednesday

3 : Thursday

4 : Friday

5 : Saturday

6 : Sunday

[Data2]

0H~17H (Hours)

[Data3]

00H~3BH (Minutes)

Acknowledgement

```
[a][Set ID][OK/NG][Data1][Data2][Data3][x]
```

*When reading data, FFH is inputted for [Data1], [Data2] and [Data3].
In other cases, all are treated as NG.

● Transmission / Receiving Protocol

36. On Timer (On/Off Timer) On, Off (Command : F b)

- ▶ Set days for On Timer.

Transmission

```
[f][b][Set ID][Data1][Data2][Cr]
```

[Data1]

0 (Write), FFH(Read)

[Data2]

00H~FFH

bit0 : Monday On Timer On(1), Off(0)

bit1 : Tuesday On Timer On(1), Off(0)

bit2 : Wednesday On Timer On(1), Off(0)

bit3 : Thursday On Timer On(1), Off(0)

bit4 : Friday On Timer On(1), Off(0)

bit5 : Saturday On Timer On(1), Off(0)

bit6 : Sunday On Timer On(1), Off(0)

bit7 : Everyday On Timer On(1), Off(0)

Acknowledgement

```
[b][Set ID][OK/NG][Data1][Data2][x]
```

* Ignore from bit6 to bit0 when bit7(Everyday) is 1.

37. Off Timer (On/Off Timer) On, Off (Command : f c)

- ▶ Set days for Off Timer.

Transmission

```
[f][c][Set ID][Data1][Data2][Cr]
```

[Data1]

0 (Write), FFH(Read)

[Data2]

00H~FFH

bit0 : Monday Off Timer On(1), Off(0)

bit1 : Tuesday Off Timer On(1), Off(0)

bit2 : Wednesday Off Timer On(1), Off(0)

bit3 : Thursday Off Timer On(1), Off(0)

bit4 : Friday Off Timer On(1), Off(0)

bit5 : Saturday Off Timer On(1), Off(0)

bit6 : Sunday Off Timer On(1), Off(0)

bit7 : Everyday Off Timer On(1), Off(0)

Acknowledgement

```
[c][Set ID][OK/NG][Data1][Data2][x]
```

* Ignore from bit6 to bit0 when bit7(Everyday) is 1.

 Transmission / Receiving Protocol
38. On Timer (On/Off Timer) Time (Command : f d)

▶ Set On Timer.

Transmission

[f][d][Set ID][Data1][Data2][Data3][Cr]

[Data1]

0 : Monday

1 : Tuesday

2 : Wednesday

3 : Thursday

4 : Friday

5 : Saturday

6 : Sunday

7 : Everyday

[Data2]

00H~17H (Hours)

[Data3]

00H~3BH (Minutes)

Acknowledgement

[d][Set ID][OK/NG][Data1][Data2][Data3][x]
--

*When reading data, FFH is inputted for [Data2], [Data3].
In other cases, all are treated as NG.

● Transmission / Receiving Protocol

39. Off Timer (On/Off Timer) Time (Command : f e)

▶ Set Off Timer.

Transmission

```
[f][e][Set ID][Data1][Data2][Data3][Cr]
```

[Data1]

0 : Monday

1 : Tuesday

2 : Wednesday

3 : Thursday

4 : Friday

5 : Saturday

6 : Sunday

7 : Everyday

[Data2]

00H~17H (Hours)

[Data3]

00H~3BH (Minutes)

Acknowledgement

```
[e][Set ID][OK/NG][Data1][Data2][Data3][x]
```

*When reading data, FFH is inputted for [Data2], [Data3].
In other cases, all are treated as NG.

 Transmission / Receiving Protocol
40. Sleep Time (Command : f f)

▶ Set Sleep Time.

Transmission

[f][f][Set ID][Data][Cr]

Data

0 : Off

1 : 10

2 : 20

3 : 30

4 : 60

5 : 90

6 : 120

7 : 180

8 : 240

(Orderly)

Acknowledgement

[f][Set ID][OK/NG][Data][x]

41. Auto Sleep (Command : f g)

▶ Set Auto Sleep.

Transmission

[f][g][Set ID][Data][Cr]

Data 0 : Off

1: On

Acknowledgement

[g][Set ID][OK/NG][Data][x]

● Transmission / Receiving Protocol

42. Power On Delay (Command : f h)

- ▶ Set the schedule delay when the power is turned on (Unit: second).

Transmission

```
[f][h][ ][Set ID][ ][Data][Cr]
```

Data : 00H ~ 64H (Data value)

- Refer to 'Real data mapping' page A8.

Acknowledgement

```
[h][ ][Set ID][ ][OK/NG][Data][x]
```

43. Language (Command : f i)

- ▶ Set the OSD language.

Transmission

```
[f][i][ ][Set ID][ ][Data][Cr]
```

Data

- 0 : English
- 1 : French
- 2 : German
- 3 : Spanish
- 4 : Italian
- 5 : Portuguese
- 6 : Chinese
- 7 : Japanese
- 8 : Korean
- 9 : Russian

Acknowledgement

```
[i][ ][Set ID][ ][OK/NG][Data][x]
```

● Transmission / Receiving Protocol

44. DPM Select (Command : f j)

- ▶ Set the DPM (Display Power Management) function.

Transmission

```
[f][j][Set ID][Data][Cr]
```

Data 0 : Off
1 : On

Acknowledgement

```
[j][Set ID][OK/NG][Data][x]
```

45. Reset (Command : f k)

- ▶ Execute the Picture, Screen and Factory Reset functions.

Transmission

```
[f][k][Set ID][Data][Cr]
```

Data
0 : Picture Reset
1 : Screen Reset
2 : Factory Reset

Acknowledgement

```
[k][Set ID][OK/NG][Data][x]
```

● Transmission / Receiving Protocol

46. Power saving(Command : f l)

▶ To set the Power saving mode.

Transmission

```
[f][l][Set ID][Data][Cr]
```

Data 0 : Off

- 1: (static level 1)
- 2: (static level 2)
- 3: (static level 3)

Acknowledgement

```
[l][Set ID][OK/NG][Data][x]
```

47. Power Indicator (Command : f o)

▶ To set the LED for Power Indicator

Transmission

```
[f][o][Set ID][Data][Cr]
```

Data 0 : Off

- 1: On

Acknowledgement

```
[o][Set ID][OK/NG][Data][x]
```

48. H Position (Command : f q)

▶ To set the Horizontal position

Transmission

```
[f][q][Set ID][Data][Cr]
```

* The data range is from 00 to 64(in Hex)

- Refer to 'Real data mapping' page A8.

Acknowledgement

```
[q][Set ID][OK/NG][Data][x]
```

● Transmission / Receiving Protocol

49. V Position (Command : f r)

▶ To set the Horizontal position

Transmission

```
[f][r][ ][Set ID][ ][Data][Cr]
```

- * The data range is from 00 to 64(in Hex)
- Refer to 'Real data mapping' page A8.

Acknowledgement

```
[r][ ][Set ID][ ][OK/NG][Data][x]
```

50. H Size (Command : f s)

▶ To set the Horizontal size.

Transmission

```
[f][s][ ][Set ID][ ][Data][Cr]
```

- * The data range is from 00 to 64(in Hex)
- Refer to 'Real data mapping' page A8.

Acknowledgement

```
[s][ ][Set ID][ ][OK/NG][Data][x]
```

* H Size Real Data Mapping

[Data1]

- 0x00: Step 0
- 0x0A: Step 10
- 0x14: Step 20
- 0x1E: Step 30
- 0x28: Step 40
- 0x32: Step 50
- 0x3C: Step 60
- 0x46: Step 70
- 0x50: Step 80
- 0x5A: Step 90
- 0x64: Step 100

● Transmission / Receiving Protocol

51. V Size (Command : f t)

▶ To set the Vertical size

Transmission

```
[f][t][ ][Set ID][ ][Data][Cr]
```

- * The data range is from 00 to 64(in Hex)
- Refer to 'Real data mapping' page A8.

Acknowledgement

```
[t][ ][Set ID][ ][OK/NG][Data][x]
```

* V Size Real Data Mapping

[Data1]

- 0x00: Step 0
- 0x0A: Step 10
- 0x14: Step 20
- 0x1E: Step 30
- 0x28: Step 40
- 0x32: Step 50
- 0x3C: Step 60
- 0x46: Step 70
- 0x50: Step 80
- 0x5A: Step 90
- 0x64: Step 100

● Transmission / Receiving Protocol

52. Scheduling Input select (Command : f u) (Main Picture Input)

▶ To select input source for TV depending on day.

Transmission

```
[f][u][Set ID][Data1][Data2][Cr]
```

Data 1 Structure

Min: 0~Max:7(0:Monday, 1: Tuesday, 2: Wednesday, 3: Thursday, 4: Friday
5: Saturday, 6: Sunday, 7: Everyday)

Data 2 Structure

Data(Hex)	INPUT
02	AV
04	Component
07	RGB-PC
08	HDMI/DVI-DTV
09	HDMIDVI-PC
FE	No change

Acknowledgement

```
[u][Set ID][OK/NG][Data 1][Data 2][x]
```

53. Serial no.Check (Command : f y)

▶ To read the serial numbers

Transmission

```
[f][y][Set ID][Data][Cr]
```

Data FF (to read the serial numbers)

Acknowledgement

```
[y][Set ID][OK/NG][Data1] ~ [Data13] [x]
```

* The data format is ASCII Code.

● Transmission / Receiving Protocol

54. S/W Version (Command : f z)

▶ Check the software version.

Transmission

```
[f][z][ ][Set ID][ ][Data][Cr]
```

Data FFH : Read

Acknowledgement

```
[z][ ][Set ID][ ][OK/NG][Data][x]
```

55. Input Select (Command : x b)

▶ To select input source for the Set.

Transmission

```
[x][b][ ][Set ID][ ][Data][Cr]
```

Data 20H : AV
 40H : Component
 60H : RGB (PC)
 90H : HDMI/DVI (DTV)
 A0H : HDMI/DVI (PC)

Acknowledgement

```
[b][ ][Set ID][ ][OK][Data][x]
```

Data 20H : AV
 40H : Component
 60H : RGB (PC)
 90H : HDMI/DVI (DTV)
 A0H : HDMI/DVI (PC)

How to connect

- ▶ Connect your wired remote control to Remote Control port on the Product.

Remote Control IR Code

- ▶ **Output waveform**
single pulse, modulated with 37.917KHz signal at 455KHz

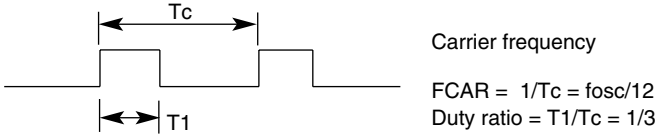

▶ **Configuration of frame**

- 1st frame

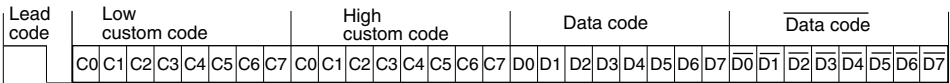

- Repeat frame

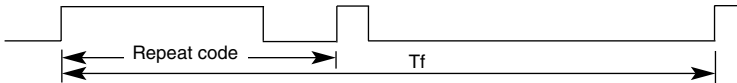

▶ **Lead code**

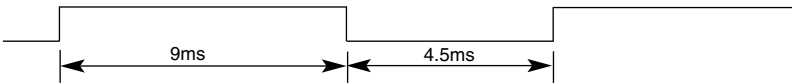

▶ **Repeat code**

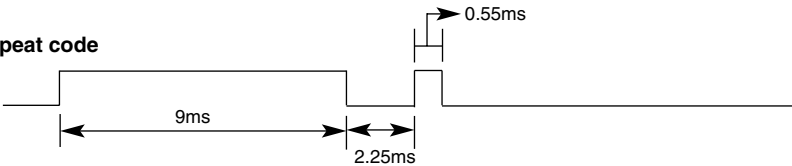

▶ **Bit description**

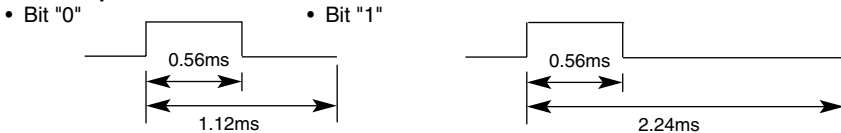

▶ **Frame interval : Tf**

- The waveform is transmitted as long as a key is depressed.

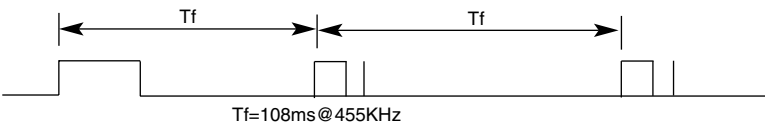

Code(Hex)	Function	Note
00	▲	R/C Button
01	▼	R/C Button
02	VOL(▶)	R/C Button
03	VOL(◀)	R/C Button
08	POWER ON/OFF	R/C Button (Power On/Off)
C4	POWER ON	Discrete IR Code(Only Power On)
C5	POWER OFF	Discrete IR Code(Only Power Off)
09	MUTE	R/C Button
98	AV	R/C Button
0B	INPUT	R/C Button
0E	SLEEP	R/C Button
43	MENU	R/C Button
5B	EXIT	R/C Button
6E	PSM	R/C Button
44	SET	R/C Button
10	Number Key 0	R/C Button
11	Number Key 1	R/C Button
12	Number Key 2	R/C Button
13	Number Key 3	R/C Button
14	Number Key 4	R/C Button
15	Number Key 5	R/C Button
16	Number Key 6	R/C Button
17	Number Key 7	R/C Button
18	Number Key 8	R/C Button
19	Number Key 9	R/C Button
5A	AV	Discrete IR Code(Input AV Selection)
BF	COMPONENT	Discrete IR Code(Input COMPONENT Selection)
D5	RGB PC	Discrete IR Code(Input RGB PC Selection)
C6	HDMI/DVI	Discrete IR Code(Input HDMI/DVI Selection)
79	ARC	R/C Button
76	ARC (4:3)	Discrete IR Code(Only 4:3 mode)
77	ARC (16:9)	Discrete IR Code(Only 16:9 mode)
AF	ARC (ZOOM)	Discrete IR Code(Only ZOOM1, ZOOM2 mode)
99	AUTO CONFIG	Discrete IR Code