

# PLASMA TV OWNER'S MANUAL

## PLASMA TV MODELS

42PQ10**	42PQ60**
50PQ10**	50PQ60**
42PQ11**	50PS20**
50PQ11**	50PS30**
42PQ20**	50PS60**
50PQ20**	60PS40**
42PQ30**	
50PQ30**	

Please read this manual carefully before operating your TV.

Retain it for future reference.

Record the model number and serial number of the TV.

Refer to the label on the back cover and quote this information.

To your dealer when requiring any service.

Model :

Serial No. :



This product qualifies for ENERGY STAR in the "factory default (Home Use mode)" setting and this is the setting in which power savings will be achieved.

Changing the factory default picture setting or enabling other features will increase power consumption that could exceed the limits necessary to qualify for Energy Star rating.

**DVB**<sup>®</sup>  
Digital Video  
Broadcasting

Trade Mark of the DVB Digital Video  
Broadcasting Project (1991 to 1996)

**ID Number(s):** 6551 : 42PQ1000-ZA  
6549 : 50PQ1000-ZA  
6630 : 42PQ1000-ZD  
6631 : 50PQ1000-ZD  
6632 : 42PQ1100-ZE  
6633 : 50PQ1100-ZE  
6023 : 42PQ2000-ZA  
6320 : 42PQ2010-ZB  
6024 : 50PQ2000-ZA  
6319 : 50PQ2010-ZB  
6025 : 42PQ3000-ZA  
6020 : 50PQ3000-ZA  
6026 : 42PQ6000-ZA  
6875 : 42PQ6010-ZB  
6029 : 50PQ6000-ZA  
6884 : 50PS2000-ZB  
6322 : 50PS3000-ZB  
6341 : 50PS6000-ZC  
6609 : 60PS4000-ZA



HDMI, the HDMI logo and High-Definition Multimedia Interface are trademarks or registered trademarks of HDMI Licensing LLC.

# ACCESSORIES

Ensure that the following accessories are included with your TV. If an accessory is missing, please contact the dealer where you purchased the TV.

- Image shown may differ from your TV.

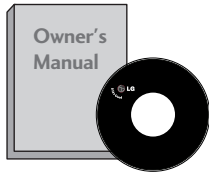

Owner's Manual



Batteries

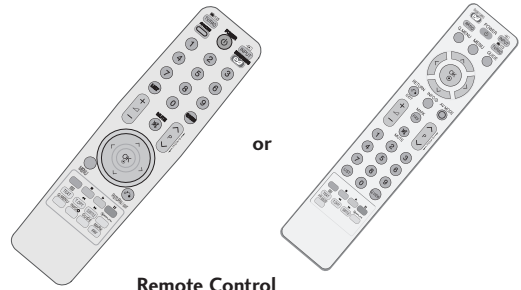

Remote Control



Power Cord

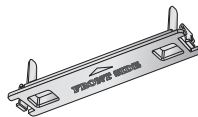

Protection Cover  
(Refer to p.8)

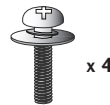

Bolts for stand assembly  
(Refer to p.8)  
(Except for 60PS40\*\*)

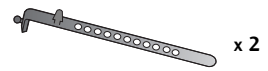

Cable Holder  
(Refer to p.8)



Ferrite Core  
(This item is not included for all models.)



Cable management clip  
(Refer to p.8)  
(Only 60PS40\*\*)

### Wall Mounting Bracket (Separate purchase)

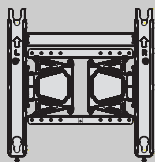

AW-50PG60MS  
(Except for 60PS40\*\*)

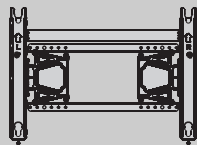

AW-60PG60MS  
(Only 60PS40\*\*)

### This item is not included for all models.



#### Polishing Cloth

Polishing cloth for use on the screen.

\* Lightly wipe any stains or fingerprints on the surface of the TV with the polishing cloth.

Do not use excessive force. This may cause scratching or discolouration.

### Use of ferrite core (This item is not included for all models.)

Ferrite core can be used to reduce the electromagnetic wave when connecting the power cord.

The closer the location of the ferrite core to the power plug, the better it is.

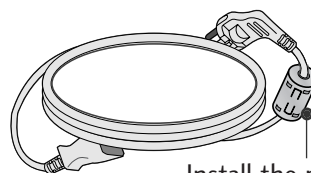

Install the power plug closely.

# CONTENTS

## ACCESSORIES ..... 1

### PREPARATION

Front Panel Controls .....	4
Back Panel Information .....	6
Stand Installation .....	8
Back Cover for Wire Arrangement .....	8
Desktop Pedestal Installation .....	8
Careful installation advice .....	9
Wall Mount: Horizontal Installation .....	9
Antenna Connection .....	10
Swivel Stand .....	10

### EXTERNAL EQUIPMENT SETUP

HD Receiver Setup .....	11
DVD Setup .....	13
VCR Setup .....	16
Insertion of CI Module .....	19
Digital Audio Out Setup .....	19
Other A/V Source Setup .....	20
Usb Setup .....	20
PC Setup .....	21
- Screen Setup for PC Mode .....	24

### WATCHING TV / PROGRAMME CONTROL

Remote Control Key Functions .....	28
Turning on the TV .....	32
Initializing setup .....	32
Programme Selection .....	32
Volume Adjustment .....	32
Quick Menu .....	33
On-Screen Menus Selection and Adjustment ..	34
Auto Programme Tuning .....	35
Manual Programme Tuning (In Digital Mode) ..	36
Manual Programme Tuning (In Analogue Mode) ..	37
Programme Edit .....	39
Software Update .....	42
Diagnostics .....	43
CI[COMMON INTERFACE] INFORMATION ...	44

Selecting the Programme Table .....	45
Input List .....	46
 SIMPLINK .....	47
Data Service .....	49
Input Label .....	49
AV Mode .....	50
Simple manual .....	51
Initializing (Reset to original factory settings) ..	52

### TO USE A USB DEVICE

When connecting a USB device .....	53
Photo List .....	54
Music List .....	58
Movie List .....	61
DivX Registration Code .....	65
Deactivation .....	66

### EPG (ELECTRONIC PROGRAMME GUIDE) (IN DIGITAL MODE)

- Switch on/off EPG .....	67
- Select Programme .....	67
- Button Function in NOW/NEXT Guide Mode ..	68
- Button Function in 8 Day Guide Mode ....	68
- Button Function in Date Change Mode ....	69
- Button Function in Extended Description Box ..	69
- Button Function in Record/Remind Setting Mode ..	70
- Button Function in Schedule List Mode ....	70

### PICTURE CONTROL

Picture Size (Aspect Ratio) Control .....	71
 ENERGY SAVING / POWER SAVING .....	73
Preset Picture Settings	
- Picture Mode-Preset .....	74
Manual Picture Adjustment	
- Picture Mode-User option .....	75
Picture Improvement Technology .....	76
Expert Picture Control .....	78

Picture Reset .....	81
Image Sticking Minimization (ISM) Method ...	82
Demo Mode .....	83
Mode Setting .....	84

## SOUND & LANGUAGE CONTROL

Auto Volume Leveler .....	85
Preset Sound Settings - Sound Mode .....	86
Sound Setting Adjustment -User Mode .....	87
SRS TruSurround XT .....	87
Clear Voice II .....	88
Balance .....	88
TV Speakers On/ Off Setup .....	89
Selecting Digital Audio Out .....	90
Audio Reset .....	91
Audio description .....	92
I/II	
- Stereo/Dual Reception (In Analogue Mode Only) ....	93
- NICAM Reception (In Analogue Mode Only) ..	94
- Speaker Sound Output Selection .....	94
On-Screen Menu Language/Country Selection ..	95
Language Selection (In Digital Mode only) ....	96

## TIME SETTING

Clock Setup .....	97
Auto On/ Off Timer Setting .....	98
Sleep Timer Setting .....	99

## PARENTAL CONTROL /34

### RATINGS

Set Password & Lock System .....	100
Block Programme .....	101
Parental Control .....	102
Input Block .....	103
Key Lock .....	104

## TELETEXT

Switch on/off .....	105
SIMPLE Text .....	105
TOP Text .....	105
FASTEXT .....	106
Special Teletext Functions .....	106

## DIGITAL TELETEXT

Teletext within Digital Service .....	107
Teletext in Digital Service .....	107

## APPENDIX

Troubleshooting .....	108
Maintenance .....	110
Product Specifications .....	111
IR Codes .....	113
External Control Device Setup .....	114

# PREPARATION

## FRONT PANEL CONTROLS

Image shown may differ from your TV.

### ⚠ CAUTION

- ▶ When the TV cannot be turned on with the remote control, press the main power button on the TV (When the power is turned off with the main power button on the TV, it will not be turned on with the remote control.)

### 42/50PQ11\*\*, 42/50PQ30\*\*, 50PS30\*\*

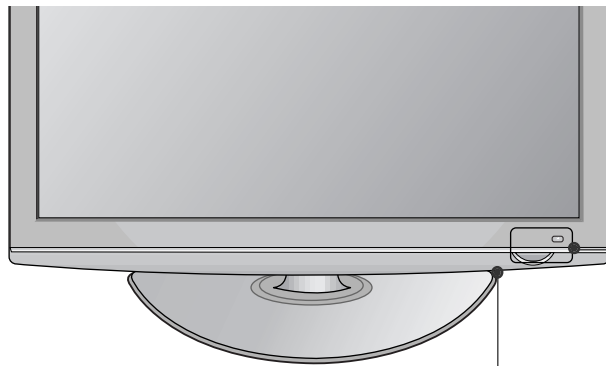

**Remote Control Sensor**

**Intelligent Sensor**  
Adjusts picture according to the surrounding conditions. (Except for 42/50PQ11\*\*)

**Power/Standby Indicator**

- Illuminates red in standby mode.
- Illuminates blue when the TV is switched on.

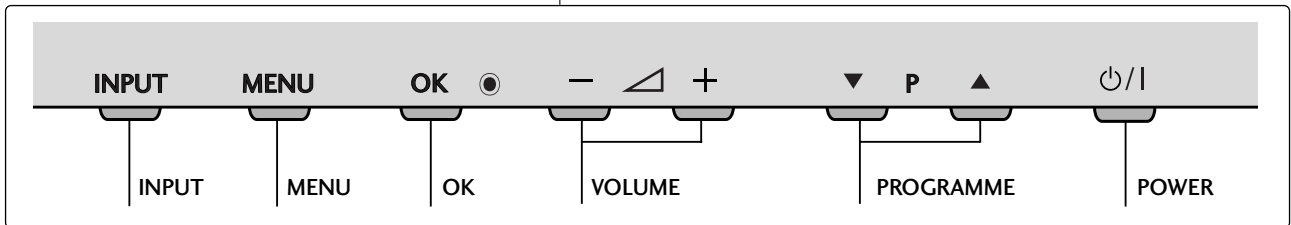

### 42/50PQ10\*\*, 42/50PQ20\*\*, 50PS20\*\*

**Intelligent Sensor** (Except for 42/50PQ10\*\*)  
Adjusts picture according to the surrounding conditions

**Remote Control Sensor**

**Power/Standby Indicator**  
Illuminates red in standby mode.  
Illuminates blue when the TV is switched on.

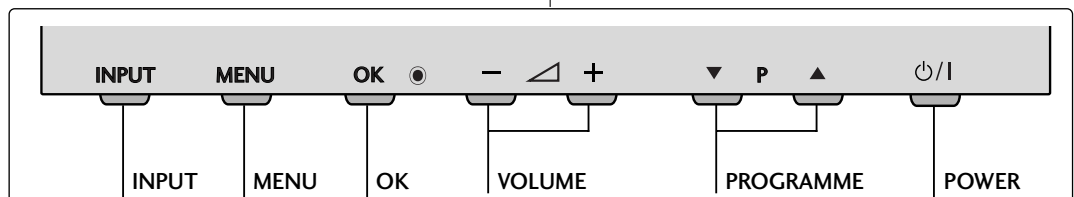
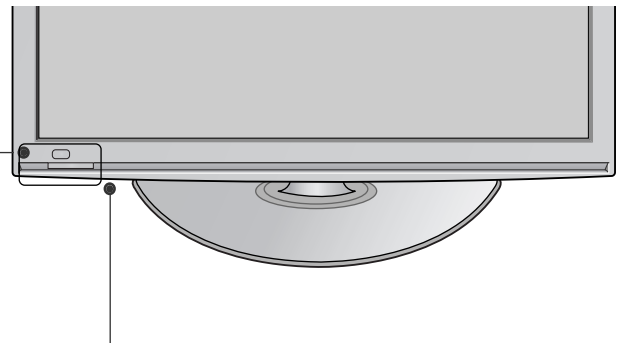

42/50PQ60\*\*, 50PS60\*\*

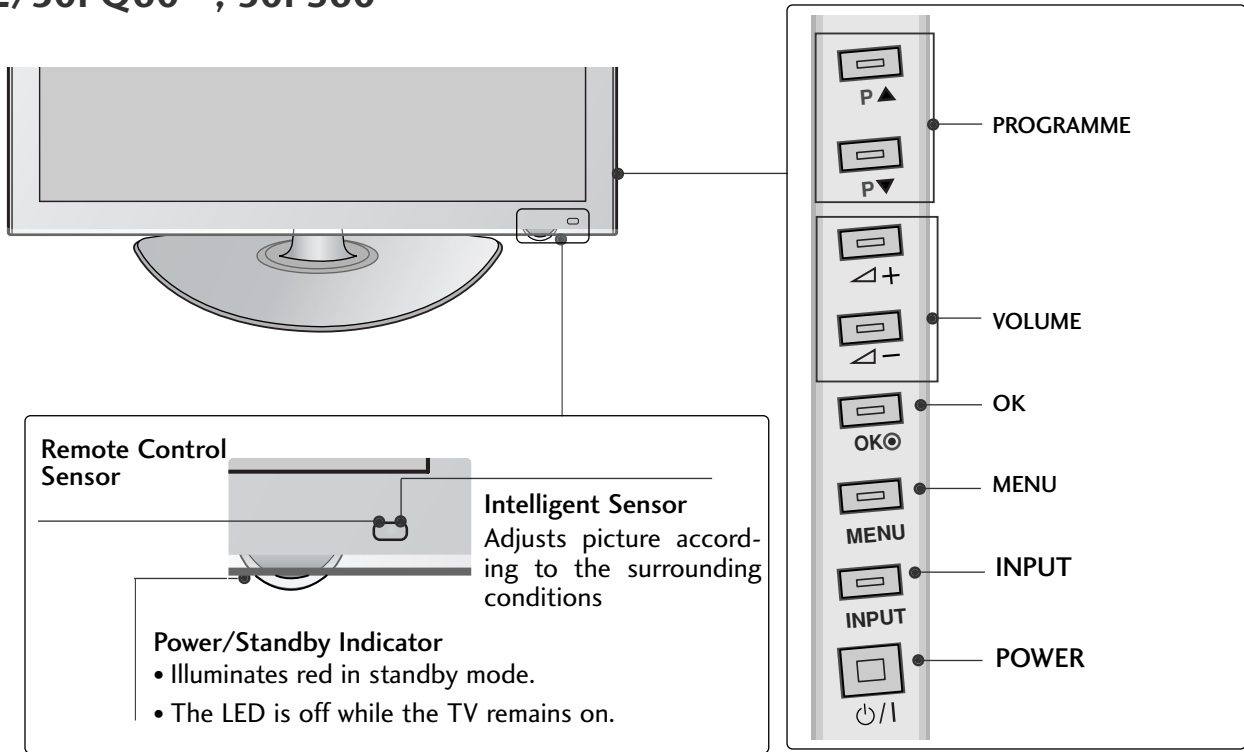

60PS40\*\*

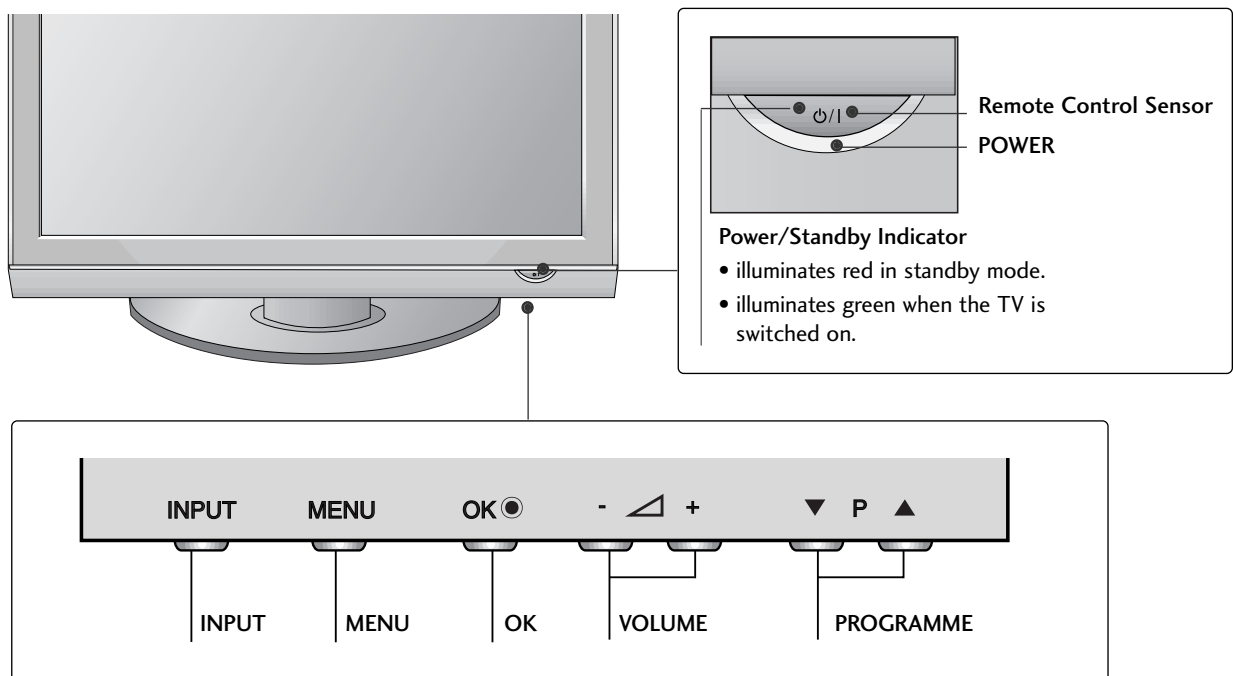

# PREPARATION

## BACK PANEL INFORMATION

- Image shown may differ from your TV.

42/50PQ10\*\*, 42/50PQ11\*\*

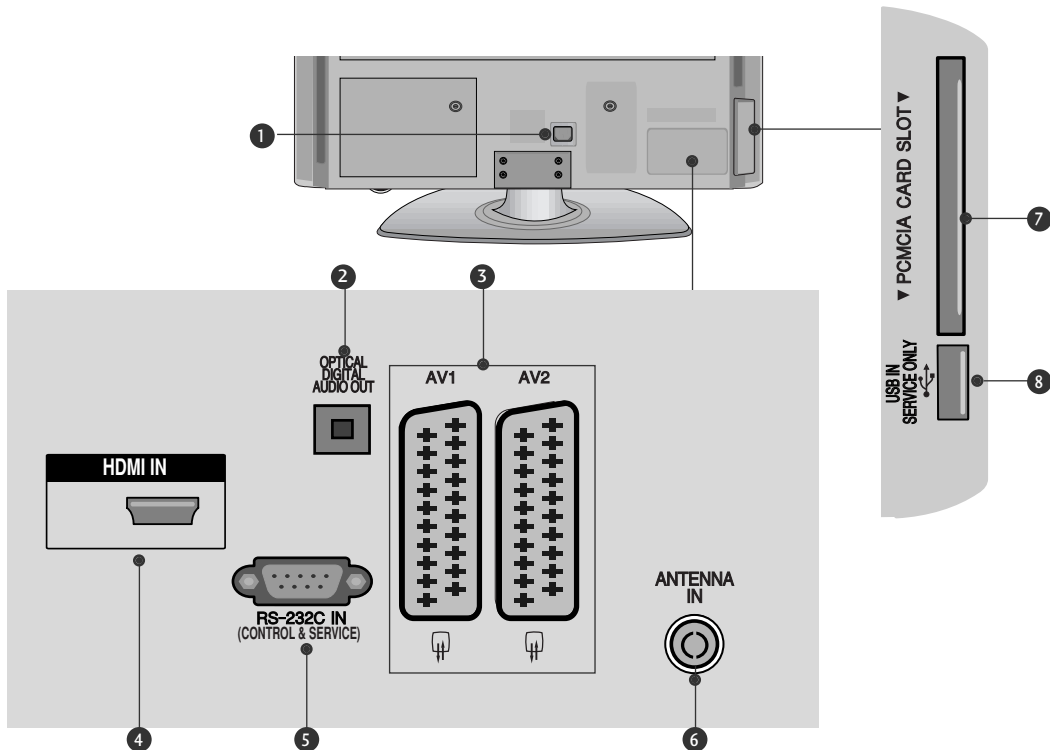

- 1 Power Cord Socket**  
This TV operates on an AC power. The voltage is indicated on the Specifications page. Never attempt to operate the TV on DC power.
- 2 OPTICAL DIGITAL AUDIO OUT**  
Connect digital audio to various types of equipment. Connect to a Digital Audio Component. Use an Optical audio cable.
- 3 Euro Scart Socket (AV1/AV2)**  
Connect scart socket input or output from an external device to these jacks.
- 4 HDMI Input**  
Connect an HDMI signal to HDMI IN.
- 5 RS-232C IN (CONTROL & SERVICE) PORT**  
Connect to the RS-232C port on a PC. This port is used for Service or Hotel mode.
- 6 Antenna Input**  
Connect RF antenna to this jack.
- 7 PCMCIA (Personal Computer Memory Card International Association) Card Slot**  
Insert the CI Module to **PCMCIA CARD SLOT**. (This feature is not available in all countries.)
- 8 SERVICE ONLY PORT**



**42/50PQ20\*\*, 42/50PQ30\*\*, 42/50PQ60\*\*, 50PS20\*\*,  
50PS30\*\*, 50PS60\*\*, 60PS40\*\***

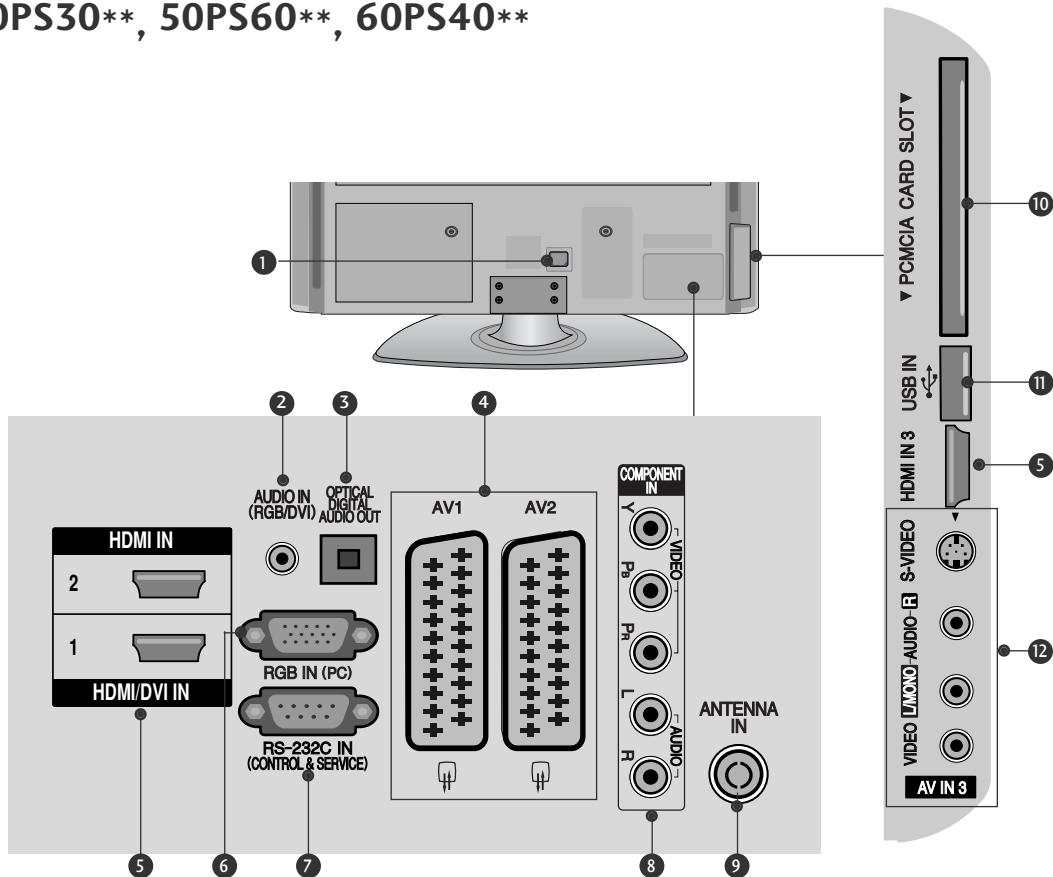

- 1 Power Cord Socket**  
This TV operates on an AC power. The voltage is indicated on the Specifications page. Never attempt to operate the TV on DC power.
- 2 RGB/DVI Audio Input**  
Connect the audio from a PC or DTV.
- 3 OPTICAL DIGITAL AUDIO OUT**  
Connect digital audio to various types of equipment. Connect to a Digital Audio Component. Use an Optical audio cable.
- 4 Euro Scart Socket (AV1/AV2)**  
Connect scart socket input or output from an external device to these jacks.
- 5 HDMI Input**  
Connect an HDMI signal to HDMI IN. Or DVI (VIDEO) signal to HDMI/DVI port with DVI to HDMI cable.
- 6 RGB Input**  
Connect the output from a PC.
- 7 RS-232C IN (CONTROL & SERVICE) PORT**  
Connect to the RS-232C port on a PC. This port is used for Service or Hotel mode.
- 8 Component Input**  
Connect a component video/audio device to these jacks.
- 9 Antenna Input**  
Connect RF antenna to this jack.
- 10 PCMCIA (Personal Computer Memory Card International Association) Card Slot**  
Insert the CI Module to **PCMCIA CARD SLOT**. (This feature is not available in all countries.)
- 11 USB Input**  
Connect USB storage device to this jack.
- 12 Audio/Video Input**  
Connect audio/video output from an external device to these jacks.  
S-Video Input  
Connect S-Video out from an S-VIDEO device.

# PREPARATION

## STAND INSTALLATION

(Except for 60PS40\*\*)

- Image shown may differ from your TV.
- When assembling the desk type stand, check whether the bolt is fully tightened. (If not tightened fully, the product can tilt forward after the product installation.) If you tighten the bolt with excessive force, the bolt can deviate from abrasion of the tightening part of the bolt.

**1** Carefully place the TV screen side down on a cushioned surface to protect the screen from damage.

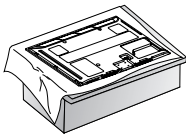

**2** Assemble the TV as shown.

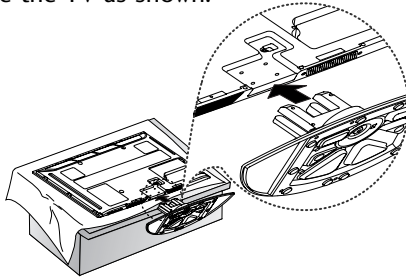

**3** Fix the 4 bolts securely using the holes in the back of the TV.

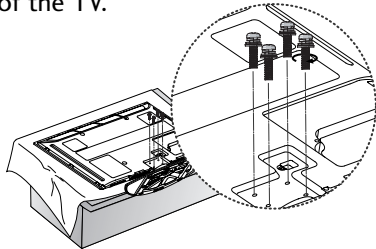

### NOTE

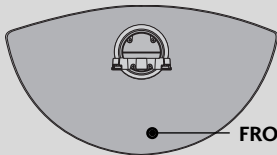

When assembling the stand, make sure to distinguish and assemble the front and rear side of the stand correctly.

## DESKTOP PEDESTAL INSTALLATION

For adequate ventilation allow a clearance of 4" (10cm) all around the TV.

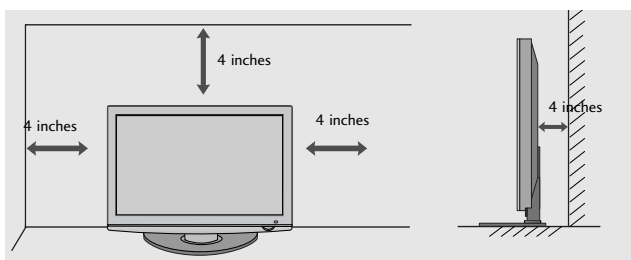

## BACK COVER FOR WIRE ARRANGEMENT

- Image shown may differ from your TV.

After Connecting the cables as necessary, install **CABLE HOLDER** as shown and bundle the cables.

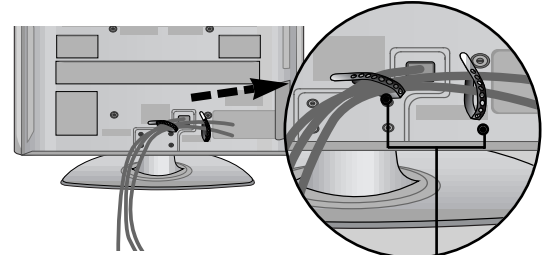

CABLE HOLDER

### Only 60PS40\*\*

Install the **CABLE MANAGEMENT CLIP** as shown.

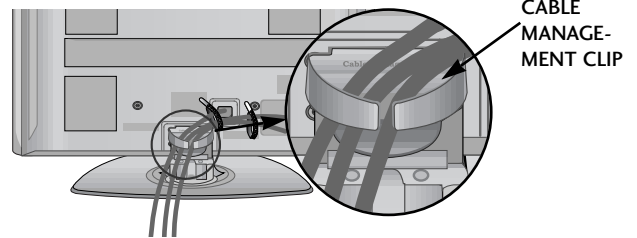

CABLE MANAGEMENT CLIP

### How to remove the cable management clip

Hold the **CABLE MANAGEMENT CLIP** with both hands and pull it upward.

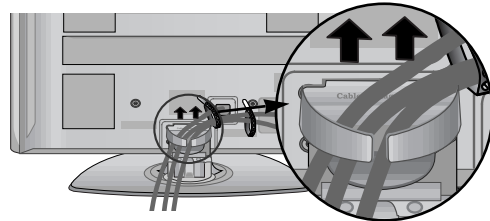

### NOTE

- Do not use the **CABLE MANAGEMENT CLIP** to lift the TV.
- If the TV is dropped, you may be injured or the TV may be damaged.

## NOT USING THE DESK-TYPE STAND

- Image shown may differ from your TV.

When installing the wall-mounted unit, use the protection cover. Insert the **PROTECTION COVER** into the TV until clicking sound.

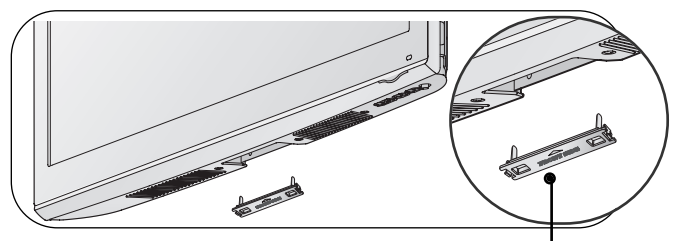

protection cover

## CAREFUL INSTALLATION ADVICE

- You should purchase necessary components to fix the TV safely and secure to the wall from the market.
- Position the TV close to the wall to avoid the possibility of it falling when pushed.
- The instructions shown below are a safer way to set up the TV, by fixing it to the wall, avoiding the possibility of it falling forwards if pulled. This will prevent the TV from falling forward and causing injury. This will also prevent the TV from damage. Ensure that children do not climb or hang from the TV.

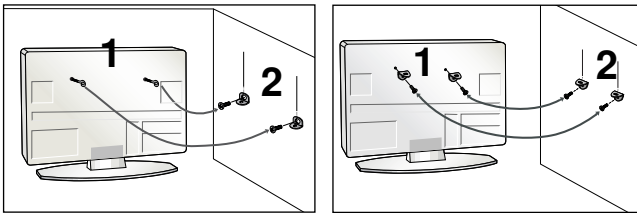

- 1** Use the eye-bolts or TV brackets/bolts to fix the product to the wall as shown in the picture. (If your TV has bolts in the eyebolts, loosen then bolts.)  
\* Insert the eye-bolts or TV brackets/bolts and tighten them securely in the upper holes.

- 2** Secure the wall brackets with the bolts on the wall. Match the height of the bracket that is mounted on the wall.

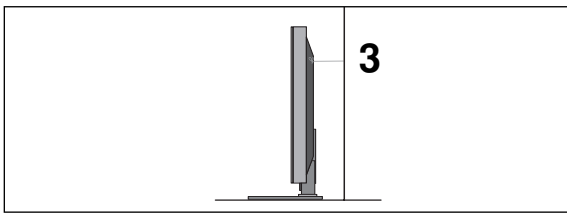

- 3** Use a sturdy rope to tie the product for alignment. It is safer to tie the rope so it becomes horizontal between the wall and the product.

### ! NOTE

- ▶ When moving the TV undo the cords first.
- ▶ Use a platform or cabinet strong and large enough to support the size and weight of the TV.
- ▶ To use the TV safely make sure that the height of the bracket on the wall and on the TV is the same.

## EARTHING

Ensure that you connect the earth wire to prevent possible electric shock. If grounding methods are not possible, have a qualified electrician install a separate circuit breaker.

Do not try to earth the TV by connecting it to telephone wires, lightning rods or gas pipes.

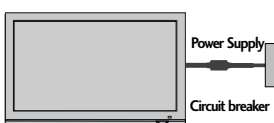

- The TV can be installed in various ways such as on a wall, or on a desktop etc.

## WALL MOUNT: HORIZONTAL INSTALLATION

- We recommend the use of a LG Brand wall mounting bracket when mounting the TV to a wall.
- We recommend that you purchase a wall mounting bracket which supports VESA standard.
- LG recommends that wall mounting be performed by a qualified professional installer.

### ! NOTE

- ▶ Should install wall mount on a solid wall perpendicular to the floor.
- ▶ Should use a special wall mount, if you want to install it to ceiling or slanted wall.
- ▶ The surface that wall mount is to be mounted on should be of sufficient strength to support the weight of TV set; e.g. concrete, natural rock, brick and hollow block.
- ▶ Installing screw type and length depends on the wall mount used. Further information, refer to the instructions included with the mount.
- ▶ LG is not liable for any accidents or damage to property or TV due to incorrect installation:
  - Where a non-compliant VESA wall mount is used.
  - Incorrect fastening of screws to surface which may cause TV to fall and cause personal injury.
  - Not following the recommended Installation method.

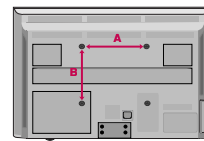
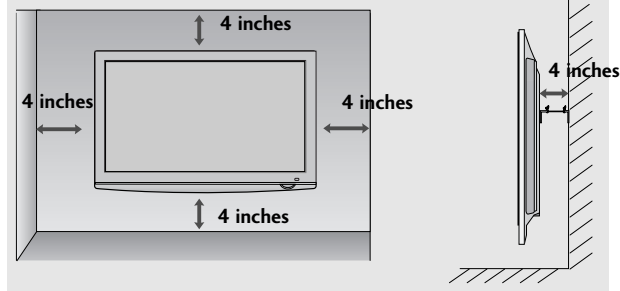

Model	VESA (A * B)	Standard Screw	Quantity
42PQ10**	400 * 400	M6	4
50PQ10**	400 * 400	M6	4
42PQ11**	400 * 400	M6	4
50PQ11**	400 * 400	M6	4
42PQ20**	400 * 400	M6	4
50PQ20**	400 * 400	M6	4
42PQ30**	400 * 400	M6	4
50PQ30**	400 * 400	M6	4
42PQ60**	400 * 400	M6	4
50PQ60**	400 * 400	M6	4
50PS20**	400 * 400	M6	4
50PS30**	400 * 400	M6	4
50PS60**	400 * 400	M6	4
60PS40**	600 * 400	M8	4

# PREPARATION

- To prevent damage do not connect to the mains outlet until all connections are made between the devices.

## ANTENNA CONNECTION

- For optimum picture quality, adjust antenna direction.
- An antenna cable and converter are not supplied.

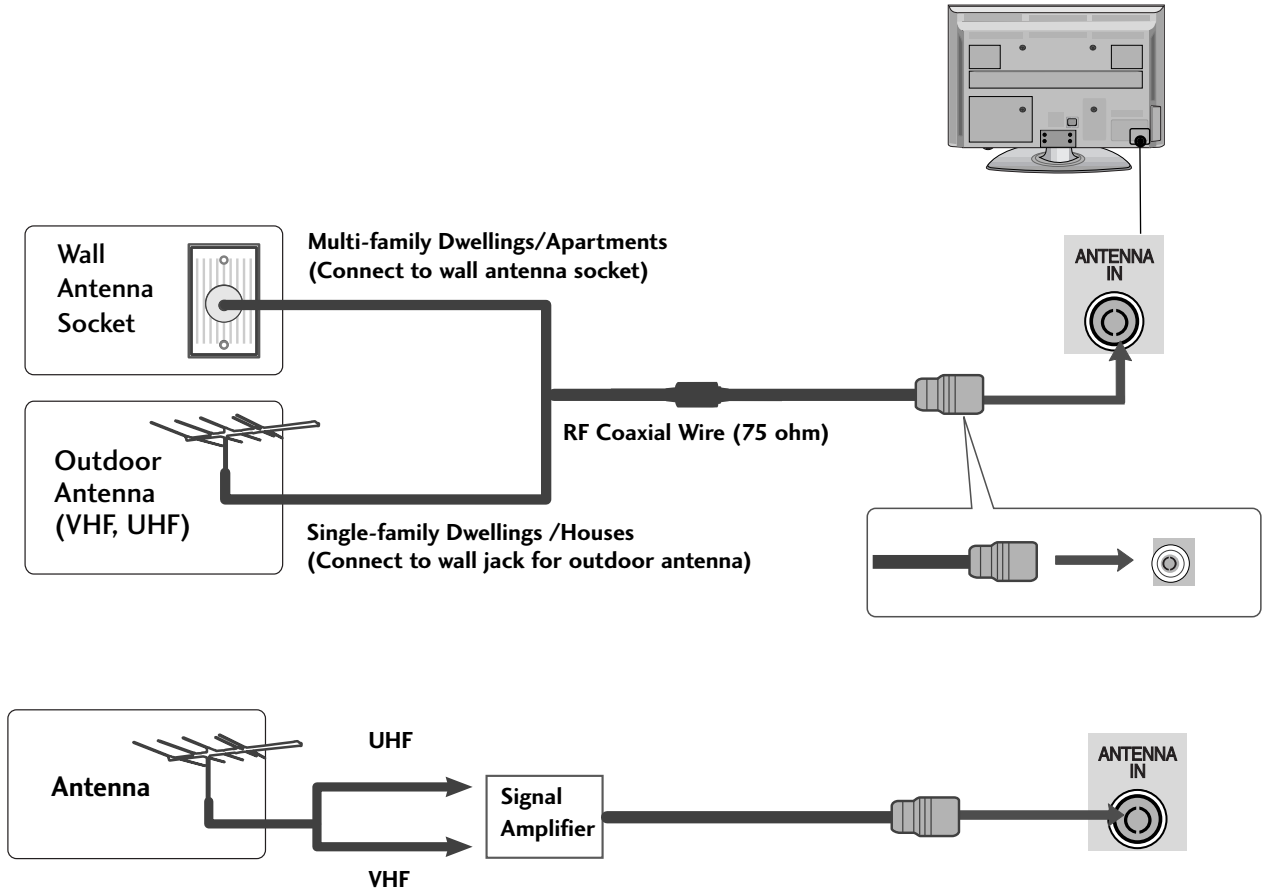

- In poor signal areas, to achieve better picture quality it may be necessary to install a signal amplifier to the antenna as shown above.
- If signal needs to be split for two TVs, use an antenna signal splitter for connection.

## SWIVEL STAND

After installing the TV, you can adjust the TV manually to the left or right direction by 20 degrees to suit your viewing position.

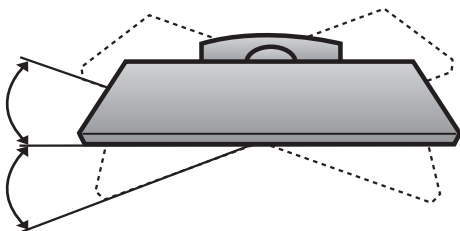

# EXTERNAL EQUIPMENT SETUP

- To avoid damaging any equipment, never plug in any power cords until you have finished connecting all equipment.
- This section on EXTERNAL EQUIPMENT SETUP mainly uses diagrams for the 42PQ30\*\* models.
- Image shown may differ from your TV.

## HD RECEIVER SETUP

- This TV can receive Digital RF/Cable signals without an external digital set-top box. However, if you do receive Digital signals from a digital set-top box or other digital external device, refer to the diagram as shown below.

### Connecting with a component cable

(Except for 42/50PQ10\*\*, 42/50PQ11\*\*)

- 1 Connect the video outputs (Y, PB, PR) of the digital set top box to the **COMPONENT IN VIDEO** jacks on the TV.
- 2 Connect the audio output of the digital set-top box to the **COMPONENT IN AUDIO** jacks on the TV.
- 3 Turn on the digital set-top box.  
(Refer to the owner's manual for the digital set-top box.)
- 4 Select **Component** input source using the **INPUT** button on the remote control.

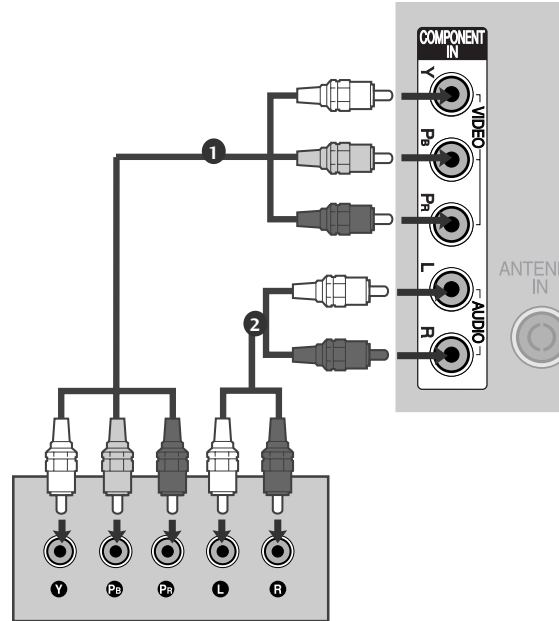

Signal	Component	HDMI
480i/576i	○	X
480p/576p	○	○
720p/1080i	○	○
1080p	○ (50/60Hz only)	○ (24Hz/30Hz/50Hz/60Hz)

(For 42/50PQ10\*\*, 42/50PQ11\*\*)

### Connecting with a component to HDMI adapter

- \* You can receive HD broadcasting by using Component to HDMI adapter.  
(You can inquire and purchase Component to HDMI adapter at Website or Market.)

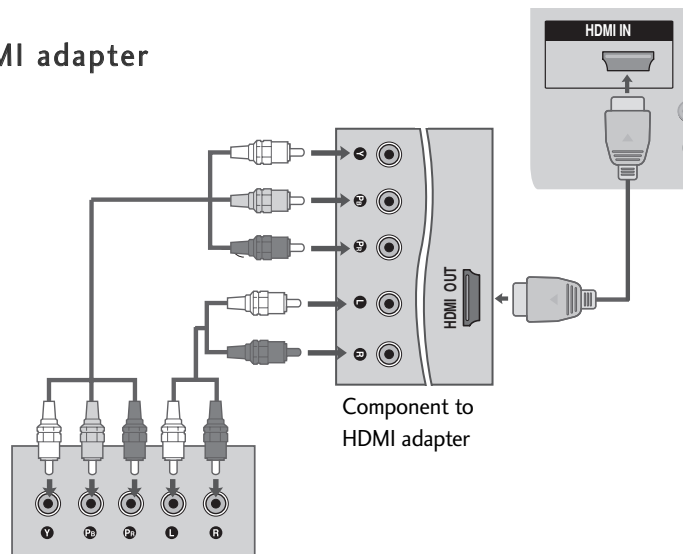

# EXTERNAL EQUIPMENT SETUP

## Connecting a set-top box with an HDMI cable

- 1 Connect the digital set-top box to **HDMI/DVI IN 1**, **HDMI IN**, **HDMI IN 2** or **HDMI IN 3** jack on the TV.
- 2 Turn on the digital set-top box. (Refer to the owner's manual for the digital set-top box.)
- 3 Select **HDMI1**, **HDMI2** or **HDMI3** input source using the **INPUT** button on the remote control.

### ! NOTE

- ▶ Check that your HDMI cable is version 1.3 or higher. If the HDMI cables don't support HDMI version 1.3, flickering or no screen display can result. Please use the latest cables that support at least HDMI version 1.3.

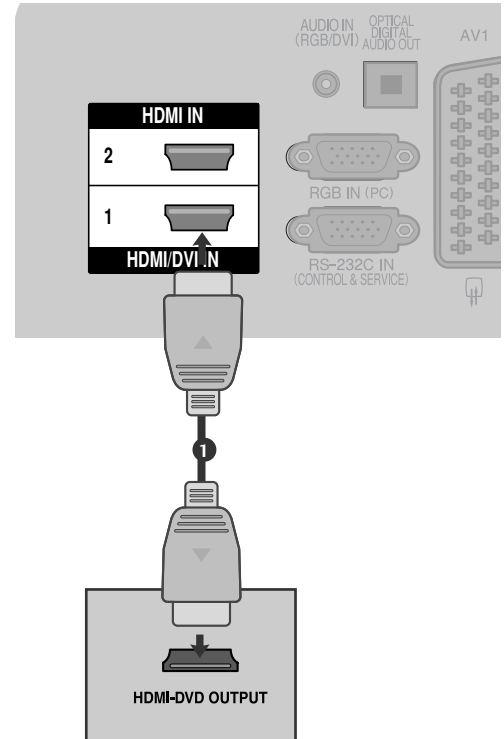

## Connecting with an HDMI to DVI cable

(Except for 42/50PQ10\*\*, 42/50PQ11\*\*)

- 1 Connect the digital set-top box to **HDMI/DVI IN 1** jack on the TV.
- 2 Connect the audio output of the digital set-top box to the **AUDIO IN (RGB/DVI)** jack on the TV.
- 3 Turn on the digital set-top box. (Refer to the owner's manual for the digital set-top box.)
- 4 Select **HDMI1** input source using the **INPUT** button on the remote control.

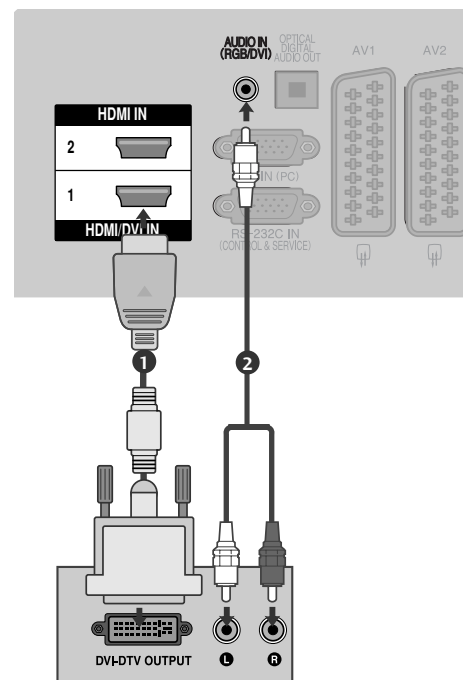

# DVD SETUP

## Connecting with a component cable

(Except for 42/50PQ10\*\*, 42/50PQ11\*\*)

- 1 Connect the video outputs (Y, Pb, Pr) of the DVD to the **COMPONENT IN VIDEO** jacks on the TV.
- 2 Connect the audio outputs of the DVD to the **COMPONENT IN AUDIO** jacks on the TV.
- 3 Turn on the DVD player, insert a DVD.
- 4 Select **Component** input source using the **INPUT** button on the remote control.
- 5 Refer to the DVD player's manual for operating instructions.

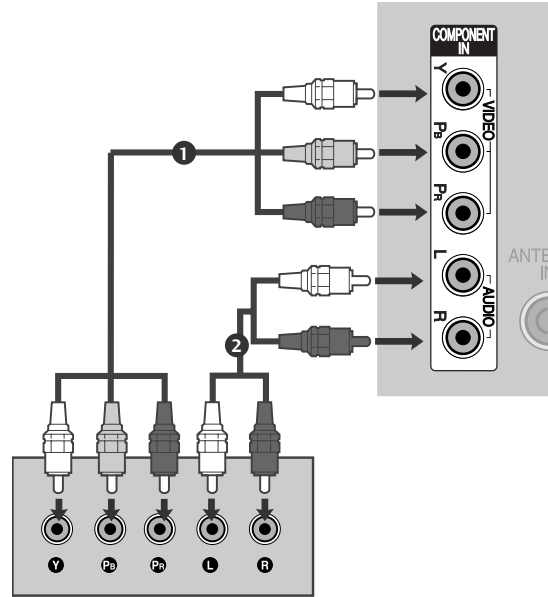

### Component Input ports

To achieve better picture quality, connect a DVD player to the component input ports as shown below.

Component ports on the TV	Y	P <sub>B</sub>	P <sub>R</sub>
Video output ports on DVD player	Y	P <sub>B</sub>	P <sub>R</sub>
	Y	B-Y	R-Y
	Y	Cb	Cr
	Y	Pb	Pr

# EXTERNAL EQUIPMENT SETUP

## Connecting with a Euro Scart cable

- 1 Connect the Euro scart socket of the DVD to the **AV1** Euro scart socket on the TV.
- 2 Turn on the DVD player, insert a DVD.
- 3 Select **AV1** input source using the **INPUT** button on the remote control.  
If connected to **AV2** Euro scart socket, select **AV2** input source.
- 4 Refer to the DVD player's manual for operating instructions.

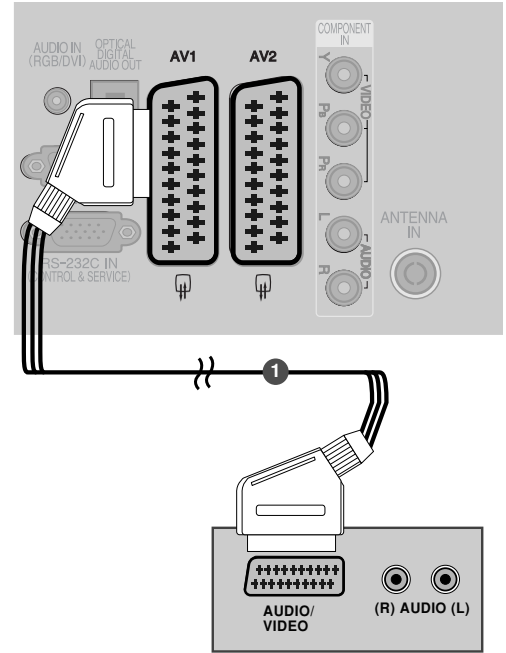

Scart	Input			Output
	Video	Audio	RGB	Video, Audio
AV1	O	O	O	ATV only
AV2	O	O	X	ATV, DTV, AV1/2/3 output is available.

Current input mode \ Output Type	AV1 (TV Out)	AV2 (Monitor Out)	AV2 (When DTV scheduled recording is in progress using recording equipment.)
Digital TV	X	O	O
Analogue TV	O	O	O (The input mode is converted to DTV automatically.)
AV1/2/3	O	O	O
Component/RGB/HDMI	O	X	O

- ▶ TV Out : Outputs analog TV video signals.
- ▶ Monitor Out: Outputs the current screen image.
- ▶ AV3, Component, RGB : Except for 42/50PQ10\*\*, 42/50PQ11\*\*.

### ! NOTE

- ▶ Any Euro scart cable used must be signal shielded.



## Connecting with a S-Video cable

(Except for 42/50PQ10\*\*, 42/50PQ11\*\*)

- 1 Connect the S-VIDEO output of the DVD to the **S-VIDEO** input on the TV.
- 2 Connect the audio outputs of the DVD to the **AUDIO** input jacks on the TV.
- 3 Turn on the DVD player, insert a DVD.
- 4 Select **AV3** input source using the **INPUT** button on the remote control.
- 5 Refer to the DVD player's manual for operating instructions.

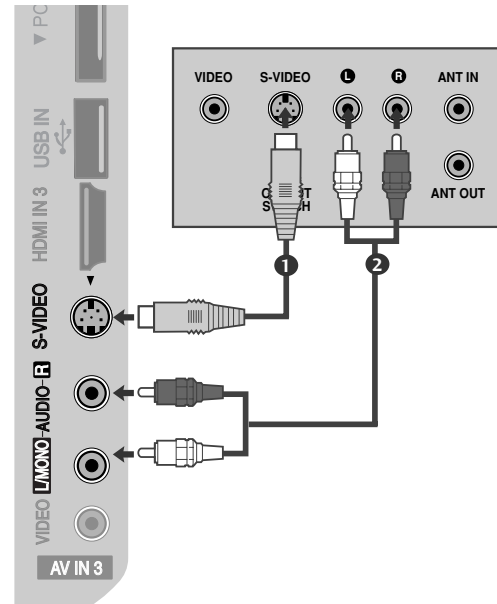

## Connecting the HDMI cable

- 1 Connect the HDMI output of the DVD to the **HDMI/DVI IN 1**, **HDMI IN**, **HDMI IN 2** or **HDMI IN 3** jack on the TV.
- 2 Select **HDMI1**, **HDMI2** or **HDMI3** input source using the **INPUT** button on the remote control.
- 3 Refer to the DVD player's manual for operating instructions.

### ! NOTE

- ▶ The TV can receive video and audio signals simultaneously when using a HDMI cable.
- ▶ If the DVD does not support Auto HDMI, you must set the output resolution appropriately.
- ▶ Check that your HDMI cable is version 1.3 or higher.  
If the HDMI cables don't support HDMI version 1.3, flickering or no screen display can result. Please use the latest cables that support at least HDMI version 1.3.

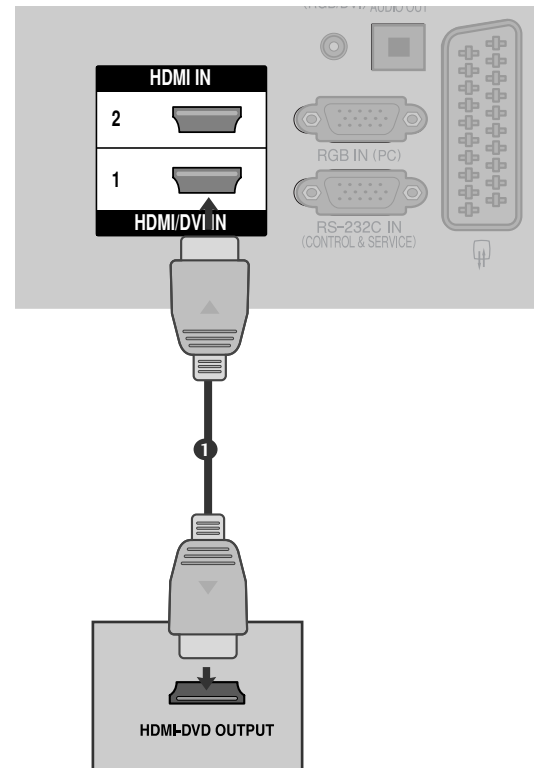

# EXTERNAL EQUIPMENT SETUP

## VCR SETUP

- To avoid picture noise (interference), allow adequate distance between the VCR and TV.

### Connecting with a RF Cable

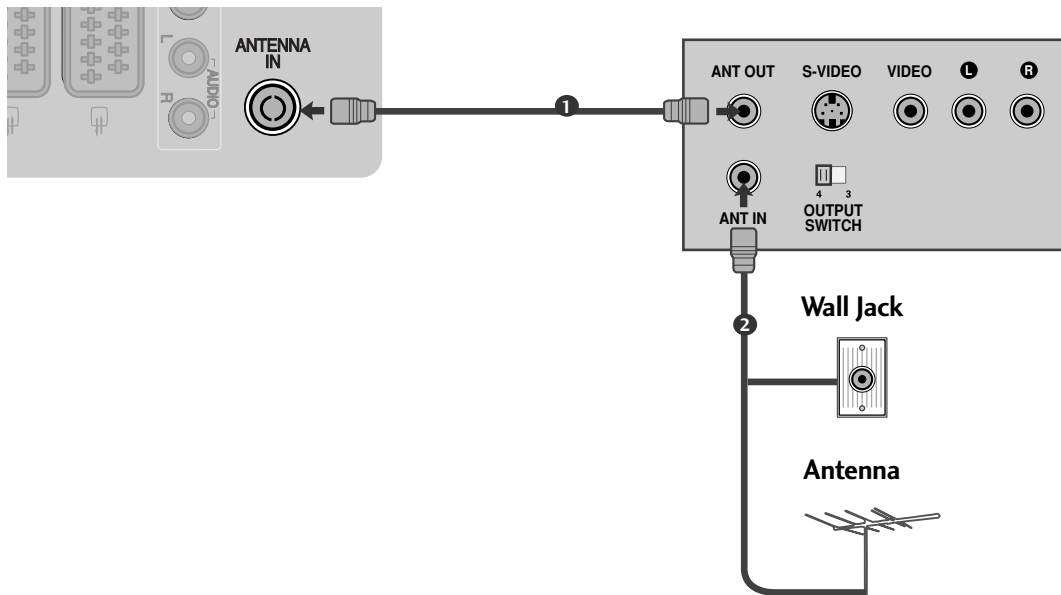

- 1 Connect the **ANT OUT** socket of the VCR to the **ANTENNA IN** socket on the TV.
- 2 Connect the antenna cable to the **ANT IN** socket of the VCR.
- 3 Press the **PLAY** button on the VCR and match the appropriate channel between the TV and VCR for viewing.

## Connecting with a Euro Scart cable

- 1 Connect the Euro scart socket of the VCR to the **AV1** Euro scart socket on the TV.
- 2 Insert a video tape into the VCR and press **PLAY** on the VCR. (Refer to the VCR owner's manual.)
- 3 Select **AV1** input source using the **INPUT** button on the remote control.
- 4 If connected to **AV2** Euro scart socket, select **AV2** input source.

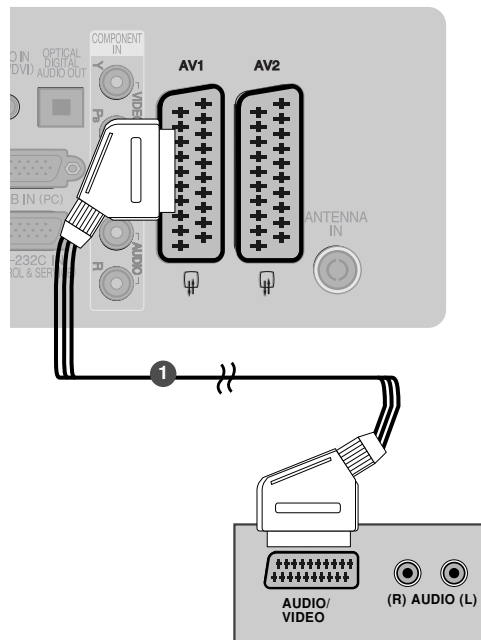

Scart	Input			Output
	Video	Audio	RGB	Video, Audio
AV1	○	○	○	ATV only
AV2	○	○	X	ATV, DTV, AV1/2/3 output is available.

Current input mode \ Output Type	AV1 (TV Out)	AV2 (Monitor Out)	AV2 (When DTV scheduled recording is in progress using recording equipment.)
Digital TV	X	○	○
Analogue TV	○	○	○ (The input mode is converted to DTV automatically.)
AV1/2/3	○	○	○
Component/RGB/HDMI	○	X	○

- ▶ **TV Out** : Outputs analog TV video signals.  
Monitor Out: Outputs the current screen image.
- ▶ **AV3, Component, RGB** : Except for 42/50PQ10\*\*, 42/50PQ11\*\*.

### ! NOTE

- ▶ Any Euro Scart cable used must be signal shielded.

# EXTERNAL EQUIPMENT SETUP

## Connecting with a RCA cable

(Except for 42/50PQ10\*\*, 42/50PQ11\*\*)

- 1 Connect the **AUDIO/VIDEO** jacks between TV and VCR. Match the jack colours (Video = yellow, Audio Left = white, and Audio Right = red)
- 2 Insert a video tape into the VCR and press **PLAY** on the VCR. (Refer to the VCR owner's manual.)
- 3 Select **AV3** input source using the **INPUT** button on the remote control.

### ! NOTE

- ▶ If you have a mono VCR, connect the audio cable from the VCR to the **AUDIO L/MONO** jack of the TV.

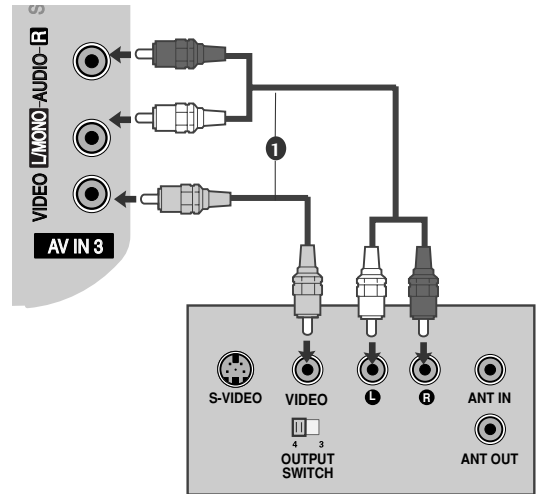

## Connecting with a S-Video cable

(Except for 42/50PQ10\*\*, 42/50PQ11\*\*)

- 1 Connect the S-VIDEO output of the VCR to the **S - VIDEO** input on the TV set. The picture quality is improved; compared to normal composite (RCA cable) input.
- 2 Connect the audio outputs of the VCR to the **AUDIO** input jacks on the TV.
- 3 Insert a video tape into the VCR and press **PLAY** on the VCR. (Refer to the VCR owner's manual.)
- 4 Select **AV3** input source with using the **INPUT** button on the remote control.

### ! NOTE

- ▶ If both S-VIDEO and VIDEO sockets have been connected to the S-VHS VCR simultaneously, only the S-VIDEO can be received.

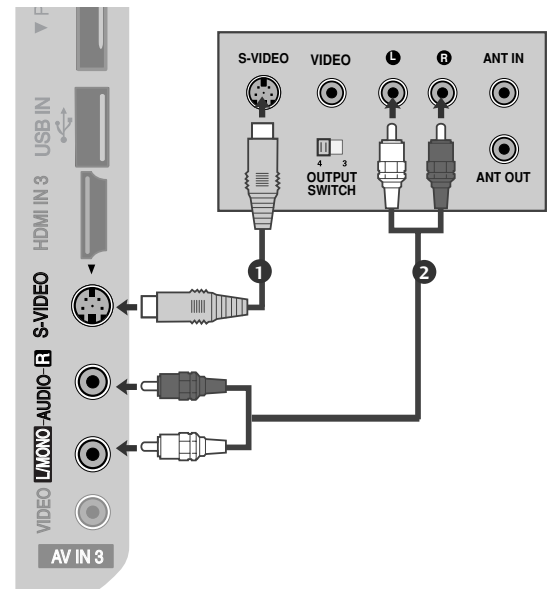

## INSERTION OF CI MODULE

- To view the encrypted (pay) services in digital TV mode.
- This item is not included for all countries.

- 1 Insert the CI Module to **PCMCIA** (Personal Computer Memory Card International Association) **CARD SLOT** of TV as shown.

For further information, see p.44.

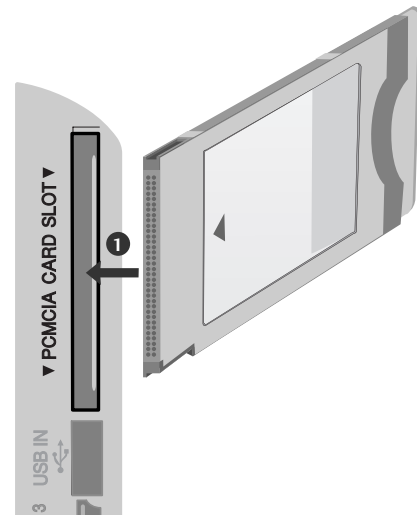

### NOTE

- ▶ Check if the CI module is inserted into the PCMCIA card slot in the right direction. If the module is not inserted properly, this can cause damage to the TV and the PCMCIA card slot.

## DIGITAL AUDIO OUT SETUP

Sending the TV's audio signal to external audio equipment via the Digital Audio Output (Optical) port. If you want to enjoy digital broadcasting through 5.1-channel speakers, connect the **OPTICAL DIGITAL AUDIO OUT** terminal on the back of TV to a DVD Home Theater (or amp).

- 1 Connect one end of an optical cable to the TV Digital Audio (Optical) Output port.
- 2 Connect the other end of the optical cable to the digital audio (Optical) input on the audio equipment.
- 3 Set the "TV Speaker option - Off" in the AUDIO menu. (▶p.89). Refer to the external audio equipment instruction manual for operation.

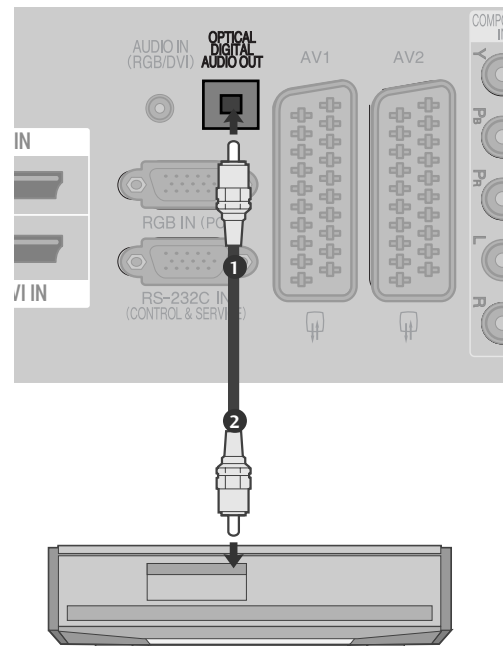

### CAUTION

- ▶ Do not look into the optical output port. Looking at the laser beam may damage your vision.

# EXTERNAL EQUIPMENT SETUP

## OTHER A/V SOURCE SETUP

(Except for 42/50PQ10\*\*, 42/50PQ11\*\*)

- 1 Connect the **AUDIO/VIDEO** jacks between TV and external equipment. Match the jack colours. (Video = yellow, Audio Left = white, and Audio Right = red)
- 2 Select **AV3** input source using the **INPUT** button on the remote control.
- 3 Operate the corresponding external equipment. Refer to external equipment operating guide.

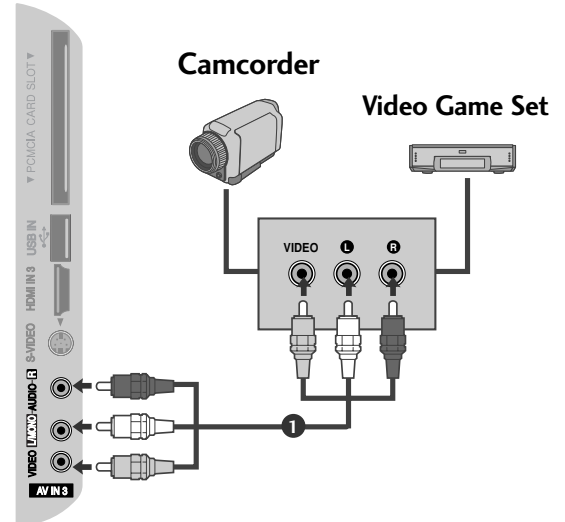

## USB SETUP

(Except for 42/50PQ10\*\*, 42/50PQ11\*\*)

- 1 Connect the USB device to the **USB IN** jacks on the side of TV.
- 2 After connecting the **USB IN** jacks, you use the **USB** function. (► p.53)

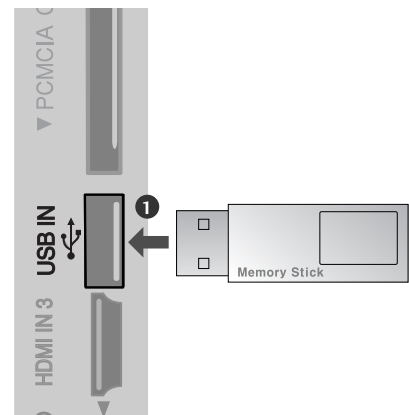

## PC SETUP (Except for 42/50PQ10\*\*, 42/50PQ11\*\*)

This TV provides Plug and Play capability, meaning that the PC adjusts automatically to the TV's settings.

### Connecting with a D-sub 15 pin cable

- 1 Connect the RGB output of the PC to the **RGB IN (PC)** jack on the TV.
- 2 Connect the PC audio output to the **AUDIO IN (RGB/DVI)** jack on the TV.
- 3 Turn on the PC and the TV
- 4 Select **RGB** input source using the INPUT button on the remote control.

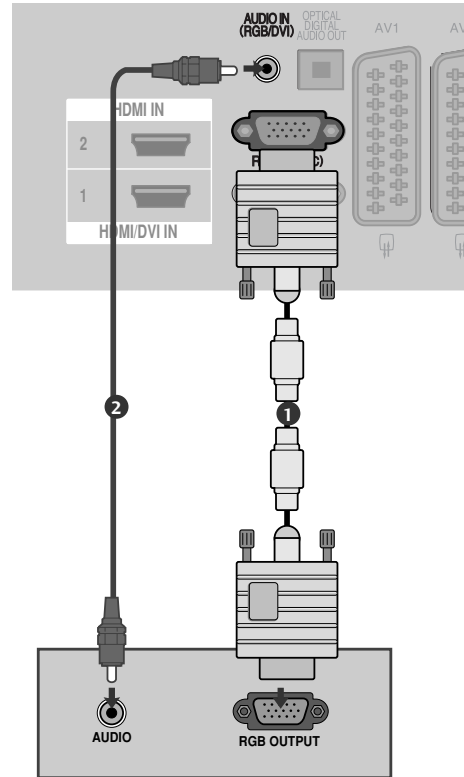

### Connecting with a HDMI to DVI cable

- 1 Connect the DVI output of the PC to the **HDMI/DVI IN1** jack on the TV.
- 2 Connect the PC audio output to the **AUDIO IN (RGB/DVI)** jack on the TV.
- 3 Turn on the PC and the TV.
- 4 Select **HDMI1** input source using the INPUT button on the remote control.

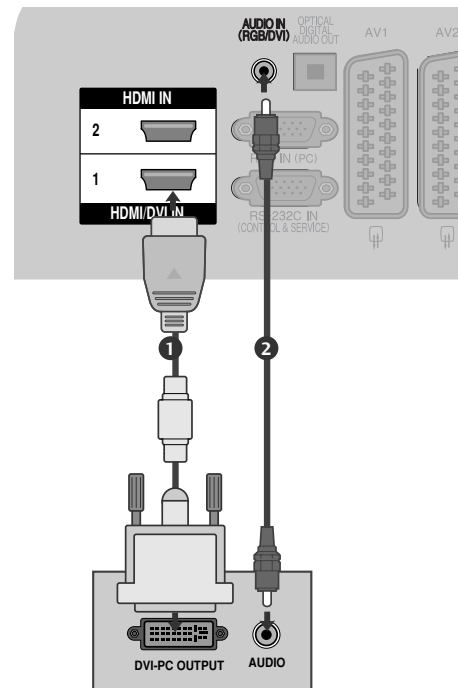

# EXTERNAL EQUIPMENT SETUP

## Supported Display Resolution

### RGB-PC, HDMI/DVI-PC mode

Resolution	Horizontal Frequency(kHz)	Vertical Frequency(Hz)
720x400	31.468	70.08
640x480	31.469	59.94
800x600	37.879	60.31
1024x768	48.363	60.00
1280x768	47.78	59.87
1360x768	47.72	59.8
1920x1080 (RGB-PC)	66.587	59.93
1920x1080 (HDMI-PC)	67.50	60.00

### HDMI/DVI-DTV mode

Resolution	Horizontal Frequency(kHz)	Vertical Frequency(Hz)
640x480	31.469	59.94
720x480	31.47	59.94
720x576	31.25	50.00
1280x720	37.50	50.00
1920x1080	44.96	59.94
	45.00	60
	28.125	50.00
	33.72	59.94
	33.75	60
	27.00	24.00
	33.75	30
	56.25	50.00
67.433	59.94	
67.50	60	



**! NOTE**

- ▶ Avoid keeping a fixed image on the set's screen for prolonged periods of time. The fixed image may become permanently imprinted on the screen; use a screen saver when possible.
- ▶ There may be interference relating to resolution, vertical pattern, contrast or brightness in PC mode. Change the PC mode to another resolution or change the refresh rate to another rate or adjust the brightness and contrast on the menu until the picture is clear. If the refresh rate of the PC graphic card can not be changed, change the PC graphic card or consult the manufacturer of the PC graphic card.
- ▶ The synchronization input waveform for Horizontal and Vertical frequencies are separate.
- ▶ We recommend using 1024x768, 60Hz (42PQ20\*\*, 42PQ30\*\*, 42PQ60\*\*) / 1360x768, 60Hz (50PQ20\*\*, 50PQ30\*\*, 50PQ60\*\*) / 1920x1080, 60Hz(50PS20\*\*, 50PS30\*\*, 50PS60\*\*, 60PS40\*\*) for the PC mode, they provide the best picture quality.
- ▶ Connect the signal cable from the monitor output port of the PC to the RGB (PC) port of the TV or the signal cable from the HDMI output port of the PC to the HDMI IN (or HDMI/DVI IN) port on the TV.
- ▶ Connect the audio cable from the PC to the Audio input on the TV. (Audio cables are not included with the TV).
- ▶ If using a sound card, adjust PC sound as required.
- ▶ If the graphic card on the PC does not output analogue and digital RGB simultaneously, connect only one of either RGB or HDMI IN (or HDMI/DVI IN) to display the PC output on the TV.
- ▶ If the graphic card on the PC does output analog and digital RGB simultaneously, set the TV to either RGB or HDMI; (the other mode is set to Plug and Play automatically by the TV.)
- ▶ DOS mode may not work depending on the video card if you use an HDMI to DVI cable.
- ▶ If you use an RGB-PC cable that is too long, there may be interference on the screen. We recommend using under 5m of cable. This provides the best picture quality.

# EXTERNAL EQUIPMENT SETUP





## Screen Setup for PC mode (Except for 42/50PQ10\*\*, 42/50PQ11\*\*)

### Screen Reset

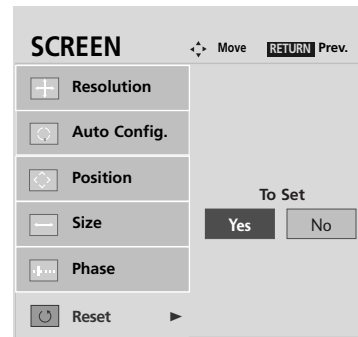
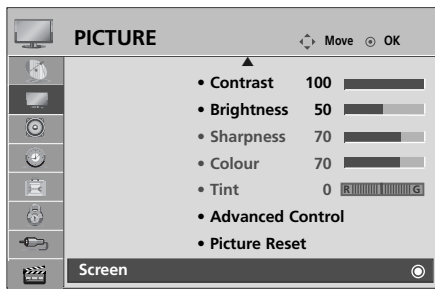
Returns Position, Size and Phase to the factory default settings.

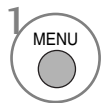
This function works in the following mode : RGB[PC].

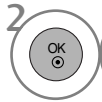
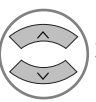
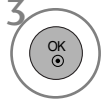
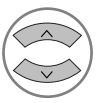
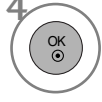
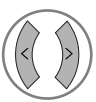

- 1   Select **PICTURE**.
- 2   Select **Screen**.
- 3   Select **Reset**.
- 4   Select **Yes**.
- 5  Run **Reset**.

- Press the **MENU** button to return to normal TV viewing.
- Press the **RETURN** button to move to the previous menu screen.

## Auto Configure (RGB [PC] mode only)

Automatically adjust the picture position and minimizes image instability. After adjustment, if the image is still not correct, your TV is functioning properly but needs further adjustment.

### Auto configure

This function is for automatic adjustment of the screen position, size, and phase. The displayed image will be unstable for a few seconds while the auto configuration is in progress.

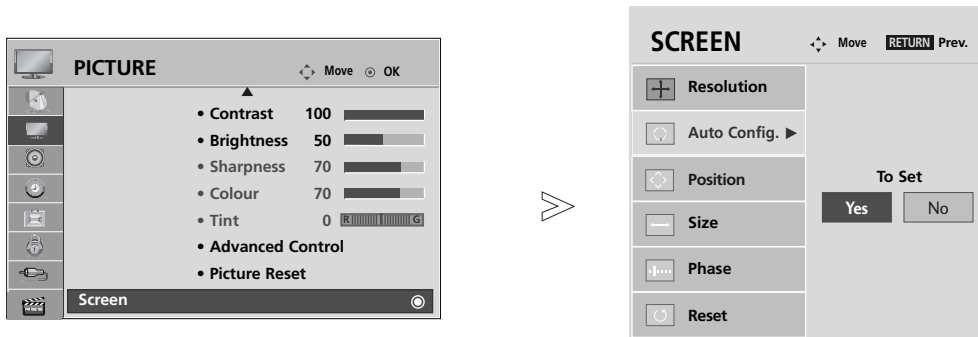

1 Select **PICTURE**.

2 Select **Screen**.

3 Select **Auto Config..**

4 Select **Yes**.

5 Run **Auto Config..**

- If the position of the image is still not correct, try Auto adjustment again.
- If picture needs to be adjusted again after Auto adjustment in RGB (PC), you can adjust the **Position, Size or Phase**.

- Press the **MENU** button to return to normal TV viewing.
- Press the **RETURN** button to move to the previous menu screen.







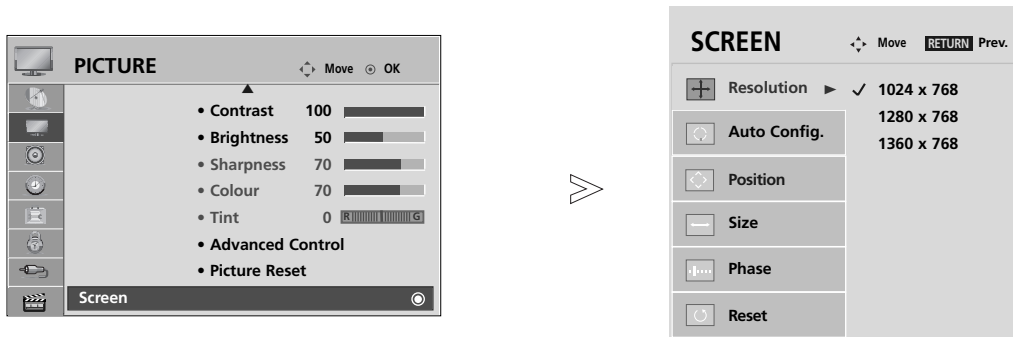

# EXTERNAL EQUIPMENT SETUP

## Selecting Resolution

To view a normal picture, match the resolution of RGB mode and selection of PC mode.

This function works in the following mode: RGB[PC]



- 1   Select **PICTURE**.
- 2   Select **Screen**.
- 3   Select **Resolution**.
- 4   Select the desired resolution.







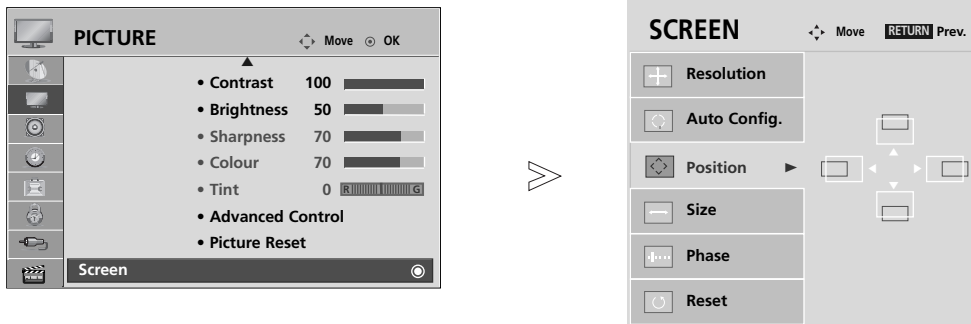

- Press the **MENU** button to return to normal TV viewing.
- Press the **RETURN** button to move to the previous menu screen.

## Adjustment for screen Position, Size, Phase

If the picture is not clear after auto adjustment and especially if characters are still trembling, adjust the picture phase manually.

This function works in the following mode : RGB[PC].



- 1   Select **PICTURE**.
- 2   Select **Screen**.
- 3   Select **Position, Size or Phase**.
- 4    Make appropriate adjustments.

- Press the **MENU** button to return to normal TV viewing.
- Press the **RETURN** button to move to the previous menu screen.

# WATCHING TV / PROGRAMME CONTROL

## REMOTE CONTROL KEY FUNCTIONS

(Only 42/50PQ10\*\*, 42/50PQ11\*\*, 42/50PQ20\*\*, 42/50PQ30\*\*)

When using the remote control, aim it at the remote control sensor on the TV.



**TV/RAD** Selects Radio, TV and DTV channel.

**AV MODE** It helps you select and set images and sounds when connecting AV devices. (► p.50)

**POWER** Switches the TV on from standby or off to standby.

**INPUT** External input mode rotate in regular sequence. (► p.46)

**1 ENERGY SAVING** Adjust the power saving mode of the TV. (► p.73) or **POWER SAVING**

**0~9 number button** Selects a programme. Selects numbered items in a menu.

**Q.VIEW** Returns to the previously viewed programme.

**LIST** Displays the programme table. (► p.45)

**THUMBSTICK** (Up/Down/Left/Right) Allows you to navigate the on-screen menus and adjust the system settings to your preference.

**OK** Accepts your selection or displays the current mode.

**MENU** Selects a menu. Clears all on-screen displays and returns to TV viewing from any menu. (► p.34)

**RETURN(EXIT)** Allows the user to move return one step in an interactive application, EPG or other user interaction function.

**Coloured buttons** These buttons are used for teletext (on **TELETEXT** models only) , **Programme edit**.

**2 TELETEXT BUTTONS** These buttons are used for teletext. For further details, see the 'Teletext' section. (► p.105)

**SUBTITLE** Recalls your preferred subtitle in digital mode.

**SIMPLINK** See a list of AV devices connected to TV. When you toggle this button, the Simplink menu appears at the screen. (► p.47) (Except for 42/50PQ10\*\*, 42/50PQ11\*\*)

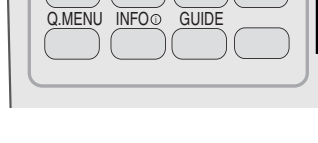
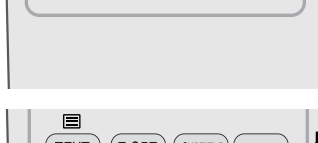
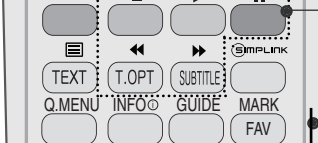
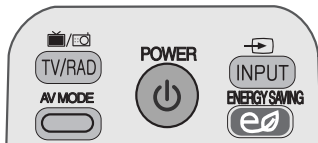
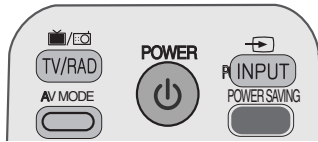

**VOLUME UP /DOWN** Adjusts the volume.

**MUTE** Switches the sound on or off.

**Programme UP/DOWN** Selects a programme.

**PAGE UP/DOWN** Move from one full set of screen information to the next one.

**SIMPLINK / USB Menu control buttons** Controls SIMPLINK or USB menu (Photo List and Music List or Movie List (Only 42/50PQ60\*\*, 50PS60\*\*)).

**Q. MENU** Select the desired quick menu source. (Aspect Ratio, Picture Mode, Sound Mode, Audio, Sleep Timer, USB Eject.) (▶ p.33)

**INFO ⓘ** Shows the present screen information.

**GUIDE** Shows programme schedule. (▶ p.67)

**FAV** Displays the selected favourite programme.

**MARK** Check and un-check programmes in the USB menu. (Except for 42/50PQ10\*\*, 42/50PQ11\*\*)

### Installing Batteries

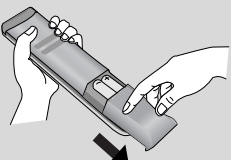

- Open the battery compartment cover on the back and install the batteries matching correct polarity (+with +,-with -).
- Install two 1.5V AAA batteries. Do not mix old or used batteries with new ones.
- Close cover.
- To remove the batteries, perform the installation actions in reverse.

# WATCHING TV / PROGRAMME CONTROL

(Except for 42/50PQ10\*\*, 42/50PQ11 \*\*, 42/50PQ20\*\*, 42/50PQ30\*\*)



- ENERGY SAVING** Adjust the power saving mode of the TV.(▶ p.73)

**RATIO** Selects your desired picture format.(▶ p.71)

**POWER** Switches the TV on from standby or off to standby.

**INPUT** External input mode rotate in regular sequence.(▶ p.46)

**TV/RAD** Selects Radio, TV and DTV channel.
- Q. MENU** Select the desired quick menu source. (Aspect Ratio, Picture Mode, Sound Mode, Audio, Sleep Timer, USB Eject.)(▶ p.33)

**MENU** Selects a menu. Clears all on-screen displays and returns to TV viewing from any menu.(▶ p.34)

**GUIDE** Shows programme schedule.(▶ p.67)
- THUMBSTICK** Allows you to navigate the on-screen menus and adjust the system settings to your preference.

**OK** Accepts your selection or displays the current mode.
- RETURN(EXIT)** Allows the user to move return one step in an interactive application, EPG or other user interaction function.

**INFO ⓘ** Shows the present screen information.

**AV MODE** It helps you select and set images and sounds when connecting AV devices.(▶ p.50)
- Coloured buttons** These buttons are used for teletext (on **TELETEXT** models only) , **Programme edit**.
- 1 TELETEXT BUTTONS** These buttons are used for teletext. For further details, see the 'Teletext' section.(▶ p.105)

**SUBTITLE** Recalls your preferred subtitle in digital mode.

**SIMPLINK** See a list of AV devices connected to TV. When you toggle this button, the Simplink menu appears at the screen.(▶ p.47)

**FREEZE** Pause the present picture at the screen.





**VOLUME UP /DOWN** Adjusts the volume.

**MARK** Check and un-check programmes in the USB menu.

**FAV** Displays the selected favourite programme.

**MUTE** Switches the sound on or off.

**Programme UP/DOWN** Selects a programme.

**PAGE UP/DOWN** Move from one full set of screen information to the next one.

**0~9 number button** Selects a programme.  
Selects numbered items in a menu.

**LIST** Displays the programme table. (▶ p.45)

**Q.VIEW** Returns to the previously viewed programme.

**SIMPLINK / USB Menu List or Movie List** Controls SIMPLINK or USB menu (Photo List and Music USB Menu List or Movie List (Only 42/50PQ60\*\*, 50PS60\*\*)).

### Installing Batteries

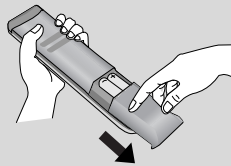

- Open the battery compartment cover on the back and install the batteries matching correct polarity (+with +,-with -).
- Install two 1.5V AAA batteries. Do not mix old or used batteries with new ones.
- Close cover.
- To remove the batteries, perform the installation actions in reverse.

# WATCHING TV / PROGRAMME CONTROL

## TURNING ON THE TV

- When your TV is turned on, you will be able to use its features.

- 1 Firstly, connect the power cord correctly and check the main power(  $\phi$  / I ) on the TV.
- 2 **Set ID : Off**  
In standby mode to turn TV on, press the INPUT or P  $\blacktriangle$   $\blacktriangledown$  button on the TV or press the POWER button on the remote control and the TV will switch on.  
**Set ID : On**  
In standby mode to turn TV on, press the INPUT or P  $\blacktriangle$   $\blacktriangledown$  button on the TV or press the POWER, INPUT, P  $\wedge$   $\vee$  or NUMBER button on the remote control and the TV will switch on.

## INITIALIZING SETUP

- 1 If the OSD (On Screen Display) is displayed on the screen after turning on the TV, you can adjust the **Language, Mode Setting, Country, Auto tuning.**  
**Note:**
  - a. If you close without completing the initial setting, the Initial Setting menu can be displayed again.
  - b. Press the RETURN button to change the current OSD to the previous OSD.
  - c. For those countries without confirmed DTV broadcasting standards, some DTV features might not work, depending on the DTV broadcasting environment.
  - d. "Home Use" mode is the optimal setting for home environments, and is the TV's default mode.
  - e. "Store Demo" mode is the optimal setting for store environments. If a user modifies image quality data, "Store Demo" mode initializes the product to the image quality set by us after a certain period of time.
  - f. The mode (Home Use, Store Demo) can be changed by executing **Mode Setting** in the **OPTION** menu.

## PROGRAMME SELECTION

- 1 Press the P  $\wedge$   $\vee$  or NUMBER buttons to select a programme number.

## VOLUME ADJUSTMENT

- 1 Press the  $\blacktriangleleft$  + or - button to adjust the volume.

If you wish to switch the sound off, press the MUTE button.

You can cancel this function by pressing the MUTE,  $\blacktriangleleft$  + or -, AV Mode button.





# QUICK MENU

Your TV's OSD (On Screen Display) may differ slightly from that shown in this manual.

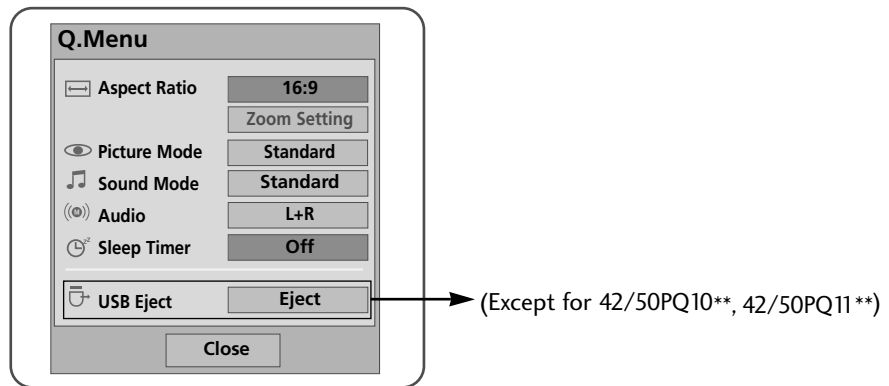
Q.Menu (Quick Menu) is a menu of features which users might use frequently.

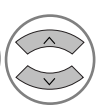
- **Aspect Ratio**: Selects your desired picture format.  
For Zoom Setting, select 14:9, Zoom and Cinema Zoom in Ratio Menu. After completing Zoom Setting, the display goes back to Q.Menu.
- **Picture Mode**: Selects your desired Picture Mode.
- **Sound Mode**: It is a feature to automatically set the sound combination which it deems the best for the images being watched. Selects your desired Sound Mode.
- **Audio**: Selects the sound output.
- **Sleep Timer**: Sets the sleep timer.
- **USB Eject**: Selects "USB Eject" in order to eject USB device. (Except for 42/50PQ10\*\*, 42/50PQ11\*\*)

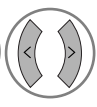
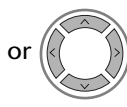

1.   Display each menu.
2.   or  Select your desired Source.
3. 

- Press the **Q.MENU** button to return to normal TV viewing.
- Press the **RETURN** button to move to the previous menu screen.

# WATCHING TV / PROGRAMME CONTROL

## ON-SCREEN MENUS SELECTION AND ADJUSTMENT

Your TV's OSD (On Screen Display) may differ slightly from that shown in this manual.

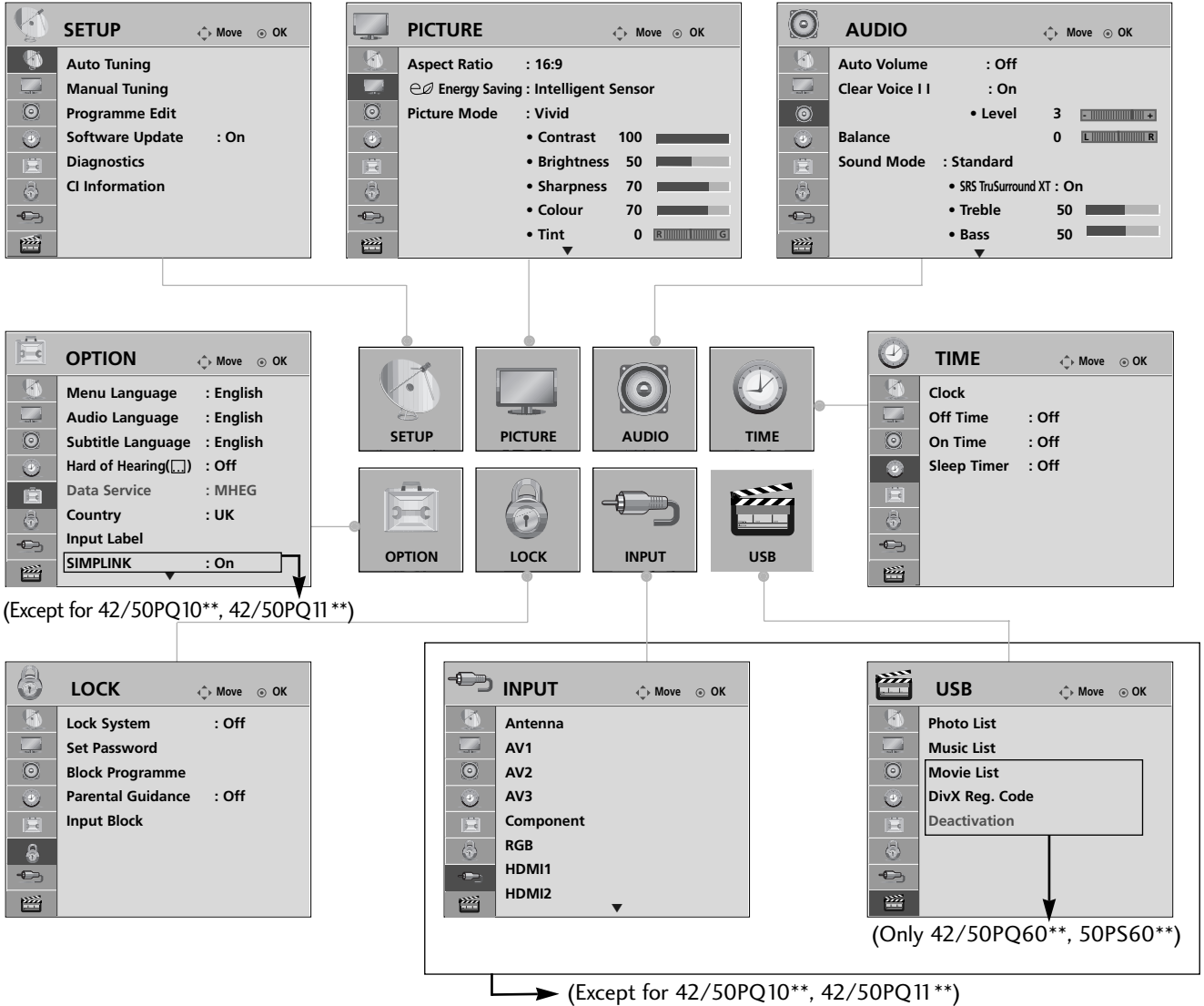

WATCHING TV / PROGRAMME CONTROL

- 1 Display each menu.
- 2 Select a menu item.
- 3 Move to the pop up menu.

- Press the **INFO** button, you can check the Simple Manual Menu.
- Press the **MENU** button to return to normal TV viewing.
- Press the **RETURN** button to move to the previous menu screen.

### ! NOTE

► It is not possible to use **CI Information** in Analogue mode.





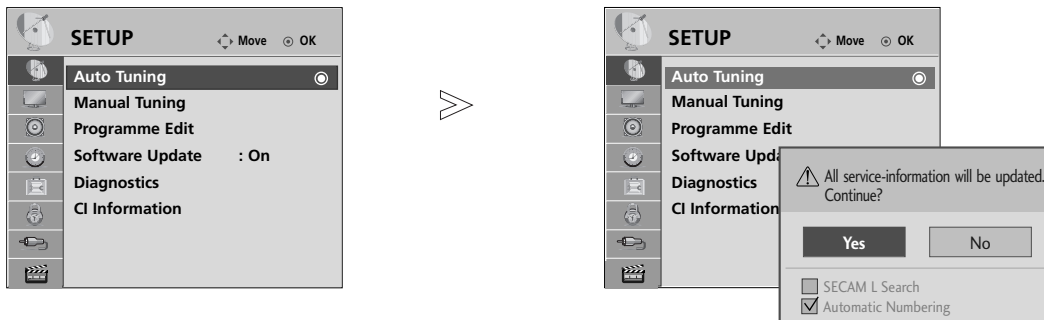

# AUTO PROGRAMME TUNING

Use this to automatically find and store all available programmes.

When you start auto programming, all previously stored service information will be deleted.

The maximum number of programmes that can be stored is 500. But the number may differ slightly depending on broadcasting signals.



- 1   Select **SETUP**.
- 2   Select **Auto Tuning**.
- 3   Select **Yes**.
- 4  Run **Auto Tuning**.

- Use **NUMBER** buttons to input a 4-digit password in **Lock System 'On'**.
- If you wish to keep on auto tuning select **Yes** using the < > button. Then, press the **OK** button. Otherwise select **No**.
- **Automatic Numbering**: Decide whether to use the programme numbers as sent by broadcasting stations for tuning.





- Press the **MENU** button to return to normal TV viewing.
- Press the **RETURN** button to move to the previous menu screen.

# WATCHING TV / PROGRAMME CONTROL

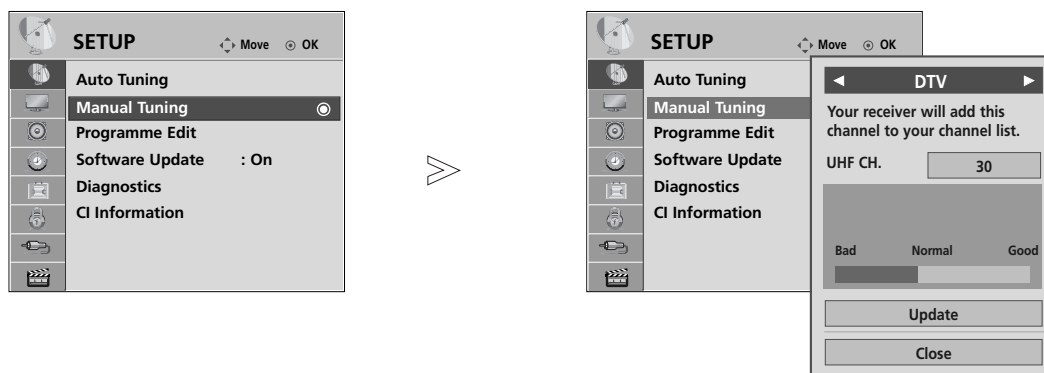
## MANUAL PROGRAMME TUNING (IN DIGITAL MODE)

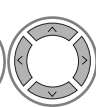
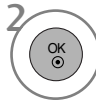
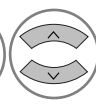
Manual Tuning lets you manually add a programme to your programme list.

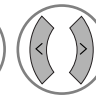

- 1   Select **SETUP**.
- 2   Select **Manual Tuning**.
- 3   Select **DTV**.
- 4   Select the desired channel number.

• Use **NUMBER** buttons to input a 4-digit password in **Lock System 'On'**.

- Press the **MENU** button to return to normal TV viewing.
- Press the **RETURN** button to move to the previous menu screen.

# MANUAL PROGRAMME TUNING (IN ANALOGUE MODE)

Manual Tuning lets you manually tune and arrange the stations in whatever order you desire.

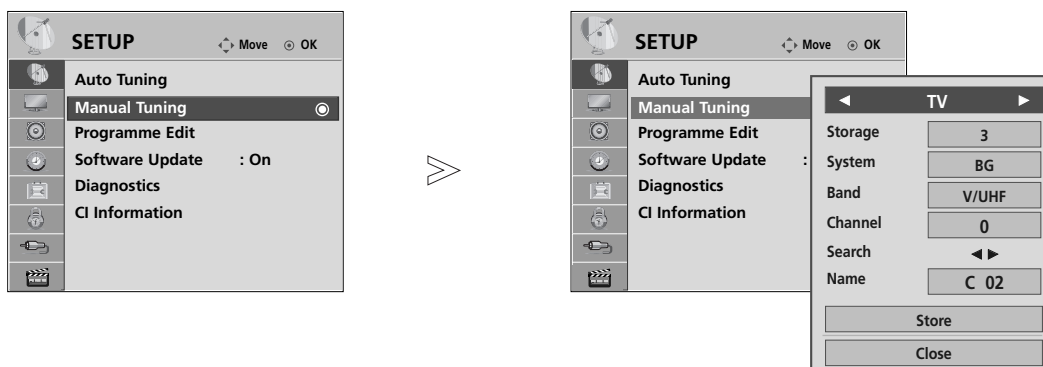

1 Select **SETUP**.

2 Select **Manual Tuning**.

3 Select **TV**.

4 or Select the desired programme number on.

5 Select a TV system.

6 Select **V/UHF** or **Cable**.

7 or Select the desired channel number.

8 Commence searching.

9 Select **Store**.

- Press the **MENU** button to return to normal TV viewing.
- Press the **RETURN** button to move to the previous menu screen.





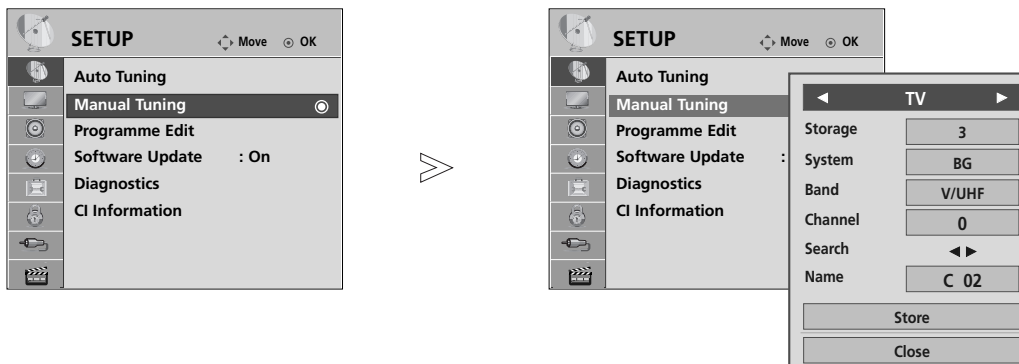



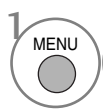

- Use **NUMBER** buttons to input a 4-digit password in **Lock System 'On'**.
- **L** : SECAM L/L' (France)
- **BG** : PAL B/G, SECAM B/G (Europe / East Europe / Asia / New Zealand / M.East / Africa / Australia)
- **I** : PAL I/II (U.K. / Ireland / Hong Kong / South Africa)
- **DK** : PAL D/K, SECAM D/K (East Europe / China / Africa / CIS)
- To store another channel, repeat steps 4 to 9.

# WATCHING TV / PROGRAMME CONTROL

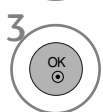
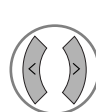

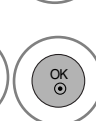
## ■ Assigning a station name

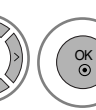
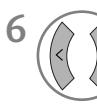
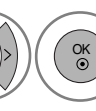
You can assign a station name with five characters to each programme number.

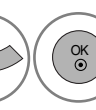
- 1   Select **SETUP**.
- 2   Select **Manual Tuning**.
- 3   Select **TV**.
- 4   Select **Name**.
- 5   Select the position and make your choice of the second character, and so on. You can use an the alphabet **A** to **Z**, the number **0** to **9**, +/ -, and blank.
- 6   Select **Close**.
- 7   Select **Store**.

- Press the **MENU** button to return to normal TV viewing.
- Press the **RETURN** button to move to the previous menu screen.



## PROGRAMME EDIT





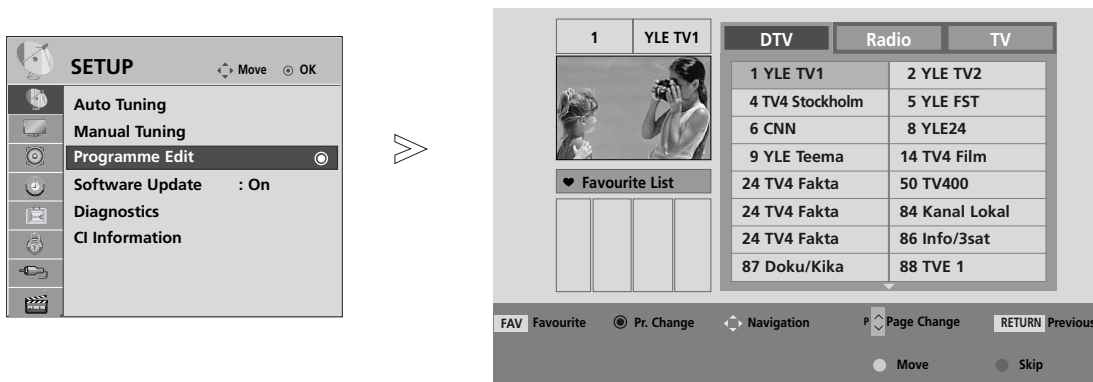

When a programme number is skipped, it means that you will be unable to select it using **P**  $\wedge$   $\vee$  button during TV viewing.

If you wish to select the skipped programme, directly enter the programme number with the **NUMBER** buttons or select it in the Programme edit menu.

This function enables you to skip the stored programmes.

In some countries it is possible to move a programme number by using the **YELLOW** button only.



- 1   Select **SETUP**.
- 2   Select **Programme Edit**.
- 3  Enter the **Programme Edit**.
- 4  Select a programme to be stored or skipped.

- Use **NUMBER** buttons to input a 4-digit password in **Lock System 'On'**.

- Press the **MENU** button to return to normal TV viewing.
- Press the **RETURN** button to move to the previous menu screen.

# WATCHING TV / PROGRAMME CONTROL

## (IN DTV/RADIO MODE)

### ■ Skipping a programme number



1 Select a programme number to be skipped.



2 Turn the skipped programme number to blue.



3 Release the skipped programme.

- When programmes are to be skipped, the skipped programme shows in blue and these programmes will not be selected by the **P** ^ v buttons during TV viewing.
- If you wish to select a skipped programme, directly enter the programme number with the NUMBER buttons or select it in the programme edit or EPG.

### ■ Selecting favourite programme



1 Select your favourite programme number.

- This will automatically include the selected programme into your favourite programme list.

## IN TV MODE



This function enables you to delete or skip the stored programmes. You can also move some channels and use other programme numbers.

### ■ Auto Sort

- 1  Start Auto Sort.





- After activating Auto Sort once, you can no longer edit programmes.

### ■ Deleting a programme



- 1  Select a programme number to be deleted.
- 2  Turn the deleted programme number to red.
- 3  Release the deleted programme.

- The selected programme is deleted, all the following programmes are shifted up one position.

### ■ Moving a programme



- 1  Select a programme number to be moved.
- 2   Turn the moved programme number to YELLOW.
- 3  Release the moved programme.

### ■ Skipping a programme number

- 1  Select a programme number to be skipped.
- 2  Turn the skipped programme number to blue.
- 3  Release the skipped programme.

- When a programme number is skipped it means that you will be unable to select it using the P ^ v button during normal TV viewing.
- If you wish to select a skipped programme, directly enter the programme number with the NUMBER buttons or select it in the programme edit or EPG.

### ■ Selecting a Favourite Programme

- 1   Select your favourite programme number.

- The selected programme will be added to the favourite programme list.

# WATCHING TV / PROGRAMME CONTROL

## SOFTWARE UPDATE

Software Update means software can be downloaded through the digital terrestrial broadcasting system.

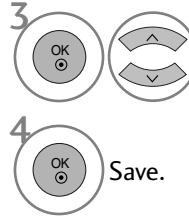
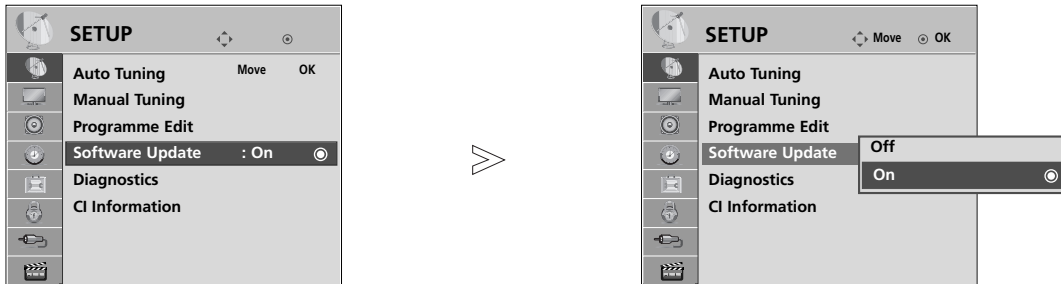

Select **On** or **Off**.

- If you select **On**, a user confirm message box will be displayed to notify that new software is found.

### \* When setting "Software Update"

Occasionally, a transmission of updated digital software information will result in the following menu on the TV screen.

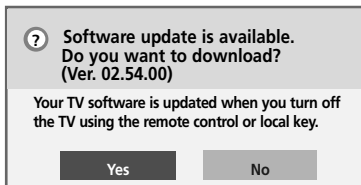

Select the **YES** using the < > button and you will see the following picture.

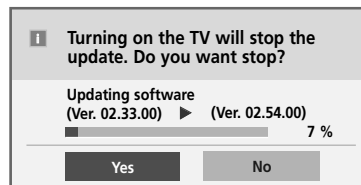

After the Software Update is complete, the System restarts.

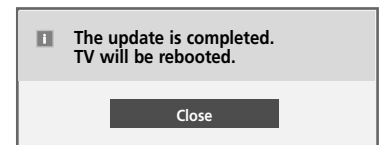

Simple Update :for current update stream

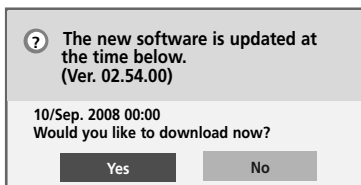

When the power is turned off, downloading starts.

When the power is turned on while updating, the progress status is displayed.

Schedule Update : for scheduled update stream

When the Software Update menu is "Off", the message to change it to "On" appears.

- During Progress of a Software Update, please note the following:

- Power to the TV must not be interrupted.
- The TV must not be switched off.
- The antenna must not be disconnected.
- After Software Update, you can confirm the updated software version in Diagnostics menu.
- It may take an hour to download the software, so make sure that the power stays on during the download.

# DIAGNOSTICS





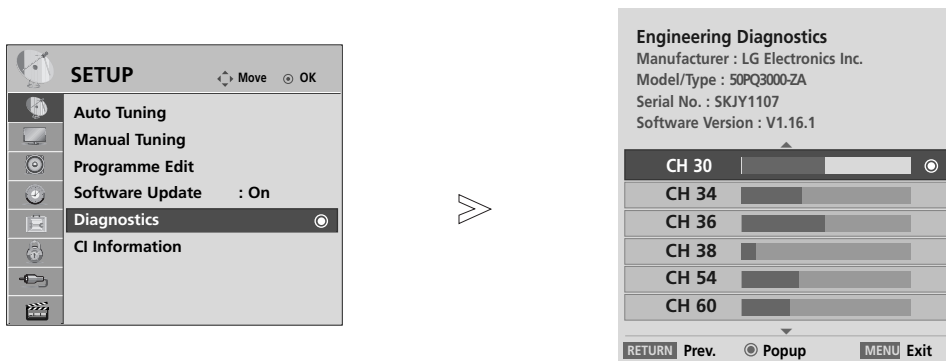

This function enables you to view information on the Manufacturer, Model/Type, Serial Number and Software Version.

This displays the information and signal strength of the tuned \*MUX.

This displays the signal information and service name of the selected MUX.

(\*MUX: A higher directory of channels in digital broadcasting (a single MUX contains multiple channels.))



- 1   Select **SETUP**.
- 2   Select **Diagnostics**.
- 3  Display Manufacturer, Model/Type, Serial Number and Software Version.
- 4   Display the information of Channel.

- Press the **MENU** button to return to normal TV viewing.
- Press the **RETURN** button to move to the previous menu screen.

# WATCHING TV / PROGRAMME CONTROL

## CI [COMMON INTERFACE] INFORMATION

This function enables you to watch some encrypted services (pay services). If you remove the CI Module, you cannot watch pay services.

When the module is inserted into the CI slot, you can access the module menu.

To purchase a module and smart card, contact your dealer. Do not repeatedly insert or remove a CI module from the TV. This may cause a malfunction. When the TV is turned on after inserting a CI Module, you may not have any sound output.

This may be incompatible with the CI module and smart card.

CI (Common Interface) functions may not be possible depending upon the country broadcasting circumstances.

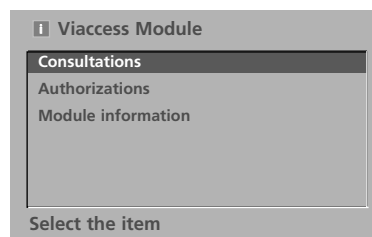
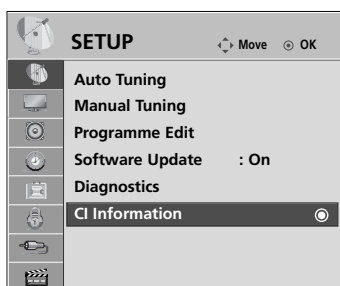

- This OSD is only for illustration and the menu options and screen format will vary according to the Digital pay services provider.
- It is possible for you to change CI (Common Interface) menu screen and service by consulting your dealer.

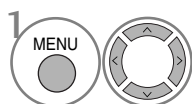

1 Select **SETUP**.

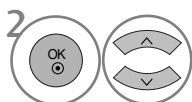

2 Select **CI Information**.

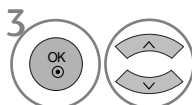

3 Select the desired item: Module information, smart card information, language, or software download etc.



4 Save.

- Press the **MENU** button to return to normal TV viewing.
- Press the **RETURN** button to move to the previous menu screen.

## SELECTING THE PROGRAMME TABLE

You can check which programmes are stored in the memory by displaying the programme table

 Displayed when the Locked Programme.

### ■ Displaying programme LIST

1  Display the Programme List.

- You may find some blue programmes. These have been set up to be skipped by auto programming or in the programme edit mode.
- Some programmes with the channel number shown in the programme LIST indicate there is no station name assigned.

### ■ Selecting a programme in the programme list

1  Select a programme.

2  Switch to the chosen programme number.

 From the programme you are currently watching, the mode will change from TV to DTV to Radio.

### ■ Paging through a programme list

1  Turn the pages.

2  Return to normal TV viewing.

### ■ Displaying the favourite programme table

1  Display the Favourite Programme table.

# WATCHING TV / PROGRAMME CONTROL

## INPUT LIST

HDMI and AV1, 2 (SCART) can be recognized by a detect pin and thus enabled only when an external device approves voltage.

By using **TV/RAD** button, you can move from External Input to RF Input and to the last watched programme in DTV/RADIO/TV mode.

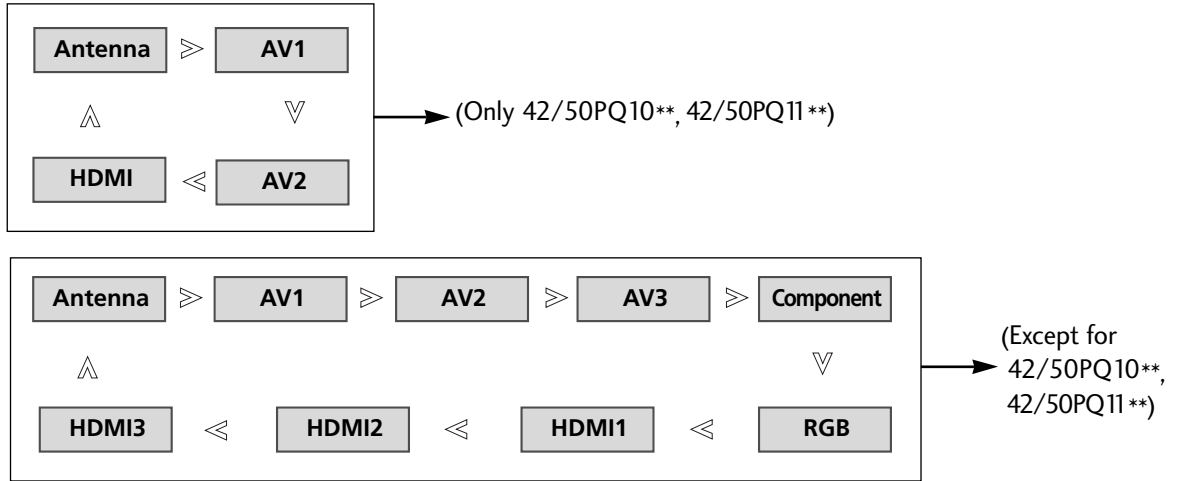

(Except for 42/50PQ10\*\*, 42/50PQ11\*\*)



• You can also adjust **INPUT** menu.

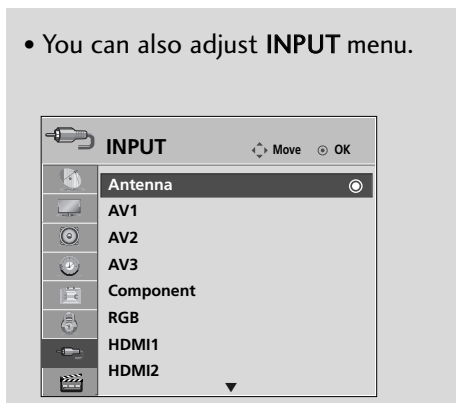

- **Antenna** : Select it when watching the DTV/TV.
- **AV1, AV2, AV3** : Select it when watching the VCR or external equipment.
- **Component** : Select it when using the DVD or the Digital set-top box depends on connector.
- **RGB** : Select it when using PC depends on connector.
- **HDMI1, HDMI2, HDMI 3** : Select it when using DVD, PC or Digital set-top box depend on connector.



## SIMPLINK (Except for 42/50PQ10\*\*, 42/50PQ11 \*\*)

This function operates only with devices with the SIMPLINK logo.  
Please check the SIMPLINK logo.

This TV might not function properly when using it with other products with HDMI-CEC function.

This allows you to control and play other AV devices connected to the display through HDMI cable without additional cables and settings.

If you do not want SIMPLINK menu, select "Off".

SIMPLINK function is not supported by HDMI IN 3 input.

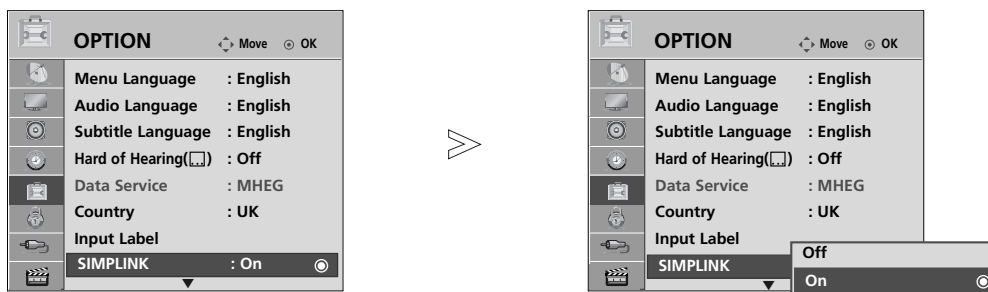

- Press the **MENU** button to return to normal TV viewing.
- Press the **RETURN** button to move to the previous menu screen.

## SIMPLINK Functions

### Disc playback

Control connected AV devices by pressing the  $\wedge$   $\vee$   $\lt$   $\gt$ , OK,  $\blacktriangleright$ ,  $\blacksquare$ ,  $\text{II}$ ,  $\lll$  and  $\ggg$  buttons.

### Direct Play

After connecting AV devices to the TV, you can directly control the devices and play media without additional settings.

### Select AV device

Enables you to select one of the AV devices connected to the TV and operate it.

### Power off all devices

When you switch off the TV, all connected devices are turned off.

### Switch audio-out

Offers an easy way to switch audio-out.

### Sync Power on

When the equipment with Simplink function connected HDMI terminal starts to play, The TV will change automatically to turn on mode.

\* A device, which is connected to the TV through a HDMI cable but does not support SIMPLINK, does not provide this function.

Note: To operate SIMPLINK, an HDMI cable over Version 1.3 with \*CEC function should be used. (\*CEC: Consumer Electronics Control).

# WATCHING TV / PROGRAMME CONTROL

## Connecting to Home Theater with the SIMPLINK logo.

- 1 Connect the **HDMI/DVI IN 1** or **HDMI IN 2** terminal on the back of the TV and the HDMI output terminal of the Home Theater using HDMI cables.
- 2 Connect the Digital Audio output terminal on the back of the TV and the Digital Audio input terminal of the Home Theater using optical cables.
- 3 Select Home Theater in the Speaker menu by pushing the **SIMPLINK** button.

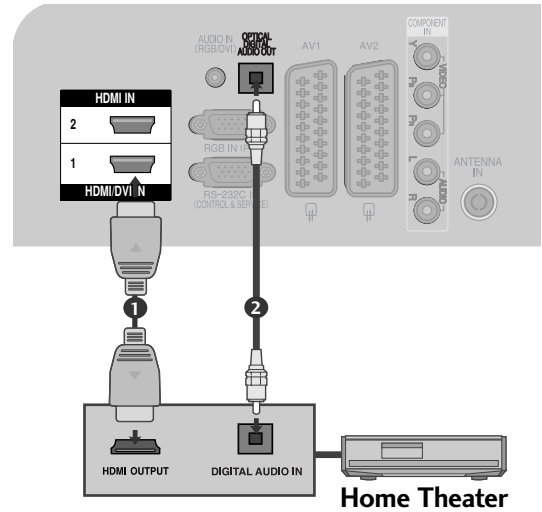

▶ When you select or operate a media device with home theater function, the speaker automatically switches to home theater speaker (HT speaker).

### ! NOTE

- ▶ Connect the HDMI/DVI IN or HDMI IN terminal of the TV to the rear terminal (HDMI terminal) of the SIMPLINK device with the HDMI cable.
- ▶ When you switch the Input source using the INPUT button on the remote control, you can stop the operation of a device controlled by SIMPLINK.

## SIMPLINK Menu

Press the  $\wedge$   $\vee$   $\lt$   $\gt$  button and then **OK** button to select the desired SIMPLINK source.

- 1 **TV viewing** : Switch to the previous TV programme regardless of the current mode.
- 2 **DISC playback** : Select and play connected discs. When multiple discs are available, the titles of discs are conveniently displayed at the bottom of the screen.
- 3 **VCR playback** : Play and control the connected VCR.
- 4 **HDD Recordings playback** : Play and control recordings stored in HDD.
- 5 **Audio Out to Home theater/Audio Out to TV:** Select Home theater or TV speaker for Audio Out.

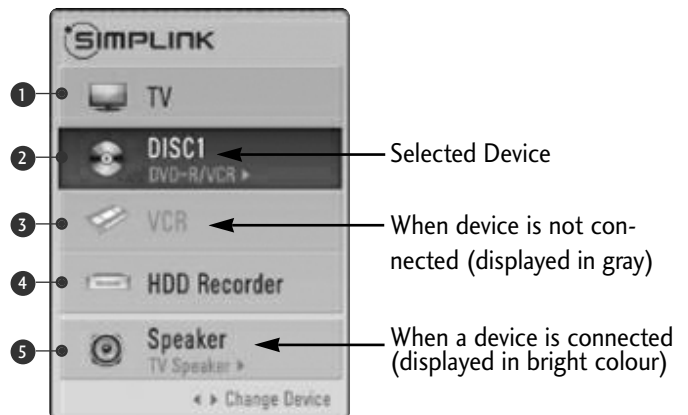

- Home theater: Only one supported at a time
- DVD, Recorder: Up to two supported at a time
- VCR: Only one supported at a time

## DATA SERVICE

(This menu is enabled only in Ireland.)

This function allow users to choose between **MHEG(Digital Teletext)** and **Teletext** if both exist at the same time.

If only one of them exists, either **MHEG** or **Teletext** is enabled regardless of which option you selected.

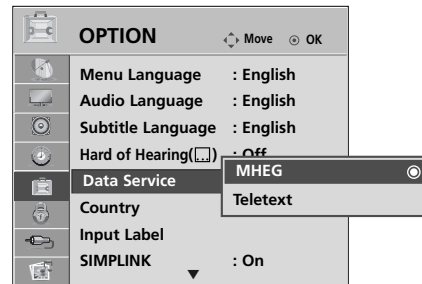
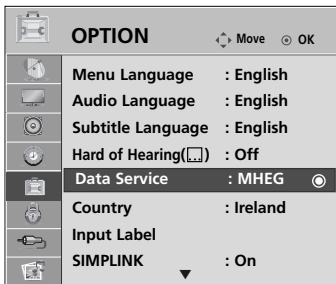

- Press the **MENU** button to return to normal TV viewing.
- Press the **RETURN** button to move to the previous menu screen.

## INPUT LABEL

Selects a label for each input source.

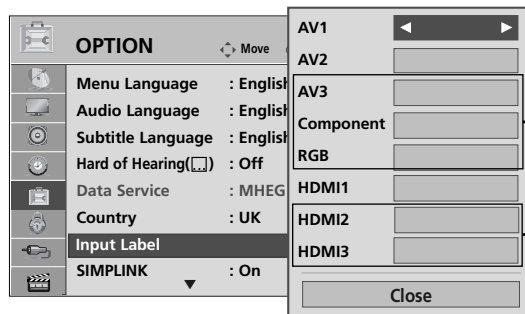

(Except for 42/50PQ10\*\*, 42/50PQ11\*\*)



- Press the **MENU** button to return to normal TV viewing.
- Press the **RETURN** button to move to the previous menu screen.

# WATCHING TV / PROGRAMME CONTROL

## AV MODE

You can select the optimal images and sounds when connecting AV devices to external input.

- Off** Disables the AV MODE.
- Cinema** Optimizes video and audio for watching movies.
- Sport** Optimizes video and audio for watching sports events.
- Game** Optimizes video and audio for playing games.

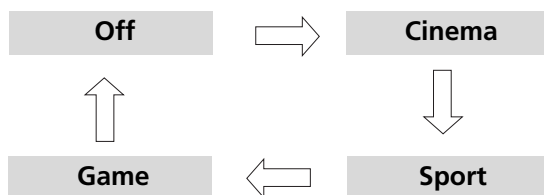

1 Press the **AV MODE** button repeatedly to select the desired source.







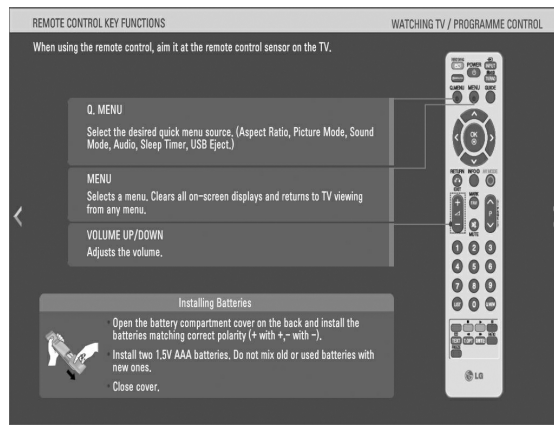
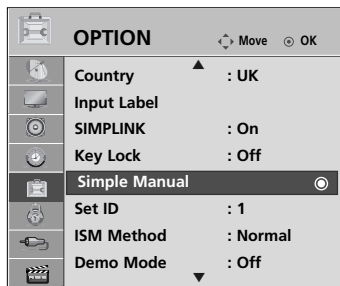

- If you select **Cinema** in AV mode, **Cinema** will be selected both for **Picture Mode** and **Sound Mode** in **PICTURE** menu and **AUDIO** menu respectively.
- If you select “**Off**” in AV mode, the picture and image which you initially set will be selected.

# SIMPLE MANUAL

You can easily and effectively access the TV information by viewing a simple manual on the TV. During the Simple Manual operation, audio will be muted.





- 1   Select **OPTION**.
- 2   Select **Simple Manual**.
- 3   Select the part of the manual you want to see.

- Press the **RETURN** button to return to normal TV viewing.

# WATCHING TV / PROGRAMME CONTROL

## Initializing (Reset to original factory settings)

This function initializes all settings.



But the settings of  **Day** and  **Night** of the **Picture Mode** cannot be initialized.

It is useful to initialize the product or when you move to other city or country.

When the Factory Reset is completed, you must restart the Initializing setup.

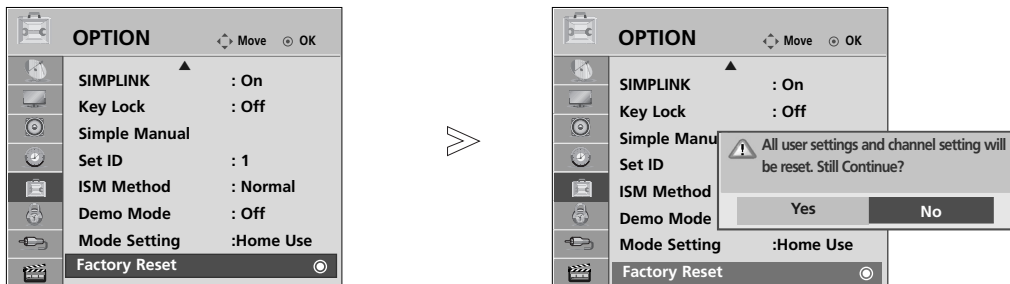
When the **Lock System** menu is "On", the message to enter the password appears.

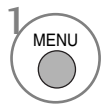
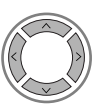

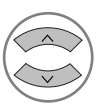
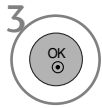
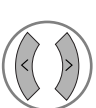
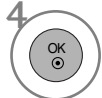
-   Select **OPTION**.
-   Select **Factory Reset**.
-   Select **Yes**.
-  Start **Factory Reset**.

• In **Lock System "On"**, if you forget your password, press '7', '7', '7', '7' on the remote control handset.

- Press the **MENU** button to return to normal TV viewing.
- Press the **RETURN** button to move to the previous menu screen.

# TO USE A USB DEVICE

- ▶ It is not possible to use USB function in 42/50PQ10\*\*, 42/50PQ11\*\* models.

## When connecting a USB device

When you connect a USB device, this pop up menu is displayed, automatically.

If the Pop Up menu does not appear, you can select Music List or Photo List or Movie List(Only 42/50PQ60\*\*, 50PS60\*\*) in the USB menu.

“POP UP MENU” will not be displayed while the OSD including Menu, EPG or Schedule list is activated.

In USB device, you can not add a new folder or delete the existing folder.

- 1 Connect the USB device to the **USB IN** jacks on the side of TV.

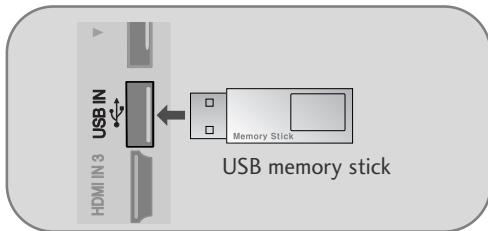

- This TV Supports on JPEG and MP3 and SD Divx.

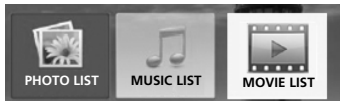

- 2 Select **PHOTO LIST** or **MUSIC LIST** or **MOVIE LIST**(Only 42/50PQ60\*\*, 50PS60\*\*).



- 3

### When removing the USB device

Select the USB Eject menu before removing the USB device.

- 1 Q. MENU  Select **Eject**
- 2 

## Precautions when using the USB device

- ▶ Only a USB storage device is recognizable.
- ▶ If the USB storage device is connected through a USB hub, the device is not recognizable.
- ▶ A USB storage device using an automatic recognition programme may not be recognized.
- ▶ A USB storage device which uses its own driver may not be recognized.
- ▶ The recognition speed of a USB storage device may depend on each device.
- ▶ Please do not turn off the TV or unplug the USB device when the connected USB storage device is working. When such device is suddenly separated or unplugged, the stored files or the USB storage device may be damaged.
- ▶ Please do not connect the USB storage device which was artificially maneuvered on the PC. The device may cause the product to malfunction or fail to be played. Never forget to use only a USB storage device which has normal music files or image files.
- ▶ Please use only a USB storage device which was formatted as a FAT16, FAT32, NTFS file system provided with the Windows operating system. In case of a storage device formatted as a different utility programme which is not supported by Windows, it may not be recognized.  
Data in a USB storage device cannot be deleted in the NTFS file system.
- ▶ Please connect power to a USB storage device which requires an external power supply. If not, the device may not be recognized.
- ▶ Please connect a USB storage device with cable is offered by USB maker. If connected with cable is not offered by USB maker or an excessively long cable, the device may not be recognized.
- ▶ Some USB storage devices may not be supported or operated smoothly.
- ▶ Maximum of 999 files and folders can be recognized.
- ▶ Data in a USB storage device cannot be aligned.  
Up to 128 English characters can be recognized as a file name.
- ▶ Please back up the important file because a data of USB device may be damaged. Data management is consumer's responsibility and in consequence the manufactures does not cover the product bearing data damage.
- ▶ If the USB is connected in Standby Mode, specific hard disk will automatically be loaded when the TV is turned on.
- ▶ The recommended capacity is 1TB or less for a USB external hard disk and 32GB or less for USB memory.
- ▶ Any device with more than the recommended capacity may not work properly.
- ▶ If a USB external hard disk with a "Energy Saving" function does not work, turn the hard disk off and on again to make it work properly.

# TO USE A USB DEVICE

## NOTE

- Image shown may differ from your TV.
- ▶ In order to avoid losing the USB memory stick, use the USB connector (sold separately) to fix the USB memory stick to the USB connector holder of the TV.

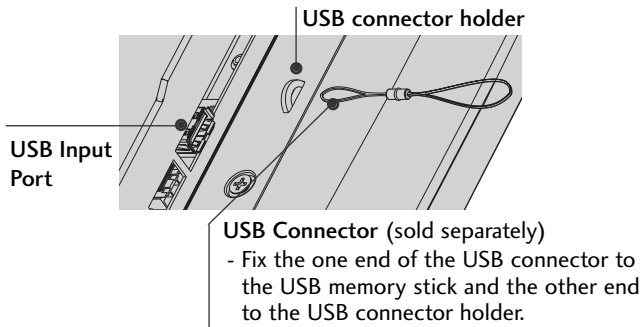

## PHOTO LIST

The On Screen Display may be different from your TV. Images are an example to assist with the TV operation.

### PHOTO(\*.JPEG) supporting file

Baseline: 15360 x 8640

Progressive format : 1024 x 768

- You can play JPEG files only.
- Only baseline scan is supported among JPEG (SOF0, SOF1 only).
- Non-supported files are displayed in the form of bitmap.

## Screen Components

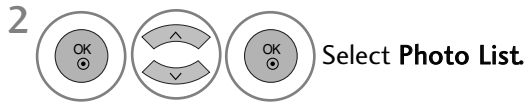

- 1 Moves to upper level folder
- 2 Current page/Total pages
- 3 Total number of marked photos
- 4 Usable USB memory
- 5 Corresponding buttons on the remote control







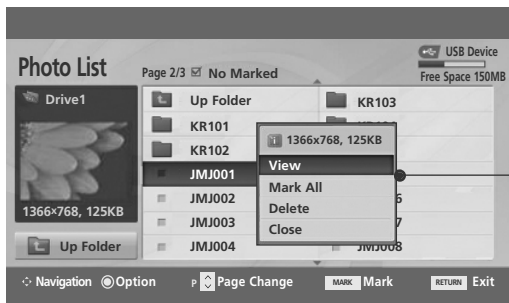
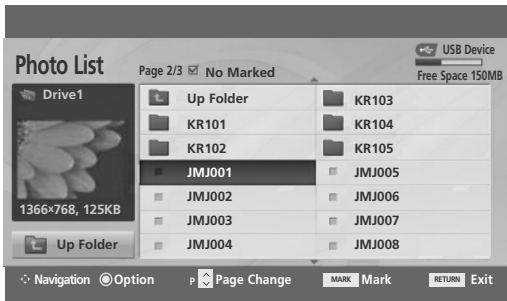





## Photo Selection and PopUp Menu



- ▶ **View** : Display the selected item.
- ▶ **Mark All** : Mark all photos on the screen.
- ▶ **Unmark All** : Deselect all marked photos.
- ▶ **Delete** : Delete the selected photo item.
- ▶ **Close** : Close the pop-up menu.

- 1  Select the target folder or drive.
- 2   Select the desired photos.
- 3   Show the PopUp menu.
- 4   Select the desired PopUp menu.

- Use the **P**   button to navigation in the photo page.
- Use the **MARK** button to mark or unmark a photo. When one or more photos are marked, you can view individual photos or a slide show of the marked photos. If no photos are marked, you can view all photos individually or all photos in the folder in a slide show.

- Press the **RETURN** button to return to normal TV viewing.

# TO USE A USB DEVICE





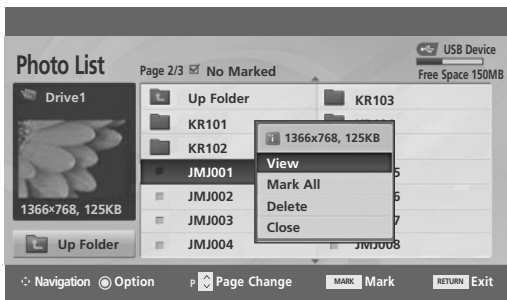
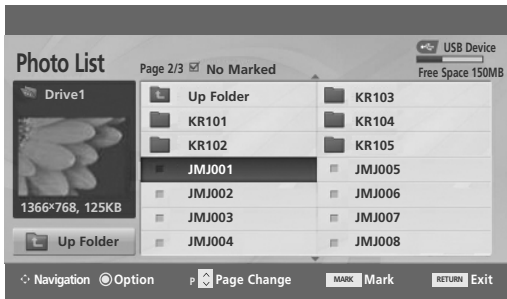

## Set up the menu in Full-Sized Screen

You can change the settings to display photos stored on a USB device, on a full-sized screen. Detailed operations are available on full-sized photo view screen.



The aspect ratio of a photo may change the size of the photo displayed on the screen in full size. Press the **RETURN** button to move to the previous menu screen.

TO USE A USB DEVICE

- 1  Select the target folder or drive.
- 2   Select the desired photos.
- 3  Show the PopUp menu.
- 4  Select **View**.
- 5  The selected photo is displayed in full size.

- Use the **P**   button to navigation in the photo page.

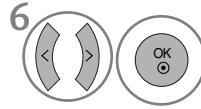

Select the **Slideshow**, **BGM**, **Rotate**, **Delete**, **Option** or **Hide**.

- Use < > button to select the previous or next photo.
- Use < > button to select and control the menu on the full-sized screen.

- ▶ **Slideshow** : When no picture is selected, all photos in the current folder are displayed during slide show. When selected, the selected photos are displayed during slide show.
  - Set the time interval of the slide show in **Option**.
- ▶ **BGM** : Listen to music while viewing photos in full size.
  - Set the BGM device and album in **Option**.
- ▶ **Rotate** : Rotate photos.
  - Rotates the photo 90°, 180°, 270°, 360° clockwise.
- ▶ **Delete** : Delete photos.
- ▶ **OPTION** : Set values for **Slide Speed** and **Music Folder**.
  - Use < > ^ v button and **OK** button to set values. Then go to **OK** and press **OK** to save the settings.
  - You cannot change **Music Folder** while BGM is playing.
- ▶ **Hide** : Hide the menu on the full-sized screen.
  - To see the menu again on the full-sized screen, press **OK** button to display.

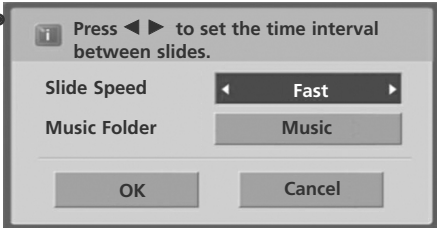

- Press the **RETURN** button to move to the previous menu screen.

# TO USE A USB DEVICE

## MUSIC LIST

Purchased music files(\*.MP3) may contain copyright restrictions. Playback of these files may not be supported by this model.

Music file on your USB device can be played by this unit.

The On Screen Display may be different from your TV. Images are an example to assist with the TV operation.

### MUSIC (\*.MP3) supporting file

Bit rate 32 ~ 320kbps

- Sampling rate MPEG1 layer 3: 32 kHz, 44.1 kHz, 48 kHz.

## Screen Components

**1** MENU Select USB.

**2** OK Select Music List.

**1** Moves to upper level folder

**2** Current page/Total pages

**3** Total number of marked music title

**4** Usable USB memory

**5** Corresponding buttons on the remote control

**Music List** Page 2/3 No Marked USB Device Free Space 150MB

Title	Duration
Up Folder	
S001	
S002	
S003	1:34
S004	1:15
S005	1:20

Up Folder 1:340, 120KB





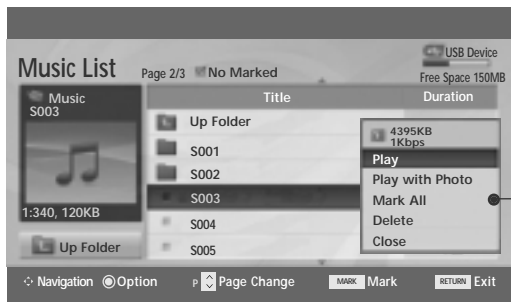
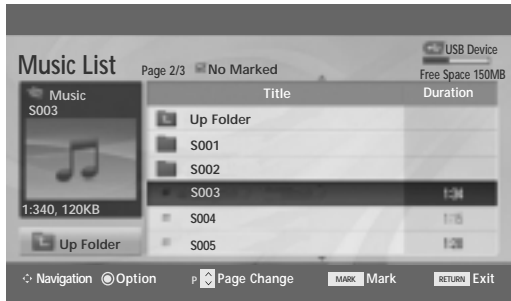

Navigation Option Page Change MARK Mark RETURN Exit

## Music Selection and PopUp Menu

As shown , up to 6 music titles are listed per page.



- ▶ **Play (During stop)** : Play the selected music titles. Once a music finishes playing, the next selected one will be played. When there are no selected music titles to play, the next one in the current folder will be played. If you go to a different folder and press the **OK** button, the current music in playback will stop.
- ▶ **Play Marked** : Play the selected music titles. Once a music finishes playing, the next selected one will be played automatically.
- ▶ **Stop Play (During playback)** : Stop the playing music titles.
- ▶ **Play with Photo** : Start playing the selected music titles and then move to the Photo List.
- ▶ **Mark All** : Mark all music titles in the folder.
- ▶ **Unmark All** : Deselect all marked music titles.
- ▶ **Delete** : Delete the selected music titles.
- ▶ **Close** : Close the pop-up menu.

- 1  Select the target folder or drive.
- 2   Select the desired music title
- 3  Show the PopUp menu.
- 4   Select the desired PopUp menu.

- Use the **P** ^ v button to navigation in the music page.
- Use **MARK** button to mark or unmark a music. When one or more music files are marked, the marked music title will be played in sequence. For example, if you want to listen to only one music repeatedly, just mark the music only and play it. If no music is marked, all the music in the folder will be played in sequence.

- Press the **RETURN** button to return to normal TV viewing.

# TO USE A USB DEVICE



- If you don't press any button for a while during the playing, the play information box (as shown in the below) will float as a screen saver.

- The 'Screen Saver'?

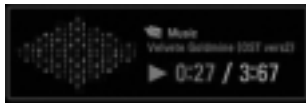
Screen saver is to prevent screen pixel damage due to an fixed image remaining on the screen for a extended period of time.



## ! NOTE

- ▶ When music is playing,  is displayed in back of the music title.
- ▶ A damaged or corrupted music does not play but displays 00:00 in playtime.
- ▶ A music downloaded from a paid service with copyright protection does not start but displays inappropriate information in playtime.
- ▶ If you press **OK**,  buttons, screen saver is stopped.
- ▶ The **PLAY(▶)**, **Pause(II)**, , **▶▶**, **◀◀** buttons on the remote control are also available in this mode.
- ▶ You can use the **▶▶** button to select the next music and the **◀◀** button to select the previous music.

## MOVIE LIST (Only 42/50PQ60\*\*, 50PS60\*\*)

The movie list is activated once USB is detected. It is used when playing movie files on TV.

Displays the movies in the USB folder and supports Play.

Allows playback of all movies in the folder and user desired files.

Video editing is not supported but files can be deleted.

It is a movie list that displays folder information and Divx file.

Supports up to four drives.

MOVIE(\*.avi/\*.Divx) supporting file

Video format : MPEG1 , MPEG2, MPEG4 (Doesn't support Microsoft MPEG4-V2, V3), DivX 3.xx , DivX 4.xx, DivX 5.xx , DivX VOD ( DRM ), XviD, DivX 6.xx(Playback)

Audio format : Mpeg, Mp3, PCM, Dolby Digital

Sampling frequency : within 8~48 khz

Bit rate : within 8~320 kbp

Subtitle format : \*.smi/ \*.srt/ \*.sub(MicroDVD, SubViewer 2.0)/ \*.ass/ \*.ssa/\*.txt(DVD Subtitle System)

- DivX may not be played depending on its types or recording methods.
- If the video and audio structure of recorded file is not interleaved, either video or audio is outputted.
- **Max bitrate of playable DivX is 4 Mbps.**
- Maximum FPS (Frame Per Second) can be reached only at SD level. FPS is 25 FPS (720\*576) or 30 FPS (720\*480) depending on Resolution.
- Files of 25 FPS or 30 FPS of higher may not be played properly.
- Files encoded with GMC(Global Motion Compensation) may not be played.
- When you're watching the movie by using **Movie List** and **Photo List** function, an image mode setup doesn't operate.

Extension name	Video Codec	Audio Codec	Resolution
mpg, mpeg, mpe, vob, dat	MPEG1, MPEG2	AC3, MPEG, MP3, PCM	
Avi, divx, m4v	MPEG4-SP, MPEG4-ASP, DivX 3.xx, DivX 4.xx, DivX 5.xx, DivX 6.xx(Playback), Xvid	AC3, MPEG, MP3, PCM	720x576@25p 720x480@30p

# TO USE A USB DEVICE

## Screen Components

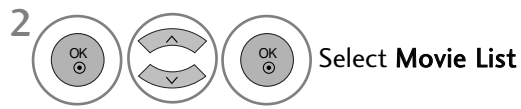

- ❶ Moves to upper level folder
- ❷ Current page/Total pages
- ❸ Total number of marked movie title
- ❹ Usable USB memory
- ❺ Corresponding buttons on the remote control

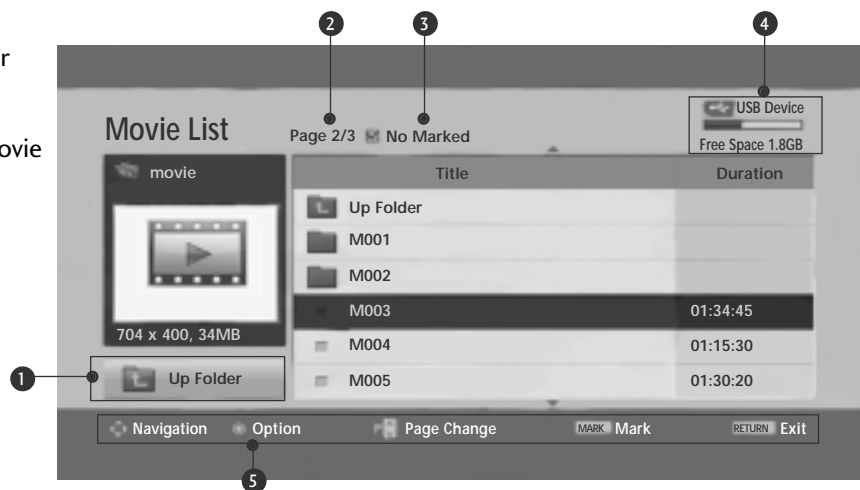

### ! NOTE

- ▶ A DivX movie file and its subtitle file must be located in the same folder.
- ▶ A video file name and its subtitle file name must be identical for it to be displayed.
- ▶ Use the left/right ( < / > ) keys to move to a specific frame forward or backward while playing a movie. (The left/right ( < / > ) keys may not work properly for some files while playing a movie.)







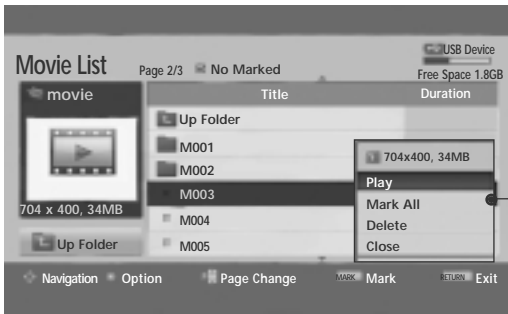
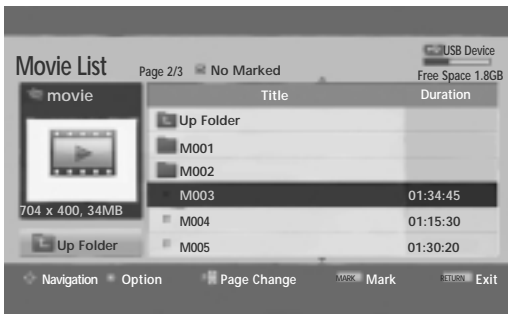

## Movie Selection and PopUp Menu

As shown , up to 6 movie titles are listed per page.



- ▶ **Play** : Play the selected movie titles. Divx Play is executed while screen changes.
- ▶ **Mark All** : Mark all movie titles in the folder.
- ▶ **Unmark All** : Deselect all marked movie titles.
- ▶ **Close** : Close the pop-up menu.

- 1  Select the target folder or drive.
- 2   Select the desired movie titles.
- 3  Show the PopUp menu.
- 4   Select the desired PopUp menu.

- In the case of files not supported, a message regarding non-supported file is displayed.

- Press the **RETURN** button to return to normal TV viewing.

# TO USE A USB DEVICE

## DivX Audio Language & Subtitle Language

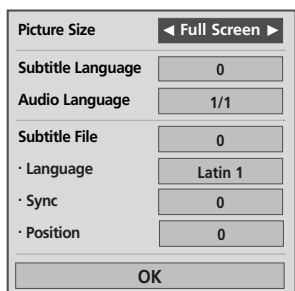

Select the desired option.

• When DivX is playing, if you press the **RED** button, this message is displayed.



Select **Picture Size, Subtitle Language, Audio Language, Subtitle File, Language, Sync or Position.**

- Press the **MENU** button to return to normal TV viewing.
- Press the **RETURN** button to move to the previous menu screen.

## Using the remote control

◀◀ / ▶▶	<p>When playing, repeatedly, press the <b>REW(◀◀)</b> button to speed up ◀◀ -&gt; ◀◀◀ -&gt; ◀◀◀◀ -&gt; ◀◀◀◀◀ -&gt; ◀◀◀◀◀◀.</p> <p>repeatedly, press the <b>FF(▶▶)</b> button to speed up ▶▶-&gt; ▶▶▶ -&gt; ▶▶▶▶ -&gt; ▶▶▶▶▶.</p> <ul style="list-style-type: none"> <li>▪ Pressing these buttons repeatedly increases the fast forward/reverse speed.</li> </ul>
	<p>During playback, press the <b>Pause(  )</b> button.</p> <ul style="list-style-type: none"> <li>▪ Still screen is displayed.</li> </ul>
< >	<ul style="list-style-type: none"> <li>▪ When using the &lt; or &gt; button during playback a cursor indicating the position can be viewed on the screen.</li> </ul>
PLAY(▶)	<p>Press the <b>PLAY(▶)</b> button to return to normal playback.</p>

# DIVX REGISTRATION CODE (Only 42/50PQ60\*\*, 50PS60\*\*)

Confirm the DivX registration code number of the TV. Using the registration number, movies can be rented or purchased at [www.divx.com/vod](http://www.divx.com/vod).

With a DivX registration code from other TV, playback of rented or purchased DivX file is not allowed. (Only DivX files matched with the registration code of the purchased TV are playable.)

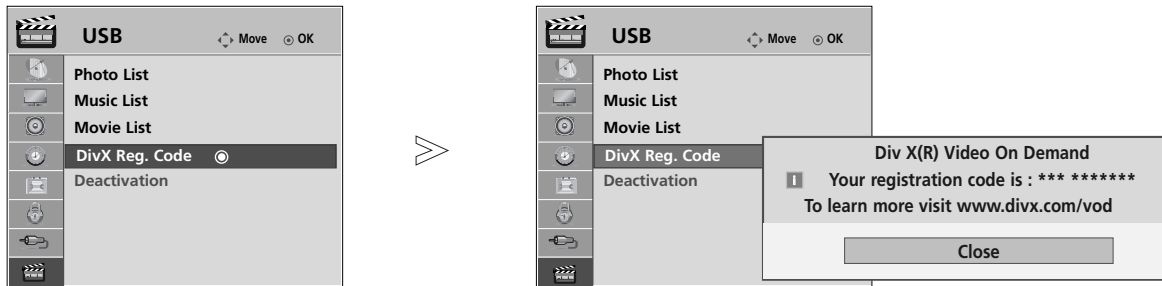

1 Select **USB**.

2 Select **Divx Reg Code**.

3 Display **Divx Reg. Code**.

- Press the **MENU** button to return to normal TV viewing.
- Press the **RETURN** button to move to the previous menu screen.

“DivX Certified to play DivX video, including premium content”



**ABOUT DIVX VIDEO:** DivX® is a digital video format created by DivX, Inc. This is an official DivX Certified device that plays DivX video. Visit [www.divx.com](http://www.divx.com) for more information and software tools to convert your files into DivX video.

**ABOUT DIVX VIDEO-ON-DEMAND:** This DivX Certified® device must be registered in order to play DivX Video-on-Demand (VOD) content. To generate the registration code, locate the DivX VOD section in the device setup menu. Go to [vod.divx.com](http://vod.divx.com) with this code to complete the registration process and learn more about DivX VOD.

## ! NOTE

### Supported movie file

Resolution : under 720x576 WxH pixels.  
Frame rate : under 30 frames/sec





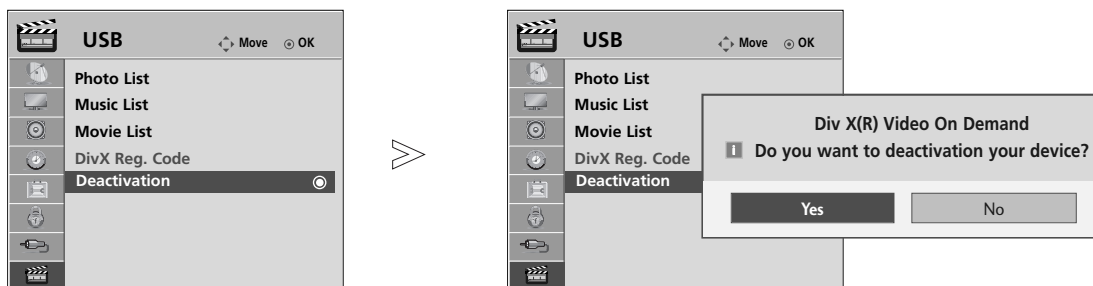

- ▶ Video Codec : MPEG1 , MPEG2, MPEG4 (Doesn't support Microsoft MPEG4-V2, V3), DivX 3.xx , DivX 4.xx, DivX 5.xx , DivX VOD ( DRM ), XviD, DivX 6.xx(Playback).
- ▶ When loading, some buttons may not work.

# TO USE A USB DEVICE

## DEACTIVATION (Only 42/50PQ60\*\*, 50PS60\*\*)

Delete the existing authentication information to receive a new DivX user authentication for TV.  
Once this function is executed, a DivX user authentication is required again to see DivX DRM files.



- 1   Select **USB**.
- 2   Select **Deactivation**.
- 3   Select **Yes** or **No**.

- Press the **MENU** button to return to normal TV viewing.
- Press the **RETURN** button to move to the previous menu screen.













# EPG (ELECTRONIC PROGRAMME GUIDE)(IN DIGITAL MODE)

This system has an Electronic Programme Guide (EPG) to help your navigation through all the possible viewing options.

The EPG supplies information such as programme listings, start and end times for all available services. In addition, detailed information about the programme is often available in the EPG (the availability and amount of these programme details will vary, depending on the particular broadcaster).

This function can be used only when the EPG information is broadcast by broadcasting companies

The EPG displays the programme details for next 8 days.

	Shows the present screen information.		Displayed with a Teletext Programme.
	Displayed with a DTV Programme.		Displayed with a Subtitle Programme.
	Displayed with a Radio Programme.		Displayed with a Scramble Programme.
	Displayed with a MHEG Programme.		Displayed with a Dolby Programme.
	Displayed with a AAC Programme.		Displayed with a Dolby Digital PLUS Programme.
	Aspect ratio of broadcasting programme.	480i/p, 576i/p, 720p, 1080i/p : Resolution of broadcasting programme	
	Aspect ratio of broadcasting programme.		

## Switch on/off EPG

1  Switch on or off EPG.

## Select a programme

1  or  Select desired programme.

2  Display the selected programme.

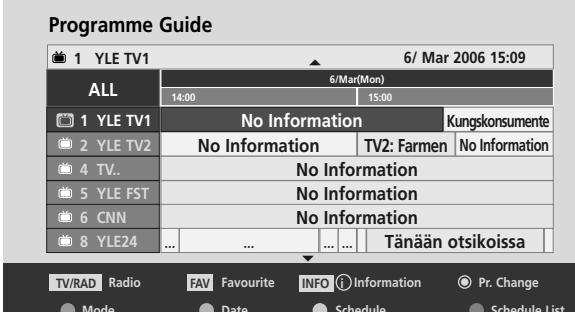

**Programme Guide**

1 YLE TV1 6/ Mar 2006 15:09

ALL	14:00	15:00
1 YLE TV1	No Information	Kungskonserterte
2 YLE TV2	No Information	TV2: Farmen No Information
4 TV..	No Information	
5 YLE FST	No Information	
6 CNN	No Information	
8 YLE24	...	Tänään otsikoissa

TV/RAD Radio FAV Favourite INFO Information Pr. Change  
 ● Mode ● Date ● Schedule ● Schedule List





# EPG (ELECTRONIC PROGRAMME GUIDE)

## Button Function in NOW/NEXT Guide Mode

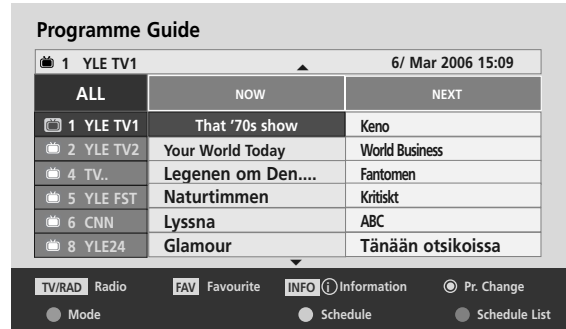







You can view a program being broadcasted and one scheduled to follow.

-  **RED** Change EPG mode.
-  **YELLOW** Enter Timer Record/Remind setting mode.
-  **BLUE** Enter Timer Record/Remind list mode.
-  **OK** Change to the selected programme.
-  Select NOW or NEXT Programme.
-  Select the Broadcast Programme.
-  Page Up/Down.





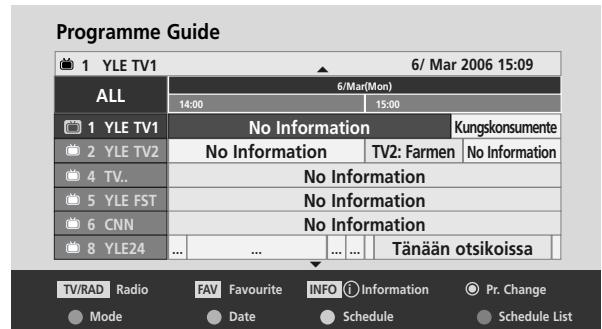

-  or  Switch off EPG.
-  Select TV or RADIO Programme.
-  Detail information on or off.

## Button Function in 8 Day Guide Mode

-  **RED** Change EPG mode.
-  **GREEN** Enter Date setting mode.
-  **YELLOW** Enter Timer Record/Remind setting mode.
-  **BLUE** Enter Timer Record/Remind list mode.
-  **OK** Change to the selected programme.
-  Select NOW or NEXT Programme.
-  Select the Broadcast Programme.
-  Page Up/Down.



-  or  Switch off EPG.
-  Select TV or RADIO Programme.
-  Detail information on or off



# EPG (ELECTRONIC PROGRAMME GUIDE)

## Button Function in Record/Remind Setting Mode

Sets a start or end time for recording, and sets a reminder only for a start time, with the end time grayed out.

- This function is available only when recording equipment that use pin8 recording signalling has been connected to the DTV-OUT(AV2) terminal, using a SCART cable.

**YELLOW** Change to Guide or Timer list mode.

**OK** Save Timer Record/Remind.

**Left/Right** Select Type, Programme, Date or Start/End time.

**Up/Down** Function setting.

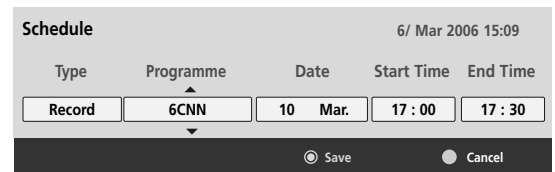

## Button Function in Schedule List Mode

If you've created a schedule list, a scheduled program is displayed at the scheduled time even when you are watching a different program at the time.

**YELLOW** Add new Manual Timer setting mode.

**GREEN** Enter **Schedule List** editing mode.

**RED** Delete the selected item.

**BLUE** Change to Guide mode.

**Up/Down** Select **Schedule List**.

Title	Time	Date	Programme
Battlestar Galactica	23:15	6/ Mar	DTV 06 BBC ONE
Criminal Minds	12:45	6/ Mar	DTV 11 Discovery
Grey's Anatomy 2	11:05	6/ Mar	DTV 20 Bloomberg
2007 Europe Football	15:08	6/ Mar	DTV 43 Cartoon...
Friends	13:30	6/ Mar	DTV 13 NBC
C.S.I. MIAMI	21:00	6/ Mar	DTV 42 ESPN



# PICTURE CONTROL





## PICTURE SIZE (ASPECT RATIO) CONTROL

You can watch the screen in various picture formats; 16:9, Just Scan, Original, 4:3, 14:9, Zoom, Cinema Zoom and Full Wide.

If a fixed image is displayed on the screen for a long time, that fixed image may become imprinted on the screen and remain visible.

You can adjust the enlarge proportion using  $\wedge \vee$  button.

This function works in the following signal.

-   Select **Aspect Ratio**.
-   Select the desired picture format.

- You can also adjust **Aspect Ratio** in the **PICTURE** menu.
- For Zoom Setting, select **14:9, Zoom and Cinema Zoom** in Ratio Menu. After completing Zoom Setting, the display goes back to Q.Menu.

### • 16:9

The following selection will allow you to adjust the picture horizontally, in linear proportion, to fill the entire screen (useful for viewing 4:3 formatted DVDs)



### • Just Scan

Following Selection will lead to you view the picture of best quality without loss of original picture in high resolution image.

Note : If there is noise in original Picture, You can see the noise at the edge.

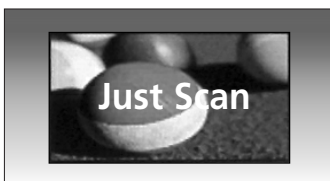

### • Original

When your TV receives a wide screen signal it will automatically change to the picture format broadcast.

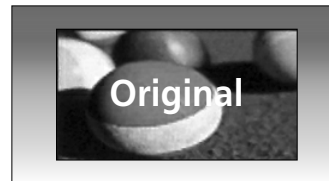

### • 4:3

The following selection will allow you to view a picture with an original 4:3 aspect ration, gray bars will appear on both the left and right of the screen.



# PICTURE CONTROL

## • 14:9

You can view a picture format of 14:9 or a general TV programme in the 14:9 mode. The 14:9 screen is viewed in the same way as in 4:3, but is magnified to the left and right.



## • Zoom

The following selection will allow you to view the picture without any alteration, while filling the entire screen. However, the top and bottom of the picture will be cropped.



## • Cinema Zoom

Choose Cinema Zoom when you wish the picture to be altered, both horizontally extended and vertically cropped. The picture adopting a compromise between alteration and screen coverage.

The adjustment range is 1-16.



## • Full Wide

When TV receives the wide screen signal, it will lead you to adjust the picture horizontally or vertically, in a linear proportion, to fill the entire screen fully.



## ! NOTE

- ▶ You can only select **4:3**, **16:9 (Wide)**, **14:9**, **Zoom**, **Cinema Zoom** in Component (under 720p), HDMI mode.
- ▶ You can only select **4:3**, **16:9 (Wide)** in RGB/HDMI[PC] mode only.
- ▶ In DTV/HDMI/Component (over 720p) mode, **Just Scan** is available.

# e ENERGY SAVING / POWER SAVING

It reduces the plasma display's power consumption.

The default factory setting complies with the Energy Star requirements and is adjusted to the comfortable level to be viewed at home.

You can increase the brightness of your screen by adjusting the Energy Saving level or by setting the Picture Mode.





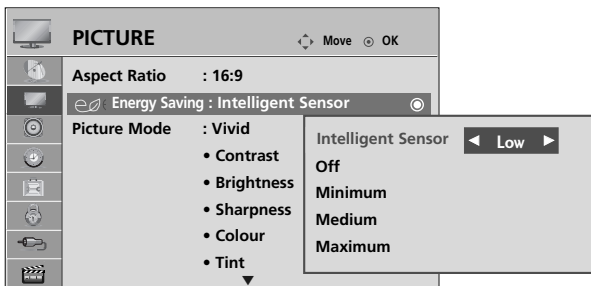

In **Picture Mode - Cinema**, You cannot adjust **Energy Saving** or **Power Saving**.

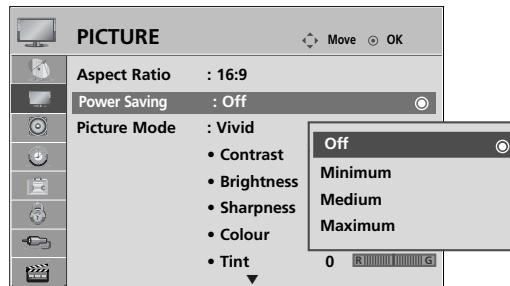
Only 42/50PQ20\*\*, 42/50PQ30\*\*,  
42/50PQ60\*\*, 50PS20\*\*, 50PS30\*\*,  
50PS60\*\*, 60PS40\*\*



Only 42/50PQ10\*\*, 42/50PQ11\*\*



- 1   Select **PICTURE**.
- 2   Select **e Energy Saving** or **Power Saving**.
- 3   Select **Intelligent Sensor**(Except for 42/50PQ10\*\* 42/50PQ11\*\*), **Off**, **Minimum**, **Medium** or **Maximum**.

(Except for 42/50PQ10\*\* 42/50PQ11\*\*)

- When the Intelligent sensor function is on, the most suitable picture is automatically adjusted according to the surrounding conditions.
- **Intelligent Sensor** : Adjusts picture according to the surrounding conditions.

When the **Intelligent Sensor** is selected,(Except for 42/50PQ10\*\* 42/50PQ11\*\*)

- 4   Select **Low**, **Middle** or **High**.

- Press the **MENU** button to return to normal TV viewing.
- Press the **RETURN** button to move to the previous menu screen.





# PICTURE CONTROL

## PRESET PICTURE SETTINGS

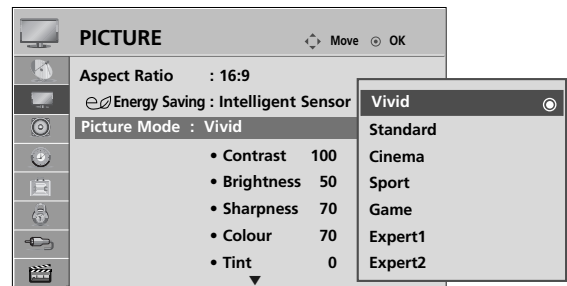
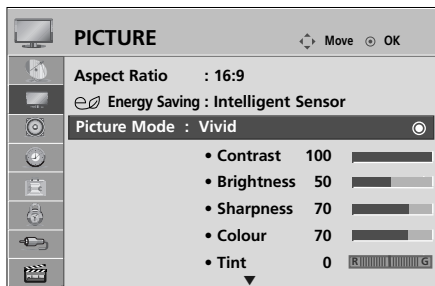
### Picture Mode-Preset

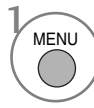
- Vivid** Enhances contrast, colour and resolution.
- Standard** Displays the standard-quality screen.
- Cinema** Optimizes video for watching movies.
- Sport** Optimizes video for watching sports events.
- Game** Optimizes video for playing games.

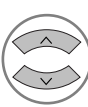

-   Select **PICTURE**.
-   Select **Picture Mode**.
-   Select **Vivid, Standard, Cinema, Sport or Game**.

- **Picture Mode** adjusts the TV for the best picture appearance. Select the preset value in the **Picture Mode** menu based on the programme category.
- You can also adjust **Picture Mode** in the **Q. Menu**.

- Press the **MENU** button to return to normal TV viewing.
- Press the **RETURN** button to move to the previous menu screen.

# MANUAL PICTURE ADJUSTMENT

## Picture Mode-User option

- **Contrast**  
Adjusts the difference between light and dark levels in the picture.
- **Brightness**  
Increases or decreases the amount of white in the picture.
- **Sharpness**  
Adjusts the level of crispness in the edges between the light and dark areas of the picture.  
The lower the level, the softer the image.
- **Colour**  
Adjusts intensity of all colours.
- **Tint**  
Adjusts the balance between red and green levels.

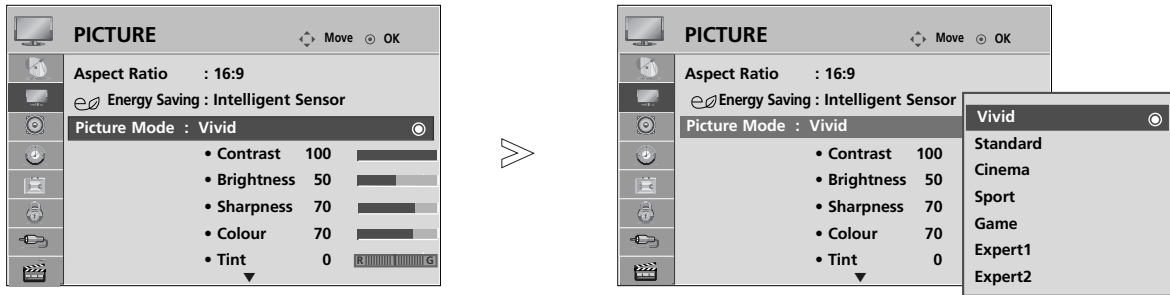

- 1 Select **PICTURE**.
- 2 Select **Picture Mode**.
- 3 Select **Vivid, Standard, Cinema, Sport or Game**.
- 4 Select **Contrast, Brightness, Sharpness, Colour or Tint**.
- 5 Make appropriate adjustments.

- Press the **MENU** button to return to normal TV viewing.
- Press the **RETURN** button to move to the previous menu screen.

### ! NOTE

- ▶ You cannot adjust colour, sharpness and tint in the RGB/HDMI[PC] mode.
- ▶ When the **Expert 1/2** is selected, you can select **Contrast, Brightness, H Sharpness, V Sharpness, Colour or Tint**.

# PICTURE CONTROL

## PICTURE IMPROVEMENT TECHNOLOGY

You can calibrate the screen for each Picture Mode or set the video value according to the special video screen.

You can set the video value differently for each input.

To reset to the factory default screen after making adjustment to each video mode, execute the "Picture Reset" function for each Picture Mode.

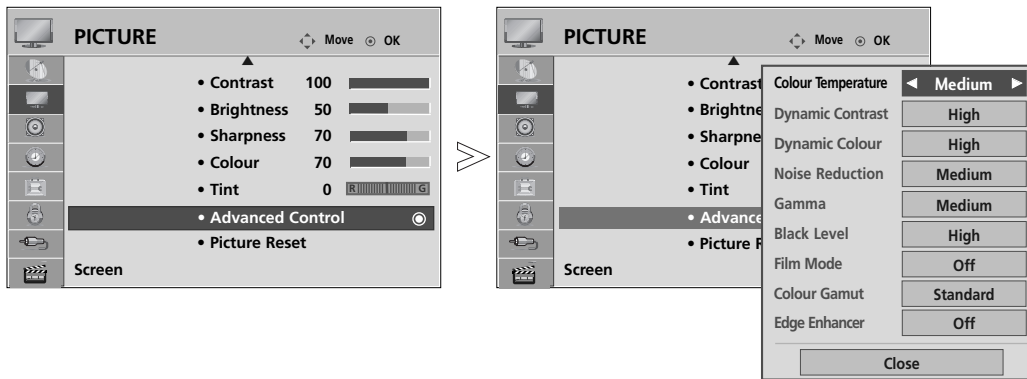

1   Select **PICTURE**.

2   Select **Advanced Control**.

3   Select your desired Source. : **Colour Temperature, Dynamic Contrast, Dynamic Colour, Noise Reduction, Gamma, Black Level, Film Mode, Colour Gamut or Edge Enhancer.**

4  Make appropriate adjustments.

- Press the **MENU** button to return to normal TV viewing.
- Press the **RETURN** button to move to the previous menu screen.

<p><b>Colour Temperature</b> (Cool/Medium/Warm)</p>	<ul style="list-style-type: none"> <li>▪ Choose one of three automatic colour adjustments. Set to warm to enhance hotter colours such as red, or set to cool to see less intense colours with more blue.</li> </ul>
<p><b>Dynamic Contrast</b> (Off/Low/High)</p>	<ul style="list-style-type: none"> <li>▪ Adjusts the contrast to keep it at the best level according to the brightness of the screen. The resolution of gradation is improved by making bright parts brighter and dark parts darker. This feature refers to dynamic contrast, and enhances the feeling of presence that contrast controls are intended to give by using dimming and other input signals.</li> </ul>
<p><b>Dynamic Colour</b> (Off/Low/High)</p>	<ul style="list-style-type: none"> <li>▪ Adjusts screen colours so that they look livelier, richer and clearer. This feature enhances hue, saturation and luminance so that red, blue, green and white look more vivid.</li> </ul>
<p><b>Noise Reduction</b> (Off/Low/Medium/High)</p>	<ul style="list-style-type: none"> <li>▪ Reduces screen noise without compromising video quality. This feature is also used to reduce recursive noise and MPEG noise (Mosquito/Block).</li> </ul>
<p><b>Gamma</b> (Low/Medium/High)</p>	<ul style="list-style-type: none"> <li>▪ You can adjust brightness of dark area and middle gray level area of the picture.             <ul style="list-style-type: none"> <li>• Low : Make dark and middle gray level area of the picture brighter.</li> <li>• Medium: Express original picture gradation.</li> <li>• High: Make dark and middle gray level area of the picture darken.</li> </ul> </li> </ul>
<p><b>Black Level</b> (Low/High)</p>	<ul style="list-style-type: none"> <li>• Low :The picture of the screen gets darker.</li> <li>• High: The picture of the screen gets brighter.</li> <li>• Auto : Realizing the black level of the screen and set it to High or Low automatically.</li> <li>▪ Makes dark parts on the screen look darker.</li> </ul> <p>Set black level of the screen to proper level. This function works in the following mode: AV (NTSC-M), HDMI or Component . This function enables to select “Low” or “High” in the following mode : AV(NTSC-M), HDMI or Component. Otherwise, “Black level” is set to “Auto”.</p>
<p><b>Film Mode</b> (On/Off)</p>	<ul style="list-style-type: none"> <li>▪ Makes video clips recorded in film look more natural. This feature operates only in TV, AV and Component 480i/576i/1080i mode.</li> </ul>
<p><b>Colour Gamut</b> (Wide/Standard)</p>	<ul style="list-style-type: none"> <li>▪ Change the colour gamut of the output image.             <ul style="list-style-type: none"> <li>• Wide: Express rich colour tones using the maximum colour gamut available in the TV regardless of the input image.</li> <li>• Standard: Express accurate colour tones by changing the colour gamut to meet international standards based on the input image data (resolution/format).</li> </ul> </li> </ul>
<p><b>Edge Enhancer</b> (Off/On)</p>	<ul style="list-style-type: none"> <li>▪ Show clearer and distinctive yet natural corners of the video. Emphasizes the frames of the video without over peaking.</li> </ul>









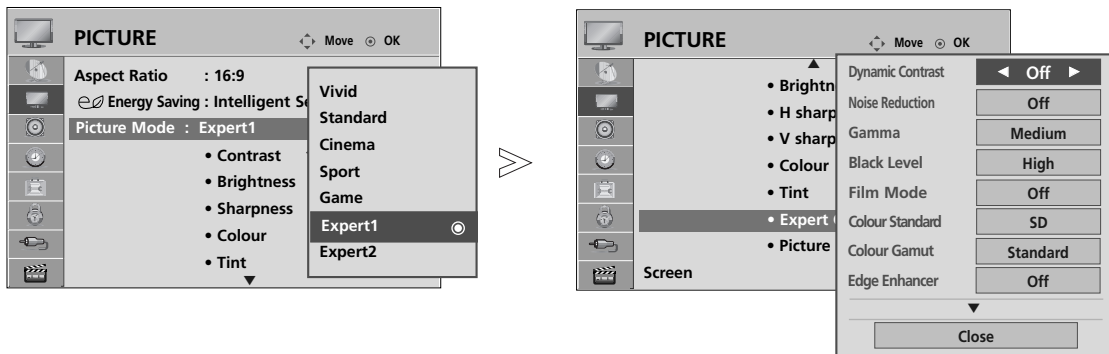

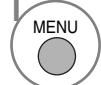

# PICTURE CONTROL

## Expert Picture Control

By segmenting categories, Expert1 and Expert2 provide more categories which users can set as they see fit, offering the optimal picture quality for users.

As the detail item for video quality experts to fine tune the video using specific videos, this may not be effective for general videos.



- 1   Select **PICTURE**.
- 2   Select **Picture Mode**.
- 3   Select **Expert1** or **Expert2**.
- 4   Select **Expert Control**.
- 5   Select your desired Source.
- 6   Make appropriate adjustments.

- Press the **MENU** button to return to normal TV viewing.
- Press the **RETURN** button to move to the previous menu screen.



<p><b>Dynamic Contrast</b> (Off/Low/High)</p>	<ul style="list-style-type: none"> <li>■ Adjusts the contrast to keep it at the best level according to the brightness of the screen. The resolution of gradation is improved by making bright parts brighter and dark parts darker. This feature refers to dynamic contrast, and enhances the feeling of presence that contrast controls are intended to give by using dimming and other input signals.</li> </ul>
<p><b>Noise Reduction</b> (Off/Low/Medium/High)</p>	<ul style="list-style-type: none"> <li>■ Reduces screen noise without compromising video quality. This feature is also used to reduce recursive noise and MPEG noise (Mosquito/Block).</li> </ul>
<p><b>Gamma</b> (Low/Medium/High)</p>	<ul style="list-style-type: none"> <li>■ You can adjust brightness of dark area and middle gray level area of the picture. <ul style="list-style-type: none"> <li>• Low : Make dark and middle gray level area of the picture brighter.</li> <li>• Medium: Express original picture gradation.</li> <li>• High: Make dark and middle gray level area of the picture darken.</li> </ul> </li> </ul>
<p><b>Black Level</b> (Low/High)</p>	<ul style="list-style-type: none"> <li>• Low :The picture of the screen gets darker.</li> <li>• High: The picture of the screen gets brighter.</li> <li>• Auto : Realizing the black level of the screen and set it to High or Low automatically.</li> <li>■ Makes dark parts on the screen look darker.</li> </ul> <p>Set black level of the screen to proper level. This function works in the following mode: AV (NTSC-M), HDMI or Component . This function enables to select “Low” or “High” in the following mode : AV(NTSC-M), HDMI or Component. Otherwise, “Black level” is set to “Auto”.</p>
<p><b>Film Mode</b> (On/Off)</p>	<ul style="list-style-type: none"> <li>■ Makes video clips recorded in film look more natural. This feature operates only in TV, AV and Component 480i/576i/1080i mode.</li> </ul>
<p><b>Colour Standard</b> (SD/HD)</p>	<ul style="list-style-type: none"> <li>■ Select the international standard for the colour gamut that will be applied when the colour gamut is set to Standard.</li> <li>• SD: Increase colour accuracy by adjusting the output image to meet the EBU (European Broadcasting Union) Colour Coordinate Standard.</li> <li>• HD: Increase colour accuracy by adjusting the output image to meet ITU.BT-709 (High Definition Signal International Colour Coordinate Standard).</li> </ul>
<p><b>Colour Gamut</b> (Wide/Standard)</p>	<ul style="list-style-type: none"> <li>■ Change the colour gamut of the output image. <ul style="list-style-type: none"> <li>• Wide: Express rich colour tones using the maximum colour gamut available in the TV regardless of the input image.</li> <li>• Standard: Express accurate colour tones by changing the colour gamut to meet international standards based on the input image data (resolution/format).</li> </ul> </li> </ul>
<p><b>Edge Enhancer</b> (Off/On)</p>	<ul style="list-style-type: none"> <li>■ Show clearer and distinctive yet natural corners of the video. Emphasizes the frames of the video without over peaking.</li> </ul>





# PICTURE CONTROL

<b>White Balance (Medium/Warm/Cool)</b>	<ul style="list-style-type: none"><li>■ White Balance (Medium/Warm/Cool)<ul style="list-style-type: none"><li>• Adjust white balance.</li></ul></li><li>■ Pattern (Inner/Outer)<ul style="list-style-type: none"><li>• Decide whether to use the Internal Pattern or External Pattern when adjusting white balance.</li></ul></li><li>■ Red Gain/Green Gain/Blue Gain<ul style="list-style-type: none"><li>• Adjust high-level white balance.</li></ul></li><li>■ Red Offset/Green Offset/Blue Offset<ul style="list-style-type: none"><li>• Adjust low-level white balance.</li></ul></li></ul>
<b>Colour Management System</b>	<ul style="list-style-type: none"><li>■ Colour (Red/Green/Blue/Yellow/Cyan/Magenta)<ul style="list-style-type: none"><li>• Adjust colour saturation by area.</li></ul></li><li>■ Tint (Red/Green/Blue/Yellow/Cyan/Magenta)<ul style="list-style-type: none"><li>• Adjust colour tint by area.</li></ul></li></ul>

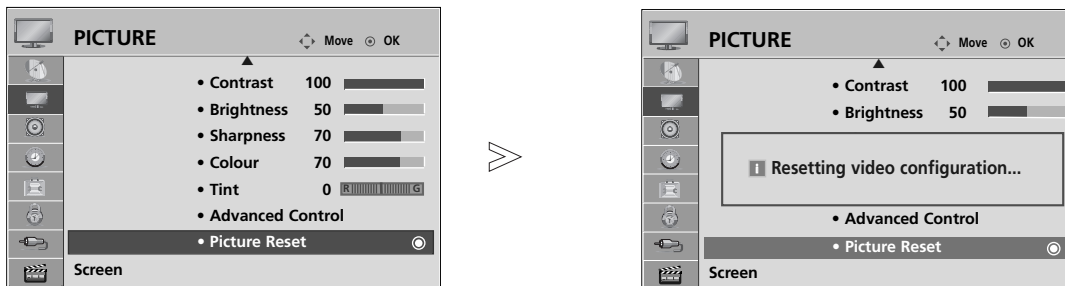
# PICTURE RESET

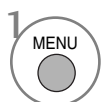
Settings of the selected picture modes return to the default factory settings.

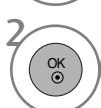

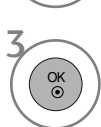
-   Select **PICTURE**.
-   Select **Picture Reset**.
-  Initialize the adjusted value.

- Press the **MENU** button to return to normal TV viewing.
- Press the **RETURN** button to move to the previous menu screen.

# PICTURE CONTROL

## IMAGE STICKING MINIMIZATION (ISM) METHOD

A frozen or still picture displayed on the screen for prolonged periods will result in a ghost image remaining even when you change the image. Avoid allowing a fixed image to remain on the screen for prolonged periods.

### Orbiter

Orbiter may help prevent ghost images. However, it is best not to allow any fixed image to remain on the screen. To avoid a permanent image on the screen, the screen will move every 2 minutes.

### Colour Wash

The colour block with the screen moved a little and the white pattern are alternately displayed. It is difficult to sense the afterimage occurred while the temporary afterimage is removed and the colour pattern is operating.

### White Wash

White wash removes permanent images from the screen.

Note: An excessive permanent image may be impossible to clear entirely with White Wash.

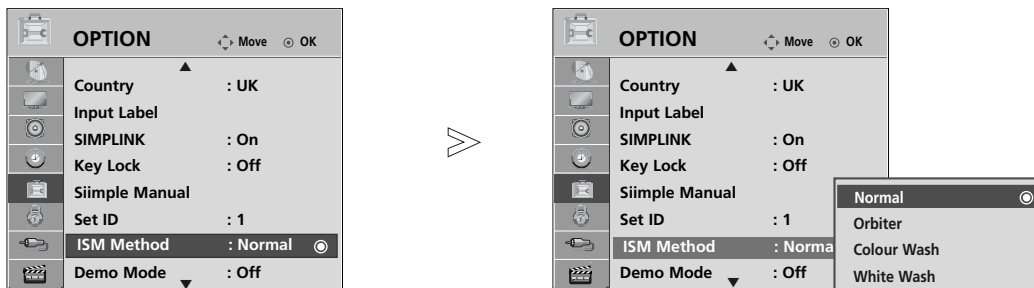

1 MENU Select **OPTION**.

2 OK Select **ISM Method**.

3 OK Select **Normal, Orbiter, Colour Wash or White Wash**.

4 OK Save.





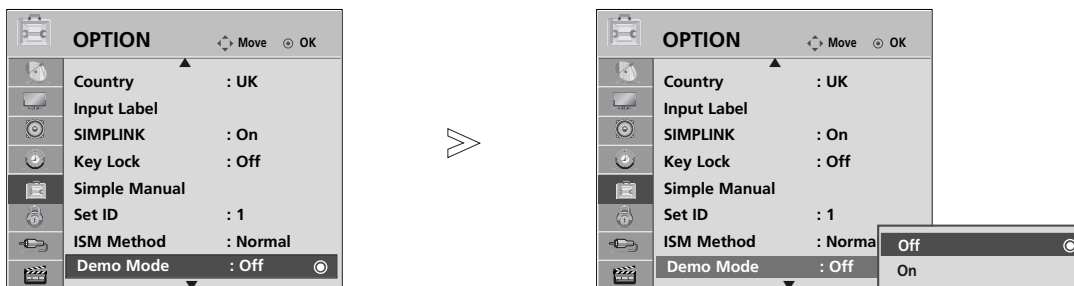

• If you do not need this function, set **Normal**.

- Press the **MENU** button to return to normal TV viewing.
- Press the **RETURN** button to move to the previous menu screen.

# DEMO MODE

Use it to see the difference between XD Demo on and XD Demo off.



- 1   Select **OPTION**.
- 2   Select **Demo Mode**.
- 3   Select **On** or **Off**.  
To stop the **Demo Mode**, press any button.





- Press the **MENU** button to return to normal TV viewing.
- Press the **RETURN** button to move to the previous menu screen.

# PICTURE CONTROL

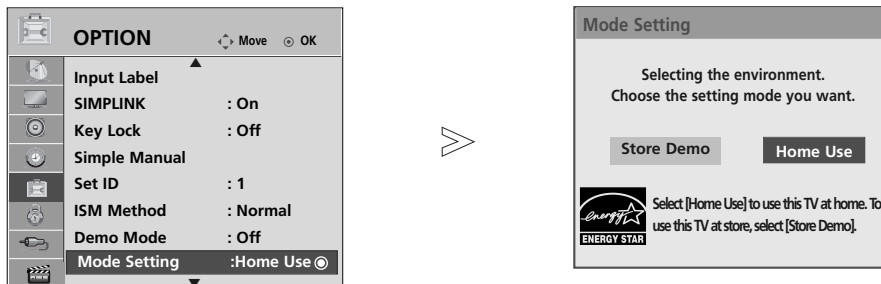
## MODE SETTING

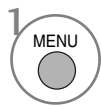
We recommend setting the TV to “Home Use” mode for the best picture in your home environment. “Store Demo” mode is an optimal setting for displaying at stores.

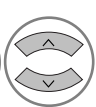
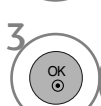

-   Select **OPTION**.
-   Select **Mode Setting**.
-   Select **Store Demo** or **Home Use**.
-  Save.

- Press the **MENU** button to return to normal TV viewing.
- Press the **RETURN** button to move to the previous menu screen.





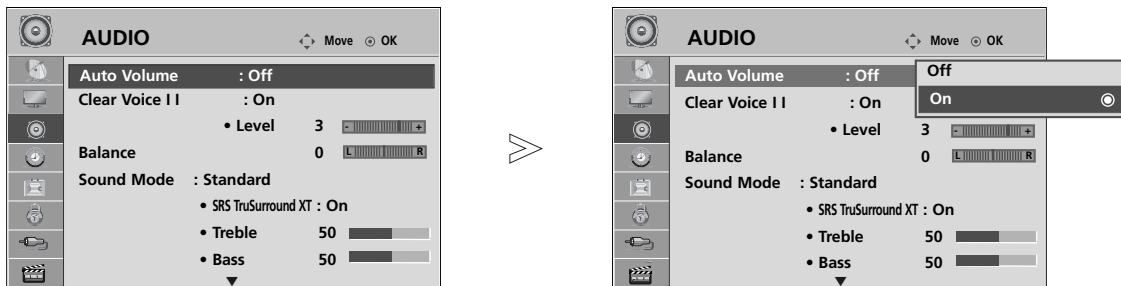

# SOUND & LANGUAGE CONTROL

## AUTO VOLUME LEVELER

AVL automatically remains on the same level of volume if you change programmes.

Because each broadcasting station has its own signal conditions, volume adjustment may be needed every time the channel is changed. This feature allows users to enjoy stable volume levels by making automatic adjustments for each programme.



- 1   Select **AUDIO**.
- 2   Select **Auto Volume**.
- 3   Select **On** or **Off**.

- Press the **MENU** button to return to normal TV viewing.
- Press the **RETURN** button to move to the previous menu screen.

# SOUND & LANGUAGE CONTROL

## PRESET SOUND SETTINGS-SOUND MODE

You can select your preferred sound setting; Standard, Music, Cinema, Sport or Game and you can also adjust Treble, Bass.

Sound Mode lets you enjoy the best sound without any Special adjustment as the TV sets the appropriate sound options based on the programme content.

Standard, Music, Cinema, Sport and Game are preset for optimum sound quality at the factory.

- Standard** Offers standard-quality sound.
- Music** Optimizes sound for listening to music.
- Cinema** Optimizes sound for watching movies.
- Sport** Optimizes sound for watching sports events.
- Game** Optimizes sound for playing games.

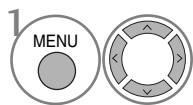
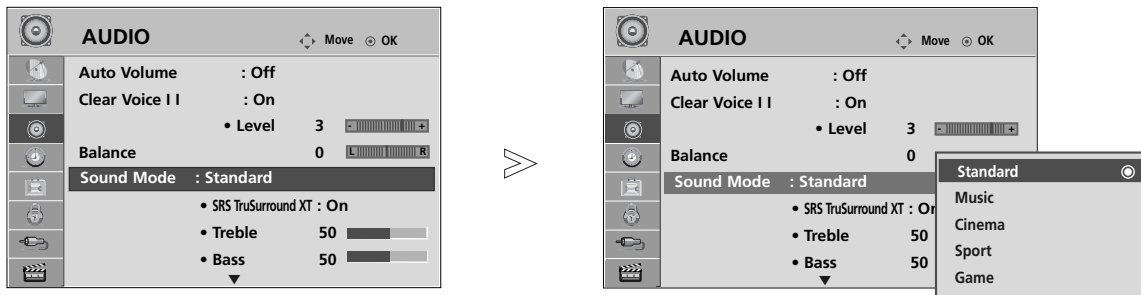

Select **AUDIO**.

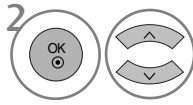

Select **Sound Mode**.

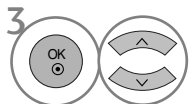

Select **Standard, Music, Cinema, Sport or Game**.

- You can also adjust **Sound Mode** in the **Q. Menu**.

- Press the **MENU** button to return to normal TV viewing.
- Press the **RETURN** button to move to the previous menu screen.



# SOUND SETTING ADJUSTMENT -USER MODE

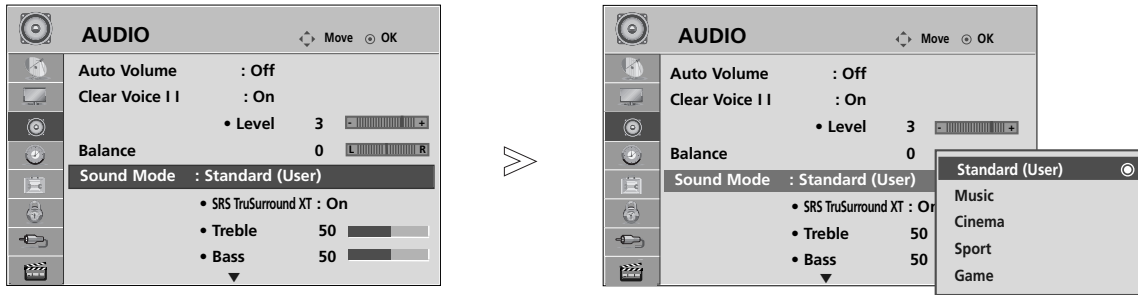

1 Select **AUDIO**.

2 Select **Sound Mode**.

3 Select **Standard, Music, Cinema, Sport or Game**.

4 Select **Treble, Bass**.

5 Set the desired sound level.

- Press the **MENU** button to return to normal TV viewing.
- Press the **RETURN** button to move to the previous menu screen.

## SRS TRUSURROUND XT

Select this option to sound realistic.

1 Select **AUDIO**.

2 Select **SRS TruSurround XT**.

3 Select **On or Off**.

• **SRS TruSurround XT** : TruSurround XT is a patented SRS technology that solves the problem of playing 5.1 multichannel content over two speakers.

- Press the **MENU** button to return to normal TV viewing.
- Press the **RETURN** button to move to the previous menu screen.

▶ is a trademark of SRS Labs, Inc.  
 ▶ TruSurround XT technology is incorporated under license from SRS Labs, Inc.

# SOUND & LANGUAGE CONTROL

## CLEAR VOICE II

By differentiating the human sound range from others, it helps users listen to human voices better.

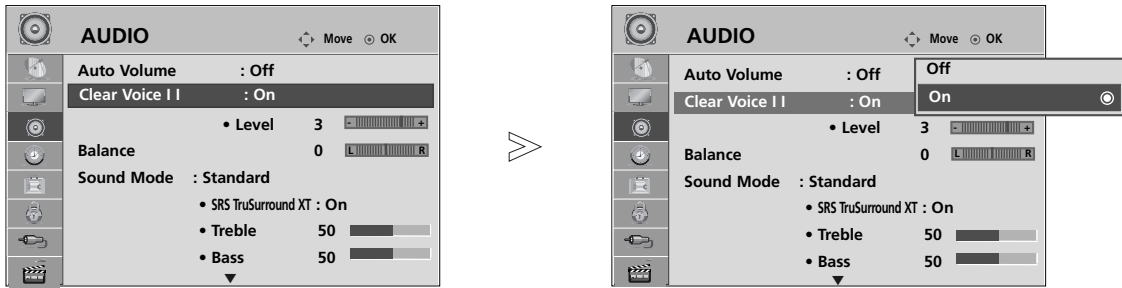

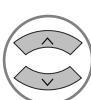
- 1   Select **AUDIO**.
- 2   Select **Clear Voice II**.
- 3   Select **On** or **Off**.

When the **Clear Voice II** is selected **On**,

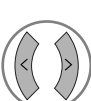
- 4   Select the desired **Level**.

• Select levels from '-6' to '+6'.

- Press the **MENU** button to return to normal TV viewing.
- Press the **RETURN** button to move to the previous menu screen.

## BALANCE

You can adjust the sound balance of the speakers to preferred levels.

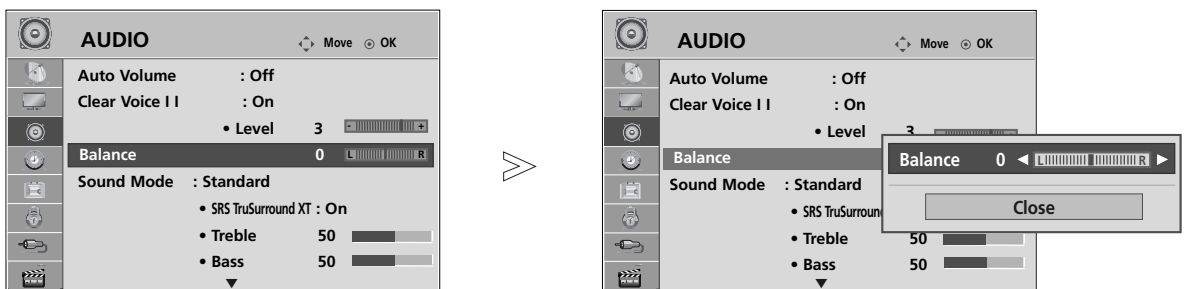

- 1   Select **AUDIO**.
- 2   Select **Balance**.
- 3   Make desired adjustment.

- Press the **MENU** button to return to normal TV viewing.
- Press the **RETURN** button to move to the previous menu screen.





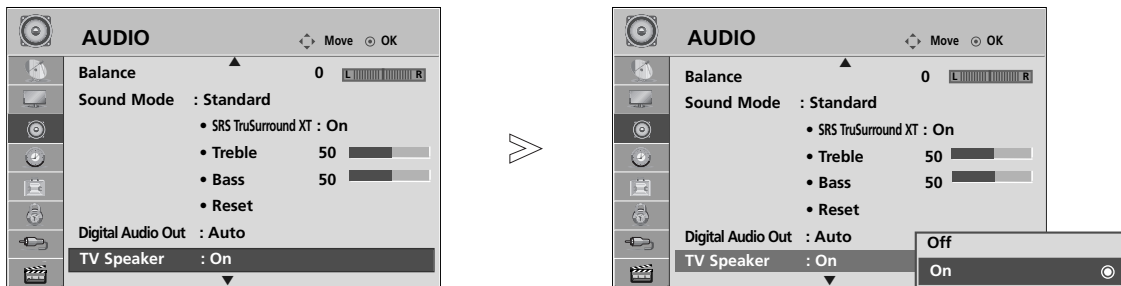

# TV SPEAKERS ON/ OFF SETUP

You can adjust the TV internal speaker status.

In **AV1**, **AV2**, **AV3** (Except for 42/50PQ10\*\*, 42/50PQ11\*\*), **COMPONENT** (Except for 42/50PQ10\*\*, 42/50PQ11\*\*), **RGB** (Except for 42/50PQ10\*\*, 42/50PQ11\*\*) and **HDMI1** with HDMI to DVI cable, the TV speaker can be operational even when there is no video signal.

If you wish to use an external Hi-Fi system, turn off the TV internal speakers.



-   Select **AUDIO**.
-   Select **TV Speaker**.
-   Select **On** or **Off**.

## NOTE

- ▶ When the TV speaker is turned off while the Simplink home theater is operating, the sound output automatically switches to the Home theater speaker, but when the TV speaker is turned on, the sound output the TV speaker.

- Press the **MENU** button to return to normal TV viewing.
- Press the **RETURN** button to move to the previous menu screen.

# SOUND & LANGUAGE CONTROL

## SELECTING DIGITAL AUDIO OUT

This function allows you to select your preferred Digital Audio Output.

The TV can only output DOLBY Digital if a channel is broadcast with Dolby Digital audio.





When Dolby digital is available, selecting Auto in the Digital Audio Out menu will set SPDIF(Sony Philips Digital InterFace) output to Dolby Digital.

If Auto is selected in the digital audio out menu when dolby digital is not available, SPDIF output will be PCM(Pulse-code modulation).

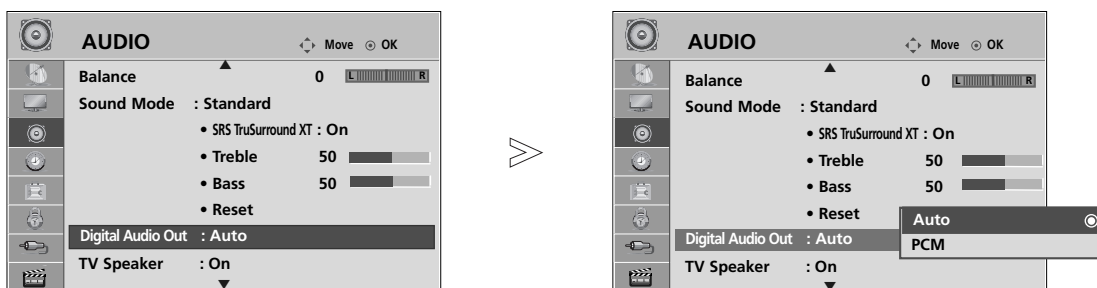
Even if both Auto and Audio language have been set in a channel which broadcast Dolby Digital Audio, only Dolby Digital will be played.

If the sample rate converter on this chip does not support 44.1 to 48kHz, this content should always produce stereo PCM at digital output.

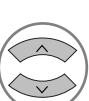

- 1   Select **AUDIO**.
- 2   Select **Digital Audio Out**.
- 3   Select **Auto** or **PCM**.



Manufactured under license from Dolby Laboratories. "Dolby" and the double-D symbol are trademarks of Dolby Laboratories.





- There is a possibility that when HDMI mode, some DVD players do not make SPDIF sound. At that time, set the output of the digital audio of the DVD player to PCM.(In HDMI, DOLBY DIGITAL PLUS is not supported)

- Press the **MENU** button to return to normal TV viewing.
- Press the **RETURN** button to move to the previous menu screen.

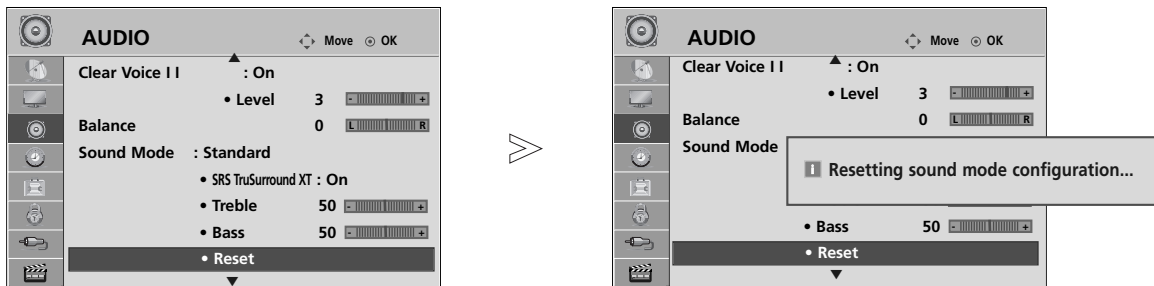
# AUDIO RESET

Settings of the selected Sound Mode return to the default factory settings.



- 1   Select **AUDIO**.
- 2   Select **Reset**.
- 3  Initialize the adjusted value.

- Press the **MENU** button to return to normal TV viewing.
- Press the **RETURN** button to move to the previous menu screen.

# SOUND & LANGUAGE CONTROL

## AUDIO DESCRIPTION (IN DIGITAL MODE ONLY)

This function is for the blind, and provides explanatory audio describing the current situation in a TV programme in addition to the basic audio.

When Audio Description On is selected, basic audio and Audio Description are provided only for those programmes that have Audio Description included.

When Main Audio is AAC or Dolby Digital Plus Audio, Audio Description is not supported.

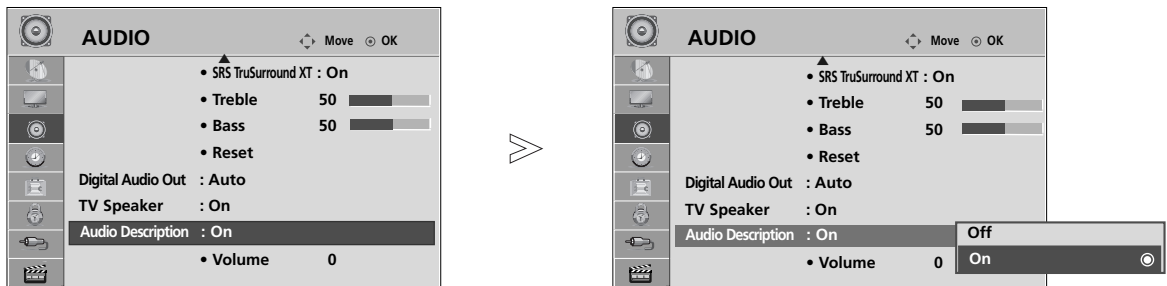



1   Select **AUDIO**.

2   Select **Audio Description**.

3   Select **On** or **Off**.

When the **Audio Description** is selected **On**,

4   Select the desired **Volume**.

- Press the **MENU** button to return to normal TV viewing.
- Press the **RETURN** button to move to the previous menu screen.

## Stereo/Dual Reception (In Analogue Mode Only)

When a programme is selected, the sound information for the station appears with the programme number and station name.

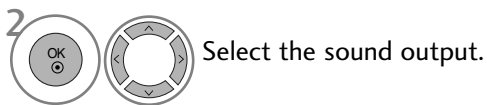

Broadcast	On Screen Display
Mono	MONO
Stereo	STEREO
Dual	DUAL I, DUAL II, DUAL I+II

### ■ Mono sound selection

If the stereo signal is weak in stereo reception, you can switch to mono. In mono reception, the clarity of sound is improved.

### ■ Language selection for dual language broadcast

If a programme can be received in two languages (dual language), you can switch to DUAL I, DUAL II or DUAL I+II.

- DUAL I Sends the primary broadcast language to the loudspeakers.
- DUAL II Sends the secondary broadcast language to the loudspeakers.
- DUAL I+II Sends a separate language to each loudspeaker.

# SOUND & LANGUAGE CONTROL

## NICAM Reception (In Analogue Mode Only)

If the TV is equipped with a receiver for NICAM reception, high quality NICAM (Near Instantaneous Companding Audio Multiplex) digital sound can be received.

Sound output can be selected according to the type of broadcast received.

- 
- 1 When **NICAM mono** is received, you can select **NICAM MONO** or **FM MONO**.
  - 2 When **NICAM stereo** is received, you can select **NICAM STEREO** or **FM MONO**.  
If the stereo signal is weak, switch to **FM MONO**.
  - 3 When **NICAM dual** is received, you can select **NICAM DUAL I**, **NICAM DUAL II** or **NICAM DUAL I+II** or **FM MONO**.
- 

## Speaker Sound Output Selection

In AV, Component, RGB and HDMI mode, you can select output sound for the left and right loudspeakers.

Select the sound output.

**L+R:** Audio signal from audio L input is sent to the left loudspeaker and audio signal from audio R input is sent to the right loudspeaker.

**L+L:** Audio signal from audio L input is sent to left and right loudspeakers.

**R+R:** Audio signal from audio R input is sent to left and right loudspeakers.



# ON-SCREEN MENU LANGUAGE / COUNTRY SELECTION

The installation guide menu appears on the TV screen when it is switched on for the first time.

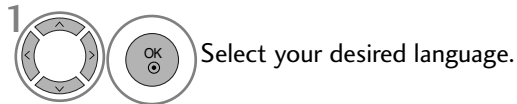

\* If you want to change Language/ Country selection

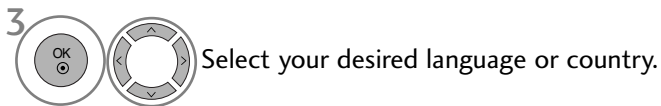

- Press the **MENU** button to return to normal TV viewing.
- Press the **RETURN** button to move to the previous menu screen.

## ! NOTE

- ▶ If you do not finish the set-up **Installation Guide** by pressing **RETURN** or if you time out on the OSD (On Screen Display) the installation menu will continuously appear until the set up is completed whenever the TV is switched on
- ▶ If you select the wrong local country, teletext may not appear correctly on the screen and some problems may occur during teletext operation.
- ▶ The CI (Common Interface) function may not be applied based on country broadcasting circumstances.
- ▶ DTV mode control buttons may not function based on country broadcasting circumstances.
- ▶ In country that Digital broadcasting regulation isn't fixed, some DTV function may not work depending on digital broadcasting circumstances.
- ▶ The Country Setting "UK" should only be activated in UK.
- ▶ If the country setting is set to "--", European terrestrial digital standard broadcasting programmes are available, but some DTV functions may not work properly.

# SOUND & LANGUAGE CONTROL

## LANGUAGE SELECTION (IN DIGITAL MODE ONLY)

The Audio function allows selection of a preferred language.

If audio data in a selected language is not broadcast, the default language audio will be played.

Use the Subtitle function when two or more subtitle languages are broadcast. If subtitle data in a selected language is not broadcast, the default language subtitle will be displayed.

When the languages you selected as the primary for Audio Language and Subtitle Language are not supported, you can select language in secondary category.

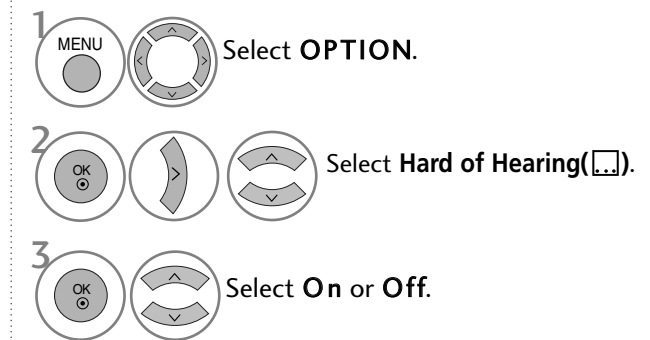
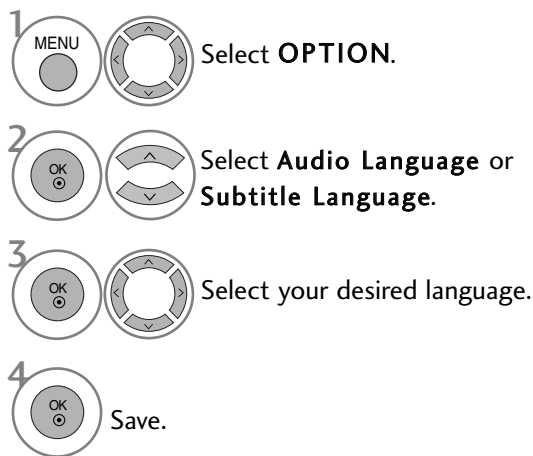

• Press the **RETURN** button to move to the previous menu screen.

### < Audio Language Selection >

- ▶ When two or more audio languages are broadcast, you can select the audio language.
- ▶ When AAC, Dolby Digital or Dolby Digital PLUS received, you cannot select the L+R, L+L or R+R.

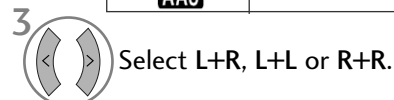
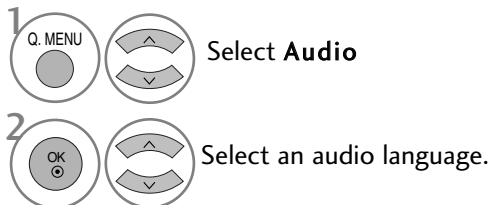

### Audio Language OSD Information

Display	Status
N.A	Not Available
	MPEG Audio
	Dolby Digital Audio
	Audio for "Visual Impaired"
	Audio for "Hearing Impaired"
	Dolby Digital Plus Audio
	AAC Audio

### < Subtitle Language Selection >

- ▶ When two or more subtitle languages are broadcast, you can select the subtitle language with the **SUBTITLE** button on the remote control.
- ▶ Press the  $\wedge \vee$  button to select a subtitle language.

### Subtitle Language OSD Information

Display	Status
N.A	Not Available
	Teletext Subtitle
	Subtitle for "Hard of Hearing"

- The audio/subtitles can be displayed in a simpler form with 1 to 3 characters broadcast by the service provider.
- When you select supplementary Audio (Audio for "Visual/Hearing Impaired") the TV may output a part of the Main audio.

# TIME SETTING

## CLOCK SETUP







The clock is set automatically when receiving a digital signal. (You can set the clock manually only if the TV has no DTV signal.)

You must set the time correctly before using on/off timer function.

When you select a Time Zone city, the TV time is set by the time offset information based on Time Zone and GMT (Greenwich Mean Time) which is received with the broadcast signal and the time is set automatically by a digital signal.

Once Clock is set in DTV mode, you cannot change time, but if the city name in Time Zone is changed into off-set, you can change time by 1 hour.



-   Select **TIME**.
-   Select **Clock**.
-   Select either the year, date, time or Time Zone option.
-  Set the year, date, time and Time Zone options.

- Press the **MENU** button to return to normal TV viewing.
- Press the **RETURN** button to move to the previous menu screen.

# TIME SETTING

## AUTO ON/OFF TIMER SETTING

The Off time function automatically switches the TV to standby at a preset time.

Two hours after the TV is switched on by the on time function it will automatically switch back to standby mode unless a button has been pressed.

The Off time function overrides the On timer function if both are set to the same time.

The TV must be in standby mode for the On timer to work.

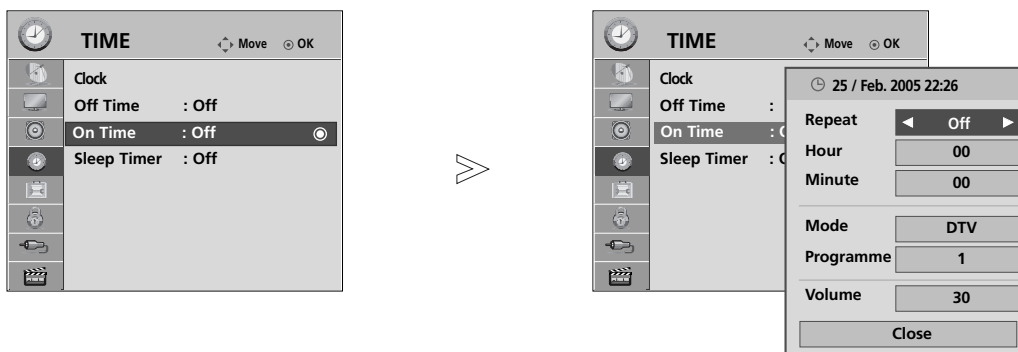

- 1 Select **TIME**.
  - 2 Select **Off Time** or **On Time**.
- When the **On Time** is selected,
- 3 Select **Repeat**.
  - 4 Select **Off, Once, Daily, Mon ~ Fri, Mon ~ Sat, Sat ~ Sun** or **Sun**.
  - 5 Set the hour.
  - 6 Set the minutes.

- To cancel **On/Off Time** function, select **Off**.
- For **On Time** function only



- 1 Select **Mode**.
- 2 Select **TV, DTV, Radio, AV1, AV2, AV3**(Except for 42/50PQ10\*\*, 42/50PQ11\*\*), **Component**(Except for 42/50PQ10\*\*, 42/50PQ11\*\*), **RGB**(Except for 42/50PQ10\*\*, 42/50PQ11\*\*), **HDMI1, HDMI2**(Except for 42/50PQ10\*\*, 42/50PQ11\*\*) or **HDMI3**(Except for 42/50PQ10\*\*, 42/50PQ11\*\*).
- 3 Set the programme.
- 4 Adjust volume level at switch-on.

- Press the **MENU** button to return to normal TV viewing.
- Press the **RETURN** button to move to the previous menu screen.

# SLEEP TIMER SETTING

You do not have to remember to switch the TV off before you go to sleep.  
The sleep timer automatically switches the TV to standby after the preset time has elapsed.

1   Select **Sleep Timer**.

2   Select **Off, 10, 20, 30, 60, 90, 120, 180 or 240 Min.**

- When you switch the TV off, the preset sleep timer is cancelled.
- You can also adjust **Sleep Timer** in the **TIME** menu.









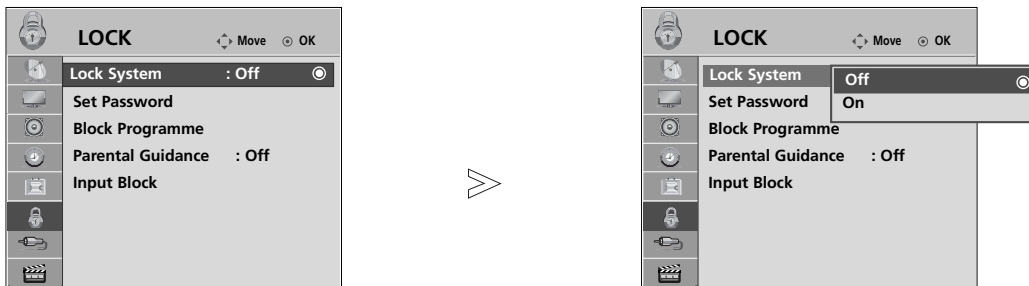

# PARENTAL CONTROL / RATINGS

## SET PASSWORD & LOCK SYSTEM

Enter the password, press '0', '0', '0', '0' on the remote control handset.

Revitalize **Block Programme**, **Parental Guidance** and **Input Block** function.



-   Select **LOCK**.
-   Select **Lock System**.
-   Select **On**.
-    Set the password.
-  Input a 4-digit password.  
Be sure to remember this number!  
Re-enter new password for confirm.

- If you forget your password, press '7', '7', '7', '7' on the remote control handset.
- If selecting **On**, **Block Programme**, **Parental Guidance** and **Input Block** operates.

- Press the **MENU** button to return to normal TV viewing.
- Press the **RETURN** button to move to the previous menu screen.





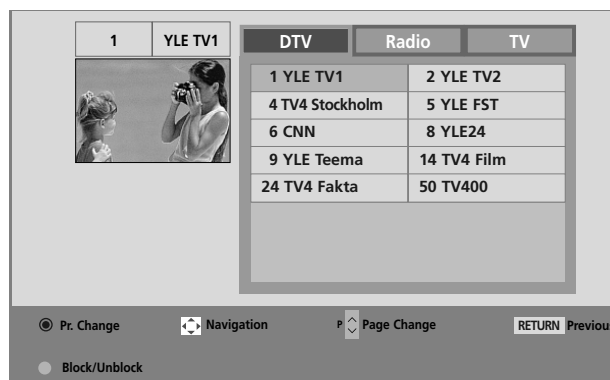
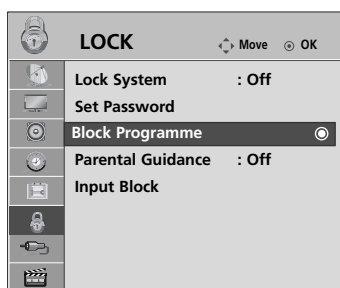

# BLOCK PROGRAMME

Blocks any programmes that you do not want to watch or that you do not want your children to watch.

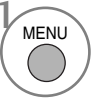
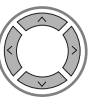
It is available to use this function in **Lock System "On"**.

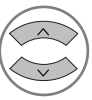
Enter a password to watch a blocked programme.



- 1   Select **LOCK**.
- 2   Select **Block Programme**.
- 3  Enter the **Block Programme**.
- 4   Select a programme to be locked.

- Press the **MENU** button to return to normal TV viewing.
- Press the **RETURN** button to move to the previous menu screen.

# PARENTAL CONTROL / RATINGS

## PARENTAL CONTROL (IN DIGITAL MODE ONLY)

This function operates according to information from the broadcasting station. Therefore if the signal has incorrect information, this function does not operate.





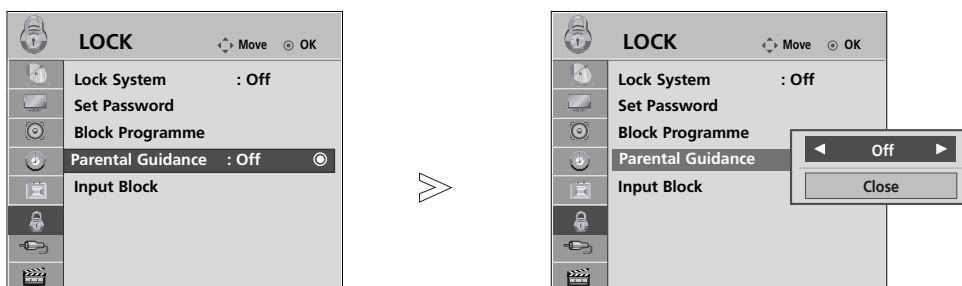

A password is required to gain access to this menu.

This TV is programmed to remember which option it was last set to even if you switch the TV off.

Prevents children from watching certain adult's TV programmes, according to the ratings limit set

Enter a password to watch a rated programme.



-   Select **LOCK**.
-   Select **Parental Guidance**.
-   Make appropriate adjustments.
-  Save.







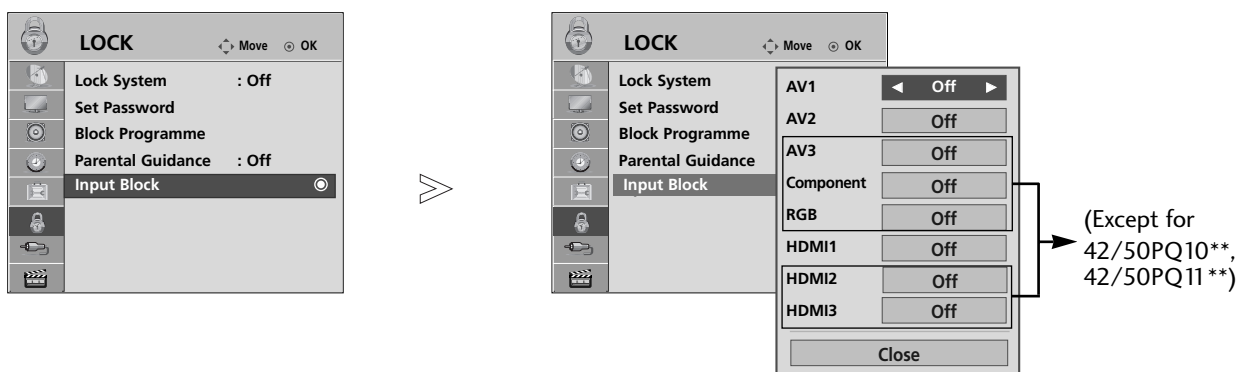

- Press the **MENU** button to return to normal TV viewing.
- Press the **RETURN** button to move to the previous menu screen.



# INPUT BLOCK

Enables you to block an input.



- 1   Select **LOCK**.
- 2   Select **Input Block**.
- 3   Select the source.
- 4   Select **Off** or **On**.

- Press the **MENU** button to return to normal TV viewing.
- Press the **RETURN** button to move to the previous menu screen.

# PARENTAL CONTROL / RATINGS

## KEY LOCK

The TV can be set so that the remote control is required to control it. This feature can be used to prevent unauthorized viewing.

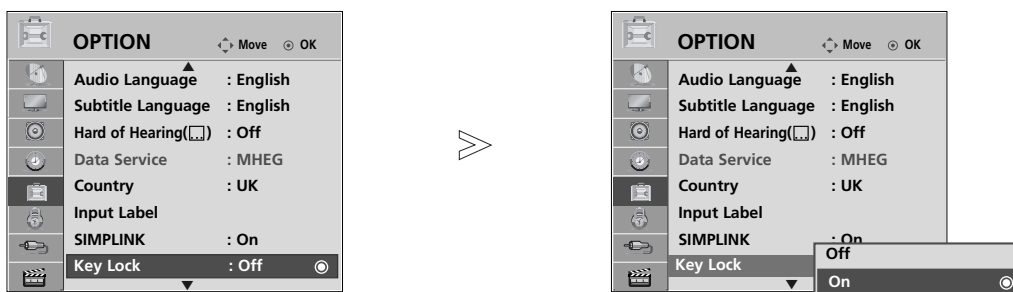

- 1 MENU Select **OPTION**.
- 2 OK Select **Key Lock**.
- 3 OK Select **On** or **Off**.
- 4 OK Save.

### • Set ID : Off

In **Key Lock 'On'**, if the TV is turned off, press the **INPUT**, **P ▲** or **▼** button on the TV or **POWER** buttons on the remote control then the set will be turned on.

### Set ID : On

In **Key Lock 'On'**, if the TV is turned off, press the **INPUT**, **P ▲** or **▼** button on the TV or **POWER**, **INPUT**, **P ▲** or **▼** or **NUMBER** buttons on the remote control then the set will be turned on.

- With the **Key Lock On**, the display ' **x** Key Lock On ' appears on the screen if any button on the front panel is pressed while viewing the TV.(Except for **⏻ / I** button)

- Press the **MENU** button to return to normal TV viewing.
- Press the **RETURN** button to move to the previous menu screen.

# TELETEXT

**This feature is not available in all countries.**

Teletext is a free service broadcast by most TV stations which gives up-to-the-minute information on news, weather, television programmes, share prices and many other topics.

The teletext decoder of this TV can support the SIMPLE, TOP and FASTEXT systems. SIMPLE (standard teletext) consists of a number of pages which are selected by directly entering the corresponding page number. TOP and FASTEXT are more modern methods allowing quick and easy selection of teletext information.

## SWITCH ON/OFF

Press the **TEXT** button to switch to teletext. The initial page or last page viewed appears on the screen.

Two page numbers, TV station name, date and time are displayed on the screen headline. The first page number indicates your selection, while the second shows the current page displayed.

Press the **TEXT** button to switch off teletext. The previous mode reappears.

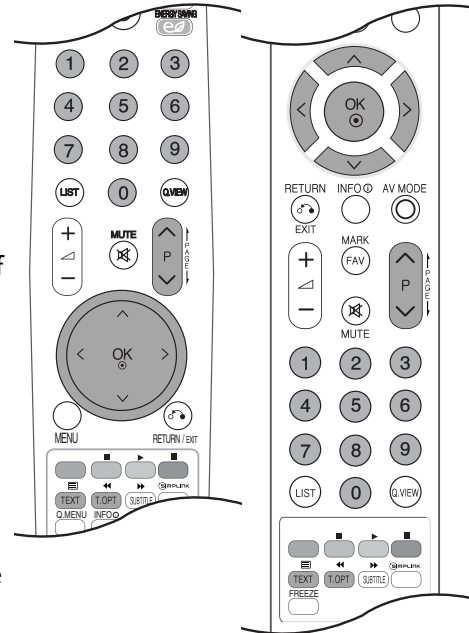

## SIMPLE TEXT

### ■ Page selection

- 1 Enter the desired page number as a three digit number with the NUMBER buttons. If during selection you press a wrong number, you must complete the three digit number and then re-enter the correct page number.
- 2 The **P** ^ ∨ button can be used to select the preceding or following page.

## TOP TEXT

The user guide displays four fields-red, green, yellow and blue at the bottom of the screen. The yellow field denotes the next group and the blue field indicates the next block.

### ■ Block / group / page selection

- 1 With the blue button you can progress from block to block.
- 2 Use the yellow button to proceed to the next group with automatic overflow to the next block.
- 3 With the green button you can proceed to the next existing page with automatic overflow to the next group. Alternatively the **P** ^ button can be used.
- 4 The red button returns to the previous selection. Alternatively the **P** ∨ button can be used.

### ■ Direct page selection

As with SIMPLE teletext mode, you can select a page by entering it as a three digit number using the NUMBER buttons in TOP mode.

# TELETEXT

## FASTEXT

The teletext pages are colour coded along the bottom of the screen and are selected by pressing the corresponding coloured button.

### ■ Page selection

- 1 Press the **T.OPT** button and then use  $\wedge \vee$  button to select  menu. Display the index page.
- 2 You can select the pages which are colour coded along the bottom line with corresponding coloured buttons.
- 3 AS with SIMPLE teletext mode, you can select a page by entering its three digit page number with the **NUMBER** buttons in FASTEXT mode.
- 4 The **P  $\wedge \vee$**  button can be used to select the preceding or following page.

## SPECIAL TELETEXT FUNCTIONS

- Press the **T. OPT** button and then use  $\wedge \vee$  button to select the **Text Option** menu.



### ■ Index

Select the each index page.



### ■ Time

When viewing a TV programme, select this menu to display the time at the top right hand corner of the screen.

In the teletext mode, press this button to select a sub page number. The sub page number is displayed at the bottom of the screen. To hold or change the sub page, press the **RED/GREEN**, **< >** or **NUMBER** buttons.



### ■ Hold

Stops the automatic page change which will occur if a teletext page consists of 2 or more sub pages. The number of sub pages and the sub page displayed is, usually, shown on the screen below the time. When this menu is selected the stop symbol is displayed at the top left-hand corner of the screen and the automatic page change is inactive.



### ■ Reveal

Select this menu to display concealed information, such as solutions to riddles or puzzles.



### ■ Update

Displays the TV picture on the screen while waiting for a new teletext page. The display will appear at the top left hand corner of the screen. When the updated page is available then display will change to the page number. Select this menu again to view the updated teletext page.

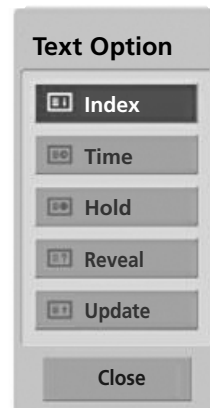

# DIGITAL TELETEXT

\*This function works in UK/ Ireland only.

The TV gives you access to digital teletext which is greatly improved in various aspects such as text, graphics etc. This digital teletext can access special digital teletext services and specific services which broadcast digital teletext.

You should select off in the subtitle language menu to display teletext by pressing the **SUBTITLE** button.

## TELETEXT WITHIN DIGITAL SERVICE

- 1 Press the numeric or **P** ^ v button to select a digital service which broadcasts digital teletext.  
To know which are digital teletext services, refer to the EPG service list.
- 2 Follow the indications on digital teletext and move onto the next step by pressing **TEXT**, **OK**, ^ v < >, **RED**, **GREEN**, **YELLOW**, **BLUE** or **NUMBER** buttons and etc..
- 3 To change digital teletext service, select a different service by the numeric or **P** ^ v button.



## TELETEXT IN DIGITAL SERVICE

- 1 Press the numeric or **P** ^ v button to select a certain service which broadcasts digital teletext.
- 2 Press the **TEXT** or coloured button to switch on teletext.
- 3 Follow the indications on digital teletext and move onto the next step by pressing **OK**, ^ v < >, **RED**, **GREEN**, **YELLOW**, **BLUE** or **NUMBER** buttons and so on.
- 4 Press the **TEXT** or colour button to switch off digital teletext and return to TV viewing.

Some services may allow you to access text services by pressing the **RED** button.



# APPENDIX

## TROUBLESHOOTING

### The TV does not operate properly.

The remote control does not work

- Check to see if there is any object between the TV and the remote control causing an obstruction. Ensure you are pointing the remote control directly at the TV.
- Ensure that the batteries are installed with correct polarity (+ to +, - to -).
- Install new batteries.

Power is suddenly turned off

- Is the sleep timer set?
- Check the power control settings. Has the Power supply been interrupted.
- The TV goes into Standby mode automatically if no signal is received and no operation is performed for 15 minutes.

### The video function does not work.

No picture & No sound

- Check whether the TV is switched on.
- Try another channel. The problem may be with the broadcast.
- Is the power cord inserted correctly into the mains?
- Check your antenna direction and/or location.
- Test the mains outlet by plugging another TV into the same outlet.

Picture appears slowly after switching on

- This is normal, the image is muted during the TV startup process. Please contact your service centre, if the picture has not appeared after five minutes.

No or poor colour or poor picture

- Adjust Colour in menu option.
- Allow a sufficient distance between the TV and the VCR.
- Try another channel. The problem may be with the broadcast.
- Are the video cables installed properly?
- Activate any function to restore the brightness of the picture.

Horizontal/vertical bars or picture shaking

- Check for local interference such as an electrical appliance or power tool.

Poor reception on some channels

- Station or cable channel experiencing problems, tune to another station.
- Station signal is weak, reposition the antenna to receive weaker stations.
- Check for sources of possible interference.

Lines or streaks in pictures

- Check antenna (Change the position of the antenna).

No picture when connecting HDMI

- Check that your HDMI cable is version 1.3 or higher.  
If the HDMI cables don't support HDMI version 1.3, flickering or no screen display can result. Please use the latest cables that support at least HDMI version 1.3.

### The audio function does not work.

Picture OK & No sound	<ul style="list-style-type: none"> <li>■ Press the  + or - button.</li> <li>■ Sound muted? Press <b>MUTE</b> button.</li> <li>■ Try another channel. The problem may be with the broadcast.</li> <li>■ Are the audio cables installed properly?</li> </ul>
No output from one of the speakers	<ul style="list-style-type: none"> <li>■ Adjust <b>Balance</b> in menu option.</li> </ul>
Unusual sound from inside the TV	<ul style="list-style-type: none"> <li>■ A change in ambient humidity or temperature may result in an unusual noise when the TV is switched on or off and does not indicate a fault with the TV.</li> </ul>
No sound when connecting HDMI or USB	<ul style="list-style-type: none"> <li>■ Check HDMI cable over version 1.3.</li> <li>■ Check USB cable over version 2.0.</li> </ul> <p style="text-align: right;">*This feature is not available for all models.</p>

### There is a problem in PC mode. (Only PC mode applied)

The signal is out of range (Invalid format)	<ul style="list-style-type: none"> <li>■ Adjust resolution, horizontal frequency, or vertical frequency.</li> <li>■ Check the input source.</li> </ul>
Vertical bar or stripe on background & Horizontal Noise & Incorrect position	<ul style="list-style-type: none"> <li>■ Use Auto configure or adjust clock, phase, or H/V position. (Option)</li> </ul>
Screen colour is unstable or single colour	<ul style="list-style-type: none"> <li>■ Check the signal cable.</li> <li>■ Reinstall the PC video card.</li> </ul>

### There is a problem with PICTURE settings.

When the user changes the picture settings, the TV automatically converts back to the initial settings after a certain period of time.	<ul style="list-style-type: none"> <li>■ It means that the TV is currently set to <b>Store Demo</b> mode. To switch to <b>Home Use</b> mode you should do the followings: From the TV Menu, choose <b>OPTION</b> -&gt; Choose <b>Mode Setting</b> -&gt; Choose <b>Home Use</b>. Now, you have completed switching to the <b>Home Use</b> mode.</li> </ul>
--	---

# APPENDIX

## MAINTENANCE

Early malfunctions can be prevented. Careful and regular cleaning can prolong the life of your new TV.

Caution: Be sure to switch the power off and unplug the power cord before you begin any cleaning.

### Cleaning the Screen

- 1 A good way to keep the dust off your screen for a while is to wet a soft cloth in a mixture of lukewarm water and a little fabric softener or dish washing detergent. Wring the cloth until it is almost dry, and then use it to wipe the screen.
- 2 Ensure there is no excess water on the screen. Allow any water or dampness to evaporate before switching on.

### Cleaning the Cabinet

- To remove dirt or dust, wipe the cabinet with a soft, dry, lint-free cloth.
- Do not to use a wet cloth.

### Extended Absence

#### CAUTION

- ▶ If you expect to leave your TV dormant for prolonged periods (such as a holiday), unplug the power cord to protect against possible damage from lightning or power surges.



# PRODUCT SPECIFICATIONS

MODELS		42PQ20**	50PQ20**	42PQ30**	50PQ30**
		42PQ2000-ZA 42PQ2010-ZB	50PQ2000-ZA 50PQ2010-ZB	42PQ3000-ZA	50PQ3000-ZA
Dimensions (Width x Height x Depth)	with stand	1031.2 x 720.9 x 308.0 mm 40.6 x 28.4 x 12.1 inches	1216.7 x 818.1 x 353.0 mm 479 x 32.2 x 13.9 inches	1031.2 x 720.9 x 308.0 mm 40.6 x 28.4 x 12.1 inches	1216.7 x 818.1 x 353.0 mm 479 x 32.2 x 13.9 inches
	without stand	1031.2 x 656.7 x 80.8mm 40.6 x 25.9 x 3.2 inches	1216.7 x 759.0 x 83.0 mm 479 x 29.9 x 3.3 inches	1031.2 x 656.7 x 80.8mm 40.6 x 25.9 x 3.2 inches	1216.7 x 759.0 x 83.0 mm 479 x 29.9 x 3.3 inches
Weight	with stand	24.8 kg / 54.7 lbs	33.7kg / 74.3 lbs	24.8 kg / 54.7 lbs	33.7kg / 74.3 lbs
	without stand	22.7 kg / 50.1 lbs	31.2 kg / 68.8 lbs	22.7 kg / 50.1 lbs	31.2 kg / 68.8 lbs
Power requirement		AC100-240V~ 50/60Hz	AC100-240V~ 50/60Hz	AC100-240V~ 50/60Hz	AC100-240V~ 50/60Hz
Power Consumption		320W	430W	320W	430W
MODELS		42PQ60**		50PQ60**	
		42PQ6000-ZA 42PQ6010-ZB		50PQ6000-ZA	
Dimensions (Width x Height x Depth)	with stand	1040.8 x 725.8 x 308 mm 41.0 x 28.6 x 12.1 inches		1228.8 x 824.6 x 353.0 mm 48.4 x 32.5 x 13.9 inches	
	without stand	1040.8 x 669.2 x 76.8 mm 41.0 x 26.4 x 3.1 inches		1228.8 x 772.0 x 78.9 mm 48.4 x 30.4 x 3.1 inches	
Weight	with stand	25.3kg / 55.8 lbs		35 kg / 77.2 lbs	
	without stand	23.3 kg / 51.4 lbs		32.5 kg / 71.7 lbs	
Power requirement		AC100-240V~ 50/60Hz		AC100-240V~ 50/60Hz	
Power Consumption		320W		430W	
Television System		PAL/SECAM B/G/D/K, PAL I/II, SECAM L/L'			
Programme Coverage		VHF: E2 ~ E12, UHF: E21 ~ E69, CATV: S1 ~ S20, HYPER: S21 ~ S47			
External Antenna Impedance		75 Ω			
Environment condition	Operating Temperature	0 ~ 40°C / 32 ~ 104°F			
	Operating Humidity	Less than 80%			
	Storage Temperature	-20 ~ 60°C / -4 ~ 140°F			
	Storage Humidity	Less than 85%			

■ The specifications shown above may be changed without prior notice for quality improvement.

# APPENDIX

MODELS		42PQ10**	50PQ10**	42PQ11**	50PQ11**
		42PQ1000-ZD/ZA	50PQ1000-ZD/ZA	42PQ1100-ZE	50PQ1100-ZE
Dimensions (Width x Height x Depth)	with stand	1031.2 x 720.9 x 308.0 mm 40.6 x 28.4 x 12.1 inches	1216.7 x 818.1 x 353.0 mm 479 x 32.2 x 13.9 inches	1031.2 x 720.9 x 308.0 mm 40.6 x 28.4 x 12.1 inches	1216.7 x 818.1 x 353.0 mm 479 x 32.2 x 13.9 inches
	without stand	1031.2 x 656.7 x 80.8mm 40.6 x 25.9 x 3.2 inches	1216.7 x 759.0 x 83.0 mm 479 x 29.9 x 3.3 inches	1031.2 x 656.7 x 80.8mm 40.6 x 25.9 x 3.2 inches	1216.7 x 759.0 x 83.0 mm 479 x 29.9 x 3.3 inches
Weight	with stand	24.3 kg / 53.6 lbs	33.7kg / 74.3 lbs	24.3 kg / 53.6 lbs	33.7kg / 74.3 lbs
	without stand	22.2 kg / 49.0 lbs	31.2 kg / 68.8 lbs	22.2 kg / 49.0 lbs	31.2 kg / 68.8 lbs
Power requirement		AC100-240V~ 50/60Hz	AC100-240V~ 50/60Hz	AC100-240V~ 50/60Hz	AC100-240V~ 50/60Hz
Power Consumption		320W	430W	320W	430W
MODELS		50PS30** / 50PS20**	50PS60**	60PS40**	
		50PS3000-ZB 50PS2000-ZB	50PS6000-ZC	60PS4000-ZA	
Dimensions (Width x Height x Depth)	with stand	1216.7 x 818.1 x 353.0 mm 479 x 32.2 x 13.9 inches	1228.8 x 824.6 x 353.0 mm 48.4 x 32.5 x 13.9 inches	1468 x 1028.8 x 395.5 mm 57.7 x 40.5 x 15.5 inches	
	without stand	1216.7 x 759.0 x 83.0 mm 479 x 29.9 x 3.3 inches	1228.8 x 772.0 x 78.9 mm 48.4 x 30.4 x 3.1 inches	1468 x 949.5 x 88.5 mm 57.7 x 37.3 x 3.4 inches	
Weight	with stand	35.4 kg / 78.0lbs	36.3 kg / 80.0 lbs	53.06 kg / 116.9 lbs	
	without stand	32.8 kg / 72.3 lbs	33.8 kg / 74.5 lbs	47.16 kg / 103.9 lbs	
Power requirement		AC100-240V~ 50/60Hz	AC100-240V~ 50/60Hz	AC100-240V~ 50/60Hz	
Power Consumption		490W	490W	580W	
Television System		PAL/SECAM B/G/D/K, PAL I/II, SECAM L/L'			
Programme Coverage		VHF: E2 ~ E12, UHF: E21 ~ E69, CATV: S1 ~ S20, HYPER: S21 ~ S47			
External Antenna Impedance		75 Ω			
Environment condition	Operating Temperature	0 ~ 40°C / 32 ~ 104°F			
	Operating Humidity	Less than 80%			
	Storage Temperature	-20 ~ 60°C / -4 ~ 140°F			
	Storage Humidity	Less than 85%			

- The specifications shown above may be changed without prior notice for quality improvement.

MODELS	42PQ60**	50PQ60**	50PS60**
	42PQ6000-ZA	50PQ6000-ZA	50PS6000-ZC
Supported movie files	Refer to p.61		

# IR CODES

Code (Hexa)	Function	Note
08	POWER	R/C BUTTON (POWER ON/OFF)
0B	INPUT	R/C BUTTON
f0	TV/RAD	R/C BUTTON
45	Q.MENU	R/C BUTTON
43	MENU	R/C BUTTON
AB	GUIDE	R/C BUTTON
07	Left (<)	R/C BUTTON
06	Right (>)	R/C BUTTON
40	Up (^)	R/C BUTTON
41	Down (v)	R/C BUTTON
44	OK(⊙)	R/C BUTTON
28	RETURN/EXIT	R/C BUTTON
AA	INFO ⓘ	R/C BUTTON
30	AV MODE	R/C BUTTON
02	↖ +	R/C BUTTON
03	↖ -	R/C BUTTON
00	P ^	R/C BUTTON
01	P v	R/C BUTTON
1E	FAV(MARK)	R/C BUTTON
09	MUTE	R/C BUTTON
10 ~ 19	Number Key 0~9	R/C BUTTON
53	LIST	R/C BUTTON
1A	Q.VIEW	R/C BUTTON
72	RED Key	R/C BUTTON
71	GREEN Key	R/C BUTTON
63	YELLOW Key	R/C BUTTON
61	BLUE Key	R/C BUTTON
20	TEXT	R/C BUTTON
21	T.OPT (T.Option)	R/C BUTTON
39	SUBTITLE	R/C BUTTON
7E	SIMPLINK	R/C BUTTON
95	ENERGY SAVING or Power Saving	R/C BUTTON
65	FREEZE	R/C BUTTON
79	RATIO	R/C BUTTON

(Except for  
42/50PQ10\*\*,  
42/50PQ11\*\*)

(Except for  
42/50PQ10\*\*,  
42/50PQ11\*\*,  
42/50PQ20\*\*,  
42/50PQ30\*\*)

# APPENDIX

## EXTERNAL CONTROL DEVICE SETUP

### RS-232C Setup

Connect the RS-232C (serial port) input jack to an external control device (such as a computer or an A/V control system) to control the product's functions externally.

Connect the serial port of the control device to the RS-232C jack on the product back panel.

Note: RS-232C connection cables are not supplied with the product.

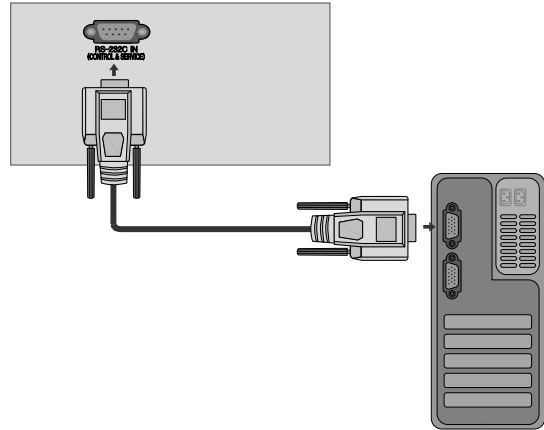

### Type of Connector; D-Sub 9-Pin Male

No.	Pin Name
1	No connection
2	RXD (Receive data)
3	TXD (Transmit data)
4	DTR (DTE side ready)
5	GND
6	DSR (DCE side ready)
7	RTS (Ready to send)
8	CTS (Clear to send)
9	No Connection

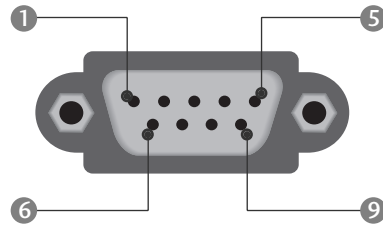

### RS-232C Configurations

#### 7-Wire Configurations (Standard RS-232C cable)

	PC	TV	
RXD	2 ● ——— ● 3		TXD
TXD	3 ● ——— ● 2		RXD
GND	5 ● ——— ● 5		GND
DTR	4 ● ——— ● 6		DSR
DSR	6 ● ——— ● 4		DTR
RTS	7 ● ——— ● 8		CTS
CTS	8 ● ——— ● 7		RTS
	D-Sub 9	D-Sub 9	

#### 3-Wire Configurations (Not standard)

	PC	TV	
RXD	2 ● ——— ● 3		TXD
TXD	3 ● ——— ● 2		RXD
GND	5 ● ——— ● 5		GND
DTR	4	6	DTR
DSR	6	4	DSR
RTS	7	7	RTS
CTS	8	8	CTS
	D-Sub 9	D-Sub 9	

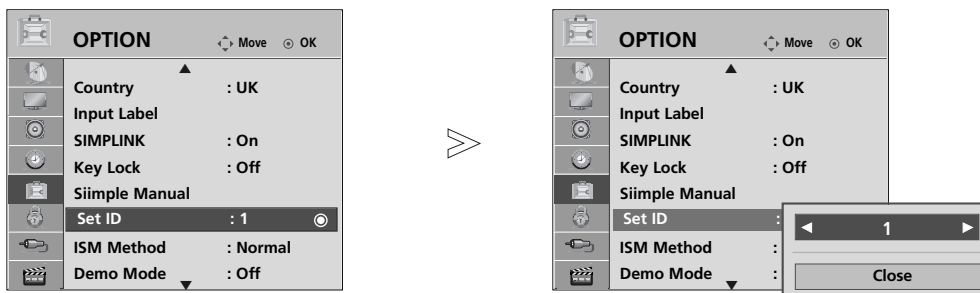

## Set ID

Use this function to specify a set ID number.  
Refer to 'Real Data Mapping'. ▶ p.119



1   Select **OPTION**.

2   Select **Set ID**.

3   Adjust **Set ID** to choose the desired TV ID number.  
The adjustment range of SET ID is 1~99.

- Press **RETURN** button to move to the previous menu screen.

# APPENDIX

## Communication Parameters

- Baud rate : 9600 bps (UART)
- Data length : 8 bits
- Parity : None
- Stop bit : 1 bit
- Communication code : ASCII code
- Use a crossed (reverse) cable.

### Command Reference List

	COMMAND 1	COMMAND 2	DATA (Hexadecimal)
01. Power	k	a	00 ~ 01
02. Aspect Ratio	k	c	Refer to p. 117
03. Screen Mute	k	d	Refer to p. 117
04. Volume Mute	k	e	00 ~ 01
05. Volume Control	k	f	00 ~ 64
06. Contrast	k	g	00 ~ 64
07. Brightness	k	h	00 ~ 64
08. Colour	k	i	00 ~ 64
09. Tint	k	j	00 ~ 64
10. Sharpness	k	k	00 ~ 64
11. OSD Select	k	l	00 ~ 01
12. Remote control lock mode	k	m	00 ~ 01
13. Treble	k	r	00 ~ 64
14. Bass	k	s	00 ~ 64
15. Balance	k	t	00 ~ 64
16. Colour Temperature	k	u	00 ~ 02
17. Abnormal Status	k	z	FF
18. ISM Method	j	p	Refer to p. 119
19. Energy Saving	j	q	Refer to p. 119
20. Auto Configuration	j	u	01
21. Tune Command	m	a	Refer to p. 119
22. Channel Add/Skip	m	b	00 ~ 01
23. Key	m	c	Sende IR-kode
24. Input select (Main)	x	b	Refer to p. 120

- \* When setting the 17 ~ 24, a menu does not appear on screen.
- \* Note: During USB operations such as Dvix or EMF, all commands except Power (ka) and Key (mc) are not executed and treated as NG.

### Transmission / Receiving Protocol

#### Transmission

[Command1][Command2][ ][Set ID][ ][Data][Cr]

- \* [Command 1] : First command to control the TV.  
(j, k, m or x)
- \* [Command 2] : Second command to control the TV.
- \* [Set ID] : You can adjust the set ID to choose desired monitor ID number in option menu. Adjustment range is 1 ~ 99. When selecting Set ID '0', every connected set is controlled. Set ID is indicated as decimal (1~99) on menu and as Hexa decimal (0x0~0x63) on transmission/receiving protocol.
- \* [DATA] : To transmit command data. Transmit 'FF' data to read status of command.
- \* [Cr] : Carriage Return  
ASCII code '0x0D'
- \* [ ] : ASCII code 'space (0x20)'

#### OK Acknowledgement

[Command2][ ][Set ID][ ][OK][Data][x]

- \* The set transmits ACK (acknowledgement) based on this format when receiving normal data. At this time, if the data is data read mode, it indicates present status data. If the data is data write mode, it returns the data of the PC computer.

#### Error Acknowledgement

[Command2][ ][Set ID][ ][NG][Data][x]

- \* The set transmits ACK (acknowledgement) based on this format when receiving abnormal data from non-viable functions or communication errors.

Data 00: Illegal Code

**01. Power (Command: k a)**

- ▶ To control Power On/Off of the set.

*Transmission*

```
[k][a][ ][Set ID][ ][Data][Cr]
```

Data 00 : Power Off            01 : Power On

*Ack*

```
[a][ ][Set ID][ ][OK/NG][Data][x]
```

- ▶ To show Power On/Off.

*Transmission*

```
[k][a][ ][Set ID][ ][FF][Cr]
```

*Ack*

```
[a][ ][Set ID][ ][OK/NG][Data][x]
```

- \* Similarly, if other functions transmit '0xFF' data based on this format, Acknowledgement data feed back presents status about each function.
- \* OK Ack., Error Ack. and other message may display on the screen when TV is power On.

**02. Aspect Ratio (Command: k c) (Main Picture Size)**

- ▶ To adjust the screen format. (Main picture format)  
You can also adjust the screen format using the **Aspect Ratio** in the Q.MENU. or PICTURE menu.

*Transmission*

```
[k][c][ ][Set ID][ ][Data][Cr]
```

Data 01 : Normal screen (4:3)    07 : 14:9  
 02 : Wide screen (16:9)        09 : Just Scan  
 04 : Zoom                        0B : Full Wide  
 06 : Original                    10~1F : Cinema Zom 1~16

*Ack*

```
[c][ ][Set ID][ ][OK/NG][Data][x]
```

- \* Using the PC input, you select either 16:9 or 4:3 screen aspect ratio.
- \* In DTV/HDMI (1080i 50Hz/60Hz, 720p 50Hz/60Hz, 1080p 24Hz/30Hz/50Hz/60Hz), Component( 720p, 1080i, 1080p 50Hz/60Hz) mode, **Just Scan** is available.
- \* Full wide is supported only for Analogue, AV1,2,3.

**03. Screen Mute (Command: k d)**

- ▶ To select screen mute on/off.

*Transmission*

```
[k][d][ ][Set ID][ ][Data][Cr]
```

Data 00 : Screen mute off (Picture on)  
           Video mute off  
           01 : Screen mute on (Picture off)  
           10 : Video mute on

*Ack*

```
[d][ ][Set ID][ ][OK/NG][Data][x]
```

- \* In case of video mute on only, TV will display On Screen Display(OSD). But, in case of Screen mute on, TV will not display OSD.

**04. Volume Mute (Command: k e)**

- ▶ To control volume mute on/off.  
You can also adjust mute using the MUTE button on remote control.

*Transmission*

```
[k][e][ ][Set ID][ ][Data][Cr]
```

Data 00 : Volume mute on (Volume off)  
 01 : Volume mute off (Volume on)

*Ack*

```
[e][ ][Set ID][ ][OK/NG][Data][x]
```

**05. Volume Control (Command: k f)**

- ▶ To adjust volume.  
You can also adjust volume with the VOLUME buttons on remote control.

*Transmission*

```
[k][f][ ][Set ID][ ][Data][Cr]
```

Data Min : 00 ~ Max : 64  
 \* Refer to 'Real data mapping 1': See page 119.

*Ack*

```
[f][ ][Set ID][ ][OK/NG][Data][x]
```

**06. Contrast (Command: k g)**

- ▶ To adjust screen contrast.  
You can also adjust contrast in the PICTURE menu.

*Transmission*

```
[k][g][ ][Set ID][ ][Data][Cr]
```

Data Min : 00 ~ Max : 64  
 \* Refer to 'Real data mapping 1': See page 119.

*Ack*

```
[g][ ][Set ID][ ][OK/NG][Data][x]
```

**07. Brightness (Command: k h)**

- ▶ To adjust screen brightness.  
You can also adjust brightness in the PICTURE menu.

*Transmission*

```
[k][h][ ][Set ID][ ][Data][Cr]
```

Data Min : 00 ~ Max : 64  
 \* Refer to 'Real data mapping 1': See page 119.

*Ack*

```
[h][ ][Set ID][ ][OK/NG][Data][x]
```

**08. Colour (Command: k i)**

- ▶ To adjust the screen colour.  
You can also adjust colour in the PICTURE menu.

*Transmission*

```
[k][i][ ][Set ID][ ][Data][Cr]
```

Data Min : 00 ~ Max : 64  
 \* Refer to 'Real data mapping 1': See page 119.

*Ack*

```
[i][ ][Set ID][ ][OK/NG][Data][x]
```

# APPENDIX

## 09. Tint (Command: k j)

- ▶ To adjust the screen tint.  
You can also adjust tint in the PICTURE menu.

### Transmission

[k][j][ ][Set ID][ ][Data][Cr]

Data Min : 00 ~ Max : 64  
\* Refer to 'Real data mapping 1'. See page 119.

### Ack

[j][ ][Set ID][ ][OK/NG][Data][x]

## 10. Sharpness (Command: k k)

- ▶ To adjust the screen sharpness.  
You can also adjust sharpness in the PICTURE menu.

### Transmission

[k][k][ ][Set ID][ ][Data][Cr]

Data Min : 00 ~ Max : 64  
\* Refer to 'Real data mapping 1'. See page 119.

### Ack

[k][ ][Set ID][ ][OK/NG][Data][x]

## 11. OSD Select (Command: k l)

- ▶ To select OSD (On Screen Display) on/off when controlling remotely.

### Transmission

[k][l][ ][Set ID][ ][Data][Cr]

Data 00 : OSD off      01 : OSD on

### Ack

[l][ ][Set ID][ ][OK/NG][Data][x]

## 12. Remote control lock mode (Command: k m)

- ▶ To lock the front panel controls on the monitor and remote control.

### Transmission

[k][m][ ][Set ID][ ][Data][Cr]

Data 00 : Lock off      01 : Lock on

### Ack

[m][ ][Set ID][ ][OK/NG][Data][x]

- \* If you are not using the remote control, use this mode.  
When main power is on/off, external control lock is released.

- \* Local Power Key will work properly.

## 13. Treble (Command: k r)

- ▶ To adjust treble.  
You can also adjust treble in the AUDIO menu.

### Transmission

[k][r][ ][Set ID][ ][Data][Cr]

Data Min : 00 ~ Max : 64  
\* Refer to 'Real data mapping 1'. See page 119.

### Ack

[r][ ][Set ID][ ][OK/NG][Data][x]

## 14. Bass (Command: k s)

- ▶ To adjust bass.  
You can also adjust bass in the AUDIO menu.

### Transmission

[k][s][ ][Set ID][ ][Data][Cr]

Data Min : 00 ~ Max : 64  
\* Refer to 'Real data mapping 1'. See page 119.

### Ack

[s][ ][Set ID][ ][OK/NG][Data][x]

## 15. Balance (Command: k t)

- ▶ To adjust balance.  
You can also adjust balance in the AUDIO menu.

### Transmission

[k][t][ ][Set ID][ ][Data][Cr]

Data Min : 00 ~ Max : 64  
\* Refer to 'Real data mapping 1'. See page 119.

### Ack

[t][ ][Set ID][ ][OK/NG][Data][x]

## 16. Colour Temperature (Command: k u)

- ▶ To adjust colour temperature. You can also adjust Colour Temperature in the PICTURE menu.

### Transmission

[k][u][ ][Set ID][ ][Data][Cr]

Data 00: Medium    01: Cool    02: Warm

### Ack

[u][ ][Set ID][ ][OK/NG][Data][x]

## 17. Abnormal State (Command: k z)

- ▶ To recognize an abnormal state.

### Transmission

[k][z][ ][Set ID][ ][FF][ ][Cr]

Data FF : Read

### Ack

[z][ ][Set ID][ ][OK/NG][Data][x]

Data 00: Normal (Power on and signal exist)  
01: No signal (Power on)  
02: Turn the TV off by remote control  
03: Turn the TV off by sleep time function  
04: Turn the TV off by RS-232C function  
05: 5V down  
06: AC down  
07: Turn the TV off by Fan Alarm function  
08: Turn the TV off by Off time function  
09: Turn the TV off by Auto sleep function  
a: Turn the TV off by AV board detection.

- \* This function is "read only".



## 18. ISM Method (Command: j p)

- ▶ To control the ISM method. You can also adjust ISM Method in OPTION menu.

### Transmission

[j][p][ ][Set ID][ ][Data][Cr]

Data 02: Orbiter  
 04: White wash  
 08: Normal  
 20: Colour Wash

### Ack

[p][ ][Set ID][ ][OK/NG][Data][x]

## 19. Energy Saving (Command: j q)

- ▶ To reduce the power consumption of the TV. You can also adjust Energy Saving in OPTION menu.

### Transmission

[j][q][ ][Set ID][ ][Data][Cr]

Data 00: Off  
 01: Minimum  
 02: Medium  
 03: Maximum

10 : Intelligent Sensor(Low)	→ (Except for 42/50PQ10**, 42/50PQ11**)
11 : Intelligent Sensor(Middle)	
12 : Intelligent Sensor(High)	

### Ack

[q][ ][Set ID][ ][OK/NG][Data][x]

## 20. Auto Configure (Command: j u)

- ▶ To adjust picture position and minimize image shaking automatically. It works only in RGB (PC) mode.

### Transmission

[j][u][ ][Set ID][ ][Data][Cr]

Data 01: To set

### Ack

[u][ ][Set ID][ ][OK/NG][Data][x]

## 21. Tune Command (Command: m a)

- ▶ Select channel to following physical number.

### Transmission

[m][a][ ][Set ID][ ][Data0][ ][Data1][ ][Data2][Cr]

Data00 : High channel data  
 Data01 : Low channel data  
 ex. No. 47 -> 00 2F (2FH)  
 No. 394 -> 01 88 (188H),  
 DTV No. 0 -> Don't care  
 Data02 0x00 : ATV Main  
 0x10 : DTV Main  
 0x20 : Radio

Channel data range  
 Analogue - Min: 00 ~ Max: 63 (0~99)  
 Digital - Min: 00 ~ Max: 3E7 (0~999)

### Ack

[a][ ][Set ID][ ][OK/NG][Data][x]

Data Min: 00 ~ Max: FF

## 22. Channel Add/Skip (Command: m b)

- ▶ To set skip status for the current Programme.

### Transmission

[m][b][ ][Set ID][ ][Data][Cr]

Data 00 : Skip      01 : Add

### Ack

[b][ ][Set ID][ ][OK/NG][Data][x]

### \* Real data mapping 1

00 : Step 0
⋮
A : Step 10 (Set ID 10)
⋮
F : Step 15 (Set ID 15)
10 : Step 16 (Set ID 16)
⋮
64 : Step 100
⋮
6E : Step 110
⋮
73 : Step 115
74 : Step 116
⋮
C7 : Step 199
⋮
FE : Step 254
FF : Step 255

### \* Real data mapping 2

00 :-40
01 :-39
02 :-38
⋮
28 : 0
⋮
4E : +38
4F : +39
50 : +40

# APPENDIX

## 23. Key (Command: m c)

► To send IR remote key code.

*Transmission*

[m][c][ ][Set ID][ ][Data][Cr]

Data Key code - Refer to page 113.

*Ack*

[c][ ][Set ID][ ][OK/NG][Data][x]

## 24. Input select (Command: x b) (Main Picture Input)

► To select input source for main picture.

*Transmission*

[x][b][ ][Set ID][ ][Data][Cr]

Data Structure

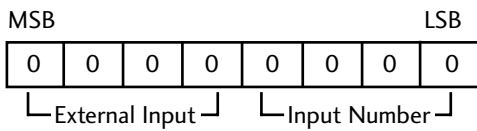

External Input				Data
0	0	0	0	DTV
0	0	0	1	Analogue
0	0	1	0	AV
0	1	0	0	Component
0	1	0	1	RGB
1	0	0	1	HDMI

Input Number				Data
0	0	0	0	Input1
0	0	0	1	Input2
0	0	1	0	Input3

(Except for 42/50PQ10\*\*,  
42/50PQ11\*\*)

*Ack*

[b][ ][Set ID][ ][OK/NG][Data][x]



**LG Electronics Inc.**