



LG

Life's Good

PLASMA TV OWNER'S MANUAL

PLASMA TV MODELS

42PQ2***

50PQ2***

42PQ3***

50PQ3***

42PQ6***

50PQ6***

Please read this manual carefully before operating your TV.

Retain it for future reference.

Record the model number and serial number of the TV.

Refer to the label on the back cover and quote this information.

To your dealer when requiring any service.



This feature is not available for all models.

This product qualifies for ENERGY STAR in the "factory default (Home Use mode)" setting and this is the setting in which power savings will be achieved.

Changing the factory default picture setting or enabling other features will increase power consumption that could exceed the limits necessary to qualify for Energy Star rating.

ACCESSORIES

Ensure that the following accessories are included with your TV. If an accessory is missing, please contact the dealer where you purchased the TV.

- Image shown may differ from your TV

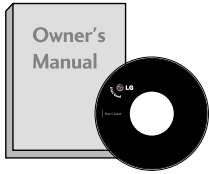

Owner's Manual

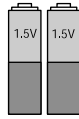

Batteries

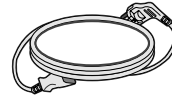

Power Cord

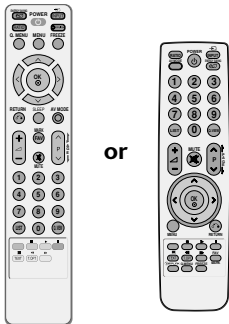

or

Remote Control

This item is not included for all models.

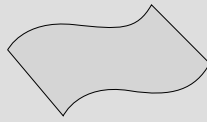

Polishing Cloth
Polishing cloth for use on the screen.

* Lightly wipe any stains or fingerprints on the surface of the TV with the polishing cloth.

Do not use excessive force. This may cause scratching or discoloration.

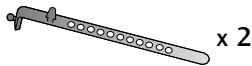

Cable Holder
(Refer to P. 9)

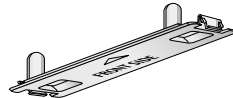

Protection cover
(Refer to p. 9)

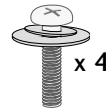

Bolts for stand assembly
(Refer to P. 7)

Wall Mounting Bracket
(Separate purchase)

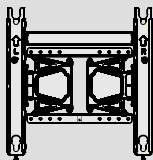

AW-50PG60MS

CONTENTS

ACCESSORIES..... 1

PREPARATION

Front Panel Controls..... 4
Back Panel Information 6
Stand Installation..... 7
Careful installation advice.....8
Back Cover for Wire Arrangement..... 9
Swivel Stand9
Not using the desk-type stand.....9
Desktop Pedestal Installation..... 10
Wall Mount: Horizontal installation 10
ANTENNA CONNECTION 11

EXTERNAL EQUIPMENT SETUP

HD Receiver Setup..... 12
DVD Setup 15
VCR Setup..... 18
Other A/V Source Setup/Usb in Setup..... 21
PC Setup 22
- Screen Setup for PC Mode..... 24

WATCHING TV / PROGRAMME CONTROL

REMOTE CONTROL KEY FUNCTIONS28
Turning on the TV32
Programme Selection.....32
Volume Adjustment 32
Quick Menu33
On Screen Menus Selection and adjustment34
Auto programme tuning35
Manual programme Tuning36
Programme Edit38
SELECTING THE PROGRAMME TABLE40
Favourite programme setup.....41
Input LIST42
SIMPLINK.....43
Input LABEL.....46

AV Mode47
key Lock.....48
Initializing (Reset to original factory settings) ..49

TO USE THE USB DEVICE

When connecting the USB device.....50
Photo list.....51
Music list.....55
Movie list.....58
DivX Registration Code62
Deactivation63

PICTURE CONTROL

Picture Size (Aspect Ratio) Control.....64
 Energy Saving.....66
Preset picture settings
Picture Mode-Preset67
Auto Colour Tone Control
(Warm/Medium/Cool)68
Manual Picture Adjustment
Picture Mode-User option69
Picture Improvement Technology70
Advanced - Black(Darkness) Level.....71
Advanced - Film Mode72
Picture Reset.....73
Image Sticking Minimization (ISM) Method74
Demo mode75
Mode setting.....76

SOUND & LANGUAGE CONTROL

Auto Volume Leveler	77
Preset Sound Settings-Sound Mode.....	78
Sound Setting Adjustment -User Mode.....	79
SRS TruSurround XT.....	79
Clear Voice II	80
Balance.....	81
Audio Reset	82
TV Speakers On/ Off Setup	83
I/II	
Stereo/Dual Reception.....	84
NICAM Reception	85
Speaker Sound Output Selection.....	85
On-Screen Menu Language /	
Country Selection	86

TIME SETTING

Clock Setup	87
Auto on/off timer setting.....	88
Sleep Timer setting.....	89

TELETEXT

Switch on/off	90
SIMPLE Text.....	90
TOP Text.....	90
FASTEXT	91
Special Teletext Functions	91

APPENDIX

Troubleshooting.....	92
Maintenance	94
Product Specifications	95
IR Codes	97
External Control Device Setup.....	99

PREPARATION

FRONT PANEL CONTROLS

- Image shown may differ from your TV.

⚠ CAUTION

- ▶ When the TV cannot be turned on with the remote control, press the main power button on the TV. (When the power is turned off with the main power button on the TV, it will not be turned on with the remote control.)

42/50PQ2***

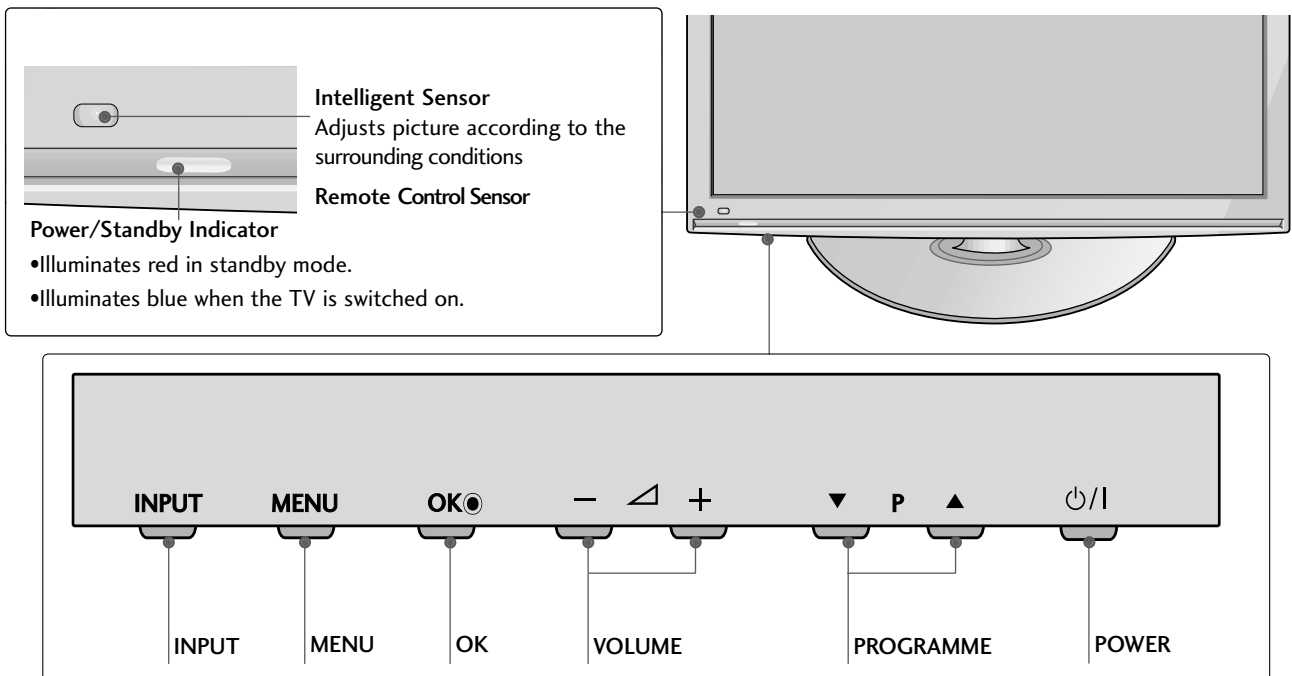

42/50PQ3***

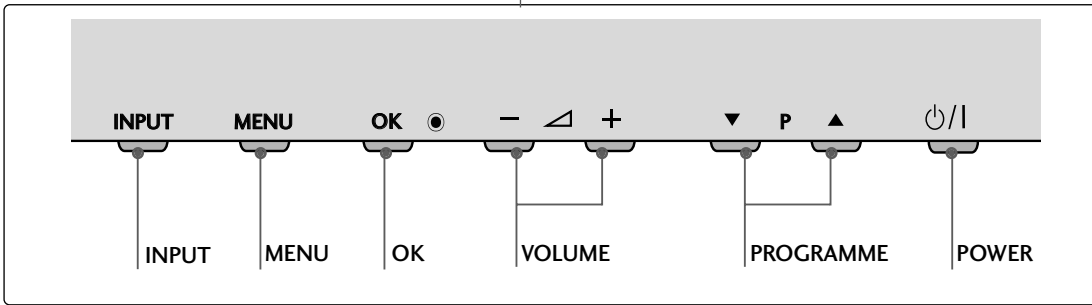
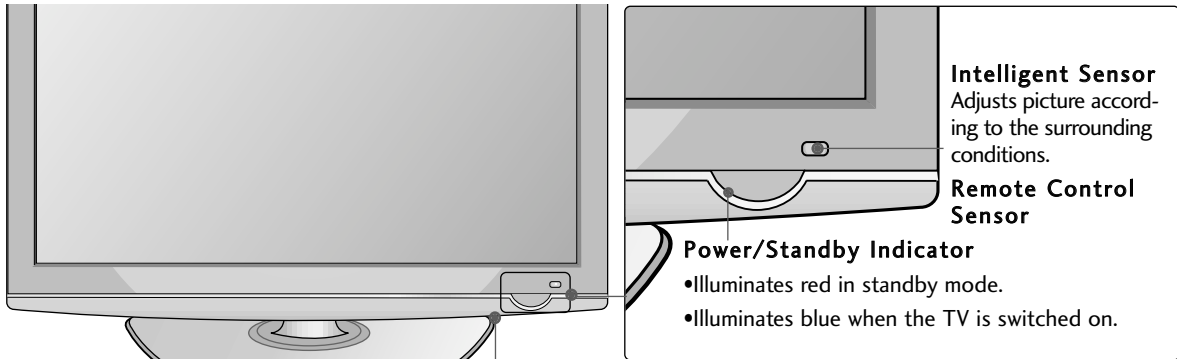

42/50PQ6***

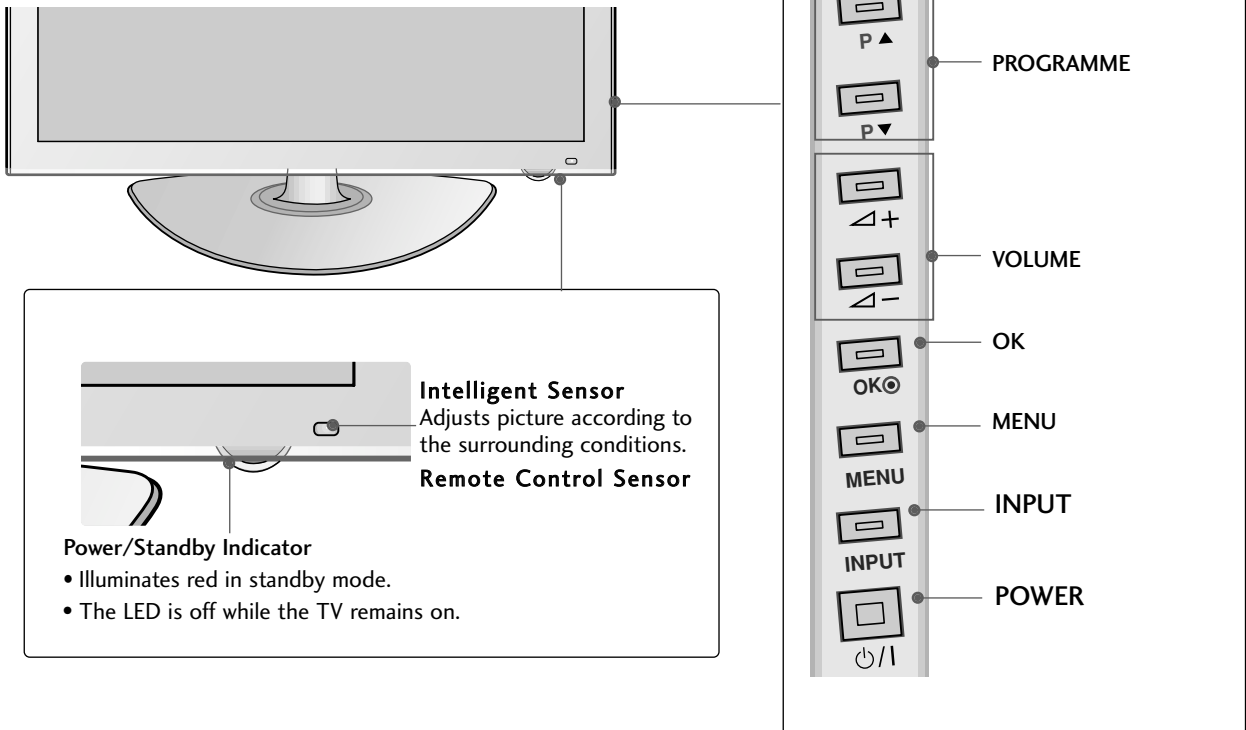

PREPARATION

BACK PANEL INFORMATION

■ Image shown may differ from your TV.

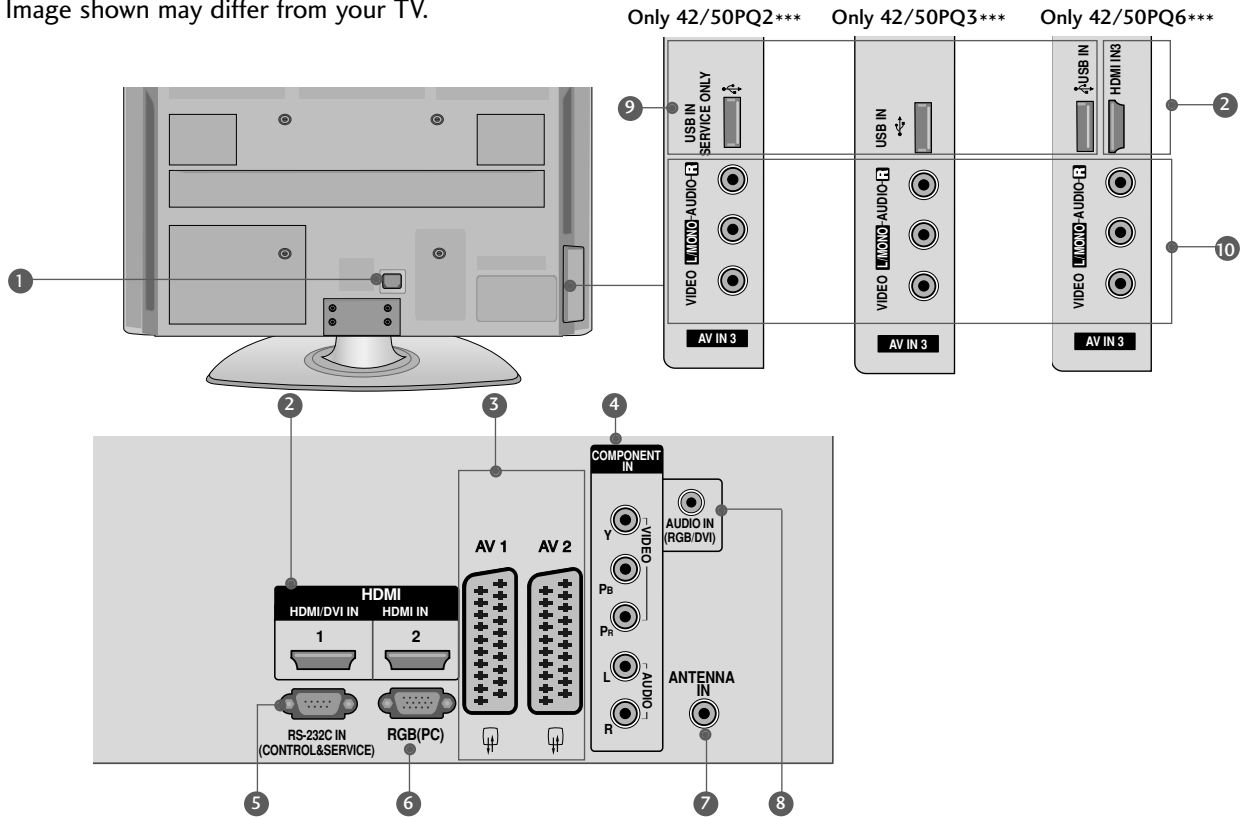

- 1 Power Cord Socket**
This TV operates on an AC power. The voltage is indicated on the Specifications page. Never attempt to operate the TV on DC power.
- 2 HDMI Input**
Connect a HDMI signal to HDMI IN
Or DVI(VIDEO)signal to HDMI/DVI port with DVI to HDMI cable.
- 3 Euro Scart Socket (AV1/AV2)**
Connect scart socket input or output from an external device to these jacks.
- 4 Component Input**
Connect a component video/audio device to this jack.
- 5 RS-232C Input (CONTROL&SERVICE) Port**
Connect to the RS-232C port on a PC.
This port is used for Service or Hotel mode.
- 6 RGB Input**
Connect the output from a PC.
- 7 Antenna Input**
Connect RF antenna to this jack.
- 8 RGB/DVI Audio Input**
Connect the audio from a PC or DTV.
- 9 USB Input**
42/50PQ2*** : Service only
42/50PQ3*** : Used for Photo and Music
42/50PQ6*** : Used for Photo, Music and Movie
- 10 Audio/Video Input(AV3)**
Connect audio/video output from an external device to these jacks.

STAND INSTALLATION

- Image shown may differ from your TV
- When assembling the desk type stand, check whether the bolt is fully tightened. (If not tightened fully, the product can tilt forward after the product installation.) If you tighten the bolt with excessive force, the bolt can deviate from abrasion of the tightening part of the bolt.

1 Carefully place the TV screen side down on a cushioned surface to protect the screen from damage.

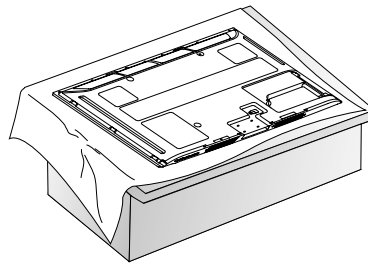

2 Assemble the TV as shown.

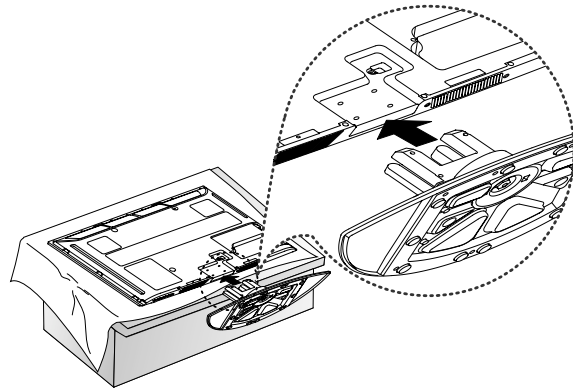

3 Fix the 4 bolts securely using the holes in the back of the TV.

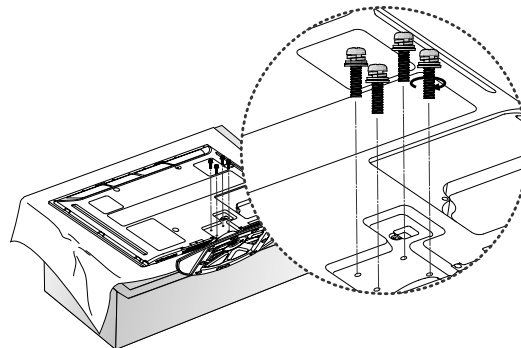

! NOTE

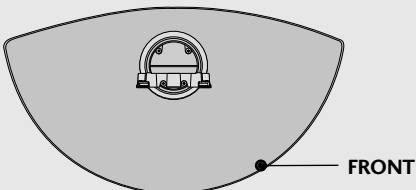

▶ When assembling the stand, make sure to distinguish and assemble the front and rear side of the stand correctly.

PREPARATION

CAREFUL INSTALLATION ADVICE

- You should purchase necessary components to fix the TV safely and secure to the wall from the market.
- Position the TV close to the wall to avoid the possibility of it falling when pushed.
- The instructions shown below are a safer way to set up the TV, by fixing it to the wall, avoiding the possibility of it falling forwards if pulled. This will prevent the TV from falling forward and causing injury. This will also prevent the TV from damage. Ensure that children do not climb or hang from the TV.

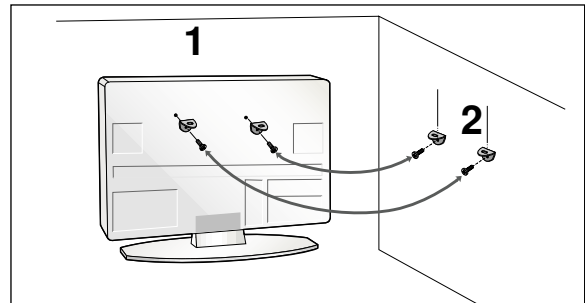
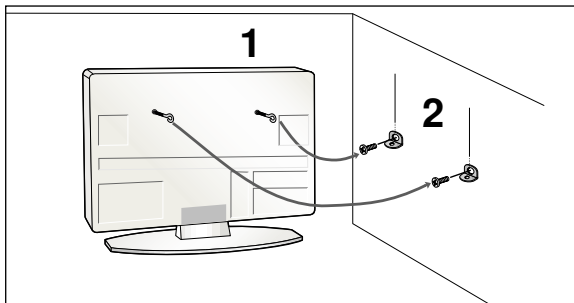

- 1 Use the eye-bolts or TV brackets/bolts to fix the product to the wall as shown in the picture. (If your TV has bolts in the eye-bolts, loosen them first.)
* Insert the eye-bolts or TV brackets/bolts and tighten them securely in the upper holes.
- 2 Secure the wall brackets with the bolts on the wall. Match the height of the bracket that is mounted on the wall.

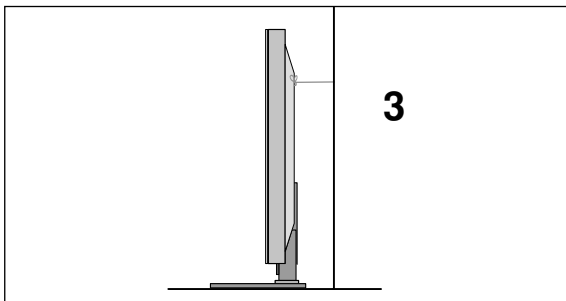

- 3 Use a sturdy rope to tie the product for alignment. It is safer to tie the rope so it becomes horizontal between the wall and the product.

! NOTE

- ▶ When moving the TV undo the cords first.
- ▶ Use a platform or cabinet strong and large enough to support the size and weight of the TV.
- ▶ To use the TV safely make sure that the height of the bracket on the wall and on the TV is the same.

BACK COVER FOR WIRE ARRANGEMENT

■ Image shown may differ from your TV.

After Connecting the cables as necessary, install **CABLE HOLDER** as shown and bundle the cables.

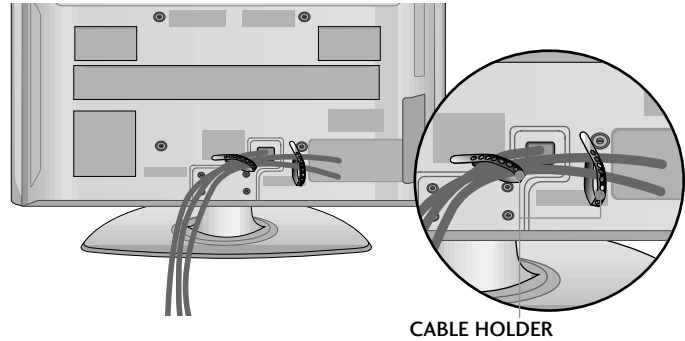

CABLE HOLDER

SWIVEL STAND

This feature is not available for all models.

After installing the TV, you can adjust the TV set manually to the left or right direction by 20 degrees to suit your viewing position.

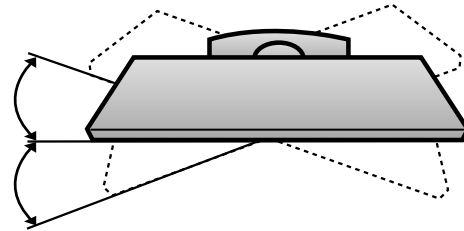

NOT USING THE DESK-TYPE STAND

■ Here shown may differ from your TV.

When installing the wall-mounted unit, use the protection cover. Insert the **PROTECTION COVER** into the TV until clicking sound.

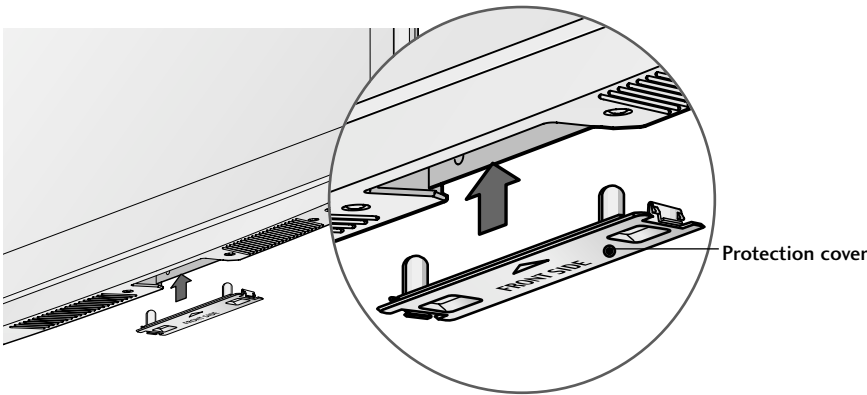

Protection cover

EARTHING

Ensure that you connect the earth wire to prevent possible electric shock. If grounding methods are not possible, have a qualified electrician install a separate circuit breaker.

Do not try to earth the TV by connecting it to telephone wires, lightning rods or gas pipes.

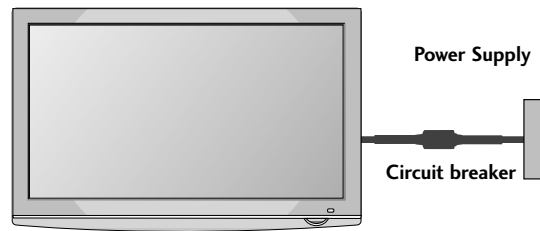

PREPARATION

- The TV can be installed in various ways such as on a wall, or on a desktop etc.
- The TV is designed to be mounted horizontally.

DESKTOP PEDESTAL INSTALLATION

For adequate ventilation allow a clearance of 4" (10cm) all around the TV.

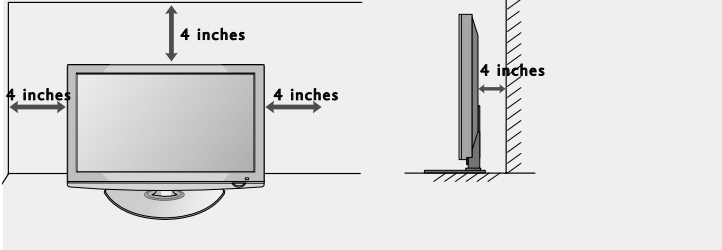

WALL MOUNT: HORIZONTAL INSTALLATION

- We recommend the use of a LG Brand wall mounting bracket when mounting the TV to a wall.
- We recommend that you purchase a wall mounting bracket which supports VESA standard.
- LG recommends that wall mounting be performed by a qualified professional installer.

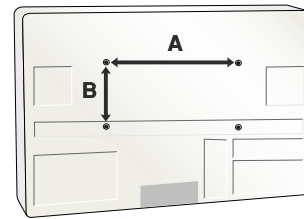

! NOTE

- ▶ Should Install wall mount on a solid wall perpendicular to the floor.
- ▶ Should use a special wall mount, if you want to install it to ceiling or slanted wall.
- ▶ The surface that wall mount is to be mounted on should be of sufficient strength to support the weight of TV set; e.g. concrete, natural rock, brick and hollow block.
- ▶ Installing screw type and length depends on the wall mount used. Further information, refer to the instructions included with the mount.
- ▶ LG is not liable for any accidents or damage to property or TV due to incorrect installation:
 - Where a non-compliant VESA wall mount is used.
 - Incorrect fastening of screws to surface which may cause TV to fall and cause personal injury.
 - Not following the recommended Installation method.

Model	VESA (A * B)	Standard Screw	Quantity
42PQ2***	400 * 400	M6	4
50PQ2***	400 * 400	M6	4
42PQ3***	400 * 400	M6	4
50PQ3***	400 * 400	M6	4
42PQ6***	400 * 400	M6	4
50PQ6***	400 * 400	M6	4

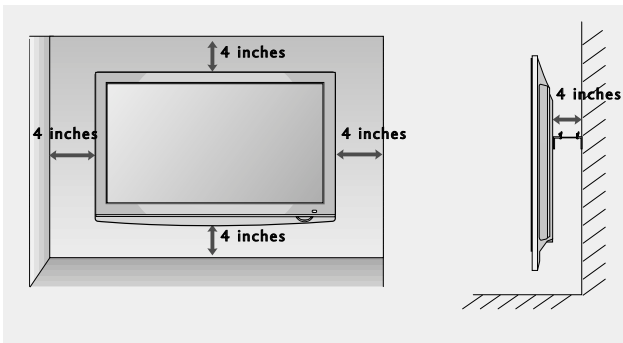

- To prevent damage do not connect to the mains outlet until all connections are made between the devices.

ANTENNA CONNECTION

- For optimum picture quality, adjust antenna direction.
- An antenna cable and converter are not supplied.

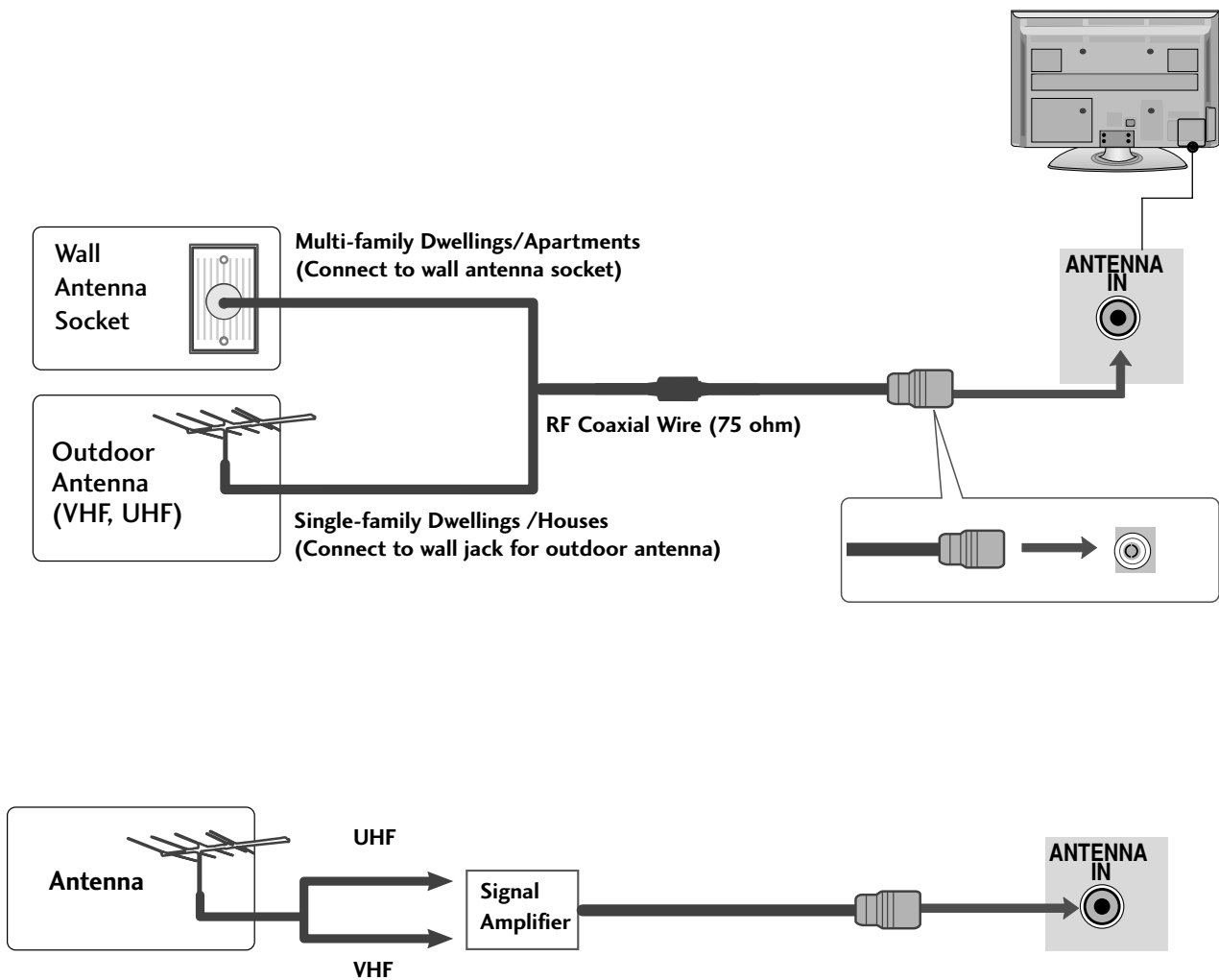

- In poor signal areas, to achieve better picture quality it may be necessary to install a signal amplifier to the antenna as shown above.
- If signal needs to be split for two TVs, use an antenna signal splitter for connection.

EXTERNAL EQUIPMENT SETUP

- To avoid damaging any equipment, never plug in any power cords until you have finished connecting all equipment.
- Image shown may differ from your TV.

HD RECEIVER SETUP

Connecting with a component cable

- 1 Connect the video outputs (Y, PB, PR) of the digital set-top box to the **COMPONENT IN VIDEO** jacks on the TV.
- 2 Connect the audio output of the digital set-top box to the **COMPONENT IN AUDIO** jacks on the TV.
- 3 Turn on the digital set-top box.
(Refer to the owner's manual for the digital set-top box.)
- 4 Select **Component** input source using the **INPUT** button on the remote control.

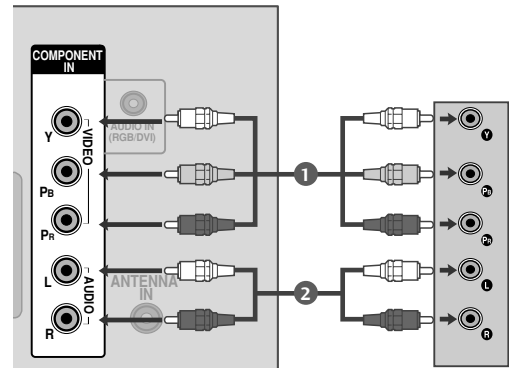

Signal	Component	HDMI
480i/576i	O	X
480p/576p	O	O
720p/1080i	O	O
1080p	O	O
	(Only 50Hz, 60Hz)	(24Hz, 30Hz, 50Hz, 60Hz)

Connecting a set-top box with an HDMI cable

- 1 Connect the HDMI output of the digital set-top box to the **HDMI/DVI IN 1**, **HDMI IN 2** or **HDMI IN 3** (Except 42/50PQ2***, 42/50PQ3***) models jack on the TV.
- 2 Select **HDMI1**, **HDMI2** or **HDMI3** (Except 42/50PQ2***, 42/50PQ3***) input source using the **INPUT** button on the remote control.
- 3 Turn on the digital set-top box.
(Refer to the owner's manual for the digital set-top box.)

! NOTE

- ▶ Check your HDMI cable is over version 1.3.
If the HDMI cables don't support HDMI version 1.3, it can cause flickers or no screen display. In this case use the latest cables that support HDMI version 1.3.

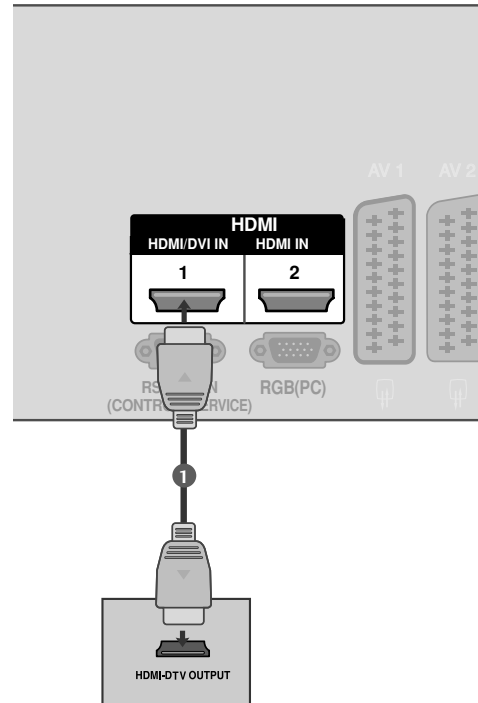

EXTERNAL EQUIPMENT SETUP

Connecting with a HDMI to DVI cable

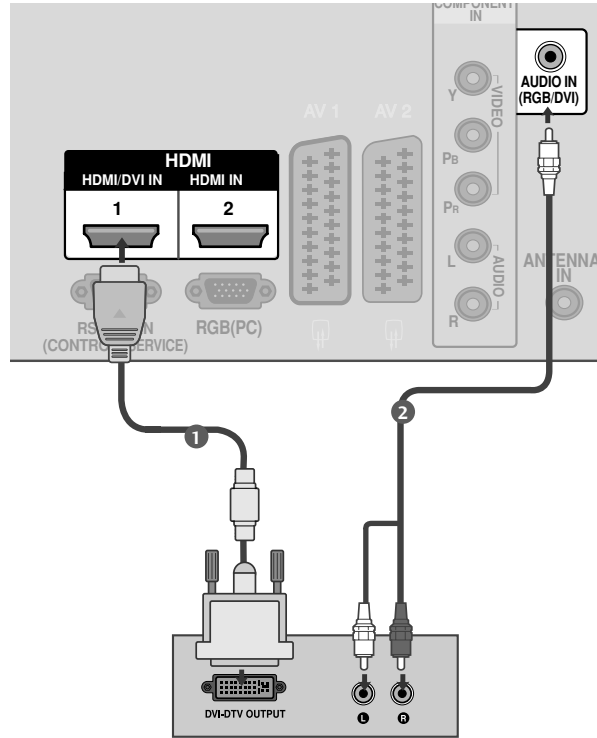

- 1 Connect the DVI output of the digital set-top box to the **HDMI/DVI IN 1** jack on the TV.
.....
- 2 Connect the audio output of the digital set-top box to the **AUDIO IN(RGB/DVI)** jack on the TV.
.....
- 3 Turn on the digital set-top box. (Refer to the owner's manual for the digital set-top box.)
.....
- 4 Select **HDMI1** input source using the **INPUT** button on the remote control.

DVD SETUP

Connecting with a component cable

- 1 Connect the video outputs (Y, Pb, Pr) of the DVD to the **COMPONENT IN VIDEO** jacks on the TV.
- 2 Connect the audio outputs of the DVD to the **COMPONENT IN AUDIO** jacks on the TV.
- 3 Turn on the DVD player, insert a DVD.
- 4 Select **Component** input source using the **INPUT** button on the remote control.
- 5 Refer to the DVD player's manual for operating instructions.

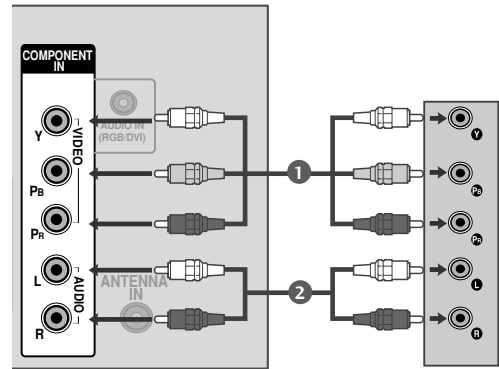

Component Input ports

To achieve better picture quality, connect a DVD player to the component input ports as shown below.

Component ports on the TV	Y	Pb	Pr
Video output ports on DVD player	Y	Pb	Pr
	Y	B-Y	R-Y
	Y	Cb	Cr
	Y	Pb	Pr

EXTERNAL EQUIPMENT SETUP

When connecting with a Euro Scart

- 1 Connect the Euro scart socket of the DVD to the **AV1** Euro scart socket on the set.
- 2 Turn on the DVD player, insert a DVD.
- 3 Select **AV1** input source with using the **INPUT** button on the remote control.
If connected to **AV2** Euro scart socket, select **AV2** input source.
- 4 Refer to the DVD player's manual for operating instructions.

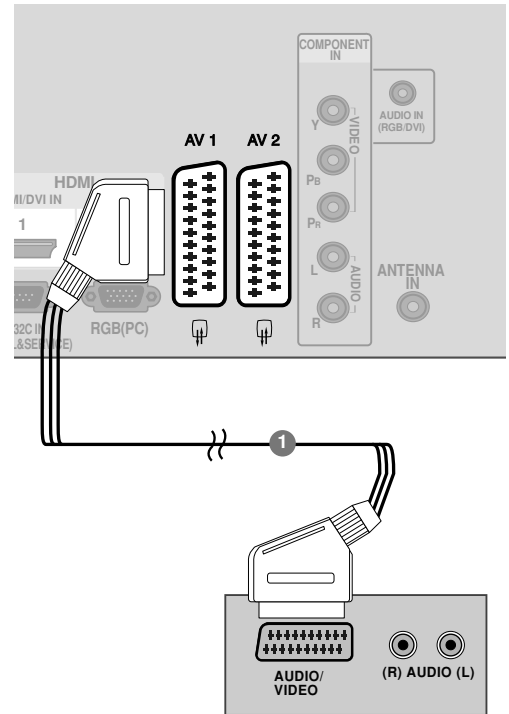

Scart	Input			Output
	Video	Audio	RGB	Video, Audio
AV1	O	O	O	ATV only
AV2	O	O	X	ATV output is available.

Current input mode \ Output Type	AV1 (TV Out)	AV2 (Monitor Out)
Analogue TV	O	O
AV1/2/3	O	O
Component/RGB/HDMI	O	X

► **TV Out** : Outputs analog TV signals.
Monitor Out: Outputs the current screen image.

! NOTE

- Any Euro scart cable used must be signal shielded.

Connecting the HDMI cable

- 1 Connect the HDMI output of the DVD to the **HDMI/DVI IN 1**, **HDMI IN 2** or **HDMI IN 3** (Except 42/50PQ2***, 42/50PQ3***) jack on the TV.
- 2 Select **HDMI1**, **HDMI2** or **HDMI3** (Except 42/50PQ2***, 42/50PQ3***) input source using the **INPUT** button on the remote control.
- 3 Refer to the DVD player's manual for operating instructions.

! NOTE

- ▶ The TV can receive video and audio signals simultaneously when using a HDMI cable.
- ▶ If the DVD does not support Auto HDMI, you must set the output resolution appropriately.
- ▶ Check HDMI cable over version 1.3.

If the HDMI cables don't support HDMI version 1.3, it can cause flickers or no screen display. In this case use the latest cables that support HDMI version 1.3.

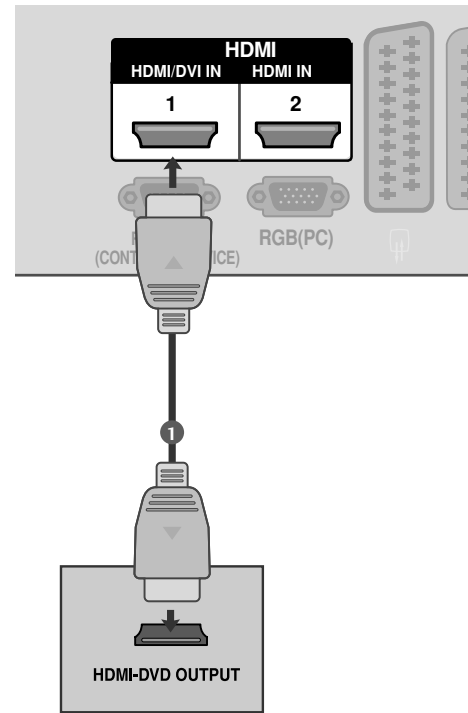

EXTERNAL EQUIPMENT SETUP

VCR SETUP

- To avoid picture noise (interference), allow adequate distance between the VCR and TV.

Connecting with a RF cable

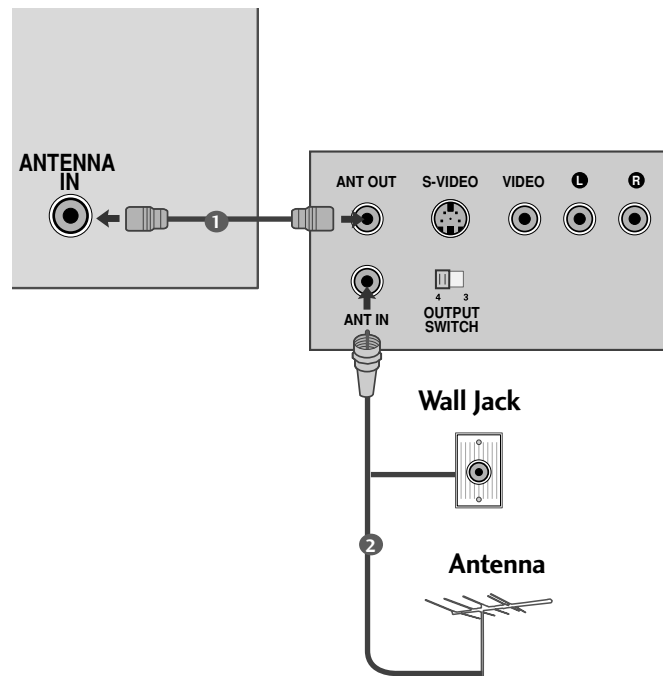

- 1 Connect the **ANT OUT** socket of the VCR to the **ANTENNA IN** socket on the TV.
.....
- 2 Connect the antenna cable to the **ANT IN** socket of the VCR.
.....
- 3 Press the **PLAY** button on the VCR and match the appropriate programme between the TV and VCR for viewing.
.....

When connecting with a Euro Scart

- 1 Connect the Euro scart socket of the VCR to the **AV1** Euro scart socket on the set.
- 2 Insert a video tape into the VCR and press **PLAY** on the VCR. (Refer to the VCR owner's manual.)
- 3 Select **AV1** input source with using the **INPUT** button on the remote control.

If connected to **AV2** Euro scart socket, select **AV2** input source.

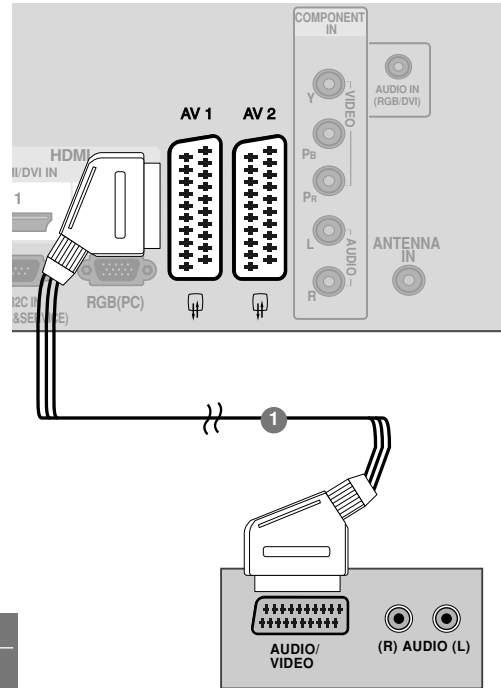

Scart	Input			Output
	Video	Audio	RGB	Video, Audio
AV1	O	O	O	ATV only
AV2	O	O	X	ATV output is available.

Current input mode \ Output Type	AV1 (TV Out)	AV2 (Monitor Out)
Analogue TV	O	O
AV1/2/3	O	O
Component/RGB/HDMI	O	X

► **TV Out** : Outputs analog TV signals.
Monitor Out: Outputs the current screen image.

! NOTE

- Any Euro scart cable used must be signal shielded.

EXTERNAL EQUIPMENT SETUP

When connecting with a RCA cable

- 1 Connect the **AUDIO/VIDEO** jacks between TV and VCR. Match the jack colours (Video = yellow, Audio Left = white, and Audio Right = red)
- 2 Insert a video tape into the VCR and press **PLAY** on the VCR. (Refer to the VCR owner's manual.)
- 3 Select **AV3** input source using the **INPUT** button on the remote control.

! NOTE

- ▶ If you have a mono VCR, connect the audio cable from the VCR to the **AUDIO L/MONO** jack of the set.

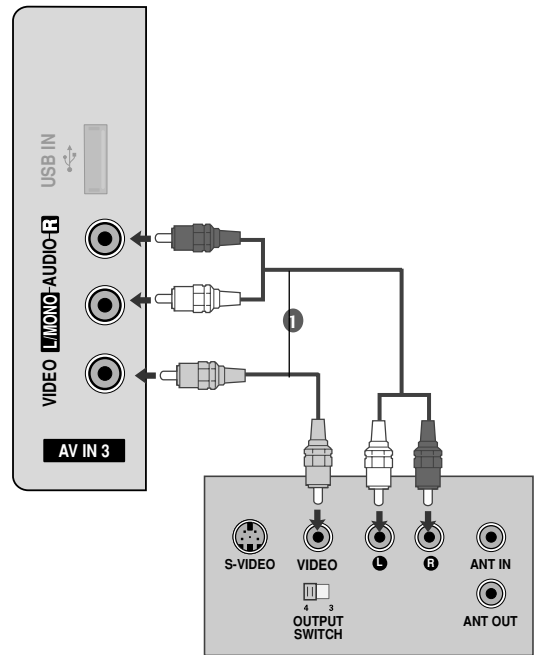

OTHER A/V SOURCE SETUP

- 1 Connect the **AUDIO/VIDEO** jacks between TV and external equipment. Match the jack colours. (Video = yellow, Audio Left = white, and Audio Right = red)
- 2 Select **AV3** input source using the **INPUT** button on the remote control.
- 3 Operate the corresponding external equipment. Refer to external equipment operating guide.

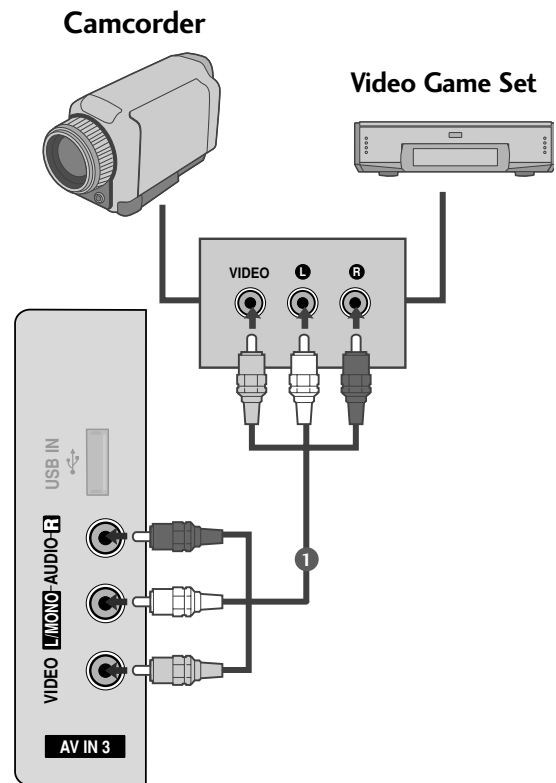

USB IN SETUP (Except 42/50PQ2***)

- Image shown may differ from your TV.

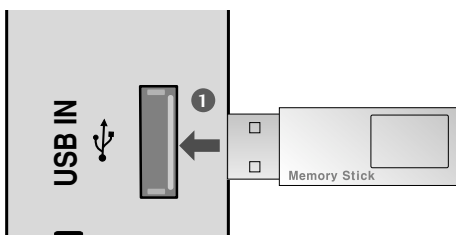

- 1 Connect the USB device to the **USB IN** jacks on the side of TV.
- 2 After connecting the **USB IN** jacks, you use the **USB** function. (► p. 50)

EXTERNAL EQUIPMENT SETUP

PC SETUP

This TV provides Plug and Play capability, meaning that the PC adjusts automatically to the TV's settings.

Connecting with a D-sub 15 pin cable

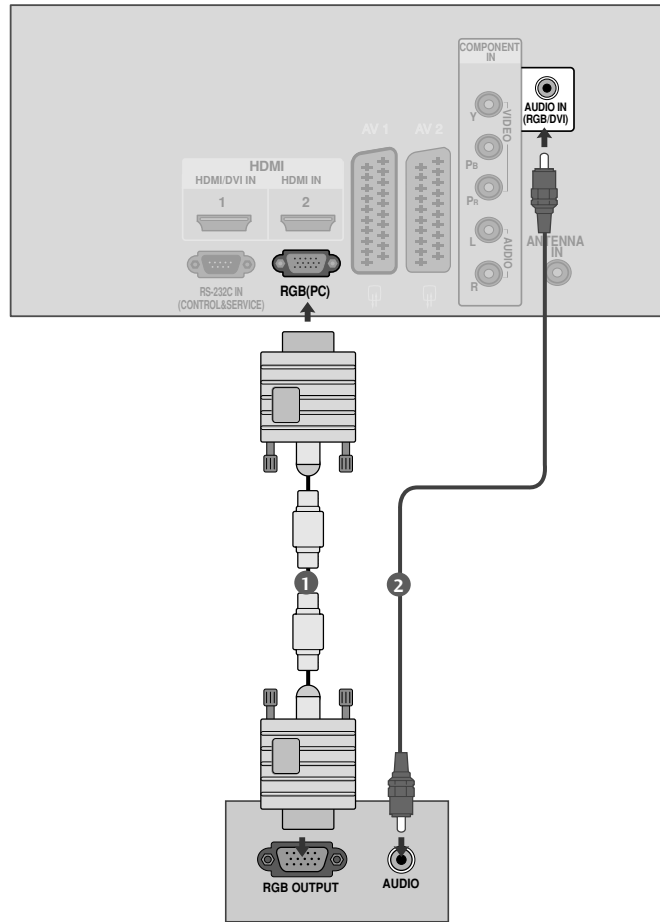

- 1 Connect the RGB output of the PC to the **RGB (PC)** jack on the TV.
.....
- 2 Connect the PC audio output to the **AUDIO IN (RGB/DVI)** jack on the TV.
.....
- 3 Turn on the TV and the PC.
.....
- 4 Select **RGB** input source using the **INPUT** button on the remote control.

Supported Display Resolution

RGB-PC mode

Resolution	Horizontal Frequency(kHz)	Vertical Frequency(Hz)
640x350	31.468	70.09
720x400	31.469	70.09
640x480	31.469	59.94
800x600	37.879	60.317
1024x768	48.363	60.004
1280x768	47.776	59.87
1360x768	47.720	59.799

Except 42PQ2***, 42PQ3***, 42PQ6***

HDMI-DTV mode

Resolution	Horizontal Frequency(kHz)	Vertical Frequency(Hz)
720x480	31.47	59.94
	31.50	60.00
720x576	31.25	50.00
1280x720	44.96	59.94
	45.00	60.00
	37.50	50.00
1920x1080	33.72	59.94
	33.75	60.00
	28.125	50.00
	67.432	59.94
	67.5	60
	56.250	50
	27	24
	33.75	30

! NOTE

- ▶ Avoid keeping a fixed image on the TV's screen for prolonged periods of time. The fixed image may become permanently imprinted on the screen; use a screen saver when possible.
- ▶ There may be interference relating to resolution, vertical pattern, contrast or brightness in PC mode. Change the PC mode to another resolution or change the refresh rate to another rate or adjust the brightness and contrast on the menu until the picture is clear. If the refresh rate of the PC graphic card can not be changed, change the PC graphic card or consult the manufacturer of the PC graphic card.
- ▶ The synchronization input waveform for Horizontal and Vertical frequencies are separate.
- ▶ We recommend using 1024 x 768, 60Hz (42PQ2***, 42PQ3***, 42PQ6*** XGA)/1360 x 768, 60Hz(50PQ2***, 50PQ3***, 50PQ6*** WXGA) for the PC mode, this should provide the best picture quality.
- ▶ If the resolution of PC is over SXGA, there will be no picture on the TV. (Only HD Models)
- ▶ Connect the audio cable from the PC to the Audio input on the TV. (Audio cables are not included with the TV).
- ▶ If you use too long an RGB-PC cable, there may be interference on the screen. We recommend using under 5m of the cable. This provides the best picture quality.

EXTERNAL EQUIPMENT SETUP







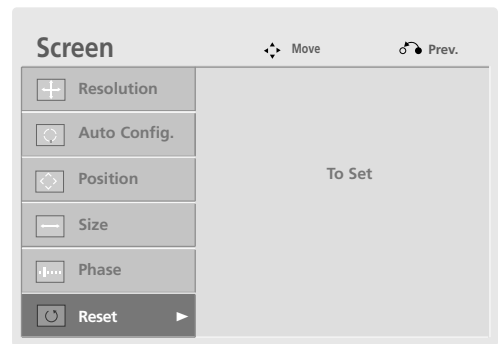
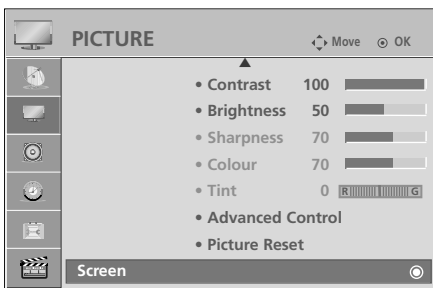

Screen Setup for PC mode

Screen Reset

Returns Position, Size and Phase to the factory default settings.

This function works in the following mode: Component(except 480i, 576i), RGB



- 1   Select **PICTURE**.
- 2   Select **Screen**.
- 3   Select **Reset**.
- 4   Select **Yes**.
- 5  Run **Reset**.







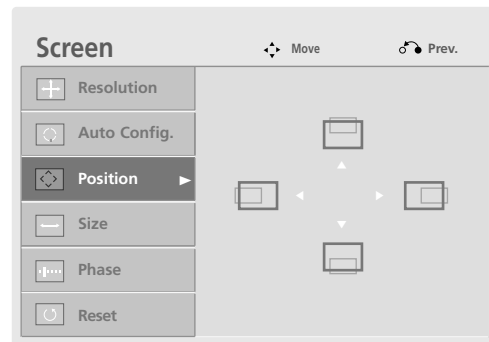
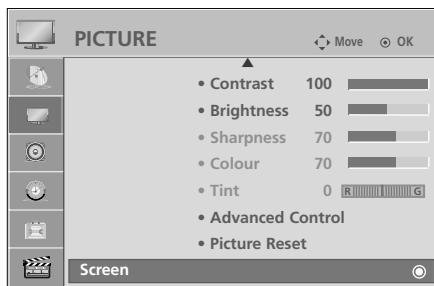

- Press the **MENU** button to return to normal TV viewing.
- Press the **RETURN** button to move to the previous menu screen.

Adjustment for screen Position, Size, Phase

If the picture is not clear after auto adjustment and especially if characters are still trembling, adjust the picture phase manually.

Position operates in Component(except 480i, 576i), RGB mode.
Size, Phase operate only in RGB mode.



- 1   Select **PICTURE**.
- 2   Select **Screen**.
- 3   Select **Position, Size or Phase**.
- 4    Make appropriate adjustments.

- Press the **MENU** button to return to normal TV viewing.
- Press the **RETURN** button to move to the previous menu screen.







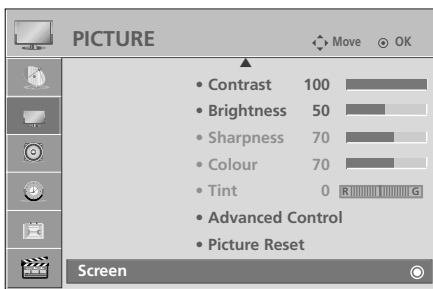

EXTERNAL EQUIPMENT SETUP

Selecting Resolution (Except 42PQ2***, 42PQ3***, 42PQ6***)

To view a normal picture, match the resolution of RGB mode and selection of PC mode.

This function works in the following mode: RGB[PC]



- 1   Select **PICTURE**.
- 2   Select **Screen**.
- 3   Select **Resolution**.
- 4   Select the desired resolution.

- Press the **MENU** button to return to normal TV viewing.
- Press the **RETURN** button to move to the previous menu screen.

Auto Configure (RGB [PC] mode only)

Automatically adjust the picture position and minimizes image instability. After adjustment, if the image is still not correct, your TV is functioning properly but needs further adjustment.

Auto configure

This function is for automatic adjustment of the screen position, size and phase. The displayed image will be unstable for a few seconds while the auto configuration is in progress.

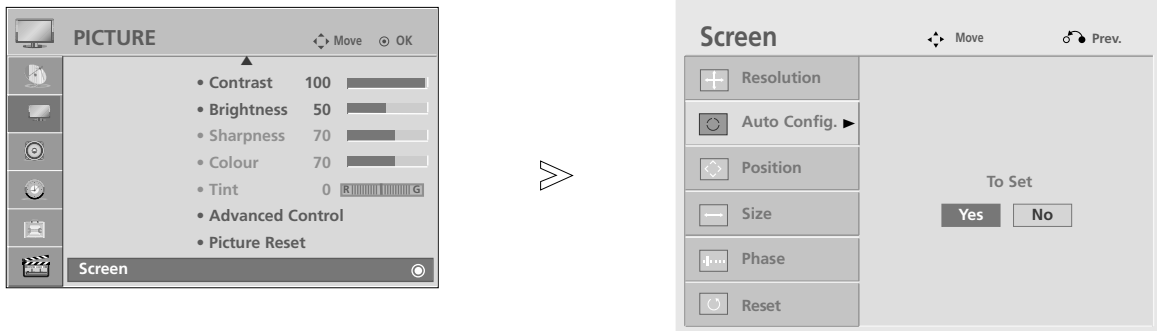

1   Select **PICTURE**.

2   Select **Screen**.

3   Select **Auto Config..**

4   Select **Yes**.

5  Run **Auto Config..**

- If the position of the image is still not correct, try Auto adjustment again.
- If picture needs to be adjusted again after Auto adjustment in RGB (PC), you can adjust the **Position, Size or Phase**.

- Press the **MENU** button to return to normal TV viewing.
- Press the **RETURN** button to move to the previous menu screen.

WATCHING TV / PROGRAMME CONTROL

REMOTE CONTROL KEY FUNCTIONS (EXCEPT 42/50PQ6***)

When using the remote control, aim it at the remote control sensor on the TV.

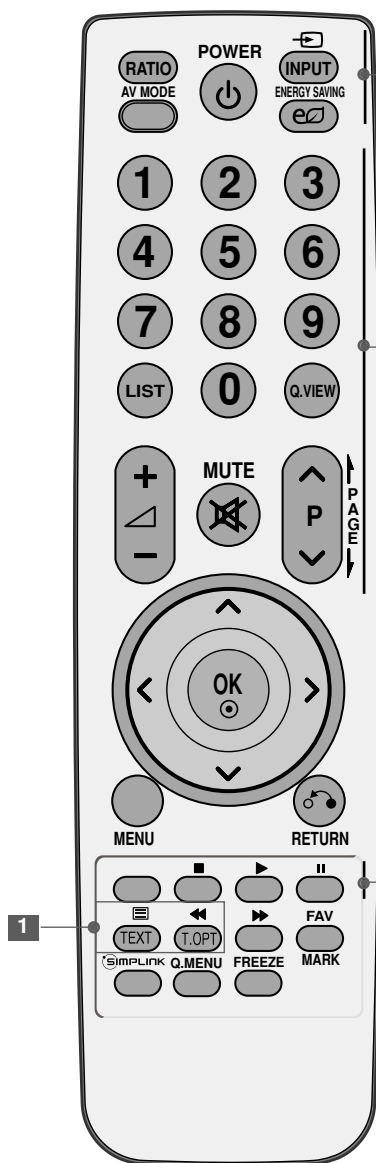

RATIO Selects your desired picture format.

AV MODE It helps you select and set images and sounds when connecting AV devices. (▶ p. 47)

POWER Switches the TV on from standby or off to standby.

INPUT External input mode rotate in regular sequence. Switches the TV on from standby.

ENERGY SAVING Adjust the power saving mode of the TV.

0~9 number button Selects a programme.
Selects numbered items in a menu.

LIST Displays the programme table.

Q.VIEW Returns to the previously viewed programme.

VOLUME UP /DOWN Adjusts the volume.

MUTE Switches the sound on or off.

Programme UP/DOWN Selects a programme.

PAGE UP/DOWN Move from one full set of screen information to the next one.

1 TELETEXT BUTTONS These buttons are used for teletext. For further details, see the 'Teletext' section. (▶ p. 90)

Coloured buttons These buttons are used for teletext (on **TELETEXT** models only) , **Programme edit**.

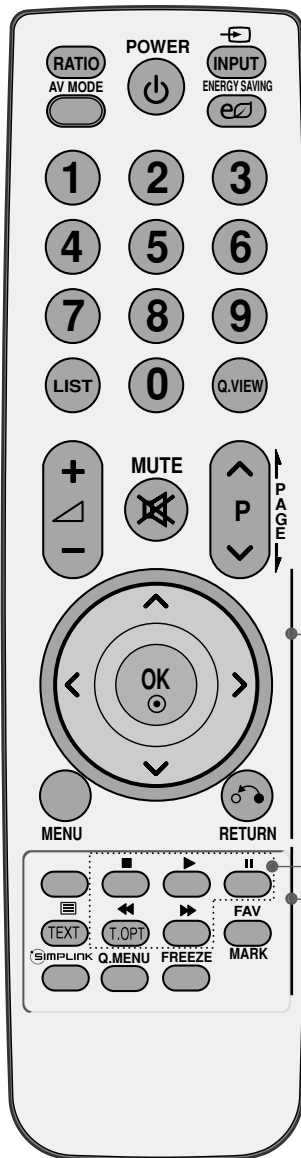

THUMBSTICK Allows you to navigate the on-screen menus and adjust the system settings to your preference. (Up/Down/Left/Right)

OK Accepts your selection or displays the current mode.

MENU Selects a menu. Clears all on-screen displays and returns to TV viewing from any menu.

RETURN Allows the user to move return one step in an interactive application or other user interaction function.

2 SIMPLINK / USB Menu control buttons Controls SIMPLINK or USB menu.

FAV Displays the selected favourite programme.

MARK Check and un-check programmes in the USB menu. (Except 42/50PQ2***)

SIMPLINK See a list of AV devices connected to TV. When you toggle this button, the Simplink menu appears at the screen. (► p. 43)

Q. MENU Select the desired quick menu source. (► p. 33)

FREEZE Pause the present picture at the screen. (It doesn't work at USB Mode.) The TV returns to normal viewing automatically if no signal is received or no operation is performed for 5 minutes.

Installing Batteries

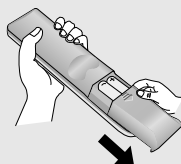

- Open the battery compartment cover on the back and install the batteries matching correct polarity (+with +,-with -).
- Install two 1.5V AAA batteries. Do not mix old or used batteries with new ones.
- Close cover.

WATCHING TV / PROGRAMME CONTROL

REMOTE CONTROL KEY FUNCTIONS (Only 42/50PQ6***)

When using the remote control, aim it at the remote control sensor on the TV.



- ENERGY SAVING** Adjust the power saving mode of the TV.

RATIO Selects your desired picture format.

POWER Switches the TV on from standby or off to standby.

SIMPLINK See a list of AV devices connected to TV. When you toggle this button, the Simplink menu appears at the screen. (▶ p. 43)

INPUT External input mode rotate in regular sequence. Switches the TV on from standby.
- Q. MENU** Select the desired quick menu source. (▶ p. 33)

MENU Selects a menu. Clears all on-screen displays and returns to TV viewing from any menu.

FREEZE Pause the present picture at the screen. (It doesn't work at USB Mode.) The TV returns to normal viewing automatically if no signal is received or no operation is performed for 5 minutes.
- THUMBSTICK** Allows you to navigate the on-screen menus and adjust the system settings to your preference. (Up/Down/Left/Right)

OK Accepts your selection or displays the current mode.
- RETURN** Allows the user to move return one step in an interactive application or other user interaction function.

SLEEP Sets the sleep timer.

AV MODE It helps you select and set images and sounds when connecting AV devices. (▶ p.47)
- Coloured buttons** These buttons are used for teletext (on **TELETEXT** models only) , **Programme edit**.

1 TELETEXT BUTTONS These buttons are used for teletext. For further details, see the 'Teletext' section. (▶ p.90)



VOLUME UP /DOWN Adjusts the volume.

MARK Check and un-check programmes in the USB menu.

FAV Displays the selected favourite programme.

MUTE Switches the sound on or off.

Programme UP/DOWN Selects a programme.

PAGE UP/DOWN Move from one full set of screen information to the next one.

0~9 number button Selects a programme.
Selects numbered items in a menu.

LIST Displays the programme table.

Q.VIEW Returns to the previously viewed programme.

SIMPLINK / USB Menu control buttons Controls SIMPLINK or USB menu.

Installing Batteries

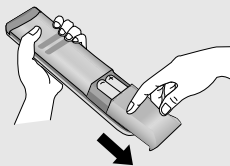

- Open the battery compartment cover on the back and install the batteries matching correct polarity (+with +,-with -).
- Install two 1.5V AAA batteries. Do not mix old or used batteries with new ones.
- Close cover.

WATCHING TV / PROGRAMME CONTROL

TURNING ON THE TV

- When your TV is turned on, you will be able to use its features.

- 1 Firstly, connect the power cord correctly.
At this stage, the TV switches to standby mode.
- 2 In standby mode to turn TV on, press the **INPUT** or **P ▲ ▼** button on the TV or press the **POWER**, **INPUT**, **P ^ v** or **NUMBER** button on the remote control and the TV will switch on.

Initializing Guide

If the OSD (On Screen Display) is displayed on the screen after turning on the TV, you can adjust the **Language, Mode Setting, Country, Auto Tuning**.

Note:

- a. If you close without completing the initial setting, the Initial Setting menu can be displayed again.
- b. "Store Demo" mode is only for shop display and not for general customer use.
- c. "Home Use" mode is the optimal setting for home environments, and is the TV's default mode.
- d. "Store Demo" mode is the optimal setting for store environments. If a user modifies image quality data, "Store Demo" mode initializes the product to the image quality set by us after a certain period of time.
- e. The mode (Home Use, Store Demo) can be changed by executing Mode Setting in the OPTION menu.

PROGRAMME SELECTION

- 1 Press the **P ^ v** or **NUMBER** buttons to select a programme number.

VOLUME ADJUSTMENT

- 1 Press the **▲ +** or **-** button to adjust the volume.

If you wish to switch the sound off, press the **MUTE** button.





You can cancel this function by pressing the **MUTE**, **▲ +** or **-**, **AV Mode** button.

QUICK MENU

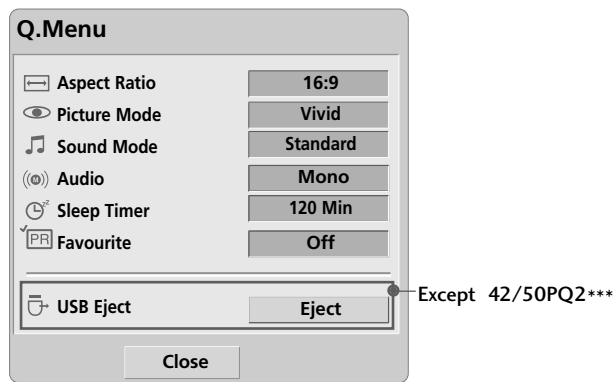
Your TV's OSD (On Screen Display) may differ slightly from that shown in this manual. Q.Menu (Quick Menu) is a menu of features which users might use frequently.

- **Aspect Ratio**: Selects your desired picture format.
For Zoom Setting, select 16:9, Original, 4:3, 14:9, Zoom et Cinema Zoom1 in Ratio Menu. After completing Zoom Setting, the display goes back to Q.Menu.
- **Picture Mode** : Selects your desired Picture Mode.
- **Sound Mode** : It is a feature to automatically set the sound combination which it deems the best for the images being watched. Selects your desired Sound Mode.
- **Audio** : Selects the sound output.
- **Sleep Timer** : Sets the sleep timer.
- **Favourite** : Selects the favourite programme.
- **USB Eject** : Selects "USB Eject" in order to eject USB device. (Except 42/50PQ2***)



1.   Display each menu.
2.  Select your desired Source.
3. 

- Press the **Q.MENU** button to return to normal TV viewing.





WATCHING TV / PROGRAMME CONTROL

ON SCREEN MENUS SELECTION AND ADJUSTMENT

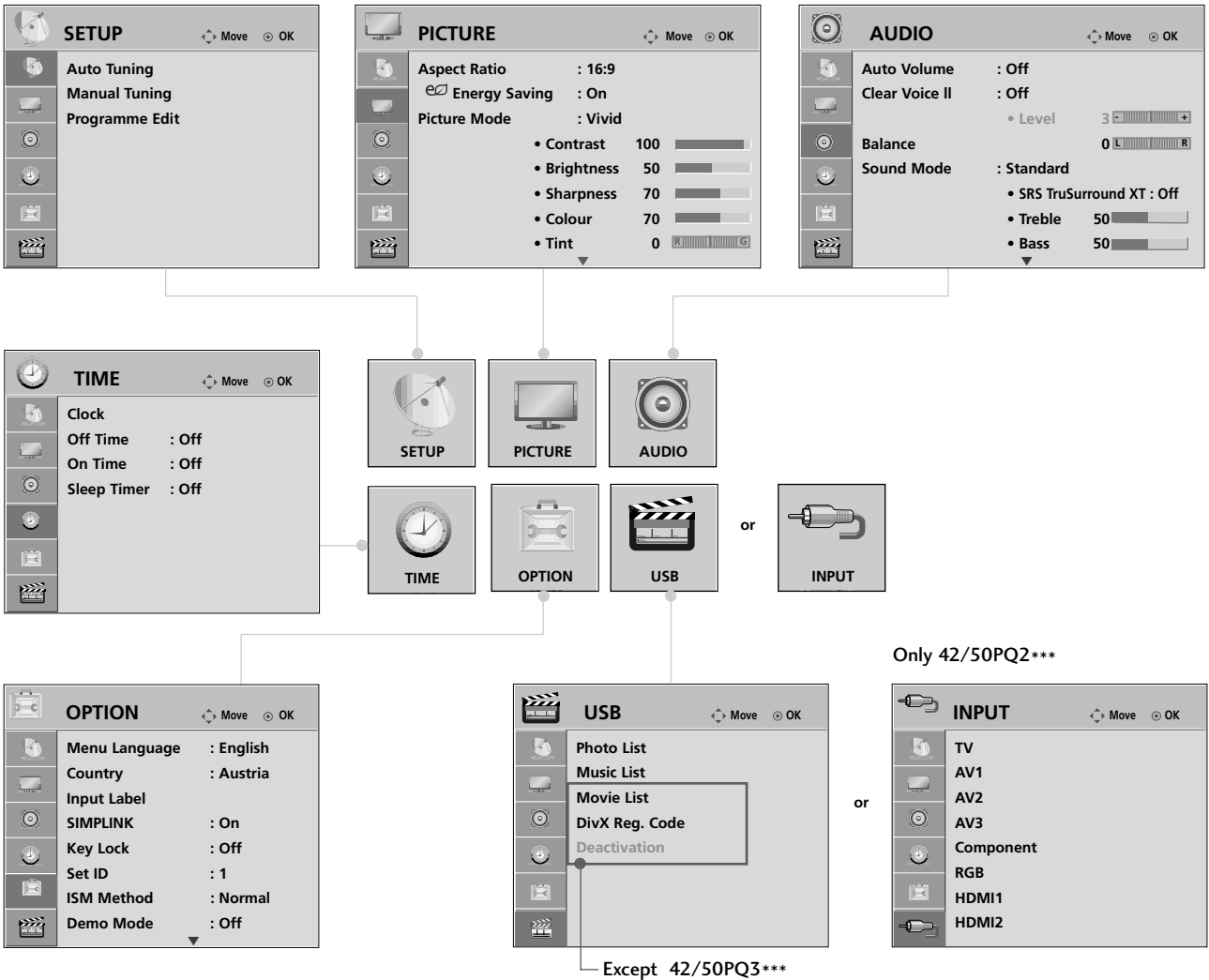
Your TV's OSD (On Screen Display) may differ slightly from that shown in this manual.

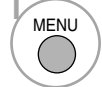
■ Image shown may differ from your TV.

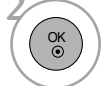

- 1   Display each menu.
- 2   Select a menu item.
- 3  Move to the pop up menu.







- Press the **MENU** button to return to normal TV viewing.
- Press the **RETURN** button to move to the previous menu screen.

AUTO PROGRAMME TUNING

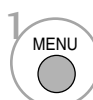
Use this to automatically find and store all available programmes.

When you start auto programming, all previously stored service information will be deleted.



-   Select **SETUP**.
-   Select **Auto Tuning**.
-   Select **Yes**.
-  Run **Auto tuning**.

• If you wish to keep on auto tuning select **Yes** using the < > button. Then, press the OK button. Otherwise select **No**.

- Press the **MENU** button to return to normal TV viewing.
- Press the **RETURN** button to move to the previous menu screen.

WATCHING TV / PROGRAMME CONTROL

MANUAL PROGRAMME TUNING

Manual Tuning lets you manually tune and arrange the stations in whatever order you desire.

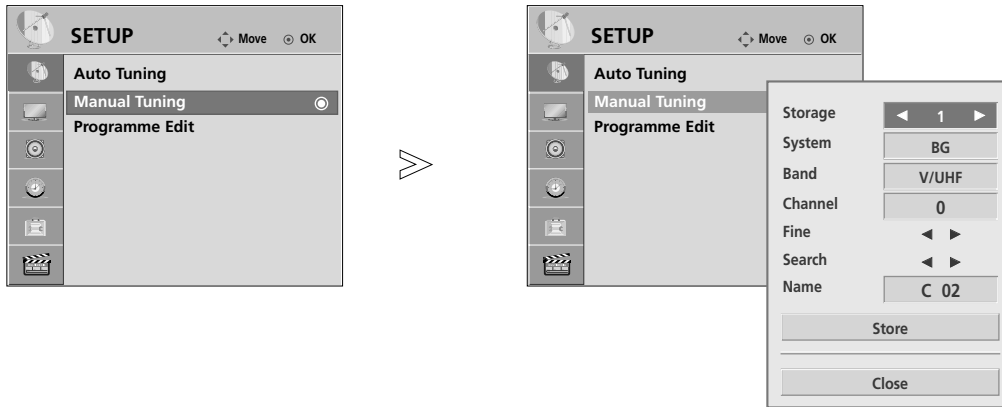

- 1 Select **SETUP**.
- 2 Select **Manual Tuning**.
- 3 or Select the desired programme number on.
- 4 Select a TV system.
- 5 Select **V/UHF** or **Cable**.
- 6 or Select the desired channel number.
- 7 Commence searching.
- 8 Select **Store**.
- 9

- Press the **MENU** button to return to normal TV viewing.
- Press the **RETURN** button to move to the previous menu screen.

- BG : PAL B/G, SECAM B/G (Europe / East Europe / Asia / NewZealand / M.East / Africa / Australia)
- I : PAL I/II (U.K. / Ireland / Hong Kong / South Africa)
- DK : PAL D/K, SECAM D/K (East Europe / China / Africa / CIS)
- To store another channel, repeat steps 3 to 8.

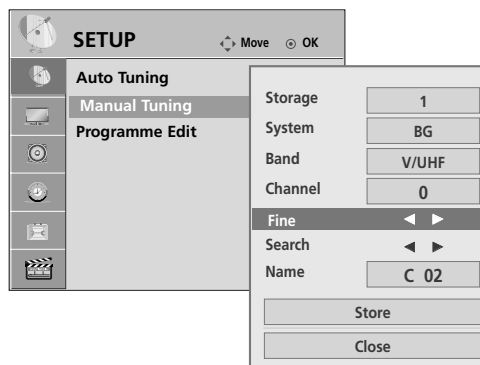
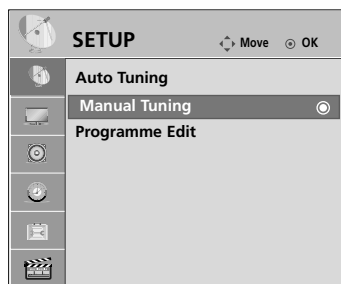

■ Assigning a station name

You can assign a station name with five characters to each programme number.

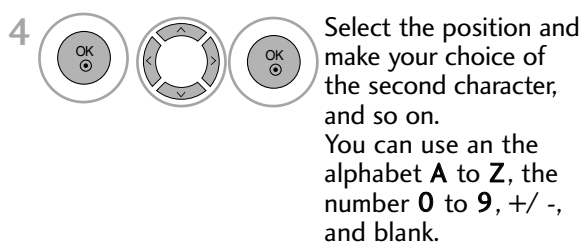

■ Fine Tuning

Normally fine tuning is only necessary if reception is poor.

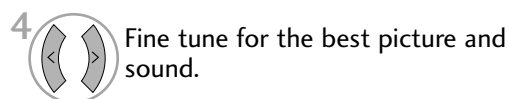

- Press the **MENU** button to return to normal TV viewing.
- Press the **RETURN** button to move to the previous menu screen.

WATCHING TV / PROGRAMME CONTROL





PROGRAMME EDIT

When a programme number is skipped, it means that you will be unable to select it using P ^ ∨ button during TV viewing.

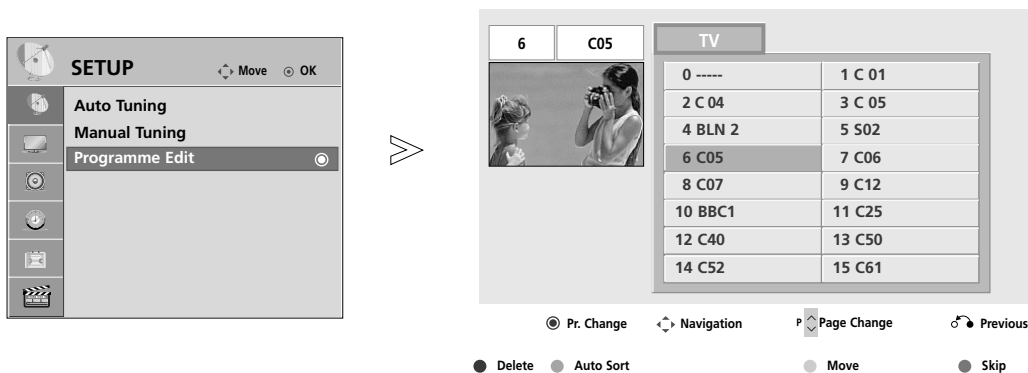
If you wish to select the skipped programme, directly enter the programme number with the NUMBER buttons or select it in the Programme edit menu.

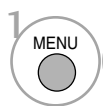
This function enables you to skip the stored programmes.

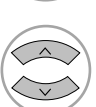
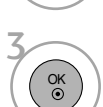

-   Select **SETUP**.
-   Select **Programme Edit**.
-  Enter the **Programme Edit**.
-  Select a programme to be stored or skipped.

- Press the **MENU** button to return to normal TV viewing.
- Press the **RETURN** button to move to the previous menu screen.

This function enables you to delete or skip the stored programmes.
You can also move some channels and use other programme numbers.

■ Deleting a programme



Select a programme number to be deleted.

- The selected programme is deleted, all the following programmes are shifted up one position.



Turn the deleted programme number to RED.



Release the deleted programme.

■ Auto sorting a programme



Start Auto Sort.

- After activating Auto Sort once, you can no longer edit programmes.

■ Moving a programme

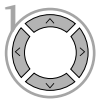

Select a programme number to be moved.



Turn the moved programme number to YELLOW.



Release the moved programme.

■ Skipping a programme number



Select a programme number to be skipped.



Turn the skipped programme number to BLUE.



Release the skipped programme.

- When a programme number is skipped it means that you will be unable to select it using the P ^ v button during normal TV viewing.
- If you wish to select the skipped programme, directly enter the programme number with the NUMBER buttons or select it in the programme edit or table menu.

WATCHING TV / PROGRAMME CONTROL

SELECTING THE PROGRAMME LIST

You can check which programmes are stored in the memory by displaying the programme list.





■ Displaying programme list

- 1  Display the Programme List.

- You may find some blue programmes. These have been set up to be skipped by auto programming or in the programme edit mode.
- Some programmes with the channel number shown in the programme list indicate there is no station name assigned.

■ Selecting a programme in the programme list

- 1  Select a programme.
- 2  Switch to the chosen programme number.

■ Paging through a programme list

- 1  Turn the pages.
- 2  Return to normal TV viewing.

FAVOURITE PROGRAMME SETUP

■ Selecting favourite programme

Favorite programmes is a convenient feature that lets you quickly scan up to programmes of your choice without having to wait for the TV to scan through all the in-between programmes.

To tune to a favorite programme, press the **FAV**(Favorite)button repeatedly.

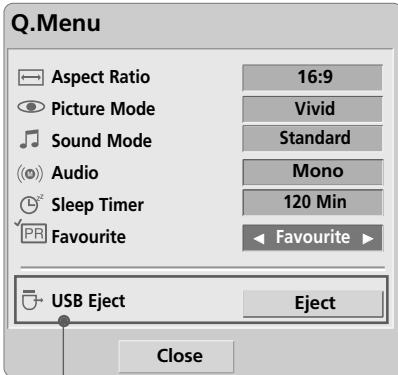

Except 42/50PQ2***

- 1 or Select your desired programme.
- 2 Select **Favourite**.
- 3 Select **Favourite**.
- 4 Return to TV viewing.

- This will automatically include the selected programme into your favourite programme list.

■ Displaying the favourite programme list



- 1 Display the Favourite Programme List.

WATCHING TV / PROGRAMME CONTROL

INPUT LIST

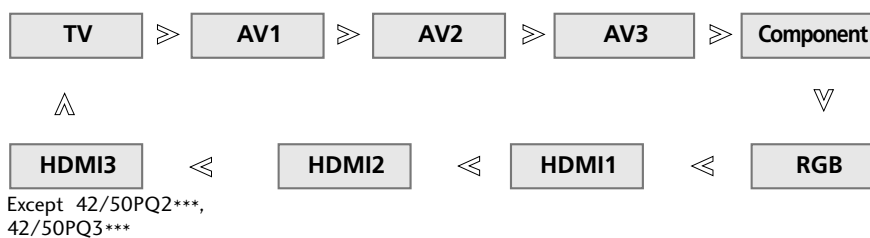

- You can also adjust **INPUT** menu. (Only 42/50PQ2***)

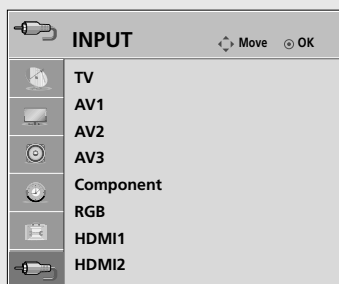

- **TV** : Select it when watching the TV.
- **AV** : Select it when watching the VCR or external equipment.
- **Component** : Select it when using DVD or Digital set-top box depends on connector.
- **RGB** : Select it when using PC depends on connector.
- **HDMI** : Select it when using DVD or Digital set-top box depend on connector.









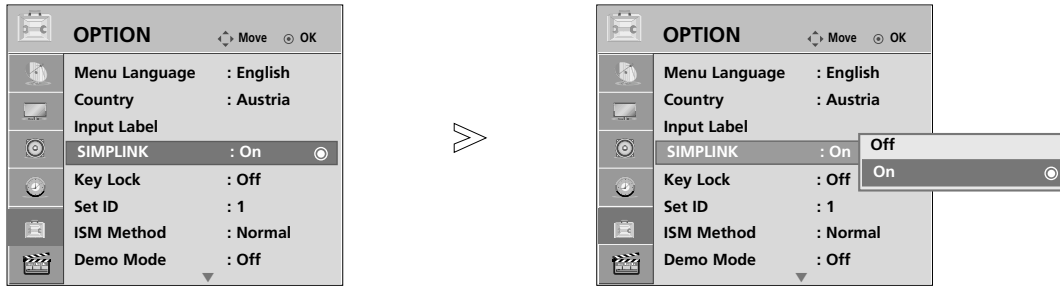

This function operates only with devices with the SIMPLINK logo.
Please check the SIMPLINK logo.

The product might not function properly when using it with other products with HDMI-CEC function.

This allows you to control and play other AV devices connected to the display through HDMI cable without additional cables and settings.

If you do not require the SIMPLINK menu, select "Off".



- 1   Select **OPTION**.
- 2   Select **SIMPLINK**.
- 3   Select **On** or **Off**.
- 4  Save.

- Press the **MENU** button to return to normal TV viewing.
- Press the **RETURN** button to move to the previous menu screen.

WATCHING TV / PROGRAMME CONTROL

SIMPLINK Functions

Disc playback

Control connected AV devices by pressing the $\wedge / \vee / < / >$, OK, \blacktriangleright , \blacksquare , $| |$, \blacktriangleleft and \blacktriangleright buttons.

Direct Play

After connecting AV devices to the TV, you can directly control the devices and play media without additional settings.

Select AV device

Enables you to select one of the AV devices connected to the TV and operate it.

Power off all devices

When you switch off the TV, all connected devices are turned off.

Switch audio-out

Offers an easy way to switch audio-out.

-Sync Power on : When the equipment with Simplink function connected HDMI terminal starts to play, The TV will change automatically to turn on mode.

*** A device, which is connected to the TV through a HDMI cable but does not support SIMPLINK, does not provide this function.**

Note: To operate SIMPLINK, an HDMI cable over Version 1.3 with *CEC function should be used. (*CEC: Consumer Electronics Control).

Connecting to Home Theater with the SIMPLINK logo.

- 1 Connect the **HDMI/DVI IN 1, HDMI IN 2** or **HDMI IN3** (Except 42/50PQ2***, 42/50PQ3***) terminal on the back of the TV and the HDMI output terminal of the Home Theater using HDMI cables.
- 2 Connect the Audio output terminal on the back of the TV and the Audio input terminal of the Home Theater using optical cables.
- 3 Select Home Theater in the Speaker menu by pushing the **SIMPLINK** button.

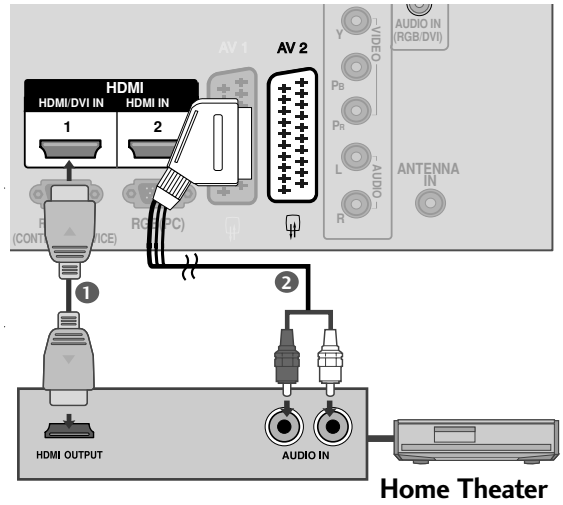

▶ When you select or operate a media device with home theater function, the speaker automatically switches to home theater speaker (HT speaker).

! NOTE

- ▶ Connect the HDMI/DVI IN or HDMI IN terminal of the TV to the rear terminal and Side terminal (HDMI terminal) of the SIMPLINK device with the HDMI cable.
- ▶ When you switch the Input source using the INPUT button on the remote control, you can stop the operation of a device controlled by SIMPLINK.

SIMPLINK Menu

Press the $\wedge \vee < >$ button and then OK button to select the desired SIMPLINK source.

- 1 **TV viewing** : Switch to the previous TV programme regardless of the current mode.
- 2 **DISC playback** : Select and play connected discs. When multiple discs are available, the titles of discs are conveniently displayed at the bottom of the screen.
- 3 **VCR playback** : Play and control the connected VCR.
- 4 **HDD Recordings playback** : Play and control recordings stored in HDD.
- 5 **Audio Out to Home theater/Audio Out to TV:** Select Home theater or TV speaker for Audio Out.

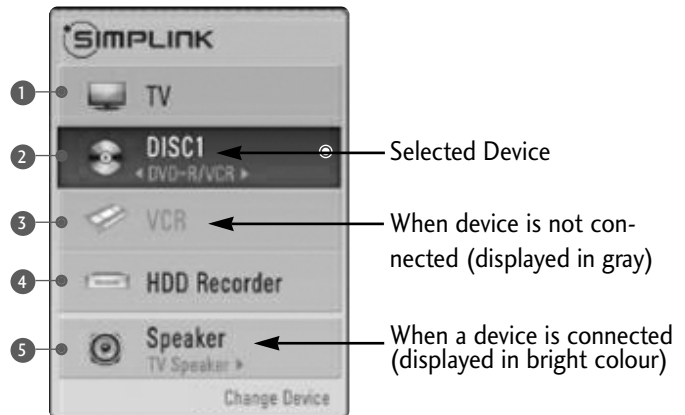





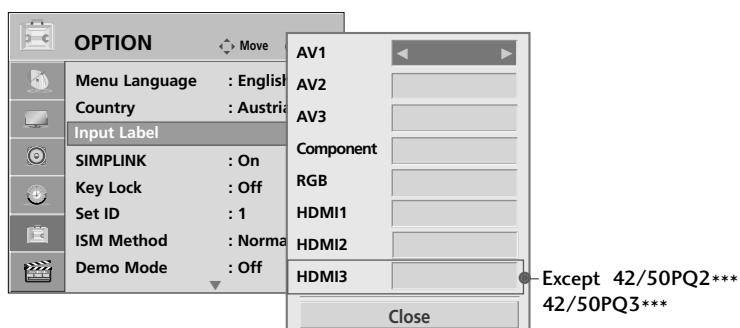

WATCHING TV / PROGRAMME CONTROL

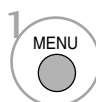
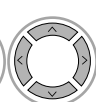
INPUT LABEL

Selects a label for each input source.



- 1   Select **OPTION**.
- 2   Select **Input Label**.
- 3   Select the source.
- 4  Select the label.

- Press the **MENU** button to return to normal TV viewing.
- Press the **RETURN** button to move to the previous menu screen.

AV MODE

You can select the optimal images and sounds when connecting AV devices to external input.

- Off** Disables the AV MODE.
- Cinema** Optimizes video and audio for watching movies.
- Sport** Optimizes video and audio for watching sports events.
- Game** Optimizes video and audio for playing games.

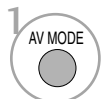
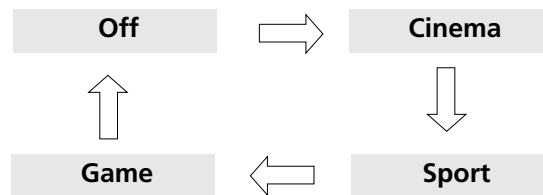

Press the **AV MODE** button repeatedly to select the desired source.



- If you select **Cinema** in AV mode, **Cinema** will be selected both for **Picture Mode** and **Sound Mode** in **PICTURE** menu and **AUDIO** menu respectively.
- If you select "**Off**" in **AV mode**, the picture and image which you initially set will be selected.

- Press the **RETURN** button to return to normal TV viewing.

WATCHING TV / PROGRAMME CONTROL

KEY LOCK

The TV can be set so that the remote control is required to control it.

This feature can be used to prevent unauthorized viewing.

This TV is programmed to remember which option it was last set to even if you turn the TV off.

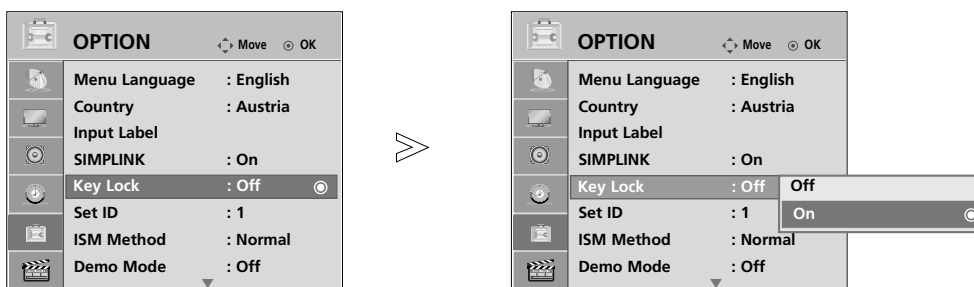

- 1 MENU Select **OPTION**.
- 2 OK Select **Key Lock**.
- 3 OK Select **On** or **Off**.
- 4 OK Save.

- In **Key Lock 'On'**, if the TV is turned off, to turn on the TV, press the **INPUT**, **P ▲** or **▼** (or **P ^ v**) button on the TV or **POWER**, **INPUT**, **P ^ v** or **NUMBER** buttons on the remote control then the set will be turned on.
- With the **Key Lock On**, the display '**x Key Lock On**' appears on the screen if any button on the front panel is pressed while viewing the TV (Except main power (⏻ / I) button).

- Press the **MENU** button to return to normal TV viewing.
- Press the **RETURN** button to move to the previous menu screen.





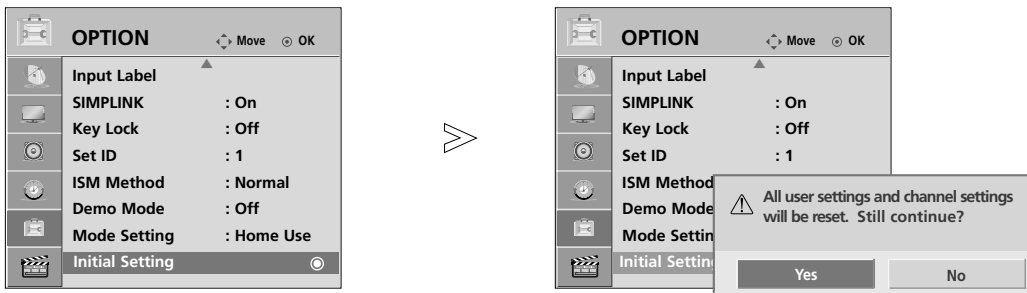

INITIALIZING (RESET TO ORIGINAL FACTORY SETTINGS)

Use to quickly reset all the menu options to their original factory preset values.

This function deletes all TV programmes.

When the **Initial Setting** is completed, you must restart the Initializing setup.



- 1   Select **OPTION**.
- 2   Select **Initial Setting**.
- 3   Select **Yes**.
- 4  Start Initial Setting.

- Press the **MENU** button to return to normal TV viewing.
- Press the **RETURN** button to move to the previous menu screen.

TO USE THE USB DEVICE (Except 42/50PQ2***)

When connecting a USB device

When you connect a USB device, this pop up menu is displayed, automatically.

In USB device, you can not add a new folder or delete the existing folder.

- Here shown may differ from your TV.

- 1 Connect the USB device to the **USB IN** jacks on the side of TV.

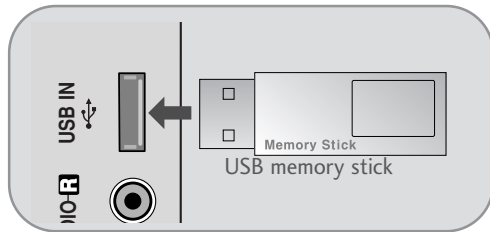

- 2 Select **PHOTO LIST**, **MUSIC LIST** or **MOVIE LIST** (Only 42/50PQ6***).

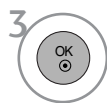

- This TV Supports on JPEG and MP3 and SD Divx. (Only 42/50PQ6***)
- This TV Supports on JPEG and MP3. (Only 42/50PQ3***)

When removing the USB device

Select the USB Eject menu before removing the USB device.



Precautions when using the USB device

- ▶ Only a USB storage device is recognizable.
- ▶ If the USB storage device is connected through a USB hub, the device is not recognizable.
- ▶ A USB storage device using an automatic recognition programme may not be recognized.
- ▶ A USB storage device which uses its own driver may not be recognized.
- ▶ The recognition speed of a USB storage device may depend on each device.
- ▶ Please do not turn off the TV or unplug the USB device when the connected USB storage device is working. When such device is suddenly separated or unplugged, the stored files or the USB storage device may be damaged.
- ▶ Please do not connect the USB storage device which was artificially maneuvered on the PC. The device may cause the product to malfunction or fail to be played. Never forget to use only a USB storage device which has normal music files or image files.
- ▶ Please use only a USB storage device which was formatted as a FAT16, FAT32, NTFS file system provided with the Windows operating system. In case of a storage device formatted as a different utility programme which is not supported by Windows, it may not be recognized.
Data in a USB storage device cannot be deleted in the NTFS file system.
- ▶ Please connect power to a USB storage device which requires an external power supply. If not, the device may not be recognized.
- ▶ Please connect a USB storage device with cable is offered by USB maker. If connected with cable is not offered by USB maker or an excessively long cable, the device may not be recognized.
- ▶ Some USB storage devices may not be supported or operated smoothly.
- ▶ Maximum of 999 files and folders can be recognized.
- ▶ Data in a USB storage device cannot be aligned.
Up to 128 English characters can be recognized as a file name.
- ▶ Please back up the important file because a data of USB device may be damaged. Data management is consumer's responsibility and in consequence the manufactures does not cover the product bearing data damage.
- ▶ If the USB is connected in Standby Mode, specific hard disk will automatically be loaded when the TV is turned on.
- ▶ The recommended capacity is 1 TB or less for a USB external hard disk and 32GB or less for USB memory.
- ▶ TV need more time to detect if the storage size is bigger.
If the USB memory is connected in Standby Mode, power on time would be longer than without memroy.
- ▶ Any device with more than the recommended capacity may not work properly.
- ▶ If a USB external hard disk with a "Energy Saving" function does not work, turn the hard disk off and on again to make it work properly.

NOTE

- Image shown may differ from your TV.
- In order to avoid losing the USB memory stick, use the USB connector(sold separately) to fix the USB memory stick to the USB connector holder of the TV.

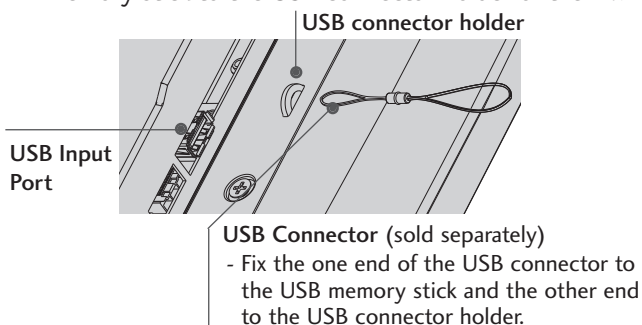

PHOTO LIST

The On Screen Display may be different from your TV. Images are an example to assist with the TV operation.

PHOTO(*.JPEG) supporting file

Baseline: Max 15360 x 8640

Min : 64 x 64

- Progressive spec out
- You can play JPEG files only.
- Only baseline scan is supported among JPEG (SOF0, SOF1 only).
- Non-supported files are displayed in the form of bitmap.

Screen Components

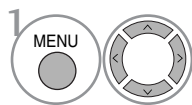

Select **USB**.

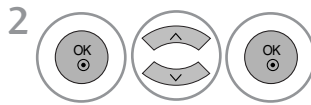

Select **Photo List**.

- Moves to upper level folder
- Current page/Total pages
- Total number of marked photos
- Corresponding buttons on the remote control

PHOTO LIST

Page 2/3 No Marked

Drive1 KY101 1366x768, 125KB	Up Folder	<input type="checkbox"/> KY107	2009/11/11
	<input checked="" type="checkbox"/> KY101	<input type="checkbox"/> KY108	2009/11/11
	<input type="checkbox"/> KY102	<input type="checkbox"/> KY109	2009/11/11
	<input type="checkbox"/> KY103	<input type="checkbox"/> KY110	2009/11/11
	<input type="checkbox"/> KY104	<input type="checkbox"/> KY111	2009/11/11
	<input type="checkbox"/> KY105	<input type="checkbox"/> KY112	2009/11/11
	<input type="checkbox"/> KY106	<input type="checkbox"/> KY113	2009/11/11

Navigation Option Page Change Mark Exit

TO USE THE USB DEVICE (Except 42/50PQ2***)

Photo Selection and PopUp Menu

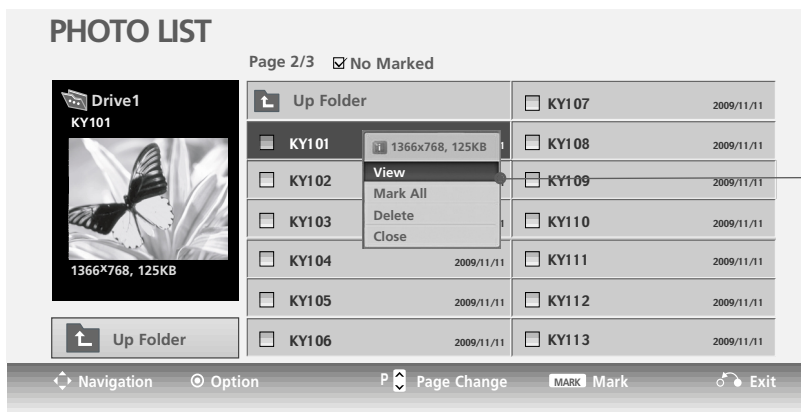
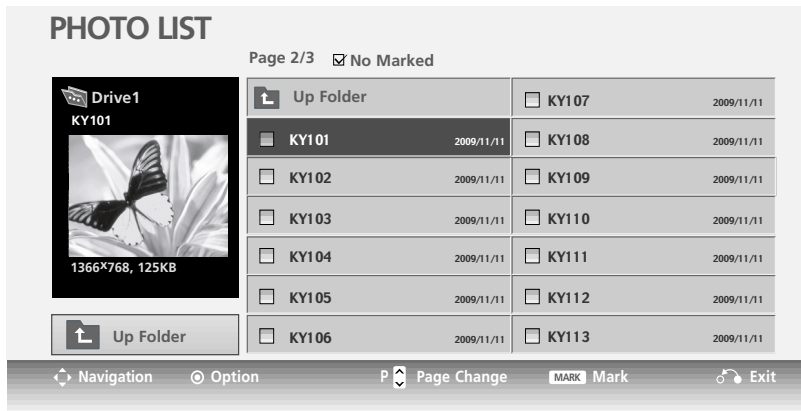

- ▶ **View** : Display the selected item.
- ▶ **Mark All** : Mark all photos on the screen.
- ▶ **Unmark All** : Deselect all marked photos.
- ▶ **Delete** : Delete the selected photo item.
- ▶ **Close** : Close the pop-up menu.

- 1 Select the target folder or drive.
- 2 Select the desired photos.
- 3 Show the PopUp menu.
- 4 Select the desired PopUp menu.





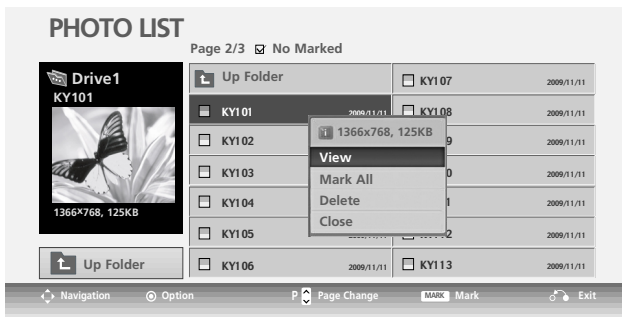
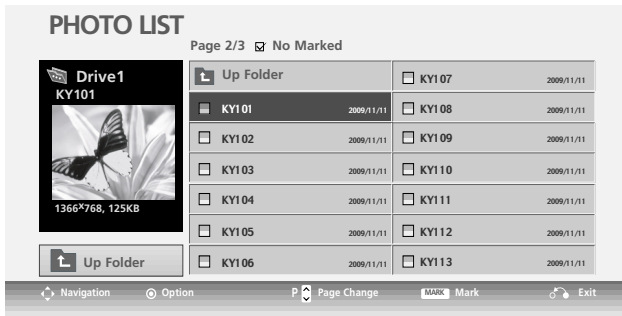

- Use the **P** ^ v button to navigation in the photo page.
- Use the **MARK** button to mark or unmark a photo. When one or more photos are marked, you can view individual photos or a slide show of the marked photos. If no photos are marked, you can view all photos individually or all photos in the folder in a slide show.

Set up the menu in Full-Sized Screen

You can change the settings to display photos stored on a USB device, on a full-sized screen. Detailed operations are available on full-sized photo view screen.



The aspect ratio of a photo may change the size of the photo displayed on the screen in full size. Press the **RETURN** button to move to the previous menu screen.

- 1  Select the target folder or drive.
- 2   Select the desired photos.
- 3  Show the PopUp menu.
- 4  Select **View**
- 5  The selected photo is displayed in full size.

TO USE THE USB DEVICE (Except 42/50PQ2***)

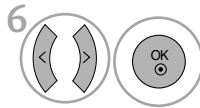

6 Select the **Slideshow**, **BGM**, **Rotate**, **Delete**, **Option** or **Hide**

- Use < > button to select the previous or next photo.
- Use < > button to select and control the menu on the full-sized screen.

- ▶ **Slideshow** : When no picture is selected, all photos in the current folder are displayed during slide show. When selected, the selected photos are displayed during slide show.
 - Set the time interval of the slide show in **Option**.
- ▶ **BGM** : Listen to music while viewing photos in full size.
 - Set the BGM device and album in **Option**.
- ▶ **Rotate** : Rotate photos.
 - Rotates the photo 90°, 180°, 270°, 360° clockwise.
- ▶ **Delete** : Delete photos.
- ▶ **Option** : Set values for **Slide Speed** and **Music Folder**.
 - Use < > ^ v button and **OK** button to set values. Then go to **OK** and press **OK** to save the settings.
 - You cannot change **Music Folder** while BGM is playing.
- ▶ **Hide** : Hide the menu on the full-sized screen.
 - To see the menu again on the full-sized screen, press **OK** button to display.

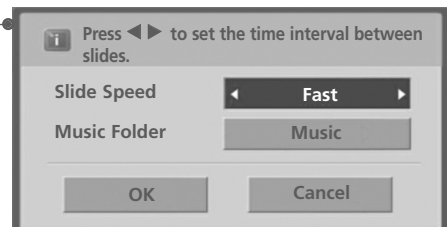

MUSIC LIST

Purchased music files(*.MP3) may contain copyright restrictions. Playback of these files may not be supported by this model.

Music file on your USB device can be played by this unit.

The On Screen Display may be different from your TV. Images are an example to assist with the TV operation.

MUSIC (*.MP3) supporting file
Bit rate : 32k ~ 320kbps
Sampling rate MPEG1 layer 3: 32k ~ 48kHz

Screen Components

1 MENU Select USB.

2 OK Select Music List.

1 Moves to upper level folder
2 Current page/Total pages
3 Total number of marked music title
4 Corresponding buttons on the remote control

MUSIC LIST

Page 2/3 No Marked

Title	Duration
Up Folder	
Aisensi	03:28
Kimigamatteirukara	03:46
Metamorphoze	04:17
mind forest	04:35
Sunano zyuzika ~ Interlude ~	03:15

Up Folder

Navigation Option Page Change MARK Mark Exit

TO USE THE USB DEVICE (Except 42/50PQ2***)

Music Selection and PopUp Menu

As shown , up to 6 music titles are listed per page.

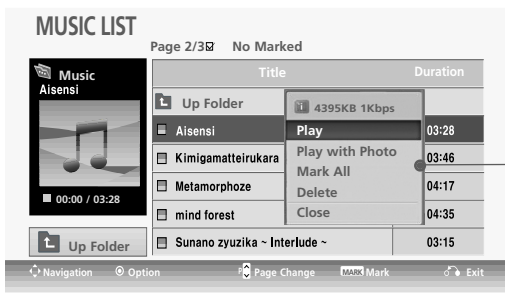
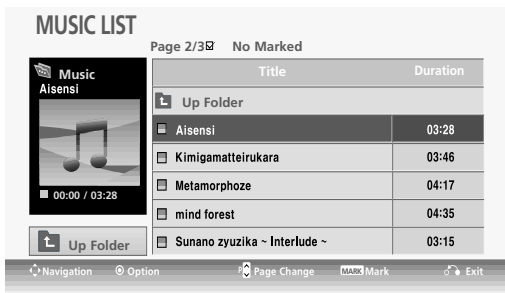

- ▶ **Play (During stop)** : Play the selected music titles.
Once a music finished playing, the next selected one will be played. When there are no selected music titles to play, the next one in the current folder will be played.
- ▶ **Play Marked** : Play the selected music titles.
Once a music finishes playing, the next selected one will be played automatically.
- ▶ **Stop Play (During playback)** : Stop the playing music titles.
- ▶ **Play with Photo** : Start playing the selected music titles and then move to the Photo List.
- ▶ **Mark All** : Mark all music titles in the folder.
- ▶ **Unmark All** : Deselect all marked music titles.
- ▶ **Delete** : Delete the selected music titles.
- ▶ **Close** : Close the pop-up menu.

TO USE THE USB DEVICE

- 1 Select the target folder or drive.
- 2 Select the desired music title
- 3 Show the PopUp menu.
- 4 Select the desired PopUp menu.

- Use the **P** ^ v button to navigation in the music page.
- Use **MARK** button to mark or unmark a music. When one or more music files are marked, the marked music title will be played in sequence. For example, if you want to listen to only one music repeatedly, just mark the music only and play it. If no music is marked, all the music in the folder will be played in sequence.

- If you don't press any button for a while during the playing, the play information box (as shown in the below) will float as a screen saver.

- The 'Screen Saver'?

Screen saver is to prevent screen pixel damage due to an fixed image remaining on the screen for a extended period of time.

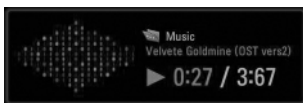

! NOTE

- ▶ When music is playing,  is displayed in back of the music title.
- ▶ A damaged or corrupted music does not play but displays 00:00 in playtime.
- ▶ A music downloaded from a paid service with copyright protection does not start but displays inappropriate information in playtime.
- ▶ If you press **OK**, **■** buttons, screen saver is stopped.
- ▶ This TV can not play music files less than 32 Kbytes.
- ▶ The **PLAY(▶)**, **Pause(II)**, **■**, **▶▶**, **◀◀** buttons on the remote control are also available in this mode.
- ▶ You can use the **▶▶** button to select the next music and the **◀◀** button to select the previous music.

TO USE THE USB DEVICE (Except 42/50PQ2***)

MOVIE LIST (Only 42/50PQ6***)

The movie list is activated once USB is detected. It is used when playing movie files on TV.

Displays the movies in the USB folder and supports Play.

Allows playback of all movies in the folder and user desired files.

Video editing is not supported but files can be deleted.

It is a movie list that displays folder information and Divx file.

Supports up to four drives.

MOVIE(*.avi/*.Divx) supporting file

Video format : MPEG1 , MPEG2, MPEG4 (Doesn't support Microsoft MPEG4-V2, V3), DivX 3.xx , DivX 4.xx, DivX 5.xx , DivX VOD (DRM) , XviD

Audio format : Mpeg, Mp3, PCM, Dolby Digital.

Sampling frequency : 32k ~ 48kHz

Bit rate : 32k ~ 320kbps

Subtitle format : *.smi/ *.srt/ *.sub(MicroDVD, SubViewer 2.0)/ *.ass/ *.ssa/*.txt(DVD Subtitle System)

- DivX may not be played depending on its types or recording methods.
- If the video and audio structure of recorded file is not interleaved, either video or audio is outputted.
- Max bitrate of playable DivX is 4Mbps.
- Maximum FPS (Frame Per Second) can be reached only at SD level. FPS is 25 FPS (720*576) or 30 FPS (720*480) depending on Resolution.
- Files of 25 FPS or 30 FPS of higher may not be played properly.
- If the file is recorded with GMC, the unit supports only 1 point of recorded level.

(GMC is the acronym for Global Motion Compensation, a technique used to compensate MPEG Video files.)

Screen Components



Select **USB**.

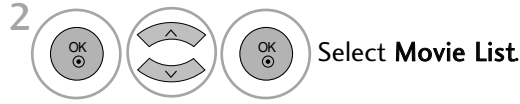

Select **Movie List**

- ❶ Moves to upper level folder
- ❷ Current page/Total pages
- ❸ Total number of marked movie title
- ❹ Corresponding buttons on the remote control



! NOTE

- ▶ A video file name and its subtitle file name must be identical for it to be displayed.
- ▶ Use the left/right (< / >) keys to move to a specific frame forward or backward while playing a movie. (The left/right (< / >) keys may not work properly for some files while playing a movie.)

TO USE THE USB DEVICE (Except 42/50PQ2***)





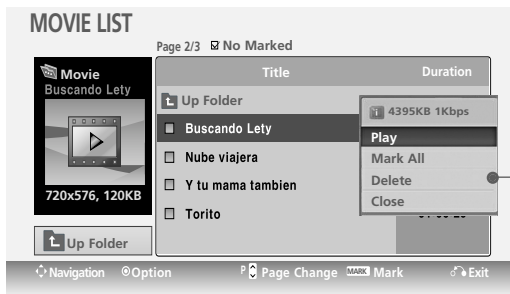
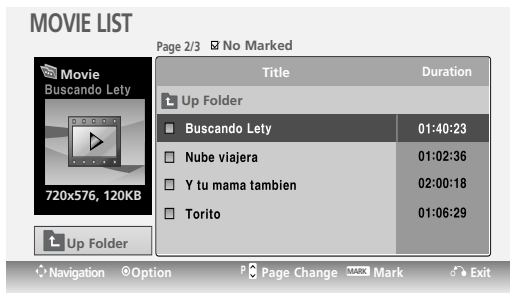

Movie Selection and PopUp Menu

As shown , up to 6 movie titles are listed per page.



- ▶ **Play** : Play the selected movie titles. Divx Play is executed while screen changes.
- ▶ **Play Marked** : Play the selected movie titles. Once a movie finishes playing, the next selected one will be played automatically.
- ▶ **Stop Play** (During playback) : Stop the playing movie titles.
- ▶ **Mark All** : Mark all movie titles in the folder.
- ▶ **Unmark All** : Deselect all marked movie titles.
- ▶ **Delete** : Delete the selected movie titles.
- ▶ **Close** : Close the pop-up menu.

TO USE THE USB DEVICE

- 1  Select the target folder or drive.
- 2   Select the desired movie titles.
- 3  Show the PopUp menu.
- 4   Select the desired PopUp menu.

• In the case of files not supported, a message regarding non-supported file is displayed.
This file is invalid.

DivX Audio Language & Subtitle Language



1 Select the desired option.

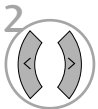

2 Select **Picture Size, Subtitle Language, Audio Language, Subtitle, Language, Sync** or **Position**.

• When DivX is playing, if you press the **RED** button, this message is displayed.

- Press the **MENU** button to return to normal TV viewing.
- Press the **RETURN** button to move to the previous menu screen.

Using the remote control

◀◀ / ▶▶	<p>When playing, repeatedly, press the REW(◀◀) button to speed up ◀◀ -> ◀◀◀ -> ◀◀◀◀ -> ◀◀◀◀◀ -> ◀◀◀◀◀◀.</p> <p>repeatedly, press the FF(▶▶) button to speed up ▶▶-> ▶▶▶ -> ▶▶▶▶ -> ▶▶▶▶▶ -> ▶▶▶▶▶▶.</p> <ul style="list-style-type: none"> ▪ Pressing these buttons repeatedly increases the fast forward/reverse speed.
	<p>During playback, press the Pause() button.</p> <ul style="list-style-type: none"> ▪ Still screen is displayed.
< >	<ul style="list-style-type: none"> ▪ When using the < or > button during playback a cursor indicating the position can be viewed on the screen.
PLAY(▶)	<p>Press the PLAY(▶) button to return to normal playback.</p>

TO USE THE USB DEVICE (Except 42/50PQ2***)

DIVX REGISTRATION CODE (Only 42/50PQ6***)

Confirm the DivX registration code number of the TV. Using the registration number, movies can be rented or purchased at www.divx.com/vod.

With a DivX registration code from other TV, playback of rented or purchased DivX file is not allowed. (Only DivX files matched with the registration code of the purchased TV are playable.)

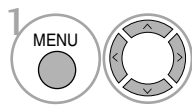
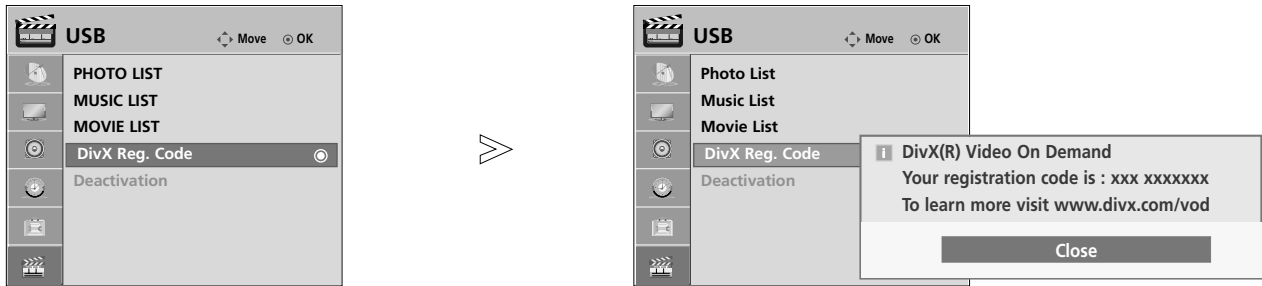

Select **USB**.

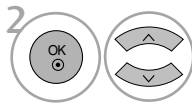

Select **Divx Reg. Code**.

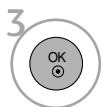

Display **Divx Reg. Code**.

- Press the **MENU** button to return to normal TV viewing.
- Press the **RETURN** button to move to the previous menu screen.



“ DivX Certified to play DivX video, including premium content ”

ABOUT DIVX VIDEO: DivX[®] is a digital video format created by DivX, Inc. This is an official DivX Certified device that plays DivX video. Visit www.divx.com for more information and software tools to convert your files into DivX video.

ABOUT DIVX VIDEO-ON-DEMAND: This DivX Certified[®] device must be registered in order to play DivX Video-on-Demand (VOD) content. To generate the registration code, locate the DivX VOD section in the device setup menu. Go to vod.divx.com with this code to complete the registration process and learn more about DivX VOD.

! NOTE

Supported movie file

Resolution : under 720x480(720x576) WxH pixels.
Frame rate : under 30 frames/sec



- ▶ Video Codec : MPEG1, MPEG2, MPEG4(Doesn't support Microsoft MPEG4-V2, V3), DivX3.xx, DivX4.xx, DivX5.xx, DivX VOD(DRM), XviD, RM.
- ▶ When loading, some buttons may not work.
- ▶ If you use the DivX registration code of another device, the rented or purchased DivX file cannot be played. Therefore always use the DivX registration code assigned to this product.

DEACTIVATION (Only 42/50PQ6***)

Delete the existing authentication information to receive a new DivX user authentication for TV.

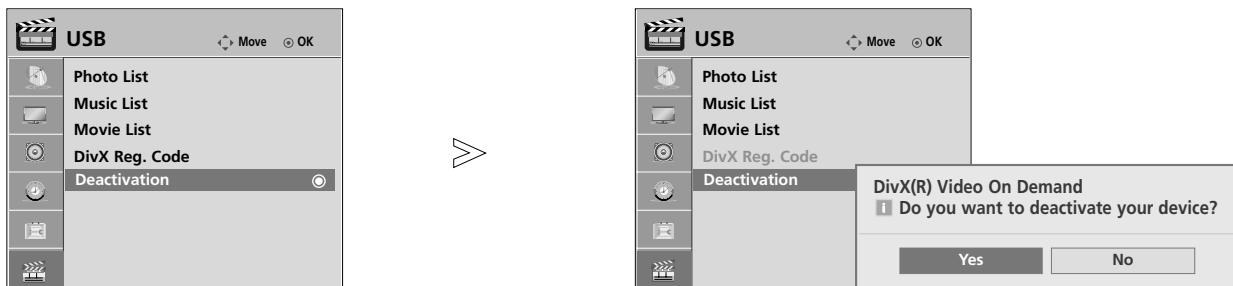
Once this function is executed, a DivX user authentication is required again to see DivX DRM files.

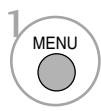

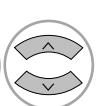
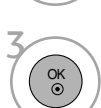
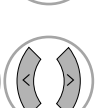
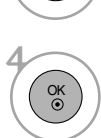
-   Select **USB**.
-   Select **Deactivation**.
-   Select **Yes** or **No**.
- 

- Press the **MENU** button to return to normal TV viewing.
- Press the **RETURN** button to move to the previous menu screen.

PICTURE CONTROL

PICTURE SIZE (ASPECT RATIO) CONTROL

You can watch the screen in various picture formats; **16:9**, **Just Scan**, **Original**, **4:3**, **14:9**, **Zoom** and **Cinema Zoom1**.

If a fixed image is displayed on the screen for a long time, that fixed image may become imprinted on the screen and remain visible.

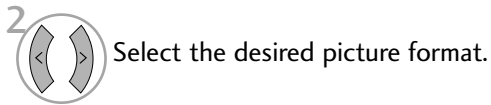

• You can also adjust **Aspect Ratio** in the **PICTURE** or **Q. Menu** menu.

• 16:9

The following selection will allow you to adjust the picture horizontally, in linear proportion, to fill the entire screen (useful for viewing 4:3 formatted DVDs)



• Original

When your TV receives a wide screen signal it will automatically change to the picture format broadcast.

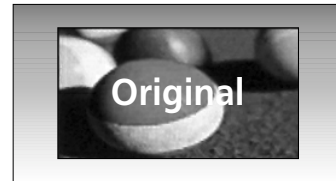

• Just Scan

Following Selection will lead to you view the picture of best quality without loss of original picture in high resolution image.

Note : If there is noise in original Picture, You can see the noise at the edge.



• 4:3

The following selection will allow you to view a picture with an original 4:3 aspect ration, gray bars will appear on both the left and right of the screen.



- **14:9**

You can view a picture format of 14:9 or a general TV programme in the 14:9 mode. The 14:9 screen is viewed in the same way as in 4:3, but is magnified to the left and right.



- **Zoom**

The following selection will allow you to view the picture without any alteration, while filling the entire screen. However, the top and bottom of the picture will be cropped.



- **Cinema Zoom1**

Choose Cinema Zoom when you wish the picture to be altered, both horizontally extended and vertically cropped. The picture adopting a compromise between alteration and screen coverage.

The adjustment range is 1-16.

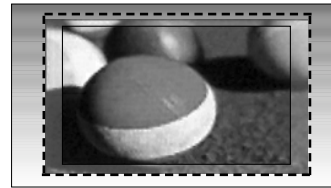

! NOTE

- ▶ You can only select **4:3**, **16:9 (Wide)**, **14:9**, **Zoom**, **Cinema Zoom1** in Component, HDMI mode.
- ▶ You can only select **4:3**, **16:9 (Wide)** in RGB mode only.
- ▶ In HDMI/Component (over 720p) mode, **Just Scan** is available.

PICTURE CONTROL





e ENERGY SAVING

It reduces the plasma display's power consumption.

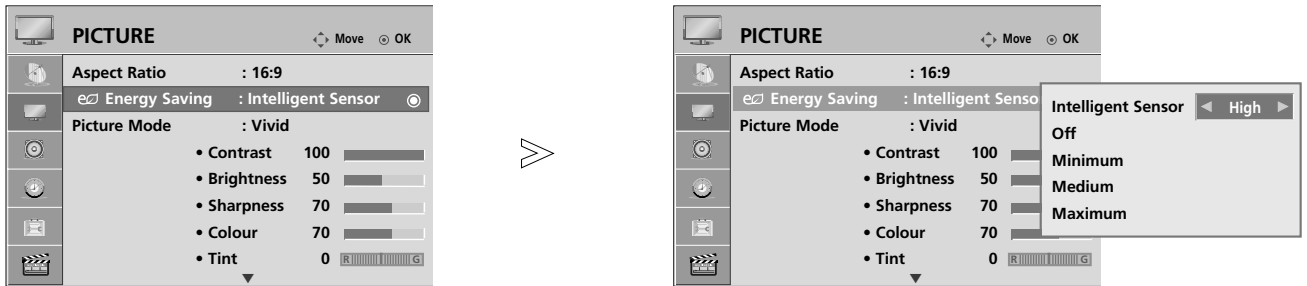
The default factory setting complies with the Energy Star requirements and is adjusted to the comfortable level to be viewed at home.

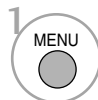
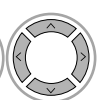
You can increase the brightness of your screen by adjusting the Energy Saving level or by setting the Picture Mode.

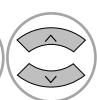

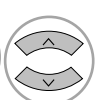
- 1   Select **PICTURE**.
- 2   Select **e ENERGY SAVING**.
- 3   Select **Intelligent Sensor, Off, Minimum, Medium or Maximum**.

- When the Intelligent sensor function is on, the most suitable picture is automatically adjusted according to the surrounding conditions.
- **Intelligent Sensor** : Adjusts picture according to the surrounding conditions.

When the **Intelligent Sensor** is selected,

- 4  Select **Low, Middle or High**.





- Press the **MENU** button to return to normal TV viewing.
- Press the **RETURN** button to move to the previous menu screen.

PRESET PICTURE SETTINGS

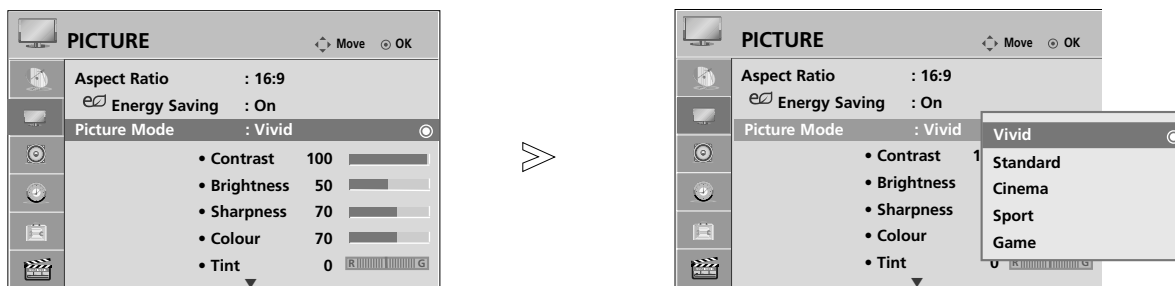
Picture Mode-Preset

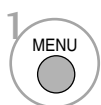
- Vivid** Strengthen the contrast, brightness, colour and sharpness for vivid picture.
- Standard** The most general screen display status.
- Cinema** Optimizes video for watching movies.
- Sport** Optimizes video for watching sports events.
- Game** Optimizes video for playing games.

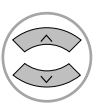

-   Select **PICTURE**.
-   Select **Picture Mode**.
-   Select **Vivid, Standard, Cinema, Sport or Game**.

- **Picture Mode** adjusts the TV for the best picture appearance. Select the preset value in the **Picture Mode** menu based on the programme category.
- You can also adjust **Picture Mode** in the **Q. Menu**.







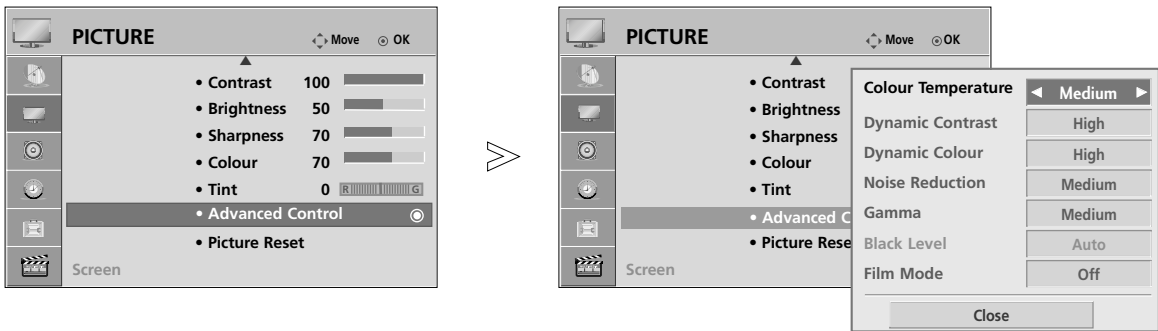

- Press the **MENU** button to return to normal TV viewing.
- Press the **RETURN** button to move to the previous menu screen.

PICTURE CONTROL

Auto Colour Tone Control (Warm/Medium/Cool)

Choose one of three automatic colour adjustments. Set to warm to enhance hotter colours such as red, or set to cool to see less intense colours with more blue.



- 1   Select **PICTURE**.
- 2   Select **Advanced Control**.
- 3   Select **Colour Temperature**.
- 4   Select either **Cool**, **Medium** or **Warm**.

- Press the **MENU** button to return to normal TV viewing.
- Press the **RETURN** button to move to the previous menu screen.

MANUAL PICTURE ADJUSTMENT

Picture Mode-User option

- **Contrast**
Adjusts the difference between light and dark levels in the picture.
- **Brightness**
Increases or decreases the amount of white in the picture.
- **Sharpness**
Adjusts the level of crispness in the edges between the light and dark areas of the picture.
The lower the level, the softer the image.
- **Colour**
Adjusts intensity of all colours.
- **Tint**
Adjusts the balance between red and green levels.

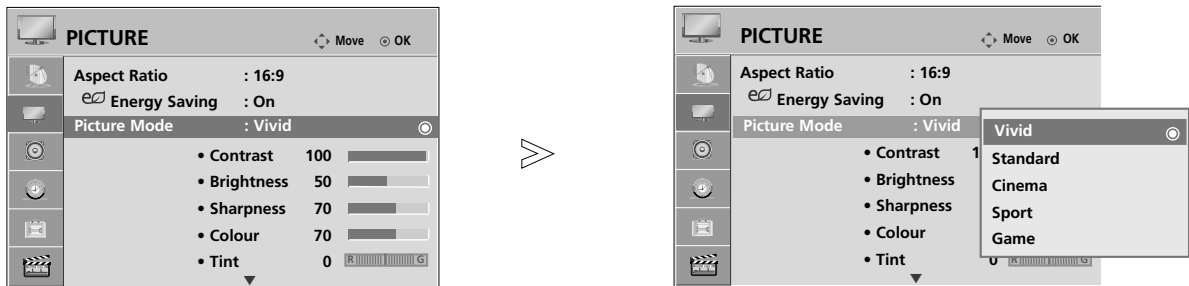

- 1   Select **PICTURE**.
- 2   Select **Picture Mode**.
- 3   Select **Vivid, Standard, Cinema, Sport or Game**
- 4   Select **Contrast, Brightness, Sharpness, Colour or Tint**.
- 5   Make appropriate adjustments.

- Press the **MENU** button to return to normal TV viewing.
- Press the **RETURN** button to move to the previous menu screen.

! NOTE

- ▶ You cannot adjust colour, sharpness and tint in the RGB-PC mode.

PICTURE CONTROL

PICTURE IMPROVEMENT TECHNOLOGY

Dynamic Contrast(Off/Low/High)

Adjusts the contrast to keep it at the best level according to the brightness of the screen. The resolution of gradation is improved by making bright parts brighter and dark parts darker. This feature refers to dynamic contrast, and enhances the feeling of presence that contrast controls are intended to give by using dimming and other input signals.

Dynamic Colour(Off/Low/High)

Adjusts screen colours so that they look livelier, richer and clearer. This feature enhances hue, saturation and luminance so that red, blue, green and white look more vivid.

Noise Reduction(Off/Low/Medium/High)

Reduces screen noise without compromising video quality. This feature is also used to reduce recursive noise and MPEG noise (Mosquito/Block).

Gamma(Low/Medium/High)

You can adjust brightness of dark area and middle gray level area of the picture.

- Low : Make dark and middle gray level area of the picture brighter.
- Medium: Express original picture gradation.
- High: Make dark and middle gray level area of the picture darken.

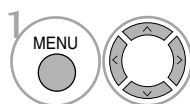
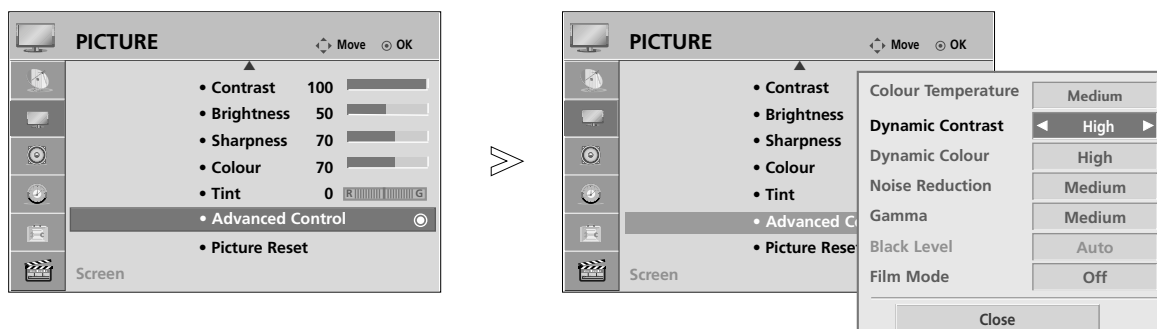

Select **PICTURE**.

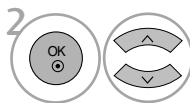

Select **Advanced Control**.

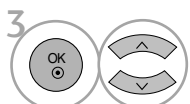

Select **Dynamic Contrast, Dynamic Colour, Noise Reduction or Gamma**.



Select your desired **Source**.







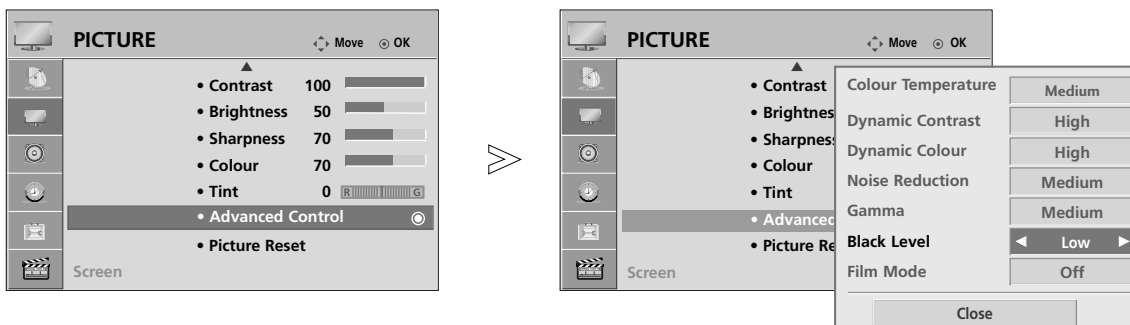

- Press the **MENU** button to return to normal TV viewing.
- Press the **RETURN** button to move to the previous menu screen.

ADVANCED - BLACK(DARKNESS) LEVEL

Makes dark parts on the screen look darker.

This function works in the following mode: TV, AV, COMPONENT or HDMI.



- 1   Select **PICTURE**.
- 2   Select **Advanced Control**.
- 3   Select **Black Level**.
- 4   Select **Low** or **High**.

- **Low** : The reflection of the screen gets darker.
- **High** : The reflection of the screen gets brighter.
- **Auto** : Realizing the black level of the screen and set it to High or Low automatically.

- Press the **MENU** button to return to normal TV viewing.
- Press the **RETURN** button to move to the previous menu screen.







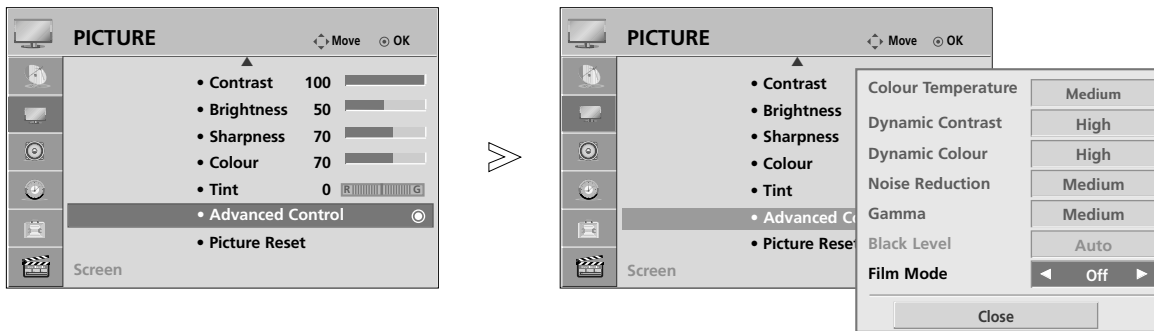

PICTURE CONTROL

ADVANCED - FILM MODE

Makes video clips recorded in film look more natural.

This feature operates only in TV, AV and Component 480i/576i mode.







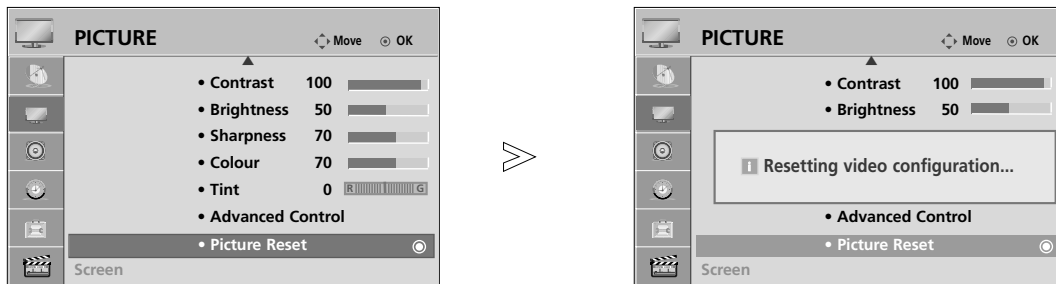

- 1   Select **PICTURE**.
- 2   Select **Advanced Control**.
- 3   Select **Film Mode**.
- 4   Select **On** or **Off**.
- 5 

- Press the **MENU** button to return to normal TV viewing.
- Press the **RETURN** button to move to the previous menu screen.

PICTURE RESET

Settings of the selected picture modes return to the default factory settings.



- 1   Select **PICTURE**.
- 2   Select **Picture Reset**.
- 3  Initialize the adjusted value.

- Press the **MENU** button to return to normal TV viewing.
- Press the **RETURN** button to move to the previous menu screen.

PICTURE CONTROL

IMAGE STICKING MINIMIZATION (ISM) METHOD

A frozen or still picture from a PC/Video game displayed on the screen for prolonged periods will result in a ghost image remaining even when you change the image. Avoid allowing a fixed image to remain on the screen for prolonged periods.

Normal

If image sticking is never a problem, ISM is not necessary - set to Normal.

White Wash

White wash removes permanent images from the screen.

Note: An excessive permanent image may be impossible to clear entirely with White Wash.

Orbiter

Orbiter may help prevent ghost images. However, it is best not to allow any fixed image to remain on the screen. To avoid a permanent image on the screen, the screen will move every 2 minutes.

Colour Wash

The colour block with the screen moved a little and the white pattern are alternately displayed. It is difficult to sense the afterimage occurred while the temporary afterimage is removed and the colour pattern is operating.

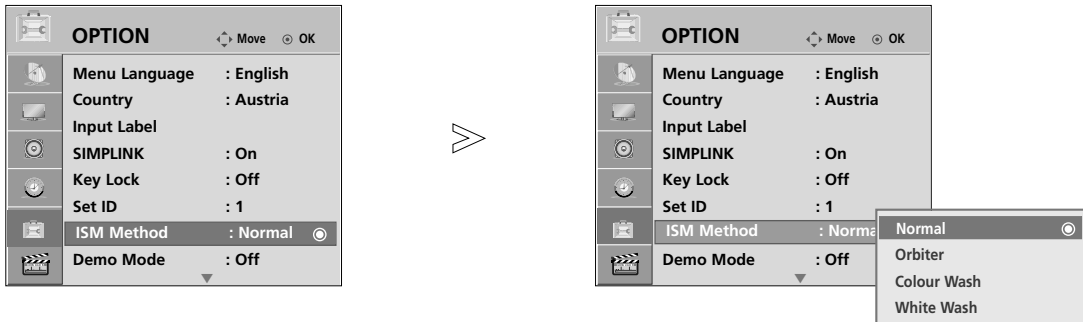

1 MENU Select **OPTION**.

2 OK Select **ISM Method**.

3 OK Select **Normal, Orbiter, Colour Wash** or **White Wash**.

4 OK Save.





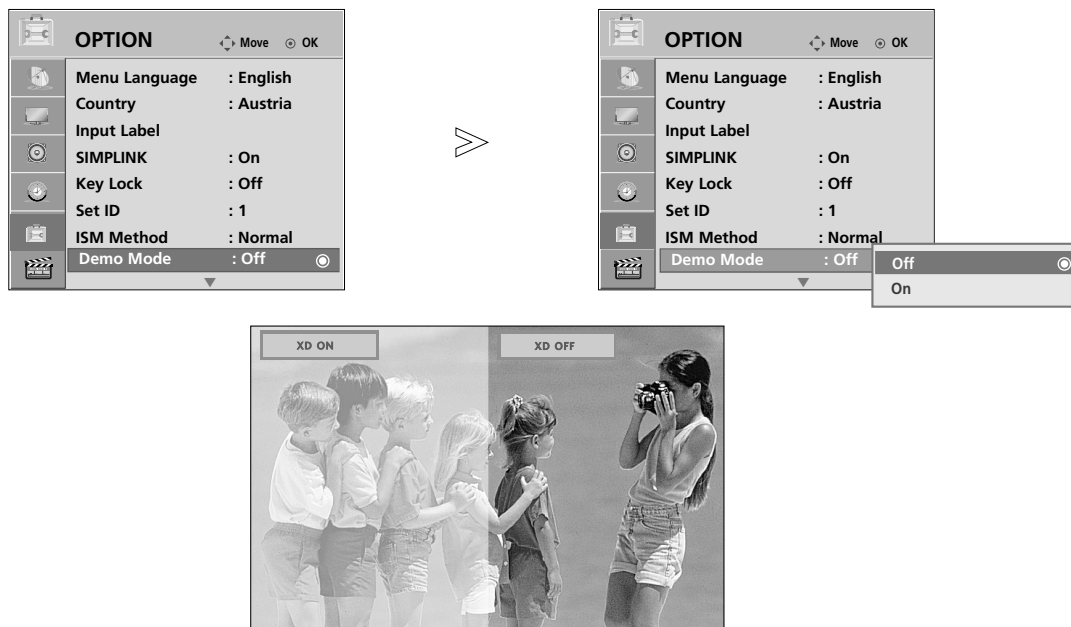

• If you do not need this function, set **Normal**.

- Press the **MENU** button to return to normal TV viewing.
- Press the **RETURN** button to move to the previous menu screen.

DEMO MODE

Use it to see the difference between XD Demo on and XD Demo off.









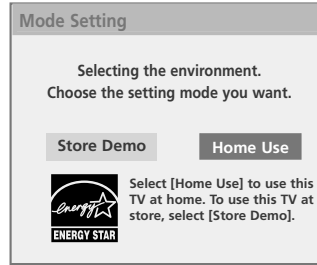
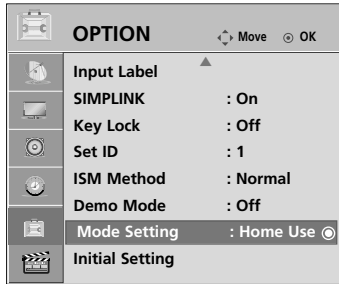

- 1   Select **OPTION**.
- 2   Select **Demo Mode**.
- 3   Select **On** or **Off**.
To stop the **Demo Mode**, press any button.

PICTURE CONTROL

MODE SETTING

We recommend setting the TV to “Home Use” mode for the best picture in your home environment. “Store Demo” mode is an optimal setting for displaying at stores.



- 1   Select **OPTION**.
- 2   Select **Mode Setting**.
- 3   Select **Store Demo** or **Home Use**.
- 4  Save.

- Press the **RETURN** button to return to normal TV viewing.





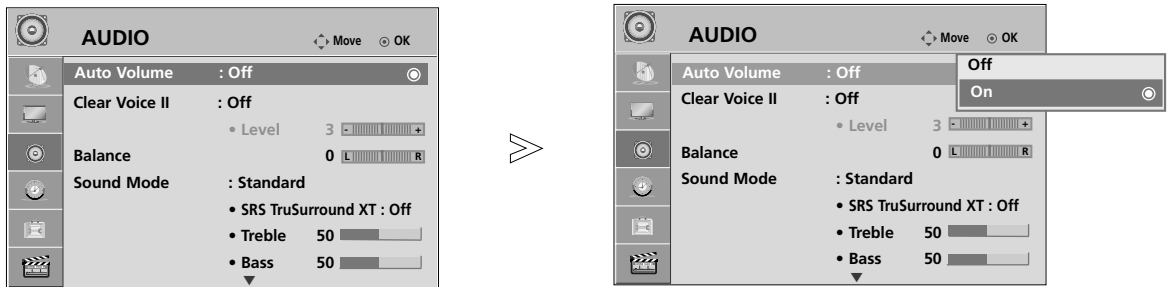

SOUND & LANGUAGE CONTROL

AUTO VOLUME LEVELER

Auto Volume automatically remains on the same level of volume if you change programmes.

Because each broadcasting station has its own signal conditions, volume adjustment may be needed every time the channel is changed. This feature allows users to enjoy stable volume levels by making automatic adjustments for each programme.



- 1   Select **AUDIO**.
- 2   Select **Auto Volume**.
- 3   Select **On** or **Off**.

- Press the **MENU** button to return to normal TV viewing.
- Press the **RETURN** button to move to the previous menu screen.

SOUND & LANGUAGE CONTROL

PRESET SOUND SETTINGS-SOUND MODE





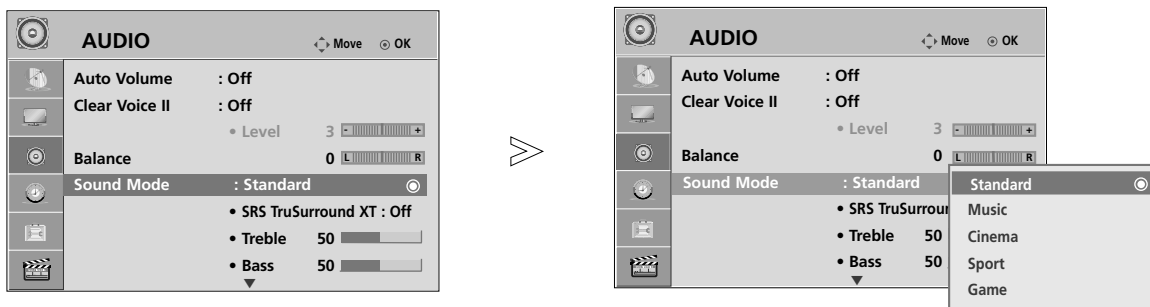

You can select your preferred sound setting; **Standard**, **Music**, **Cinema**, **Sport** or **Game** and you can also adjust **Treble**, **Bass**.

Sound Mode lets you enjoy the best sound without any Special adjustment as the TV sets the appropriate sound options based on the programme content.

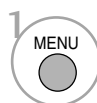
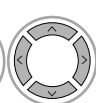
Standard, **Music**, **Cinema**, **Sport** and **Game** are preset for optimum sound quality at the factory.

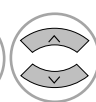
- Standard** Offers standard-quality sound.
- Music** Optimizes sound for listening to music.
- Cinema** Optimizes sound for watching movies.
- Sport** Optimizes sound for watching sports events.
- Game** Optimizes sound for playing games.

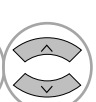

- 1   Select **AUDIO**.
- 2   Select **Sound Mode**.
- 3   Select **Standard**, **Music**, **Cinema**, **Sport** or **Game**.
- 4 

• You can also adjust **Sound Mode** in the **Q. Menu**.

- Press the **MENU** button to return to normal TV viewing.
- Press the **RETURN** button to move to the previous menu screen.

SOUND SETTING ADJUSTMENT -USER MODE

Adjusting the audio equalizer.

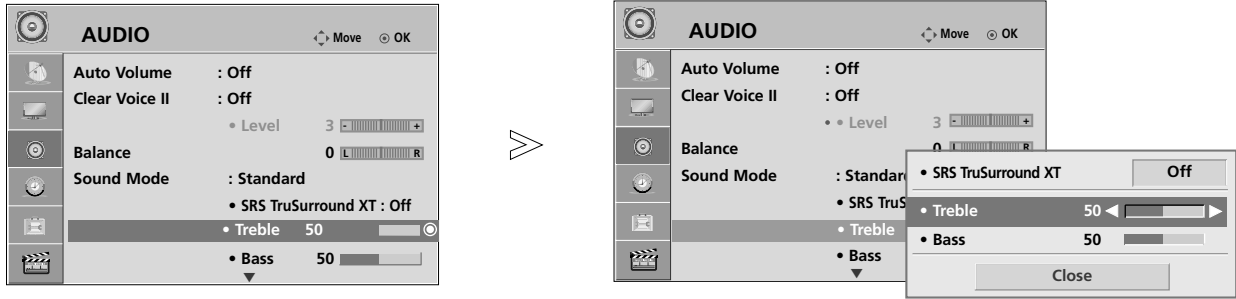

- 1 Select **AUDIO**.
- 2 Select **Sound Mode**.
- 3 Select **Standard, Music, Cinema, Sport or Game**.

- 4 Select **Treble, Bass**.
- 5 Make appropriate adjustments.
- 6

- Press the **MENU** button to return to normal TV viewing.
- Press the **RETURN** button to move to the previous menu screen.

SRS TRUSURROUND XT

Select this option to sound realistic.

- 1 Select **AUDIO**.
- 2 Select **SRS TruSurround XT**.
- 3 Select **On** or **Off**.
- 4

SRS TruSurround XT : TruSurround XT is a patented SRS technology that solves the problem of playing 5.1 multichannel content over two speakers.





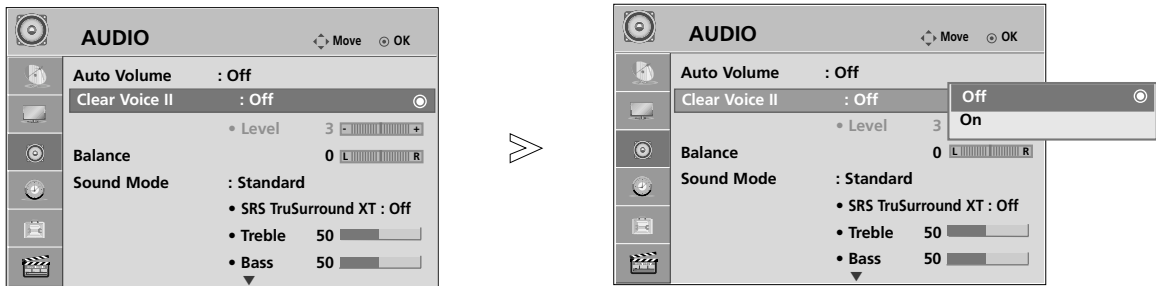

- ▶ is a trademark of SRS Labs, Inc.
- ▶ TruSurround XT technology is incorporated under license from SRS Labs, Inc.

SOUND & LANGUAGE CONTROL

CLEAR VOICE II



By differentiating the human sound range from others, it helps users listen to human voices better.



- 1   Select **AUDIO**.
- 2   Select **Clear Voice II**.
- 3   Select **On** or **Off**.

• If you select “On” for **Clear Voice II**, **SRS TruSurround XT** feature will not work.

Adjustment for Clear Voice Level With selecting On

- 4   Select **Level**.
- 5   Make desired adjustment.

• Select levels from ‘-6’ to ‘6’.

- Press the **MENU** button to return to normal TV viewing.
- Press the **RETURN** button to move to the previous menu screen.

BALANCE

You can adjust the sound balance of the speakers to preferred levels.

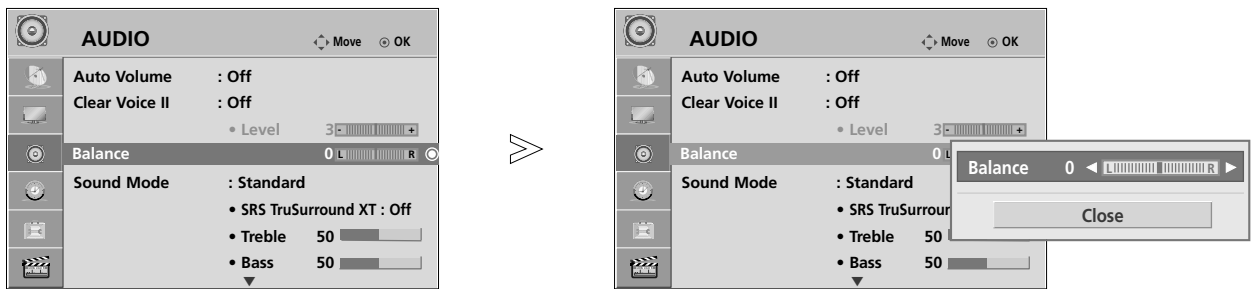

- 1   Select **AUDIO**.
- 2   Select **Balance**.
- 3   Make desired adjustment.





- Press the **MENU** button to return to normal TV viewing.
- Press the **RETURN** button to move to the previous menu screen.

SOUND & LANGUAGE CONTROL

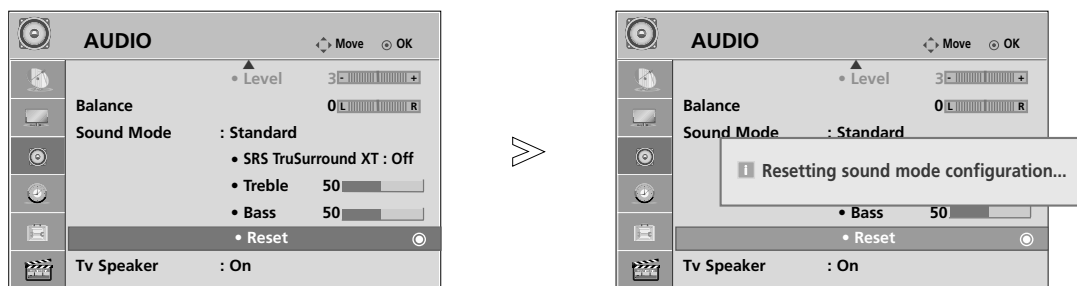
AUDIO RESET

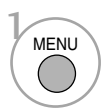
Settings of the selected Sound Mode return to the default factory settings.

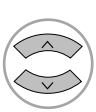

- 1   Select **AUDIO**.
- 2   Select **Reset**.
- 3  Initialize the adjusted value.

- Press the **MENU** button to return to normal TV viewing.
- Press the **RETURN** button to move to the previous menu screen.





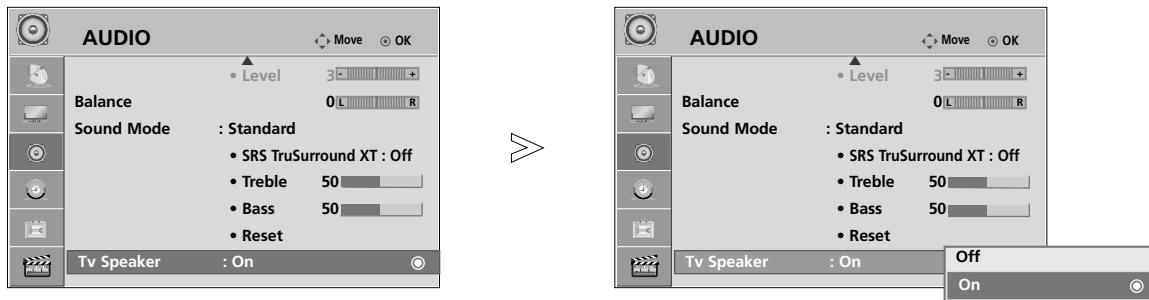

TV SPEAKERS ON/ OFF SETUP

You can adjust the TV internal speaker status.

In **AV**, **Component**, **RGB** and **HDMI** with HDMI to DVI cable, the TV speaker can be operational even when there is no video signal.

If you wish to use an external Hi-Fi system, turn off the TV internal speakers.



- 1   Select **AUDIO**.
- 2   Select **TV Speaker**.
- 3   Select **On** or **Off**.

- Press the **MENU** button to return to normal TV viewing.
- Press the **RETURN** button to move to the previous menu screen.

! NOTE

- ▶ When the TV speaker is turned off while the Simlink home theater is operating, the sound output automatically switches to the Home theater speaker, but when the TV speaker is turned on, the sound output the TV speaker.

SOUND & LANGUAGE CONTROL

I/II

Stereo/Dual Reception

When a programme is selected, the sound information for the station appears with the programme number and station name.

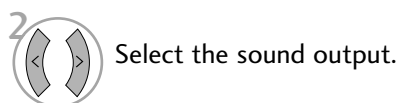

Broadcast	On Screen Display
Mono	MONO
Stereo	STEREO
Dual	DUAL I, DUAL II, DUAL I+II

■ Mono sound selection

If the stereo signal is weak in stereo reception, you can switch to mono. In mono reception, the clarity of sound is improved.

■ Language selection for dual language broadcast

If a programme can be received in two languages (dual language), you can switch to DUAL I, DUAL II or DUAL I+II.

DUAL I Sends the primary broadcast language to the loudspeakers.

DUAL II Sends the secondary broadcast language to the loudspeakers.

DUAL I+II Sends a separate language to each loudspeaker.

NICAM Reception

If the TV is equipped with a receiver for NICAM reception, high quality NICAM (Near Instantaneous Companding Audio Multiplex) digital sound can be received.

Sound output can be selected according to the type of broadcast received.

-
- 1 When **NICAM mono** is received, you can select **NICAM MONO**.

 - 2 When **NICAM stereo** is received, you can select **NICAM MONO** or **NICAM STEREO**.

 - 3 When **NICAM dual** is received, you can select **NICAM DUAL I**, **NICAM DUAL II** or **NICAM DUAL I+II** or **NICAM MONO**.
-

Speaker Sound Output Selection

In AV, Component, RGB and HDMI mode, you can select output sound for the left and right loudspeakers.

Select the sound output.

L+R: Audio signal from audio L input is sent to the left loudspeaker and audio signal from audio R input is sent to the right loudspeaker.

L+L: Audio signal from audio L input is sent to left and right loudspeakers.

R+R: Audio signal from audio R input is sent to left and right loudspeakers.

SOUND & LANGUAGE CONTROL

ON-SCREEN MENU LANGUAGE / COUNTRY SELECTION

The installation guide menu appears on the TV screen when it is switched on for the first time.

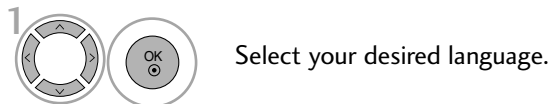

* If you want to change Language/ Country selection

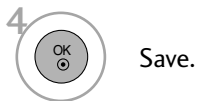
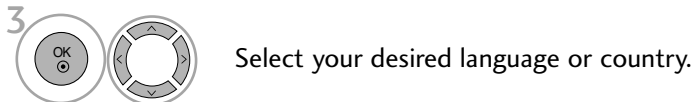

- Press the **MENU** button to return to normal TV viewing.
- Press the **RETURN** button to move to the previous menu screen.

! NOTE

- ▶ If you don't finish set up **Installation Guide** by pressing **RETURN** button or time out of OSD (On Screen Display) display, it will continuously appear until completing set up whenever the set is turned on.
- ▶ If you select wrong local country, the teletext may not appear correctly on the screen and some problem may happen during teletext operation.







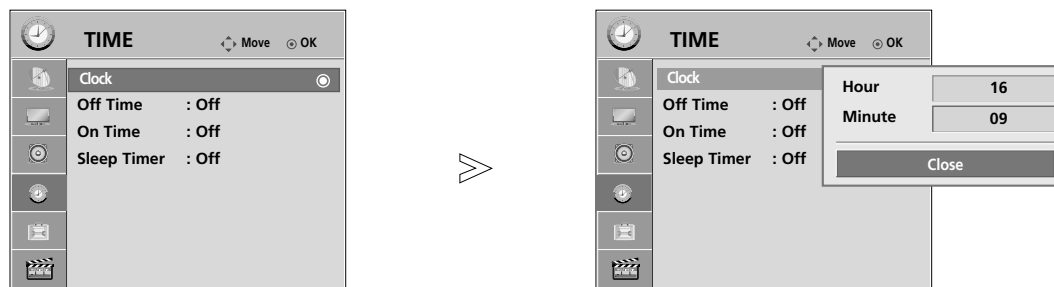

TIME SETTING

CLOCK SETUP

You must set the time correctly before using on/off timer function.

If current time setting is erased by a power failure or the TV is unplugged, reset the clock.



-   Select **TIME**.
-   Select **Clock**.
-   Select **Hour** or **Minute**.
-   Set the **Hour** or **Minute**.

- Press the **MENU** button to return to normal TV viewing.
- Press the **RETURN** button to move to the previous menu screen.

TIME SETTING

AUTO ON/OFF TIMER SETTING

The Off time function automatically switches the TV to standby at a preset time.

Two hours after the TV is switched on by the on time function it will automatically switch back to standby mode unless a button has been pressed.

The Off time function overrides the On timer function if both are set to the same time.

The TV must be in standby mode for the On timer to work.

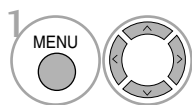
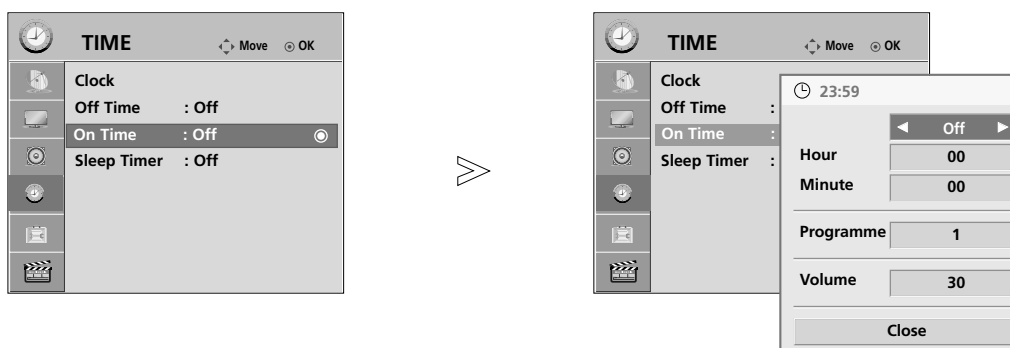

1 Select **TIME**.

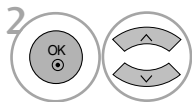

2 Select **Off Time** or **On Time**.

When the **On Time** is selected,

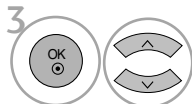

3 Select **Hour**, **Minute**, **Programme** or **Volume** .



4 Set the hour, Minute, Programme, Volume .

- Press the **MENU** button to return to normal TV viewing.
- Press the **RETURN** button to move to the previous menu screen.

SLEEP TIMER SETTING

You do not have to remember to switch the TV off before you go to sleep. The sleep timer automatically switches the TV to standby after the preset time has elapsed.

1   Select **Sleep Timer**.

2  Select **Off, 10, 20, 30, 60, 90, 120, 180 or 240 Min.**

- When you switch the TV off, the preset sleep timer is cancelled.
- You can also adjust **Sleep Timer** in the **TIME** menu.

TELETEXT

This feature is not available in all countries.

Teletext is a free service broadcast by most TV stations which gives up-to-the-minute information on news, weather, television programmes, share prices and many other topics.

The teletext decoder of this TV can support the SIMPLE, TOP and FASTEXT systems. SIMPLE (standard teletext) consists of a number of pages which are selected by directly entering the corresponding page number. TOP and FASTEXT are more modern methods allowing quick and easy selection of teletext information.

SWITCH ON/OFF

Press the **TEXT** button to switch to teletext. The initial page or last page viewed appears on the screen.

Two page numbers, TV station name, date and time are displayed on the screen headline. The first page number indicates your selection, while the second shows the current page displayed.

Press the **TEXT** button to switch off teletext. The previous mode reappears.

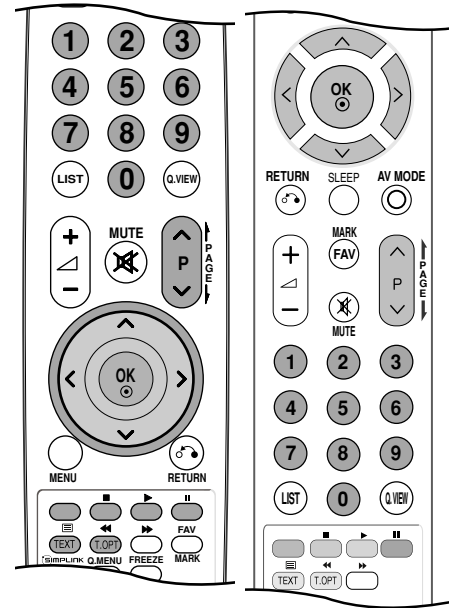

SIMPLE TEXT

■ Page selection

- 1 Enter the desired page number as a three digit number with the NUMBER buttons. If during selection you press a wrong number, you must complete the three digit number and then re-enter the correct page number.
- 2 The P ^ ∨ button can be used to select the preceding or following page.

TOP TEXT

The user guide displays four fields-red, green, yellow and blue at the bottom of the screen. The yellow field denotes the next group and the blue field indicates the next block.

■ Block / group / page selection

- 1 With the blue button you can progress from block to block.
- 2 Use the yellow button to proceed to the next group with automatic overflow to the next block.
- 3 With the green button you can proceed to the next existing page with automatic overflow to the next group. Alternatively the P ^ button can be used.
- 4 The red button returns to the previous selection. Alternatively the P ∨ button can be used.

■ Direct page selection

As with SIMPLE teletext mode, you can select a page by entering it as a three digit number using the NUMBER buttons in TOP mode.

FASTEXT

The teletext pages are colour coded along the bottom of the screen and are selected by pressing the corresponding coloured button.

■ Page selection

- 1 Press the **T.OPT** button and then use $\wedge \vee$ button to select  menu. Display the index page.
- 2 You can select the pages which are colour coded along the bottom line with corresponding coloured buttons.
- 3 AS with SIMPLE teletext mode, you can select a page by entering its three digit page number with the **NUMBER** buttons in FASTEXT mode.
- 4 The **P $\wedge \vee$** button can be used to select the preceding or following page.

SPECIAL TELETEXT FUNCTIONS



■ Index

Select the each index page.



■ Time

When viewing a TV programme, press this button to display the time at the top right hand corner of the screen. Press this button again to remove the display. In the teletext mode, press this button to select a sub page number. The sub page number is displayed at the bottom of the screen. To hold or change the sub page, press the **RED/GREEN, P $\wedge \vee$** or **NUMBER** buttons.

Press again to exit this function.

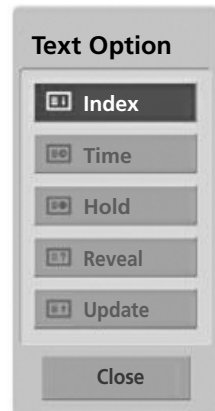

■ Hold

Stops the automatic page change which will occur if a teletext page consists of 2 or more sub pages. The number of sub pages and the sub page displayed is, usually, shown on the screen below the time. When this button is pressed the stop symbol is displayed at the top left-hand corner of the screen and the automatic page change is inactive. To continue press this button again.



■ Reveal

Press this button to display concealed information, such as solutions to riddles or puzzles.

Press this button again to remove the information from the display.



■ Update

Displays the TV picture on the screen while waiting for a new teletext page. The display will appear at the top left hand corner of the screen. When the updated page is available then display will change to the page number. Press this button again to view the updated teletext page.

APPENDIX

TROUBLESHOOTING

The TV does not operate properly.

The remote control does not work

- Check to see if there is any object between the TV and the remote control causing an obstruction. Ensure you are pointing the remote control directly at the TV.
- Ensure that the batteries are installed with correct polarity (+ to +, - to -).
- Install new batteries.

Power is suddenly turned off

- Is the sleep timer set?
- Check the power control settings. Has the Power supply been interrupted.
- The TV goes into Standby mode automatically if no signal is received or no operation is performed for 15 minutes.

The video function does not work.

No picture & No sound

- Check whether the TV is switched on.
- Try another channel. The problem may be with the broadcast.
- Is the power cord inserted correctly into the mains?
- Check your antenna direction and/or location.
- Test the mains outlet by plugging another TV into the same outlet.

Picture appears slowly after switching on

- This is normal, the image is muted during the TV startup process. Please contact your service centre, if the picture has not appeared after five minutes.

No or poor colour or poor picture

- Adjust Colour in menu option.
- Allow a sufficient distance between the TV and the VCR.
- Try another channel. The problem may be with the broadcast.
- Are the video cables installed properly?
- Activate any function to restore the brightness of the picture.

Horizontal/vertical bars or picture shaking

- Check for local interference such as an electrical appliance or power tool.

Poor reception on some channels

- Station or cable channel experiencing problems, tune to another station.
- Station signal is weak, reposition the antenna to receive weaker stations.
- Check for sources of possible interference.

Lines or streaks in pictures

- Check antenna (Change the position of the antenna).

No picture when connecting HDMI

- Check HDMI cable over version 1.3.
If the HDMI cables don't support HDMI version 1.3, it can cause flickers or no screen display. In this case use the latest cables that support HDMI version 1.3.

The audio function does not work.

Picture OK & No sound	<ul style="list-style-type: none"> ■ Press the  + or - button. ■ Sound muted? Press MUTE button. ■ Try another channel. The problem may be with the broadcast. ■ Are the audio cables installed properly?
No output from one of the speakers	<ul style="list-style-type: none"> ■ Adjust Balance in menu option.
Unusual sound from inside the TV	<ul style="list-style-type: none"> ■ A change in ambient humidity or temperature may result in an unusual noise when the TV is switched on or off and does not indicate a fault with the TV.
No sound when connecting HDMI or USB	<ul style="list-style-type: none"> ■ Check HDMI cable over version 1.3. ■ Check USB cable over version 2.0. <p style="text-align: right; margin-top: 10px;">*This feature is not available for all models.</p>

There is a problem in PC mode. (Only PC mode applied)

The signal is out of range (Invalid format)	<ul style="list-style-type: none"> ■ Adjust resolution, horizontal frequency, or vertical frequency. ■ Check the input source.
Vertical bar or stripe on background & Horizontal Noise & Incorrect position	<ul style="list-style-type: none"> ■ Use Auto configure or adjust clock, phase, or H/V position. (Option)
Screen colour is unstable or single colour	<ul style="list-style-type: none"> ■ Check the signal cable. ■ Reinstall the PC video card.

There is a problem with PICTURE settings.

When the user changes the picture settings, the TV automatically converts back to the initial settings after a certain period of time.

- It means that the TV is currently set to **Store Demo** mode. To switch to **Home Use** mode you should do the followings:
From the TV Menu, choose **OPTION** -> Choose **Mode Setting** -> Choose **Home Use**.
Now, you have completed switching to the **Home Use** mode.

MAINTENANCE

Early malfunctions can be prevented. Careful and regular cleaning can prolong the life of your new TV.

Caution: Be sure to switch the power off and unplug the power cord before you begin any cleaning.

Cleaning the Screen

- 1 A good way to keep the dust off your screen for a while is to wet a soft cloth in a mixture of lukewarm water and a little fabric softener or dish washing detergent. Wring the cloth until it is almost dry, and then use it to wipe the screen.
- 2 Ensure there is no excess water on the screen. Allow any water or dampness to evaporate before switching on.

Cleaning the Cabinet

- To remove dirt or dust, wipe the cabinet with a soft, dry, lint-free cloth.
- Do not use a wet cloth.

Extended Absence

CAUTION

- ▶ If you expect to leave your TV dormant for prolonged periods (such as a holiday), unplug the power cord to protect against possible damage from lightning or power surges.

APPENDIX

PRODUCT SPECIFICATIONS

MODELS		42PQ2***	50PQ2***
		42PQ200R-ZA	50PQ200R-ZA
Dimensions (Width x Height x Depth)	with stand	1031.2 x 720.9 x 308.0 mm 40.5 x 28.3 x 12.1 inches	1216.7 x 818.1 x 353.0 mm 47.9 x 32.2 x 13.8 inches
	without stand	1031.2 x 656.7 x 80.8 mm 40.5 x 25.8 x 3.1 inches	1216.7 x 759.0 x 83.0 mm 47.9 x 29.8 x 3.2 inches
Weight	with stand	24.8 kg / 54.6 lbs	33.7 kg / 74.2 lbs
	without stand	22.7 kg / 50.0 lbs	31.2 kg / 68.7 lbs
Power requirement		AC100-240V~ 50/60Hz	AC100-240V~ 50/60Hz
Power Consumption		320W	430W
MODELS		42PQ3***	50PQ3***
		42PQ300R-ZA	50PQ300R-ZA
Dimensions (Width x Height x Depth)	with stand	1031.2 x 720.9 x 308.0 mm 40.5 x 28.3 x 12.1 inches	1216.7 x 818.1 x 353.0 mm 47.9 x 32.2 x 13.8 inches
	without stand	1031.2 x 656.7 x 80.8 mm 40.5 x 25.8 x 3.1 inches	1216.7 x 759.0 x 83.0 mm 47.9 x 29.8 x 3.2 inches
Weight	with stand	24.8 kg / 54.6 lbs	33.7 kg / 74.2 lbs
	without stand	22.7 kg / 50.0 lbs	31.2 kg / 68.7 lbs
Power requirement		AC100-240V~ 50/60Hz	AC100-240V~ 50/60Hz
Power Consumption		320W	430W
Television System		PAL/SECAM B/G/D/K, PAL I/II	
Program Coverage		VHF: NZ1 ~ E21, UHF: E21 ~ E69, CATV: S1 ~ S20, HYPER: S21 ~ S47	
External Antenna Impedance		75 Ω	
Environment condition	Operating Temperature	0 ~ 40°C / 32 ~ 104°F	
	Operating Humidity	Less than 80%	
	Storage Temperature	-20 ~ 60°C / -4 ~ 140°F	
	Storage Humidity	Less than 85%	

■ The specifications shown above may be changed without prior notice for quality improvement.

MODELS		42PQ6***	50PQ6***
		42PQ600R-ZA	50PQ600R-ZA
Dimensions (Width x Height x Depth)	with stand	1040.8 x 725.8 x 308.0 mm 40.9 x 28.5 x 12.1 inches	1228.8 x 824.6 x 353.0 mm 48.3 x 32.4 x 13.8 inches
	without stand	1040.8 x 669.2 x 76.8 mm 40.9 x 26.3 x 3.0 inches	1228.8 x 772 x 78.9 mm 48.3 x 30.39 x 3.1 inches
Weight	with stand	25.3 kg / 55.7 lbs	35.0 kg / 77.1 lbs
	without stand	23.3 kg / 51.3 lbs	32.5 kg / 71.6 lbs
Power requirement		AC100-240V~ 50/60Hz	AC100-240V~ 50/60Hz
Power Consumption		320W	430W
Television System		PAL/SECAM B/G/D/K, PAL I/II	
Program Coverage		VHF: NZ1~E21, UHF: E21 ~ E69, CATV: S1 ~ S20, HYPER: S21 ~ S47	
External Antenna Impedance		75 Ω	
Environment condition	Operating Temperature	0 ~ 40°C / 32 ~ 104°F	
	Operating Humidity	Less than 80%	
	Storage Temperature	-20 ~ 60°C / -4 ~ 140°F	
	Storage Humidity	Less than 85%	

■ The specifications shown above may be changed without prior notice for quality improvement.

APPENDIX

Code (Hexa)	Function	Note
95	ENERGY	R/C BUTTON
08	POWER	R/C BUTTON (POWER ON/OFF)
0B	INPUT	R/C BUTTON
79	RATIO	R/C BUTTON
45	Q.MENU	R/C BUTTON
43	MENU	R/C BUTTON
07	<	R/C BUTTON
06	>	R/C BUTTON
40	^	R/C BUTTON
41	v	R/C BUTTON
44	OK(⊙)	R/C BUTTON
28	RETURN	R/C BUTTON
30	AV MODE	R/C BUTTON
02	↙ +	R/C BUTTON
03	↙ -	R/C BUTTON
00	P ^	R/C BUTTON
01	P v	R/C BUTTON
1E	FAV	R/C BUTTON
09	MUTE	R/C BUTTON
10 ~ 19	Number Key 0~9	R/C BUTTON
53	LIST	R/C BUTTON
1A	Q.VIEW	R/C BUTTON
72	RED Key	R/C BUTTON
71	GREEN Key	R/C BUTTON
63	YELLOW Key	R/C BUTTON
61	BLUE Key / II	R/C BUTTON
20	TEXT	R/C BUTTON
21	T.OPT(T.Option)/ ◀◀	R/C BUTTON
7E	SIMPLINK	R/C BUTTON
65	FREEZE	R/C BUTTON
0E	SLEEP	R/C BUTTON
8E	▶▶	R/C BUTTON

: Except 42/50PQ2***, 42/50PQ3***

EXTERNAL CONTROL DEVICE SETUP

RS-232C Setup

Connect the RS-232C (serial port) input jack to an external control device (such as a computer or an A/V control system) to control the product's functions externally.

Connect the serial port of the control device to the RS-232C jack on the product back panel.

Note:

RS-232C connection cables are not supplied with the product.

In USB mode, it doesn't support RS-232C function.

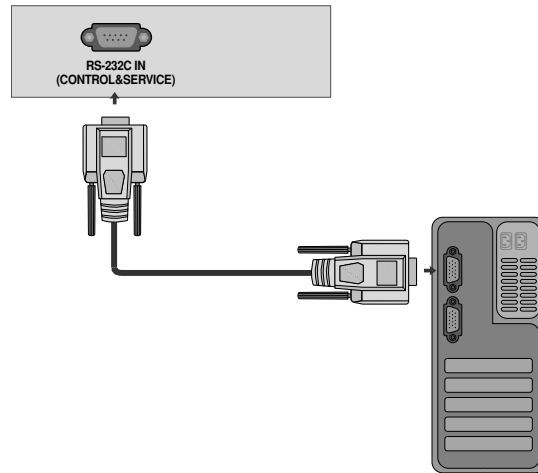

Type of Connector; D-Sub 9-Pin Male

No.	Pin Name
1	No connection
2	RXD (Receive data)
3	TXD (Transmit data)
4	DTR (DTE side ready)
5	GND
6	DSR (DCE side ready)
7	RTS (Ready to send)
8	CTS (Clear to send)
9	No Connection

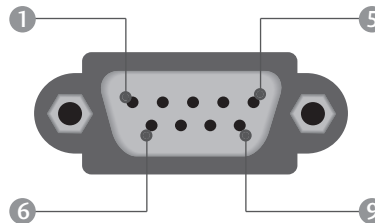

RS-232C Configurations

7-Wire Configurations (Standard RS-232C cable)

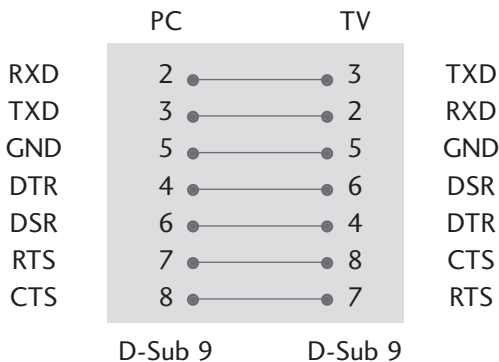

3-Wire Configurations (Not standard)

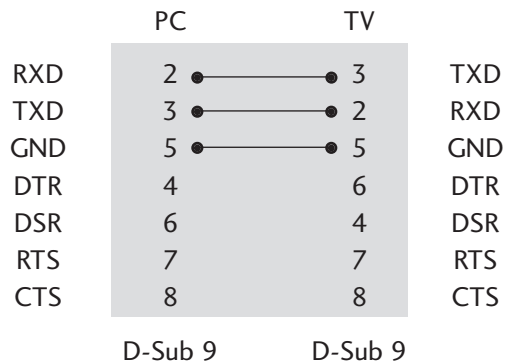

Set ID

Use this function to specify a set ID number.
Refer to 'Real Data Mapping' ▶ p. 104

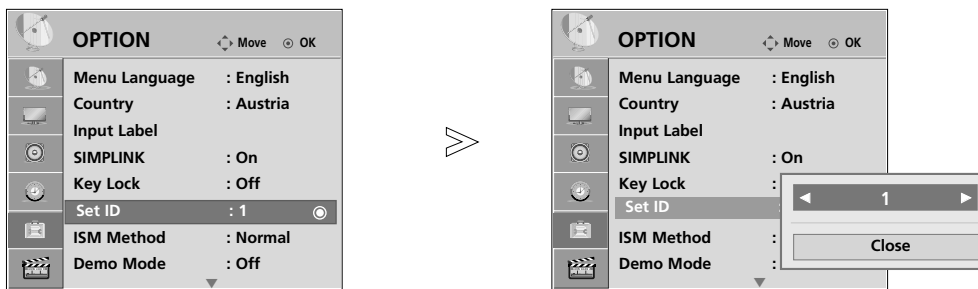

1   Select **OPTION**.

2   Select **Set ID**.

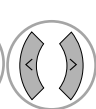
3   Adjust **Set ID** to choose the desired TV ID number.
The adjustment range of SET ID is 1~99.

- Press the **RETURN** button to move to the previous menu screen.

Communication Parameters

- Baud rate : 9600 bps (UART)
- Data length : 8 bits
- Parity : None
- Stop bit : 1 bit
- Communication code : ASCII code
- Use a crossed (reverse) cable.

Command Reference List

	COMMAND1	COMMAND2	DATA (Hexadecimal)		COMMAND1	COMMAND2	DATA (Hexadecimal)
01. Power	k	a	00 ~ 01	14. Colour Temperature	k	u	00 ~ 03
02. Aspect Ratio	k	c	Refer to p.102	15. Treble	k	r	00 ~ 64
03. Screen Mute	k	d	00 ~ 01, 10	16. Bass	k	s	00 ~ 64
04. Volume Mute	k	e	00 ~ 01	17. Abnormal Status	k	z	FF
05. Volume Control	k	f	00 ~ 64	18. ISM Method	j	p	Refer to p.104
06. Contrast	k	g	00 ~ 64	19. Auto Configure	j	u	01
07. Brightness	k	h	00 ~ 64	20. Energy Saving	j	q	00 ~ 04
08. Colour	k	i	00 ~ 64	21. Tune Command	m	a	Refer to p.105
09. Tint	k	j	00 ~ 64	22. Channel Skip	m	b	00 ~ 01
10. Sharpness	k	k	00 ~ 64	23. Key	m	c	Refer to p.98
11. OSD Select	k	l	00 ~ 01	24. Input select (Main)	x	b	Refer to p.106
12. Remote Control Lock /Key Lock Mode	k	m	00 ~ 01				
13. Balance	k	t	00 ~ 64				

Transmission / Receiving Protocol

Transmission

[Command1][Command2][][Set ID][][Data][Cr]

[Command 1] : First command to control the set.(j, k, m or x)

[Command 2] : Second command to control the set.

[Set ID] : You can adjust the set ID to choose desired TV ID number in Setup menu. Adjustment range is 1 ~ 99. When selecting Set ID '0', every connected TV is controlled. Set ID is indicated as decimal (1 ~ 99) on menu and as Hexa decimal (0x0~ 0x63) on transmission/receiving protocol.

[DATA] : To transmit command data.

Transmit 'FF' data to read status of comand.

[Cr] : Carriage Return

ASCII code '0x0D'

[] : ASCII code 'space (0x20)'

OK Acknowledgement

[Command2][][Set ID][][OK][Data][x]

The TV transmits ACK (acknowledgement) based on this format when receiving normal data. At this time, if the data is data read mode, it indicates present status data. If the data is data write mode, it returns the data of the PC computer.

Error Acknowledgement

[Command2][][Set ID][][NG][Data][x]

TV transmits ACK(acknowledgement) based on this format when receiving abnormal data form non-viable functions or communication errors.

[Command 2] : use as command.

[Set ID]: use the small character, if set ID is 10, TV will send the '0'; 'a'

[Data]: use the small character, if data is 0xab, TV will send the 'a'; 'b'.

[NG]: use the large character.

APPENDIX

01. Power (Command: k a)

To control Power On/Off of the TV.

Transmission [k][a][][Set ID][][Data][Cr]

Data 00 : Power Off Data 01 : Power On

Acknowledgement [a][][Set ID][][OK/NG][Data][x]

To show Power On/Off.

Transmission [k][a][][Set ID][][FF][Cr]

Acknowledgement [a][][Set ID][][OK/NG][Data][x]

* If there is the time delay between command and ack message during power on sequence, It should be described like "Note: In this model, TV will send the Acknowledge after power on processing completion. There might be a time delay between command and acknowledge."

02. Aspect Ratio (Command: k c) (Main picture size)

To adjust the screen format. (Main picture format)

You can adjust the screen format using the Aspect Ratio in the PICTURE menu.

Transmission [k][c][][Set ID][][Data][Cr]

Data 01: Normal screen (4:3) Data 06: Original

Data 02: Wide screen (16:9) Data 07: 14:9

Data 04: Zoom Data 09: Just Scan

Data 10~1F: Cinema Zoom1~ 16

Acknowledgement [c][][Set ID][][OK/NG][Data][x]

* Using the RGB-PC, Component or HDMI input, you select either 16:9 or 4:3 screen aspect ratio.

* In HDMI/Component (over 720p) mode, Just Scan is available.

03. Screen Mute (Command: k d)

To select screen mute on/off.

Transmission [k][d][][Set ID][][Data][Cr]

Data 00 : Screen mute off (Picture on)

Data 01 : Screen mute on (Picture off)

Data 00 : Video-Out Mute off

Data 10 : Video-Out Mute on

Acknowledgement [d][][Set ID][][OK/NG][Data][x]

In case of Video-Out mute on only, TV will display On Screen Display(OSD) But, In case of Screen Mute On, TV will not display OSD.

04. Volume Mute (Command: k e)

To control volume mute on/off.

You can also adjust mute using the MUTE button on remote control.

Transmission [k][e][][Set ID][][Data][Cr]

Data 00 : Volume mute on (Volume off)

Data 01 : Volume mute off (Volume on)

Acknowledgement [e][][Set ID][][OK/NG][Data][x]

05. Volume Control (Command: k f)

To adjust volume.

You can also adjust volume with the volume buttons on remote control.

Transmission [k][f][][Set ID][][Data][Cr]

Data Min : 00 ~ Max : 64

Refer to 'Real data mapping 1' : See page 104.

Acknowledgement [f][][Set ID][][OK/NG][Data][x]

06. Contrast (Command: k g)

To adjust screen contrast.

You can also adjust contrast in the PICTURE menu.

Transmission [k][g][][Set ID][][Data][Cr]

Data Min : 00 ~ Max : 64

Refer to 'Real data mapping 1' : See page 104.

Acknowledgement [g][][Set ID][][OK][Data][x]

07. Brightness (Command: k h)

To adjust screen brightness.

You can also adjust brightness in the PICTURE menu.

Transmission [k][h][][Set ID][][Data][Cr]

Data Min : 00 ~ Max : 64

Refer to 'Real data mapping 1' : See page 104.

Acknowledgement [h][][Set ID][][OK/NG][Data][x]

08. Colour (Command: k i)

To adjust the screen colour.

You can also adjust colour in the PICTURE menu.

Transmission [k][i][][Set ID][][Data][Cr]

Data Min : 00 ~ Max : 64

Refer to 'Real data mapping 1' : See page 104.

Acknowledgement [i][][Set ID][][OK/NG][Data][x]

09. Tint (Command: k j)

To adjust the screen tint.

You can also adjust tint in the PICTURE menu.

Transmission [k][j][][Set ID][][Data][Cr]

Data Red : 00 ~ Green : 64

Refer to 'Real data mapping 1' : See page 104.

Acknowledgement [j][][Set ID][][OK/NG][Data][x]

10. Sharpness (Command: k k)

To adjust the screen sharpness.

You can also adjust sharpness in the PICTURE menu.

Transmission [k][k][][Set ID][][Data][Cr]

Data Min: 00 ~ Max: 64

Refer to 'Real data mapping 1'. See page 104.

Acknowledgement [k][][Set ID][][OK/NG][Data][x]

11. OSD Select (Command: k l)

To select OSD (On Screen Display) on/off when controlling remotely.

Transmission [k][l][][Set ID][][Data][Cr]

Data 00: OSD off

Data 01: OSD on

Acknowledgement [l][][Set ID][][OK][Data][x]

12. Remote Control Lock/Key Lock Mode (Command: k m)

To lock the remote control and the front panel controls on the set.

(If you're not using the remote control and front panel controls on the TV, use this mode. When main power is on/off, remote control lock is released.)

Transmission [k][m][][Set ID][][Data][Cr]

Data 00: Lock off Data 01: Lock on

Acknowledgement [m][][Set ID][][OK/NG][Data][x]

13. Balance (Command: k t)

To adjust balance.

You can also adjust balance in the AUDIO menu.

Transmission [k][t][][Set ID][][Data][Cr]

Data Min: 00 ~ Max: 64

Refer to 'Real data mapping 1'. See page 104.

Acknowledgement [t][][Set ID][][OK/NG][Data][x]

14. Colour Temperature (Command: k u)

To adjust colour temperature.

You can also adjust Colour Temperature in the PICTURE menu.

Transmission [k][u][][Set ID][][Data][Cr]

Data 00: Medium 01: Cool 02: Warm

Acknowledgement [u][][Set ID][][OK/NG][Data][x]

15. Treble (Command: k r)

To adjust treble.

Transmission [k][r][][Set ID][][Data][Cr]

Data Min: 00 ~ Max: 64

Refer to 'Real data mapping 1'. See page 104.

Acknowledgement [r][][Set ID][][OK/NG][Data][x]

16. Bass (Command: k s)

To adjust bass.

Transmission [k][s][][Set ID][][Data][Cr]

Data Min: 00 ~ Max: 64

Refer to 'Real data mapping 1'. See page 104.

Acknowledgement [s][][Set ID][][OK/NG][Data][x]

17. Abnormal State (Command: k z)

To recognize an abnormal state.

Transmission [k][z][][Set ID][][FF][][Cr]

Data FF: Read

Acknowledgement [z][][Set ID][][OK/NG][Data][x]

Data 00: Normal (Power on and signal exist)

Data 01: No signal (Power on)

Data 02: Turn the TV off by remote control

Data 03: Turn the TV off by sleep time function

Data 04: Turn the TV off by RS-232C function

Data 05: 5V down

Data 06: AC down

Data 07: Turn the TV off by Fan Alarm function (option)

Data 08: Turn the TV off by Off time function

Data 09: Turn the TV off by Auto off function

Data a: Turn the TV off by AV board detection.

* This function is "read only".

APPENDIX

18. ISM Method (Command: j p)

To avoid having a fixed image remain on screen.

Transmission [j][p][][Set ID][][Data][Cr]

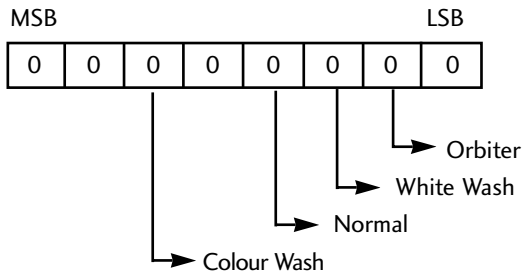

7	6	5	4	3	2	1	0	Function
				0	0	1	0	Orbiter
				0	1	0	0	White Wash
				1	0	0	0	Normal
		1	0	0	0	0	0	Colour Wash

Data 02: Orbiter

Data 04: White Wash

Data 08: Normal

Data 20: Colour Wash

* More two kinds of function can not be set at a time.

Acknowledgement [p][][Set ID][][OK/NG][Data][x]

19 . Auto Configure (Command: j u)

To adjust picture position and minimize image shaking automatically. It works only in RGB (PC) mode.

Transmission [j][u][][Set ID][][Data][Cr]

Data 01: To set

Acknowledgement [u][][Set ID][][OK/NG][Data][x]

20. Energy Saving (Command: j q)

To reduce the power consumption of the TV.

Transmission [j][q][][Set ID][][Data][][Cr]

Data 00: Low Power Off

Data 01: Low Power Minimum

Data 02: Low Power Medium

Data 03: Low Power Maximum

Data 10: Intelligent Sensor Low

Data 11: Intelligent Sensor Middle

Data 12: Intelligent Sensor High

Acknowledgement [q][][Set ID][][OK/NG][Data][x]

* Real data mapping 1

00 : Step 0
 ⋮
 A : Step 10
 ⋮
 F : Step 15
 10 : Step 16
 ⋮
 64 : Step 100
 ⋮
 6E : Step 110
 ⋮
 73 : Step 115
 74 : Step 116
 ⋮
 C7 : Step 199
 ⋮
 FE : Step 254
 FF : Step 255

* Real data mapping 2

00: -30
 01: -29
 02: -28
 ⋮
 1E: 0
 ⋮
 28: +10
 ⋮
 3A: +28
 3B: +29
 3C: +30
 ⋮
 4E: N/A
 4F: N/A
 50: N/A

21 . Tune Command / Channel Tuning (Command: m a)

Tune Channel to following Physical number.

```
Transmission [m][a][ ][Set ID][ ][Data0][ ][Data1]
           [ ][Data2][Cr]
```

Data0, Data1 : Program Number

Data0: High byte

Data1 : Low byte

Data2: Attribute

Air

7 Reserved	6 Reserved	5 Reserved	4 Reserved	RF Source	3 Reserved	2 Reserved	1 Reserved	0	
								Data	Main / Sub
0	x	0	0	ATV	x	x	x	0	Main picture
0	x	0	1	DTV	x	x	x	1	Sub picture
0	x	1	0	Radio					
0	x	1	1	Reserved					

Cable

7 Reserved	6 Reserved	5 Reserved	4 Reserved	RF Source	3 Reserved	2 Reserved	1 Reserved	0	
								Data	Main / Sub
1	x	0	0	ATV	x	x	x	0	Main picture
1	x	0	1	DTV	x	x	x	1	Sub picture
1	x	1	0	Radio					
1	x	1	1	Reserved					

'x' : don't care

```
Acknowledgement [a][ ][Set ID][OK][ ][Data0][Data1][x]
                [a][ ][Set ID][NG][ ][Data0][x]
```

22. Channel Skip(Command: m b)

To set skip status for the current Programme.

```
Transmission [m][b][ ][Set ID][ ][Data][Cr]
```

Data 00 : Skip 01 : Add

```
Acknowledgement [b][ ][Set ID][ ][OK/NG][Data][x]
```

23. Key (Command: m c)

To send IR remote key code.

```
Transmission [m][c][ ][Set ID][ ][Data][Cr]
```

Data: Key code - Refer to page 98.

```
Acknowledgement [c][ ][Set ID][ ][OK/NG][Data][x]
```

APPENDIX

24. Input select (Command: x b)

(Main Picture Input)

To select input source for TV

Transmission [x][b][][Set ID][][Data][Cr]

Data: Structure

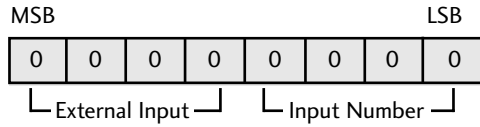

External Input				Data
0	0	0	1	Analog
0	0	1	0	AV
0	1	0	0	Component
0	1	1	0	RGB-PC
1	0	0	1	HDMI

Input Number				Data
0	0	0	0	Input1
0	0	0	1	Input2
0	0	1	0	Input3
0	0	1	1	Input4

Acknowledgement [b][][Set ID][][OK/NG][Data][x]

LG Electronics Inc.