



LG

Life's Good

OWNER'S MANUAL PLASMA TV

Please read this manual carefully before operating your set and retain it for future reference.

42PJ250
50PJ250
50PK250
60PK250
60PK280
60PK290

42PJ340
50PJ340
42PJ350
50PJ350

50PK350
50PK340
50PK540
60PK540

42PJ550
50PJ550
50PK550
60PK550

42PJ350C
50PJ350C
50PK550C
60PK550C

WARNING / CAUTION



WARNING / CAUTION
RISK OF ELECTRIC SHOCK
DO NOT OPEN



TO REDUCE THE RISK OF ELECTRIC SHOCK
DO NOT REMOVE COVER (OR BACK). NO
USER SERVICEABLE PARTS INSIDE. REFER TO
QUALIFIED SERVICE PERSONNEL.



The lightning flash with arrowhead symbol, within an equilateral triangle, is intended to alert the user to the presence of uninsulated “dangerous voltage” within the product’s enclosure that may be of sufficient magnitude to constitute a risk of electric shock to persons.



The exclamation point within an equilateral triangle is intended to alert the user to the presence of important operating and maintenance (servicing) instructions in the literature accompanying the appliance.

WARNING/CAUTION

TO REDUCE THE RISK OF FIRE AND ELECTRIC SHOCK, DO NOT EXPOSE THIS PRODUCT TO RAIN OR MOISTURE.

NOTE TO CABLE/TV INSTALLER

This reminder is provided to call the CATV system installer’s attention to Article 820-40 of the National Electric Code (U.S.A.). The code provides guidelines for proper grounding and, in particular, specifies that the cable ground shall be connected to the grounding system of the building, as close to the point of the cable entry as practical.

WARNING / CAUTION

To prevent fire or shock hazards, do not expose this product to rain or moisture.

FCC NOTICE

Class B digital device

This equipment has been tested and found to comply with the limits for a Class B digital device, pursuant to Part 15 of the FCC Rules. These limits are designed to provide reasonable protection against harmful interference in a residential installation. This equipment generates, uses and can radiate radio frequency energy and, if not installed and used in accordance with the instructions, may cause harmful interference to radio communications. However, there is no guarantee that interference will not occur in a particular installation. If this equipment does cause harmful interference to radio or television reception, which can be determined by turning the equipment off and on, the user is encouraged to try to correct the interference by one or more of the following measures:

- Reorient or relocate the receiving antenna.
- Increase the separation between the equipment and receiver.
- Connect the equipment to an outlet on a circuit different from that to which the receiver is connected.
- Consult the dealer or an experienced radio/TV technician for help.

This device complies with part 15 of the FCC Rules.

Operation is subject to the following two conditions: (1) This device may not cause (harmful) interference, and (2) this device must accept any interference received, including interference that may cause undesired operation (of the device).

Any changes or modifications not expressly approved by the party responsible for compliance could void the user’s authority to operate the equipment.

CAUTION

Do not attempt to modify this product in any way without written authorization from LG Electronics. Unauthorized modification could void the user’s authority to operate this product

SAFETY INSTRUCTIONS

IMPORTANT SAFETY INSTRUCTIONS

Read these instructions.

Keep these instructions.

Heed all warnings.

Follow all instructions.



- 1 Do not use this apparatus near water.

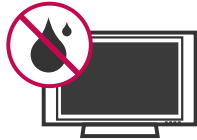

- 2 Clean only with soft dry cloth.



- 3 Do not block any ventilation openings. Install in accordance with the manufacturer's instructions.



- 4 Do not install near any heat sources such as radiators, heat registers, stoves, or other apparatus (including amplifiers) that produce heat.



- 5 Do not defeat the safety purpose of the polarized or grounding-type plug. A polarized plug has two blades with one wider than the other. A grounding type plug has two blades and a third grounding prong. The wide blade or the third prong are provided for your safety. If the provided plug does not fit into your outlet, consult an electrician for replacement of the obsolete outlet.



- 6 Protect the power cord from being walked on or pinched particularly at plugs, convenience receptacles, and the point where they exit from the apparatus.



- 7 Only use attachments/accessories specified by the manufacturer.



- 8 Use only with the cart, stand, tripod, bracket, or table specified by the manufacturer, or sold with the apparatus. When a cart is used, use caution when moving the cart/apparatus combination to avoid injury from tip-over.



- 9 Unplug this apparatus during lightning storms or when unused for long periods of time.

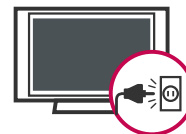

- 10 Refer all servicing to qualified service personnel. Servicing is required when the apparatus has been damaged in any way, such as power-supply cord or plug is damaged, liquid has been spilled or objects have fallen into the apparatus, the apparatus has been exposed to rain or moisture, does not operate normally, or has been dropped.

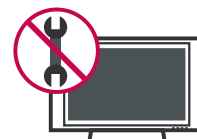

SAFETY INSTRUCTIONS

11 Never touch this apparatus or antenna during a thunder or lightning storm.

12 When mounting a TV on the wall, make sure not to install the TV by the hanging power and signal cables on the back of the TV.

13 Do not allow an impact shock or any objects to fall into the product, and do not drop onto the screen with something.

14 **CAUTION** concerning the Power Cord:
It is recommend that appliances be placed upon a dedicated circuit; that is, a single outlet circuit which powers only that appliance and has no additional outlets or branch circuits. Check the specification page of this owner's manual to be certain.

Do not connect too many appliances to the same AC power outlet as this could result in fire or electric shock.

Do not overload wall outlets. Overloaded wall outlets, loose or damaged wall outlets, extension cords, frayed power cords, or damaged or cracked wire insulation are dangerous. Any of these conditions could result in electric shock or fire. Periodically examine the cord of your appliance, and if its appearance indicates damage or deterioration, unplug it, discontinue use of the appliance, and have the cord replaced with an exact replacement part by an authorized servicer. Protect the power cord from physical or mechanical abuse, such as being twisted, kinked, pinched, closed in a door, or walked upon. Pay particular attention to plugs, wall outlets, and the point where the cord exits the appliance.

Do not make the TV with the power cord plugged in. Do not use a damaged or loose power cord. Be sure do grasp the plug when unplugging the power cord. Do not pull on the power cord to unplug the TV.

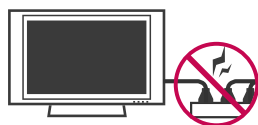

15 **WARNING** - To reduce the risk of fire or electrical shock, do not expose this product to rain, moisture or other liquids. Do not touch the TV with wet hands. Do not install this product near flammable objects such as gasoline or candles or expose the TV to direct air conditioning.



16 Do not expose to dripping or splashing and do not place objects filled with liquids, such as vases, cups, etc. on or over the apparatus (e.g. on shelves above the unit).



17 GROUNDING

Ensure that you connect the earth ground wire to prevent possible electric shock (i.e. a TV with a three-prong grounded AC plug must be connected to a three-prong grounded AC outlet). If grounding methods are not possible, have a qualified electrician install a separate circuit breaker.

Do not try to ground the unit by connecting it to telephone wires, lightning rods, or gas pipes.

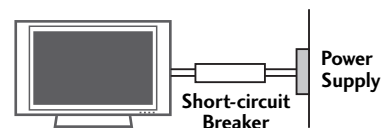

18 **DISCONNECTING DEVICE FROM MAINS**
Mains plug is the disconnecting device. The plug must remain readily operable.

19 "As long as this unit is connected to the AC wall outlet, it is not disconnected from the AC power source even if you turn off this unit by SWITCH"

20 ANTENNAS

Outdoor antenna grounding

If an outdoor antenna is installed, follow the precautions below. An outdoor antenna system should not be located in the vicinity of overhead power lines or other electric light or power circuits, or where it can come in contact with such power lines or circuits as death or serious injury can occur.

Be sure the antenna system is grounded so as to provide some protection against voltage surges and built-up static charges.

Section 810 of the National Electrical Code (NEC) in the U.S.A. provides information with respect to proper grounding of the mast and supporting structure, grounding of the lead-in wire to an antenna discharge unit, size of grounding conductors, location of antenna discharge unit, connection to grounding electrodes and requirements for the grounding electrode.

Antenna grounding according to the National Electrical Code, ANSI/NFPA 70

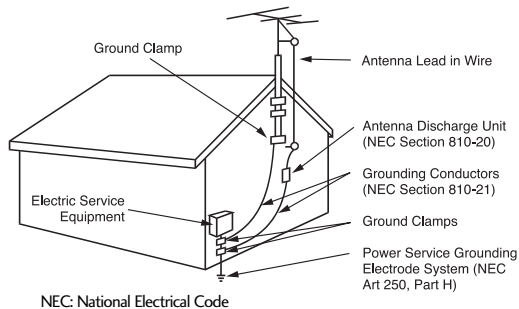

21 Cleaning

When cleaning, unplug the power cord and scrub gently with a soft cloth to prevent scratching. Do not spray water or other liquids directly on the TV as electric shock may occur. Do not clean with chemicals such as alcohol, thinners or benzene.

22 Moving

Make sure the product is turned off, unplugged and all cables have been removed. It may take 2 or more people to carry larger TVs. Do not press against or put stress on the front panel of the TV.

23 Ventilation

Install your TV where there is proper ventilation. Do not install in a confined space such as a bookcase. Do not cover the product with cloth or other materials (e.g.) plastic while plugged in. Do not install in excessively dusty places.

24 Take care not to touch the ventilation openings. When watching the TV for a long period, the ventilation openings may become hot.

25 If you smell smoke or other odors coming from the TV or hear strange sounds, unplug the power cord contact an authorized service center.

26 Do not press strongly upon the panel with hand or sharp object such as nail, pencil or pen, or make a scratch on it. Do not allow a impact shock onto the panel.

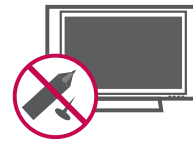

27 Keep the product away from direct sunlight.

CONTENTS

WARNING / CAUTION	2
SAFETY INSTRUCTIONS	3
FEATURE OF THIS TV	8

PREPARATION

Accessories	9
Front Panel Information	10
Back Panel Information	13
Stand Instruction	15
Cable Management	17
Desktop Pedestal Installation	18
Swivel Stand	18
VESA Wall Mounting	19
Securing the TV to the wall to prevent falling when the TV is used on a stand	20
Antenna or Cable Connection	21

EXTERNAL EQUIPMENT SETUP

HD Receiver Setup	22
DVD Setup	25
VCR Setup	27
Other A/V Source Setup	28
USB Connection	28
Audio Out Connection	29
PC Setup	30

WATCHING TV / CHANNEL CONTROL

Remote Control Functions	36
Turning On TV	38
Channel Selection	38
Volume Adjustment	38
Initial Setting	39
On-Screen Menus Selection	40
Quick Menu	42
Channel Setup	
- Auto Scan (Auto Tuning)	43

- Add / Delete Channel (Manual Tuning)	44
- Channel Editing	45
Channel List	46
Favorite Channel Setup	47
Favorite Channel List	47
Brief Information	48
Input List	49
Input Label	50
AV Mode	51
SIMPLINK	52

USB

Entry Modes	54
Photo List	55
Music List	61

PICTURE CONTROL

Picture Size (Aspect Ratio) Control	64
Picture Wizard	66
 Energy Saving	68
Preset Picture Settings(Picture Mode)	69
Manual Picture Adjustment - User Mode	70
Picture Improvement Technology	71
Expert Picture Control	72
Picture Reset	74
Demo Mode	74
Image Sticking Minimization (ISM) Method	75

SOUND & LANGUAGE CONTROL

Auto Volume Leveler (Auto Volume)	76
Clear Voice II	77
Preset Sound Settings (Sound Mode)	78
Sound Setting Adjustment - User Mode	79
Balance	81
TV Speakers On/Off Setup	82
Audio Reset	83
Stereo/SAP Broadcasts Setup	84
Audio Language	85
On-Screen Menus Language Selection	86
Caption Mode	
- Analog Broadcasting System Captions	87
- Digital Broadcasting System Captions	88
- Caption Option	89

TIME SETTING

Clock Setting	
- Auto Clock Setup	90
- Manual Clock Setup	91
Auto On/Off Time Setting	92
Sleep Timer Setting	93

PARENTAL CONTROL / RATINGS

Set Password & Lock System	94
Channel Blocking	97
Movie & TV Rating	98
Downloadable Rating	103
External Input Blocking	104
Key lock	105

APPENDIX

Troubleshooting	106
Maintenance	108
Product Specifications	109
IR Codes	112
External Control Through RS-232C	114

FEATURE OF THIS TV

- This feature is not available for all models.



High-definition television. High-resolution digital television broadcast and playback system composed of roughly a million or more pixels, 16:9 aspect-ratio screens, and AC3 digital audio. A subset of digital television, HDTV formats include 1080i and 720p resolutions.



Manufactured under license from Dolby Laboratories. "Dolby" and the double-D symbol are trademarks of Dolby Laboratories.



This TV contains the detailed calibrations necessary for professional certification by the Imaging Science Foundation. The resulting ISF "day" and "night" modes will then be accessible by the user to experience the best their LG HDTV has to offer. Sophisticated and detailed calibrations can be made through the ISFccc mode. Detailed calibration requires a licensed technician. Please contact your local dealer to inquire about an ISF certified technician.



HDMI, the HDMI logo and High-Definition Multimedia Interface are trademarks or registered trademarks of HDMI Licensing LLC."



AV Mode is three preset picture and audio settings. It allows the viewer to quickly switch between common settings. It includes Cinema, Sports, and Game Modes.



Unlike other sensors which can only sense brightness of ambient light, LG's "Intelligent Sensor" uses 4,096 sensing steps to evaluate its surroundings. Using a sophisticated algorithm, the LG processes picture quality elements including brightness, contrast, color, sharpness and white balance. The result is a picture optimized for it's surroundings, more pleasing to watch and which can also save up to 50% in power consumption.



Automatically enhances and amplifies the sound of human voice frequency range to help keep dialogue audible when background noise swells.



View videos and photos and listen to music on your TV through USB 2.0 ('videos' dependent on model).



Displays HDTV programs in full 1920 x 1080p resolution for a more detailed picture.



IMPORTANT INFORMATION TO PREVENT "IMAGE BURN / BURN-IN" ON YOUR TV SCREEN

- When a fixed image (e.g. logos, screen menus, video game, and computer display) is displayed on the TV for an extended period, it can become permanently imprinted on the screen. This phenomenon is known as "image burn" or "burn-in." Image burn is not covered under the manufacturer's warranty.
- In order to prevent image burn, avoid displaying a fixed image on your TV screen for a prolonged period (2 or more hours for LCD, 1 or more hours for Plasma).
- Image burn can also occur on the letterboxed areas of your TV if you use the 4:3 aspect ratio setting for an extended period.

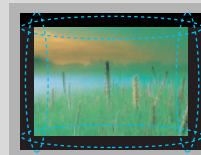
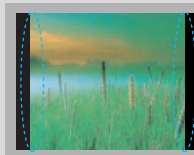

PREPARATION

ACCESSORIES

Ensure that the following accessories are included with your TV. If an accessory is missing, please contact the dealer where you purchased the TV.

The accessories included may differ from the images below.

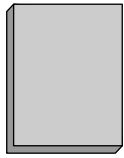

Owner's Manual

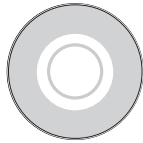

CD Manual

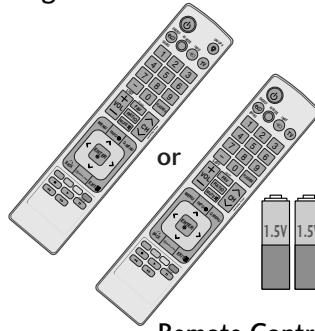

or

Remote Control,
Batteries

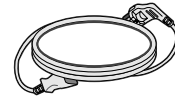

Power Cord

(Except 60PK250, 60PK540,
60PK550, 60PK280, 60PK290,
60PK550C)

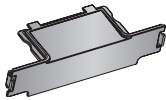

Protection Cover
(Refer to P.16)

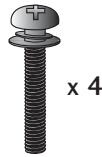

x 4

M4x28

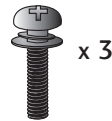

x 3

M5x14

Bolts for stand assembly
(Refer to P.15)



x 2

Cable Holder

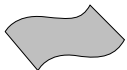

Polishing Cloth

(Not included with all models)

* Wipe spots on the exterior only with the polishing cloth.

* Do not wipe roughly when removing stain. Excessive pressure may cause scratch or discoloration.

Option Extras

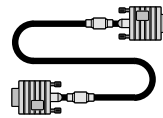

D-sub 15 pin Cable

When using the VGA (D-sub 15 pin cable) PC connection, the user must use shielded signal interface cables with ferrite cores to maintain standards compliance.



Ferrite Core
(Gray)

(This feature is not available for all models.)

The ferrite core can be used to reduce the electromagnetic waves in the PC Audio cable. Wind the PC Audio cable on the ferrite core twice, and then plug the cables into the TV as shown in the following picture.

Place the ferrite core close to AUDIO IN(RGB/DVI) jack on the display.

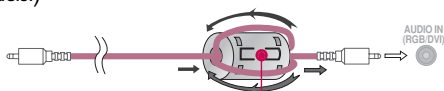

Place the ferrite core close to AUDIO IN(RGB/DVI) jack on the display.



Ferrite Core
(Black)

(This feature is not available for all models.)

Ferrite core can be used to reduce the electromagnetic waves that may interfere with the TV. Install the Ferrite core on the power cable close to the wall plug.

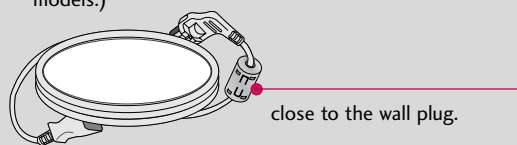

close to the wall plug.

PREPARATION

FRONT PANEL INFORMATION

■ Image shown may differ from your TV.

PREPARATION

50/60PK550, 50/60PK540, 42/50PJ550, 50/60PK550C

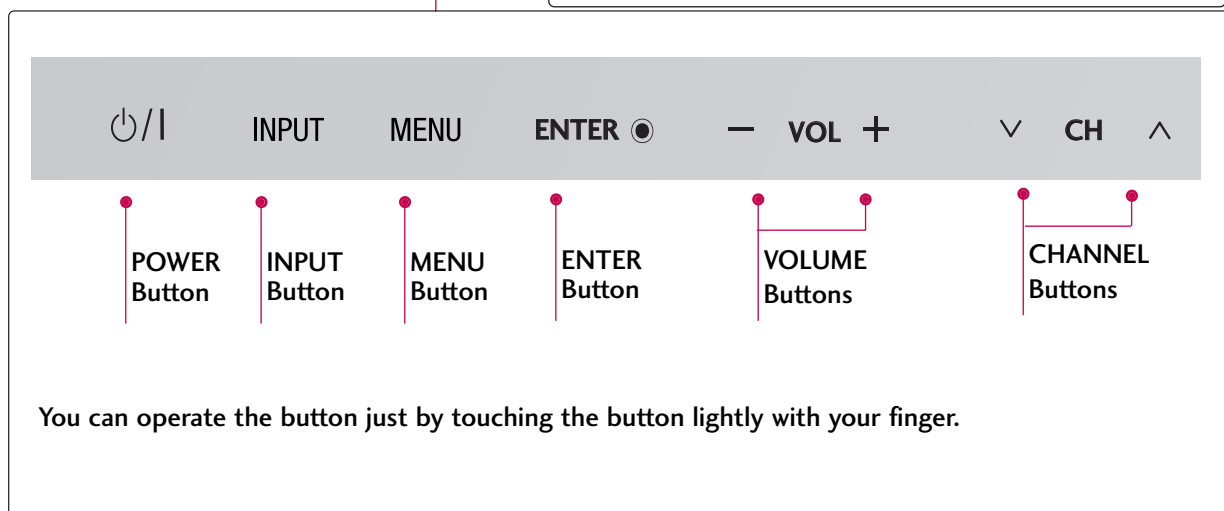
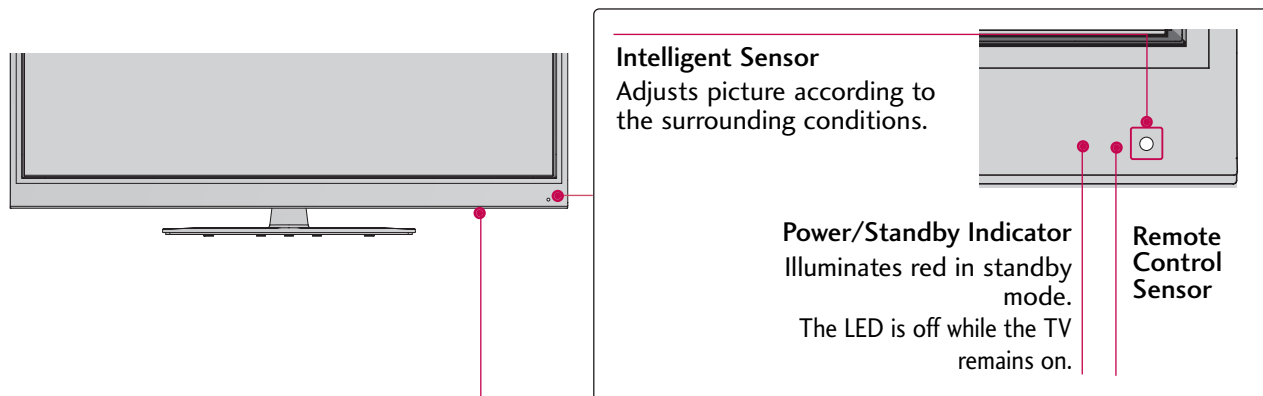

50/60PK250, 42/50PJ250, 60PK280, 60PK290

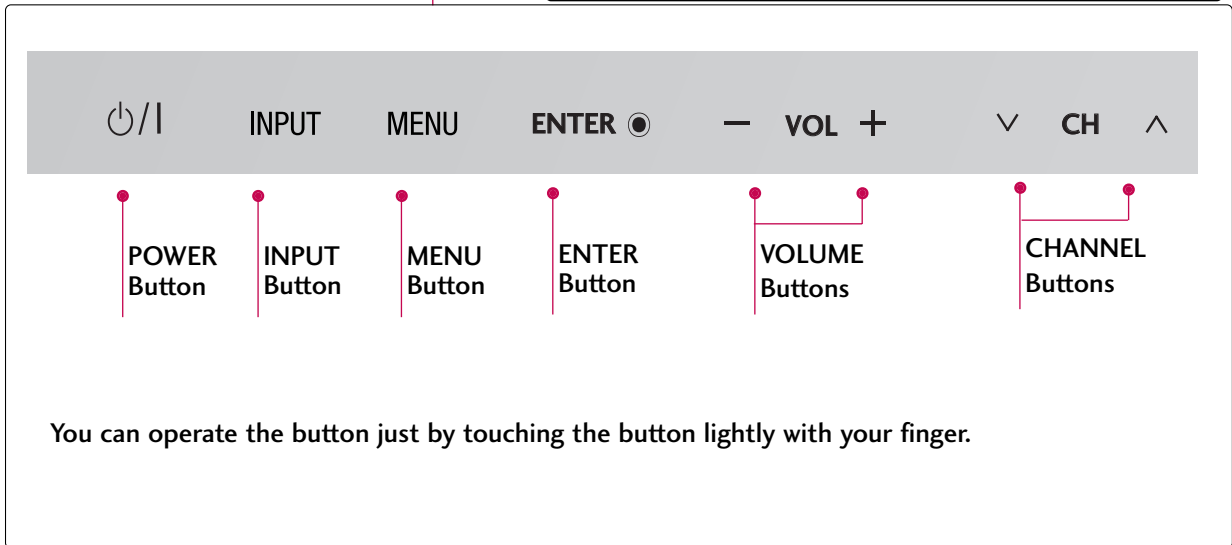
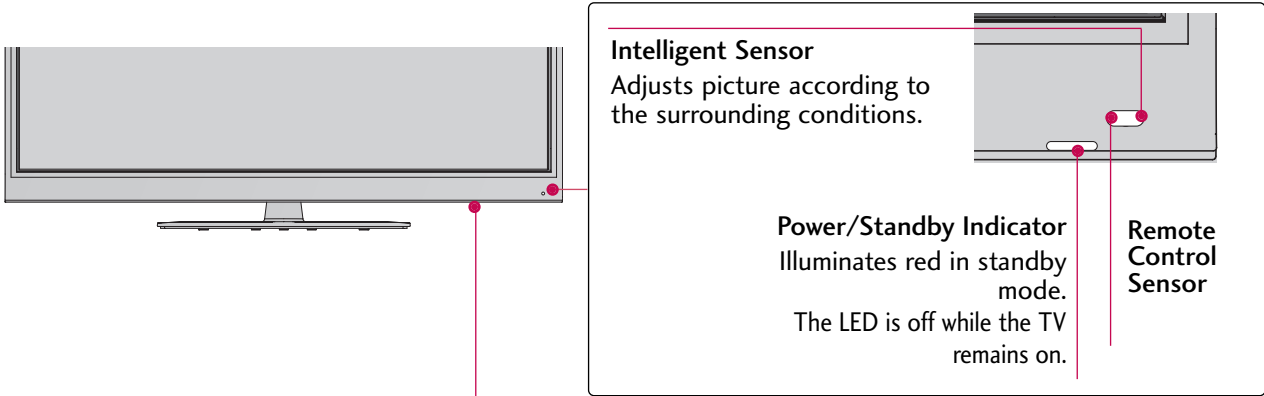

PREPARATION

42/50PJ350, 42/50PJ340, 50PK340, 50PK350, 42/50PJ350C



Intelligent Sensor
Adjusts picture according to the surrounding conditions.

Power/Standby Indicator
Illuminates red in standby mode.
The LED is off while the TV remains on.

Remote Control Sensor

A close-up diagram of the bottom right corner of the TV. It shows three small red dots and a small square sensor. Red lines connect these elements to the text in the callout box.A diagram of the TV's touch-sensitive control panel. It shows a row of buttons: a power icon, 'INPUT', 'MENU', 'ENTER' with a circle icon, 'VOL' with minus and plus signs, 'CH' with up and down arrows. Below each button is a red dot and a label: 'POWER Button', 'INPUT Button', 'MENU Button', 'ENTER Button', 'VOLUME Buttons', and 'CHANNEL Buttons'.

You can operate the button just by touching the button lightly with your finger.

- ▶ Do not step on the glass stand or subject it to any impact. It may break, causing possible injury from fragments of glass, or the TV may fall.
- ▶ Do not drag the TV. The floor or the product may be damaged.

BACK PANEL INFORMATION

Image shown may differ from your TV.

**42/50PJ250, 50/60PK250, 60PK280, 42/50PJ340,
50/60PK540, 50PK340**

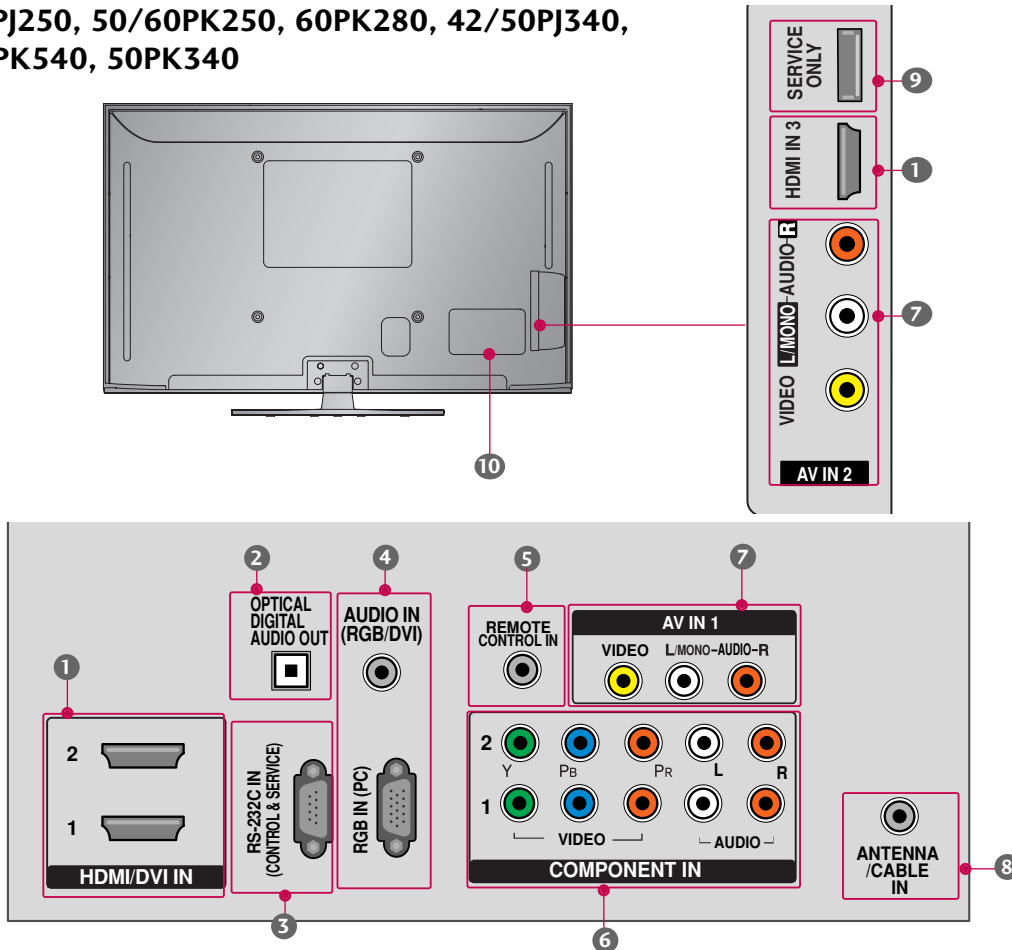

- 1 HDMI/DVI IN**
Digital Connection. Supports HD video and Digital audio. Doesn't support 480i.
Accepts DVI video using an adapter or HDMI to DVI cable (not included)
- 2 OPTICAL DIGITAL AUDIO OUT**
Optical digital audio output for use with amps and home theater systems.
Note: In standby mode, this port doesn't work.
- 3 RS-232C IN (CONTROL & SERVICE) PORT**
Used by third party devices.
- 4 AUDIO IN (RGB)
RGB IN (PC)**
1/8" headphone jack for analog PC audio input.
Analog PC Connection. Uses a D-sub 15 pin cable (VGA cable).
- 5 REMOTE CONTROL IN PORT**
For a wired remote control.
- 6 COMPONENT IN**
Analog Connection. Supports HD.
Uses a red, green, and blue cable for video & red and white for audio.
- 7 AV (Audio/Video) IN**
Analog composite connection. Supports standard definition video only (480i).
- 8 ANTENNA/CABLE IN**
Connect over-the air signals to this jack.
Connect cable signals to this jack.
- 9 SERVICE ONLY**
Used for software updates.
- 10 Power Cord Socket**
For operation with AC power.
Caution: Never attempt to operate the TV on DC power.

PREPARATION

42/50PJ350, 50PK350, 50/60PK550, 42/50PJ550,
60PK290, 42/50PJ350C, 50/60PK550C

PREPARATION

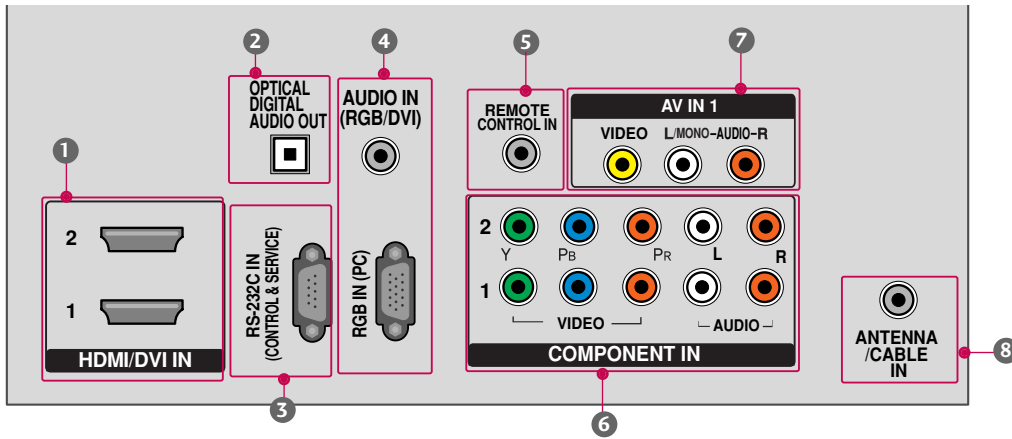
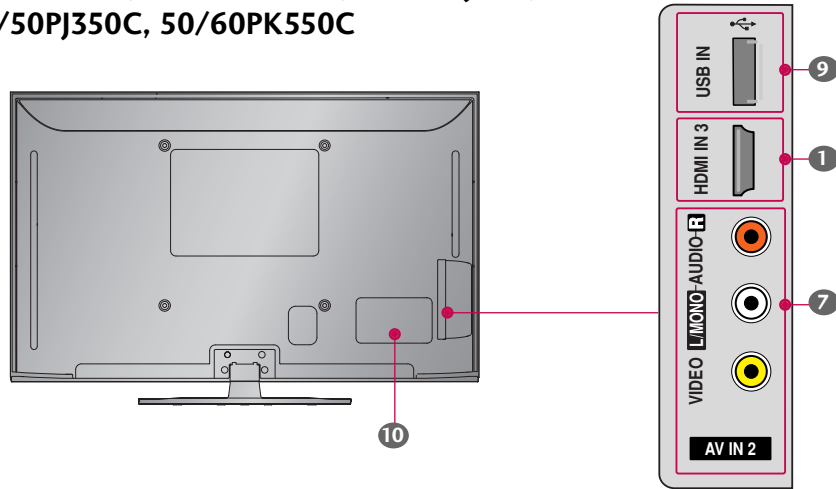

1 HDMI/DVI IN

Digital Connection. Supports HD video and Digital audio. Doesn't support 480i.
Accepts DVI video using an adapter or HDMI to DVI cable (not included)

2 OPTICAL DIGITAL AUDIO OUT

Optical digital audio output for use with amps and home theater systems.
Note: In standby mode, this port doesn't work.

3 RS-232C IN (CONTROL & SERVICE) PORT

Used by third party devices.

AUDIO IN (RGB)

4 1/8" headphone jack for analog PC audio input.

RGB IN (PC)

Analog PC Connection. Uses a D-sub 15 pin cable (VGA cable).

REMOTE CONTROL IN PORT

5 For a wired remote control.

6 COMPONENT IN

Analog Connection. Supports HD.
Uses a red, green, and blue cable for video & red and white for audio.

7 AV (Audio/Video) IN

Analog composite connection. Supports standard definition video only (480i).

8 ANTENNA/CABLE IN

Connect over-the air signals to this jack.
Connect cable signals to this jack.

9 USB IN

Used for viewing photos and listening to MP3.

10 Power Cord Socket

For operation with AC power.
Caution: Never attempt to operate the TV on DC power.

STAND INSTRUCTION

▪ Image shown may differ from your TV.

Installation (Except 60PK250, 60PK540, 60PK550, 60PK280, 60PK290, 60PK550C)

- 1 Carefully place the TV screen side down on a cushioned surface to protect the screen from damage.

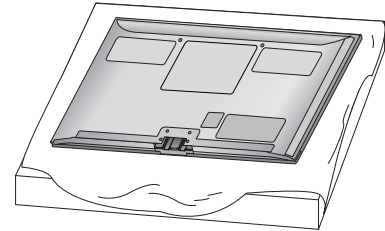

- 2 Assemble the parts of the Stand Body with the Stand Base of the TV.

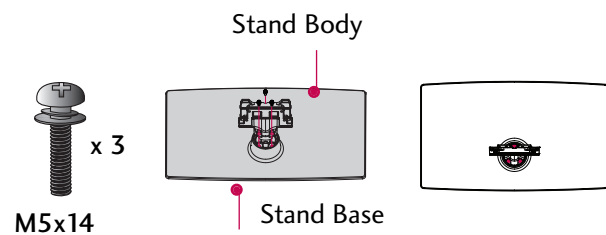

- 3 Assemble the TV as shown.

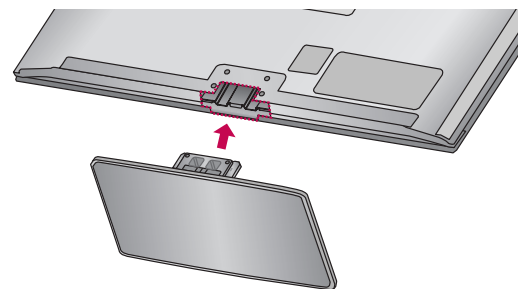

- 4 Fix the 4 bolts securely using the holes in the back of the TV.

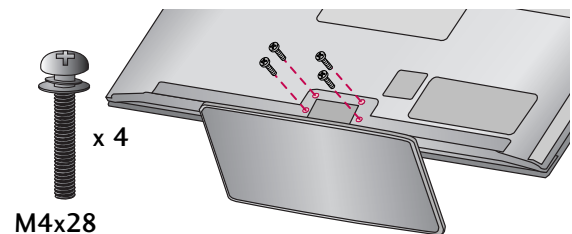

PREPARATION

Detachment

- 1 Carefully place the TV screen side down on a cushioned surface to protect the screen from damage.

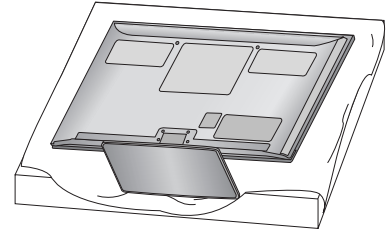

- 2 Loosen the bolts from TV.

(42/50PJ250, 50PK250, 42/50PJ340, 42/50PJ350, 50PK350, 50PK340, 50PK540, 42/50PJ550, 50PK550, 42/50PJ350C, 50PK550C)

(60PK250, 60PK540, 60PK550, 60PK280, 60PK290, 60PK550C)

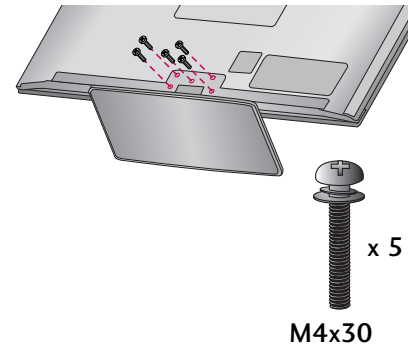
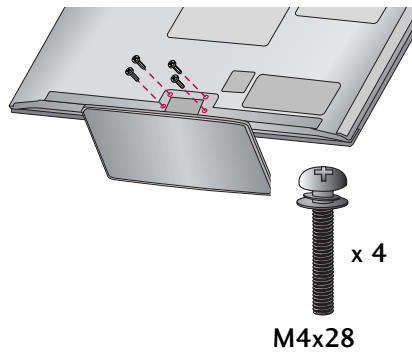

- 3 Detach the stand from TV.

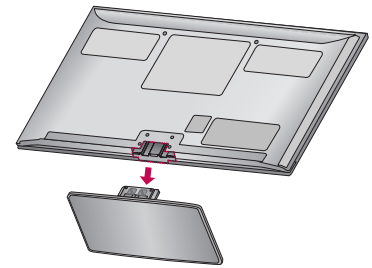

PROTECTION COVER
(Fix a Guide to the Outsides.)

Protection Cover

After removing the stand, install the included **protection cover** over the hole for the stand. Press the **PROTECTION COVER** into the TV until you hear it click.

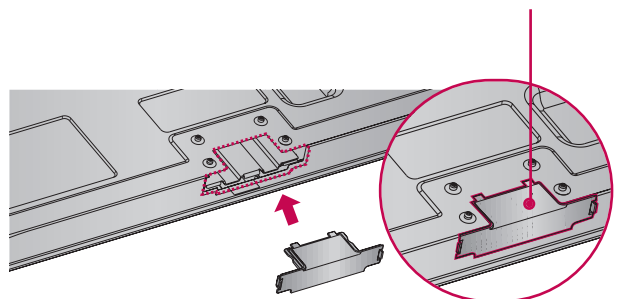

CABLE MANAGEMENT

■ Image shown may differ from your TV.

- 1 After connecting the cables as necessary, install **CABLE HOLDER** as shown and bundle the cables. To connect additional equipment, see **EXTERNAL EQUIPMENT SETUP** section.

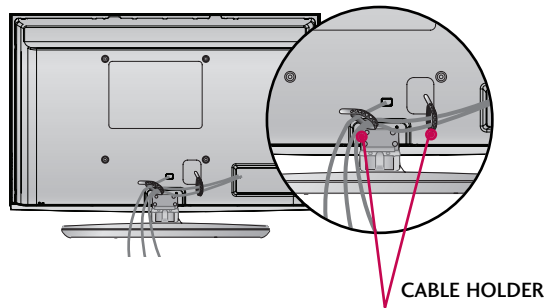

PREPARATION

DESKTOP PEDESTAL INSTALLATION

- Image shown may differ from your TV.

For proper ventilation, allow a clearance of 4 inches on all four sides from the wall.

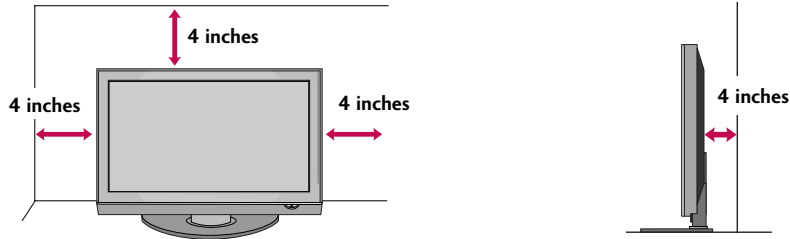

⚠ CAUTION

- ▶ Ensure adequate ventilation by following the clearance recommendations.
- ▶ Do not mount near or above any type of heat source.

SWIVEL STAND

(This feature is not available for all models.)

After installing the TV, you can adjust the TV manually to the left or right direction by 20 degrees to suit your viewing position.

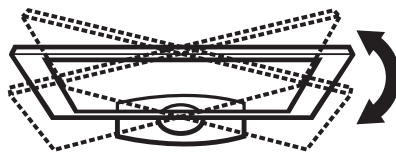

VESA WALL MOUNTING

Install your wall mount on a solid wall perpendicular to the floor. When attaching to other building materials, please contact your nearest installer.

If installed on a ceiling or slanted wall, it may fall and result in severe personal injury.

We recommend that you use an LG brand wall mount when mounting the TV to a wall.

LG recommends that wall mounting be performed by a qualified professional installer.

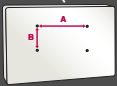
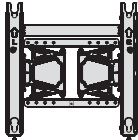
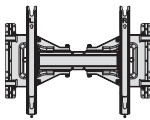
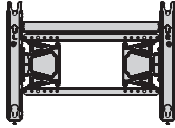
Model	VESA (A * B) 	Standard Screw	Quantity	Wall Mounting bracket (sold separately)
50PK550, 42/50PJ340 42/50PJ350, 42/50PJ250 50PK250, 50PK340, 50PK350, 50PK540, 42/50PJ550, 42/50PJ350C, 50PK550C	400 * 400	M6	4	 AW-50PG60MS  AW-50PG60M
60PK550, 60PK250, 60PK280, 60PK290, 50PK540, 60PK550C	600 * 400	M8	4	 AW-60PG60MS

NOTE

- ▶ Screw length needed depends on the wall mount used. For further information, refer to the instructions included with the mount.
- ▶ Standard dimensions for wall mount kits are shown in the table.
- ▶ When purchasing our wall mount kit, a detailed installation manual and all parts necessary for assembly are provided.
- ▶ Do not use screws longer than the standard dimension, as they may cause damage to the inside of the TV.
- ▶ For wall mounts that do not comply with the VESA standard screw specifications, the length of the screws may differ depending on their specifications.
- ▶ Do not use screws that do not comply with the VESA standard screw specifications. Do not use fasten the screws too strongly, this may damage the TV or cause the TV to a fall, leading to personal injury. LG is not liable for these kinds of accidents.
- ▶ LG is not liable for TV damage or personal injury when a non-VESA or non specified wall mount is used or the consumer fails to follow the TV installation instructions.

CAUTION

- ▶ Do not install your wall mount kit while your TV is turned on. It may result in personal injury due to electric shock.

PREPARATION

PREPARATION

SECURING THE TV TO THE WALL TO PREVENT FALLING WHEN THE TV IS USED ON A STAND

- You should purchase necessary components to prevent the TV from tipping over (when not using a wall mount).
- Image shown may differ from your TV.

We recommend that you set up the TV close to a wall so it cannot fall over if pushed backwards.

Additionally, we recommend that the TV be attached to a wall so it cannot be pulled in a forward direction, potentially causing injury or damaging the product.

Caution: Please make sure that children don't climb on or hang from the TV.

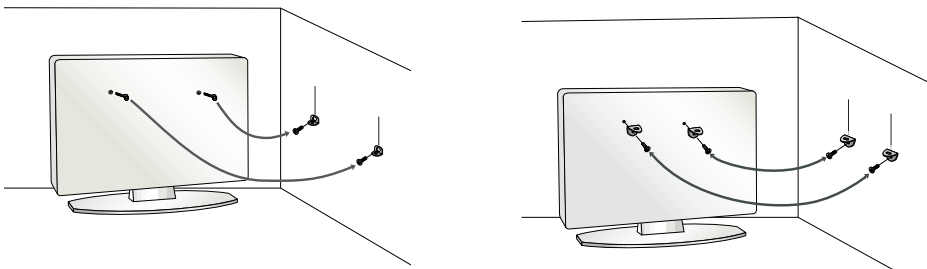

- Insert the eye-bolts (or TV brackets and bolts) to tighten the product to the wall as shown in the picture.

* If your product has the bolts in the eye-bolts position before inserting the eye-bolts, loosen the bolts.

* Insert the eye-bolts or TV brackets/bolts and tighten them securely in the upper holes.

Secure the wall brackets with the bolts (sold separately) to the wall. Match the height of the bracket that is mounted on the wall to the holes in the product.

Ensure the eye-bolts or brackets are tightened securely.

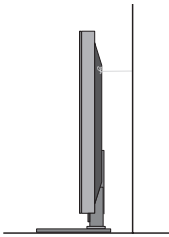

- Use a sturdy rope (sold separately) to tie the product. It is safer to tie the rope so it becomes horizontal between the wall and the product.

! NOTE

- ▶ Use a platform or cabinet strong enough and large enough to support the size and weight of the TV.
- ▶ To use the TV safely, make sure that the height of the bracket on the wall and the one on the TV are the same.

- To prevent damage do not connect to the power outlet until all connections are made between the devices.

ANTENNA OR CABLE CONNECTION

1. Antenna (Analog or Digital)

Wall Antenna Socket or Outdoor Antenna without a Cable Box Connection.

For optimum picture quality, adjust antenna direction if needed.

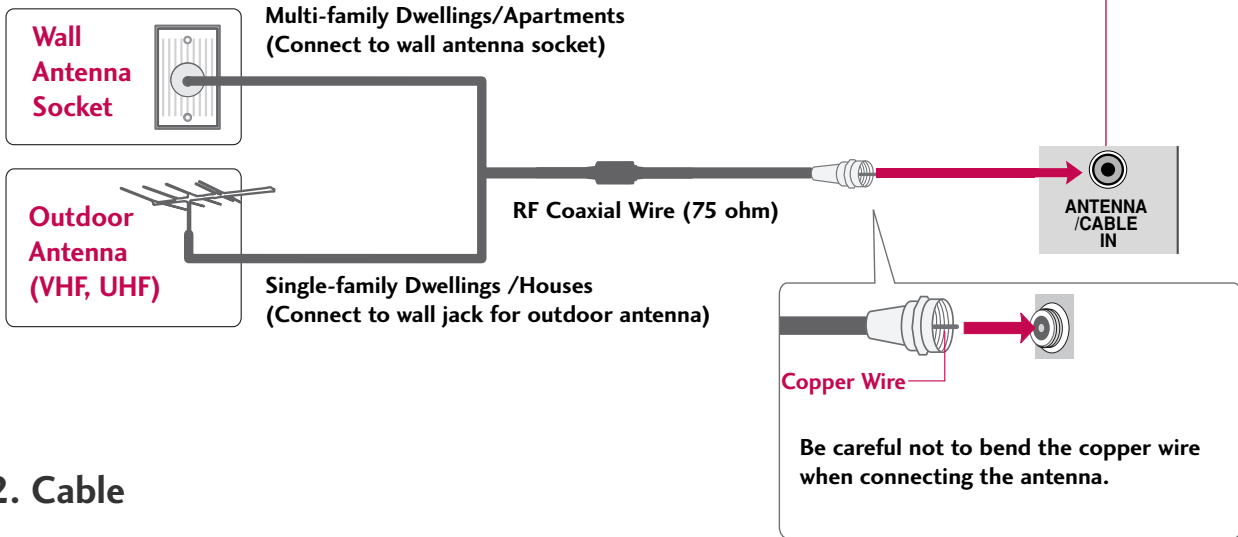

2. Cable

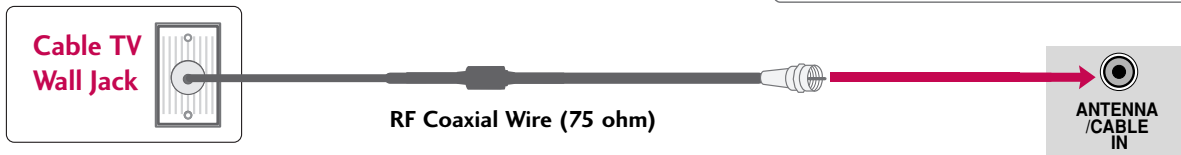

- To improve the picture quality in a poor signal area, please purchase a signal amplifier and install properly.
- If the antenna needs to be split for two TV's, install a 2-Way Signal Splitter.
- If the antenna is not installed properly, contact your dealer for assistance.

EXTERNAL EQUIPMENT SETUP

- To prevent the equipment damage, never plug in any power cords until you have finished connecting all equipment.
- Image shown may differ from your TV.

HD RECEIVER SETUP

This TV can receive Digital Over-the-air/Cable signals without an external digital set-top box. However, if you do receive digital signals from a digital set-top box or other digital external device, refer to the figure as shown below.

Component Connection

1. How to connect

- 1 Connect the video outputs (Y, PB, PR) of the digital set-top box to the **COMPONENT IN VIDEO 1** jacks on the TV. Match the jack colors (Y = green, PB = blue, and PR = red).
- 2 Connect the audio output of the digital set-top box to the **COMPONENT IN AUDIO 1** jacks on the TV.

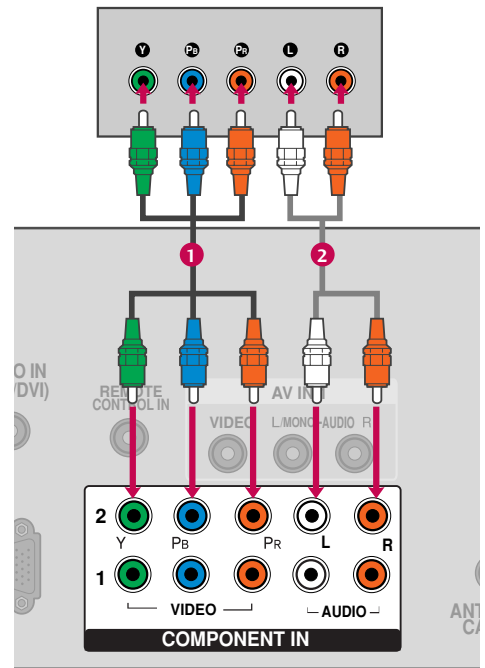

2. How to use

- Turn on the digital set-top box.
(Refer to the owner's manual for the digital set-top box operation)
- Select the **Component1** input source on the TV using the **INPUT** button on the remote control.
- If connected to **COMPONENT IN 2** input, select the **Component2** input source on the TV.

Supported Resolutions

Signal	Component	HDMI
480i	Yes	No
480p	Yes	Yes
720p	Yes	Yes
1080i	Yes	Yes
1080p	Yes	Yes

Y, CB/PB, CR/PR

Resolution	Horizontal Frequency(KHz)	Vertical Frequency(Hz)
720x480i	15.73	59.94
	15.73	60.00
720x480p	31.47	59.94
	31.47	60.00
1280x720p	44.96	59.94
	45.00	60.00
1920x1080i	33.72	59.94
	33.75	60.00
1920x1080p	27.00	24.00
	33.75	30.00
	67.432	59.939
	67.50	60.00
	26.97	23.94
	33.71	29.97

HDMI Connection

1. How to connect

- 1 Connect the digital set-top box to **HDMI/DVI IN 1, 2 or 3**
- 2 No separate audio connection is necessary.
HDMI supports both audio and video.

2. How to use

- Turn on the digital set-top box.
(Refer to the owner's manual for the digital set-top box.)
- Select the **HDMI1, 2 or 3** input source on the TV using the **INPUT** button on the remote control.

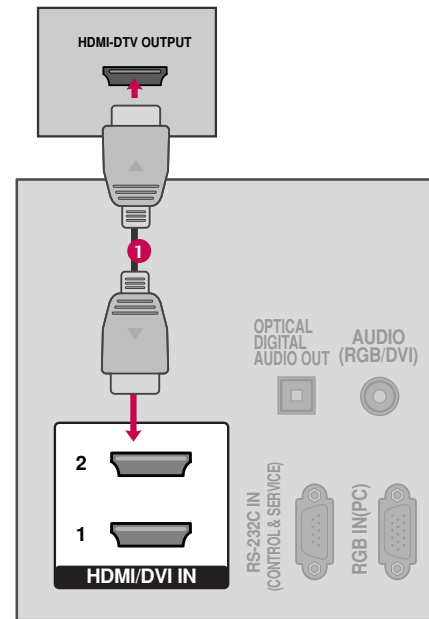

! NOTE

- ▶ Check HDMI cable over version 1.3.
If the HDMI cables don't support HDMI version 1.3, it can cause flickers or no screen display. In this case use the latest cables that support HDMI version 1.3.
- ▶ HDMI mode supports PCM, AC-3(Dolby Digital) audio format.

HDMI-DTV

Resolution	Horizontal Frequency(KHz)	Vertical Frequency(Hz)
720x480p	31.47	59.94
	31.47	60.00
1280x720p	44.96	59.94
	45.00	60.00
1920x1080i	33.72	59.94
	33.75	60.00
1920x1080p	27.00	24.00
	33.75	30.00
	67.432	59.939
	67.50	60.00
	26.97	23.94
	33.71	29.97

EXTERNAL EQUIPMENT SETUP

DVI to HDMI Connection

1. How to connect

- 1 Connect the DVI output of the digital set-top box to the **HDMI/DVI IN 1, 2 or 3** jack on the TV.
- 2 Connect the audio output of the digital set-top box to the **AUDIO IN (RGB/DVI)** jack on the TV.

2. How to use

- Turn on the digital set-top box. (Refer to the owner's manual for the digital set-top box.)
- Select the **HDMI 1, 2 or 3** input source on the TV using the **INPUT** button on the remote control.

! NOTE

- ▶ A DVI to HDMI cable or adapter is required for this connection. DVI doesn't support audio, so a separate audio connection is necessary.

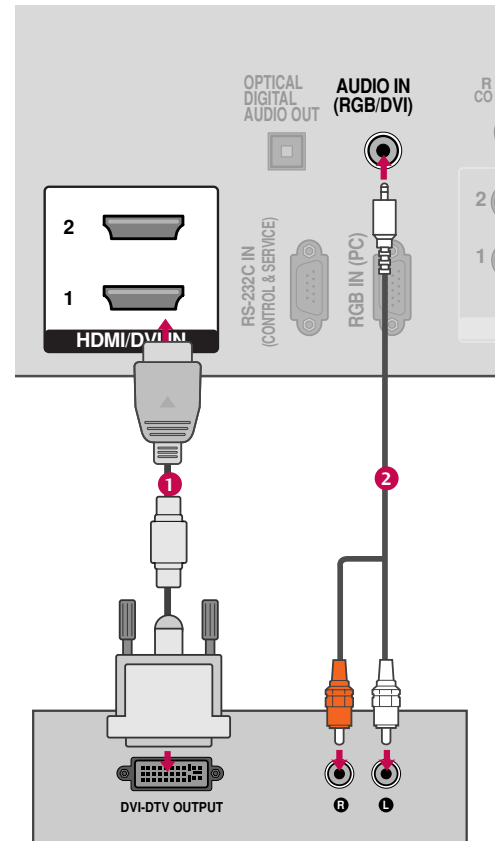

DVD SETUP

Component Connection

1. How to connect

- 1 Connect the video outputs (Y, PB, PR) of the DVD to the **COMPONENT IN VIDEO 1** jacks on the TV.
Match the jack colors (Y = green, PB = blue, and PR = red).

- 2 Connect the audio outputs of the DVD to the **COMPONENT IN AUDIO 1** jacks on the TV.

2. How to use

- Turn on the DVD player, insert a DVD.
- Select the **Component1** input source on the TV using the **INPUT** button on the remote control.
- If connected to **COMPONENT IN 2** input, select the **Component2** input source on the TV.
- Refer to the DVD player's manual for operating instructions.

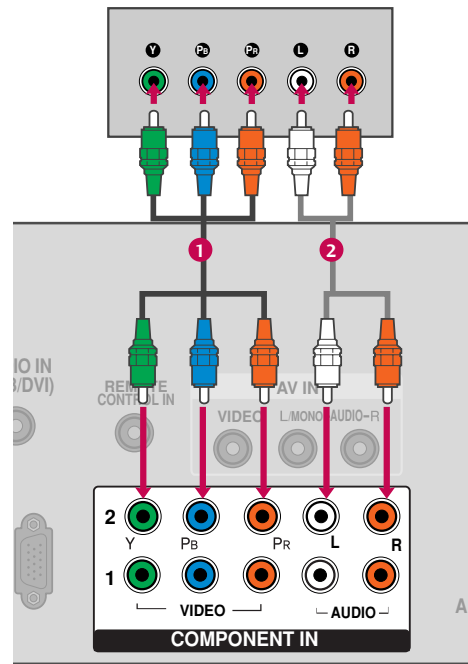

Component Input ports

To get better picture quality, connect a DVD player to the component input ports as shown below.

Component ports on the TV	Y	P _B	P _R
Video output ports on DVD player	Y	P _B	P _R
	Y	B-Y	R-Y
	Y	C _b	C _r
	Y	P _b	P _r

EXTERNAL EQUIPMENT SETUP

HDMI Connection

1. How to connect

- 1 Connect the HDMI output of the DVD to the **HDMI/DVI IN 1, 2 or 3** jack on the TV.
- 2 No separate audio connection is necessary. HDMI supports both audio and video.

2. How to use

- Select the **HDMI 1, 2 or 3** input source on the TV using the **INPUT** button on the remote control.
- Refer to the DVD player's manual for operating instructions.

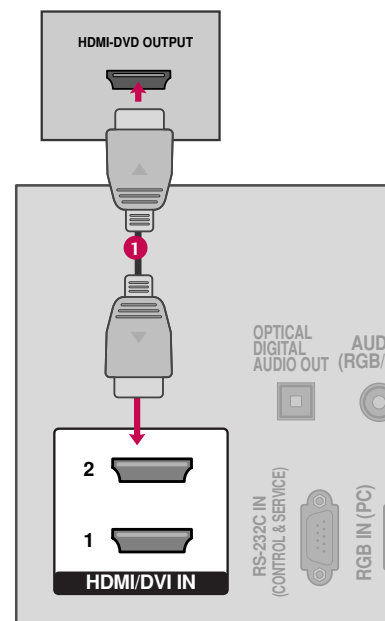

VCR SETUP

Antenna Connection

1. How to connect

- 1 Connect the RF antenna out socket of the VCR to the **ANTENNA/CABLE IN** socket on the TV.
- 2 Connect the antenna cable to the RF antenna in socket of the VCR.

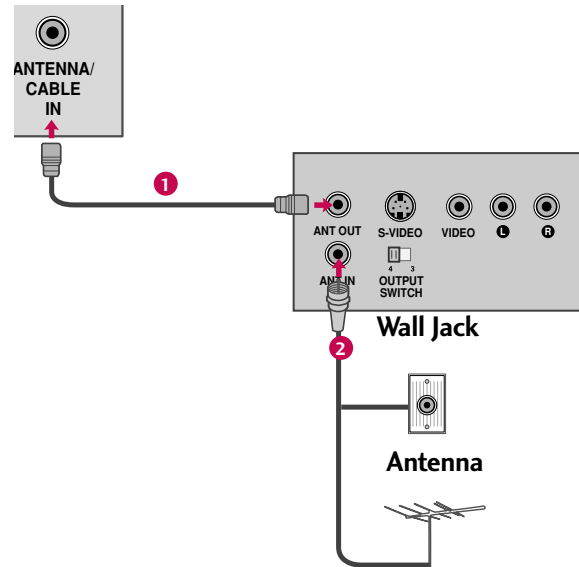

2. How to use

- Set VCR output switch to 3 or 4 and then tune TV to the same channel number.
- Insert a video tape into the VCR and press PLAY on the VCR. (Refer to the VCR owner's manual.)

Composite (RCA) Connection

1. How to connect

- 1 Connect the **AUDIO/VIDEO** jacks between TV and VCR. Match the jack colors (Video = yellow, Audio Left = white, and Audio Right = red)

2. How to use

- Insert a video tape into the VCR and press PLAY on the VCR. (Refer to the VCR owner's manual.)
- Select the **AV1** input source on the TV using the **INPUT** button on the remote control.
- If connected to **AV IN 2**, select **AV2** input source on the TV.

NOTE

- ▶ If you have a mono VCR, connect the audio cable from the VCR to the **AUDIO L/MONO** jack of the TV.

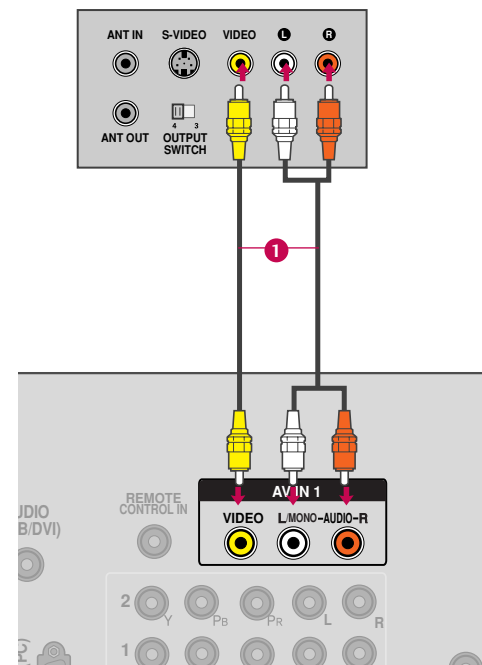

EXTERNAL EQUIPMENT SETUP

OTHER A/V SOURCE SETUP

1. How to connect

- 1 Connect the **AUDIO/VIDEO** jacks between TV and external equipment. Match the jack colors. (Video = yellow, Audio Left = white, and Audio Right = red)

2. How to use

- Select the **AV2** input source on the TV using the **INPUT** button on the remote control.
- If connected to **AV IN 1** input, select the **AV1** input source on the TV.
- Operate the corresponding external equipment.

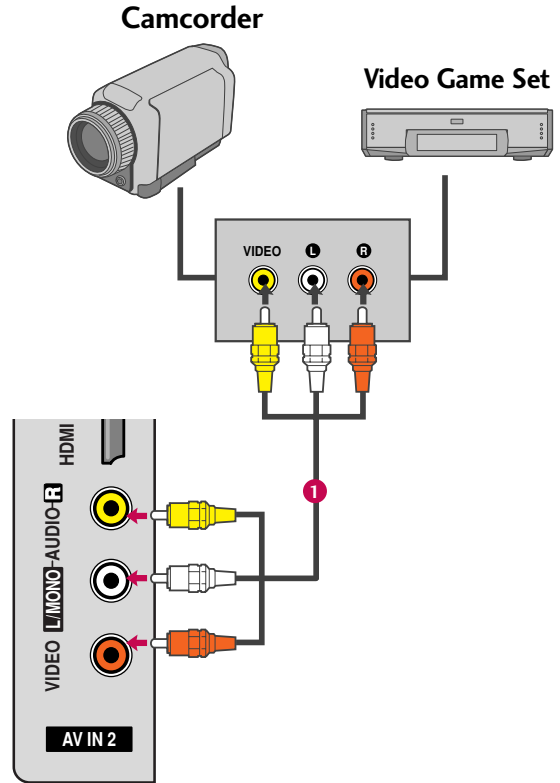

USB CONNECTION - For 42/50PJ350, 50PK350, 42/50PJ550, 50/60PK550, 60PK290, 42/50PJ350C, 50/60PK550C models

1. How to connect

- 1 Connect the USB device to the **USB IN** jack on the side of TV.

2. How to use

- After connecting the **USB IN** jack, you use the USB function. (► p.54)

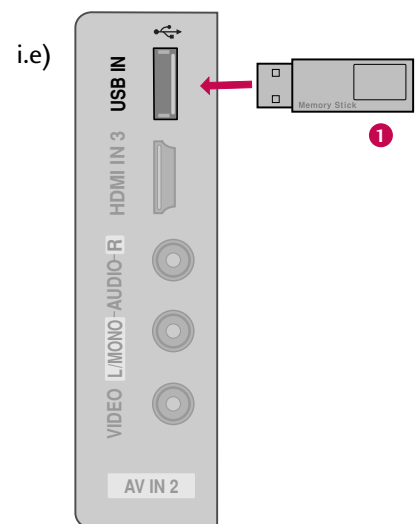

AUDIO OUT CONNECTION

Send the TV's audio to external audio equipment via the Audio Output port.

1. How to connect

- 1 Connect one end of the optical cable to the TV's **OPTICAL** port of **DIGITAL AUDIO OUT**.
- 2 Connect the other end of the optical cable to the digital audio input on the audio equipment.
- 3 Set the "TV Speaker option - Off" in the AUDIO menu. (▶ p.82). See the external audio equipment instruction manual for operation.

! NOTE

- ▶ When connecting with external audio equipment, such as amplifiers or speakers, you can turn the TV speakers off in the menu. (▶ p.82)

⚠ CAUTION

- ▶ Do not look into the optical output port. Looking at the laser beam may damage your vision.
- ▶ Audio with ACP (Audio Copy Protection) function may block digital audio output.

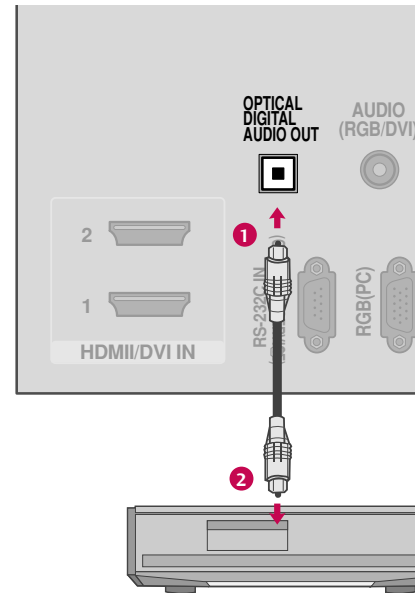

EXTERNAL EQUIPMENT SETUP

PC SETUP

This TV provides Plug and Play capability, meaning that the PC adjusts automatically to the TV's settings.

VGA (D-Sub 15 pin) Connection

1. How to connect

- 1 Connect the VGA output of the PC to the **RGB IN (PC)** jack on the TV.
- 2 Connect the PC audio output to the **AUDIO IN (RGB/DVI)** jack on the TV.

2. How to use

- Turn on the PC and the TV.
- Select the **RGB-PC** input source on the TV using the **INPUT** button on the remote control.

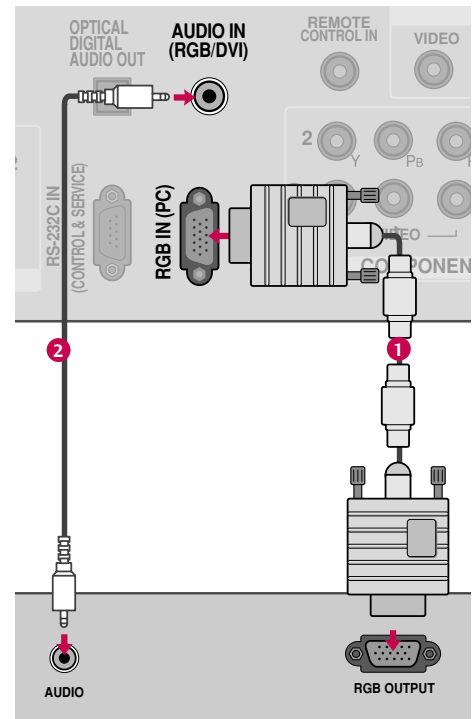

DVI to HDMI Connection

1. How to connect

- 1 Connect the DVI output of the PC to the **HDMI/DVI IN 1, 2 or 3** jack on the TV.
- 2 Connect the PC audio output to the **AUDIO IN (RGB/DVI)** jack on the TV.

2. How to use

- Turn on the PC and the TV.
- Select the **HDMI 1, 2 or 3** input source on the TV using the **INPUT** button on the remote control.

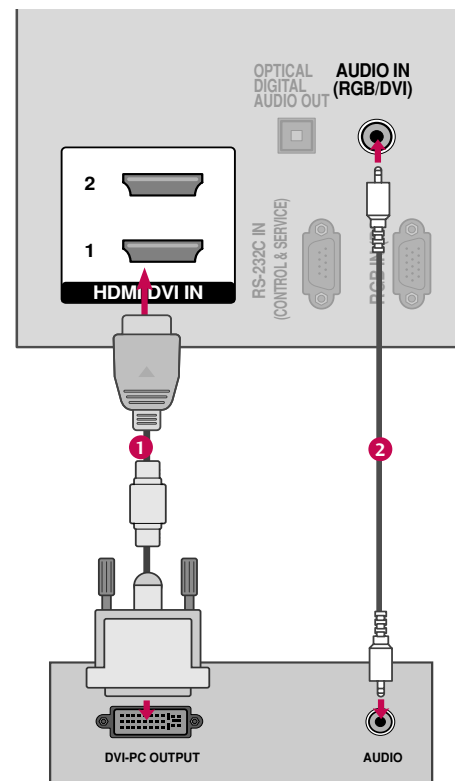

! NOTES

- ▶ Depending on the graphics card, DOS mode may not work if a HDMI to DVI Cable is in use.
- ▶ In PC mode, there may be noise associated with the resolution, vertical pattern, contrast or brightness. If noise is present, change the PC output to another resolution, change the refresh rate to another rate or adjust the brightness and contrast on the PICTURE menu until the picture is clear.
- ▶ Avoid keeping a fixed image on the screen for a long period of time. The fixed image could become permanently imprinted on the screen.
- ▶ The synchronization input form for Horizontal and Vertical frequencies is separate.
- ▶ Depending on the graphics card, some resolution settings may not allow the image to be positioned on the screen properly.

Supported Display Specifications (RGB-PC, HDMI-PC)

Resolution	Horizontal Frequency(KHz)	Vertical Frequency(Hz)
640x350	31.468	70.09
720x400	31.469	70.08
640x480	31.469	59.94
800x600	35.156	56.25
	37.879	60.31
1024x768	48.363	60.00
1280x768	47.776	59.87
1360x768	47.712	60.015
1280x1024	63.981	60.020
1600x1200	74.537	59.869
1920x1080	66.587	59.934

Except 42/50PJ250, 42/50PJ340, 42/50PJ350, 42/50PJ550, 42/50PJ350C







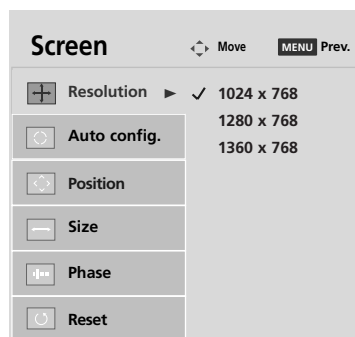
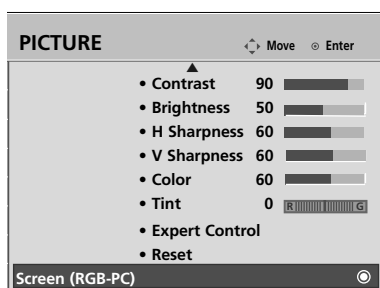

EXTERNAL EQUIPMENT SETUP

Screen Setup for PC mode

Selecting Resolution

You can choose the resolution in RGB-PC mode.
The **Position**, **Phase**, and **Size** can also be adjusted.









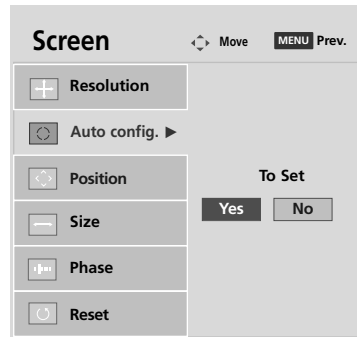

-   Select **PICTURE**.
-   Select **Screen (RGB-PC)**.
-   Select **Resolution**.
-   Select the desired resolution.
- 

Auto Configure

Automatically adjusts picture position and minimizes image instability. After adjustment, if the image is still not correct, try using the manual settings or a different resolution or refresh rate on the PC.



- 1   Select **PICTURE**.
- 2   Select **Screen (RGB-PC)**.
- 3   Select **Auto config..**
- 4   Select **Yes**.
- 5  Start Auto Configuration.

- If the position of the image is still not correct, try Auto adjustment again.
- If picture needs to be adjusted again after Auto adjustment in RGB-PC, you can adjust the **Position**, **Size** or **Phase**.







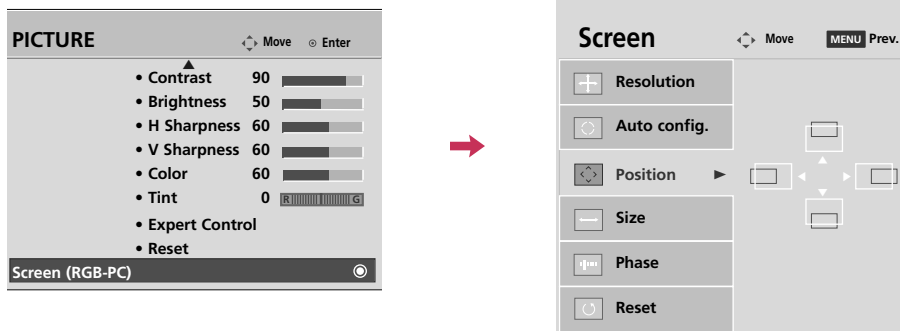

EXTERNAL EQUIPMENT SETUP

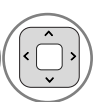
Adjustment for screen Position, Size, and Phase

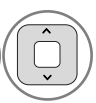
If the picture is not clear after auto adjustment and especially if characters are still trembling, adjust the picture phase manually.

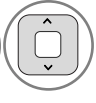
This feature operates only in RGB-PC mode.

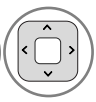









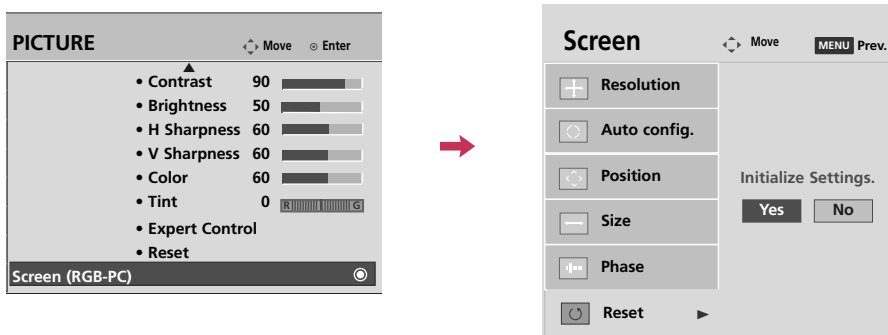

-   Select **PICTURE**.
-   Select **Screen (RGB-PC)**.
-   Select **Position, Size, or Phase**.
-   Make appropriate adjustments.
- 

- **Position:** This function is to adjust picture to left/right and up/down as you prefer.
- **Size:** This function is to minimize any vertical bars or stripes visible on the screen background. And the horizontal screen size will also change.
- **Phase:** This function allows you to remove any horizontal noise and clear or sharpen the image of characters.

Screen Reset (Reset to original factory values)

Returns **Position**, **Size**, and **Phase** to the default factory settings.
This feature operates only in RGB-PC mode.



- 1   Select **PICTURE**.
- 2   Select **Screen (RGB-PC)**.
- 3   Select **Reset**.
- 4   Select **Yes**.
- 5 

WATCHING TV / CHANNEL CONTROL

REMOTE CONTROL FUNCTIONS

When using the remote control, aim it at the remote control sensor on the TV.

50/60PK250, 50/60PJ250,
42/50PJ350, 42/50PJ340,
42/50PJ550, 50PK340,
50PK350, 60PK280,
60PK290, 42/50PJ350C

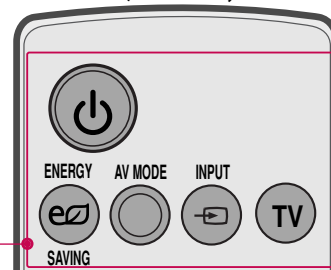

50/60PK550, 50/60PK540,
50/60PK550C

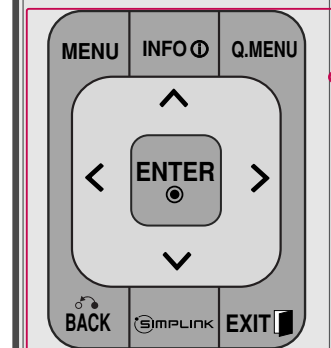
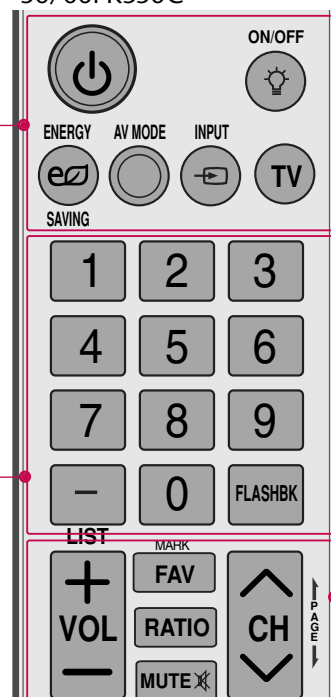

POWER Turns the TV on from standby or off to standby.

ON/OFF Illuminates the remote control buttons.

ENERGY SAVING Adjusts the Energy Saving.

AV MODE Toggles through preset Video and Audio modes. ▶ p.51

INPUT Rotates through inputs.
Also switches the TV on from standby. ▶ p.49

TV Select the remote operating mode: TV

NUMBER button

— (DASH) Used to enter a program number for multiple program channels such as 2-1, 2-2, etc.

LIST Displays the channel list.

FLASHBK Tunes to the last channel viewed.

Colored buttons Programme edit.

SIMPLINK Control buttons

- ◀◀ (Rewind), ▶▶ (Fast Forward), ▶ (Playback), || (Pause)
- Controls the SIMPLINK compatible devices.

FREEZE Freezes the current frame.

■ (Stop) Stops processing of time machine function. (Playback, Rewind etc)

THUMBSTICK
(Up/Down/Left
Right/ENTER)

Navigates the on-screen menus and adjusts the system settings to your preference.

- MENU** Displays the main menu or clears all on-screen displays and returns to TV viewing.
- INFO** Displays channel information at the top of the screen.
- Q.MENU** Opens the list of Quick Menu options.
- BACK** Allows the user to move return one step in an interactive application or other user interaction function.
- SIMPLINK** Displays channel information at the top of the screen.
- EXIT** Clears all on-screen displays and return to TV viewing from any menu.

**VOLUME UP
/DOWN**

Adjusts the volume.

FAV Scroll through the programmed Favorite channels. ► **p.47**

RATIO Changes the aspect ratio.

MUTE Switches the sound on or off. ► **p.38**

**CHANNEL
UP/DOWN**

Changes the channel.

**PAGE
UP/DOWN**

Moves from one full set of screen information to the next one.

Installing Batteries

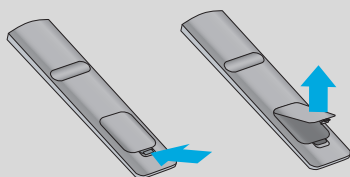

- Open the battery compartment cover on the back side and install the batteries matching correct polarity.
- Install two 1.5V AAA batteries. Don't mix old or used batteries with new ones.
- Close cover.

WATCHING TV / CHANNEL CONTROL

TURNING ON TV

- 1** First, connect power cord correctly.
At this moment, TV is in standby mode.
 - In standby mode to turn TV on, press the ϕ/I , **INPUT, CH** (^ or v) button on the TV or press the **POWER, INPUT, CH** (^ or v), **Number (0-9)** button on the remote control.

- 2** Select the viewing source by using the **INPUT** button on the remote control.

- 3** When finished using the TV, press the **POWER** button on the remote control. The TV reverts to standby mode.

! NOTE

- ▶ If you intend to be away on vacation, disconnect the power plug from the wall power outlet.

CHANNEL SELECTION

- 1** Press the **CH** (^ or v) or **NUMBER** buttons to select a channel number.

VOLUME ADJUSTMENT

Adjust the volume to suit your personal preference.

- 1** Press the **VOL (+ or -)** button to adjust the volume.

- 2** If you want to switch the sound off, press the **MUTE** button.

- 3** You can cancel the Mute function by pressing the **MUTE** or **VOL (+ or -)** button.

INITIAL SETTING

This Function guides the user to easily set the essential items for viewing the TV for the first time when purchasing the TV. It will be displayed on the screen when turning the TV on for the first time. It can also be activated from the user menus.

- Default selection is “**Home Use**”. We recommend setting the TV to “**Home Use**” mode for the best picture in your home environment.
- “**Store Demo**” Mode is only intended for use in retail environments. Customers can adjust the “**Picture menu - Picture mode**” manually while inspecting the TV, but the TV will automatically return to preset in-store mode after 5 minutes.
- You can also adjust **Initial Setting** in the **OPTION** menu.
Factory defaults are set when you choose “**Home Use**”.
- If you do not complete the **Initial setting**, it will appear whenever the TV is switched on until the **Initial setting** procedure is completed.

Step1. Welcome

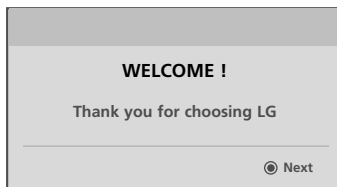

Step2. Language Selecting

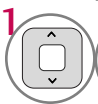
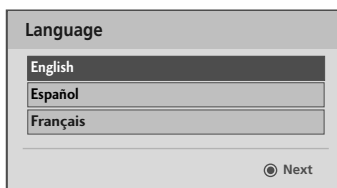

Select menu Language.

Step3. Mode setting

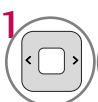
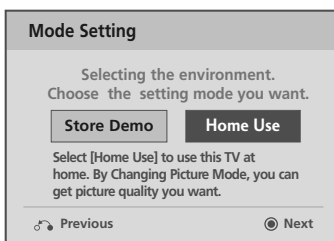

Select **Home Use** mode.

Step4. Time setting

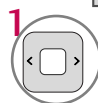
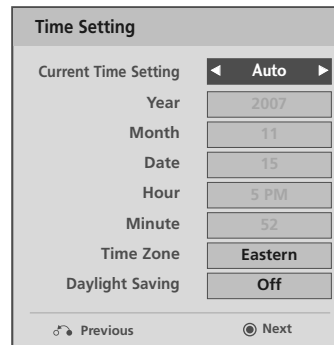

Select **Auto** or **Manual**.



Select desired time option.

Step5. Auto Tuning

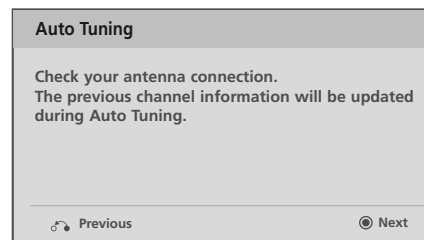





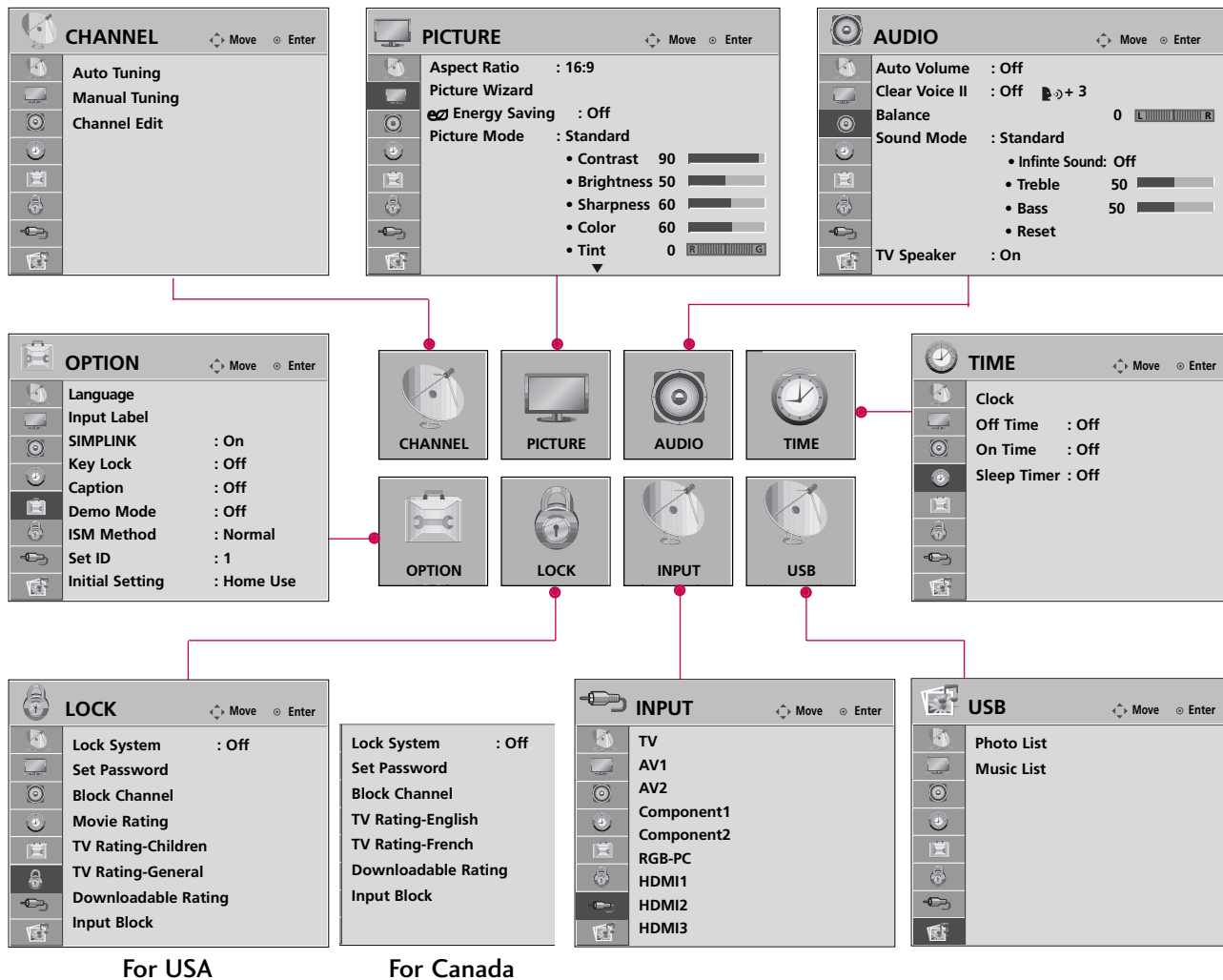

Start **Auto Tuning**.

WATCHING TV / CHANNEL CONTROL

ON-SCREEN MENUS SELECTION

Your TV's OSD (On Screen Display) may differ slightly from that shown in this manual.



- 1   Display each menu.
- 2   Select a menu item.
- 3  Accept the current selection.
- 4  Return to TV viewing.

42/50PJ250, 50/60PK250, 60PK280, 42/50PJ340, 50PK340, 50/60PK540

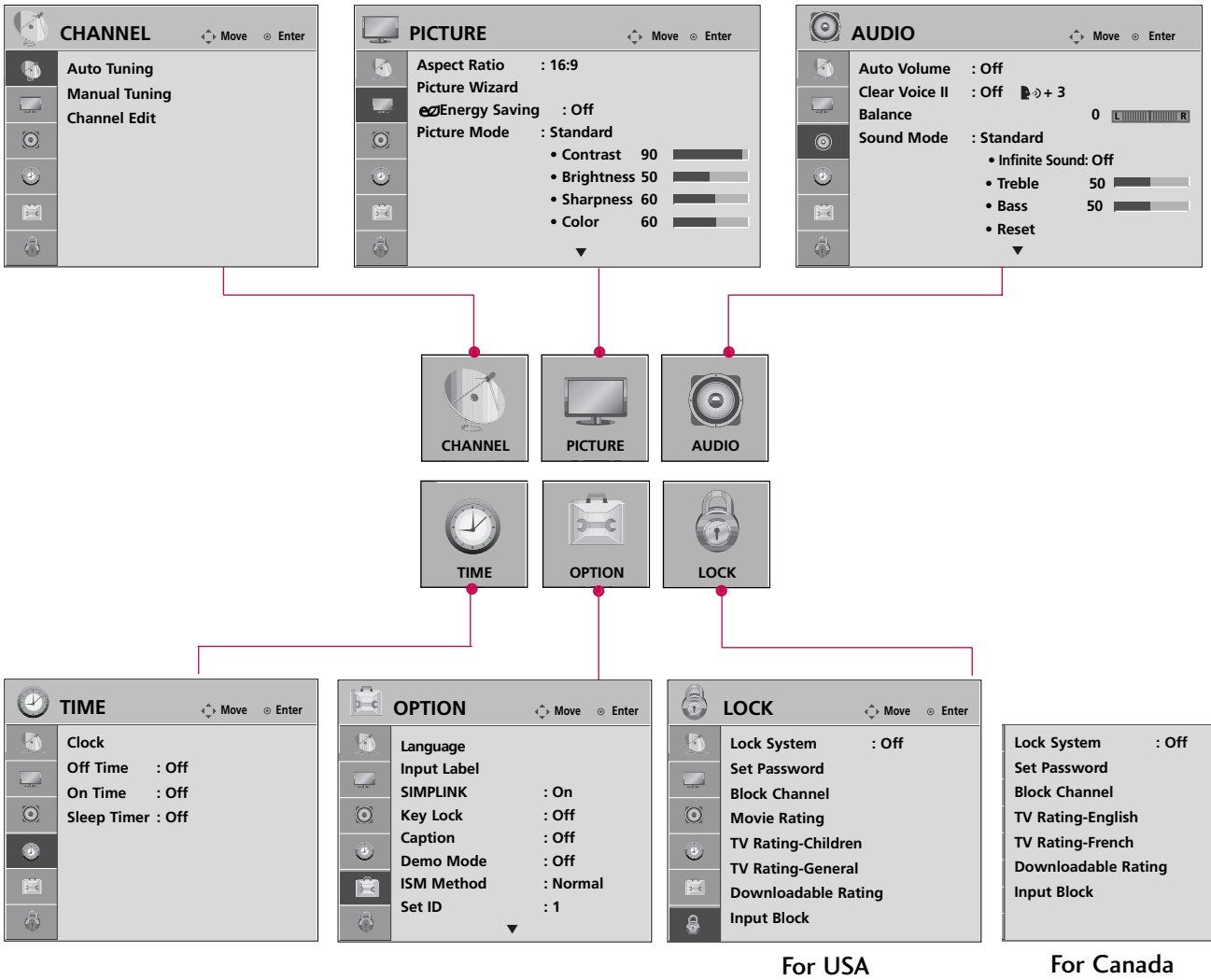

1 Display each menu.

2 Select a menu item.

3 Accept the current selection.

4 Return to TV viewing.

WATCHING TV / CHANNEL CONTROL

QUICK MENU

Your TV's OSD (On Screen Display) may differ slightly from what is shown in this manual.

Q.Menu (Quick Menu) is a menu of features which users might use frequently.

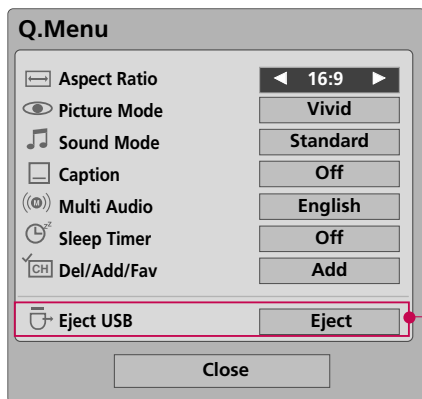

For 42/50PJ350, 50PK350,
50/60PK550, 42/50PJ550,
60PK290, 42/50PJ350C,
50/60PK550C

- Aspect Ratio:** Selects your desired picture format.
- Picture Mode:** Selects the factory preset picture depend on the viewing environment.
- Sound Mode:** Selects the factory preset sound for type of program.
- Multi Audio:** Changes the audio language (Digital signal).
- SAP:** Selects MTS sound (Analog signal).
- Sleep Timer:** Select the amount of time before your TV turns off automatically.
- Del/Add/Fav:** Select channel you want to add/delete or add the channel to the Favorite List.
- Caption:** Select on or off.
- USB Device:** Select "Eject" in order to eject a USB device.

1   Display each menu.

2  Make appropriate adjustments.

3  Return to TV viewing.

CHANNEL SETUP

Auto Scan (Auto Tuning)

Automatically finds all channels available through antenna or cable inputs, and stores them in memory on the channel list.

Run this function if you change your residence or move the TV. Also, make sure to run this function with the antenna connected during TV broadcasting hours.

Auto Tuning memorizes only the channels available at the time.

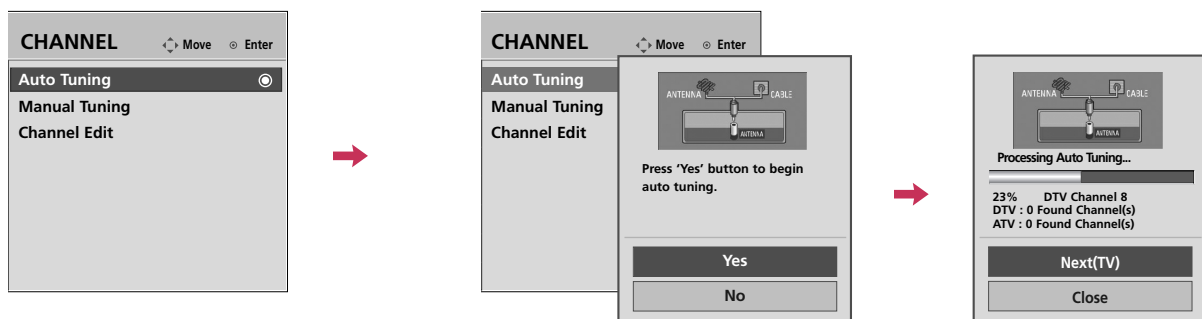



1   Select **CHANNEL**.

2   Select **Auto Tuning**.

3   Select **Yes**.

4  Run **Auto Tuning**.

5  Return to the previous menu.

 Return to TV viewing.

- The TV will ask for a password if parental control has been activated (LOCK Menu). Use the password you set up in the LOCK Menu to allow a channel search.
- When setting the Auto tuning or Manual tuning, the number of maximum channel you can store is 900.
It is subject to change depending on the broadcasting signal environment.
- Memorizes all the available channels in the order of DTV, TV, CDTV and CATV.

WATCHING TV / CHANNEL CONTROL

Add/Delete Channel (Manual Tuning)

If you select DTV or CADTV input signal, you can view the on-screen signal strength monitor to see the quality of the signal being received.

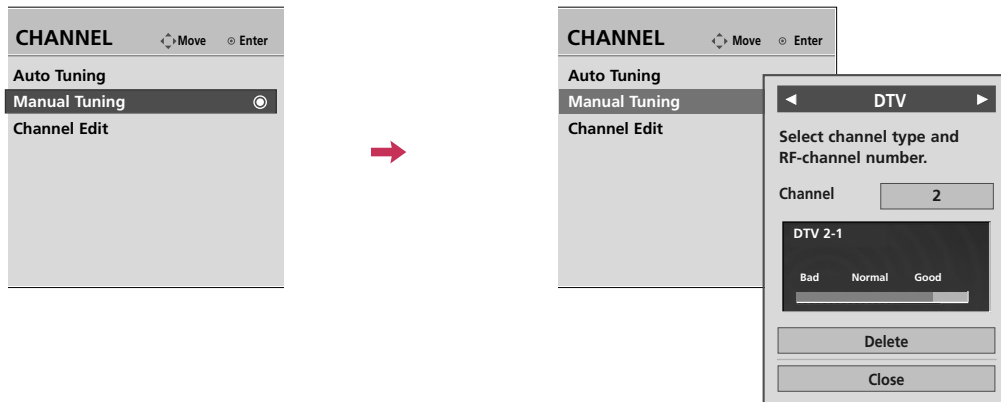

-   Select **CHANNEL**.
-   Select **Manual Tuning**.
-   Select **DTV, TV, CADTV, or CATV**.
-   Select channel you want to add or delete.
-   Select **Add** or **Delete**.
-  Return to the previous menu.
-  Return to TV viewing.







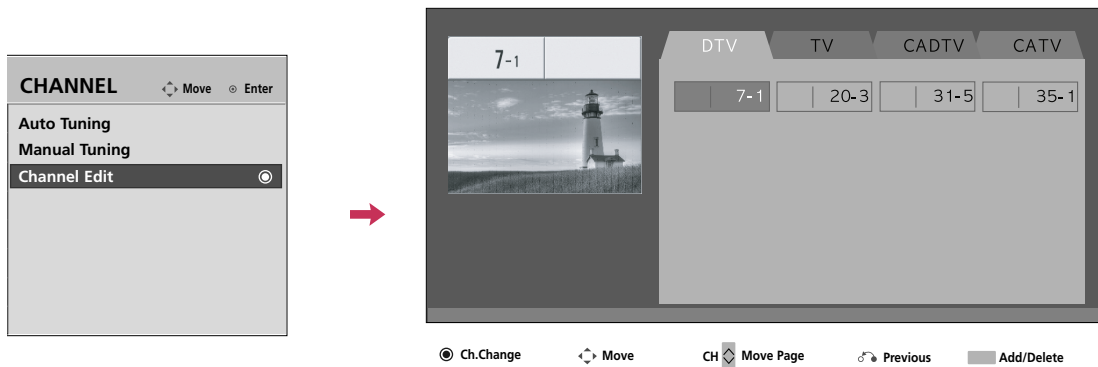

- The TV will ask for a password if parental control has been activated (LOCK Menu). Use the password you set up in the LOCK Menu to allow a channel search.
- When setting the Auto tuning or Manual tuning, the number of maximum channel you can store is 900. It is subject to change depending on the broadcasting signal environment.

Channel Editing

When a channel number is deleted, it means that you will be unable to select it using CH ^, v button during TV viewing.

If you wish to select the deleted channel, directly enter the channel number with the NUMBER buttons or select it in the Channel Edit menu.



- 1   Select **CHANNEL**.
- 2   Select **Channel Edit**.
- 3   Select a channel.
- 4  Add or delete the channel.
- 5  Return to the previous menu.
-  Return to TV viewing.

- Keep pressing the ^ button and use the < or > buttons to move between DTV, TV, CADTV and CATV.

- If the channel list is too long, use the CH ^ or v button to move between pages.

WATCHING TV / CHANNEL CONTROL

CHANNEL LIST

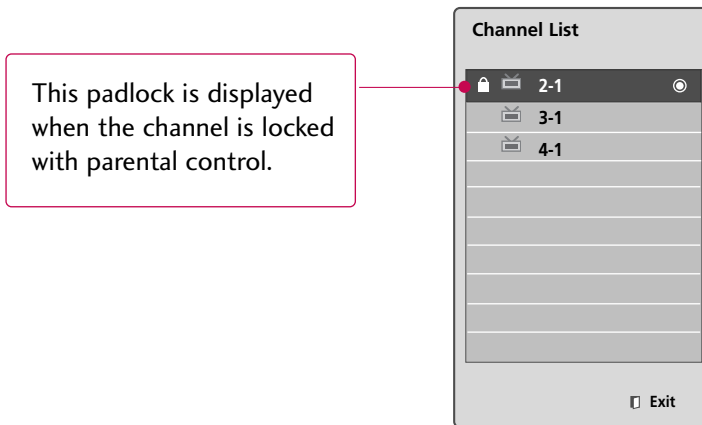

You can check channels which are stored in the memory by displaying the channel list.





Displaying Channel List

- 1  Display the **Channel List**.

Selecting a channel in the channel list

- 1  Select a channel.
- 2  Switch to the chosen channel number.

Paging through a channel list

- 1  Turn the pages.
- 2  Return to TV viewing.



FAVORITE CHANNEL SETUP

Your TV's OSD (On Screen Display) may differ slightly from what is shown in this manual.

Favorite Channels are a convenient feature that lets you quickly select channels of your choice without waiting for the TV to select through all the in-between channels.

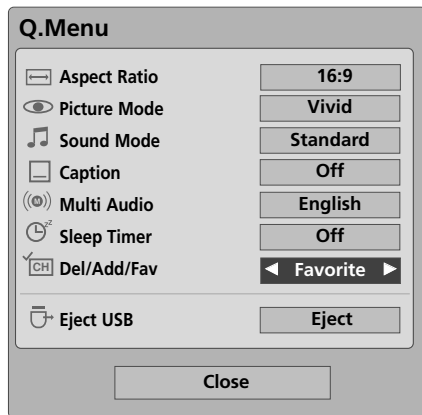
To tune to a favorite channel, press the **FAV** (Favorite) button repeatedly.

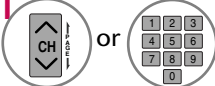
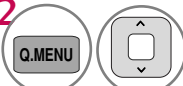

- 1  Select your desired channel.
- 2  Select **Del/Add/Fav**.
- 3  Select **Favorite**.
- 4  Return to TV viewing.

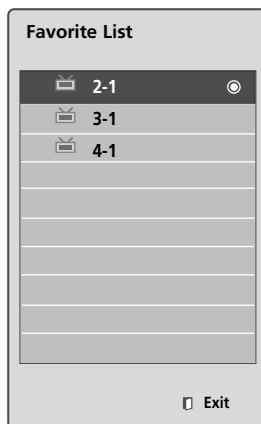

FAVORITE CHANNEL LIST





Displaying the favorite channel list

- 1  Display the Favorite channel list.

Selecting a channel in the favorite channel list

- 1  Select a channel.
- 2  Switch to the chosen channel number.



Paging through a favorite channel list

- 1  Turn the pages.
- 2  Return to TV viewing.

WATCHING TV / CHANNEL CONTROL









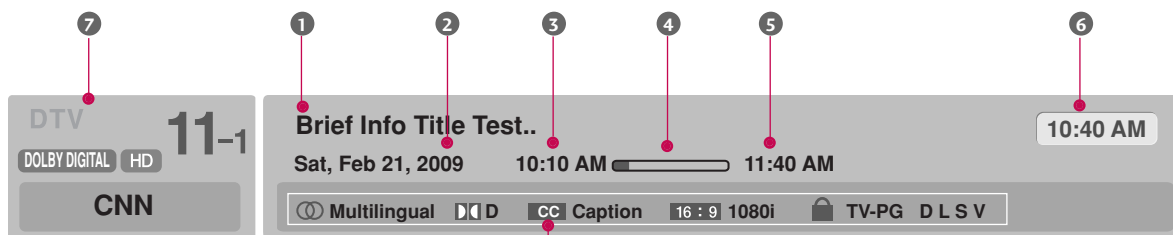

BRIEF INFORMATION

Brief Info shows the present screen information.

1  or  Show the Brief Info on the screen.

2  Return to TV viewing



	Multilingual : The program contains two or more audio services. Use the Q.MENU menu to select wanted Audio.
	Caption : The program contains one or more caption services. Use the Q.MENU menu to select wanted Closed caption.
	Dolby Digital : The program contains a Dolby Digital audio signal in TV and HDMI input source.
	The original aspect ratio of the video is 4:3
	The original aspect ratio of the video is 16:9 (wide)
	The video resolution is 720x480i
	The video resolution is 720x480p
	The video resolution is 1280x720p
	The video resolution is 1920x1080i
	The video resolution is 1920x1080p
	V-Chip : The program contains V-Chip information. Refer to the LOCK menu: A (Age), D (Dialogue), L (Language), S (Sex), V (Violence), FV (Fantasy Violence)

- 1 Program title
- 2 Day, Month, Year
- 3 Program start time
- 4 Program progress bar
- 5 Program finish time
- 6 Present time
- 7 Banner information

INPUT LIST

Only these input signals which are connected to a TV can be activated and selected.

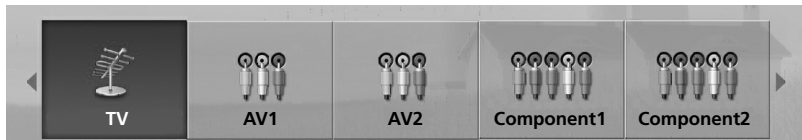

1

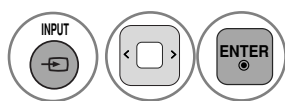

Select the desired input source.

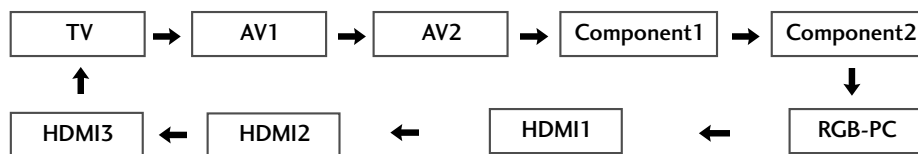

ie)

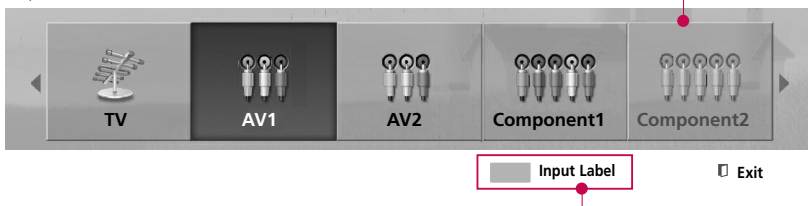

Disconnected inputs are inactive (grayed out)

Select a desired input source (except TV). Then, you can select your desired **Input Label** with using Blue button. ► p.50

ie) In case of changing the input label with using Blue button

- When new external device is connected, this popup menu is displayed automatically. If selecting **Yes**, you can select input source that you want to appreciate.
- But, when selecting “**SIMPLINK - On**”, popup menu for HDMI input will not be displayed.

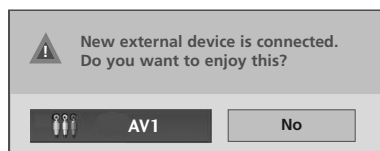

- **TV**: Select it to watch over-the-air, cable and digital cable broadcasts.
- **AV**: Select them to watch a VCR or other external equipment.
- **Component**: Select them to watch DVD or a Digital set-top box.
- **RGB-PC**: Select it to view PC input.
- **HDMI**: Select them to watch high definition devices.





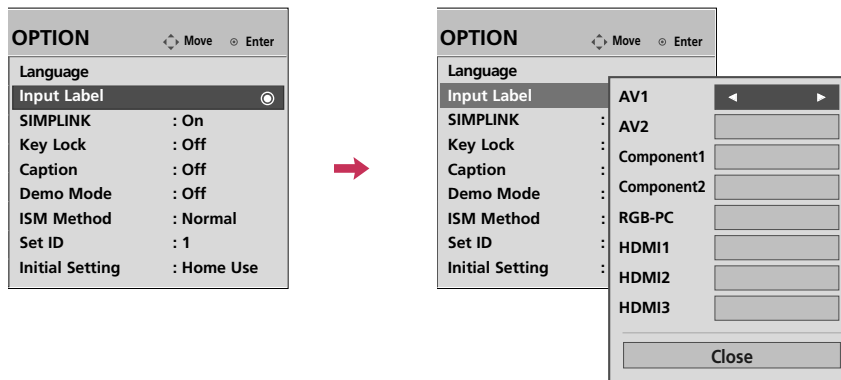

WATCHING TV / CHANNEL CONTROL

INPUT LABEL

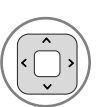

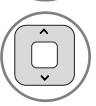

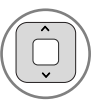
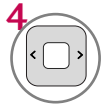
This indicates which device is connected to which input port.

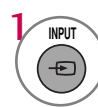
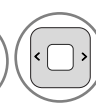

With using OPTION menu

-   Select **OPTION**.
-   Select **Input Label**.
-   Select the source.
-  Select the label.
-  Return to the previous menu.
-  Return to TV viewing.

With using INPUT button

-   Select the source(except **TV**).
-   Select the label.
-  Return to the previous menu.
-  Return to TV viewing.

AV MODE

AV Mode toggles through preset Video and Audio settings.

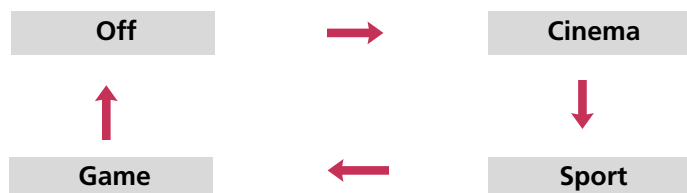

Press the **AV MODE** button repeatedly to select the desired source.



- If you select “**Cinema**” in AV mode, **Cinema** will be selected both for “**PICTURE** menu - Picture Mode” and “**AUDIO** menu - Sound Mode” respectively.
- If you select “**Off**” in AV mode, the “**Picture Mode**” and “**Sound Mode**” return to previous selected value.
- **Off**: Disables the AV MODE.
- **Cinema**: Optimizes video and audio for watching movies.
- **Sport**: Optimizes video and audio for watching sports events.
- **Game**: Optimizes video and audio for playing games.







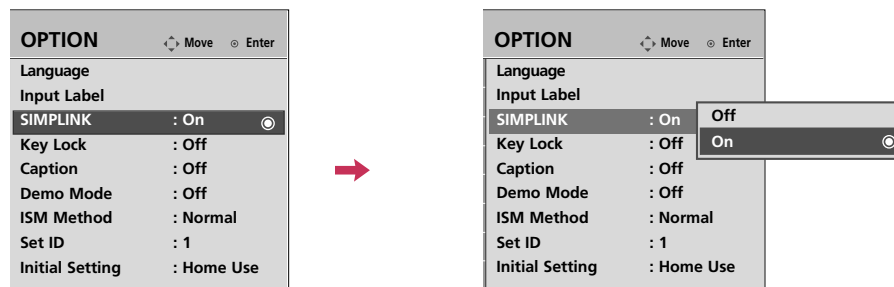

WATCHING TV / CHANNEL CONTROL



Simplink allows you to control and play other AV devices connected with HDMI cable without additional cables and settings. This TV may work with devices with HDMI-CEC support, but only devices with the  logo are fully supported.

SIMPLINK can be turned on and off in the user menus.



-   Select **OPTION**.
-   Select **SIMPLINK**.
-   Select **On** or **Off**.
-  Return to the previous menu.
-  Return to TV viewing.

NOTE

- ▶ Connect the HDMI/DVI IN or HDMI IN terminal of the TV to the rear terminal (HDMI terminal) of the SIMPLINK device with the HDMI cable.
- ▶ When you switch the Input source with the INPUT button on the remote control, the SIMPLINK device will stop.
- ▶ When you select a device with home theater functionality, the sound output automatically switches to the home theater speakers and the TV speakers are turned off.
- ▶ If a connected SIMPLINK home theater system doesn't play the audio from the TV, connect the DIGITAL AUDIO OUT terminal on the back of the TV to the DIGITAL AUDIO IN terminal on the back of the SIMPLINK device with an OPTICAL cable.

SIMPLINK Functions

- **Direct Play:** After connecting AV devices to the TV, you can directly control the devices and play media without additional settings.
- **Select AV device:** Enables you to select one of the AV devices connected to TV.
- **Disc playback:** Control connected AV devices by pressing the \wedge \vee \langle \rangle , ENTER, \blacktriangleright , \blacksquare , II , \blacktriangleleft and \blacktriangleright buttons.
- **Power off all devices:** When you power off the TV, all connected devices are turned off.
- **Switch audio-out:** Offers an easy way to switch audio-out.
- **Sync Power on:** When the equipment with Simplink function connected HDMI terminal starts to play, The TV will change automatically to turn on mode.

(A device, which is connected to the TV through a HDMI cable but does not support SIMPLINK, does not provide this function)

Note: To operate SIMPLINK, an HDMI cable over Version 1.3 with *CEC function should be used. (*CEC: Consumer Electronics Control).

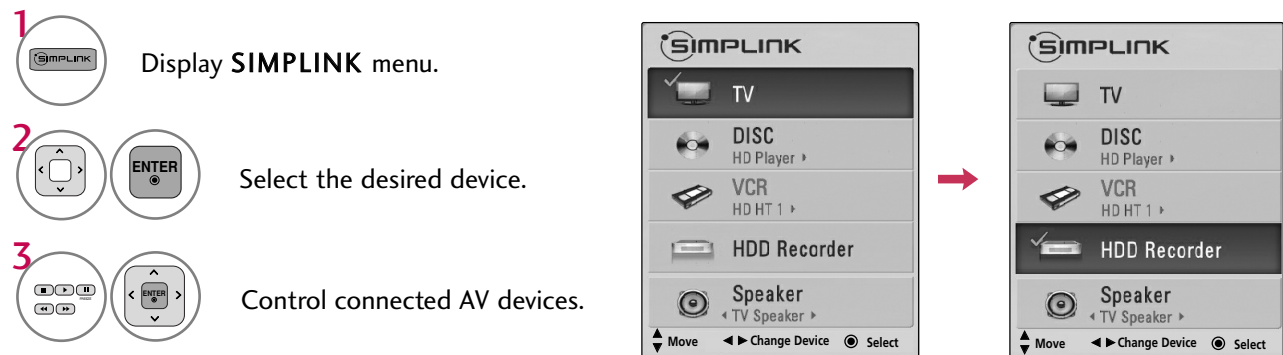

SIMPLINK Menu

1 **TV viewing:** Switch to the previous TV channel regardless of the current mode.

2 **DISC playback:** Select and play discs. When multiple discs are available, the titles of discs are conveniently displayed at the bottom of the screen.

3 **VCR playback:** Control the connected VCR.

4 **HDD Recordings playback:** Control recordings stored in HDD.

5 **Audio Out to Home Theater speaker/Audio Out to TV:** Select Home Theater speaker or TV speaker for Audio Out.

▶ When no device is connected (displayed in gray)

▶ Selected Device

▶ When a device is connected (displayed in bright color)

USB

- For 42/50PJ350, 50PK350, 50/60PK550, 42/50PJ550, 60PK290, 42/50PJ350C models,
50/60PK550C

ENTRY MODES

When you connect a USB device, this screen is displayed automatically.

In USB device, you can not add a new folder or delete the existing folder.

1 Connect the USB device to the **USB IN** jacks on the side of TV.

- It doesn't support USB HDD.
- This TV supports JPG and MP3 files.

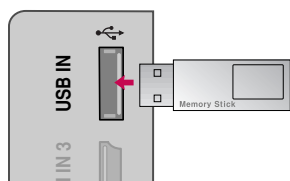

2 Select **Photo List**, **Music List** or **Movie List**.

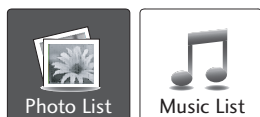

NOTE

- ▶ In order to avoid losing the USB memory stick, use the USB connector to fix the USB memory stick to the USB connector holder of the TV.

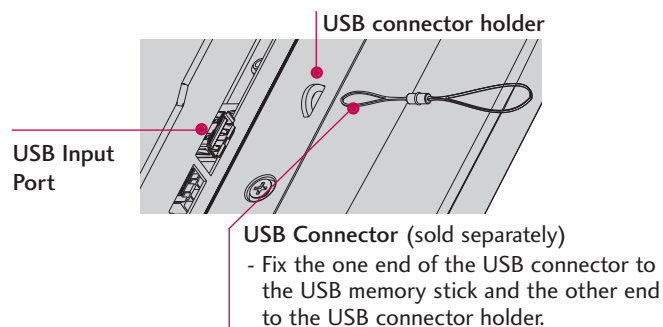

When removing the USB device

Select the **Eject USB** menu before removing the USB device.



Precautions when using the USB device

- ▶ Only a USB storage device is recognizable.
- ▶ If the USB storage device is connected through a USB hub, the device is not recognizable.
- ▶ A USB storage device using an automatic recognition program may not be recognized.
- ▶ A USB storage device which uses its own driver may not be recognized.
- ▶ In case of a card reader, up to four memory cards are concurrently recognizable and the device may not operate normally.
- ▶ The recognition speed of a USB storage device may depend on each device.
- ▶ Please do not turn off the TV or unplug the USB device when the connected USB storage device is working. When such device is suddenly separated or unplugged, the stored files or the USB storage device may be damaged.
- ▶ Only use a USB storage device which has normal music files or image files.
- ▶ Please use only a USB storage device which was formatted as a FAT16, FAT32 or NTFS file system provided with the Windows operating system. In case of a storage device formatted as a different utility program which is not supported by Windows, it may not be recognized.
- ▶ Please connect power to a USB storage device which requires an external power supply. If not, the device may not be recognized.
- ▶ Please connect a USB storage device with cable is offered by USB maker. If connected with cable is not offered by USB maker or an excessively long cable, the device may not be recognized.
- ▶ Some USB storage devices may not be supported or operate properly.
- ▶ The TV will display up to 128 characters of a files name.
- ▶ Please backup important files because data on USB device may be damaged. Data management is consumer's responsibility and as a result, the manufacturer does not cover data damage.
- ▶ The recommended capacity is 1TB or less for a USB external hard disk and 32GB or less for USB memory. Any device with more than the recommended capacity may not work properly.

PHOTO LIST

You can view (*.JPG) files from USB storage devices.
The On Screen Display on your model may be slightly different.

Supported photo file: *.JPG

- You can play JPG files only.
- Only baseline scan is supported among JPG.

USB

Screen Components

1

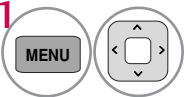

Select **USB**.

2

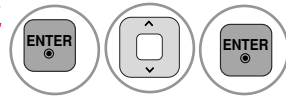

Select **Photo List**.

- ① Moves to upper level file
- ② Preview: Display the thumbnail/folder name of the photo in the selected folder
- ③ Current page/Total pages
- ④ Total number of marked photos
- ⑤ Usable USB memory
- ⑥ Corresponding buttons on the remote control

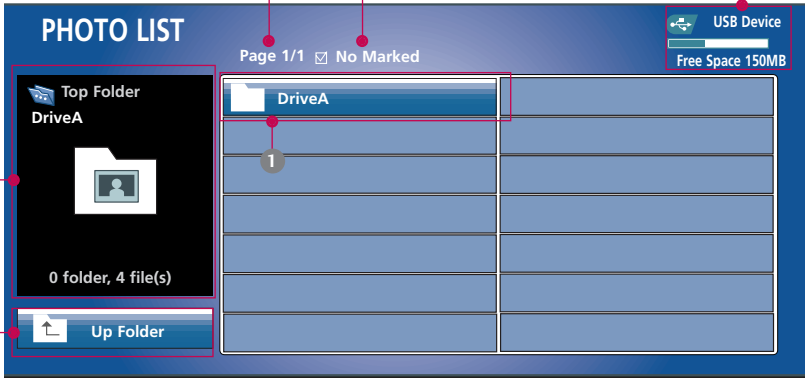





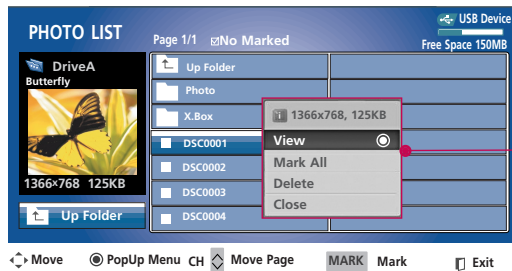
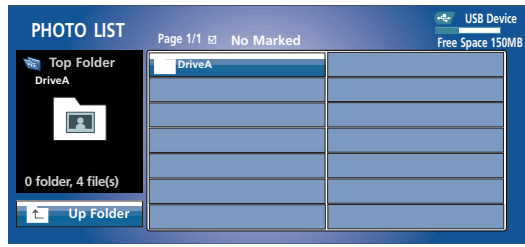

The screenshot shows a 'PHOTO LIST' interface. At the top, it says 'Page 1/1' and 'No Marked'. On the right, it shows 'USB Device' and 'Free Space 150MB'. The main area is a table with a header 'DriveA' and several empty rows. A preview window on the left shows a folder icon and '0 folder, 4 file(s)'. At the bottom, there is a navigation bar with buttons: 'Move', 'PopUp Menu', 'CH', 'Move Page', 'MARK Mark', and 'Exit'.

Photo Selection and PopUp Menu



When you select a file (not folder), this PopUp menu is displayed.

- ▶ **View:** Display the selected item.
- ▶ **Mark All:** Mark all photos on the screen.
- ▶ **Unmark All:** Deselect all marked photos.
- ▶ **Delete:** Delete the selected photo item.
- ▶ **Close:** Close the pop-up menu.

- 1  Select the target folder or drive.
- 2   Select the desired photos.
- 3  Show the Popup menu.
- 4   Select the desired Popup menu.





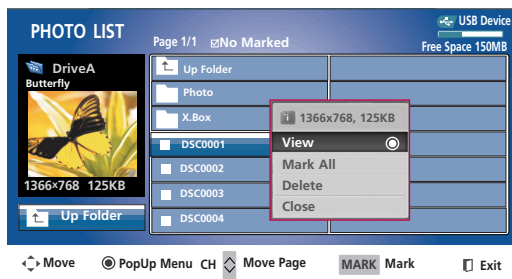
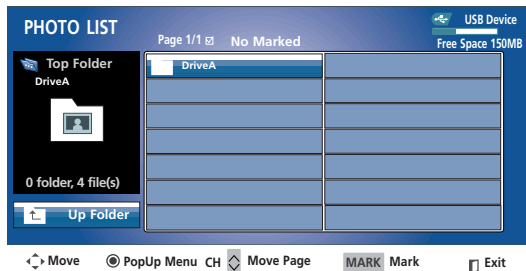

- Use the **CH** ^ v button to navigation in the photo page.
- Use the **MARK** button to mark or unmark a photo. When one or more photos are marked, you can view individual photos or a slide show of the marked photos. If no photos are marked, you can view all photos individually or all photos in the folder in a slide show.



Full Screen Menu

You can change the Photo List view so that it fills the screen. More operations are available in full screen mode.



The aspect ratio of a photo may change the size of the photo displayed on the screen in full size.

- 1  Select the target folder or drive.
- 2   Select the desired photos.
- 3  Show the Popup menu.
- 4  Select **View**.
- 5  The selected photo is displayed in full size.

■ Use the CH   button to navigation in the photo page.

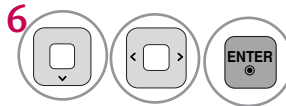

6 Select the **Slideshow**, **BGM**, **Rotate**, **Delete**, or **Close**.

- Use < > button to select the previous or next photo.
- Use ^ v < > button to select and control the menu on the full-sized screen.

- ▶ **Slideshow:** Selected photos are displayed during the slide show. If no photo is selected, all photos in the current folder are displayed during slide show.
 - Set the time interval of the slide show in **Option**.
- ▶ **BGM:** Listen to music while viewing photos in full size.
 - Set the BGM device and album in **Option**.
- ▶ **Rotate:** Rotate photos.
 - Rotates the photo 90°, 180°, 270°, 360° clockwise.
- ▶ **Delete:** Delete photos.
- ▶ **Close :** Hide the menu on the full-sized screen.
 - To see the menu again on the full-sized screen, press **ENTER** button to display.

! NOTE

- ▶ This TV will not be able to decode most JPEG images saved using the Progressive option.

Using the Photo List Option



1  Show the PopUp menu.



2   Select **Set Photo View**, **Set Video** or **Set Audio**.

► When you select the **Set Photo View**,

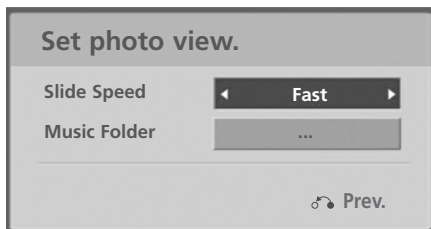
- You cannot change **Music Folder** while BGM is playing.





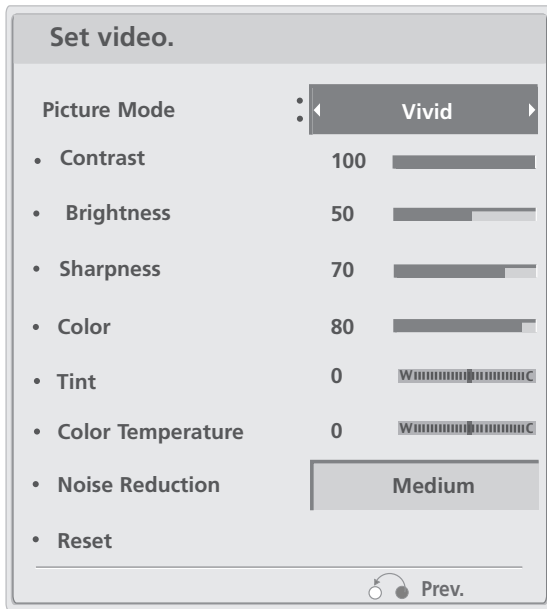

1   Show the **Slide Speed** or **Music Folder**.

2   Make appropriate adjustments.

► When you select the **Set Video**,



1   Show the **Picture Mode**.



2   Make appropriate adjustments.

■ APS mode is not supported in Set Video function.

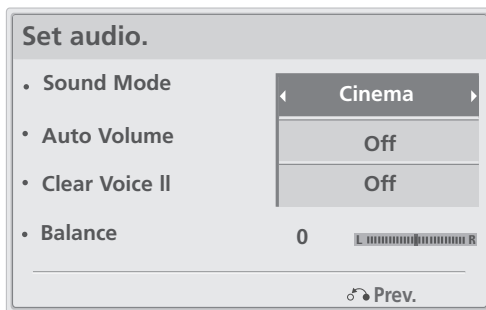
► When you select the **Set Audio**,



1   Show the **Sound Mode**, **Auto Volume**, **Clear Voice II** and **Balance**.

2   Make appropriate adjustments.

MUSIC LIST

You can use the Music List menu to play MP3 files from a USB storage device.

This TV cannot play back copy-protected files.

The On Screen Display on your model may be slightly different.

Supported music file: *.MP3

Bit rate range 8Kbps ~ 320Kbps

- Sampling rate (Sampling Frequency)
MPEG1 Layer 3 : 8KHz ~ 48KHz
- Music Max Length : 999.59 Sec.

USB

Screen Components

1

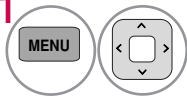

Select **USB**.

2

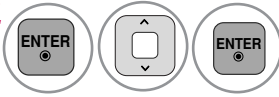

Select **Music List**.

- ① Moves to upper level file
- ② Preview: Display the title/folder name of the music in the selected folder
- ③ Current page/Total pages
- ④ Total number of marked music
- ⑤ Usable USB memory
- ⑥ Corresponding buttons on the remote control

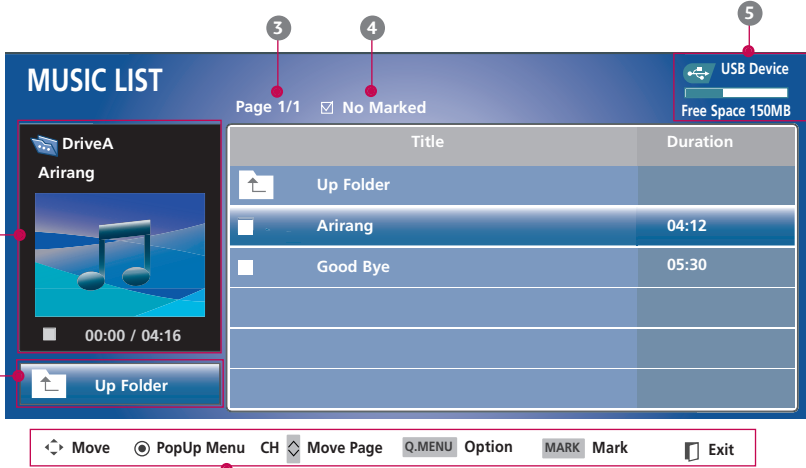

	Title	Duration
①	Up Folder	
②	Arirang	04:12
	Good Bye	05:30

Music Selection and Popup Menu

Up to 6 music titles are listed per page.

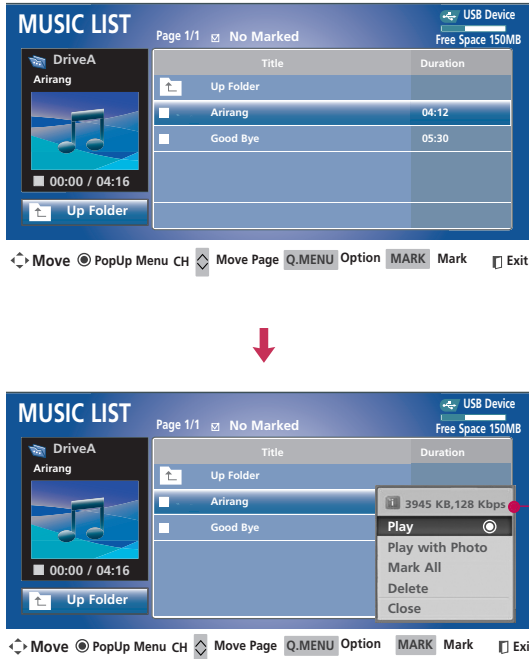

- ▶ **Play (During stop):** Play the selected music. Once a song finishes playing, the next selected one will be played. When there are no selected music to play, the next one in the current folder will be played. If you go to a different folder and press the **ENTER** button, the current music in playback will stop.
- ▶ **Play Marked:** Play the selected music. Once a music finishes playing, the next selected one will be played automatically.
- ▶ **Stop Play (During playback):** Stop the playing music.
- ▶ **Play with Photo:** Start playing the selected music and then move to the Photo List.
- ▶ **Mark All:** Mark all music in the folder.
- ▶ **Unmark All:** Deselect all marked music.
- ▶ **Delete:** Delete the selected music.
- ▶ **Close:** Close the pop-up menu.

- 1 Select the target folder or drive.
- 2 Select the desired musics.
- 3 Show the Popup menu.
- 4 Select the desired Popup menu.
- 5 Return to TV viewing

- Use the **CH** ^ v button to navigation in the music page.
- Use **MARK** button to mark or unmark a music file. If no music is marked, all the music in the folder will be played in sequence. When one or more music files are marked, the marked music files will be played in sequence. If you want to listen to only one song repeatedly, just mark that one file and play.

Using the Music List Option, play

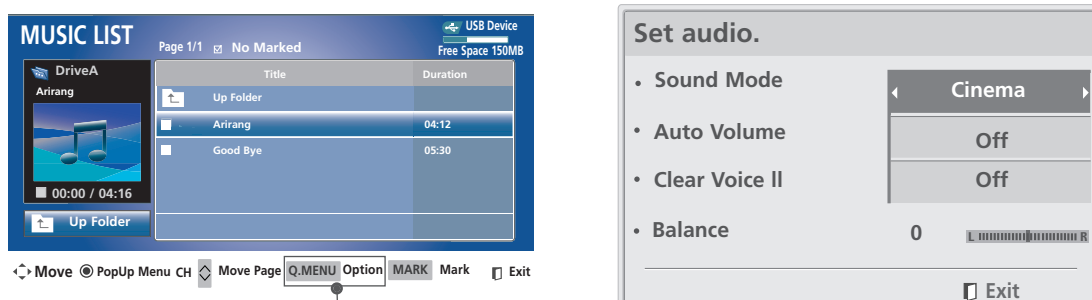

1  Show the **Sound Mode**.

2  Make appropriate adjustments.

- The play information box (as shown below) will automatically move across the screen when there is no user input to prevent a fixed image remaining on the screen for an extended period of time.

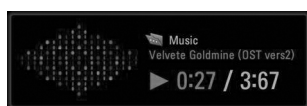

! NOTE

- ▶ When music is playing,  is displayed in front of the music play time.
- ▶ A damaged or corrupted music file that does not play displays 00:00 as the play time.
- ▶ Music files with copy-protection will not play.
- ▶ Press **ENTER**, **■**, **MENU**, **Q-Menu**, **BACK**, **EXIT** or **ENERGY SAVING** button to stop the screen saver.
- ▶ This TV can not play music files less than 16 Kbytes.

PICTURE CONTROL

PICTURE SIZE (ASPECT RATIO) CONTROL

This feature lets you choose the way an analog picture with a 4:3 aspect ratio is displayed on your TV.

- RGB-PC input source use 4:3 or 16:9 aspect ratio.

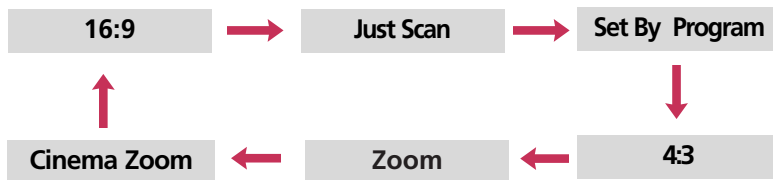
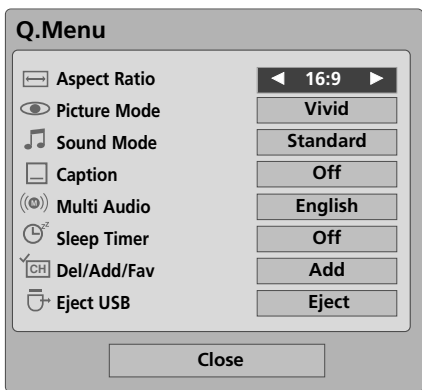

- 1   Select the **Aspect Ratio**.
- 2  Select the desired picture format.
- 3  Return to TV viewing.

- You can also press the **RATIO** button repeatedly on the remote control.

16:9

Adjust the picture horizontally, in a linear proportion to fill the entire screen.



Just Scan

Normally the edges of video signals are cropped 1-2%. Just Scan turns off this cropping and shows the complete video.

Notes: If there is noise on the edges of the original signal, it will be visible when Just Scan is activated.

Just Scan operates only in DTV/CADTV/Component/HDMI-DTV/DVI-DTV (720p/1080i/1080p) input source.



Set by program

Selects the proper picture proportion to match the source's image.

(4:3 → 4:3)



(16:9 → 16:9)



4:3

Choose 4:3 when you want to view a picture with an original 4:3 aspect ratio.



Zoom

Choose Zoom when you want to view the picture without any alteration. However, the top and bottom portions of the picture will be cropped.

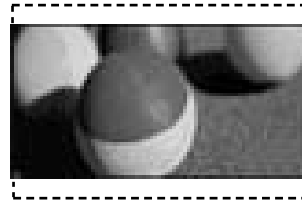

Cinema Zoom

Choose Cinema Zoom when you want to enlarge the picture in correct proportion. Note: When enlarging or reducing the picture, the image may become distorted.



■ The adjustment range is 1-16.

PICTURE CONTROL

PICTURE WIZARD

This feature lets you adjust the picture quality of the original image.

Use this to calibrate the screen quality by adjusting the Black and White Level etc. You can calibrate the screen quality by easily following each step.

When you adjust the image to **Low**, **Recommended** or **High**, you can see the example of the changes you made.

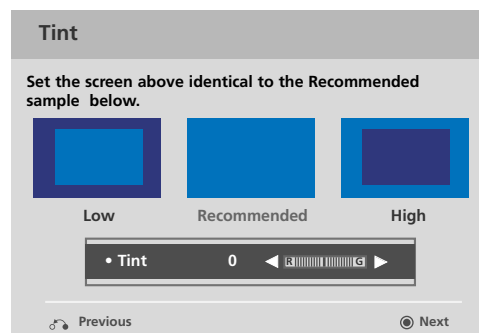
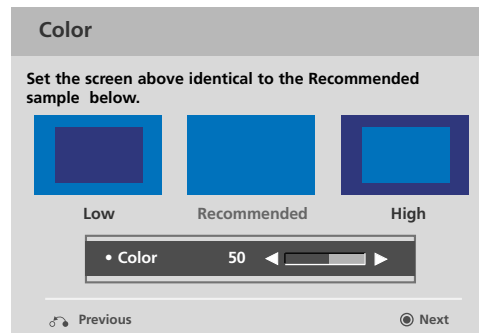
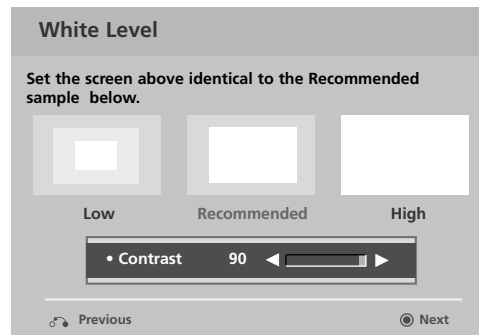
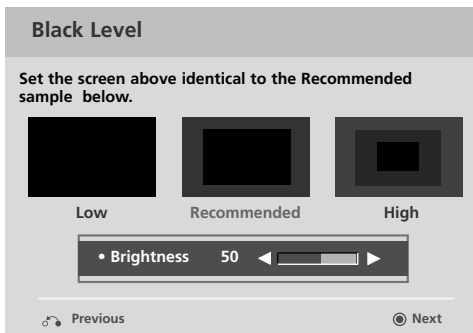
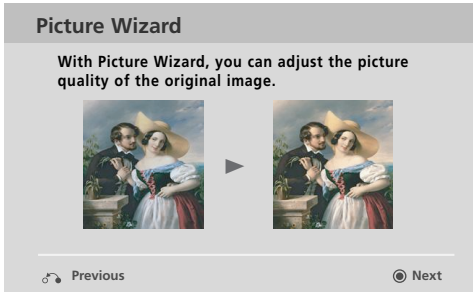
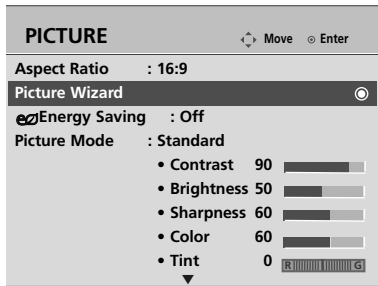

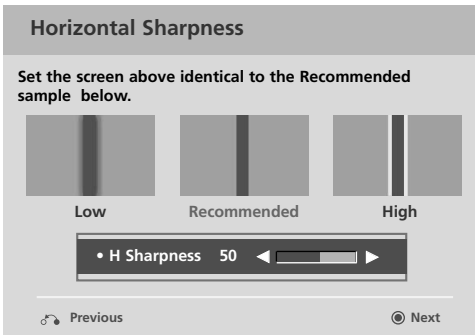

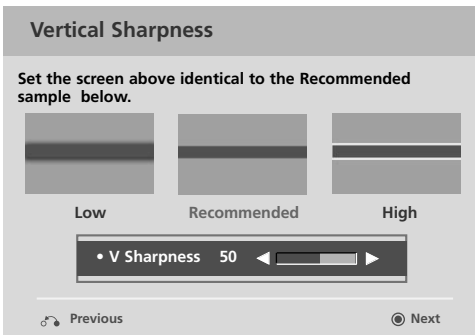

8   Adjust **Horizontal Sharpness**.



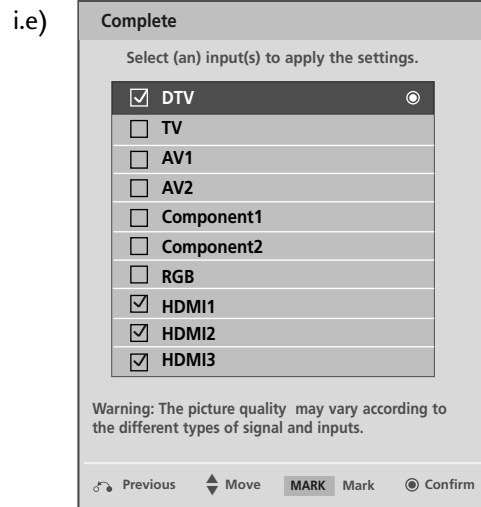

9   Adjust **Vertical Sharpness**.

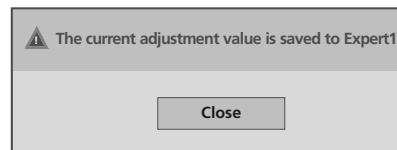

10   Select input source to apply the settings.

11  Save.



12  Finish the Picture Wizard.

■ If you stop the setting before the final step, the changes will not be saved to the TV.







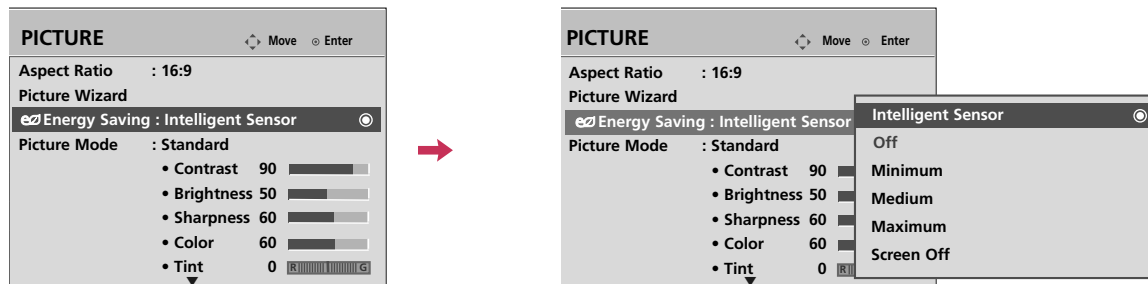

PICTURE CONTROL

e ENERGY SAVING

It reduces the TV's power consumption.

You can increase the brightness of your screen by adjusting the Energy Saving level or by setting the Picture Mode. This feature is disabled in "Picture Mode-Cinema".



-   Select **PICTURE**.
-   Select **e Energy Saving**.
-   Select **Intelligent Sensor**,
Off, Minimum, Medium or Maximum.
-  Return to the previous menu.
-  Return to TV viewing.

- You can also adjust the **ENERGY SAVING** button on the remote control.
- **Intelligent Sensor?**
This function automatically adjusts the brightness of screen to the most suitable picture according to the surrounding conditions.

PRESET PICTURE SETTINGS (PICTURE MODE)

There are factory presets for picture settings available in the user menus. You can use a preset, change each setting manually.

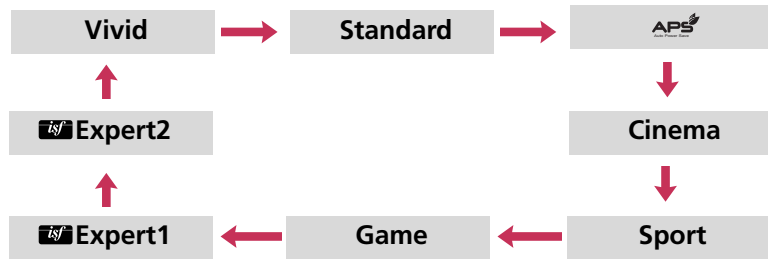
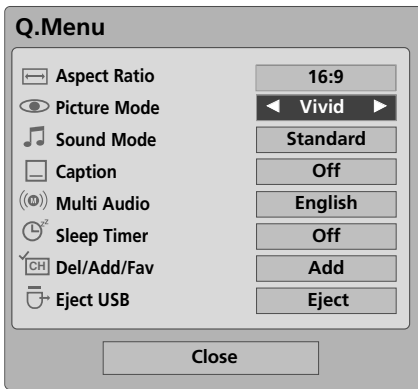

- 1 Select **Picture Mode**.
- 2 Select **Vivid, Standard, APS, Cinema, Sport, Game, Expert1 or Expert2**.
- 3 Return to TV viewing.









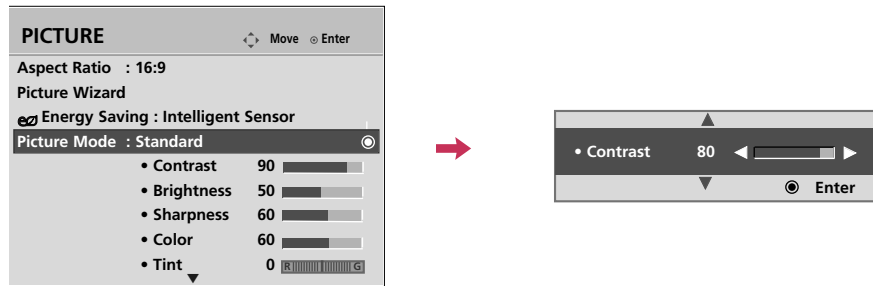



- **Vivid, Standard, APS, Cinema, Sport, and Game** Settings are preset for the optimum picture quality at the factory.
- You can also adjust **Picture Mode** in the **PICTURE** menu.
- **Vivid:** This is the mode to maximize the effect of the video in the retail store. Strengthen the contrast, brightness, color and sharpness for vivid picture.
- **APS:** This mode maximizes reducing the power consumption without hurting the picture quality.
- **Standard:** This is the mode to realize optimum viewing condition for the general user.
- **Cinema:** This mode optimizes video for watching movies.
- **Sport:** This is the video mode to emphasize dynamic video and primary color (Ex, white, uniform, grass, sky blue etc.) by realizing the optimal screen for sports.
- **Game:** This is the mode to realize fast response speed in a fast gaming screen.
- **Expert:** This is the mode to adjust the video in detail for video quality expert

PICTURE CONTROL

MANUAL PICTURE ADJUSTMENT-USER MODE

Adjust the picture appearance to suit your preference and viewing situations.



- 1   Select **PICTURE**.
- 2   Select **Picture Mode**.
- 3   Select **Vivid, Standard, Cinema, Sport, or Game**.
- 4   Select **Contrast, Brightness, Sharpness, Color, Tint or Color Temperature**.
- 5   Make appropriate adjustments.
- 6  Return to the previous menu.
-  Return to TV viewing.







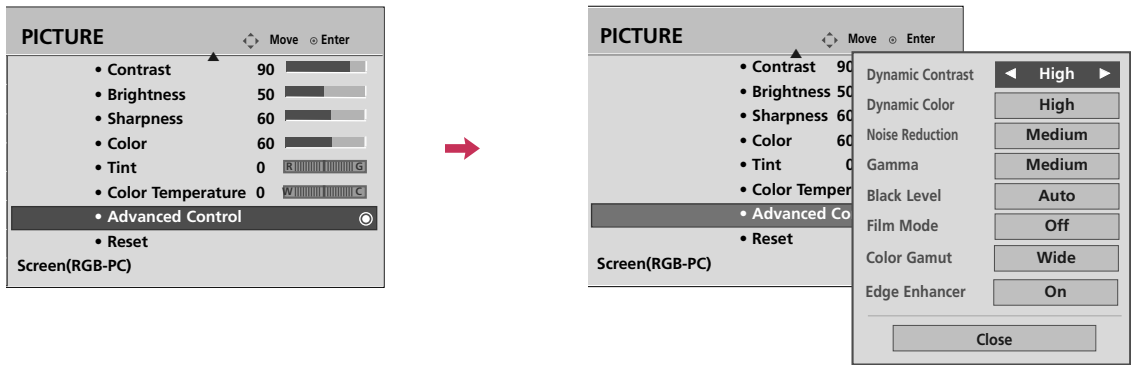

- **Contrast:** Increase or decrease the gradient of the video signal. You may use Contrast when the bright part of picture is saturated.
- **Brightness:** Adjusts the base level of the signal in the picture. You may use brightness when the dark part of the picture is saturated.
- **Sharpness:** Adjusts the level of crispness in the edges between the light and dark areas of the picture. The lower the level, the softer the image.
- **Color:** Adjusts intensity of all colors.
- **Tint:** Adjusts the balance between red and green levels.
- **Color Temperature:** Set to warm to enhance hotter colors such as red, or set to cool to make picture bluish.

PICTURE IMPROVEMENT TECHNOLOGY

You can calibrate the screen for each Picture Mode or set the video value according to the special video screen. You can set the video seeing differently for each input.



To reset to the factory default screen after making adjustments to each video mode, execute the “Reset” function for each Picture Mode.



- 1   Select **PICTURE**.
- 2   Select **Advanced Control**.
- 3   Select your desired options.
- 4  Make appropriate adjustments.
- 5  Return to the previous menu.
-  Return to TV viewing.









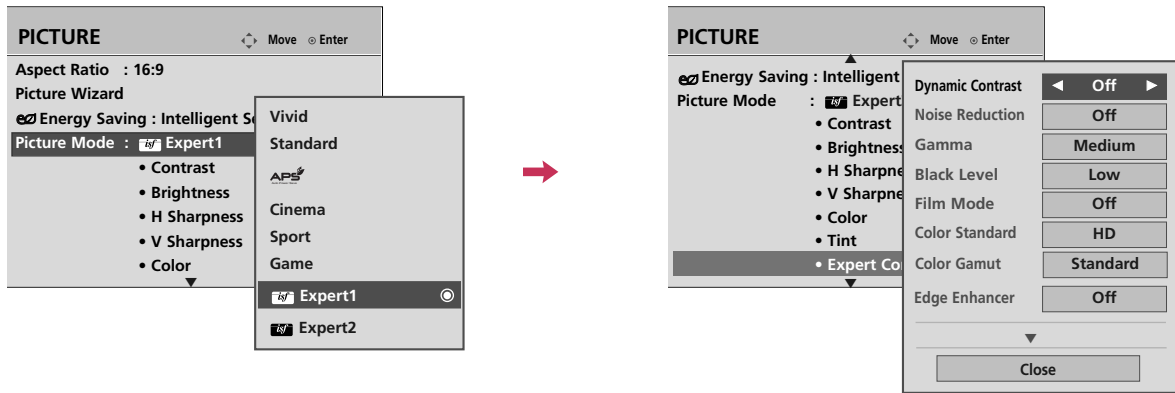





PICTURE CONTROL

EXPERT PICTURE CONTROL

By segmenting categories,  **Expert1** and  **Expert2** provide more categories which users can set as they see fit, offering the optimal picture quality for users.

This may also be used be a professional to help optimize the TV performance in the environment the TV is in.



-   Select **PICTURE**.
-   Select **Picture Mode**.
-   Select  **Expert1**, or  **Expert2**.
-   Select **Expert Control**.
-   Select your desired menu option.
-  Make appropriate adjustments.
-  Return to the previous menu.
-  Return to TV viewing.

Dynamic Contrast	<ul style="list-style-type: none"> Adjusts the contrast to keep it at the best level according to the brightness of the screen. The picture is improved by making bright parts brighter and dark parts darker.
Dynamic Color	<ul style="list-style-type: none"> Adjusts screen colors so that they look livelier, richer and clearer. This feature enhances hue, saturation and luminance so that red, blue, green and white look more vivid.
Noise Reduction	<ul style="list-style-type: none"> Reduces screen noise without compromising video quality.
Gamma	<p><i>Low : Make dark and middle gray level area of the picture brighter.</i> <i>Medium: Express original picture levels.</i> <i>High: Make dark and middle gray level area of the picture darker.</i></p> <ul style="list-style-type: none"> You can adjust brightness of dark area and middle gray level area of the picture.
Black Level	<p><i>Low: The reflection of the screen gets darker.</i> <i>High: The reflection of the screen gets brighter.</i> <i>Auto: Realizing the black level of the screen and set it to High or Low automatically.</i></p> <ul style="list-style-type: none"> Set black level of the screen to proper level. This function enables to select 'Low' or 'High' in the following mode: AV (NTSC-M), HDMI or Component. Otherwise, 'Black level' is set to 'Auto'.
Film Mode	<ul style="list-style-type: none"> Makes video clips recorded in film look more natural by eliminating judder effect. DVD and Blu-ray movies are filmed at 24 frames per second.
Color Gamut	<p><i>Standard: Displays standard color area.</i> <i>Wide: Mode to use and set the rich color area of the display.</i></p> <ul style="list-style-type: none"> Maximize the utilization of color to increase color quality.
Edge Enhancer	<ul style="list-style-type: none"> Show clearer and distinctive yet natural corners of the video.
Color Standard	<ul style="list-style-type: none"> Convert the color of a different video to HD color.
White Balance	<ul style="list-style-type: none"> This is the function to adjust the overall color of the screen to the feeling you want. <ol style="list-style-type: none"> Method : 2 Points <ul style="list-style-type: none"> Pattern: Inner, Outer Red/Green/Blue Contrast, Red/Green/Blue Brightness: The adjustment range is -50 - +50. Method : 20 Point IRE <ul style="list-style-type: none"> Pattern: Inner, Outer IRE (Institute of Radio Engineers) is the unit to display the size of the video signal and can be set among 5, 10, 15 - 95, 100. You can adjust Red, Green or Blue according to each setting. Red/Green/Blue: The adjustment range is -50 - +50.
Color Management System	<ul style="list-style-type: none"> As the tool used by the experts to make adjustments by using the test patterns, this does not affect other colors but can be used to selectively adjust the 6 color areas (Red/Green/Blue/Cyan/Mgt/Yellow). Color difference may not be distinctive even when you make the adjustments for the general video. Adjusts Red/Green/Blue/Yellow/Cyan, Magenta. <ul style="list-style-type: none"> Red/Green/Blue/Yellow/Cyan, Magenta Color: The adjustment range is -30 - +30. Red/Green/Blue/Yellow/Cyan, Magenta Tint: The adjustment range is -30 - +30. This feature is disable in RGB-PC and HDMI (PC) mode.

PICTURE CONTROL

PICTURE RESET

Settings of the selected picture modes return to the default factory settings.

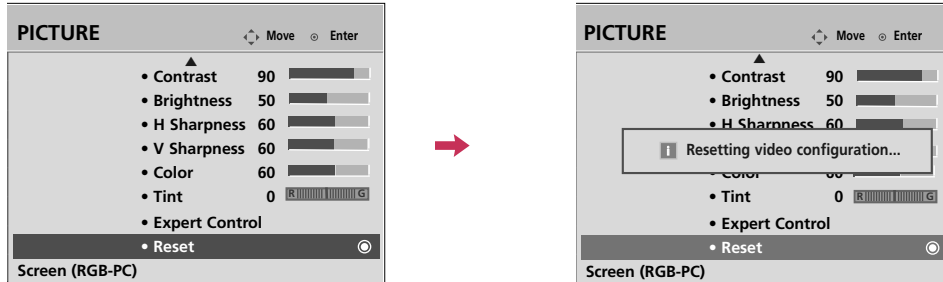

1   Select **PICTURE**.

2   Select **Reset**.

3  Initialize the adjusted value.

4  Return to TV viewing.

DEMO MODE

Displays a slide show to explain the various features of this TV.

This feature is disabled in “Initial Setting-Home Use”.

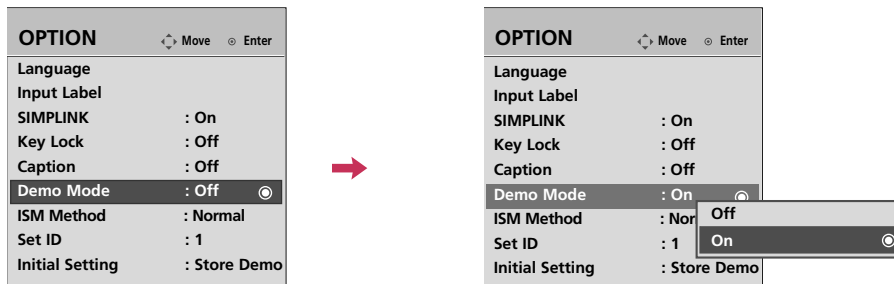

1   Select **OPTION**.

2   Select **Demo Mode**.

3   Select **On**.

4  Return to TV viewing.

After a while, **Demo Mode** starts.
If you want to stop the demo, press any button.
(except VOL or MUTE)







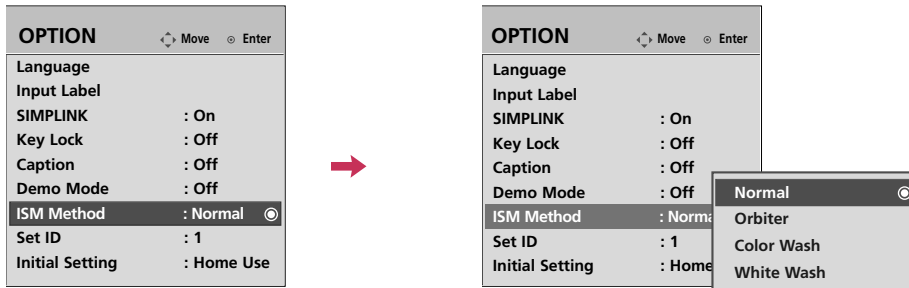

5 Show the various features of the TV.

6 Show the difference XD Engine features.

IMAGE STICKING MINIMIZATION (ISM) METHOD

A frozen still picture displayed on the screen for prolonged periods can result in a ghost image. You can use Orbiter to help prevent image sticking. The other two functions are for removing a ghost image.



- 1   Select **OPTION**.
- 2   Select **ISM Method**.
- 3   Select **Normal, Orbiter, Color Wash** or **White Wash**.
- 4  Return to the previous menu.
-  Return to TV viewing.

- **Normal:** If image sticking is never a problem, ISM is not necessary - set to Normal.
- **Orbiter:** Orbiter may help prevent ghost images. However, it is best not to allow any fixed image to remain on the screen. To avoid a ghost image on the screen, the image will move every 2 minutes.
- **Color Wash:** The color block with the screen moved a little and the white pattern are alternately displayed. It is difficult to see the after image on all colors. Once it has been corrected it will not be visible in any color.
- **White Wash:** White Wash removes ghost images from the screen. Use sparingly. Watch the TV normally for a while before using this feature to see if the ghost image disappears on its own.

! NOTE

- ▶ An excessive ghosted image may be impossible to clear entirely with White Wash. To return to normal viewing, press the any button.







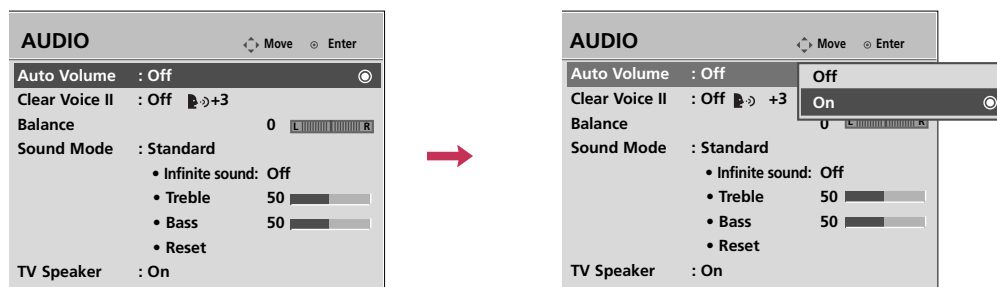

SOUND & LANGUAGE CONTROL

AUTO VOLUME LEVELER (AUTO VOLUME)

Auto Volume makes sure that the volume level remains consistent whether you are watching a commercial or a regular TV program.

Because each broadcasting station has its own signal conditions, volume adjustment may be needed every time the channel is changed. This feature allows users to enjoy stable volume levels by making automatic adjustments for each program.



-   Select **AUDIO**.
-   Select **Auto Volume**.
-   Select **On** or **Off**.
-  Return to the previous menu.
-  Return to TV viewing.

CLEAR VOICE II

By differentiating the human sound range from others, it improves the sound quality of voices.

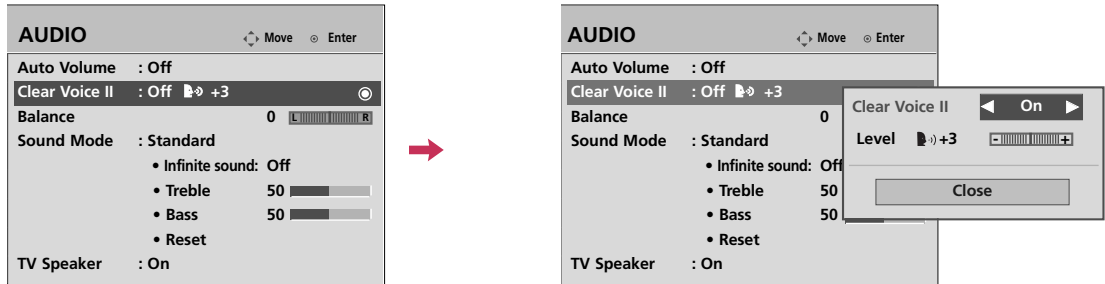

1   Select **AUDIO**.



2   Select **Clear Voice II**.

3   Select **On** or **Off**.

Adjustment for Clear Voice II Level With selecting On

4   Select **Clear Voice II**.

5   Select **Level**.

6   Make appropriate adjustments.

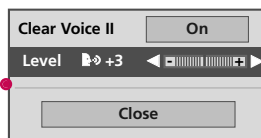

7  Return to the previous menu.

 Return to TV viewing.

SOUND & LANGUAGE CONTROL

PRESET SOUND SETTINGS (SOUND MODE)

Sound Mode lets you enjoy the best sound without any special adjustment as the TV sets the appropriate sound options based on the program content.

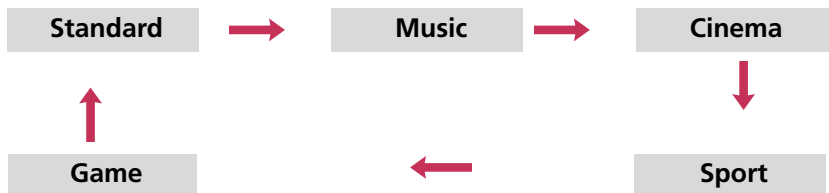
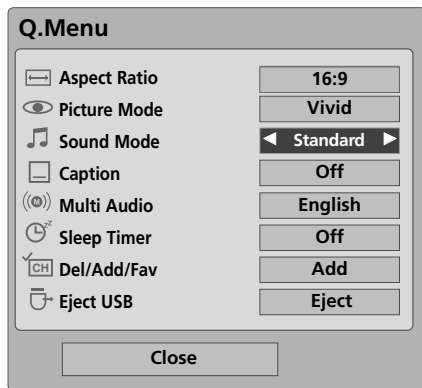

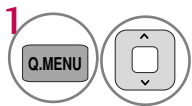
-  Select **Sound Mode**.
-  Select **Standard, Music, Cinema, Sport, or Game**.
-  Return to TV viewing.

- **Standard, Music, Cinema, Sport, and Game** are preset for optimum sound quality at the factory.
- You can also adjust **Sound Mode** in the **AUDIO** menu.
- **Standard:** Offers standard-quality sound.
- **Music:** Optimizes sound for listening to music.
- **Cinema:** Optimizes sound for watching movies.
- **Sport:** Optimizes sound for watching sports events.
- **Game:** Optimizes sound for playing games.

SOUND SETTING ADJUSTMENT - USER MODE

Adjust the sound to suit your taste and room situations.

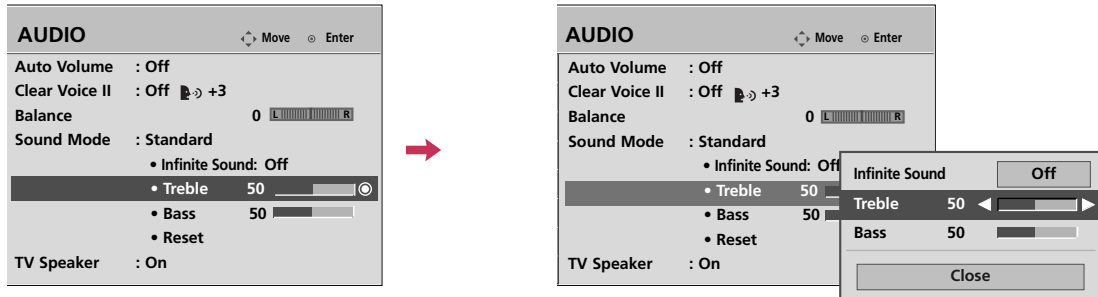





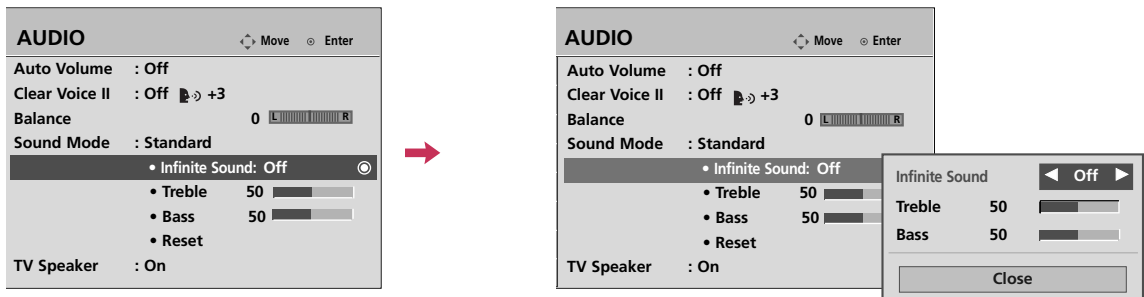

- 1   Select **AUDIO**.
- 2   Select **Sound Mode**.
- 3   Select **Standard, Music, Cinema, Sport, or Game**.
- 4   Select **Treble** or **Bass**.
- 5   Make appropriate adjustments.
- 6  Return to the previous menu.
-  Return to TV viewing.

SOUND & LANGUAGE CONTROL

INFINITE SOUND

Select this option to sound realistic.









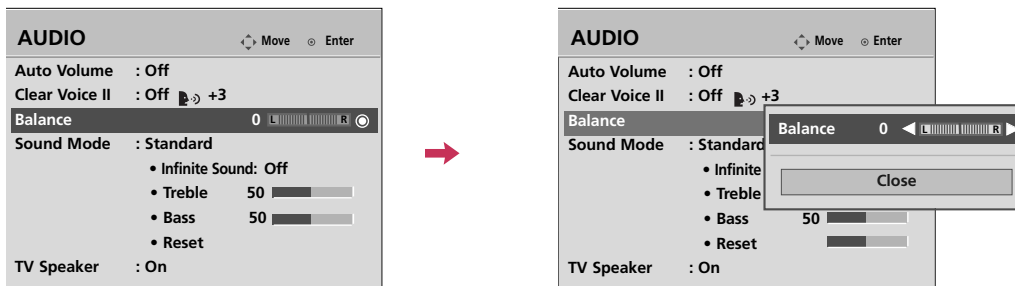

- 1   Select **AUDIO**.
- 2   Select **Infinite Sound**.
- 3   Select **On** or **Off**.
- 4  Return to the previous menu.
-  Return to TV viewing.

- If sound quality or volume is not at the level you want, it is recommended to use a separate home theater system or amp to cope with different user environments.
- If you select “**Clear Voice II-On**”, **Infinite Sound** feature will not work.

BALANCE

Adjust the left/right sound of speaker to suit your taste and room situations.



-   Select **AUDIO**.
-   Select **Balance**.
-   Make appropriate adjustments.
-  Return to the previous menu.
-  Return to TV viewing.

SOUND & LANGUAGE CONTROL

TV SPEAKERS ON/OFF SETUP

Turn the TV speakers off if using external audio equipment.

In **AV**, **Component**, **RGB** and **HDMI** with HDMI to DVI cable, the TV speaker can be operational even when there is no video signal.

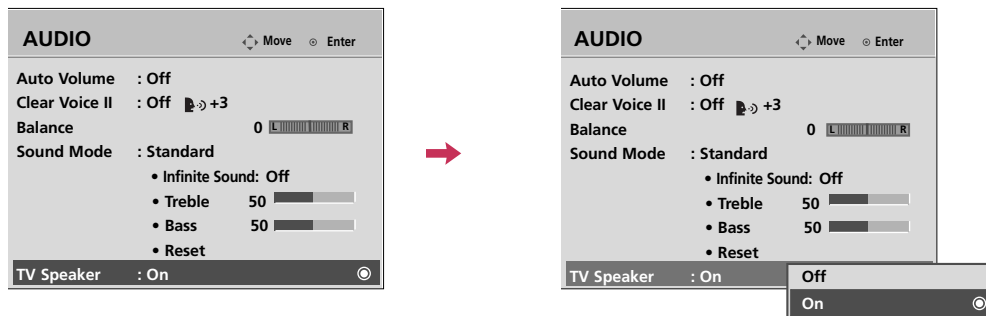

-   Select **AUDIO**.
-   Select **TV Speaker**.
-   Select **On** or **Off**.
-  Return to the previous menu.
-  Return to TV viewing.

AUDIO RESET

Settings of the selected Sound Mode return to the default factory settings.

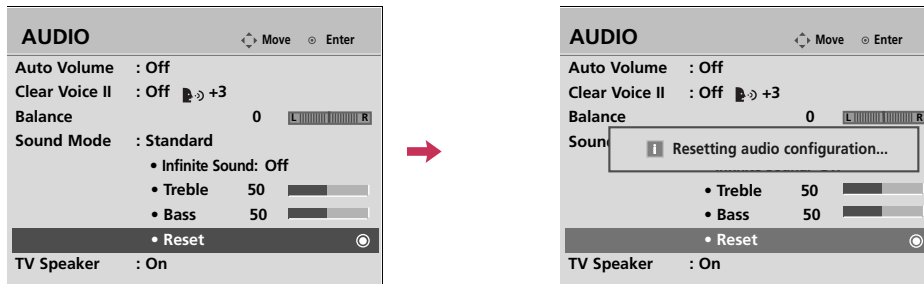

1   Select **AUDIO**.

2   Select **Reset**.

3  Initialize the adjusted value.

4  Return to TV viewing.



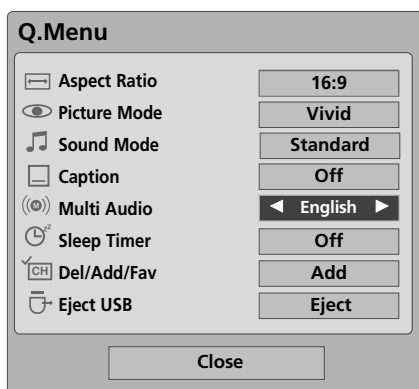

SOUND & LANGUAGE CONTROL

STEREO/SAP BROADCAST SETUP





For Analog only: This TV can receive MTS stereo programs and any SAP (Secondary Audio Program) that accompanies the stereo program if the station transmits an additional sound signal. Mono sound is automatically used if the broadcast is only in Mono.



Analog TV

-   Select **SAP**.
-  Select **Mono, Stereo, or SAP**.
-  Return to TV viewing.



Digital TV

-   Select **Multi Audio**.
-  Select other languages.
-  Return to TV viewing.

AUDIO LANGUAGE

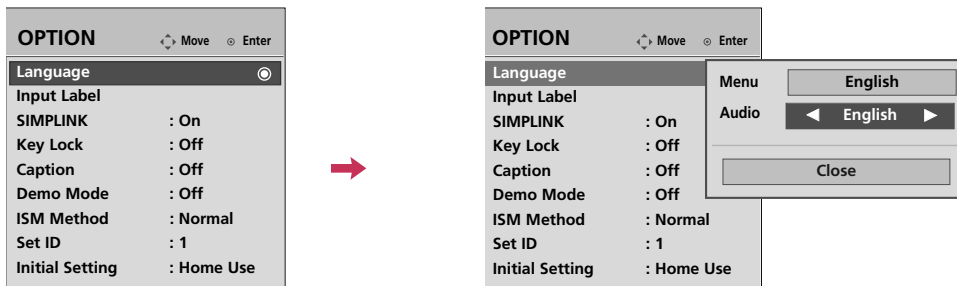
Other languages may be available if a digital signal is provided by the broadcasting station.
This feature operates only in DTV/CADTV mode.





-   Select **OPTION**.
-   Select **Language**.
-   Select **Audio**.
-   Select your desired language.
-  Return to the previous menu.
-  Return to TV viewing.

SOUND & LANGUAGE CONTROL

ON-SCREEN MENUS LANGUAGE SELECTION

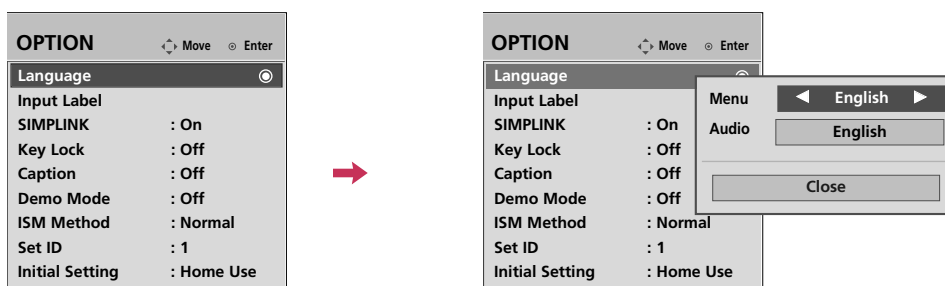
The menus can be shown on the screen in the selected language.

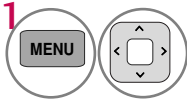
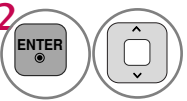
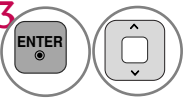
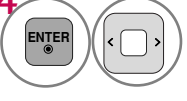









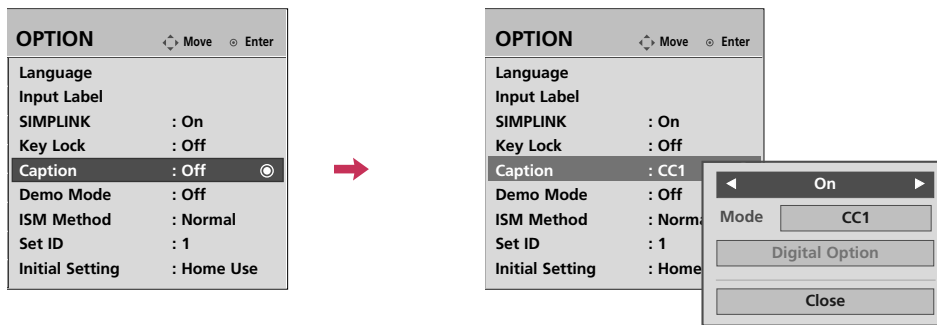

-  Select **OPTION**.
-  Select **Language**.
-  Select **Menu**.
-  Select your desired language.
From this point on, the on-screen menus will be shown in the selected language.
-  Return to the previous menu.
-  Return to TV viewing.

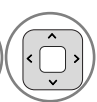
CAPTION MODE

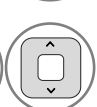
Analog Broadcasting System Captions

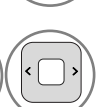
Captions are provided to help people with hearing loss watch TV. Select a caption mode for displaying captioning information if provided on a program. Analog caption displays information at any position on the screen and is usually the program's dialog. Caption/Text, if provided by the broadcaster, would be available for both digital and analog channels on the Antenna/Cable. This TV is programmed to memorize the caption/text mode which was last set when you turned the power off. This function is only available when **Caption Mode** is set **On**.

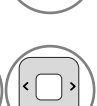

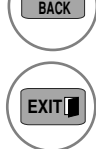
-   Select **OPTION**.
-   Select **Caption**.
-   Select **On**.
-   Select **CC1-4** or **Text1-4**.
-  Return to the previous menu.
-  Return to TV viewing.

- When selecting **Off**, Sub-menus for Analog, DTV, and Digital Option become disabled.
- **CAPTION**
The term for the words that scroll across the bottom of the TV screen; usually the audio portion of the program provided for the hearing impaired.
- **TEXT**
The term for the words that appear in a large black frame and almost cover the entire screen; usually messages provided by the broadcaster.

SOUND & LANGUAGE CONTROL









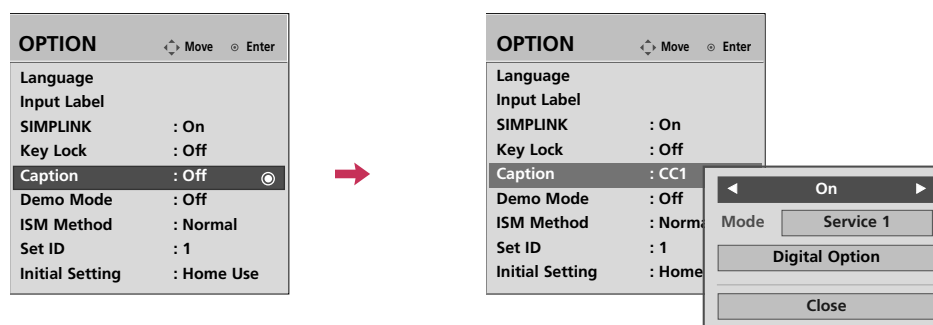

Digital Broadcasting System Captions

Choose the language you want the DTV/CADTV Captions to appear in.

Other Languages can be chosen for digital sources only if they are included on the program.

This function is only available when **Caption Mode** is set **On**.



-   Select **OPTION**.
-   Select **Caption**.
-   Select **On**.
-   Select **CC1-4, Text1-4, or Service1 - 6**.
-  Return to the previous menu.
-  Return to TV viewing.

Caption Option

Customize the DTV/CADTV captions that appear on your screen.
This function is only available when Caption Mode is turned On.

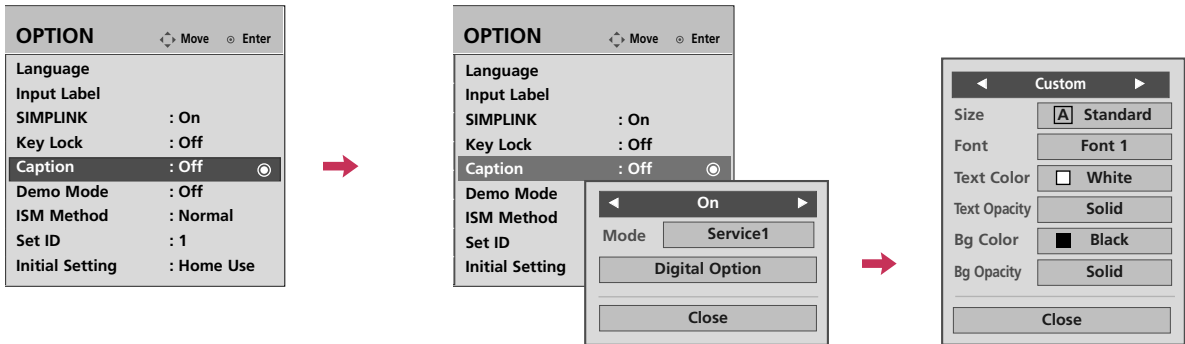



1   Select **OPTION**.

2   Select **Caption**

3   Select **On**.

4  Select **Digital Option**.

5   Select **Custom**.

6   Customize the **Style, Font**, etc., to your preference. A preview icon is provided at the bottom of the screen, use it to see the caption language.

7  Return to the previous menu.

 Return to TV viewing.

- **Size:** Set the word size.
- **Font:** Select a typeface for the text.
- **Text Color:** Choose a color for the text.
- **Text Opacity:** Specify the opacity for the text color.
- **Bg (Background) Color:** Select a background color.
- **Bg (Background) Opacity:** Select the opacity for the background color.

TIME SETTING

CLOCK SETTING









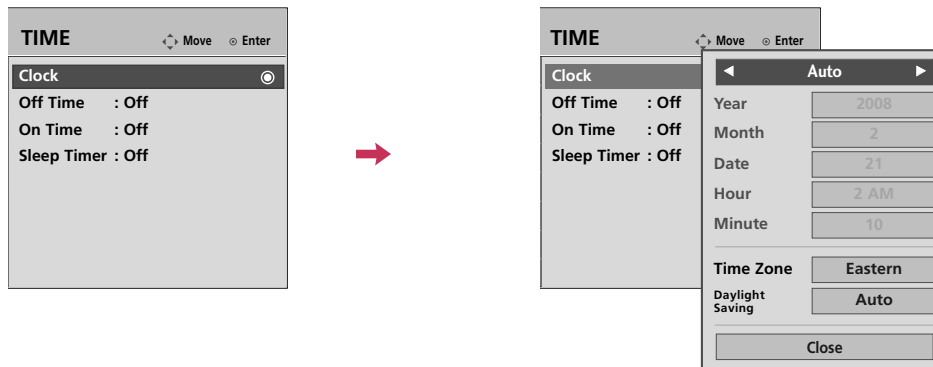



Auto Clock Setup

The time is set automatically from a digital channel signal.

The digital channel signal includes information for the current time provided by the broadcasting station.

Set the clock manually if the current time is set incorrectly by the auto clock function.









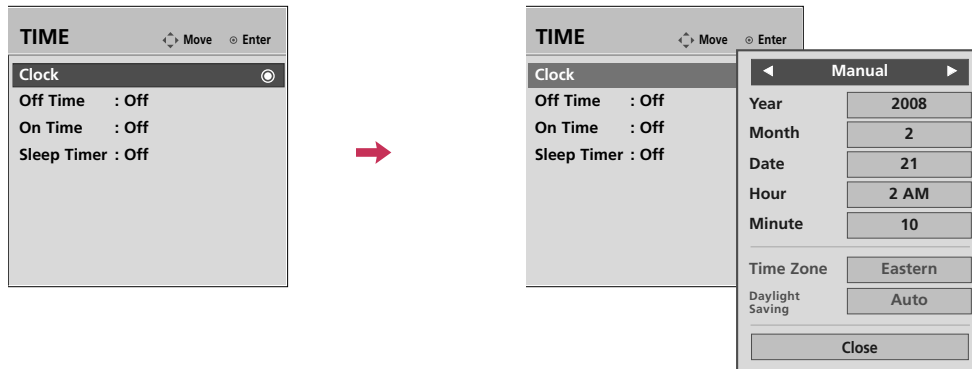



- 1   Select **TIME**.
- 2   Select **Clock**.
- 3   Select **Auto**.
- 4   Select your viewing area time zone.
 - U.S.A: **Eastern, Central, Mountain, Pacific, Alaska, or Hawaii.**
 - Canada: **Eastern, Central, Mountain, Pacific, New F.land, or Atlantic.**
- 5   Select **Auto, On, or Off** (depending on whether or not your viewing area observes Daylight Saving time).
- 6  Return to the previous menu.
-  Return to TV viewing.

Manual Clock Setup

If the current time setting is wrong, set the clock manually.



-   Select **TIME**.
-   Select **Clock**.
-   Select **Manual**.
-  Select the Year, Month, Date, Hour, or Minutes option.
-  Set the Year, Month, Date, Hour, or Minutes option.
-  Return to the previous menu.
-  Return to TV viewing.

► If you unplug the TV once or turn the main power off, the clock function reset.

TIME SETTING

AUTO ON/OFF TIME SETTING

This function operates only if the current time has been set.

The **Off Time** function overrides the **On Time** function if they are both set to the same time.

The TV must be in standby mode for the **On Time** to work.

If you do not press any button within 2 hours after the TV turns on with the **On Time** function, the TV will automatically revert to standby mode.



- 1 Select **TIME**.
- 2 Select **Off time** or **On time**.
- 3 Select **Repeat**.
- 4 Select **Off, Once, Daily, Mon.~Fri., Mon.~Sat., Weekend, or Sunday**.
- 5 Select and set **Hour** or **Minute**.
- 6 Return to the previous menu.
- Return to TV viewing.

- To cancel **On/Off Time** function, select **Off**.
- Only for **On Time** function

- 1 Select **Input**.
- 2 Select the desired input source.
- 3 When Selecting **TV**: set the channel at turn-on.
- 4 Adjust to sound level at turn-on.

SLEEP TIMER SETTING

The Sleep Time turns the TV off at the preset time.

Note that this setting is cleared when the TV is turned off.

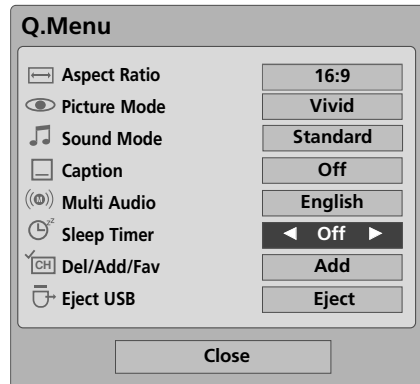

1   Select **Sleep Timer**.

2  Select **Off, 10, 20, 30, 60, 90, 120, 180, or 240** minutes.

3  Return to TV viewing.

■ You can also adjust **Sleep Timer** in the **TIME** menu.

PARENTAL CONTROL / RATINGS

Parental Control can be used to block specific channels, ratings and other viewing sources.

The Parental Control Function (V-Chip) is used to block program viewing based on the ratings sent by the broadcasting station. The default setting is to allow all programs to be viewed. Viewing can be blocked by choosing the type of the program and the categories. It is also possible to block all program viewing for a time period. To use this function, the following must be done :

1. Set ratings and categories to be blocked.
2. Specify a password
3. Enable the lock

V-Chip rating and categories

Rating guidelines are provided by broadcasting stations. Most television programs and television movies can be blocked by TV Rating and/or Individual Categories. Movies that have been shown at the theaters or direct-to-video movies use the Movie Rating System (MPAA) only.

Ratings for Television programs including made-for-TV movies :

- TV-G (General audience)
- TV-PG (Parental guidance suggested)
- TV-14 (Parents strongly cautioned)
- TV-MA (Mature audience only)
- TV-Y (All children)
- TV-Y7 (Children 7 years older)

SET PASSWORD & LOCK SYSTEM

Setting up Your Password

Set up blocking schemes to block specific channels, ratings, and external viewing sources. A password is required to gain access to this menu.

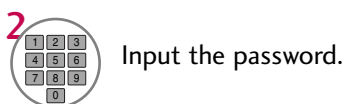



- Enter the password as requested.
- If you forgot your password, press “0-3-2-5” on the remote control.

Lock System

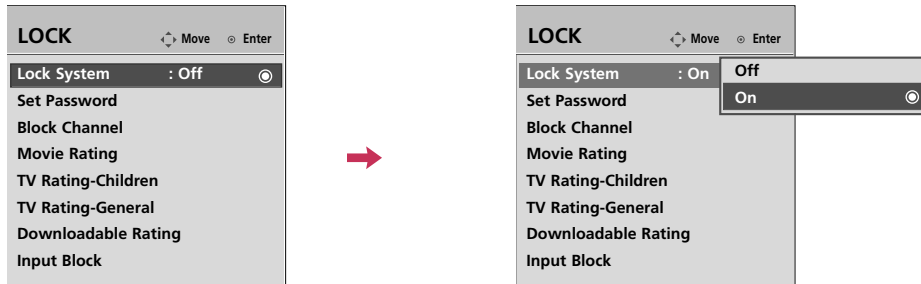
Enables or disables the blocking scheme you set up previously.





1    Select **LOCK**.

2  Input the password.

3  Select **Lock System**.

4   Select **On** or **Off**.

5  Return to the previous menu.

 Return to TV viewing.



- When you select **On**, the Lock System is enable.

PARENTAL CONTROL / RATINGS

Set Password

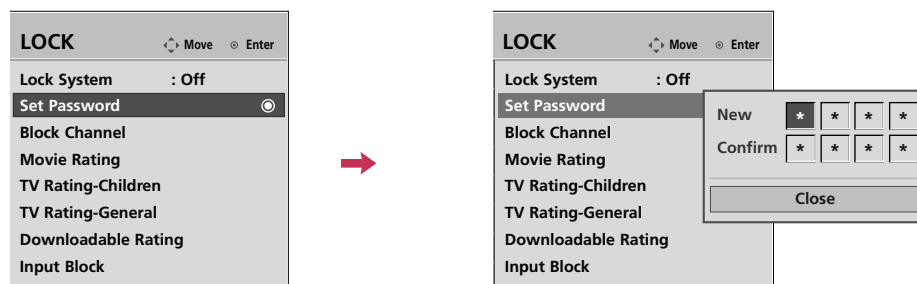
Change the password by inputting a new password twice.

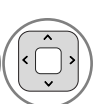



1    Select **LOCK**.

2  Input the password.

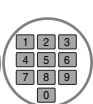
3  Select **Set password**.

4   Choose any 4 digits for your new password.
As soon as the 4 digits are entered, re-enter the same 4 digits on the **Confirm**.



5  Return to the previous menu.

 Return to TV viewing.

CHANNEL BLOCKING

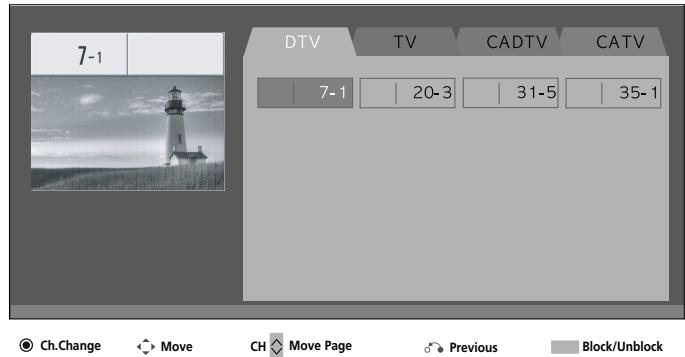
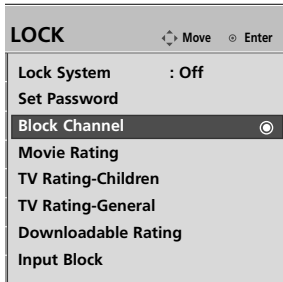

Blocks any channels that you do not want to watch or that you do not want your children to watch.





1    Select **LOCK**.

2  Input the password.

3  Select **Block Channel**.

4   Select a channel to block or unblock.

5  Block or unblock a channel.

6  Return to the previous menu.

 Return to TV viewing.



PARENTAL CONTROL / RATINGS

MOVIE & TV RATING

Movie Rating (MPAA) - For USA only

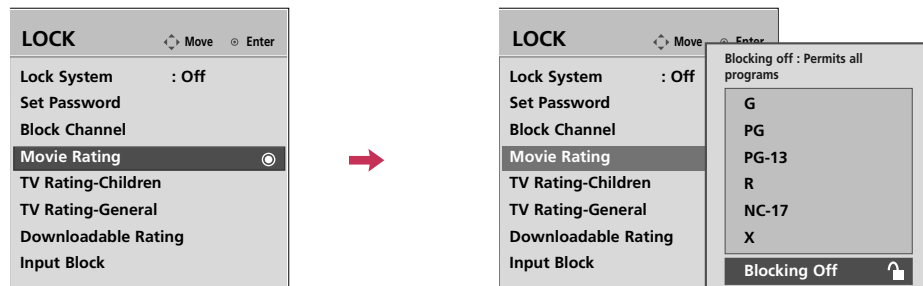
Blocks movies according to the movie ratings limits specified, so children cannot view certain movies. You can set the ratings limit by blocking out all the movies with the ratings above a specified level. Keep in mind that the movie ratings limit only applies to movies shown on TV, not TV programs, such as soap operas.





1    Select **LOCK**.

2  Input the password.

3  Select **Movie Rating**.

4   Select **G, PG, PG-13, R, NC-17, X, or Blocking Off**.

5  Return to the previous menu.









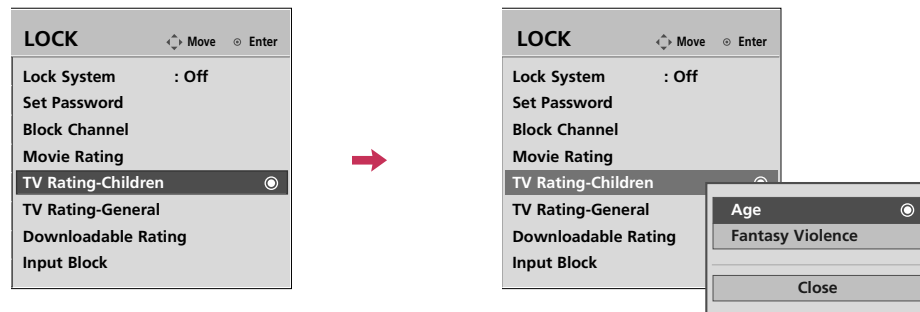

 Return to TV viewing.

- G (General audience)
- PG (Parental guidance suggested)
- PG-13 (Parents strongly cautioned)
- R (Restricted)
- NC-17 (No one 17 and under admitted)
- X (Adult only)
- Blocking Off (Permits all programs)
- ▶ If you set PG-13: G and PG movies will be available, PG-13, R, NC-17 and X will be blocked.

TV Rating Children - For USA only

Prevents children from watching certain children's TV programs, according to the ratings limit set. The children rating does not apply to other TV programs. Unless you block certain TV programs intended for mature audiences in the TV Rating - sub menu, your children can view those programs.



-    Select **LOCK**.
-  Input the password.
-  Select **TV Rating-Children**.
-   Select **Age** or **Fantasy Violence**.
-   Select block options.
-  Return to the previous menu.
-  Return to TV viewing.

- Age (applies to TV-Y, TV-Y7)
- Fantasy Violence (applies to TV-Y7)

PARENTAL CONTROL / RATINGS

TV Rating General - For USA only

Based on the ratings, blocks certain TV programs that you and your family do not want to view.

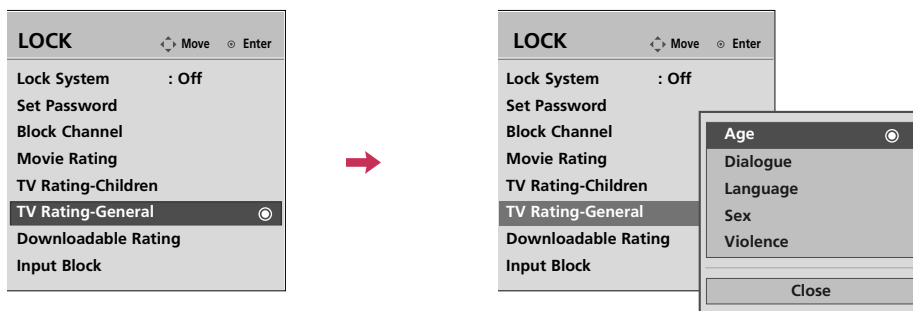

1    Select **LOCK**.

2  Input the password.

3  Select **TV Rating-General**.

4   Select **Age, Dialogue, Language, Sex or Violence**.

5   Select block options.

6  Return to the previous menu.

 Return to TV viewing.

- Age (applies to TV-G,TV-PG,TV-14,TV-MA).
- Dialogue-sexual dialogue (applies to TV-PG,TV-14).
- Language-adult language (applies to TV-PG, TV-14, TV-MA).
- Sex-sexual situations (applies to TV-PG, TV-14, TV-MA).
- Violence (applies to TV-PG, TV-14, TV-MA).

TV Rating English - For CANADA only

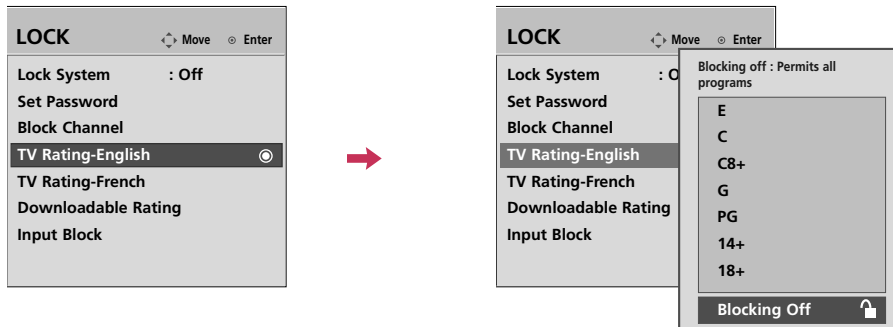

Selecting English rating system.





1    Select **LOCK**.

2  Input the password.

3  Select **TV Rating-English**.

4   Select **E, C, C8+, G, PG, 14+, 18+, or Blocking Off**.

5  Return to the previous menu.

 Return to TV viewing.

- E (Exempt)
- C (Children)
- C8+ (Children eight years and older)
- G (General programming, suitable for all audiences)
- PG (Parental Guidance)
- 14+ (Viewers 14 years and older)
- 18+ (Adult programming)
- Blocking Off (Permits all programs)

PARENTAL CONTROL / RATINGS

TV Rating French - *For CANADA only*

Selecting Canadian French rating system.

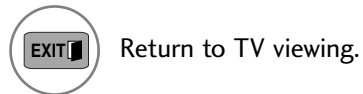
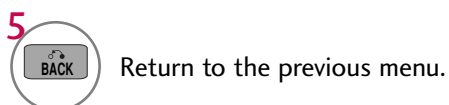
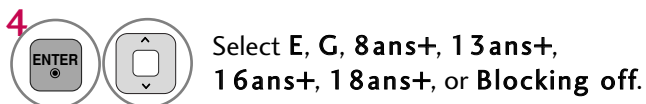
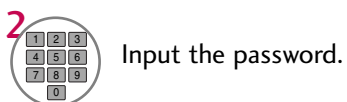
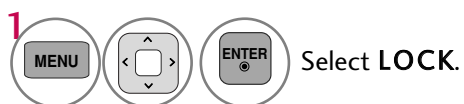
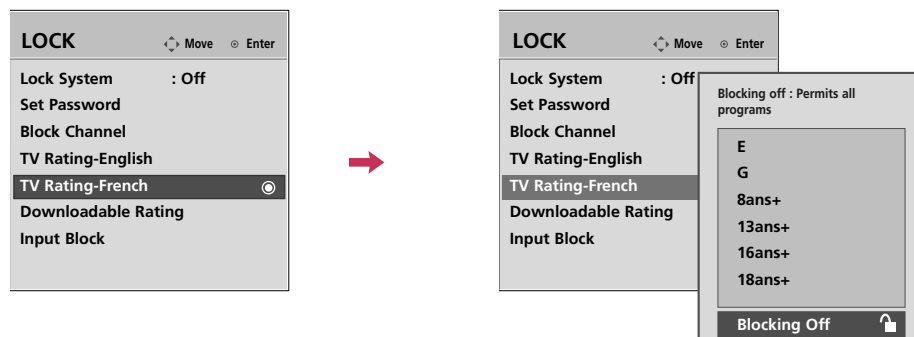

- E (Exempt)
- G (General)
- 8ans+ (General-Not convenient for little children)
- 13ans+ (Not convenient for children of 13 years and younger)
- 16ans+ (Not convenient for children of 16 years and younger)
- 18ans+ (This programs is only for adults)
- Blocking off (Permits all programs)







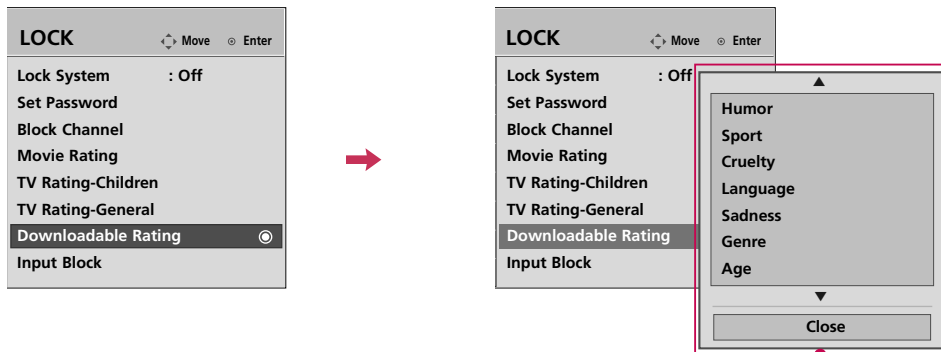



DOWNLOADABLE RATING

This function is available only for digital channels.

This function operates only when TV has received Region5 Rating data.



■ Based on rating table, your TV's OSD (On Screen Display) may differ slightly from what is shown in this manual.









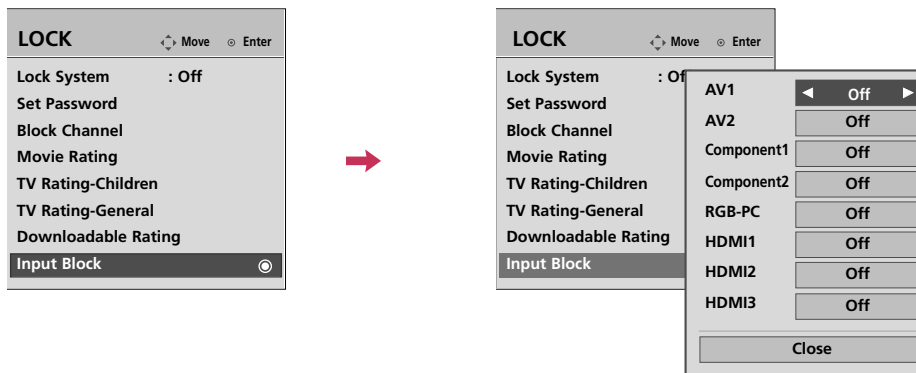

- 1    Select **LOCK**.
- 2  Input the password.
- 3  Select **Downloadable Rating**.
- 4   Select desired **Downloadable Rating** option.
- 5   Select desired option and block it.
- 6  Return to the previous menu.
-  Return to TV viewing.

PARENTAL CONTROL / RATINGS

EXTERNAL INPUT BLOCKING

Enables you to block an input.









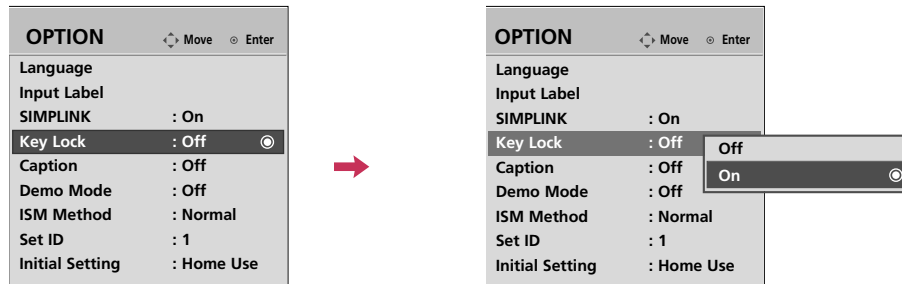

-    Select **LOCK**.
-  Input the password.
-  Select **Input Block**.
-   Select input source.
-  Select **On** or **Off**.
-  Return to the previous menu.
-  Return to TV viewing.

KEY LOCK

The TV can be set up so that it can only be used with the remote control. This feature can be used to prevent unauthorized viewing by locking out the front panel controls. This TV is programmed to remember which option it was last set to even if you turn the TV off.



- 1   Select **OPTION**.
- 2   Select **Key Lock**.
- 3   Select **On** or **Off**.
- 4  Return to the previous menu.
-  Return to TV viewing.

- In **Key Lock 'On'**, if the TV is turned off, press the ϕ /I (power), **INPUT**, **CH ^**, **CH v** button on the TV or **POWER**, **INPUT**, **CH ^**, **CH v** or **NUMBER** buttons on the remote control.
- With the **Key Lock On**, the display **'⚠ Key Lock'** appears on the screen if any button (Except ϕ /I (power) button) on the front panel is pressed while viewing the TV.

APPENDIX

TROUBLESHOOTING

The operation does not work normally.	
The remote control doesn't work	<ul style="list-style-type: none"> Check to see if there is any object between the product and the remote control causing obstruction. Ensure you are pointing the remote control directly at the TV. Ensure that the batteries are installed with correct polarity (+ to +, - to -). Ensure that the correct remote operating mode is set: TV, VCR etc. Install new batteries. <p style="text-align: right;">*This feature is not available for all models.</p>
Power is suddenly turned off	<ul style="list-style-type: none"> Is the sleep timer set? Check the power control settings. Power interrupted. TV will be automatically turned off, in case of no signal for 15 minutes.

The video function does not work.	
No picture & No sound	<ul style="list-style-type: none"> Check whether the product is turned on. Try another channel. The problem may be with the broadcast. Is the power cord inserted into wall power outlet? Check your antenna direction and/or location. Test the wall power outlet, plug another product's power cord into the outlet where the product's power cord was plugged in.
Picture appears slowly after switching on	<ul style="list-style-type: none"> This is normal, the image is muted during the product startup process. Please contact your service center, if the picture has not appeared after five minutes.
No or poor color or poor picture	<ul style="list-style-type: none"> Adjust Color in menu option. Keep a sufficient distance between the product and the VCR. Try another channel. The problem may be with the broadcast. Are the video cables installed properly? Activate any function to restore the brightness of the picture.
Horizontal/vertical bars or picture shaking	<ul style="list-style-type: none"> Check for local interference such as an electrical appliance or power tool.
Poor reception on some channels	<ul style="list-style-type: none"> Station or cable product experiencing problems, tune to another station. Station signal is weak, reorient antenna to receive weaker station. Check for sources of possible interference.
Lines or streaks in pictures	<ul style="list-style-type: none"> Check antenna (Change the direction of the antenna).
No picture when connecting HDMI	<ul style="list-style-type: none"> Check HDMI cable over version 1.3. The HDMI cables don't support HDMI version 1.3, it cause flickers or no screen display. In this case use the latest cables that support HDMI version 1.3.

The audio function does not work.

Picture OK & No sound	<ul style="list-style-type: none"> ■ Press the VOL or VOLUME button. ■ Sound muted? Press MUTE button. ■ Try another channel. The problem may be with the broadcast. ■ Are the audio cables installed properly?
No output from one of the speakers	<ul style="list-style-type: none"> ■ Adjust Balance in menu option.
Unusual sound from inside the product	<ul style="list-style-type: none"> ■ A change in ambient humidity or temperature may result in an unusual noise when the product is turned on or off and does not indicate a fault with the product.
No sound when connecting HDMI/USB	<ul style="list-style-type: none"> ■ Check HDMI cable over version 1.3. ■ Check USB cable over version 2.0. ■ Use normal MP3 file. <p style="text-align: right; margin-top: 10px;">*This feature is not available for all models.</p>

There is a problem in PC mode. (Only PC mode applied)

The signal is out of range	<ul style="list-style-type: none"> ■ Adjust resolution, horizontal frequency, or vertical frequency. ■ Check the input source.
Vertical bar or stripe on background & Horizontal Noise & Incorrect position	<ul style="list-style-type: none"> ■ Work the Auto configure or adjust clock, phase, or H/V position. (Option)
Screen color is unstable or single color	<ul style="list-style-type: none"> ■ Check the signal cable. ■ Reinstall the PC video card.

MAINTENANCE

Early malfunctions can be prevented. Careful and regular cleaning can extend the amount of time you can enjoy your new TV.

Caution: Be sure to turn the power off and unplug the power cord before you begin any cleaning.

Cleaning the Screen

- 1 Here's a great way to keep the dust off your screen for a while. Wet a soft cloth in a mixture of lukewarm water and a little fabric softener or dish washing detergent. Wring the cloth until it's almost dry, and then use it to wipe the screen.
- 2 Make sure the excess water is off the screen, and then let it air-dry before you turn on your TV.

Cleaning the Cabinet

- To remove dirt or dust, wipe the cabinet with a soft, dry, lint-free cloth.
- Please be sure not to use a wet cloth.

Extended Absence

CAUTION

- ▶ If you expect to leave your TV dormant for a long time (such as a vacation), it's a good idea to unplug the power cord to protect against possible damage from lightning or power surges.

PRODUCT SPECIFICATIONS

MODEL		50PK550, 50PK550C (50PK550-UD, 50PK550C-UD) (50PK550-UE)	60PK550, 60PK550C (60PK550-UD, 60PK550C-UD)
Dimensions (Width x Height x Depth)	With stand	1171.4 mm x 786.2 mm x 309.7 mm (46.1 inch x 30.9 inches x 12.1 inch)	1392 mm x 915 mm x 367 mm (54.8 inch x 36 inch x 14.4 inch)
	Without stand	1171.4 mm x 724.4 mm x 55.3 mm (46.1 inches x 28.5 inch x 2.1 inch)	1392 mm x 852 mm x 55.3 mm (54.8 inch x 33.5 inch x 2.1 inch)
Weight	With stand	31 kg (68.3 lb)	49.5 kg (109.1 lb)
	Without stand	28.6 kg (63.0 lb)	45 kg (99.2 lb)
MODEL		42PJ350, 42PJ350C (42PJ350-UB, 42PJ350C-UB)	50PJ350, 50PJ350C (50PJ350-UB, 50PJ350C-UB)
Dimensions (Width x Height x Depth)	With stand	988 mm x 688.5 mm x 260 mm (38.8 inch x 27.1 inches x 10.2 inch)	1171.4 mm x 781.8 mm x 309.7 mm (46.1 inches x 30.7 inch x 12.1 inch)
	Without stand	988 mm x 617.8 mm x 55.3 mm (38.8 inch x 24.3 inch x 2.1 inches)	1171.4 mm x 720.9 mm x 55.3 mm (46.1 inches x 28.3 inch x 2.1 inch)
Weight	With stand	21.6 kg (47.6 lb)	30kg (66.1 lb)
	Without stand	20 kg (44 lb)	27.6 kg (60.8 lb)
MODEL		42PJ340 (42PJ340-UB)	50PJ340 (50PJ340-UB, 50PJ340-UC, 50PJ340-UH)
Dimensions (Width x Height x Depth)	With stand	988 mm x 688.5 mm x 260 mm (38.8 inch x 27.1 inch x 10.2 inch)	1171.4 mm x 781.8 mm x 309.7 mm (46.1 inches x 30.7 inch x 12.1 inch)
	Without stand	988 mm x 617.8 mm x 55.3 mm (38.8 inch x 24.3 inch x 2.1 inch)	1171.4 mm x 720.9 mm x 55.3 mm (46.1 inches x 28.3 inch x 2.1 inch)
Weight	With stand	21.6 kg (47.6 lb)	30 kg (66.1 lb)
	Without stand	20 kg (44 lb)	27.6 kg (60.8 lb)
MODEL		50PK540 (50PK540-UE)	60PK540 (60PK540-UE)
Dimensions (Width x Height x Depth)	With stand	1171.4 mm x 786.2 mm x 309.7 mm (46.1 inch x 30.9 inch x 12.1 inch)	1392 mm x 915 mm x 367 mm (54.8 inch x 36 inch x 14.4 inch)
	Without stand	1171.4 mm x 724.4 mm x 55.3 mm (46.1 inches x 28.5 inch x 2.1 inch)	1392 mm x 852 mm x 55.3 mm (54.8 inch x 33.5 inch x 2.1 inch)
Weight	With stand	31 kg (68.3 lb)	49.5 kg (109.1 lb)
	Without stand	28.6 kg (63.0 lb)	45 kg (99.2 lb)
Power requirement Television System Program Coverage External Antenna Impedance		AC 100-240 V ~ 50 / 60 Hz NTSC-M, ATSC, 64 & 256 QAM VHF 2-13, UHF 14-69, CATV 1-135, DTV 2-69, CADTV 1-135 75 ohm	
Environment condition	Operating Temperature Operating Humidity	32 ~ 104°F (0 ~ 40 °C) Less than 80%	
	Storage Temperature Storage Humidity	-4 ~ 140°F (-20 ~ 60 °C) Less than 85%	

APPENDIX

MODEL		42PJ550 (42PJ550-UD)	50PJ550 (50PJ550-UD)
Dimensions (Width x Height x Depth)	With stand	988 mm x 692.7 mm x 260 mm (38.8 inch x 27.2 inch x 10.2 inch)	1171.4 mm x 786.2 mm x 309.7 mm (46.1 inch x 30.9 inch x 12.1 inch)
	Without stand	988 mm x 621.8 mm x 55.3 mm (38.8 inch x 24.4 inch x 2.1 inch)	1171.4 mm x 724.4 mm x 55.3 mm (46.1 pouces x 28.5 inch x 2.1 inch)
Weight	With stand	21.6 kg (47.6 lb)	30 kg (66.1 lb)
	Without stand	20 kg (44.0 lb)	27.6 kg (60.8 lb)
MODEL		60PK290 (60PK290-UA)	50PK340 (50PK340-UB)
Dimensions (Width x Height x Depth)	With stand	1392 mm x 910 mm x 367 mm (40.9 inch x 28.5 inch x 12.1 inch)	1171.4 mm x 781.8 mm x 309.7 mm (46.1 pouces x 30.7 inch x 12.1 inch)
	Without stand	1392 mm x 843 mm x 55.3 mm (40.9 inch x 26.3 inch x 3.0 inch)	1171.4 mm x 720.9 mm x 55.3 mm (46.1 pouces x 28.3 inch x 2.1 inch)
Weight	With stand	49.5 kg (109.1 lb)	31 kg (68.3 lb)
	Without stand	45 kg (99.2 lb)	28.6 kg (63.0 lb)
MODEL		42PJ250 (42PJ250-UA) (42PJ250-UB)	50PJ250 (50PJ250-UA)
Dimensions (Width x Height x Depth)	With stand	988 mm x 688.5 mm x 260 mm (38.8 inch x 27.1 inch x 10.2 inch)	1171.4 mm x 781.8 mm x 309.7 mm (46.1 inch x 30.7 inch x 12.1 inch)
	Without stand	988 mm x 617.8 mm x 55.3 mm (38.8 inch x 24.3 inch x 2.1 inch)	1171.4 mm x 720.9 mm x 55.3 mm (46.1 pouces x 28.3 inch x 2.1 inch)
Weight	With stand	21.6 kg (47.6 lb)	30 kg (66.1 lb)
	Without stand	20 kg (44.0 lb)	27.6 kg (60.8 lb)
Power requirement Television System Program Coverage External Antenna Impedance		AC 100-240 V ~ 50 / 60 Hz NTSC-M, ATSC, 64 & 256 QAM VHF 2-13, UHF 14-69, CATV 1-135, DTV 2-69, CADTV 1-135 75 ohm	
Environment condition	Operating Temperature Operating Humidity	32 ~ 104°F (0 ~ 40 °C) Less than 80%	
	Storage Temperature Storage Humidity	-4 ~ 140°F (-20 ~ 60 °C) Less than 85%	

MODEL		50PK350 (50PK350-UC)	60PK280 (60PK280-UA)
Dimensions (Width x Height x Depth)	With stand	1171.4 mm x 781.8 mm x 309.7 mm (46.1 inch x 30.7 inch x 12.1 inch)	1392 mm x 910 mm x 367 mm (40.9 inch x 28.5 inch x 12.1 inch)
	Without stand	1171.4 mm x 720.9 mm x 55.3 mm (46.1 inch x 28.3 inch x 2.1 inch)	1392 mm x 843 mm x 55.3 mm (40.9 inch x 26.3 inch x 3.0 inch)
Weight	With stand	31 kg (68.3 lb)	49.5 kg (109.1 lb)
	Without stand	28.6 kg (63.0 lb)	45 kg (99.2 lb)
MODEL		50PK250 (50PK250-UA) (50PK250-UB)	60PK250 (60PK250-UA) (60PK250-UB)
Dimensions (Width x Height x Depth)	With stand	1171.4 mm x 781.8 mm x 309.7 mm (46.1 pouces x 30.7 inch x 12.1 inch)	1392 mm x 910 mm x 367 mm (40.9 inch x 28.5 inch x 12.1 inch)
	Without stand	1171.4 mm x 720.9 mm x 55.3 mm (46.1 pouces x 28.3 inch x 2.1 inch)	1392 mm x 843 mm x 55.3 mm (40.9 inch x 26.3 inch x 3.0 inch)
Weight	With stand	31 kg (68.3 lb)	49.5 kg (109.1 lb)
	Without stand	28.6 kg (63.0 lb)	45 kg (99.2 lb)
Power requirement Television System Program Coverage External Antenna Impedance		AC 100-240 V ~ 50 / 60 Hz NTSC-M, ATSC, 64 & 256 QAM VHF 2-13, UHF 14-69, CATV 1-135, DTV 2-69, CADTV 1-135 75 ohm	
Environment condition	Operating Temperature Operating Humidity	32 ~ 104°F (0 ~ 40 °C) Less than 80%	
	Storage Temperature Storage Humidity	-4 ~ 140°F (-20 ~ 60 °C) Less than 85%	

- The specifications shown above may be changed without prior notice for quality improvement.

APPENDIX

IR CODES

(This feature is not available for all models.)

1. How to Connect

- Connect your wired remote control to the Remote Control port on the TV.

2. Remote Control IR Codes

■ Output waveform

Single pulse, modulated with 37.917KHz signal at 455KHz

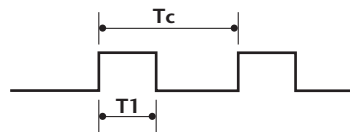

Carrier frequency
 $FCAR = 1/TC = fOSC/12$
 Duty ratio = $T1/TC = 1/3$

■ Configuration of frame

1st frame

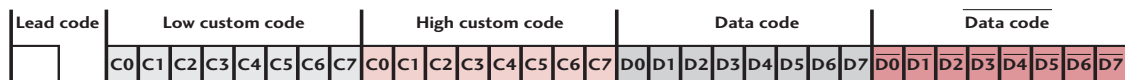

Repeat frame

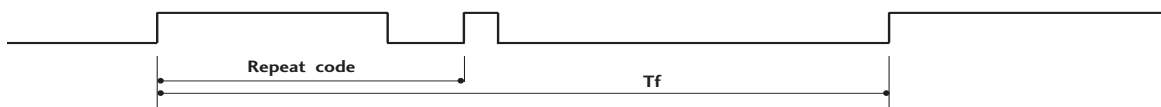

■ Lead code

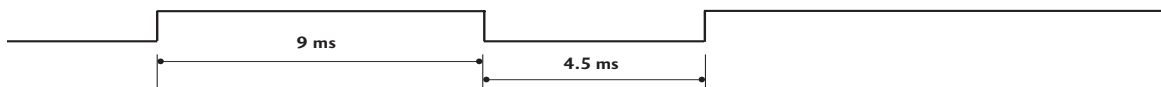

■ Repeat code

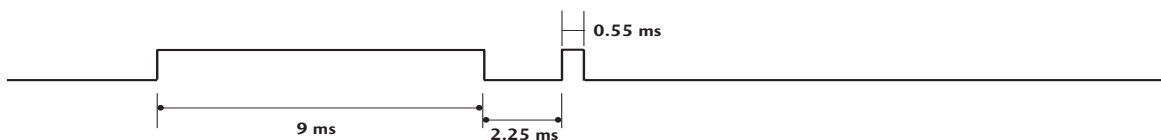

■ Bit description



■ Frame interval: Tf

The waveform is transmitted as long as a key is depressed.

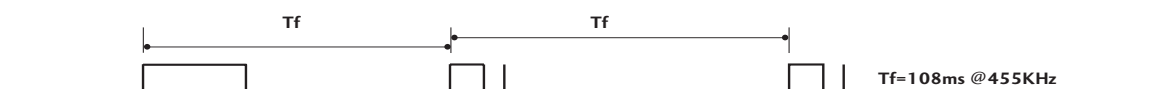

Code (Hexa)	Function	Note	Code (Hexa)	Function	Note
08	POWER	Remote control Button (Power On/Off)	D6	TV	Discrete IR Code (TV Input Selection)
45	Q.MENU	Remote control Button			
43	MENU	Remote control Button	C4	POWER ON	Discrete IR Code (Only Power On)
0B	INPUT	Remote control Button			
10-19	Number Key 0-9	Remote control Button	C5	POWER OFF	Discrete IR Code (Only Power Off)
4C	- Dash(List)	Remote control Button			
1A	FLASHBK	Remote control Button	5A	AV1	Discrete IR Code (AV1 Input Selection)
09	MUTE	Remote control Button			
02	VOL +	Remote control Button	D0	AV2	Discrete IR Code (AV2 Input Selection)
03	VOL -	Remote control Button			
00	CH ^	Remote control Button	BF	COMPONENT1	Discrete IR Code (Component1 Input Selection)
01	CH v	Remote control Button			
1E	FAV	Remote control Button	D4	COMPONENT2	Discrete IR Code (Component2 Input Selection)
40	^	Remote control Button			
41	v	Remote control Button	D5	RGB-PC	Discrete IR Code (RGB-PC Input Selection)
07	<	Remote control Button			
06	>	Remote control Button	CE	HDMI1	Discrete IR Code (HDMI1 Input Selection)
44	ENTER	Remote control Button			
28	BACK	Remote control Button	CC	HDMI2	Discrete IR Code (HDMI2 Input Selection)
7E	SIMPLINK	Remote control Button			
30	AV MODE	Remote control Button	E9	HDMI3	Discrete IR Code (HDMI3 Input Selection)
79	RATIO	Remote control Button			
BA	Pause (FREEZE)	Remote control Button	76	Ratio 4:3	Discrete IR Code (Only 4:3 Mode)
95	ENERGY	Remote control Button			
AA	Info	Remote control Button	77	Ratio 16:9	Discrete IR Code (Only 16:9 Mode)
72	Red	Remote control Button			
71	Green	Remote control Button	AF	Ratio Zoom	Discrete IR Code (Only Zoom1 Mode)
63	Yellow	Remote control Button			
61	Blue	Remote control Button			
8E	FF ►►	Remote control Button			
8F	Rew ◀◀	Remote control Button			
0F	TV	Remote control Button			
5B	EXIT	Remote control Button			
B1	Stop ■	Remote control Button			
B0	Play ►	Remote control Button			

EXTERNAL CONTROL THROUGH RS-232C

The RS-232C port allows you connect the RS-232C input jack to an external control device (such as a computer or an A/V control system) to control the TV's functions externally.

- **Note:** RS-232C on this unit is intended to be used with third party RS-232C control hardware and software. The instructions below are provided to help with programming software or to test functionality using telenet software.

RS-232C Setup

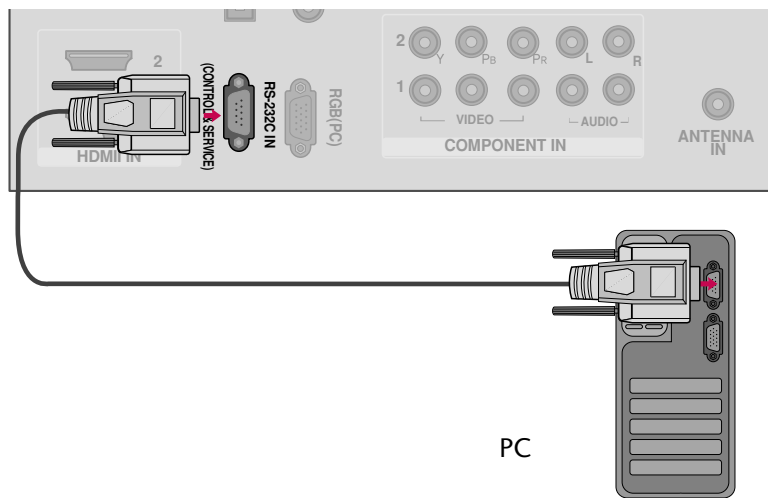

Type of Connector; D-Sub 9-Pin Male

No.	Pin Name
1	No connection
2	RXD (Receive data)
3	TXD (Transmit data)
4	DTR (DTE side ready)
5	GND
6	DSR (DCE side ready)
7	RTS (Ready to send)
8	CTS (Clear to send)
9	No Connection

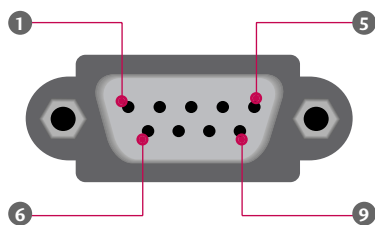

Communication Parameters

- Baud rate : 9600 bps (UART)
- Data length : 8 bits
- Parity : None
- Stop bit : 1 bit
- Communication code : ASCII code
- Use a crossed (reverse) cable.

RS-232C Configurations

Either cable below can be used.

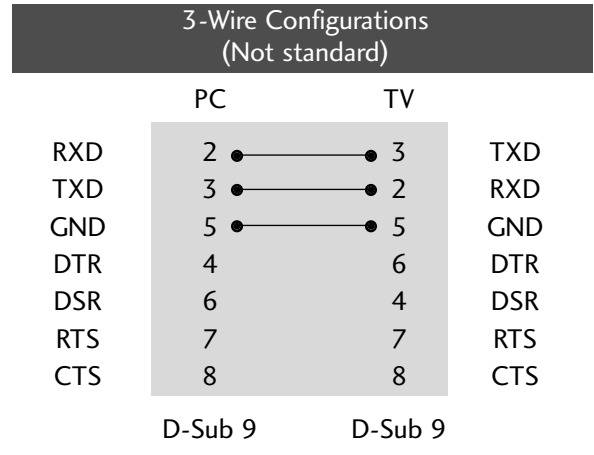
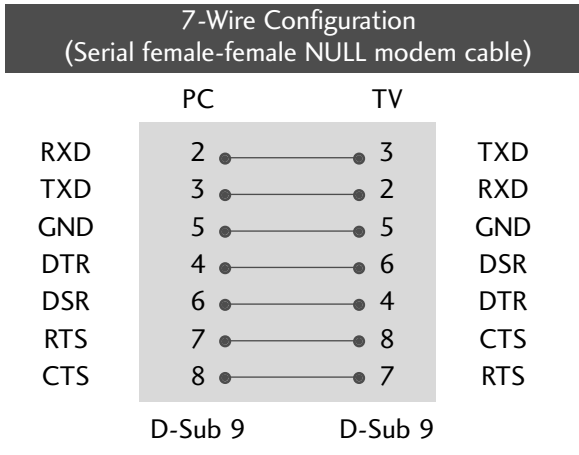

Set ID

Use this function to specify a TV ID number.
Refer to 'Real Data Mapping'.

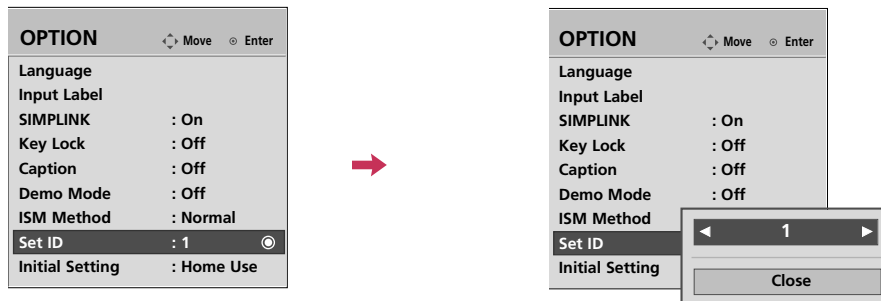

- 1 Select **OPTION**.
- 2 Select **Set ID**.
- 3 Choose the desired TV ID number.
The adjustment range of Set ID is 1 ~ 99.
- 4 Return to the previous menu.
- Return to TV viewing.

*Real data mapping

0 : Step 0
⋮
A : Step 10 (SET ID 10)
⋮
F : Step 15 (SET ID 15)
10 : Step 16 (SET ID 16)
⋮
63 : Step 99 (SET ID 99)
64 : Step 100

Command Reference List

	COMMAND1	COMMAND2	DATA (Hexadecimal)		COMMAND1	COMMAND2	DATA (Hexadecimal)
01. Power	k	a	00 ~ 01	13. Remote Control			
02. Input Select	x	b	(▶ p.117)	Lock Mode	k	m	00 ~ 01
03. Aspect Ratio	k	c	(▶ p.117)	14. Treble	k	r	00 ~ 64
04. Screen Mute	k	d	00 ~ 01	15. Bass	k	s	00 ~ 64
05. Volume Mute	k	e	00 ~ 01	16. Balance	k	t	00 ~ 64
06. Volume Control	k	f	00 ~ 64	17. Color Temperature	x	u	00 ~ 64
07. Contrast	k	g	00 ~ 64	18. ISM Method	j	p	(▶ p.118)
08. Brightness	k	h	00 ~ 64	19. Power Saving	j	q	00 ~ 01
09. Color	k	i	00 ~ 64	20. Auto Configuration	j	u	(▶ p.118)
10. Tint	k	j	00 ~ 64	22. Channel Add/Del	m	b	00 ~ 01
11. Sharpness	k	k	00 ~ 64	23. Key	m	c	(▶ p.119)
12. OSD Select	k	l	00 ~ 01				

	COMMAND1	COMMAND2	DATA00 (Hexadecimal)	DATA01 (Hexadecimal)	DATA02 (Hexadecimal)	DATA03 (Hexadecimal)	DATA04 (Hexadecimal)	DATA05 (Hexadecimal)
21. Channel Tuning	m	a	physical program high	major program low	major low	minor high	minor low	attribute

Transmission / Receiving Protocol

Transmission

[Command1][Command2][][Set ID][][Data][Cr]

[Command 1] : First command to control the set.(j, k, m or x)

[Command 2] : Second command to control the set.

[Set ID] : You can adjust the set ID to choose desired TV ID number in Setup menu. Adjustment range is 1 ~ 99. When selecting Set ID '0', every connected the TV is controlled. Set ID is indicated as decimal (1 ~ 99) on menu and as Hexa decimal (0x0 ~ 0x63) on transmission /receiving protocol.

[DATA] : To transmit the command data.

Transmit the 'FF' data to read status of command.

[Cr] : Carriage Return

ASCII code '0x0D'

[] : ASCII code 'space (0x20)'

* In this model, TV will not send the status during the standby mode.

OK Acknowledgement

[Command2][][Set ID][][OK][Data][x]

The TV transmits ACK (acknowledgement) based on this format when receiving normal data. At this time, if the data is data read mode, it indicates present status data. If the data is data write mode, it returns the data of the PC computer.

* In this model, TV will not send the status during the standby mode.

* Data Format

[Command 2] : Use as command.

[Set ID] : Use the small character, if set ID is 10, it will send the '0', 'a'.

[DATA] : Use the small character, if data is 0 x ab, it will send the 'a', 'b'.

[OK] : Use the large character.

Error Acknowledgement

[Command2][][Set ID][][NG][Data][x]

The TV transmits ACK (acknowledgement) based on this format when receiving abnormal data from non-viable functions or communication errors.

Data1: Illegal Code

Data2: Not supported function

Data3: Wait more time

* In this model, TV will not send the status during the standby mode.

* Data Format

[Command 2] : Use as command.

[Set ID] : Use the small character, if set ID is 10, it will send the '0', 'a'.

[DATA] : Use the small character, if data is 0 x ab, it will send the 'a', 'b'.

[NG] : Use the large character

01. Power (Command: k a)

To control Power On/Off of the TV.

Transmission [k][a][][Set ID][][Data][Cr]

Data 00: Power Off Data 01: Power On

Acknowledgement [a][][Set ID][][OK/NG][Data][x]

* In a like manner, if other functions transmit 'FF' data based on this format, Acknowledgement data feedback presents status about each function.

* Note: In this model, TV will send the Acknowledge after power on processing completion.

There might be a time delay between command and acknowledge.

02. Input Select (Command: x b)

To select input source for TV.

Transmission [x][b][][Set ID][][Data][Cr]

Data 00: DTV (Antenna) Data 01: DTV (Cable)

Data 10: Analog (Antenna) Data 11: Analog (Cable)

Data 20: AV1 Data 21: AV2

Data 40: Component 1 Data 41: Component 2

Data 60: RGB-PC Data 90: HDMI1

Data 91: HDMI2 Data 92: HDMI3

Acknowledgement [b][][Set ID][][OK/NG][Data][x]

03. Aspect Ratio (Command: k c)

To adjust the screen format.

Transmission [k][c][][Set ID][][Data][Cr]

Data 01: 4:3 09: Just scan

02: 16:9 10: Cinema Zoom (1)

04: Zoom

06: Set by program 1f: Cinema Zoom (16)

Acknowledgement [c][][Set ID][][OK/NG][Data][x]

04. Screen Mute (Command: k d)

To select screen mute on/off.

Transmission [k][d][][Set ID][][Data][Cr]

Data 00: Screen mute off (Picture on), Video-Out Mute Off

Data 01: Screen mute on (Picture off)

Data 10: Video-Out Mute On

Acknowledgement [d][][Set ID][][OK/NG][Data][x]

* In case of Video-Out mute on only, TV will display On Screen Display(OSD). But, In case of Screen Mute On, TV will not display OSD.

05. Volume Mute (Command: k e)

To control volume mute on/off.

You can also adjust mute using the MUTE button on remote control.

Transmission [k][e][][Set ID][][Data][Cr]

Data 00: Volume mute on (Volume off)

Data 01: Volume mute off (Volume on)

Acknowledgement [e][][Set ID][][OK/NG][Data][x]

06. Volume Control (Command: k f)

To adjust volume.

You can also adjust volume with the volume buttons on remote control.

Transmission [k][f][][Set ID][][Data][Cr]

Data Min: 00 ~ Max: 64 (*transmit by Hexadecimal code)

*Refer to 'Real data mapping' ► p.116.

Acknowledgement [f][][Set ID][][OK/NG][Data][x]

07. Contrast (Command: k g)

To adjust screen contrast.

You can also adjust contrast in the PICTURE menu.

Transmission [k][g][][Set ID][][Data][Cr]

Data Min: 00 ~ Max: 64 (*transmit by Hexadecimal code)

*Refer to 'Real data mapping' ► p.116.

Acknowledgement [g][][Set ID][][OK/NG][Data][x]

08. Brightness (Command: k h)

To adjust screen brightness.

You can also adjust brightness in the PICTURE menu.

Transmission [k][h][][Set ID][][Data][Cr]

Data Min: 00 ~ Max: 64 (*transmit by Hexadecimal code)

*Refer to 'Real data mapping' ► p.116.

Acknowledgement [h][][Set ID][][OK/NG][Data][x]

09. Color (Command: k i)

To adjust screen color.

You can also adjust color in the PICTURE menu.

Transmission [k][i][][Set ID][][Data][Cr]

Data Min: 00 ~ Max: 64 (*transmit by Hexadecimal code)

*Refer to 'Real data mapping' ► p.116.

Acknowledgement [i][][Set ID][][OK/NG][Data][x]

10. Tint (Command: k j)

To adjust screen tint.

You can also adjust tint in the PICTURE menu.

Transmission [k][j][][Set ID][][Data][Cr]

Data Red: 00 ~ Green: 64 (*transmit by Hexadecimal code)

*Refer to 'Real data mapping' ► p.116.

Acknowledgement [j][][Set ID][][OK/NG][Data][x]

11. Sharpness (Command: k k)

To adjust screen sharpness.

You can also adjust sharpness in the PICTURE menu.

Transmission [k][k][][Set ID][][Data][Cr]

Data Min: 00 ~ Max: 64 (*transmit by Hexadecimal code)

*Refer to 'Real data mapping' ► p.116.

Acknowledgement [k][][Set ID][][OK/NG][Data][x]

12. OSD Select (Command: k l)

To select OSD (On Screen Display) on/off.

Transmission [k][l][][Set ID][][Data][Cr]

Data 00: OSD off Data 01: OSD on

Acknowledgement [l][][Set ID][][OK/NG][Data][x]

13. Remote Control Lock Mode (Command: k m)

To lock the remote control and the front panel controls on the TV.

Transmission [k][m][][Set ID][][Data][Cr]

Data 00: Lock off Data 01: Lock on

Acknowledgement [m][][Set ID][][OK/NG][Data][x]

If you're not using the remote control and front panel controls on the TV, use this mode. When main power is on/off, remote control lock is released.

14. Treble (Command: k r)

To adjust treble.

You can also adjust treble in the AUDIO menu.

Transmission [k][r][][Set ID][][Data][Cr]

Data Min: 00 ~ Max: 64 (*transmit by Hexadecimal code)

*Refer to 'Real data mapping': ► p.116.

Acknowledgement [r][][Set ID][][OK/NG][Data][x]

15. Bass (Command: k s)

To adjust bass.

You can also adjust bass in the AUDIO menu.

Transmission [k][s][][Set ID][][Data][Cr]

Data Min: 00 ~ Max: 64 (*transmit by Hexadecimal code)

*Refer to 'Real data mapping': ► p.116.

Acknowledgement [s][][Set ID][][OK/NG][Data][x]

16. Balance (Command: k t)

To adjust balance.

You can also adjust balance in the AUDIO menu.

Transmission [k][t][][Set ID][][Data][Cr]

Data Min: 00 ~ Max: 64 (*transmit by Hexadecimal code)

*Refer to 'Real data mapping': ► p.116.

Acknowledgement [t][][Set ID][][OK/NG][Data][x]

17. Color Temperature (Command: x u)

To adjust color temperature.

You can also adjust color temperature in the PICTURE menu.

Transmission [x][u][][Set ID][][Data][Cr]

Data Min: 00 ~ Max: 64 (*transmit by Hexadecimal code)

*Refer to 'Real data mapping': ► p.116.

Acknowledgement [u][][Set ID][][OK/NG][Data][x]

18. ISM Method (Command: j p)

To avoid having a fixed image remain on screen.

Transmission [j][p][][Set ID][][Data][Cr]

Data 02: Orbiter 04: White Wash

08: Normal 20: Color Wash

Acknowledgement [p][][Set ID][][OK/NG][Data][x]

19. Energy saving (Command: j q)

To control the low energy function on/off.

Transmission [j][q][][Set ID][][Data][Cr]

Data 00: Energy Saving off

01: Energy Saving: Minimum

02: Energy Saving: Medium

03: Energy Saving: Maximum

05: Screen Off

10: Intelligent Sensor

Acknowledgement [q][][Set ID][][OK/NG][Data][x]

20. Auto Configuration (Command: j u)

To adjust picture position and minimize image shaking automatically. Auto configuration only works in RGB-PC mode.

Transmission [j][u][][Set ID][][Data][Cr]

Data 1: To set

Acknowledgement [u][][Set ID][][OK/NG][Data][x]

21. Channel Tuning (Command: m a)

To tune channel to following physical/major/minor number.

Transmission [m][a][][Set ID][][Data00][][Data01]

[][Data02][][Data03][][Data04][][Data05][Cr]

Digital channels have a Physical, Major, and Minor channel number. The Physical number is the actual digital channel number, the Major is the number that the channel should be mapped to, and the Minor is the sub-channel. Since the ATSC tuner automatically maps the channel to the Major number, the Physical number is not required when sending a command.

Data 00: Physical Channel Number

NTSC air: 02~45, NTSC cable: 01, 0E~7D

ATSC air: 01~45, ATSC cable: 01~87

Data 01 & 02: Major Channel Number

Data 01: High byte

Data 02: Low byte

Two bytes are available for the Major and Minor, normally only the second byte is used.

Data 03 & 04: Minor Channel Number

Not needed for NTSC.

Data 05:

7	Main/Sub Picture	6	Two/One Part Channel	5	Using Physical Channel	4	Reserved	3	2	1	0	Step
0	Main	0	Two	0	Use	x		0	0	0	0	NTSC Air
1	Sub	1	One	1	No Use	x		0	0	0	1	NTSC Cable
						x		0	0	1	0	ATSC Air
						x		0	0	1	1	ATSC Cable_std
						x		0	1	0	0	ATSC Cable_hrc
						x		0	1	0	1	ATSC Cable_irc
						x		0	1	1	0	ATSC cable_auto
						x		0	1	1	1	Reserved
						x		x	x	x	x	...
						x		1	1	1	1	Reserved

The table above lists the binary code which must be converted to Hexadecimal before sending. For example: The binary code to tune the sub source to an NTSC cable channel is "1000 0001", which translates to "81" in Hex.

- * 7th bit : For which source do you want to change the channel.
- * 6th bit: Use a two part or one part channel. Most cases just use 0 since it's ignored when using NTSC.
- * 5th bit: Use 0 with NTSC since it can only use the physical channel number. Normally use 1 for ATSC since most times it doesn't matter what the physical number is.
- * 4th bit: Set to 0.
- * 3-0 bits: Choose signal type.

* Tune Command Examples:

1. Tune to the analog (NTSC) cable channel 35.

Data 00 = Physical of 35 = 23
 Data 01 & 02 = No Major = 00 00
 Data 03 & 04 = No Minor = 00 00
 Data 05 = 0000 0001 in binary = 01
 Total = ma 00 23 00 00 00 00 01

2. Tune to the digital (ATSC) local channel 30-3.

Data 00 = Don't know Physical = 00
 Data 01 & 02 = Major is 30 = 00 1E
 Data 03 & 04 = Minor is 3 = 00 03
 Data 05 = 0010 0010 in binary = 22
 Total = ma 00 00 00 1E 00 03 22

Acknowledgement [a] [] [Set ID] [] [OK] [Data00] [Data01] [Data02] [Data03] [Data04] [x] [a] [] [Set ID] [] [NG] [Data00] [x]

22. Channel Add/Del (Command: m b)

To add and delete the channels.

Transmission [m][b][] [Set ID] [] [Data][Cr]

Data 00: Channel Delete Data 01: Channel Add

Acknowledgement [b] [] [Set ID] [] [OK/NG] [Data] [x]

23. Key (Command: m c)

To send IR remote key code.

Transmission [m][c][] [Set ID] [] [Data][Cr]

► p.113.

Acknowledgement [c] [] [Set ID] [] [OK/NG] [Data] [x]



The model and serial number of the TV is located on the back and one side of the TV. Record it below should you ever need service.

MODEL _____

SERIAL _____



LG

Life's Good

GUIDE DE L'UTILISATEUR TÉLÉ PLASMA

Veuillez lire ce manuel attentivement avant d'utiliser votre appareil et conservez-le pour consultation ultérieure.

42PJ250
50PJ250
50PK250
60PK250
60PK280
60PK290

42PJ340
50PJ340
42PJ350
50PJ350

50PK350
50PK340
50PK540
60PK540

42PJ550
50PJ550
50PK550
60PK550

42PJ350C
50PJ350C
50PK550C
60PK550C

AVERTISSEMENT/ATTENTION



AVERTISSEMENT

RISQUE D'ELECTROCUTION
NE PAS OUVRIR



POUR RÉDUIRE LE RISQUE DE CHOC ÉLECTRIQUE, NE PAS ENLEVER LE COUVERCLE (OUDOS). AUCUNE PIÈCE NE PEUT ÊTRE RÉPARÉE PAR L'UTILISATEUR. RÉFÉRER TOUT SER-VICE À UN TECHNICIEN QUALIFIÉ.



L'éclair avec flèche dans un triangle équilatéral est destiné à aviser l'utilisateur de la présence de tension dangereuse non isolée dans le boîtier de l'appareil pouvant être suffisamment forte pour causer un risque de choc électrique.



Le point d'exclamation dans un triangle équilatéral est destiné à aviser l'utilisateur de la présence d'instructions de fonctionnement et d'entretien.

AVERTISSEMENT/ATTENTION

POUR ÉVITER TOUT RISQUE DE CHOC ÉLECTRIQUE OU D'INCENDIE, NE PAS EXPOSER CE PRO-DUIT À LA PLUIE OU À L'HUMIDITÉ.

NOTE À L'INSTALLATEUR DE LA CÂBLODISTRIBUTION

Ceci est un rappel à l'installateur de la câblodistribution de tenir compte de l'article 820-40 du National Electric Code (É.-U.). On y trouve les lignes directrices portant sur une mise à la terre conforme. On y stipule, entre autres, que le conducteur de terre du câble doit être raccordé au système de mise à la terre de l'immeuble, aussi près que possible du point d'entrée du câble.

AVERTISSEMENT/ATTENTION

AFIN D'ÉVITER TOUT RISQUE DE CHOC ÉLECTRIQUE OU INCENDIAIRE, NE PAS EXPOSER CE PRODUIT À LA PLUIE OU L'HUMIDITÉ.

AVIS DE LA FCC

Appareil numérique de classe B

Cet appareil a été testé et est conforme aux exigences pour appareil numérique de classe B, partie 15 des règlements de la FCC. Ces limites sont conçues pour assurer une protection raisonnable contre les interférences nocives dans une installation résidentielle. Cet équipement génère, utilise et peut radier de l'énergie de radiofréquence et s'il n'est pas installé et utilisé conformément aux instructions, peut causer des interférences nuisibles aux communications radio. Toutefois, il n'y a aucune garantie que des interférences ne surviendront pas. Si cet appareil cause des interférences à la réception radio et télé, ce qui peut être déterminé en mettant l'appareil hors circuit, puis en circuit, l'utilisateur peut essayer de corriger cette interférence d'une des façons suivantes:

- Réorienter l'antenne réceptrice.
- Éloigner l'appareil du récepteur.
- Brancher l'appareil sur un circuit différent de celui du récepteur.
- Consulter le marchand ou un technicien qualifié en radio et téléviseur.

Ce dispositif est conforme à la partie 15 des réglementations de la FCC.

L'opération est assujettie aux deux conditions suivantes: (1) Ce dispositif ne doit pas causer d'interférences (nocives) et (2) ce dispositif doit accepter toute interférence reçue risquant causer une opération indésirable de l'appareil.

Tout changement ou modification non expressément approuvé par la partie responsable concernant la conformité peut annuler la possibilité de l'utilisateur à utiliser cet appareil.

ATTENTION

Ne pas tenter de modifier cet appareil de quelle que façon que ce soit sans une autorisation écrite de LG Electronics.

Toute modification non autorisée peut annuler la possibilité de l'utilisateur à utiliser cet appareil.

CONSIGNES DE SÉCURITÉ

INSTRUCTIONS DE SÉCURITÉ IMPORTANTES

Lire ces instructions.

Conserver ces instructions.

Observer les avertissements.

Observer les instructions.



- 1 Ne pas utiliser cet appareil près de l'eau.

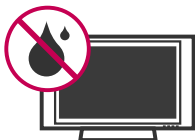

- 2 Nettoyer seulement avec un chiffon sec.



- 3 Ne pas obstruer les ouvertures de ventilation. Installer conformément aux instructions du fabricant.

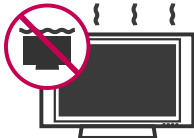

- 4 Ne pas installer à proximité de sources de chaleur comme radiateurs, registres de chauffage, cuisinières ou tout autre appareil (incluant amplificateurs) produisant de la chaleur.



- 5 Ne pas outrepasser le dispositif de sécurité de la fiche polarisée ou mise à la terre. Une fiche polarisée est dotée de deux lames dont une plus large que l'autre. Une fiche mise à la terre est dotée de deux lames et d'une broche mise à la terre. La lame large ou la broche sont destinées à la sécurité. Si la fiche ne peut être branchée sur la prise, demander à un électricien qualifié de remplacer la prise usitée.



- 6 Protéger le cordon d'alimentation afin qu'il ne soit pas écrasé ni pincé, surtout à la prise et au point où il sort de l'appareil.



- 7 Utiliser seulement les accessoires spécifiés par le fabricant.



- 8 Utiliser seulement avec chariot, support, fixation ou table spécifiés par le fabricant ou vendus avec l'appareil. Au moment d'utiliser avec un chariot, faire attention pour le déplacer afin qu'il ne bascule pas avec l'appareil.



- 9 Débranchez cet appareil pendant les orages ou durant les longues périodes d'inutilisation.

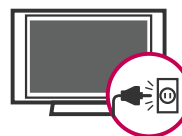

- 10 Référez tout service à un technicien qualifié. Un service est requis lorsque l'appareil a été endommagé comme le cordon d'alimentation ou la fiche, du liquide a été renversé ou des objets sont tombés dans l'appareil, s'il a été exposé à la pluie ou à l'humidité, s'il ne fonctionne pas normalement ou a été échappé.

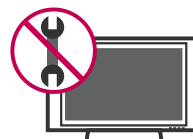

INSTRUCTIONS DE SÉCURITÉ

11 Ne jamais toucher cet appareil ou l'antenne lors d'un orage ou d'une tempête.

12 Si vous fixez votre téléviseur au mur, veillez à ne pas le suspendre par le cordon d'alimentation et le câble situés à l'arrière du moniteur.

13 Faites attention à ce qu'aucun objet ne choque sur l'appareil, et ne laissez pas tomber d'éléments solides sur l'écran.

14 ATTENTION concernant le cordon d'alimentation: Il est recommandé que la plupart des appareils soient branchés sur un circuit dédié qui est une prise simple qui alimente seulement cet appareil et qu'il n'y a pas d'autres prises additionnelles ou circuits terminaux. Vérifier les données techniques dans le guide du propriétaire.

Ne pas brancher un trop grand nombre d'appareils à la même prise c.a. puisque cela pourrait causer un incendie ou un choc électrique.

Ne pas surcharger les prises murales. Une surcharge, des prises endommagées ou lâches, des rallonges, des cordons effrités ou dont l'isolation est endommagée, peuvent être dangereux. Si ces conditions existent, il peut en résulter un risque de choc électrique ou d'incendie. Vérifier périodiquement le cordon de l'appareil et s'il semble endommagé et détérioré, le débrancher et ne pas utiliser l'appareil tant que le cordon n'est pas remplacé par un modèle de rechange semblable par un technicien qualifié.

Protéger le cordon de tout abus physique ou mécanique. Il ne doit pas être tordu, pincé, situé près de la porte et il ne faut pas marcher dessus. Porter une attention particulière aux fiches, prises murales et au point de sortie de l'appareil.

Ne pas déplacer le téléviseur lorsque le cordon d'alimentation est branché. Ne pas utiliser le téléviseur si le cordon est endommagé ou desserré. Assurez-vous de tirer sur la prise du cordon lorsque vous voulez le débrancher; ne tirez pas sur le cordon pour débrancher le téléviseur.



15 AVERTISSEMENT - Pour réduire le risque d'incendie ou de choc électrique, n'exposez pas ce produit à la pluie, à l'humidité ou à d'autres liquides. Ne touchez pas le téléviseur si vous avez les mains mouillées. Ne pas installer ce produit près de produits inflammables comme de l'essence ou des chandelles ou exposer le téléviseur à une source directe de climatisation.



16 Ne pas exposer le téléviseur à des gouttes ou à des éclaboussures d'eau et ne pas déposer d'objets remplis de liquide comme des vases, des tasses, etc. sur le téléviseur ou les placer au-dessus de celui-ci (par exemple sur une étagère, au-dessus de l'appareil).



17 MISE À LA TERRE

S'assurer de brancher la mise à la terre pour empêcher les chocs électriques possible (par ex., un téléviseur avec une prise à trois fils c.a. mis à la masse doit être branché à une prise c.a. trois fils, mise à la masse). Si les méthodes de mise à la terre ne sont pas possibles, demander à un électricien d'installer un coupe-circuit séparé.

Ne pas mettre l'appareil à la terre sur les fils de téléphone, paratonnerre ou tuyau à gaz.

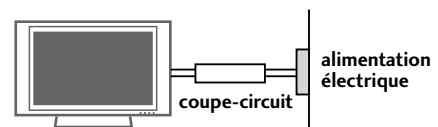

18 RETIRER DU RÉSEAU ÉLECTRIQUE

Vous devez débrancher l'appareil de la prise principale. La prise doit demeurer disponible et fonctionnelle.

19 Tant que cette unité est reliée à la prise murale, elle est toujours alimentée en courant alternatif même si vous éteignez le bouton d'alimentation.

20 ANTENNE

Mise à la terre de l'antenne extérieure

Si une antenne extérieure a été installée, veuillez suivre les directives indiquées ci-dessous. Un système avec antenne extérieure ne devrait pas se trouver près de lignes aériennes d'électricité ou de tout autre circuit de transport d'électricité ou d'alimentation électrique ni près de tout endroit où il peut entrer en contact avec de telles lignes de transport ou circuits électriques puisque cela pourrait entraîner le décès de la personne qui y touche ou que celle-ci pourrait subir des blessures graves.

Assurez-vous que le système d'antenne soit mis à la masse pour ainsi offrir une certaine protection contre la tension et l'accumulation de statique.

L'article 810 du National Electrical Code (NEC) des États-Unis donne de l'information à l'égard de la mise à la masse appropriée du mât et de la structure de soutien, de la mise à la masse du fil de connexion à une unité de décharge de l'antenne, de la taille des conducteurs de mise à la masse, de l'emplacement de l'unité de décharge de l'antenne, de la connexion à des électrodes de mise à la masse et des exigences que doit respecter l'électrode de mise à la masse.

La mise à la masse de l'antenne devrait être conforme au National Electrical Code, ANSI/NFPA 70 des États-Unis.

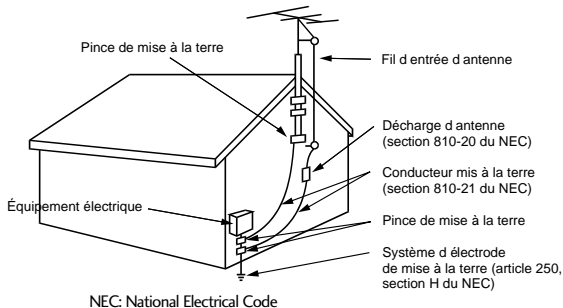

21 Nettoyage

Lorsque vous nettoyez le téléviseur, assurez-vous de l'avoir d'abord débranché. Utilisez un chiffon doux pour éviter d'égratigner le téléviseur. Ne pas vaporiser d'eau ou d'autres liquides directement sur le téléviseur puisque cela pourrait causer un choc électrique. Ne pas nettoyer le téléviseur avec des produits chimiques comme de l'alcool, du diluant ou du benzène.

22 Déplacement

Assurez-vous que le téléviseur a été éteint, qu'il a été débranché et que tous les câbles et cordons ont été retirés. Deux personnes ou plus pourront être requises pour transporter les plus gros téléviseurs. Ne pas vous appuyer contre le panneau avant du téléviseur ou causer de la tension sur ce panneau.

23 Ventilation

Installez votre téléviseur dans un endroit offrant une ventilation appropriée. Ne pas l'installer dans un endroit confiné comme une bibliothèque. Ne pas recouvrir l'appareil de tissu ou d'autres matériaux comme du plastique, lorsqu'il est branché. Ne pas l'installer dans un endroit excessivement poussiéreux.

24 Veuillez prendre soin de ne pas toucher les ouvertures de ventilation. Lors de longues périodes de visionnement, les ouvertures de ventilation risquent devenir chaudes.

25 Si vous sentez une odeur de fumée ou que d'autres odeurs se dégagent du téléviseur ou qu'il produit des sons étranges, débranchez le cordon d'alimentation et communiquez avec un centre de service autorisé.

26 N'appuyez pas avec force sur le panneau avec une main ou un objet pointu comme un clou, un crayon ou un stylo et évitez les égratignures. Do not allow a impact shock onto the panel.

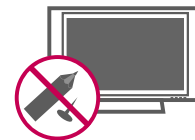

27 Garder l'appareil éloigné de la lumière directe du soleil.

TABLE DES MATIÈRES

AVERTISSEMENT/ATTENTION	2
CONSIGNES DE SÉCURITÉ	3
CARACTÉRISTIQUES DU TÉLÉVISEUR	8

PRÉPARATION

Accessoires	9
Information relative au panneau avant	10
Information relative au panneau arrière	13
Instructions du support	15
Pince du Compartiment à fils	17
Installation sur un Bureau	18
Stand de pivot	18
Système de fixation vesa (Association des standards vidéo)	19
Installer le téléviseur au mur de façon sécuritaire pour l'empêcher de tomber lorsqu'il est installé sur un pied	20
Connexion antenne ou câble	21

CONFIGURATION DE LA SOURCE AUXILIAIRE

Installation de Récepteur HD	22
Réglage DVD	25
Réglage magnétoscope	27
Réglage source A/V externe	28
Connexion USB	28
Audio Out Connection	29
Réglage PC	30

VISIONNEMENT DE LA TÉLÉVISION / COMMANDE DES CHAÎNES

Fonctions de la télécommande	36
Mise en circuit du téléviseur	38
Sélection de chaîne	38
Réglage du volume	38
Réglage initial	39
Sélection des menus affichés à l'écran	40
Menu éclair (Quick Menu)	42

Repérage de canaux	
- Recherche automatique des chaînes (Syntonisation automatique)	43
- Ajout/Effacement des chaînes (Syntonisation manuelle)	44
- Édition des chaînes	45
Liste des Canaux	46
Mémoire des Canaux préférés	47
Liste des Favoris	47
Brève Info.	48
Liste d'entrées	49
Identité source	50
Mode AV	51
SIMPLINK	52

USB

Modes d'entrée	54
Liste Photo	55
Liste Musique	61

COMMANDE DE L'IMAGE

Commande de la taille de l'image (Allongement)	64
Assistant Image	66
Économie d'énergie	68
Configuration pré réglée des Images (Mode image) ..	69
Réglage Manuel de l'image - Mode personnel	70
Technologie D'amélioration de l'image	71
Commande Experte d'image	72
Réinitialisation de l'image	74
Mode Démo	74
Méthode ISM (minimisation d'incrustation d'image) ..	75

COMMANDE DU SON ET DE LA LANGUE

Contrôle Automatique du Volume (Réglage vol.auto.)	76
Voix claires II	77
Configuration préréglée du son (Mode audio) ..	78
Réglages du son - Mode personnel	79
Équilibre	81
Réglage marche-arrêt des haut-parleurs du téléviseur	82
Réinitialisation du mode audio	83
Réglage diffusions stéréo/SAP	84
Langage audio	85
Sélection de langue pour les menus à l'écran	86
Sous-titres	
- Sous-titres à système de diffusion analogique ..	87
- Sous-titres à système de diffusion numérique ..	88
- Option sous-titres	89

RÉGLAGE DE L'HEURE

Réglage de la pendule	
- Réglage automatique	90
- Réglage manuel	91
Réglage minuterie en marche/arrêt	92
Réglage minuterie	93

COMMANDE PARENTALE / CLASSEMENT

Système de Réglage de mot de passe et Verrouillage	94
Blocage des chaînes	97
Classement des films et des émissions télévisées ..	98

Téléchargeable	103
Blocage de l'entrée externe	104
Touches verrouillées	105

ANNEXE

Liste de vérification de dépannage	106
Entretien	108
Spécifications de l'appareil	109
Réglage de la télécommande	112
Commande externe par le biais du RS-232C	114

CARACTÉRISTIQUES DU TÉLÉVISEUR

- Cette fonction n'est pas disponible pour tous les modèles.



Télévision Haute Définition. Système de diffusion et de lecture d'émissions de télévision numérique à grande résolution, comprenant environ 1 millions de pixels, le format d'écran 16/9 et l'audio numérique AC3. Avec une télévision non numérique, les formats HDTV comprennent les résolutions 1080i et 720p.



Fabriqué sous la licence de Dolby Laboratories. 'Dolby' et le symbole du double D sont des marques déposées de Dolby Laboratories.



Ce téléviseur offre les réglages précis exigés pour la certification professionnelle par l'Imaging Science Foundation. Les modes « nuit » et « jour » d'ISF en résultant, sont donc accessibles et permettent aux utilisateurs de profiter pleinement de leur télévision haute définition LG.

Des calibrations sophistiquées et détaillées peuvent être réalisées avec le mode ISFccc.

Un technicien qualifié est requis pour effectuer une calibration détaillée.

Veuillez vous adresser à votre détaillant local pour trouver un technicien qualifié ISF.



HDMI™, le logo HDMI et High-Definition Multimedia Interface sont des marques déposées de HDMI Licensing.



Le mode AV optimise l'image pour le film, les sports et le mode jeu en fonction du contenu visuel et audio. Le spectateur peut sélectionner rapidement le mode approprié à l'image qu'il regarde.



À l'encontre d'autres capteurs qui ne peuvent détecter que la luminosité ambiante, Sensor Intelligent de LG utilise 4 096 incréments de détection pour évaluer son environnement. Utilisant un algorithme sophistiqué, LG traite les ingrédients inhérents à la qualité d'image, c.-à-d. Luminosité, contraste, couleur et équilibre du blanc. Le résultat est une image optimisée pour son environnement, plus agréable à regarder et vous faisant économiser 50% de la consommation.



Augmente automatiquement et amplifie le son de la gamme de fréquence humaine de voix pour maintenir une audition optimale du dialogue quand le bruit de fond augmente.



Visionnez fichiers vidéo, photo et écouter de la musique à même votre téléviseur par le biais de la prise USB 2,0 (lecture vidéo dépendant des modèles)



Affiche toute émission haute définition dans une résolution HD intégrale 1080p pour une vue beaucoup plus détaillée.



INFORMATION IMPORTANTE POUR ÉVITER LE PHÉNOMÈNE DE « INCRUSTATION D'IMAGE » SUR VOTRE ÉCRAN DE TÉLÉVISEUR.

- Quand une image fixe (par exemple logos, menus d'écran, affichage de jeu vidéo, et d'ordinateur) est affichée pendant une période prolongée sur le téléviseur, elle peut rester imprimée de manière permanente sur l'écran. Ce phénomène est connu sous le nom de « brûlure d'image » ou « brûlure ». La brûlure d'image n'est pas couverte par la garantie du fabricant.
- Afin d'empêcher la brûlure d'image, éviter d'afficher une image fixe sur votre écran de télévision pendant une période prolongée (2 heures ou plus pour l'affichage à cristaux liquides, 1 heure ou plus pour le plasma).
- La brûlure d'image peut également se produire si vous utilisez le format 4:3 pendant une période prolongée.

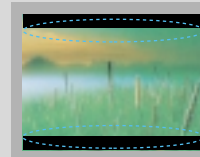
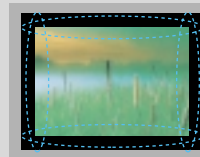
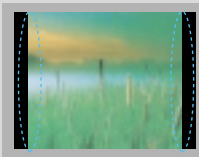

PRÉPARATION

ACCESSORIES

S'assurer que les accessoires suivants sont compris avec l'appareil. S'il manque des accessoires, communiquer avec le marchand où l'appareil a été acheté.

Il se peut que les accessoires inclus ne correspondent pas aux illustrations ci-dessous.

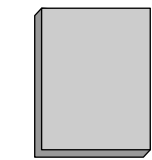

Manuel de l'Utilisateur

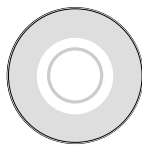

Manuel sur CD

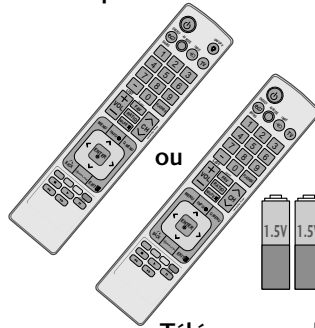

ou

Télécommande, Piles



Cordon d'alimentation

(Sauf 60PK250, 60PK540, 60PK550, 60PK280, 60PK290, 60PK550C)

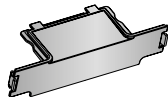

Couvercle de protection (Voir page .12)

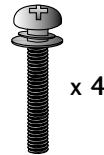

x 4

M4x28

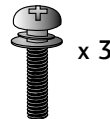

x 3

M5x14

Écrous pour l'assemblage de la base (Voir page. 15)



x 2

Serre-fils



Chiffon à lustrer (Non inclus avec tous les modèles)

* N'essuyez les taches apparaissant sur la surface extérieure qu'à l'aide d'un chiffon à lustrer.

* N'essuyez pas énergiquement la surface pour enlever la saleté. Autrement, cela risquerait de rayer ou de décolorer la surface de l'appareil.

En option

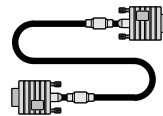

D-sub câble 15 broches

Lors de l'utilisation d'une connexion PC VGA (câble D-sub à 15 broches), l'utilisateur doit utiliser des câbles de passage de signaux blindés à noyaux de ferrite pour conserver la conformité du produit aux normes de la standard.



Tore de ferrite (Gris)

(Cette fonction n'est pas disponible pour tous les modèles.)

Le noyau de ferrite peut être utilisé pour réduire les ondes électromagnétiques dans le câble audio du PC. Enroulez le câble audio du PC 2 fois autour du noyau de ferrite, puis branchez les câbles au téléviseur comme indiqué dans l'illustration suivante.

Placez le noyau de ferrite à proximité de la fiche jack AUDIO IN (RGB/DVI) (ENTREE AUDIO) sur l'écran.

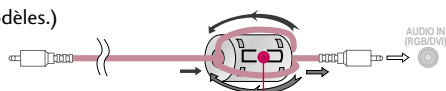

Placez le noyau de ferrite à proximité de la fiche jack AUDIO IN (RGB/DVI) (ENTREE AUDIO) sur l'écran.



Tore de ferrite (Noir)

(Cette fonction n'est pas disponible pour tous les modèles.)

Le tore de ferrite peut être utilisé pour réduire l'onde électromagnétique lors du raccordement au cordon d'alimentation.

Plus le tore de ferrite sera près de la fiche d'alimentation électrique, mieux ce sera.

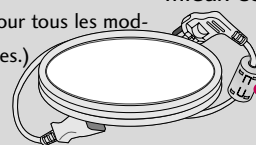

Installez la fiche d'alimentation très près.

PRÉPARATION

INFORMATION RELATIVE AU PANNEAU AVANT

■ Cette illustration peut ne pas correspondre à votre téléviseur.

PRÉPARATION

50/60PK550, 50/60PK540, 42/50PJ550, 50/60PK550C

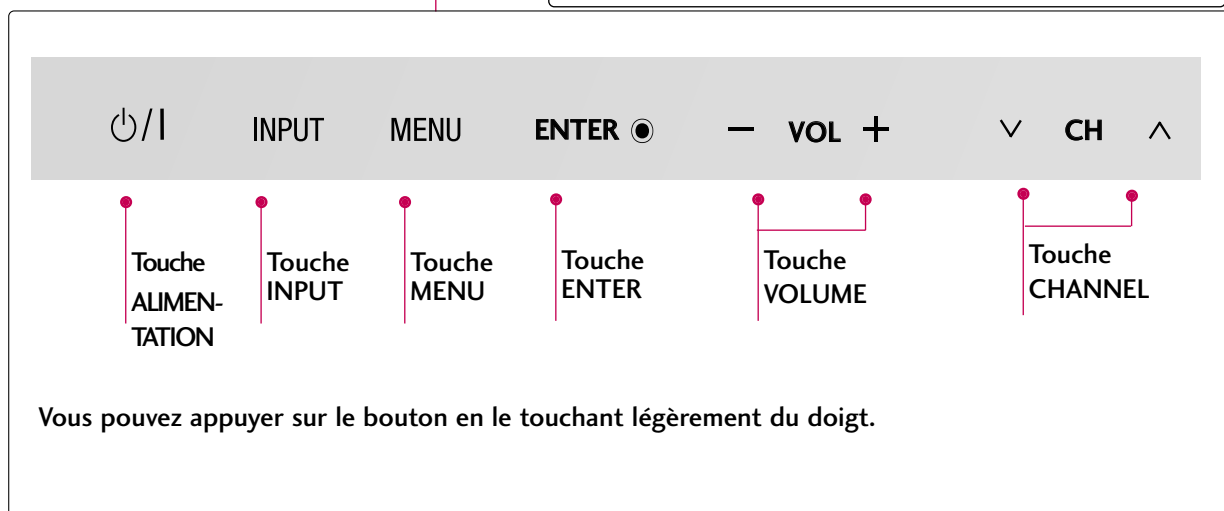
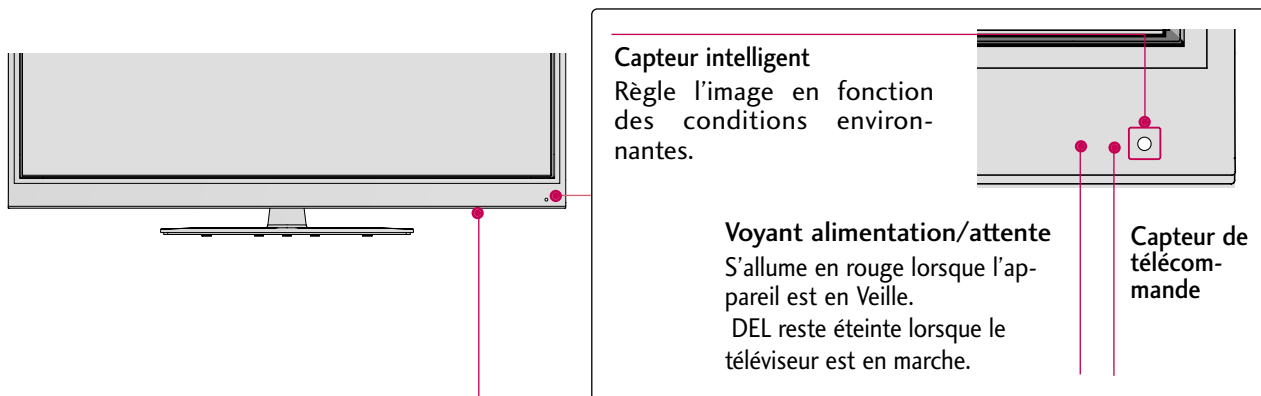

50/60PK250, 42/50PJ250, 60PK280, 60PK290

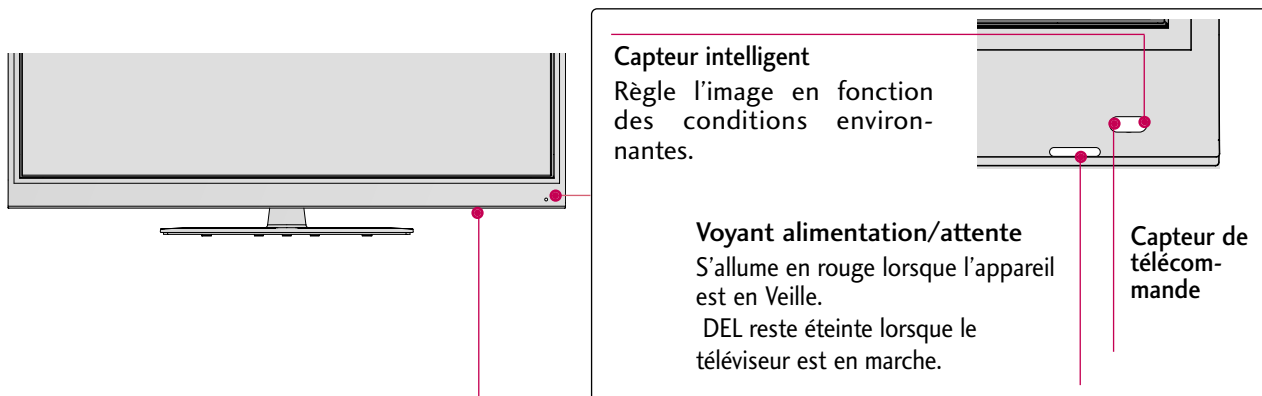

PRÉPARATION

PRÉPARATION

42/50PJ350, 42/50PJ340, 50PK340, 50PK350, 42/50PJ350C

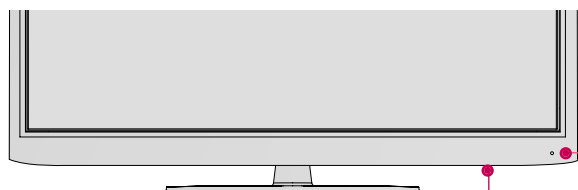

Capteur intelligent
Règle l'image en fonction des conditions environnantes.

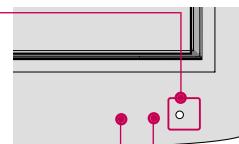

Voyant alimentation/attente
S'allume en rouge lorsque l'appareil est en Veille.
DEL reste éteinte lorsque le téléviseur est en marche.

Capteur de télécommande



Touche ALIMENTATION

Touche INPUT

Touche MENU

Touche ENTER

Touche VOLUME

Touche CHANNEL

Vous pouvez appuyer sur le bouton en le touchant légèrement du doigt.

- ▶ Ne marchez pas sur le support en verre et ne le soumettez à aucun impact. Il pourrait se casser, et les morceaux de verre peuvent occasionner des blessures, ou le téléviseur pourrait tomber.
- ▶ Ne traînez pas le téléviseur. Vous pourriez endommager le sol ou le produit.

INFORMATION RELATIVE AU PANNEAU ARRIÈRE

▪ Cette illustration peut ne pas correspondre à votre téléviseur.

**42/50PJ250, 50/60PK250, 60PK280, 42/50PJ340,
50/60PK540, 50PK340**

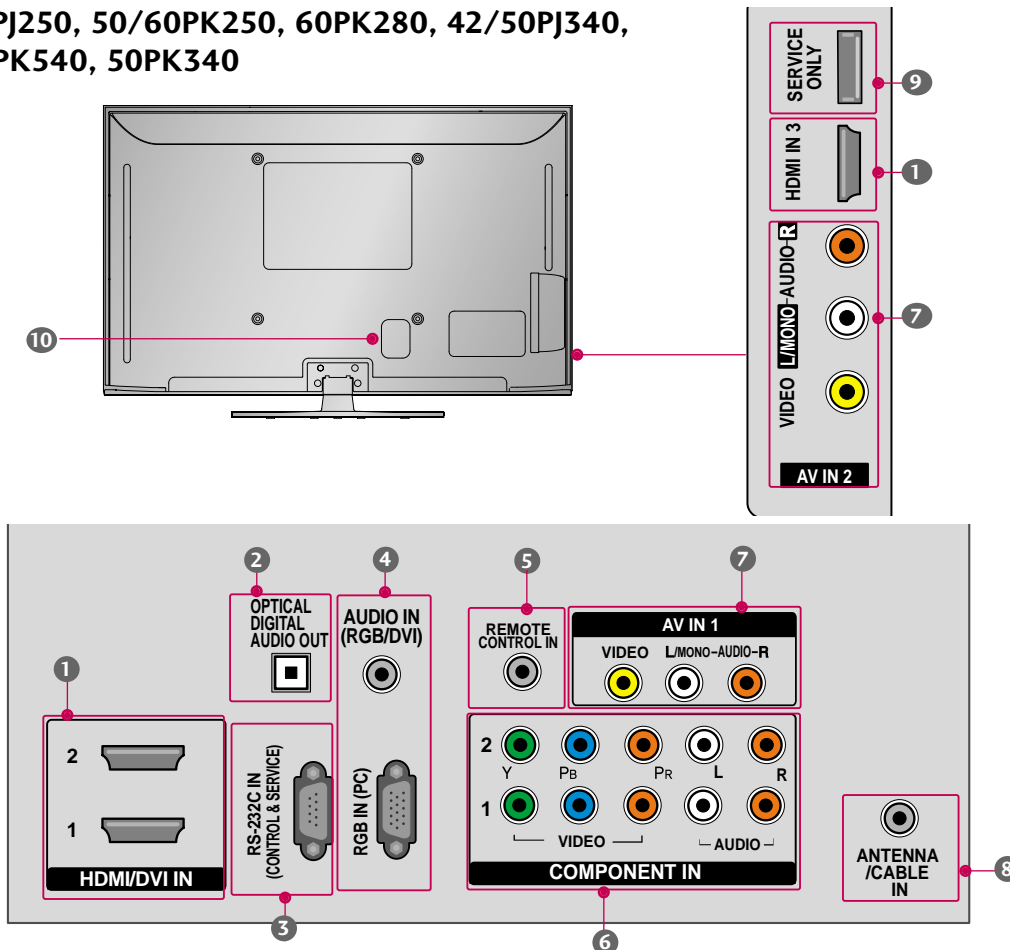

- 1 HDMI/DVI IN**
Connexion numérique.
Prend en charge les signaux vidéo et audio-umériques de haute définition. Ne prend pas en charge le mode 480i.
Prend en charge le signal DVI à l'aide d'un adaptateur ou d'un câble HDMI vers DVI (non inclus)
- 2 OPTICAL DIGITAL AUDIO OUT**
Prise de sortie audionumérique pour l'amplificateur ou système cinéma maison.
Remarque: en mode attente, ces prises sont désactivées.
- 3 RS-232C IN (CONTROL & SERVICE) PORT**
Utilisé sur appareils offerts par des tiers.
- 4 AUDIO IN (RGB)**
Prise pour écouteurs de 1/8" pour l'entrée du signal audio analogique du PC.
RGB IN (PC)
Connexion analogique pour PC. Nécessite un câble D-sub à 15 broches (câble VGA).
- 5 REMOTE CONTROL IN PORT**
Prise pour télécommande à fil.
- 6 COMPONENT IN**
Connexion analogique. Prend en charge les signaux haute définition.
Nécessite un câble rouge, un câble vert et un câble bleu pour le signal vidéo, et un câble rouge et un câble blanc pour le signal audio.
- 7 AV (Audio/Video) IN**
Connexion analogique composite. Prend en charge uniquement le signal vidéo de définition standard (480i).
- 8 ANTENNA/CABLE IN**
Brancher les signaux d'antenne sur l'appareil.
Reliez les signaux du câble à cette prise.
- 9 SERVICE ONLY**
Utilisé pour les mises à jour logicielles.
- 10 Prise de cordon d'alimentation**
Cet appareil fonctionne sur c.a.
Avertissement : Ne jamais faire fonctionner sur une alimentation c.c.

PRÉPARATION

42/50PJ350, 50PK350, 50/60PK550, 42/50PJ550,
60PK290, 42/50PJ350C, 50/60PK550C

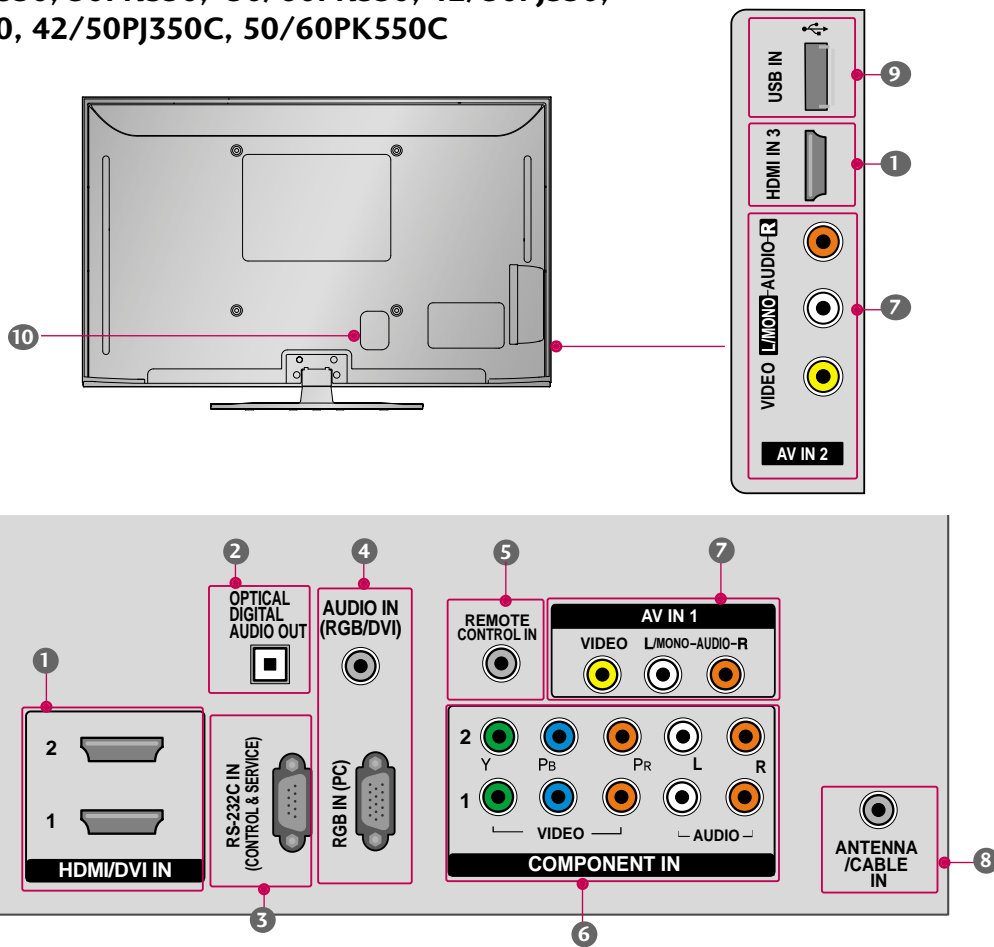

1 HDMI/DVI IN

Connexion numérique.

Prend en charge les signaux vidéo et audio numériques de haute définition. Ne prend pas en charge le mode 480i.

Prend en charge le signal DVI à l'aide d'un adaptateur ou d'un câble HDMI vers DVI (non inclus)

2 OPTICAL DIGITAL AUDIO OUT

Prise de sortie audio numérique pour l'amplificateur ou système cinéma maison.

Remarque: en mode attente, ces prises sont désactivées.

3 RS-232C IN (CONTROL & SERVICE) PORT

Utilisé sur appareils offerts par des tiers.

4 AUDIO IN (RGB)

Prise pour écouteurs de 1/8" pour l'entrée du signal audio analogique du PC.

RGB IN (PC)

Connexion analogique pour PC. Nécessite un câble D-sub à 15 broches (câble VGA).

5 REMOTE CONTROL IN PORT

Prise pour télécommande à fil.

6 COMPONENT IN

Connexion analogique. Prend en charge les signaux haute définition.

Nécessite un câble rouge, un câble vert et un câble bleu pour le signal vidéo, et un câble rouge et un câble blanc pour le signal audio.

7 AV (Audio/Video) IN

Connexion analogique composite. Prend en charge uniquement le signal vidéo de définition standard (480i).

8 ANTENNA/CABLE IN

Brancher les signaux d'antenne sur l'appareil. Reliez les signaux du câble à cette prise.

9 USB IN

Permet de regarder des photos, d'écouter des fichiers MP3.

10 PRISE DE CORDON D'ALIMENTATION

Cet appareil fonctionne sur c.a.

Avertissement : Ne jamais faire fonctionner sur une alimentation c.c.

INSTRUCTIONS DU SUPPORT

▪ Cette illustration peut ne pas correspondre à votre téléviseur.

Installation (Sauf 60PK250, 60PK540, 60PK550, 60PK280, 60PK290, 60PK550C)

- 1 Placez soigneusement l'écran du téléviseur, face vers le bas, sur un coussin afin de ne pas endommager l'appareil.

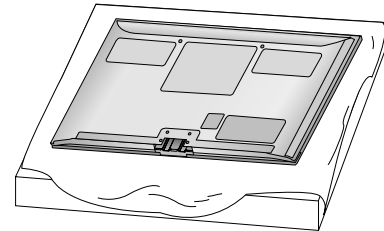

- 2 Assemblez les pièces du corps du pied à la base du pied du téléviseur.

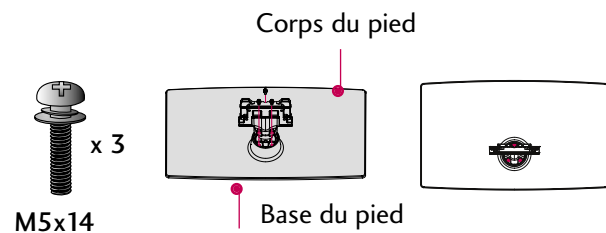

- 3 Assemblez le téléviseur tel qu'illustré.

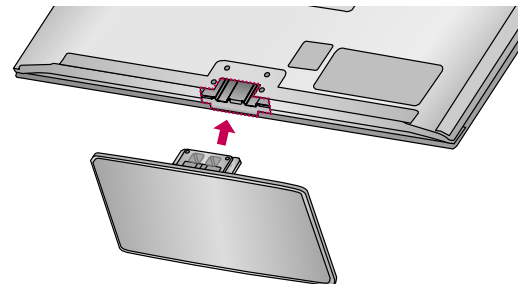

- 4 Fixez bien les quatre boulons dans les trous situés au dos de l'appareil.

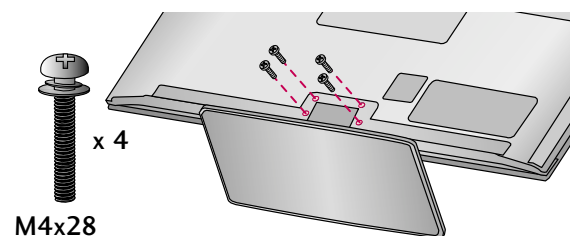

PRÉPARATION

Démontage

- 1 Placez soigneusement l'écran du téléviseur, face vers le bas, sur un coussin afin de ne pas endommager l'appareil.

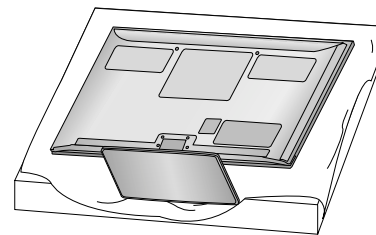

- 2 Desserrez les boulons du téléviseur.

(42/50PJ250, 50PK250, 42/50PJ340, 42/50PJ350, 50PK350, 50PK340, 50PK540, 42/50PJ550, (50PK550, 42/50PJ350C, 50PK550C) 60PK250, 60PK540, 60PK550, 60PK280, 60PK290, 60PK550C)

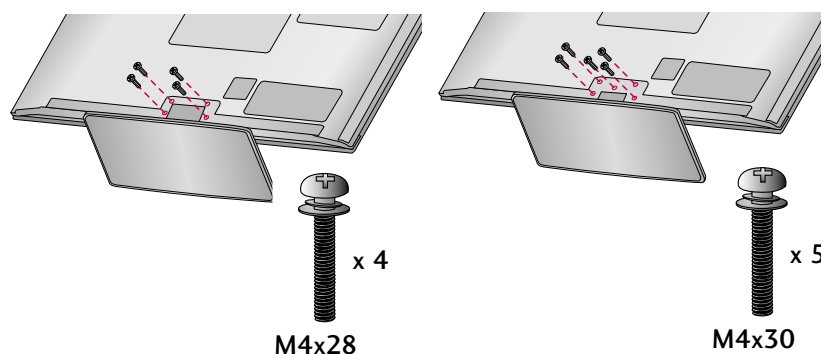

- 3 Démontez le support du téléviseur.

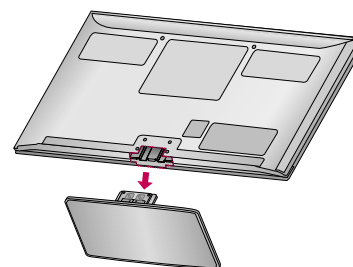

Couvercle de Protection
(fixer un guide aux extrémités).

Couvercle de Protection

Une fois la base retirée, fixez le **COUVERCLE DE PROTECTION** sur la cavité servant à accueillir la base.

Insérez le **COUVERCLE DE PROTECTION** dans le téléviseur jusqu'à ce que vous entendiez un clic.

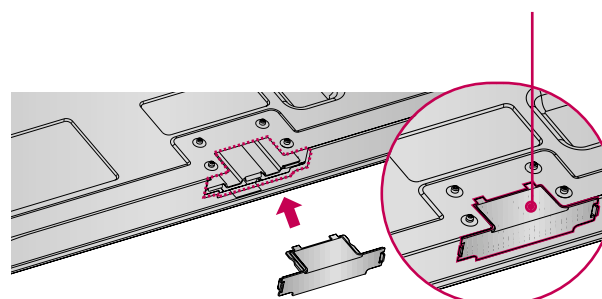

PINCE DU COMPARTIMENT À FILS

■ Cette illustration peut ne pas correspondre à votre téléviseur.

1 Après avoir relié les câbles selon les besoins, installez le SUPPORT de CÂBLE comme indiqué et regroupez les câbles.

Pour relier un appareil supplémentaire, reportez-vous à la section **CONFIGURATION DE LA SOURCE AUXILIAIRE**.

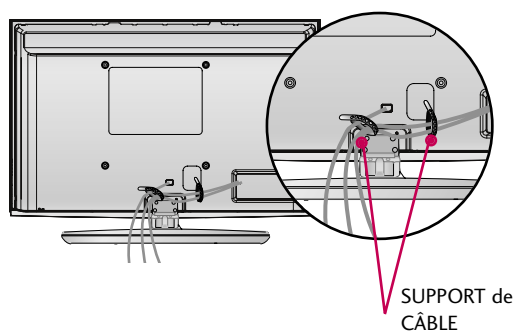

PRÉPARATION

INSTALLATION SUR UN BUREAU

- Cette illustration peut ne pas correspondre à votre téléviseur.

Pour assurer une ventilation adéquate, laissez un espace de 10 centimètres (4 pouces) des quatre côtés à partir du mur.

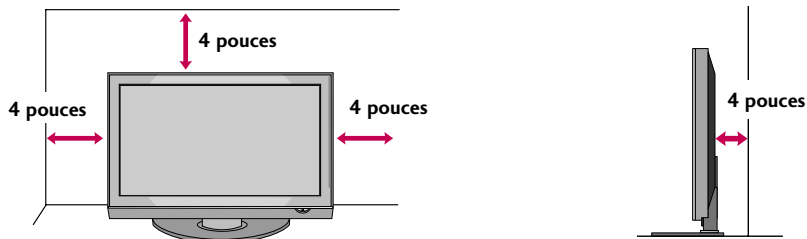

⚠ ATTENTION

- ▶ Assurez une bonne ventilation en respectant ces recommandations.
- ▶ Ne pas installer l'appareil près ou au-dessus d'une source de chaleur.

SOCLE PIVOTANT

- Cette fonction n'est pas disponible pour tous les modèles.

Après avoir installé le téléviseur, le régler manuellement vers la gauche ou la droite de 20° selon la position de visionnement désirée.

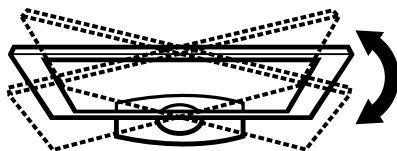

SYSTÈME DE FIXATION VESA (ASSOCIATION DES STANDARDS VIDÉO)

Installez votre fixation murale sur un mur solide perpendiculaire au plancher. Lorsque vous devez fixer à d'autres matériaux de construction, veuillez contacter le détaillant le plus proche de chez vous.

Si le téléviseur est installé au plafond ou sur un mur incliné, il peut chuter et causer des blessures corporelles graves. Nous vous préconisons l'utilisation d'un support de montage mural de la marque LG pour monter le téléviseur sur un mur. LG recommande que l'installation murale soit effectuée par un installateur professionnel qualifié.

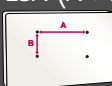
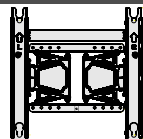
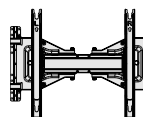
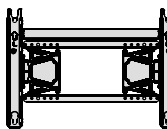
Modèle	VESA (A * B) 	Vis standard	Quantité	Support mural (vendu séparément)
50PK550, 42/50PJ340 42/50PJ350, 42/50PJ250 50PK250, 50PK340, 50PK350, 50PK540, 42/50PJ550, 42/50PJ350C, 50PK550C	400 * 400	M6	4	 AW-50PG60MS  AW-50PG60M
60PK550, 60PK250, 60PK280, 60PK290, 50PK540, 60PK550C	600 * 400	M8	4	 AW-60PG60MS

! NOTE

- ▶ La longueur des vis dépend de la fixation murale utilisée. Pour un complément d'information, reportez-vous aux instructions qui accompagnent la fixation.
- ▶ Les dimensions standard des ensembles de fixation murale sont présentées dans le tableau.
- ▶ Avec l'achat de notre ensemble de fixation murale, un manuel d'installation détaillé et toutes les pièces requises pour l'assemblage sont fournis.
- ▶ N'utilisez pas des vis plus longues que la dimension standard, puisqu'elles peuvent endommager l'intérieur du téléviseur.
- ▶ Pour les fixations murales qui ne sont pas conformes aux spécifications de la norme VESA concernant les vis, la longueur des vis peut différer dépendant de leurs caractéristiques techniques.
- ▶ N'utilisez pas des vis qui ne sont pas conformes aux spécifications de la norme VESA concernant les vis. Ne serrez pas les vis trop à fond, ce qui peut endommager le téléviseur ou causer la chute du téléviseur et des blessures corporelles. LG n'est pas responsable dans le cas de ce type d'accident.
- ▶ LG n'est pas responsable des dommages au téléviseur ou des blessures corporelles lorsqu'une fixation murale non conforme à la norme VESA ou qu'une fixation non spécifiée est utilisée ou que l'utilisateur néglige de suivre les instructions d'installation du téléviseur.

! ATTENTION

- ▶ N'installez pas votre ensemble de fixation murale pendant que votre téléviseur est allumé. Il pourrait en résulter des blessures corporelles causées par une décharge électrique.

INSTALLER LE TÉLÉVISEUR AU MUR DE FAÇON SÉCURITAIRE POUR L'EMPÊCHER DE TOMBER LORSQU'IL EST INSTALLÉ SUR UN PIED

- Vous devriez vous procurer les pièces requises pour éviter que le téléviseur ne bascule sur sa base.
- Cette illustration peut ne pas correspondre à votre téléviseur.

Nous vous conseillons d'installer votre téléviseur à proximité immédiate d'un mur afin que ce dernier retienne l'appareil en cas de basculement vers l'arrière.

De plus, nous vous conseillons également d'attacher le téléviseur au mur afin qu'il ne bascule pas vers l'avant, ce qui pourrait causer des blessures et endommager l'appareil.

Attention : Assurez-vous que les enfants ne montent pas ni s'accrochent au téléviseur.

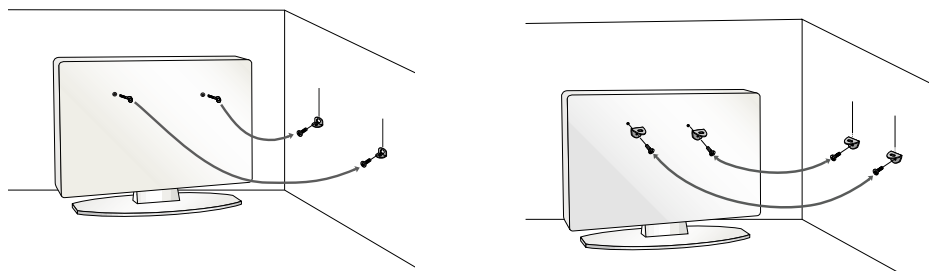

- Insérez les boulons à œil (ou les supports et boulons de la TV) pour attacher le produit au mur comme le montre l'image.

* Insérez les boulons à œil et serrez-les à fond dans les orifices supérieurs.

Fixez les supports au mur avec les boulons (vendu séparément). Faites correspondre la hauteur des supports montés au mur avec les orifices du produit.

Vérifiez que les boulons à œil et supports soient bien complètement serrés.

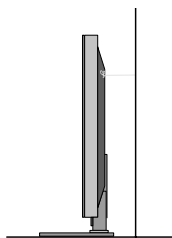

- Utilisez une ficelle solide (vendu séparément) pour attacher l'appareil. Il est plus sûr d'attacher la corde de façon à ce qu'elle soit horizontale entre le mur et l'appareil.

! REMARQUE

- ▶ Servez-vous d'une plateforme ou d'une armoire suffisamment grande pour accueillir le téléviseur, et suffisamment solide pour en supporter le poids.
- ▶ Pour utiliser le téléviseur en toute sécurité, veillez à ce que la hauteur du support mural et celle du téléviseur correspondent.

- Pour éviter d'endommager le téléviseur, ne branchez pas le cordon d'alimentation avant de procéder au branchement de tous les appareils.

CONNEXION ANTENNE OU CÂBLE

1. Antenne (analogique ou numérique)

Douille d'antenne murale ou antenne extérieure sans connexion à un convertisseur. Pour une qualité d'image maximale, régler la direction de l'antenne au besoin.

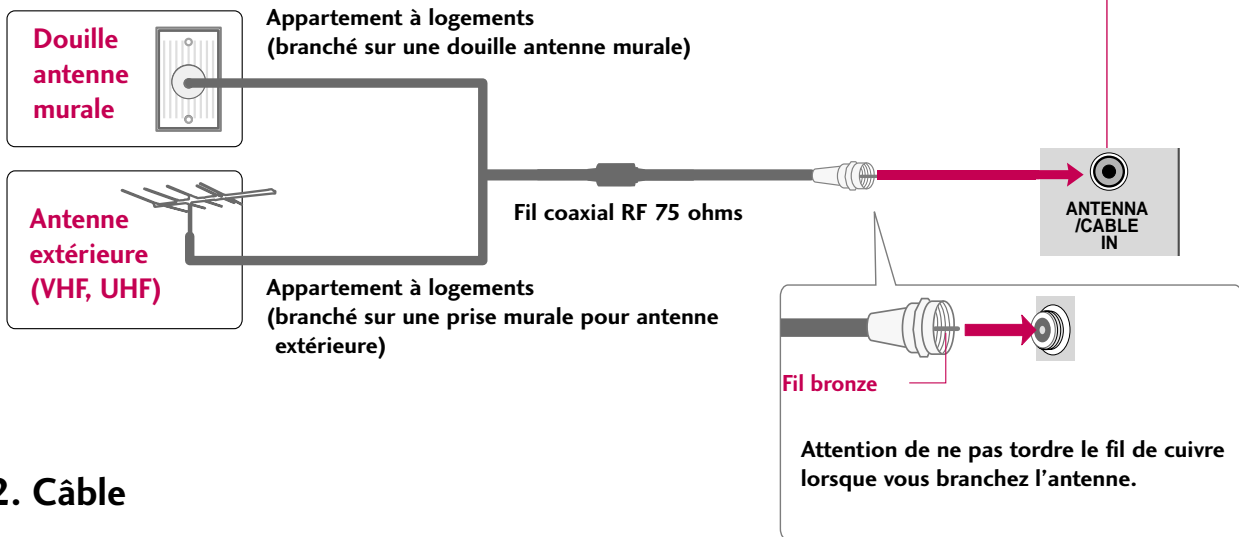

2. Câble

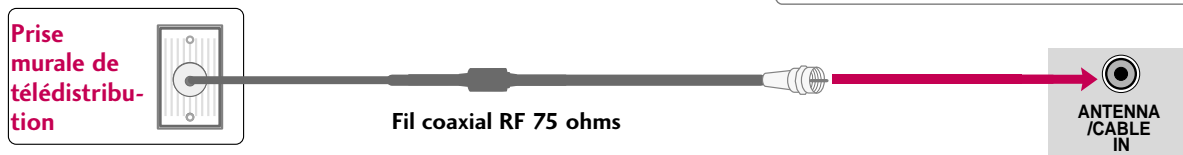

- Dans une zone où le signal est faible, pour améliorer la qualité, acheter et installer un amplificateur de signal.
- Si l'antenne doit être séparée pour deux téléviseurs, installer un séparateur de signal 2 façons pour les connexions.
- Si l'antenne n'est pas installée adéquatement, communiquer avec le marchand pour de l'aide.

CONFIGURATION DE LA SOURCE AUXILIAIRE

- Pour éviter que l'équipement ne subisse des dommages, ne branchez aucun cordon d'alimentation avant que tous les composants aient été raccordés.
- Cette illustration peut ne pas correspondre à votre téléviseur.

INSTALLATION DE RÉCEPTEUR HD

Cet appareil peut recevoir les signaux câble/hors antenne numérique sans boîte numérique extérieure. Toutefois il faut recevoir les signaux numériques depuis une boîte ou autre appareil externe numérique, voir l'illustration ci-dessous.

Connexion des composants

1. Comment brancher

- 1 Reliez les sorties vidéo (Y, PB, PR) du boîtier de la télévision numérique aux prises d'entrée **COMPONENT IN VIDEO 1** de l'appareil. Respectez les couleurs des prises (Y = vert, PB = bleu et PR = rouge).
- 2 Reliez la sortie audio du boîtier de la télévision numérique aux prises d'entrée **COMPONENT IN AUDIO 1** de l'appareil.

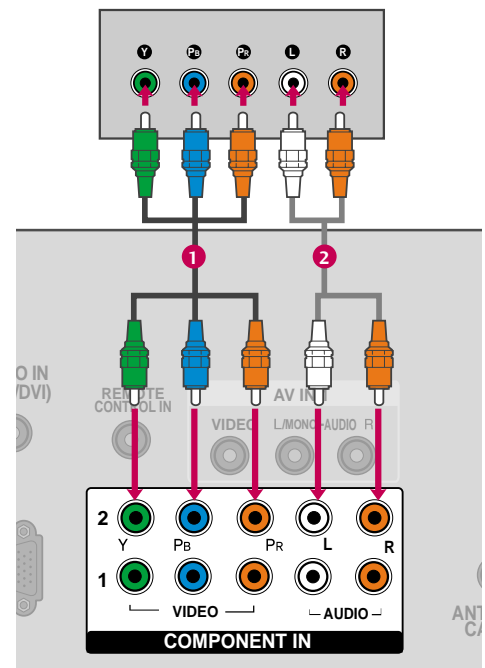

2. Comment utiliser

- Mettre la boîte numérique en circuit (voir le guide du propriétaire).
- Sélectionnez la source d'entrée **Composante 1** sur le téléviseur à l'aide de la touche **INPUT** de la télécommande.
- Si la composante est branchée à l'entrée **COMPONENT IN 2**, sélectionnez la source d'entrée **Composante 2** sur le téléviseur.

Résolutions prises en charge

Signal	Composante	HDMI
480i	Yes	No
480p	Yes	Yes
720p	Yes	Yes
1080i	Yes	Yes
1080p	Yes	Yes

Y, Cb/PB, Cr/PR

Resolution	Horizontal Frequency(KHz)	Vertical Frequency(Hz)
720x480i	15.73	59.94
	15.73	60.00
720x480p	31.47	59.94
	31.47	60.00
1280x720p	44.96	59.94
	45.00	60.00
1920x1080i	33.72	59.94
	33.75	60.00
1920x1080p	27.00	24.00
	33.75	30.00
	67.432	59.939
	67.50	60.00
	26.97	23.94
	33.71	29.97

Connexion HDMI

1. Comment brancher

- 1 Reliez le boîtier de la télévision numérique à la prise **HDMI/DVI IN 1, 2** ou **3** de l'appareil.
- 2 Un branchement audio séparé n'est pas nécessaire.
L'interface HDMI prend en charge l'audio et le vidéo.

2. Comment l'utiliser

- Allumez le boîtier de la télévision numérique (Consultez le manuel de l'utilisateur de votre boîtier numérique).
- Sélectionnez la source d'entrée **HDMI1, 2** ou **3** sur le téléviseur à l'aide de la touche **INPUT** de la télécommande.

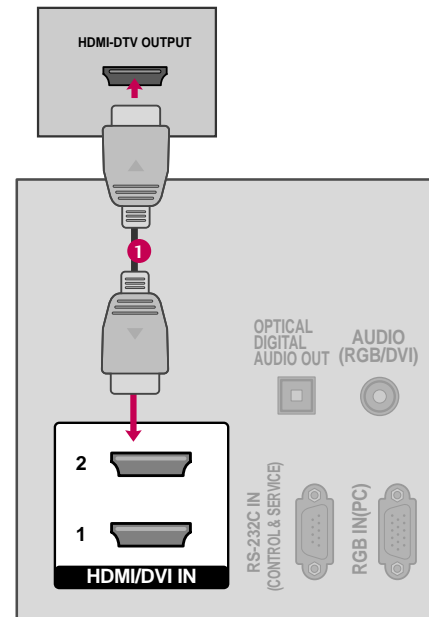

! REMARQUE

- Vérifiez la compatibilité du câble HDMI avec la version 1.3.

Les câbles HDMI ne prennent pas en charge l'HDMI version 1.3, ils causent des scintillements ou aucun affichage. Dans ce cas, utilisez des câbles plus récents qui prennent en charge HDMI version 1.3.

- Le mode HDMI supporte les formats audio PCM, AC-3 (Dolby Digital).

HDMI-DTV

Résolution	Fréquence Horizontale (KHz)	Fréquence Verticale (Hz)
720x480p	31.47	59.94
	31.47	60.00
1280x720p	44.96	59.94
	45.00	60.00
1920x1080i	33.72	59.94
	33.75	60.00
1920x1080p	27.00	24.00
	33.75	30.00
	67.432	59.939
	67.50	60.00
	26.97	23.94
	33.71	29.97

CONFIGURATION DE LA SOURCE AUXILIAIRE

Connexion DVI vers HDMI

1. Comment brancher

- 1 Reliez la sortie DVI du boîtier de la télévision numérique à la prise **HDMI/DVI IN 1, 2 ou 3** de l'appareil.

- 2 Reliez la sortie audio du boîtier de la télévision numérique à la prise **AUDIO IN (RGB/DVI)** de l'appareil.

2. Comment l'utiliser

- Allumez le boîtier de la télévision numérique. (Consultez le manuel de l'utilisateur de votre boîtier numérique.)
- Sélectionnez la source d'entrée **HDMI 1, 2 ou 3** sur le téléviseur à l'aide de la touche **INPUT** de la télécommande.

! REMARQUE

- ▶ Cette connexion requiert un câble DVI vers HDMI ou un adaptateur. Comme la connexion DVI ne prend pas en charge le signal audio, une connexion audio autonome est requise.

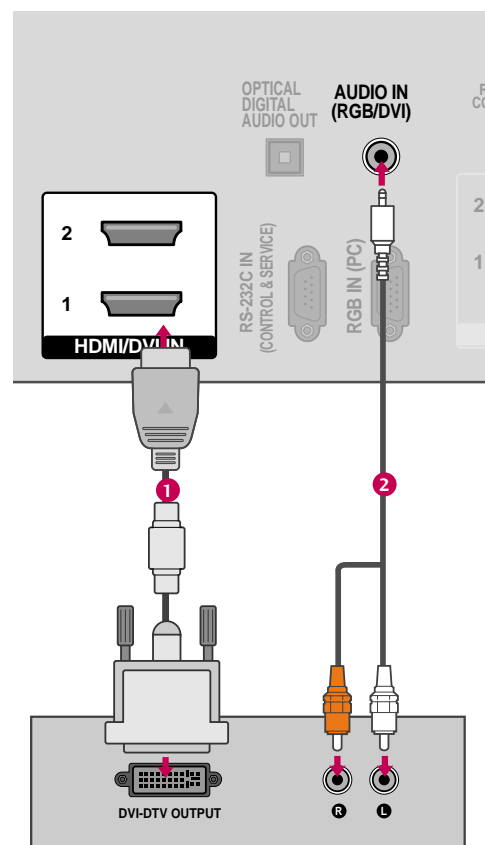

RÉGLAGE DVD

Connexion des composantes

1. Comment brancher

- 1 Reliez les sorties vidéo (Y, PB, PR) du DVD aux prises **COMPONENT IN VIDEO1** de l'appareil. Respectez les couleurs. (Y = vert, PB = bleu et PR = rouge).
-
- 2 Reliez les sorties audio du DVD aux prises **COMPONENT IN AUDIO1** de l'appareil.

2. Comment l'utiliser

- Allumez votre lecteur et insérez un DVD.
- Sélectionnez la source d'entrée **Component1** sur le téléviseur à l'aide de la touche **INPUT** de la télécommande.
- Si la composante est branchée à l'entrée **COMPONENT IN 2** sélectionnez la source d'entrée **Composante2** sur le téléviseur.
- Reportez-vous au manuel d'utilisation du lecteur DVD.

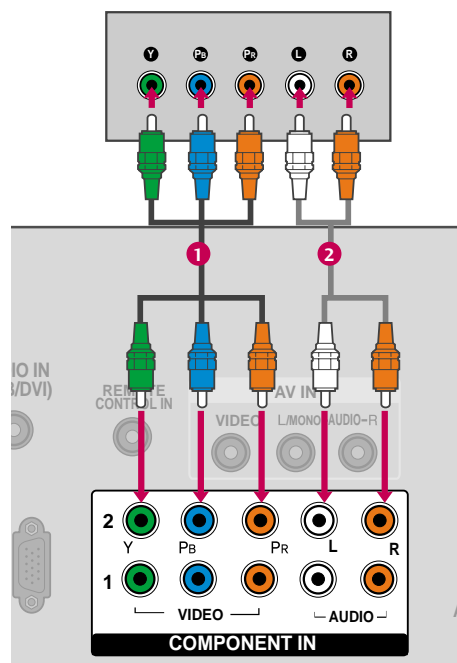

Ports Entrée Composante

Pour une meilleure qualité d'image, connectez votre lecteur DVD aux ports d'entrée composante comme montré ci-dessous.

Ports Composante de la TV	Y	P _B	P _R
Ports de sortie vidéo du lecteur DVD	Y	P _B	P _R
	Y	B-Y	R-Y
	Y	C _b	C _r
	Y	P _b	P _r

CONFIGURATION DE LA SOURCE AUXILIAIRE

Connexion HDMI

1. Comment brancher

- 1 Reliez la sortie HDMI due DVD aux prises **HDMI/DVI IN 1, 2 ou 3** de l'appareil.
- 2 Un branchement audio séparé n'est pas nécessaire. L'interface HDMI prend en charge l'audio et le vidéo.

2. Comment l'utiliser

- Sélectionnez la source d'entrée **HDMI 1, 2 ou 3** sur le téléviseur à l'aide de la touche **INPUT** de la télécommande.
- Reportez-vous au manuel d'utilisation du lecteur DVD.

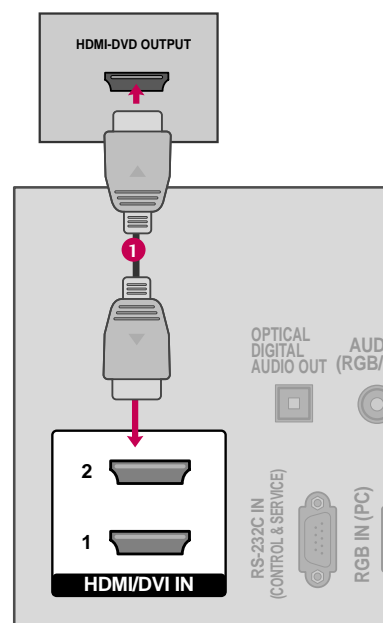

RÉGLAGE MAGNÉTOSCOPE

Branchement de l'antenne

1. Comment brancher

- 1 Reliez la sortie antenne RF du magnéto-scope à la prise **ANTENNA/CABLE IN** de l'appareil.
- 2 Branchez le câble de l'antenne à la prise antenne RF du magnéto-scope.

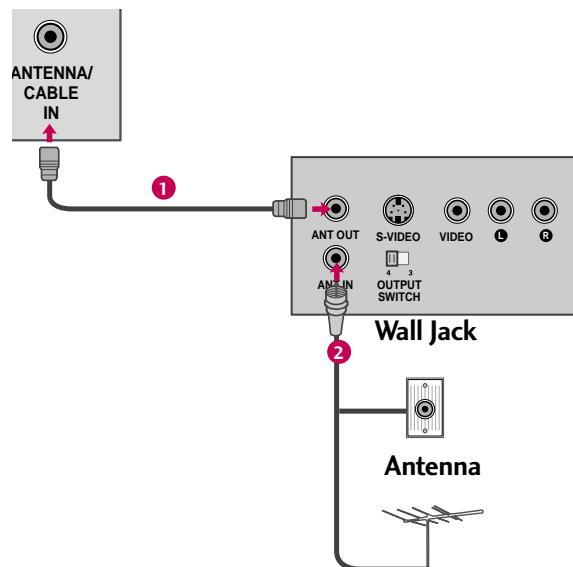

2. Comment l'utiliser

- Réglez l'interrupteur de sortie du magnéto-scope sur 3 ou 4 puis réglez la télévision sur le même canal.
- Insérez une cassette vidéo dans le magnéto-scope et appuyez sur la touche **PLAY**. (Reportez-vous au manuel de l'utilisateur du magnéto-scope).

Connexion composite (RCA)

1. Comment brancher

- 1 Reliez les prises **AUDIO/VIDEO** du téléviseur et du magnéto-scope. Respectez les couleurs (Vidéo = jaune, Audio Gauche = blanc et Audio Droit = rouge)

2. Comment l'utiliser

- Insérez une cassette vidéo dans le magnéto-scope et appuyez sur la touche **PLAY**. (Reportez-vous au manuel de l'utilisateur du magnéto-scope).
- Sélectionnez la source d'entrée **Vidéo 1** sur le téléviseur à l'aide de la touche **INPUT** de la télécommande.
- Si la composante est branchée à l'entrée **AV IN 2**, sélectionnez la source d'entrée **Vidéo 2** sur le téléviseur.

! REMARQUE

- ▶ Si votre magnéto-scope n'est pas stéréo, reliez le câble audio entre le magnéto-scope et la prise **AUDIO L/MONO** de l'appareil.

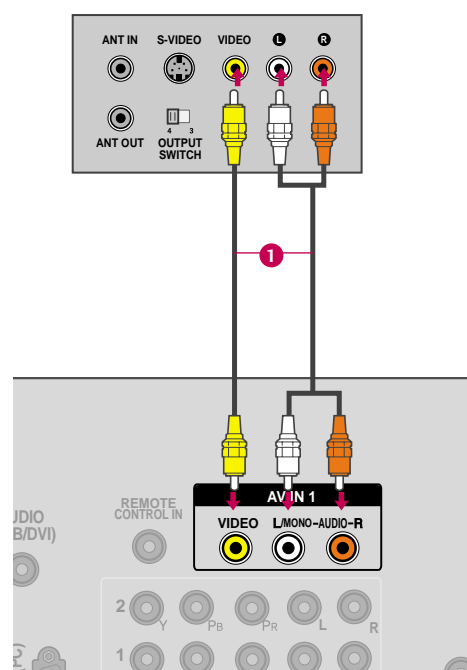

CONFIGURATION DE LA SOURCE AUXILIAIRE

RÉGLAGE SOURCE A/V EXTERNE

1. Comment brancher

- 1 Reliez les prises **AUDIO/VIDEO** du téléviseur et de l'appareil externe. Respectez les couleurs (Vidéo = jaune, Audio Gauche = blanc, et Audio Droit = rouge)

2. Comment l'utiliser

- Sélectionnez la source d'entrée **Vidéo2** sur le téléviseur à l'aide de la touche **INPUT** de la télécommande.
- Si la composante est branchée à l'entrée **AV IN 1** sélectionnez la source d'entrée **Vidéo1** sur le téléviseur.
- Faites fonctionner l'appareil externe.

Caméscope numérique

Console de jeux vidéo

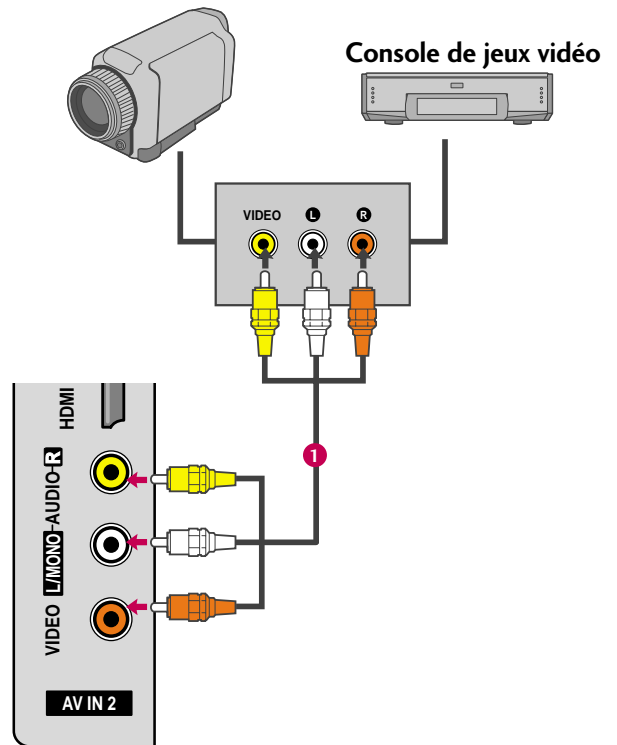

CONNEXION USB - Pour modèles 42/50PJ350, 50PK350, 42/50PJ550, 50/60PK550, 60PK290, 42/50PJ350C, 50/60PK550C

1. Comment brancher

- 1 Branchez le périphérique USB dans les prises **USB IN** situées sur le côté du téléviseur.

2. How to use

- Vous utilisez la fonction **USB IN** après avoir branché les prises **USB**. (► p.54)

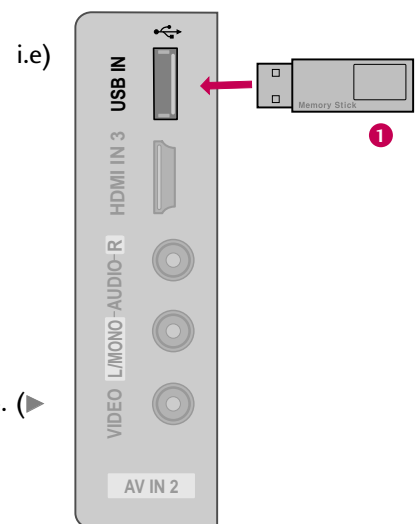

CONNEXION DE SORTIE AUDIO

Relier le son du téléviseur vers de l'équipement audio externe par le biais de la prise optique.

1. Comment brancher

- 1 Branchez l'une des extrémités du câble optique au port **OPTICAL** de la **DIGITAL AUDIO OUT** du téléviseur..
- 2 Branchez l'autre extrémité dans l'entrée audio numérique (optique) de l'équipement audio.
- 3 Réglez «Option Haut-parleurs internes – Arrêt» dans le menu **AUDIO**. (► p.82). Consultez le manuel d'utilisation de l'équipement audio externe.

! REMARQUE

- Lorsque vous branchez équipements audios externes comme des amplificateurs ou des haut-parleurs, vous pouvez désactiver les haut-parleurs du téléviseur à partir du menu. (► p.82)

⚠ ATTENTION

- Ne pas regarder à l'intérieur du port de sortie optique. Regarder un rayon laser peut endommager vos yeux.
- La fonction ACP (Audio Copy Protection) peut bloquer la sortie audio numérique.

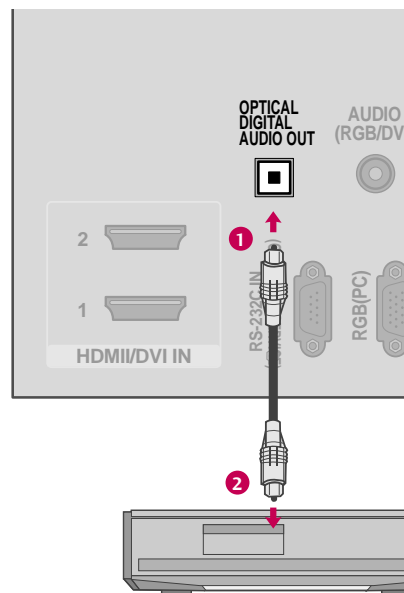

CONFIGURATION DE LA SOURCE AUXILIAIRE

RÉGLAGE PC

Cette TV dispose d'une fonctionnalité Plug&Play (prête à utiliser), ce qui signifie que l'ordinateur se règle automatiquement en fonction des réglages de la télévision.

Connexion VGA (D-sub à 15 broches)

1. Comment brancher

- 1 Reliez la sortie VGA de l'ordinateur à la prise **RGB IN (PC)** de l'appareil.
- 2 Reliez la sortie audio du PC à la prise **AUDIO IN (RGB/DVI)** de l'appareil.

2. Comment l'utiliser

- Allumez votre ordinateur et l'appareil.
- Sélectionnez la source d'entrée **RGB-PC** sur le téléviseur à l'aide de la touche **INPUT** de la télécommande.

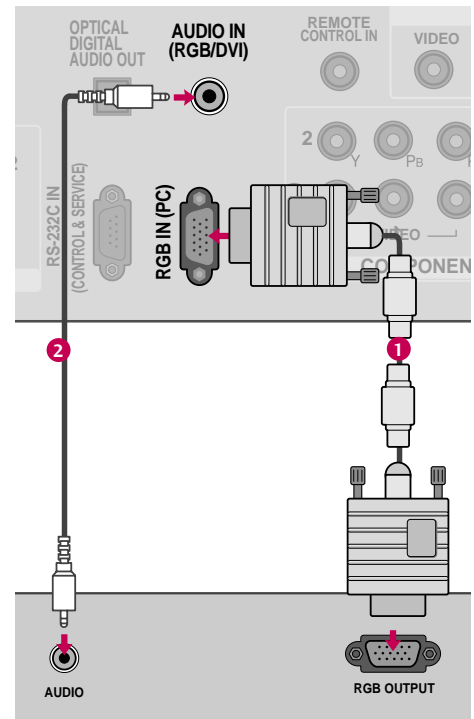

Connexion DVI vers HDMI

1. Comment brancher

- 1 Reliez la sortie DVI du PC à la prise **HDMI/DVI IN 1, 2 ou 3** de l'appareil.
- 2 Reliez la sortie audio du PC à la prise **AUDIO IN (RGB/DVI)** de l'appareil.

2. Comment l'utiliser

- Allumez votre ordinateur et l'appareil.
- Sélectionnez la source d'entrée **HDMI 1, 2 ou 3** sur le téléviseur à l'aide de la touche **INPUT** de la télécommande.

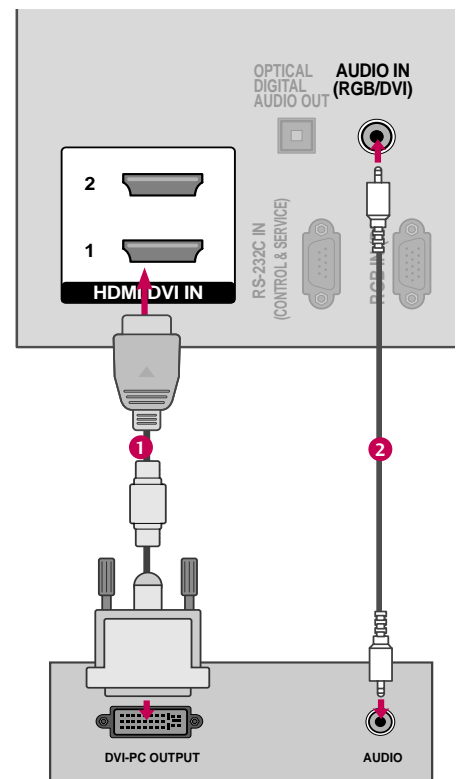

! REMARQUE

- ▶ En fonction de votre carte graphique, il se peut que le mode DOS ne fonctionne pas si vous utilisez un câble DVI vers HDMI.
- ▶ IEn mode PC, il se peut qu'il y ait des défauts du point de vue de la résolution, de l'alignement vertical, du contraste ou de la brillance. Si tel est le cas, modifiez la résolution de la sortie PC ainsi que le taux de rafraîchissement et réglez la brillance et le contraste dans le menu IMAGE jusqu'à ce que l'image soit claire.
- ▶ Évitez de laisser une image fixe à l'écran pendant une période prolongée. Celle-ci pourrait s'imprimer de manière permanente à l'écran.
- ▶ La synchronisation des fréquences Horizontales et Verticales est séparée.
- ▶ Sur certains modèles de carte graphique, il se peut que certains réglages de résolution empêchent l'affichage de l'image au bon endroit sur l'écran.

Spécifications des Affichages Compatibles (RGB-PC, HDMI-PC)

Résolution	Fréquence Horizontale (KHz)	Fréquence Verticale (Hz)
640x350	31.468	70.09
720x400	31.469	70.08
640x480	31.469	59.94
800x600	35.156	56.25
	37.879	60.31
1024x768	48.363	60.00
1280x768	47.776	59.87
1360x768	47.712	60.015
1280x1024	63.981	60.020
1600x1200	74.537	59.869
1920x1080	66.587	59.934

Sauf 42/50PJ250, 42/50PJ340, 42/50PJ350, 42/50PJ550, 42/50PJ350C

CONFIGURATION DE LA SOURCE AUXILIAIRE







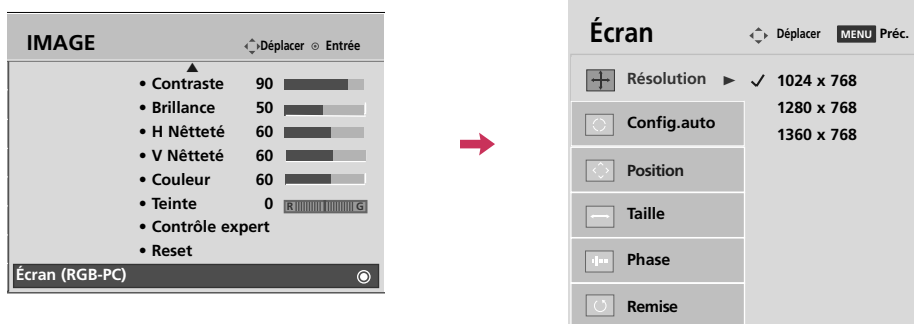

Réglage de l'écran pour mode PC

Sélection de la résolution

Vous pouvez choisir le mode RGB-PC.

D'autres réglages, comme la **Position**, la **Phase** et la **Taille** peuvent également être modifiés.











-   Sélectionnez **IMAGE**.
-   Sélectionnez **Écran (RGB-PC)**.
-   Sélectionnez **Résolution**.
-   Sélectionnez la résolution souhaitée.
- 

Config.Auto

Ajuste automatiquement la position de l'image et en réduit l'instabilité. Si l'image ne s'affiche toujours pas correctement après l'avoir ajustée, essayez le réglage manuel ou choisissez une résolution différente, ou encore un autre taux de rafraîchissement sur votre PC.



- 1   Sélectionnez **IMAGE**.
- 2   Sélectionnez **Écran (RGB-PC)**.
- 3   Sélectionnez **Config.auto**.
- 4   Sélectionnez **Oui**.
- 5  Démarrage de la configuration automatique.

- Si la position de l'image n'est toujours pas satisfaisante, essayez de nouveau l'ajustement automatique.
- Si vous avez encore besoin d'ajuster l'image après avoir utilisé l'ajustement automatique du mode RGB-PC, vous pouvez modifier la **Position**, la **Taille** et la **Phase** de l'image.







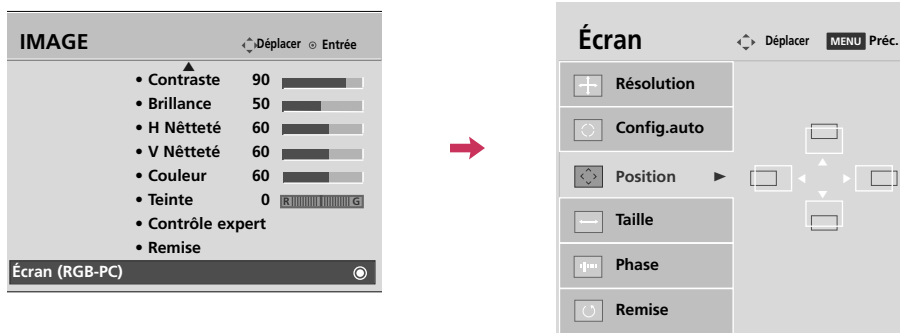

CONFIGURATION DE LA SOURCE AUXILIAIRE

Réglage de la position de Position, Taille, Phase

Si l'image n'est pas claire après le réglage automatique et surtout si les caractères vibrent, régler la Phase manuellement.

Cette fonctionnalité n'est offerte qu'en mode RGB-PC.











-   Sélectionnez **IMAGE**.
-   Sélectionnez **Écran (RGB-PC)**.
-   Sélectionnez **Position, Taille** ou **Phase**.
-   Effectuez les réglages appropriés.
- 

- **Position:** Cette fonction sert à ajuster la position Gauche/Droite et Haut/Bas de l'image en fonction de vos préférences.
- **Taille:** Cette fonction sert à réduire les lignes verticales ou les rayures visibles en fond d'écran. Les dimensions horizontales de l'écran sont également modifiées.
- **Phase:** Cette fonction vous permet d'éliminer le brouillage horizontal et d'améliorer la netteté et le contraste de l'affichage des caractères.

Réinitialisation de l'écran (chargement des paramètres usine)

Réinitialise les réglages de l'image effectués en usine touchant la **Position**, la **Taille** et la **Phase**. Cette fonctionnalité n'est offerte qu'en mode RGB-PC.



- 1   Sélectionnez **IMAGE**.
- 2   Sélectionnez **Écran (RGB-PC)**.
- 3   Sélectionnez **Remise**.
- 4   Sélectionnez **Oui**.
- 5 

VISIONNEMENT DE LA TÉLÉVISION / COMMANDE DES CHÂÎNES

FONCTIONS DE LA TÉLÉCOMMANDE

Au moment d'utiliser la télécommande, la diriger vers le capteur sur l'appareil.

50/60PK250, 50/60PJ250,
42/50PJ350, 42/50PJ340,
42/50PJ550, 50PK340,
50PK350, 60PK280, 60PK290,
42/50PJ350C

POWER Met le téléviseur en marche et le met en mode d'attente.

ON/OFF Permet d'illuminer les boutons de la télécommande.

ENERGY SAVING Permet de régler la fonction Économie d'énergie.

AV MODE Toggles through preset Video and Audio modes. ► p.51

Alterne les sources d'entrées

INPUT Met le téléviseur en marche. ► p.49

TV Mode de fonctionnement de la télécommande: TV

Touches NUMÉRIQUES — (TIRET) Utilisé pour entrer un numéro d'émission pour des canaux à émissions multiples comme 2-1, 2-2, etc.

LIST Affiche le tableau des chaînes.

FLASHBK Syntonise les canaux plus récents.

Touches colorées Modification du programme.

SIMPLINK Control buttons ◀◀ (Retour arrière), ▶▶ (Avance rapide), ▶ (Lecture), || (Pause)
◦ Permet de commander les dispositifs compatibles SIMPLINK.

FREEZE Gèle l'image courante.

■ (Stop) Permet d'arrêter la fonction Time Machine contrôle du direct. (Lecture, Retour rapide, etc.)

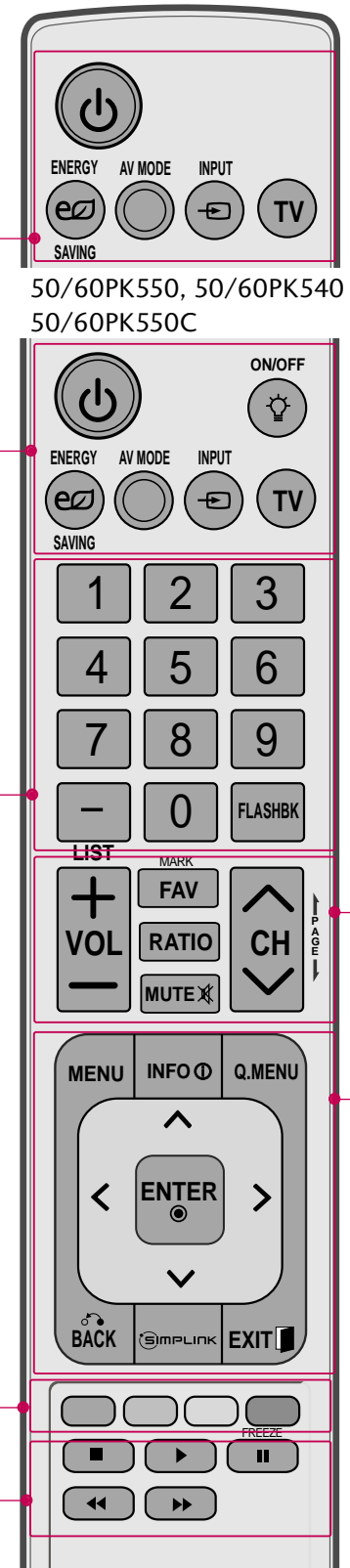

NAVIGATEUR (ascendant/descendant/gauche/droite/ENTER)	Permet de naviguer les menus à l'écran et effectuer les réglages selon ses préférences.
MENU	Affiche le menu principal ou efface tous les affichages à l'écran et revient au mode de visionnage TV.
INFO	Pour afficher les informations en haut de l'écran.
Q.MENU	Ouvre la liste d'options du menu rapide.
BACK	Permet à l'utilisateur de retourner à l'opération précédente d'une application ou d'une fonction interactive.
SIMPLINK	Permet d'afficher les informations sur les chaînes en haut de l'écran.
EXIT	Permet d'effacer tous les affichages à l'écran et de retourner à la chaîne visionnée, à partir de n'importe-quel menu.

VOLUME ASCENDANT / DESCENDANT	Amplifie ou atténue le niveau sonore.
FAV	Utiliser pour faire défiler les canaux préférés. ► p.47
RATIO	Change le rapport largeur/hauteur de la vidéo.
MUTE	Sonorité marche-arrêt. ► p.38
CHANNEL ASCENDANT / DESCENDANT	Pour sélectionner les chaînes disponibles.
PAGE ASCENDANT / DESCENDANT	Passer d'une page d'information à l'autre.

Installation des piles

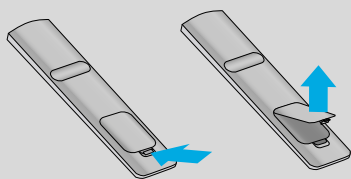

- Installation des piles l'arrière et installer les piles en observant les polarités.
- Installer deux piles 1,5 V AAA. Ne pas mélanger des piles usées avec des piles neuves.
- Remettre le couvercle.

VISIONNEMENT DE LA TÉLÉVISION / COMMANDE DES CHAÎNES

MISE EN CIRCUIT DU TÉLÉVISEUR

- 1 D'abord, brancher correctement le cordon d'alimentation.
À ce moment le téléviseur se met en mode attente.
 - En mode attente pour mettre l'appareil en circuit, presser $\phi/1$, **INPUT, CH** (^ ou v) sur le téléviseur ou presse **POWER, INPUT, CH** (^ ou v), **NUMÉRIQUES(0~9)** sur la télécommande.
- 2 Sélectionner la source de visionnement avec les touches **INPUT** sur la télécommande.
- 3 Lorsque l'on a terminé d'utiliser le téléviseur, presser **POWER** sur la télécommande, l'appareil revient au mode attente.

! REMARQUES

- ▶ Si l'on part en vacances, débrancher le cordon d'alimentation de la prise murale.

SÉLECTION DE CHAÎNE

- 1 Appuyez sur la touche **CH** (^ ou v) ou **NUMÉRIQUES** pour définir un numéro de chaîne.

RÉGLAGE DU VOLUME

Réglez le volume à votre convenance.

- 1 Appuyez sur la touche **VOL (+ or -)** pour ajuster le volume.
- 2 Si vous souhaitez couper le son, appuyer sur la touche **MUTE**.
- 3 Vous pouvez réactiver le son en appuyant de nouveau sur la touche **MUTE** ou **VOL (+ ou -)**.

RÉGLAGE INITIAL

Cette fonction permet à l'utilisateur de facilement configurer les éléments de base qui permettent de regarder le téléviseur pour la première fois après son achat. Ces éléments apparaîtront à l'écran dès la première utilisation du téléviseur. La fonction peut également être activée à partir des menus utilisateur.

- Le réglage par défaut correspond au mode "**Résidentielle**". Pour la résidence, nous recommandons le mode "**Résidentielle**" qui procurera une qualité d'image optimale.
- Le mode "**Démo en magasin**" est conçu uniquement pour les téléviseurs utilisés en magasin. L'utilisateur peut régler le **Mode image** manuellement, lorsqu'il inspecte le téléviseur, mais le téléviseur rétablira le réglage In **Démo en magasin** 5 prédéfini après un délai de 5 minutes.
- Vous pouvez également régler l'option **Réglage initial** dans le menu **OPTION**. Les réglages d'usine par défaut sont définis si vous choisissez "**Résidentielle**".
- Si vous ne terminez pas la procédure d'installation, le menu de réglage initial sera affiché à chaque fois que vous mettez le téléviseur en marche et, tant que le réglage initial ne sera pas complété.

Étape1. Welcome

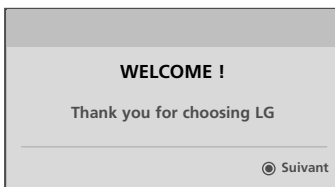

Étape2. Sélection de la langue

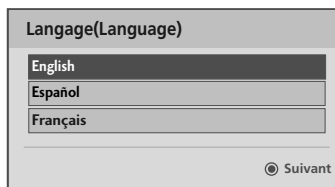

Sélectionnez Langage menu.

Étape3. Réglage mode

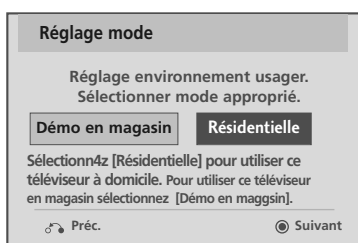

Sélectionnez **Résidentielle**.

Étape4. Réglage temporel



Sélectionnez **Auto** ou **Manuel**.



Régler l'heure désirée.

Étape5. Syntonisation auto

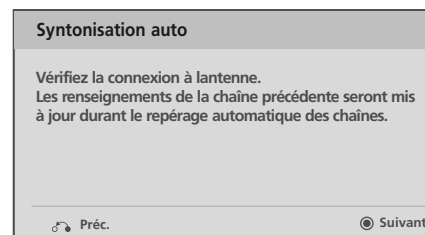

Démarrer **Syntonisation auto**.

VISIONNEMENT DE LA TÉLÉVISION / COMMANDE DES CHAÎNES

SÉLECTION DES MENUS AFFICHÉS À L'ÉCRAN

L'écran OSD de votre téléviseur peut différer légèrement de l'illustration du présent manuel.

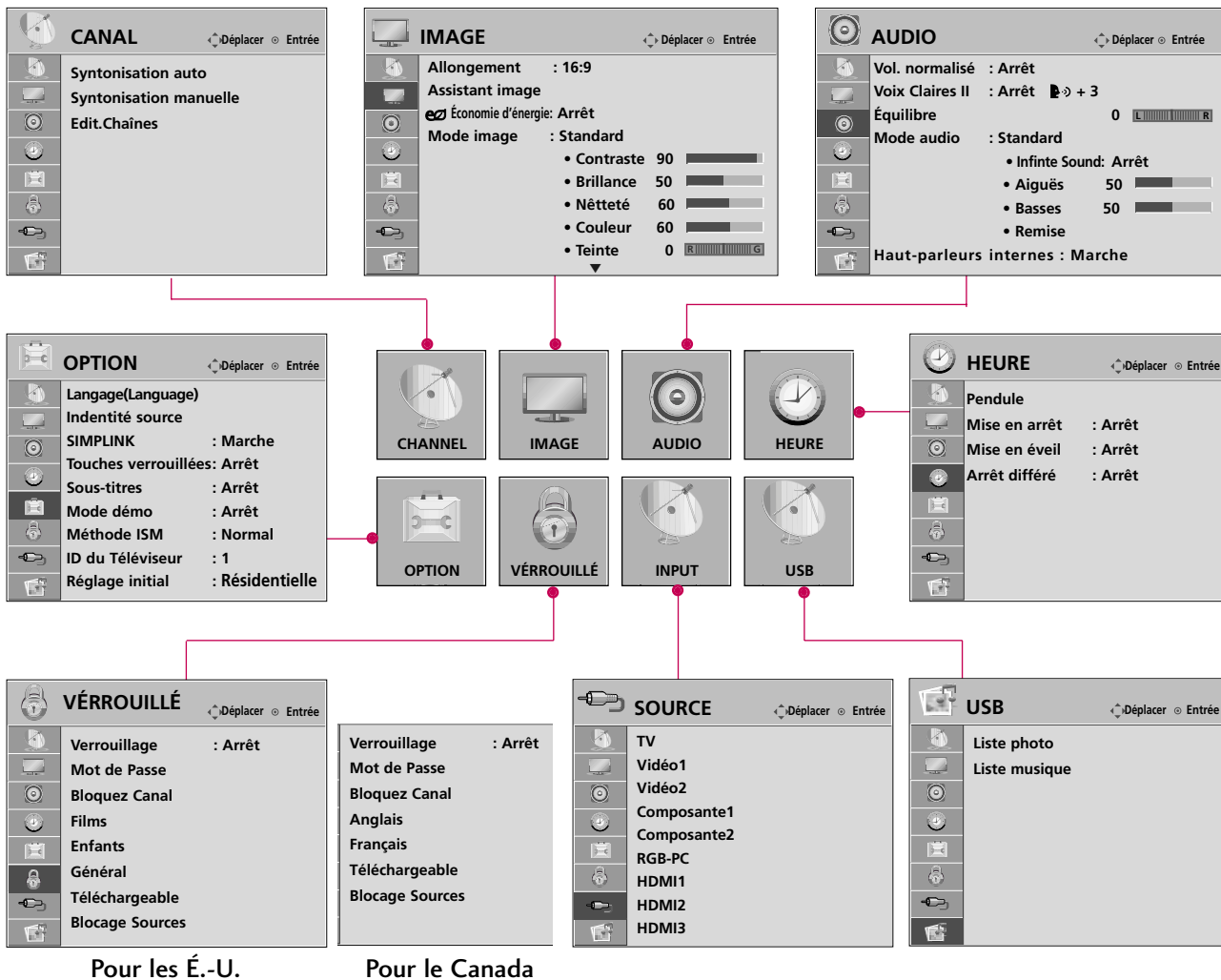

- 1 Affiche chaque menu.
- 2 Sélectionner une option de menu.
- 3 Accepte la sélection en cours.
- 4 Retourner à l'affichage télé.

42/50PJ250, 50/60PK250, 60PK280, 42/50PJ340, 50PK340, 50/60PK540

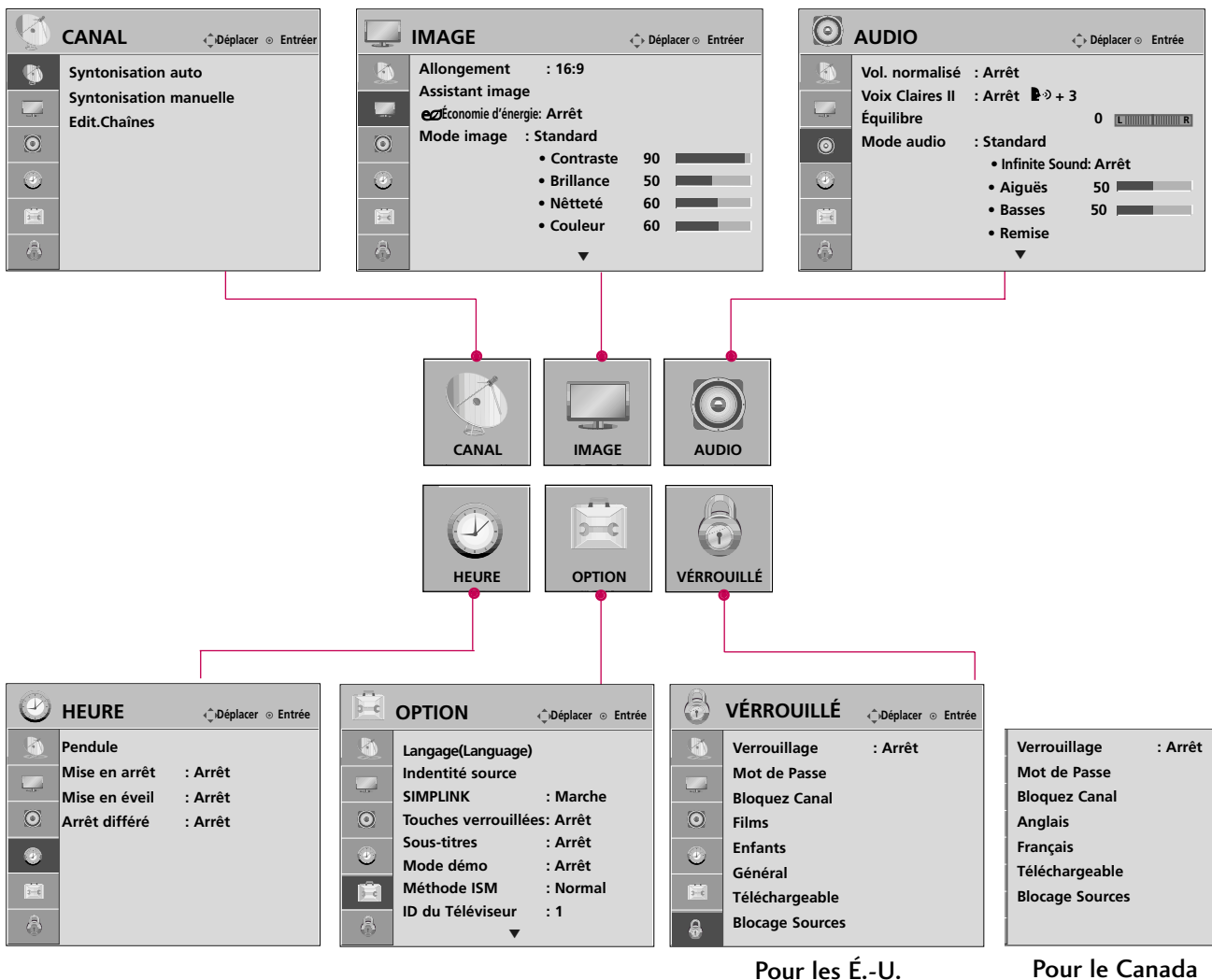

1 Affiche chaque menu.

2 Sélectionner une option de menu.

3 Accepte la sélection en cours.

4 Retourner à l'affichage télé.

VISIONNEMENT DE LA TÉLÉVISION / COMMANDE DES CHAÎNES

MENU ÉCLAIR (QUICK MENU)



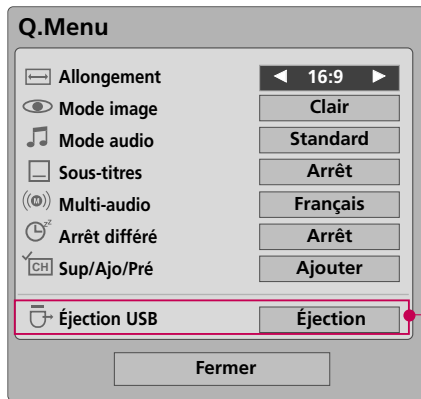

L'écran OSD de votre téléviseur peut différer légèrement de l'illustration du présent manuel.

Le Q.Menu (Menu éclair) comprend des fonctions auxquelles l'utilisateur pourrait faire fréquemment appel.



Seulement 42/50PJ350,
50PK350, 50/60PK550,
42/50PJ550, 60PK290,
42/50PJ350C,
50/60PK550C

- ☐ **Allongement:** Permet de sélectionner le format d'image désirée.
- 👁️ **Mode image:** Pour choisir le mode image réglée en usine selon l'environnement de visionnement.
- 🎵 **Mode audio:** Sélectionner le son approprié pour le programme.
- 🔊 **Multi-audio:** Modifier la langue audio (signal numérique).
- 🔊 **SAP:** Permet de choisir la sonorité MTS (signal analogique).
- 🕒 **Arrêt différé:** Pour choisir la durée avant la mise hors circuit automatique du téléviseur.
- 📺 **Sup/Ajo/Pré:** Sélectionnez les chaînes que vous désirez ajouter ou supprimer, ou ajoutez les chaînes à votre liste de chaînes favorites.
- ☐ **Sous-titres:** Sélectionner Marche ou Arrêt.
- 🗑️ **USB Device:** Sélectionnez la fonction "Éjection" pour retirer le périphérique USB.

- 1   Affiche chaque menu.
- 2  Effectuez les réglages appropriés.
- 3  Retourner à l'affichage télé.

REPÉRAGE DE CANAUX







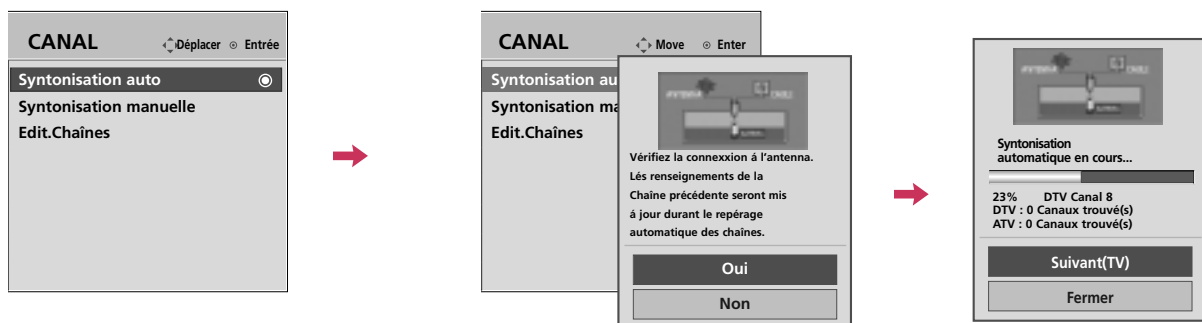

Recherche automatique des chaînes (Syntonisation automatique)

Trouve automatiquement tous les canaux disponibles par l'antenne ou la télédistribution et les met en mémoire dans la liste de canaux.

Utilisez cette fonction si vous déménagez ou si vous déplacez le téléviseur. Veuillez également utiliser cette fonction avec l'antenne connectée pendant les heures de diffusion des émissions de télévision.

La recherche automatique des chaînes mémorise uniquement les chaînes disponibles à l'instant précis où elle est lancée.



- 1   Sélectionnez **CANAL**.
- 2   Sélectionnez **Syntonisation auto**.
- 3   Sélectionnez **Oui**.
- 4  Effectuer le **Syntonisation auto**.
- 5  Retourner au menu précédent.
-  Retourner à l'affichage télé.









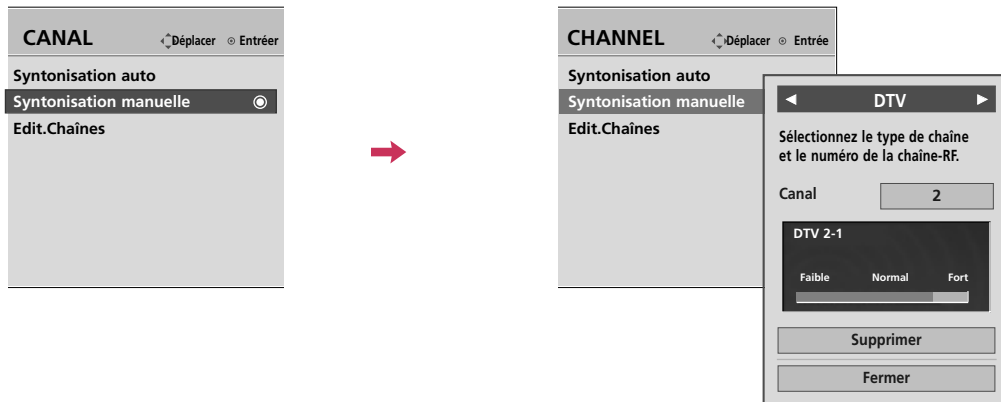



- Le téléviseur demandera un mot de passe si le contrôle parental a été activé (menu de verrouillage).
Utilisez le mot de passe que vous avez défini dans le menu de verrouillage pour autoriser une recherche de canal.
- Lors du réglage de la syntonisation automatique ou manuelle, le nombre maximum de stations pouvant être placées en mémoire est de 900. Sujet à changer dépendamment de l'environnement des signaux télédiffusés.
- Permet de mémoriser toutes les chaînes disponibles dans l'ordre suivant: DTV, TV, CADTV et CATV.

VISIONNEMENT DE LA TÉLÉVISION / COMMANDE DES CHAÎNES

Ajout/Effacement des chaînes (Syntonisation manuelle)

Lorsque vous sélectionnez les signaux d'entrée DTV ou CADTV, vous pouvez afficher le témoin évaluant l'intensité du signal à l'écran de manière à voir la qualité du signal reçu.



-   Sélectionnez **CANAL**.
-   Sélectionnez **Syntonisation manuelle**.
-   Sélectionnez **DTV, TV, CADTV** ou **CATV**.
-   Sélectionnez la chaîne que vous désirez ajouter ou supprimer.
-   Sélectionnez **Ajouter** ou **Supprimer**.
-  Retourner au menu précédent.
-  Retourner à l'affichage télé.









- Le téléviseur demandera un mot de passe si le contrôle parental a été activé (menu de verrouillage). Utilisez le mot de passe que vous avez défini dans le menu de verrouillage pour autoriser une recherche de canal.
- Lors du réglage de la syntonisation automatique ou manuelle, le nombre maximum de stations pouvant être placées en mémoire est de 900. Sujet à changer dépendamment de l'environnement des signaux télédiffusés.

Édition des chaînes

Lorsqu'une chaîne est supprimée cela signifie que vous ne pourrez la sélectionner par le biais des touches CH ^ , v en naviguant les stations disponibles au téléviseur.

Si vous désirez sélectionner une chaîne supprimée, saisissez directement le numéro de la chaîne respective avec les touches numériques ou réactivez-la par le biais du menu « Edit Chaînes ».



- 1   Sélectionnez **CANAL**.
- 2   Sélectionnez **Edit.Chaînes**.
- 3   Sélectionner une chaîne.
- 4  Ajouter ou supprimer une chaîne.
- 5  Retourner au menu précédent.
-  Retourner à l'affichage télé.

VISIONNEMENT DE LA TÉLÉVISION / COMMANDE DES CHÂÎNES

LISTE DES CANAUX

Vous pouvez vérifier quelles chaînes sont enregistrées dans la mémoire en affichant la liste des canaux.

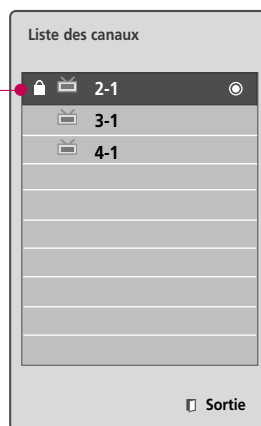

Ce cadenas est affiché quand la chaîne est verrouillée avec le contrôle parental.



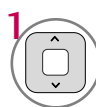

Affichage de la liste des chaînes

- 1  Afficher la liste des chaînes

Sélection d'une chaîne dans la liste des chaînes

- 1  Choisir une chaîne.
- 2  Se rendre au numéro de chaîne choisi.

Pagination à l'aide d'une liste de chaînes

- 1  Tourner les pages.
- 2  Retourner à l'affichage télé.





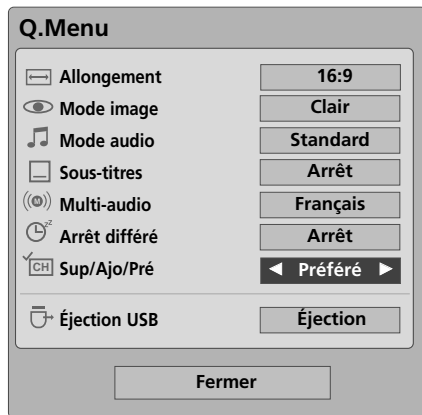

MÉMOIRE DES CANAUX PRÉFÉRÉS

L'écran OSD de votre téléviseur peut différer légèrement de l'illustration du présent manuel.

Les stations préférées sont une façon agréable de vous donner accès rapide à une gamme de stations de votre choix sans avoir à naviguer toutes les autres intermédiaires.

Pour sélectionner le canal préféré, appuyez de touche **FAV** (Favoris) de façon répétitive.



- 1  ou  Sélectionnez le canal souhaité.
- 2   Sélectionnez **Sup/Ajo/Pré**.
- 3  Sélectionnez **Préré**.
- 4  Retourner à l'affichage télé.

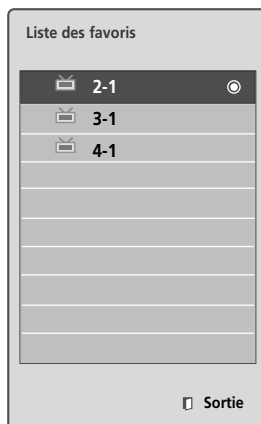

LISTE DES FAVORIS





Affichage de la liste des chaînes préférées

- 1  Afficher la liste des chaînes préférées.

Sélection d'une chaîne dans la liste des chaînes préférées

- 1  Choisir une chaîne.
- 2  Se rendre au numéro de chaîne choisi.



Pagination par une liste des chaînes préférées

- 1  Tourner les pages.
- 2  Retourner à l'affichage télé.

VISIONNEMENT DE LA TÉLÉVISION / COMMANDE DES CHAÎNES

INFO. EN BREF

L'écran Info affiche les informations de la programmation en cours.

1  ou  Appuyez sur la touche INFO pour faire apparaître l'Écran Info.

2  Retourner à l'affichage télé.

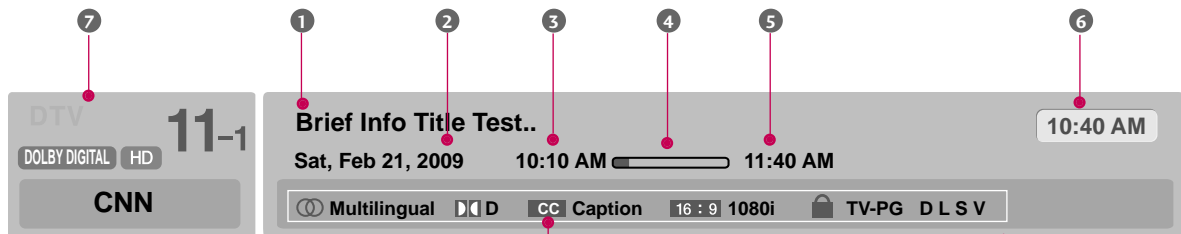

Multilingue: Multilingue: programme contenant un ou plusieurs services audio. Appuyez sur **Q.MENU** pour choisir l'audio désiré.



Sous-titres: programme contenant un ou plusieurs services de sous-titres. Appuyez sur **Q.MENU** pour sélectionner celui désiré.



Dolby Digital: Le programme contient un signal audio Dolby Digital dans la source d'entrée TV et HDMI.



Allongement d'origine de vidéo est 4:3



Allongement d'origine de vidéo est 16:9 (large)



Définition vidéo est 720x480i



Définition vidéo est 720x480p



Définition vidéo est 1280x720p



Définition vidéo est 1920x1080i



Définition vidéo est 1920x1080p



V-Chip: Programme contenant information puce V, voir **VÉRROUILLÉ** menu: A (Age), D (Dialogue), L (Langue), S (Sexe), V (Violence), FV (violence fantaisiste)

- 1 Titre programme
 - 2 Jour, Mois, Année
 - 3 Heure début programme
 - 4 Barre de progression du programme
 - 5 Heure fin programme
 - 6 Heure fin programme
 - 7 Heure en cours
- Bande d'information

LISTE D'ENTRÉES

Vous ne pouvez choisir et activer que les signaux d'entrée branchés au téléviseur.



1

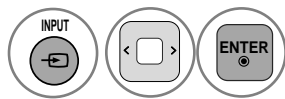

Sélectionner la source de signal d'entrée.

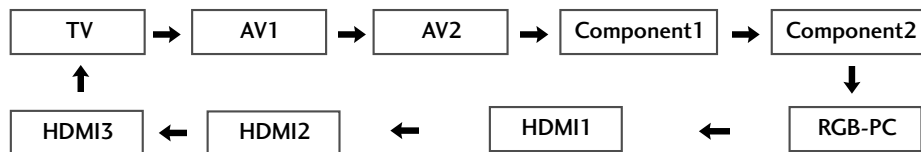

ie)

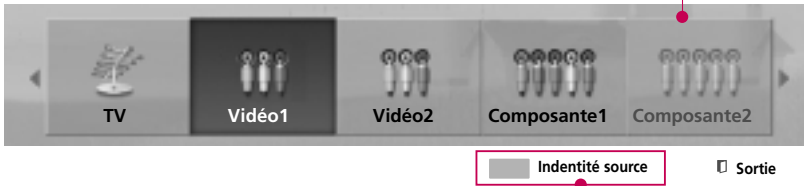

Les entrées déconnectées sont inactives.

Sélectionnez la source d'entrée qui convient (sauf TV). Ensuite, vous pouvez sélectionner une **Identité source** au moyen de la touche Bleue. ► p.50

c.-à-d.) Pour changer l'étiquette d'entrée en utilisant la touche bleue.

- Lorsqu'un nouvel appareil externe est branché à l'appareil, le menu contextuel suivant apparaît automatiquement.
- Lorsque vous sélectionnez **Oui**, vous pouvez choisir la source d'entrée que vous souhaitez utiliser.
- Par contre, lorsque vous sélectionnez "**SIMPLINK - Marche**" en mode HDMI, le même menu contextuel n'apparaît pas.

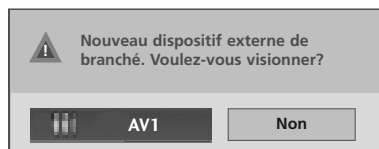







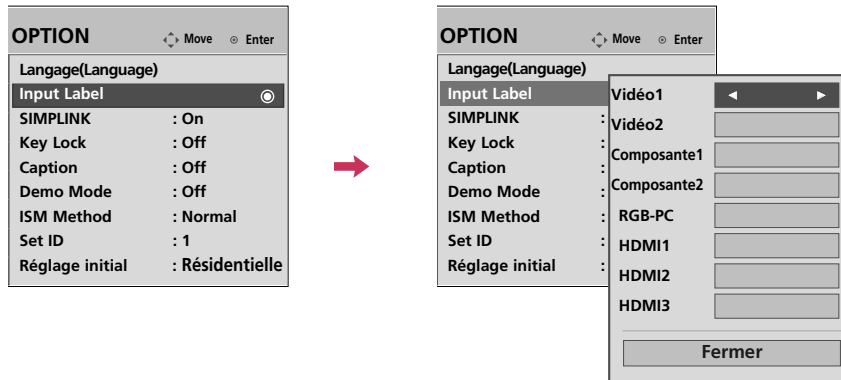

- **TV**: pour syntoniser les signaux de radiodiffusion terrestres, câble ou du câble d'une station.
- **Vidéo**: pour lire le signal d'un magnétoscope ou d'un autre appareil externe.
- **Composante**: pour regarder un DVD ou le signal d'un décodeur numérique.
- **RGB-PC**: pour visualiser le signal d'entrée du PC.
- **HDMI**: pour visualiser le signal provenant d'un appareil haute définition.

IDENTITÉ SOURCE







Ceci indique lequel dispositif est branché à laquelle prise d'entrée.



Au moyen du menu OPTION

-   Sélectionnez **OPTION**.
-   Sélectionnez **Identité source**.
-   Sélectionner la source.
-  Sélectionner l'identification appropriée.
-  Retourner au menu précédent.
-  Retourner à l'affichage télé.

Au moyen de la touche INPUT

-   Sélectionner la source (sauf **TV**).
-   Sélectionner l'identification appropriée.
-  Retourner au menu précédent.
-  Retourner à l'affichage télé.

MODE AV

Le Mode AV alterne entre les réglages pré-réglés vidéo et audio.

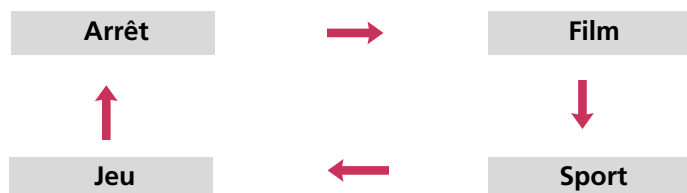

Appuyez plusieurs fois sur la touche **AV MODE** pour sélectionner la source.









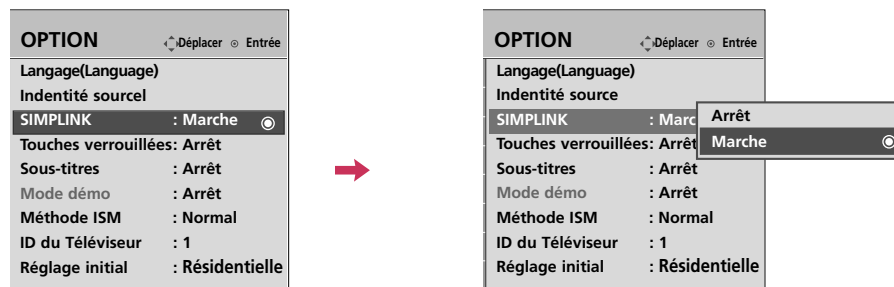

- L'option « **Film** » du mode audiovisuel (AV Mode) permet de choisir cette option à la fois dans le « menu IMAGE – Mode image » et dans le « Menu AUDIO – Mode audio ».
- Lorsque vous sélectionnez «**Arrêt**» en mode AV, l'image que vous aviez sélectionnée à l'origine sera rétablie.
- **Arrêt**: l'AV MODE.
- **Film** : Optimise la vidéo et l'acoustique pour regarder des films.
- **Sport** : Optimise la vidéo et l'acoustique pour regarder des manifestations sportives.
- **Jeu** : Optimise la vidéo et l'acoustique pour jouer.

VISIONNEMENT DE LA TÉLÉVISION / COMMANDE DES CHÂÎNES



SIMPLINK vous permet de commander et lire d'autres périphériques audio/vidéo par un câble HDMI, et sans câbles ni réglages supplémentaires. Ce téléviseur pourrait ne pas fonctionner avec les périphériques avec prise en charge HDMI-CEC, mais seuls les périphériques avec le logo SIMPLINK sont totalement pris en charge. SIMPLINK peut être activé ou désactivé par les menus utilisateurs.



-   Sélectionnez **OPTION**.
-   Sélectionnez **SIMPLINK**.
-   Sélectionnez **Marche** ou **Arrêt**.
-  Retourner au menu précédent.
-  Retourner à l'affichage télé.

! REMARQUE

- ▶ Branchez la borne HDMI/DVI IN ou HDMI IN du téléviseur sur la borne arrière (sortie HDMI) de l'appareil SIMPLINK à l'aide du câble HDMI.
- ▶ Lorsque vous changez de source d'entrée avec la touche INPUT de la télécommande, l'appareil SIMPLINK cessera de fonctionner.
- ▶ Lorsque vous sélectionnez un appareil cinéma maison, la sortie sonore est automatiquement relayée aux haut-parleurs dudit système cinéma maison.
- ▶ Si un cinéma maison SIMPLINK ne lit pas le signal audio du téléviseur auquel il est raccordé, branchez la sortie audio numérique (DIGITAL AUDIO OUT), située à l'arrière de l'appareil, à l'entrée audio numérique (DIGITAL AUDIO IN) de l'appareil SIMPLINK au moyen d'un câble optique.

Fonctions SIMPLINK

- **Lecture directe:** après avoir connecté les appareils audiovisuels au téléviseur, vous pouvez commander directement les appareils et la lecture de médias sans définir de paramètres supplémentaires.
- **Sélection de l'appareil audiovisuel:** vous permet de sélectionner l'un des appareils audiovisuels connecté au téléviseur.
- **Lecture de disque:** pour commander les appareils audiovisuels en appuyant sur les touches \wedge \vee \lt \gt , ENTER, \blacktriangleright , \blacksquare , II , \ll et \gg .
- **Mise hors tension de tous les appareils:** lorsque vous éteignez le téléviseur, tous les appareils connectés sont également éteints.
- **Basculement de la sortie audio:** procure un moyen facile pour changer la sortie audio.
- **Alimentation synchronisée:** Quand l'équipement avec la fonction Simplink est connecté à la prise HDMI commence à jouer, le téléviseur affiche ce mode automatiquement.

(Un appareil connecté au téléviseur par un câble HDMI mais qui n'est pas pris en charge par SIMPLINK n'offre pas cette fonction.)

Remarque: Pour le fonctionnement d'un lien simple, on peut utiliser le câble HDMI dans une version supérieure à 1.3 avec *CEC. (*CEC: Consumer Electronics Control).

1  Affichage du menu **SIMPLINK**.

2  Sélectionner l'appareil.

3  Permet de commander des appareils audiovisuels branchés au téléviseur.



Menu SIMPLINK

1 **Affichage télé:** Passe à la chaîne de télévision précédente peu importe le mode courant.

2 **Lecture de disque:** Permet de sélectionner et de lire des disques. Lorsque de multiples disques sont disponibles, les titres de disques s'affichent de façon pratique au bas de l'écran.

3 **Lecture de magnétoscope:** Permet de commander le magnétoscope branché au téléviseur.

4 **Lecture d'enregistrements sur disque dur:** Permet de lire des fichiers sur le disque dur.

5 **Sortie audio vers les haut-parleurs de cinéma maison/sortie audio vers le téléviseur:** Sélectionnez les haut-parleurs de cinéma maison ou du téléviseur pour la sortie audio.



► Lorsque aucun appareil n'est connecté (s'affiche en gris)

► Appareil sélectionné

► Lorsqu'un appareil est connecté (s'affiche en couleur vive)

USB - pour modèles 42/50PJ350, 50PK350, 50/60PK550, 42/50PJ550, 60PK290, 42/50PJ350C, 50/60PK550C

MODES D'ENTRÉE

Cet écran s'affiche automatiquement lorsque vous branchez un périphérique USB

En mode Périphérique USB, vous ne pouvez ajouter de nouveau dossier ou supprimer un dossier existant.

1 Branchez le périphérique USB dans les prises **USB IN** situées sur le côté du téléviseur.

- Les disques durs USB ne sont pas pris en charge.
- Ce téléviseur prend en charge les formats JPG et MP3.

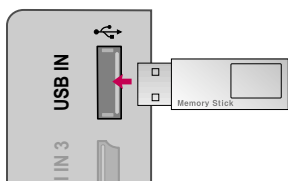

2 Sélectionnez **Liste photo** ou **Liste musique**.

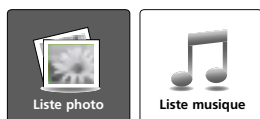

REMARQUE

- ▶ Afin d'éviter de perdre la clé-mémoire USB, utilisez un connecteur USB pour fixer la clé-mémoire USB à la prise USB du téléviseur.

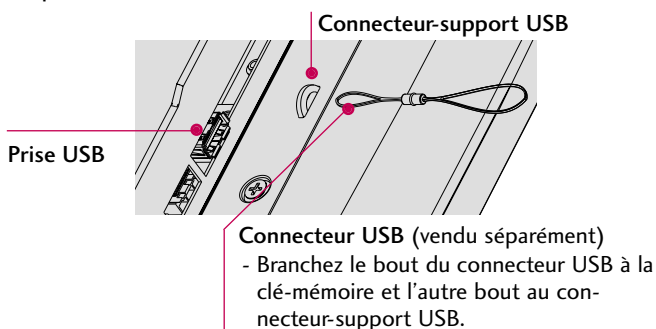

Au moment de retirer un périphérique USB

Sélectionnez le menu **Éjection USB** avant de retirer le périphérique USB.

- 1 Sélectionnez **Q.MENU** 2 Sélectionnez **ENTER** Select **Éjection**.

Mesures de sécurité concernant les périphériques USB

- ▶ Seuls les périphériques de stockage USB peuvent être reconnus.
- ▶ Si le périphérique de stockage USB est branché par l'entremise d'un concentrateur USB, le périphérique ne peut être reconnu.
- ▶ Un périphérique de stockage USB utilisant un programme de reconnaissance automatique peut ne pas être reconnu.
- ▶ Un périphérique de stockage USB utilisant son propre pilote peut ne pas être reconnu.
- ▶ Si vous utilisez un lecteur de carte, quatre cartes mémoire (maximum) peuvent être reconnues simultanément et l'appareil peut ne pas fonctionner correctement.
- ▶ La vitesse de reconnaissance d'un périphérique de stockage USB varie selon le périphérique utilisé.
- ▶ Veuillez ne pas mettre en marche le téléviseur ou débrancher le périphérique USB lorsque le périphérique de stockage USB branché à l'appareil est en fonction. Lorsqu'un périphérique similaire est retiré ou débranché, les fichiers stockés ou le périphérique de stockage USB peuvent être endommagés.
- ▶ Utilisez seulement un périphérique de stockage USB qui a les fichiers de musique ou d'images normaux.
- ▶ Veuillez n'utiliser qu'un périphérique de stockage USB ayant été formaté à l'aide du système de fichier FAT16, FAT32 ou NTFS fourni avec le système d'exploitation Windows. Tout périphérique de stockage formaté en tant que programme utilitaire non pris en charge par Windows ne pourra être reconnu.
- ▶ Veuillez brancher l'alimentation pour tout périphérique de stockage USB nécessitant une alimentation externe. Dans le cas contraire, le périphérique peut ne pas être reconnu.
- ▶ Veuillez brancher un périphérique de stockage USB à l'aide d'un câble certifié. Si le périphérique est branché à l'aide d'un câble non certifié ou excessivement long, il peut ne pas être reconnu.
- ▶ Quelques périphériques de stockage USB peuvent ne pas être pris en charge ou ne pas fonctionner correctement.
- ▶ Le téléviseur affichera jusqu'à 128 caractères des noms de fichiers.
- ▶ Veuillez effectuer une copie de sauvegarde des fichiers importants puisque certaines données présentes sur les périphériques USB peuvent être corrompues. La responsabilité de la gestion des données revient à l'utilisateur et, en conséquence, le fabricant ne couvrira pas les dommages causés aux données.
- ▶ La capacité recommandée est de 1 téraoctet ou moins pour un disque dur USB externe et de 32 gigaoctets ou moins pour une clé-mémoire USB.

LISTE PHOTO

Vous pouvez visualiser des fichiers JPG qui se trouvent sur un périphérique USB.

L'écran Affichage à l'écran (On Screen Display) de votre modèle de téléviseur peut être légèrement différent.

Format de fichiers photo pris en charge : *.JPG

- Vous pouvez uniquement lire des fichiers JPG.
- Seul le balayage en mode « baseline » est pris en charge sur JPG.

Composant de l'écran

1 Sélectionnez **USB**. 2 Sélectionnez **Liste photo**.

1 Permet de passer au répertoire de fichiers supérieur

2 Aperçu: affiche un aperçu et le nom du répertoire de la photo dans le répertoire sélectionné.

3 Page en cours/Pages totales

4 Nombre total de photos miniatures sélectionnées

5 Mémoire USB utilisable

6 Boutons correspondants de la télécommande





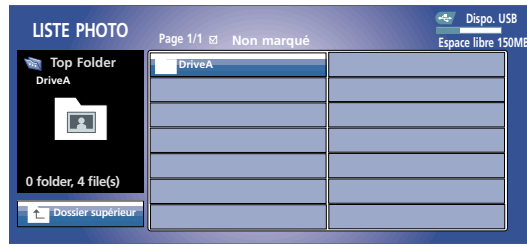

The diagram shows a TV screen displaying a 'LISTE PHOTO' interface. The screen is divided into several sections: a top header with 'LISTE PHOTO', 'Page 1/1', and 'Non marqué'; a left sidebar with 'Top Folder DriveA' and '0 folder, 4 file(s)'; a main area with a folder 'DriveA' and a list of files; and a bottom status bar with 'Dispo. USB' and 'Espace libre 150MB'. A navigation bar at the bottom contains buttons: 'Déplacer', 'Menu contextue', 'CH', 'Déplacer page', 'MARK Sélectionner', and 'Sortie'. Numbered callouts (1-6) point to specific elements: 1 points to the 'MENU' button and the 'Dossier supérieur' button; 2 points to the folder name 'DriveA'; 3 points to the page indicator 'Page 1/1'; 4 points to the number of files '4 file(s)'; 5 points to the 'Dispo. USB' indicator; 6 points to the bottom navigation bar.

Sélection de photo et menu contextuel



Lorsque vous sélectionnez un fichier (et non un répertoire), ce menu contextuel apparaît à l'écran.

- ▶ **Vue:** Affiche l'élément sélectionné.
- ▶ **Sélect.tous:** Sélectionne toutes les photos à l'écran.
- ▶ **Désélect.tous:** Désélectionner les photos sélectionnées.
- ▶ **Supprimer:** Supprime la photo sélectionnée.
- ▶ **Fermer:** Ferme le menu contextuel.

- 1  Sélectionner le répertoire ou le lecteur cible.
- 2   Sélectionner les photos.
- 3  Afficher le menu contextuel.
- 4   Sélectionner le menu contextuel.

- Utilisez les touches **CH** ^ v pour faire défiler la page de photos.
- Utilisez le bouton **MARK** pour sélectionner ou désélectionner une photo. Lorsqu'une ou plusieurs photos sont sélectionnées, vous pouvez afficher les photos individuellement ou un diaporama des photos sélectionnées. Si aucune photo n'est sélectionnée, vous pouvez afficher toutes les photos individuellement ou un diaporama de toutes les photos du dossier.

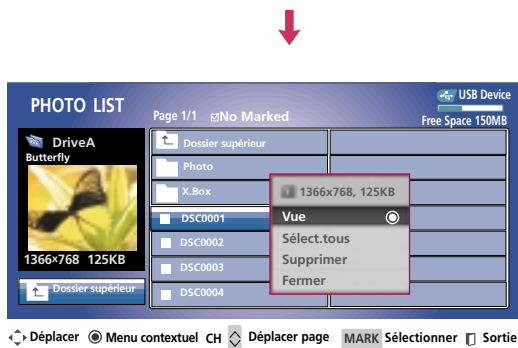
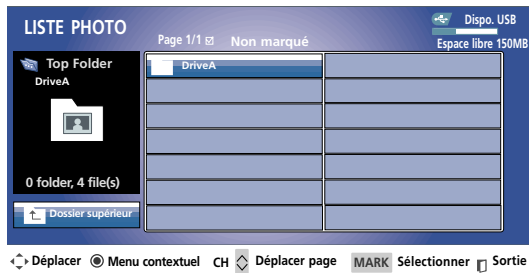

Menu Plein écran

Vous pouvez modifier l'affichage de la liste de photos pour qu'elle occupe tout l'écran du téléviseur. D'autres options sont offertes en mode plein écran.



L'allongement d'une photo peut changer la taille de la photo affichée sur l'écran dans normal.

- 1  Sélectionner le répertoire ou le lecteur cible.
- 2   Sélectionner les photos.
- 3  Afficher le menu contextuel.
- 4  Sélectionnez **Vue**.
- 5  La photo sélectionnée s'affiche en mode plein écran.

■ Utilisez les touches **CH**   pour faire défiler la page de photos.

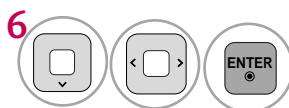

6 Sélectionnez **Diaporama**, **BGM**, **Rotation**, **Supprimer**, ou **Cacher**.

- Utilisez les boutons < > pour sélectionner la photo précédente ou suivante.
- Utilisez les boutons ^ v < > pour sélectionner et contrôler le menu en mode plein écran.

- ▶ **Diaporama**: Les photos sélectionnées sont affichées dans le diaporama. Si aucune image n'est sélectionnée, toutes les photos du répertoire sélectionné s'affichent dans le diaporama.
 - Réglez l'intervalle du diaporama à partir du menu **Option**.
- ▶ **BGM** : Écoutez de la musique alors que vous visionnez les photos en mode plein écran.
 - Réglez le dispositif de musique d'arrière-plan et l'album à partir du menu **Option**.
- ▶ **Rotation** : Fait pivoter les photos.
 - Permet de faire pivoter la photo de 90°, 180°, 270°, 360° dans le sens des aiguilles d'une montre.
- ▶ **Supprimer** : Supprimez les photos.
- ▶ **Cacher** : Masque le menu en mode plein écran.
 - Pour afficher le menu de nouveau en mode plein écran, appuyez sur le bouton **ENTER**.

! REMARQUE

- ▶ Ce téléviseur ne peut pas lire la plupart des images en format JPEG sauvegardées en mode progressif.

Utilisation de l'option liste photo

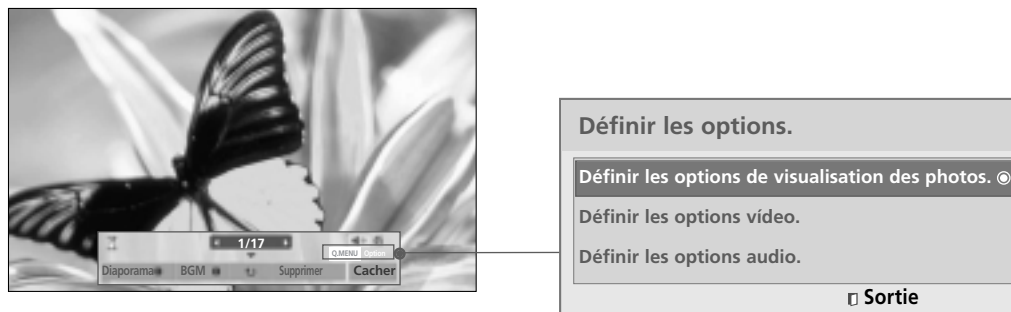

USB

1  Afficher le menu contextuel.



2   Sélectionnez **Définir les options de visualisation des photos**, **Définir les options vidéo** ou **Définir les options audio**.

► Lorsque vous sélectionnez l'option définir les options de visualisation des photos,

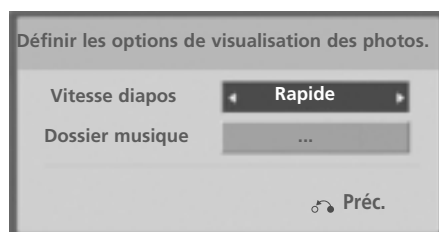
- Vous ne pouvez pas changer le dossier musique pendant que BGM est en lecture.





1   Affichage de la **vitesse diapos** ou du **dossier musique**.

2   Procéder aux réglages appropriés.

► Lorsque vous sélectionnez **Définir les options vidéo,**



1   Affichage du mode image.



2   Procéder aux réglages appropriés.

■ Le mode APS n'est pas supporté par la fonction réglage vidéo.

► Lorsque vous sélectionnez **Définir les options audio,**



1   Affichage de **mode audio, vol. normalisé, voix claires II** et de la **Équilibre.**

2   Procéder aux réglages appropriés.

LISTE MUSIQUE

Vous pouvez utiliser le menu « Liste de pistes (Music List) » pour lire des fichiers MP3 qui se trouvent sur un périphérique USB.

Ce téléviseur ne peut lire les fichiers protégés contre la copie.

L'écran Affichage à l'écran (On Screen Display) de votre modèle de téléviseur peut être légèrement différent.

Format de fichiers de musique pris en charge : *.MP3

Débit binaire 8Kbps ~ 320Kbps

- Fréquence d'échantillonnage (Fréquence d'échantillonnage)

MPEG1 Layer 3 : 8KHz ~ 48KHz

- Longueur maximum de musique : 999.59 Sec.

USB

Composant de l'écran

1   Sélectionnez **USB**.

2    Sélectionnez **Liste Musique**.

1 Permet de passer au répertoire de fichiers supérieur

2 Aperçu: Affiche le titre/le nom du fichier de la musique dans le dossier sélectionné

3 Page en cours/Pages totales

4 Nombre total de musique miniatures sélectionnées

5 Mémoire USB utilisable

6 Boutons correspondants de la télécommande



	Titre	Durée
	Dossier supérieur	
	Arirang	04:12
	Good Bye	05:30

Dispo. USB
Espace libre 150MB

00:00 / 04:16

Dossier supérieur





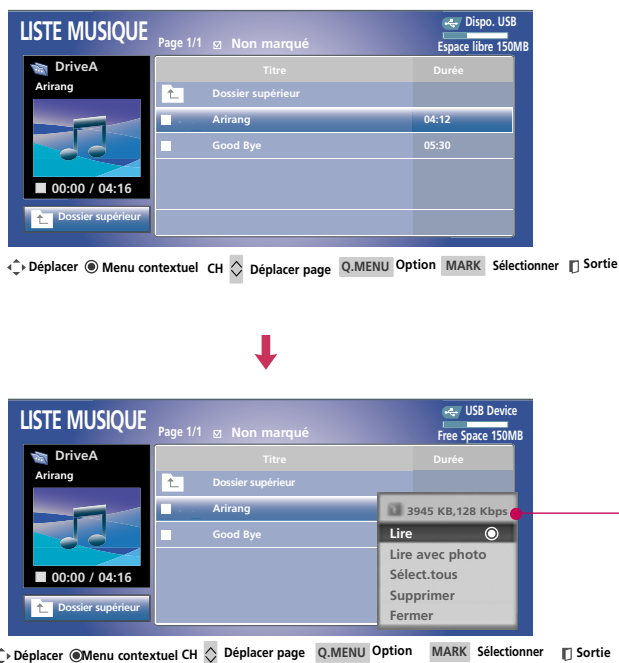

◀ Déplacer ◉ Menu contextuel CH ▶ Déplacer page Q.MENU Option MARK Sélectionner ▶ Sortie

Sélection de musique et menu contextuel

Jusqu'à 6 pistes sont affichées par page.





- ▶ **Lire** (pendant l'arrêt): Lit les pistes sélectionnées.
- Lorsque la lecture d'une piste se termine, la prochaine piste sélectionnée sera jouée. Si aucune piste n'est sélectionnée, la piste suivante du dossier en cours sera jouée. Si vous accédez à un autre dossier et appuyez sur le bouton **ENTER**, la lecture de la piste en cours sera interrompue.
- ▶ **Lire sélect.:** Lire les pistes sélectionnées. Une fois la lecture d'une piste terminée, la piste suivante joue automatiquement.
- ▶ **Arrêt la lecture** (pendant le playback): Arrêter le musics de jeu.
- ▶ **Lire avec photo:** Démarre la lecture des pistes sélectionnées, puis se déplace vers la liste de photos.
- ▶ **Sélect.tous:** Sélectionne toutes les pistes du dossier.
- ▶ **Désélect.tous:** Désélectionner les photos sélectionnées.
- ▶ **Supprimer:** Supprime les pistes sélectionnées.
- ▶ **Fermer:** Ferme le menu contextuel.

- 1  Sélectionner le répertoire ou le lecteur cible.
- 2   Sélectionner les pièces musicales désirées.
- 3  Afficher le menu contextuel.
- 4   Sélectionner le menu contextuel.
- 5  Retourner à l'affichage télé.

- Utilisez le bouton **CH** ^ v pour vous déplacer dans la page des titres musicaux.
- Utilisez le bouton **MARK** pour sélectionner ou désélectionner une piste. Si aucune piste n'est sélectionnée, tous les fichiers se trouvant dans le dossier seront joués consécutivement. Lorsqu'une ou plusieurs pistes sont sélectionnées, celles-ci sont lues de façon consécutive. Par exemple, si vous souhaitez écouter une seule piste à plusieurs reprises, sélectionnez simplement la piste en question et faites-en la lecture.

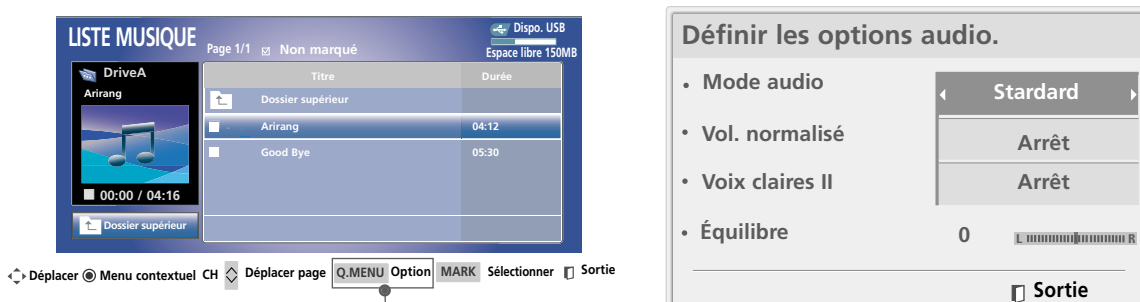
Utilisation de l'option liste Musique



1  Affichage du **mode audio**.

2  Procéder aux réglages appropriés.

- Si vous n'appuyez sur aucune touche, la boîte d'information de lecture (illustrée ci-dessous) se déplacera automatiquement dans l'écran pour éviter qu'une image fixe demeure trop longtemps à l'écran.



! REMARQUE

- ▶ Lors de la lecture d'une piste,  apparaît devant le temps de lecture.
- ▶ Une piste endommagée ou corrompue ne jouera pas et le temps de lecture 00:00 s'affichera à l'écran.
- ▶ Les fichiers protégés contre la copie ne joueront pas.
- ▶ Appuyez sur **ENTER**, **■** ou **RETURN** pour arrêter l'économiseur d'écran.
- ▶ Ce téléviseur ne lit pas les pistes de moins de 16 Ko.





COMMANDE DE L'IMAGE

COMMANDE DE LA TAILLE DE L'IMAGE (ALLONGEMENT)

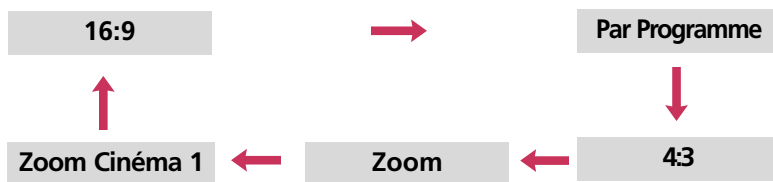
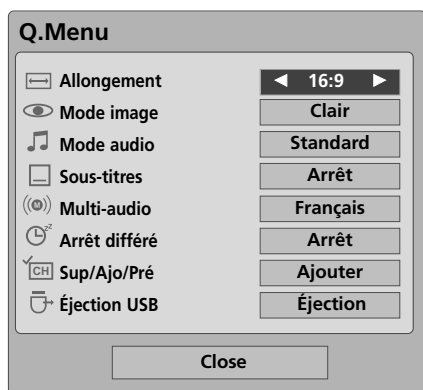
Cette fonctionnalité vous permet de choisir comment vous souhaitez qu'une image analogique 4:3 apparaisse à l'écran.

- À la source d'entrée RGB-PC, seule 4:3 et 16:9 sont disponibles.



- 1   Sélectionnez **Allongement**.
- 2  Sélectionner le format d'image désirée.
- 3  Retourner à l'affichage télé.

- Vous pouvez aussi appuyer la touche **RATIO** sur la télécommande répétitivement.

16:9

Choisir ce format pour régler une image horizontalement en proportion linéaire pour remplir l'écran..



Selon source

Habituellement, le recadrage des images est de 1 % à 2 %. La fonctionnalité Just Scan permet d'arrêter ce recadrage et d'afficher les images dans leur intégralité.

Remarque: Si des interférences sont présentes sur les bordures de l'image d'origine, elles seront visibles lorsque la fonctionnalité Just Scan est activée.

Cette fonctionnalité est disponible uniquement en mode DTV/CADTV/Composante/HDMI-DTV/DVI-DTV (720p/1080i/1080p).



Par Programme

Sélectionner la proportion appropriée pour correspondre à la source d'image.

(4:3 → 4:3)



(16:9 → 16:9)



4:3

Choisir ce format pour visionner une image avec le rapport d'origine.



Zoom

Choisir pour visionner une image sans altération. Toutefois les portions du haut et du bas sont coupées.

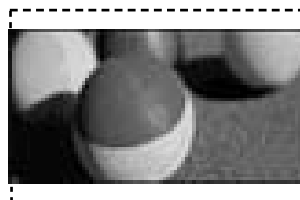

Zoom cinéma

Choisir pour agrandir l'image en proportion correcte. Remarque: en agrandissant ou rapetissant une image, elle peut devenir déformée.



■ La portée de réglage est de 1-16x.

COMMANDE DE L'IMAGE

ASSISTANT IMAGE

Cette fonction vous permet d'optimiser la qualité de l'image apparaissant à l'écran.

Utilisez l'**Assistant Image** afin de raffiner et calibrer la qualité d'image à l'écran en réglant le niveau noir, blanc, etc. Vous pouvez exécuter cette calibration en suivant les quelques simples étapes figurant à l'écran.

Des exemples de **Faible**, **Recommandé** ou **Élevé** vous guideront afin de faciliter la tâche en cours.

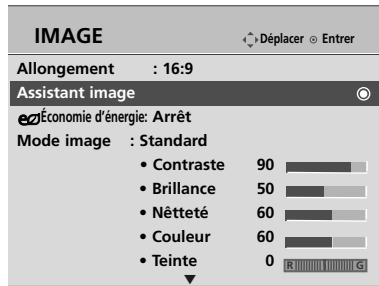



1   Sélectionnez **IMAGE**.

2    Sélectionnez **Assistant image**.



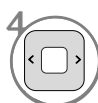

3  Procédez avec l'**Assistant image**.

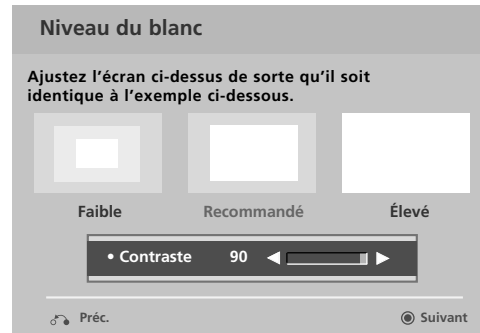

4   Réglez le **Niveau noir**.

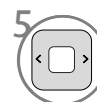

5   Réglez le **Niveau du blanc**.

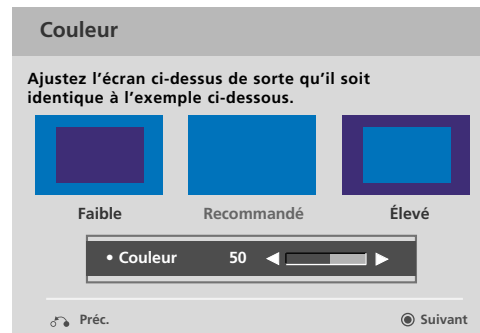

6   Réglez le **Couleur**.

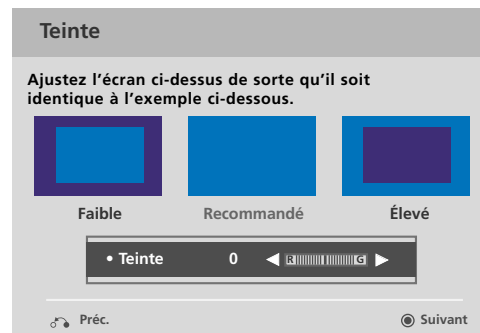

7   Réglez le **Teinte**.





8   Réglez la **Netteté horizontale**.



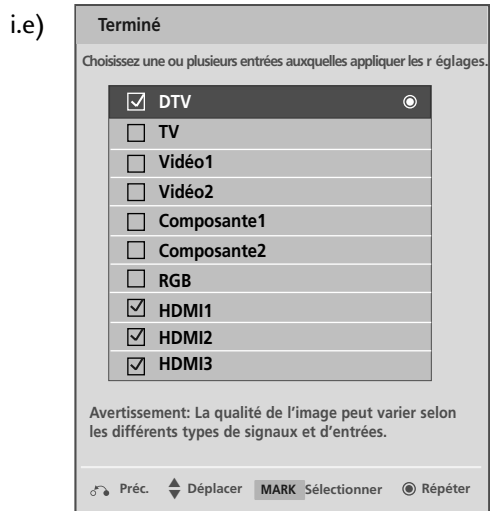

9   Réglez la **Netteté verticale**.

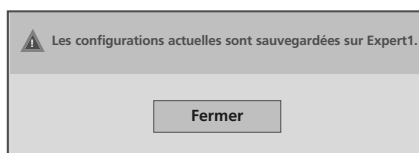

10   Choisissez la ou les source(s) d'entrée où y appliquer les réglages.

11  Sauvegarde.



12  Arrêtez la fonction Assistant image.

■ Si vous interrompez l'installation avant l'étape finale, les changements ne seront pas appliqués à la télévision.

COMMANDE DE L'IMAGE







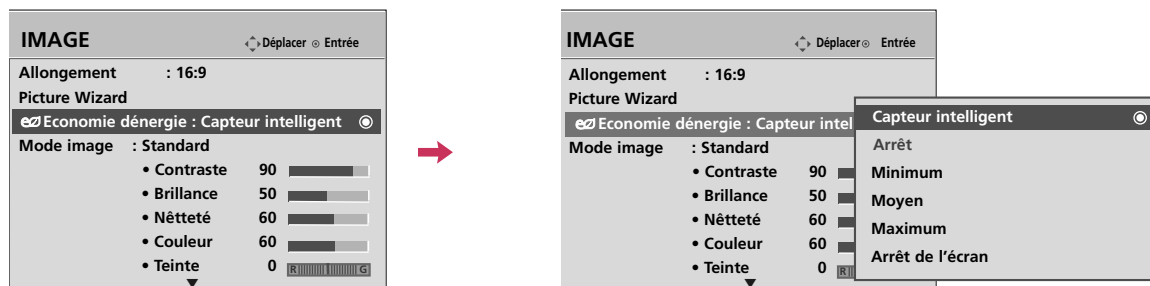

ÉCONOMIE D'ÉNERGIE

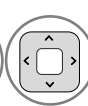
Réduit la consommation d'énergie de la télévision.

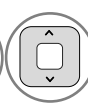
Vous pouvez accroître la luminosité de votre écran en réglant le niveau **Économique d'énergie** d'énergie ou en réglant le **Mode image**.

Cette fonction est désactivée sous "**Modo image-Film**".



-   Sélectionnez **IMAGE**.
-   Sélectionnez ** Économie d'énergie**.
-   Sélectionnez **Capteur intelligent**
Arrêt, Minimum, Moyen ou Maximum.
-  Retourner au menu précédent.
-  Retourner à l'affichage télé.

■ Vous pouvez aussi appuyer la touche **ENERGY SAVING** située sur la télécommande.

■ **Capteur intelligent?**

Cette fonction règle automatiquement la brillance de l'écran à l'image la plus appropriée selon les conditions ambiantes.

CONFIGURATION PRÉRÉGLÉE DES IMAGES (MODE IMAGE)

Vous pouvez choisir des réglages d'image effectués en usine dans les menus utilisateur. Vous pouvez choisir un réglage effectué en usine, le modifier manuellement.

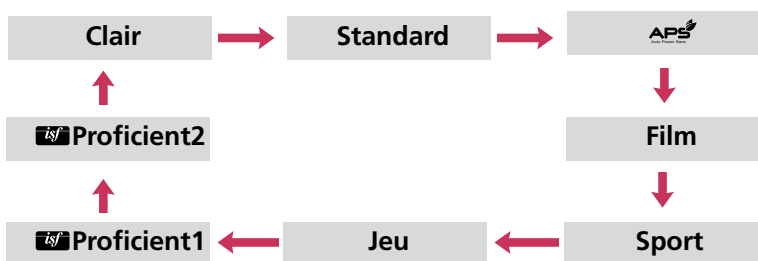
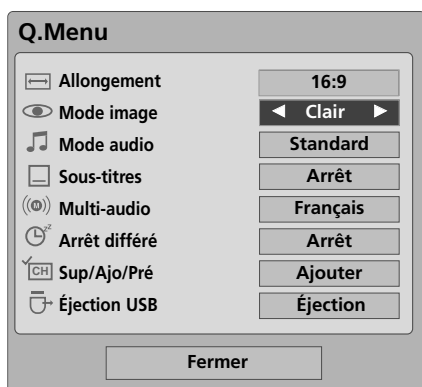

1   Sélectionnez **Mode image**.

2  Sélectionnez **Clair, Standard, APS, Film, Sport, Jeu, Proficient1** ou **Proficient2**.

3  Retourner à l'affichage télé.









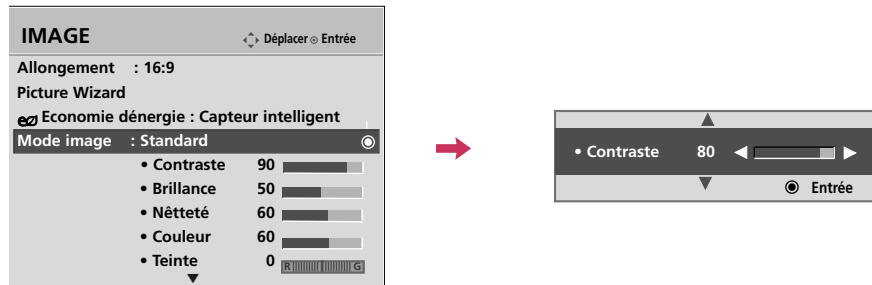



- **Clair, Standard, APS, Film, Sport, et Jeu** sont prédéterminés en usine pour une obtenir qualité d'image optimale, et ne peuvent pas être modifiés.
- L'on peut aussi **Mode image** le menu **IMAGE**.
- **Clair**: Ce mode maximise l'effet de la vidéo dans le magasin de détail. Renforce le contraste, l'éclat, la couleur et l'acuité pour une image vive.
- **APS** : Ce mode permet d'optimiser la réduction de la consommation électrique sans affecter la qualité de l'image.
- **Standard**: Ce mode garantit un visionnement optimal pour une utilisation standard.
- **Film** : Ce mode optimise la vidéo pour des films.
- **Sport** : C'est le mode vidéo qui optimise la vidéo dynamique et la couleur primaire (ex, blanc, uniforme, herbe, bleu ciel, etc.) en réalisant un écran optimal pour les sports.
- **Jeu**: Ce mode permet une vitesse de réponse rapide, dans un écran rapide de jeu.
- **Proficient**: c'est le mode pour ajuster la vidéo en détail pour l'expert vidéo et l'utilisateur général.

COMMANDE DE L'IMAGE

RÉGLAGE MANUEL DE L'IMAGE - MODE PERSONNEL

Règle l'apparence de l'image selon ses préférences et situations de visionnement.



-   Sélectionnez **IMAGE**.
-   Sélectionnez **Mode image**.
-   Sélectionnez **Clair, Standard, Film, Sport** ou **Jeu**.
-   Sélectionnez **Contraste, Brillance, Néteté, Couleur, Teinte** ou **Température couleur**.
-   Effectuez les réglages appropriés.
-  Retourner au menu précédent.
-  Retourner à l'affichage télé.









- **Contraste:** Accroît ou décroît le dégradé du signal vidéo. Régler lorsque les portions vives de l'image sont saturées.
- **Brillance:** Règle le niveau de base du signal vidéo dans l'image. Régler lorsque les portions sombres de l'image sont saturées.
- **Néteté:** Règle la définition du détail des bordures entre les portions sombres et pâles de l'image. Plus le niveau est bas, plus l'image est douce et plus il est élevé, plus l'image est rauque.
- **Couleur:** Ajuste l'intensité de toutes les couleurs.
- **Teinte:** Ajuste l'équilibre entre les niveaux rouges et verts.
- **Température couleur:** Régler à chaud afin d'intensifier les couleurs chaudes tel le rouge ou, régler à froid afin d'obtenir une image plus bleuâtre.

TECHNOLOGIE D'AMÉLIORATION DE L'IMAGE

Vous pouvez calibrer l'écran pour chaque mode d'image ou placer la valeur vidéo selon l'écran vidéo spécial. Vous pouvez régler la valeur vidéo différemment pour chaque entrée.

Pour réinitialiser au réglage d'usine après avoir effectué des réglages pour chaque source d'entrée, exécutez «Remise» pour chaque mode d'image.



-   Sélectionnez **IMAGE**.
-   Sélectionnez **Contrôle avancé**.
-   Sélectionnez les options désirées.
-  Effectuez les réglages appropriés.
-  Retourner au menu précédent.
-  Retourner à l'affichage télé.









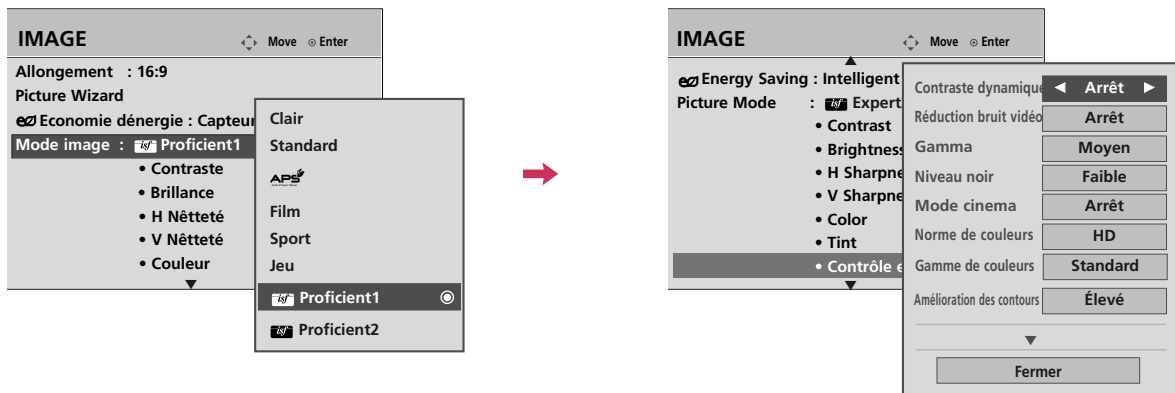



COMMANDE DE L'IMAGE

COMMANDE EXPERTE D'IMAGE

En segmentant les catégories, **Proficient1** et **Proficient2** procurent beaucoup plus de fins réglages aptes à être ajustés par les usagers à leur guise afin d'optimiser au maximum la performance visuelle du téléviseur.

Ces réglages, entre les mains d'un professionnel, vous assurera l'ultime optimisation de performance visuelle d'image pour le contexte ambiant où le téléviseur est installé.



-   Sélectionnez **IMAGE**.
-   Sélectionnez **Mode image**.
-   Sélectionnez **Proficient1**, ou **Proficient2**.
-   Sélectionnez **Contrôle expert**.
-   Sélectionnez l'option de menu désirée.
-  Effectuez les réglages appropriés.
-  Retourner au menu précédent.
-  Retourner à l'affichage télé.

Contraste dynamique	<ul style="list-style-type: none"> ■ Règle le contraste afin de le garder au meilleur niveau selon la brillance de l'écran. L'image se voit améliorée en rendant les portions claires plus vives et les portions foncées plus sombres.
Couleur dynamique	<ul style="list-style-type: none"> ■ Règle les couleurs à l'écran afin de les rendre plus vives, riches et claires. Cet attribut améliore la tonalité, saturation et luminance pour que le rouge, bleu, vert et blanc resplendissent de plus de vivacité.
Réduction bruit vidéo	<ul style="list-style-type: none"> ■ Réduit le bruit vidéo à l'écran sans compromettre la qualité du traitement vidéo.
Gamme	<p><i>Faible: rend les endroits de niveau gris moyen et foncé de l'image plus brillants.</i> <i>Moyen: respecte les niveaux originaux de l'image.</i> <i>Élevé: rend les endroits de niveau gris moyen et foncé de l'image plus sombres.</i></p> <ul style="list-style-type: none"> ■ Vous pouvez régler la brillance des endroits à niveau gris moyen et foncé de l'image.
Niveau noir	<ul style="list-style-type: none"> ■ <i>Faible: le reflet de l'écran s'assombrit.</i> ■ <i>Élevé: le reflet de l'écran s'éclaircit.</i> ■ <i>Auto: se règle automatiquement en fonction de ce qui apparaît à l'écran.</i> ■ Règle le niveau noir de l'écran au niveau approprié. ■ Cet attribut permet de sélectionner "Faible" ou "Élevé" dans les modes suivant: AV (NTSC), HDMI ou composante. Autrement, il se limite à "Auto".
Mode cinema	<ul style="list-style-type: none"> ■ Rend les clips vidéo enregistrés en mode "film" beaucoup plus naturel en éliminant les effets de trépidation. ■ Les films DVD et Blu-Ray sont filmés à 24 images par seconde.
Gamme de couleurs	<p><i>Standard: affiche une surface de couleurs normale.</i> <i>Étendue: mode conçu à amplifier la richesse des couleurs à l'écran dans les endroits édatants.</i></p> <ul style="list-style-type: none"> ■ Optimise l'utilisation des couleurs afin d'accroître la qualité des couleurs.
Amélioration des contours	<ul style="list-style-type: none"> ■ Reproduit les coins dans l'image plus clairement et distinctivement tout en conservant une allure naturelle.
Norme de couleurs	<ul style="list-style-type: none"> ■ Convertit la palette de couleurs d'un signal vidéo différent aux couleurs HD.
Équilibre niveau blanc	<ul style="list-style-type: none"> ■ Cette fonction sert à régler les couleurs à l'écran en général de façon à vous plaire. <ul style="list-style-type: none"> a. Méthode : 2 Points <ul style="list-style-type: none"> - Tracé: Intérieur, Extérieur - Contraste rouge/verte/bleue, Brillance rouge/verte/bleue: La portée du réglage est de -50 à +50. b. Méthode : 20 Point IRE <ul style="list-style-type: none"> - Tracé: Intérieur, Extérieur - IRE (institut des ingénieurs radio) est l'unité qui indique la taille du signal vidéo ; elle peut être réglée sur 5, 10, 15 - 95, 100. Vous pouvez régler les couleurs rouge, vert et bleu selon chaque intensité. - rouge/verte/bleue: La portée du réglage est de -50 à +50.
Système gérance des couleurs	<ul style="list-style-type: none"> ■ Étant l'outil principal utilisé par les calibreurs professionnels, il sert à régler les 3 couleurs primaires (rouge/vert/bleue) et les 3 couleurs secondaires (jaune/cyan/magenta) individuellement l'une de l'autre. La différence de couleur risque ne pas se distinguer même en effectuant les réglages vidéo en général. Ajustez rouge/verte/bleue/jaune/cyan, magenta. <ul style="list-style-type: none"> - Contraste rouge/verte/bleue/jaune/cyan, magenta: La portée du réglage est de -30 à +30. - Teinte rouge/verte/bleue/jaune/cyan, magenta : La portée du réglage est de -30 à +30. - Fonction inactive en mode RGB-PC et HDMI-PC.

COMMANDE DE L'IMAGE

RÉINITIALISATION DE L'IMAGE

Les réglages des modes image sélectionnés retournent aux valeurs par défaut.

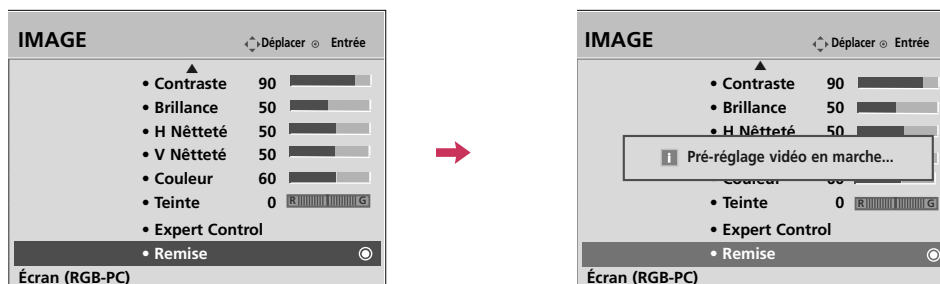

1 Sélectionnez **IMAGE**.

2 Sélectionnez **Remise**.

3 Initialiser la valeur réglée.

4 Retourner à l'affichage télé.

MODE DÉMO

Affiche un diaporama qui explique les différentes fonctions de cette télévision.

- Cette fonction est désactivée sous "Réglage initial-Résidentielle".

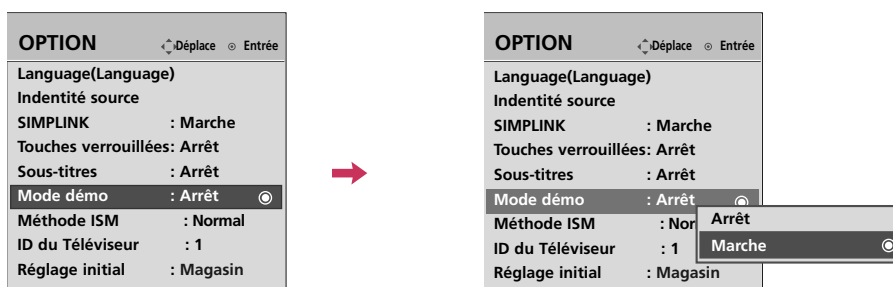

1 Sélectionnez **OPTION**.

2 Sélectionnez **Mode démo**.

3 Sélectionnez **Marche**.

4 Retourner à l'affichage télé.

Après quelques instants, le **Mode démo**.
Si vous voulez arrêter la démo, appuyez sur n'importe quelle touche.(sauf VOL ou MUTE)







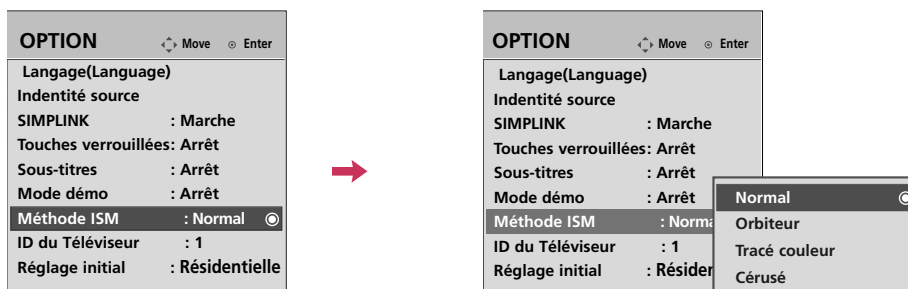

5 Afficher les différentes fonctions de la télévision.

6 Affiche les différentes fonctionnalités du moteur XD.

MÉTHODE ISM (MINIMISATION D'INCRUSTATION D'IMAGE)

Une image figée d'un à l'écran pendant de longues périodes peut causer une image-fantôme; même si l'on change d'image. Vous pouvez faire appel à l'Orbiteur pour éviter la rémanence de l'image. Les deux autres fonctions servent à effacer une image fantôme.



-   Sélectionnez **OPTION**.
-   Sélectionnez **Méthode ISM**.
-   Sélectionnez **Normal, Orbiteur, Tracé couleur** ou **Cérusé**.
-  Retourner au menu précédent.
-  Retourner à l'affichage télé.

- **Normal:** Si le collage d'image n'est pas un problème, ISM n'est pas nécessaire régler à normal.
- **Orbiteur:** Peut aider à prévenir les images-fantômes. Toutefois, il est préférable de ne pas laisser une image fixe demeurer à l'écran. Pour éviter cela, l'image se déplace toutes les 2 minutes.
- **Tracé couleur:** Le bloc de couleur avec l'écran s'est déplacé un peu et le motif blanc s'affiche alternativement. Il est difficile de voir l'image suivante avec toutes les couleurs. Une fois que ceci a été corrigé il ne sera pas visible dans aucune couleur.
- **Cérusé:** Pour enlever les images permanentes à l'écran.
Utiliser cette fonction modérément. Regardez la télé comme à l'habitude pendant un certain temps avant d'utiliser cette fonction pour vérifier si l'image-fantôme disparaît d'elle-même.

REMARQUE

- Une image permanente excessive peut être impossible à effacer entièrement avec le blanc. Pour reprendre le visionnement normal, presser toute touche.









COMMANDE DU SON ET DE LA LANGUE

CONTRÔLE AUTOMATIQUE DU VOLUME (VOL.NORMALISÉ)

S'assure que le volume demeure constant soit lors d'une publicité ou de retour à l'émission.

Puisque chaque station émettrice a ses propres signaux, l'ajustement de volume peut être nécessaire à chaque fois que vous changez de chaîne. Ce dispositif vous permet de profiter d'un volume stable en faisant des ajustements automatiques pour chaque programme.



-   Sélectionnez **AUDIO**.
-   Sélectionnez **Vol.normalisé**.
-   Sélectionnez **Marche** ou **Arrêt**.
-  Retourner au menu précédent.
-  Retourner à l'affichage télé.





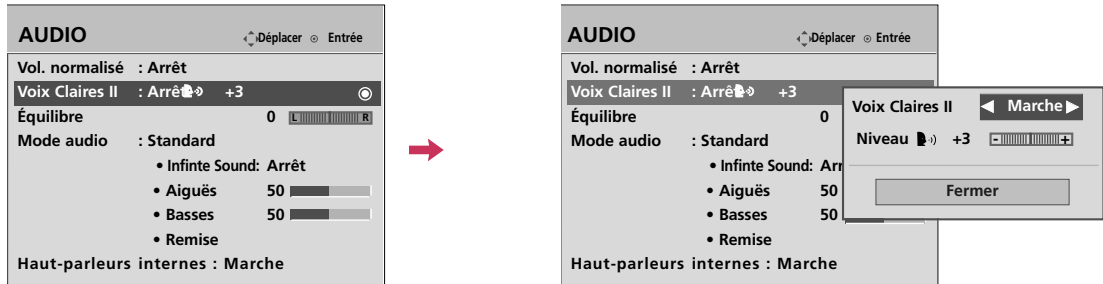



VOIX CLAIRES II

En différenciant la voix humaine des autres sons, les voix humaines ressortent mieux.



- 1   Sélectionnez **AUDIO**.
- 2   Sélectionnez **Voix claires II**.
- 3   Sélectionnez **Marche** ou **Arrêt**.

Réglage du niveau voix claires II lors de la mise en marche.

- 4   Sélectionnez **Voix claires II**.
- 5   Sélectionnez **Niveau**.
- 6   Effectuez les réglages appropriés.
- 7  Retourner au menu précédent.
-  Retourner à l'affichage télé.

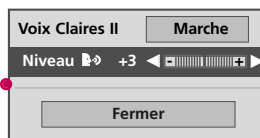



COMMANDE DU SON ET DE LA LANGUE

CONFIGURATION PRÉRÉGLÉE DU SON (MODE AUDIO)

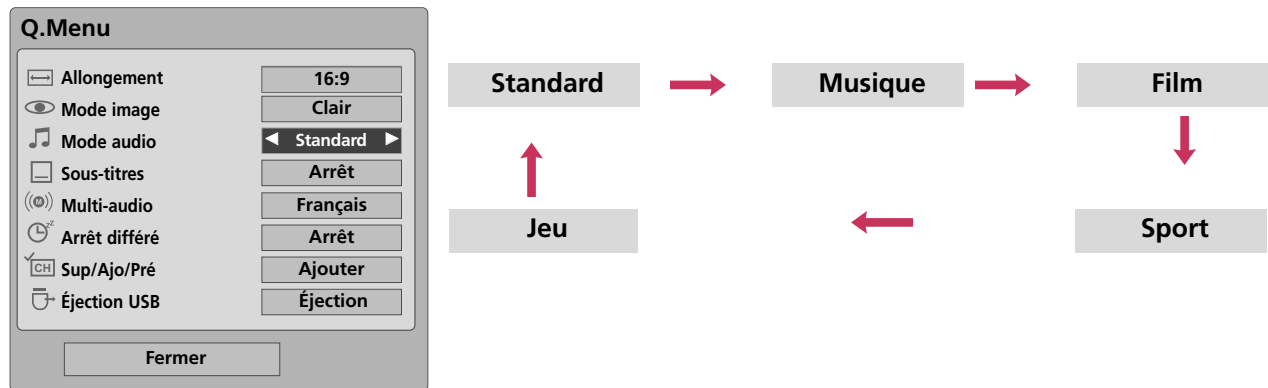
Balaie les changements de sonorité pendant les publicités, puis règle le niveau sonore pour correspondre au niveau audio spécifié.



-   Sélectionnez **Mode audio**.
-  Sélectionnez **Standard, Musique, Film, Sport** ou **Jeu**.
-  Retourner à l'affichage télé.

- **Standard, Music, Cinema, Sport, and Game** are preset for optimum sound quality at the factory.
- L'on peut aussi **Mode audio** le menu **AUDIO**.
- **Standard**: Offre un son de qualité standard.
- **Musique**: Optimise le son pour écouter de la musique.
- **Film**: Optimise le son pour regarder des films.
- **Sport**: Optimise le son pour des manifestations sportives.
- **Jeu**: Optimise le son pour les jeux.

RÉGLAGES DU SON - MODE PERSONNEL

Règle le son selon ses préférences et l'emplacement de la pièce.

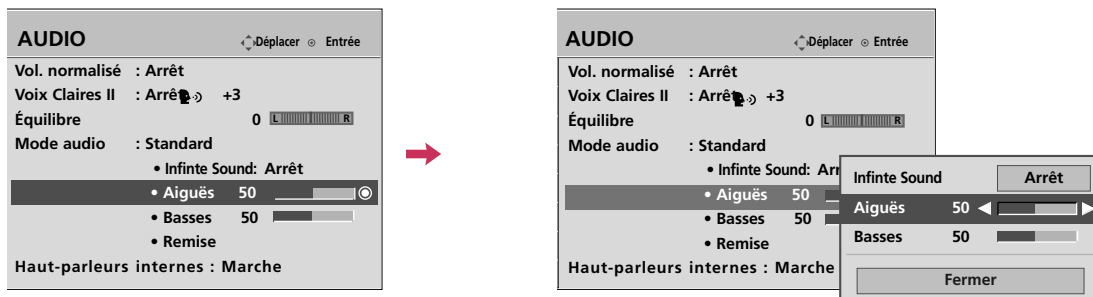





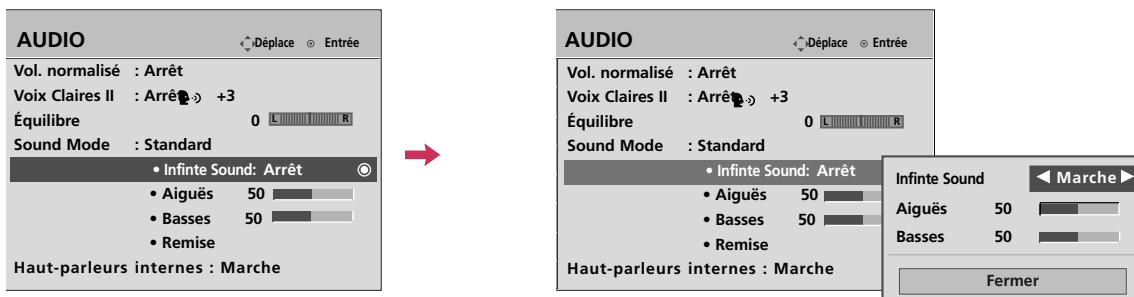

-   Sélectionnez **AUDIO**.
-   Sélectionnez **Mode audio**.
-   Sélectionnez **Standard, Musique, Film, Sport ou Jeu**.
-   Sélectionnez **Aiguës** ou **Basses**.
-   Effectuez les réglages appropriés.
-  Retourner au menu précédent.
-  Retourner à l'affichage télé.

COMMANDE DU SON ET DE LA LANGUE

INFINITE SOUND

Choisir cette option pour un son réaliste.











- 1   Sélectionnez **AUDIO**.
- 2   Sélectionnez **Infinite Sound**.
- 3   Sélectionnez **Marche** ou **Arrêt**.
- 4  Retourner au menu précédent.
-  Retourner à l'affichage télé.

■ Si vous sélectionnez « Clear Voice II-On » (Activation de la fonction « Voix Claires II »), la fonctionnalité Infinite Sound ne pourra pas être activée.

ÉQUILIBRE

Réglez le son du haut-parleur gauche/droit en fonction de vos préférences et de la disposition de la pièce.



-   Sélectionnez **AUDIO**.
-   Sélectionnez **Équilibre**.
-   Effectuez les réglages appropriés.
-  Retourner au menu précédent.
-  Retourner à l'affichage télé.

COMMANDE DU SON ET DE LA LANGUE

RÉGLAGE MARCHE-ARRÊT DES HAUT - PARLEURS DU TÉLÉVISEUR

Met les haut-parleurs du téléviseur hors circuit si l'on utilise un équipement audio externe.

Dans le cas d'une connexion AV, Composite, RGB et HDMI avec un câble HDMI vers DVI, le haut-parleur du téléviseur peut fonctionner même en l'absence de signal vidéo.





-   Sélectionnez **AUDIO**.
-   Sélectionnez **Haut-parleurs internes**.
-   Sélectionnez **Marche** ou **Arrêt**.
-  Retourner au menu précédent.
-  Retourner à l'affichage télé.

RÉINITIALISATION DU MODE AUDIO

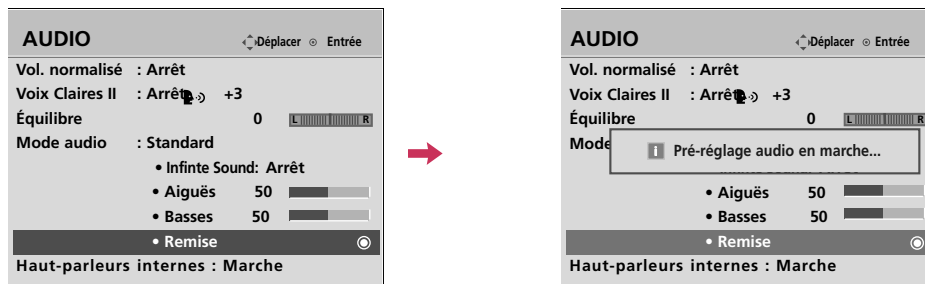
Les réglages du mode audio sélectionnés retournent aux valeurs par défaut.



- 1   Sélectionnez **AUDIO**.
- 2   Sélectionnez **Remise**.
- 3  Initialiser la valeur réglée.
- 4  Retourner à l'affichage télé.



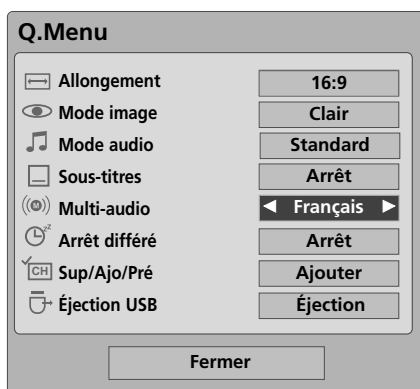

COMMANDE DU SON ET DE LA LANGUE

RÉGLAGE DIFFUSIONS STÉRÉO/SAP





Signal analogique uniquement: ce téléviseur peut recevoir les programmes stéréo MTS et tout SAP (Secondary Audio Program) accompagnant un programme stéréo, si la station transmet un signal audio additionnel. Le son mono est utilisé automatiquement si le signal n'est émis qu'en mode mono.



Téléviseur analogique

-   Sélectionnez **SAP**.
-  Sélectionnez **Mono, Stereo** ou **SAP**.
-  Retourner à l'affichage télé.









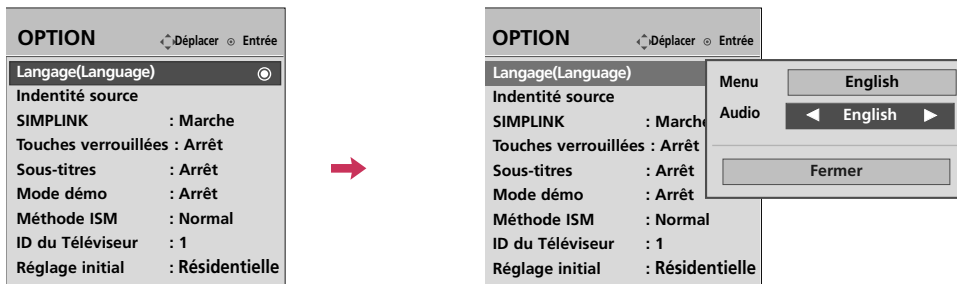

Téléviseur numérique

-   Sélectionnez **Multi-audio**.
-  Sélectionner d'autres langues.
-  Retourner à l'affichage télé.

LANGAGE AUDIO

D'autres langues sont disponibles si un signal numérique est fourni par le diffuseur.
Cette fonctionnalité est disponible uniquement en mode DTV/CADTV.











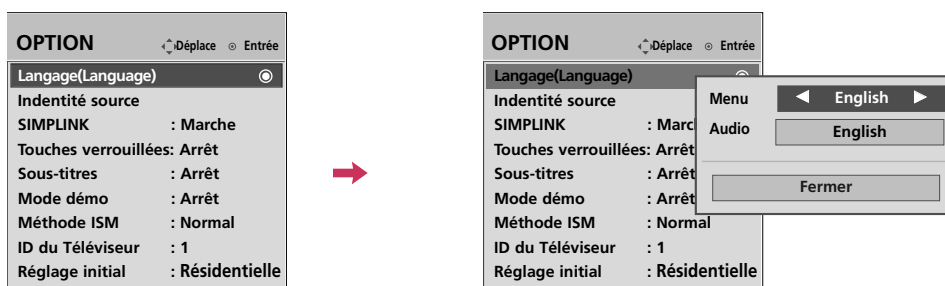

-   Sélectionnez **OPTION**.
-   Sélectionnez **Langage(Language)**.
-   Sélectionnez **Audio**
-   Sélectionner la langue désirée.
-  Retourner au menu précédent.
-  Retourner à l'affichage télé.

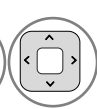
COMMANDE DU SON ET DE LA LANGUE

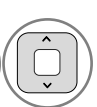
SÉLECTION DE LANGUE POUR LES MENUS À L'ÉCRAN

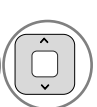
Les menus peuvent figurer dans la langue choisie.

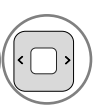









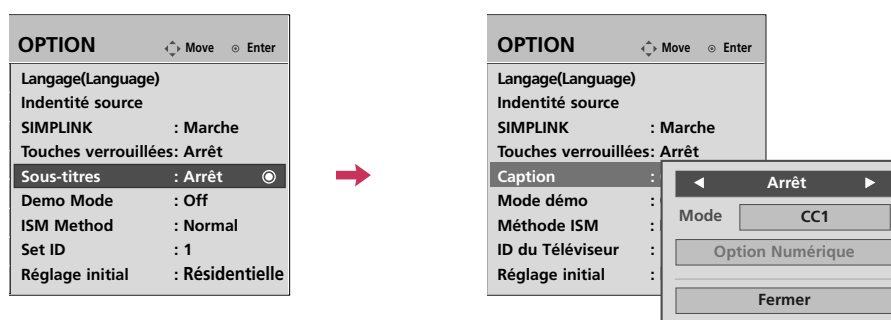

-   Sélectionnez **OPTION**.
-   Sélectionnez **Langage(Language)**.
-   Sélectionnez **Menu**
-   Sélectionner la langue désirée.
À partir de ce point les menus à l'écran fig-
urent dans la langue choisie.
-  Retourner au menu précédent.
-  Retourner à l'affichage télé.

SOUS-TITRES

Sous-titres à système de diffusion analogique

Les sous-titres permettent aux gens souffrant de déficience auditive de regarder la télé. Sélectionner un mode sous-titres pour afficher l'information fournie par le programme. Les sous-titres analogiques donnent l'information à toute position à l'écran, habituellement le dialogue. Les sous-titres/texte, si fournis par le télédiffuseur, seraient offerts pour les canaux numériques et analogiques, sur la source antenne/câble. Ce téléviseur est programmé pour se rappeler le mode sous-titres/ texte réglé au moment de la mise hors circuit. Cette fonction n'est disponible que lorsque le mode **Sous-titres** est **Marche**.



-   Sélectionnez **OPTION**.
-   Sélectionnez **Sous-titres**.
-   Sélectionnez **Marche**.
-   Sélectionnez **CC1-4** ou **Text1-4**.
-  Retourner au menu précédent.
-  Retourner à l'affichage télé.

- Lorsque **Arrêt** est sélectionné, les sous-menus des options Analog Analogique, DTV et Numérique sont désactivés.
- **Sous-titres**
Il s'agit des mots qui défilent au bas de l'écran, habituellement la portion audio d'un programme pour malentendants.
- **Texte**
Il s'agit de mots qui défilent dans un grand cadre noir couvrant presque tout l'écran, habituellement des messages fournis par le diffuseur.

COMMANDE DU SON ET DE LA LANGUE

Sous-titres à système de diffusion numérique

Choisir la langue désirée pour les sous-titres DTV/CADTV.

D'autres langues peuvent être choisies pour des sources numériques seulement si elles sont incluses sur le programme.

Cette fonction n'est disponible que lorsque le mode **Sous-titres** est **Marche**.

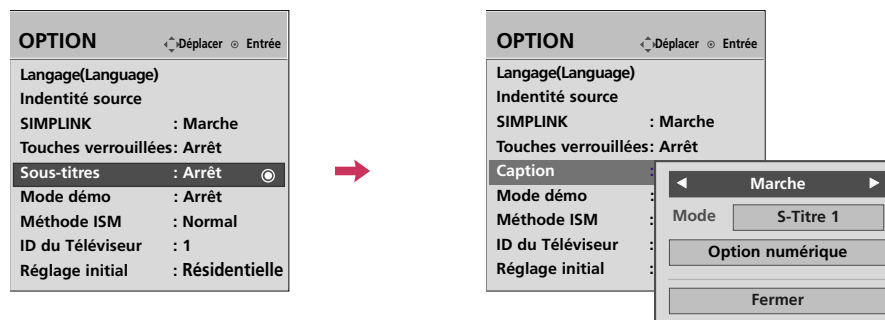



-   Sélectionnez **OPTION**.
-   Sélectionnez **Sous-titres**.
-   Sélectionnez **Marche**.
-   Sélectionnez **S-Titre1-4** ou **Texte1-4**.
-  Retourner au menu précédent.
-  Retourner à l'affichage télé.

Option sous-titres

Pour personnaliser les sous-titres DTV/CADTV figurant à l'écran.

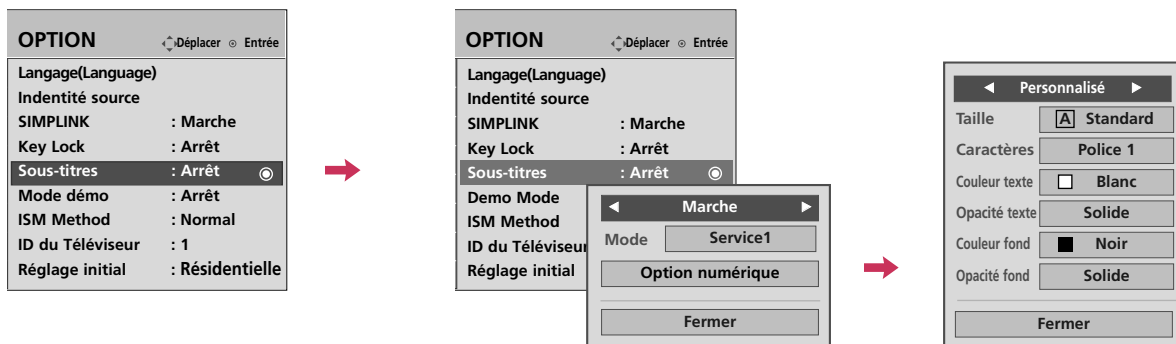
Cette fonction n'est disponible que lorsque le mode **Sous-titres** est **Marche**.



- 1   Sélectionnez **OPTION**.
- 2   Sélectionnez **Sous-titres**.
- 3   Sélectionnez **Marche**.
- 4  Sélectionnez **Option numérique**.
- 5   Sélectionnez **Personnalisé**.
- 6   Personnaliser les options **Taille**, **Caractères**, etc., to your preference. Un icône aperçu figure au bas de l'écran, l'utiliser pour voir les sous-titres.
- 7  Retourner au menu précédent.
-  Retourner à l'affichage télé.

- **Taille** : Règle la grosseur des mots figurant.
- **Caractères**: Sélectionne le type des mots.
- **Couleur texte** : Pour choisir la couleur du texte.
- **Opacité texte**: Spécifier l'opacité pour la couleur du texte.
- **Couleur fond** : Pour choisir la couleur du fond.
- **Opacité fond** : Pour choisir l'opacité du fond.

RÉGLAGE DE L'HEURE

RÉGLAGE DE LA PENDULE









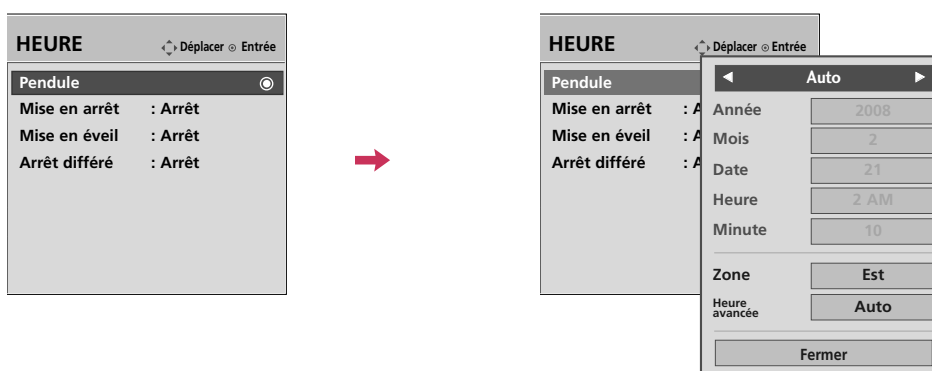



Réglage automatique

L'heure est réglée automatiquement depuis un signal de canal numérique.

Le signal de canal numérique comprend l'information pour l'heure en cours fournie par le diffuseur.

Régler la pendule manuellement, si l'heure est incorrecte.









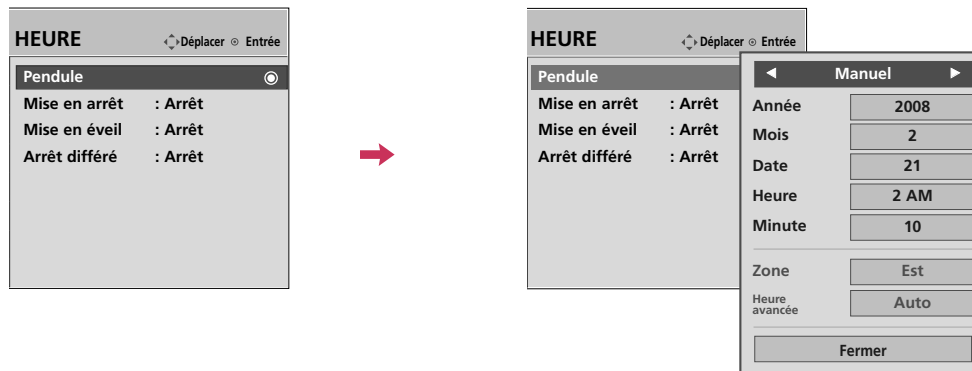



-   Sélectionnez **HEURE**.
-   Sélectionnez **Pendule**.
-   Sélectionnez **Auto**.
-   Sélectionner votre fuseau horaire.
 - États-Unis: **Est, Centrale, Rocheuses, Pacifique, Alaska** ou **Hawaii**.
 - Canada: **Est, Centrale, Rocheuses, Pacifique, Maritime** ou **Atlantique**.
-   Sélectionnez **Auto**, **Arrêt**, ou **Marche** si votre pays est soumis au passage à l'heure d'été.
-  Retourner au menu précédent.
-  Retourner à l'affichage télé.

Réglage manuel

Si l'heure en cours est erronée, régler manuellement.



-   Sélectionnez **HEURE**.
-   Sélectionnez **Pendule**.
-   Sélectionnez **Manuel**.
-  Sélectionner l'option Année, mois, date, heure et minutes.
-  Régler l'option Année, mois, date, heure et minutes.
-  Retourner au menu précédent.
-  Retourner à l'affichage télé.

► Si la télévision est débranchée ou est éteinte avec coupez l'alimentation secteur, la fonction du pendule est remise à zéro.

RÉGLAGE DE L'HEURE

RÉGLAGE DE LA MINUTERIE

Mise en marche/arrêt automatique

Fonctionne seulement si l'heure est réglée.

Minuterie arrêt outrepassé minuterie marche si elles sont réglées à la même heure.

Le téléviseur doit être en mode attente pour que la minuterie marche fonctionne.



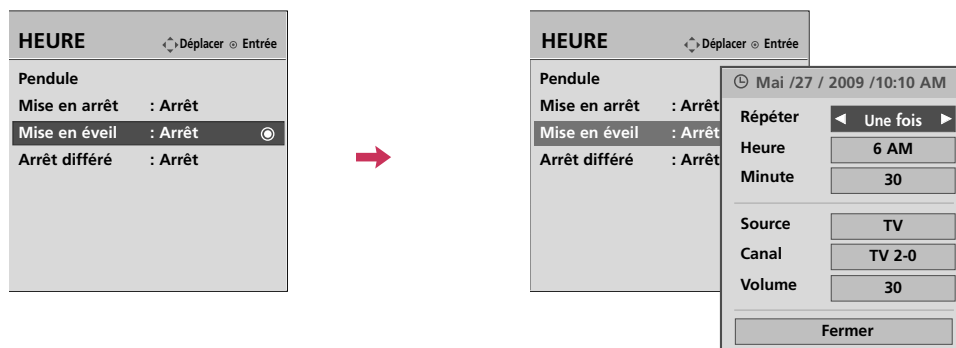

Si aucune touche n'est pressée dans un délai de 2 heures une fois le téléviseur mis en circuit avec la minuterie marche, le téléviseur revient automatiquement au mode attente.

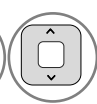

-   Sélectionnez **HEURE**.
-   Sélectionnez **Mise en arrêt** ou **Mise en éveil**.
-   Sélectionnez **Répéter**.
-  Sélectionnez **Arrêt, Une fois, Quotidien, Lun.~Ven., Lun.~Sam., Week-end** ou **Dimanche**.
-   Sélectionner et Régler **Heure** ou **Minute**.
-  Retourner au menu précédent.
-  Retourner à l'affichage télé.

- Pour annuler **Mise en arrêt / éveil** fonction, choisir **Arrêt**.

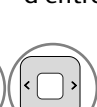
- Pour la fonction Mise en éveil seulement

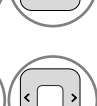
-   Sélectionnez **Source**.
-  Sélectionner la source de signal d'entrée.
-   Lorsque **TV** est sélectionné: régler pour choisir le canal à syntoniser
-   Régler pour régler le niveau sonore à la mise en circuit.

Arrêt différé

Pour mettre le téléviseur hors circuit à une heure donnée.

Il est à noter que ce réglage est annulé lorsque le téléviseur est mis en circuit.

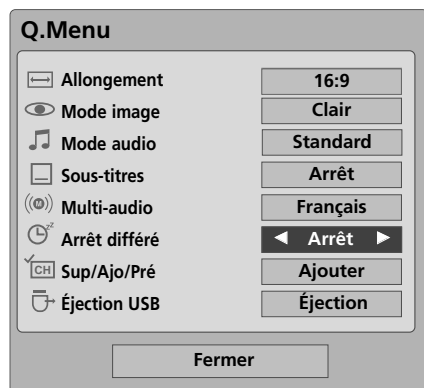

1   Sélectionnez **Arrêt différé**.

2  Sélectionnez **Arrêt, 10, 20, 30, 60, 90, 120, 180 ou 240** minutes.

3  Retourner à l'affichage télé.

■ L'on peut aussi **Arrêt différé** le menu **HEURE**.

COMMANDE PARENTALE / CLASSEMENT

Le contrôle parental peut être utilisé pour verrouiller canaux, cotes et autres sources de visionnement.

Défaut permet tout programme. Le visionnement peut être bloqué par type de programme et par catégories choisies. Il est aussi possible de bloquer tout visionnement pour une période donnée. Pour utiliser cette fonction, il faut faire ce qui suit :

1. Régler les codes et catégories à bloquer.
2. Spécifier un mot de passe
3. Activer le verrouillage

Cote puce V et catégories

Les directives sont fournies par les diffuseurs. La plupart des programmes télé et des films peuvent être bloqués par cote télé et/ou catégories individuelles. Les films qui ont été diffusés au cinéma ou directement sur vidéo utilisent le système de cote de film (MPAA) seulement.

Classifications pour les programmes de télévision y compris les téléfilms:

- TV-G (Tout public)
- TV-PG (Avis Parental Souhaité)
- TV-14 (Avis Parental Exigé)
- TV-MA (Adultes)
- TV-Y (Pour enfants)
- TV-Y7 (Interdit aux moins de 7 ans)

SYTÈME DE RÉGLAGE DE MOT DE PASSE ET VERROUILLAGE

Réglage de votre code d'accès

Configurez vos options de blocage pour bloquer certaines chaînes, classifications et sources externes de lecture. Un code d'accès est exigé pour accéder à ce menu.



1    Sélectionnez **VÉRROUILLÉ**

2  Entrer le mot de passe.

- Indiquez le code d'accès comme demandé.
- Si vous oubliez votre mot de passe, appuyer les touches "0-3-2-5" à votre télécommande.

Système de verrouillage

Active ou désactive la stratégie de contrôle que vous avez configurée précédemment.

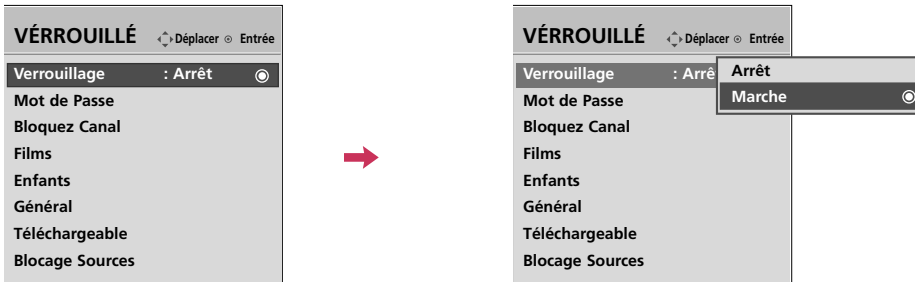



1    Sélectionnez **VÉROUILLÉ**

2  Entrer le mot de passe.

3  Sélectionnez **Verrouillage**.

4   Sélectionnez **Marche** ou **Arrêt**.

5  Retourner au menu précédent.

 Retourner à l'affichage télé.

■ Si vous choisissez **Marche**, le système de verrouillage est activé.

COMMANDE PARENTALE /CLASSEMENT

Définition du mot de passe

Changez le mot de passe en saisissant deux fois le nouveau mot de passe.

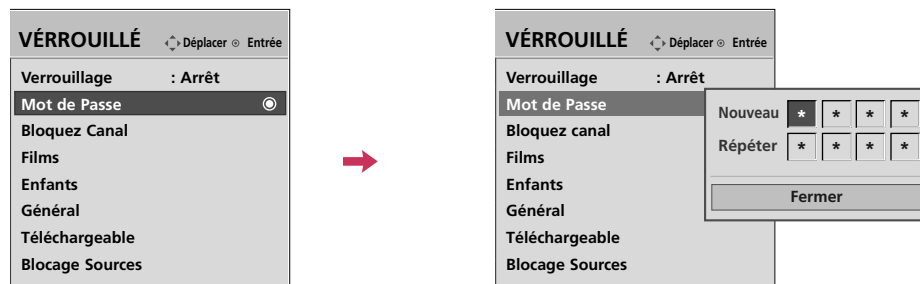



1    Sélectionnez **VÉRROUILLÉ**.

2  Entrer le mot de passe.

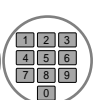
3  Sélectionnez **Mot de Passe**.

4   choisissez quatre chiffres au choix pour votre nouveau mot de passe et saisissez-les sur le champ. Une fois les quatre chiffres entrés, resaisissez le mot de passe pour **Répéter**.

5  Retourner au menu précédent.

 Retourner à l'affichage télé.

BLOPAGE DES CHAÎNES

Verrouille les chaînes que vous ne souhaitez pas regarder ou celles que vous ne souhaitez pas que vos enfants regardent.

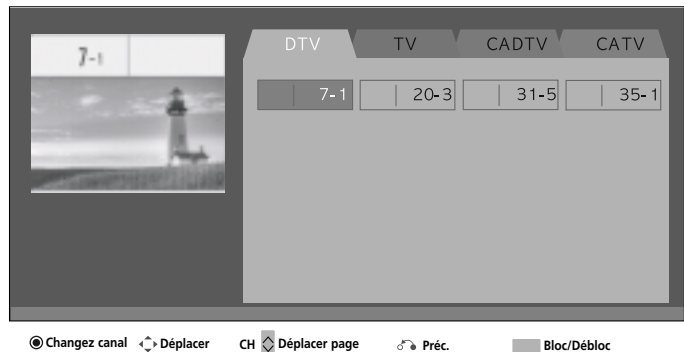

-    Sélectionnez **VÉRROUILLÉ**
-  Entrer le mot de passe.
-  Sélectionnez **Bloquez Canal**.
-   Sélectionner une chaîne à bloquer ou à débloquer.
-  Bloquer ou débloquer une chaîne.
-  Retourner au menu précédent.
-  Retourner à l'affichage télé.

CLASSEMENT DES FILMS ET DES ÉMISSIONS TÉLÉVISÉES

Classement des films (MPAA) - Pour les É.-U uniquement

Empêche le visionnage des films en fonction de du classement qui leur a été affecté, afin que les enfants ne puissent pas accéder aux contenus à caractère choquant ou jugé comme tel. Vous pouvez ainsi fixer des limites en bloquant l'accès aux films dont l'indice de classement dépasse un certain seuil. Gardez à l'esprit que les limites de classement s'appliquent uniquement aux films retransmis à la TV, et non aux programmes TV comme par exemple les feuilletons.

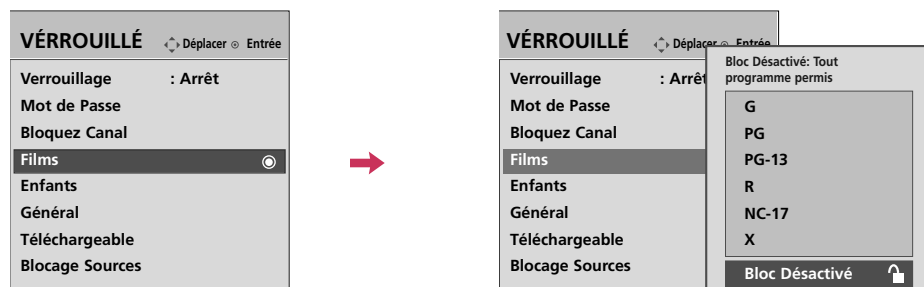



1    Sélectionnez **VÉRROUILLÉ**

2  Entrer le mot de passe.

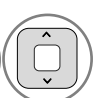
3  Sélectionnez **Films**.

4   Sélectionnez **G, PG, PG-13, R, NC-17, X** ou **Bloc Désactivé**.

5  Retourner au menu précédent.



 Retourner à l'affichage télé.

- G (Audience Générale)
- PG (Conseil Parental Suggéré)
- PG-13 (Parents Fortement Avertis)
- R (Restreint)
- NC-17 (Restreint pour 17 ans et moins)
- X (Adulte Seulement)
- Bloc Désactivé (tout programme permis)
- ▶ Si vous classez un programme dans la catégorie PG-13 : Les films de catégorie G et PG pourront être visionnés, les films PG-13, R, NC-17 et X seront bloqués.

Classement des émissions pour enfants - Pour les É.-U uniquement

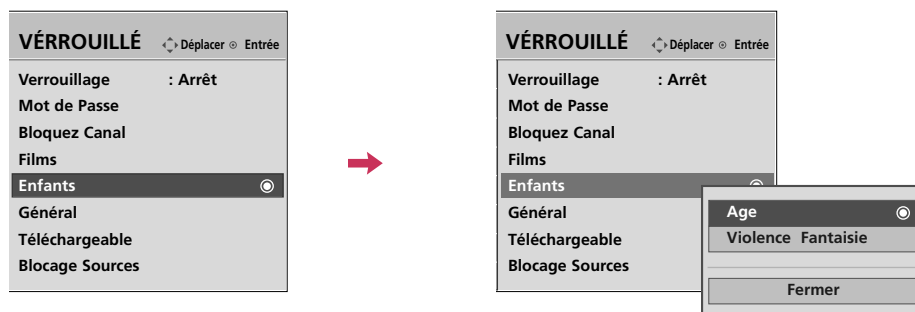
Empêche les enfants de visionner certains programmes TV, en fonction du classement qui leur a été affecté. Ce classement ne s'applique pas aux autres émissions TV. À moins que vous ne bloquiez expressément certaines émissions TV réservées à un public mature dans le sous menu TV Rating, vos enfants pourront visionner ces programmes.



-    Sélectionnez **VÉRROUILLÉ**
-  Entrer le mot de passe.
-  Sélectionnez **Enfants**.
-   Sélectionnez **Age** ou **Violence Fantaisie**.
-   Sélectionner les options de blocage.
-  Retourner au menu précédent.
-  Retourner à l'affichage télé.

- Age (s'applique à TV-Y, TV-Y7)
- Violence Fantaisie (s'applique à TV-Y7)

COMMANDE PARENTALE /CLASSEMENT

Classement des émissions - Pour les É.-U uniquement

Basé sur les classements, filtre certaines émissions télévisées que vous et votre famille ne souhaitez pas regarder.

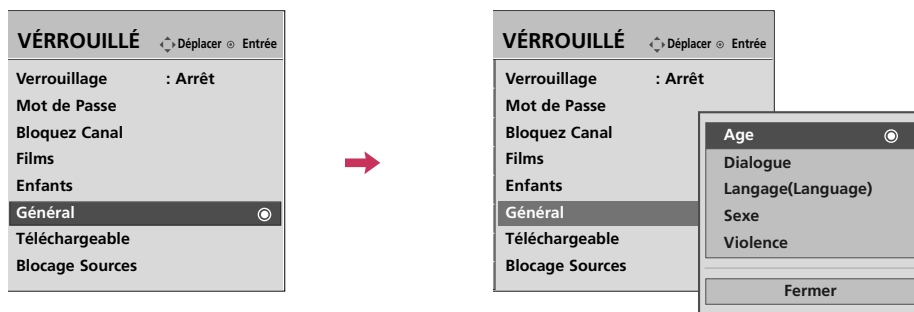

1 Sélectionnez **VÉRROUILLÉ**

2 Entrer le mot de passe.

3 Sélectionnez **Général**.

4 Sélectionnez **Age, Dialogue, Langage, Sexe** ou **Violence**.

5 Sélectionner les options de blocage.

6 Retourner au menu précédent.

Retourner à l'affichage télé.

- Age (s'applique à TV-G, TV-PG, TV-14, TV-MA)
- Dialogue (s'applique à TV-PG, TV-14)
- Langage (s'applique à TV-PG, TV-14, TV-MA)
- Sexe (s'applique à TV-PG, TV-14, TV-MA)
- Violence (s'applique à TV-PG, TV-14, TV-MA)

Système de classement en anglais - Pour le Canada uniquement

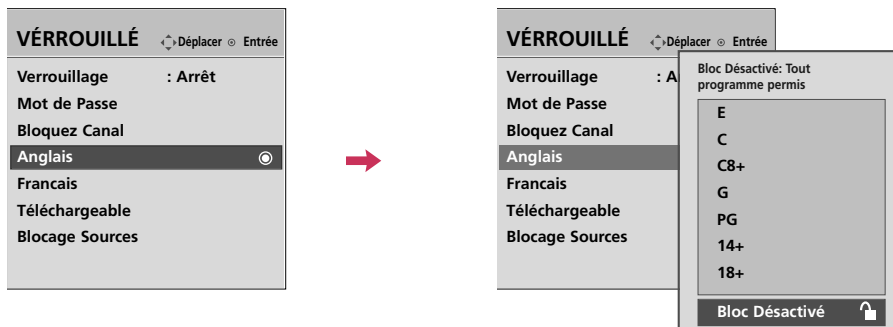

Sélection du système de classement en Anglais (Canada).





1    Sélectionnez **VÉROUILLÉ**

2  Entrer le mot de passe.

3  Sélectionnez **Anglais**.

4   Sélectionnez **E, C, C8+, G, PG, 14+, 18+ ou Bloc Désactivé**.

5  Retourner au menu précédent.

 Retourner à l'affichage télé.





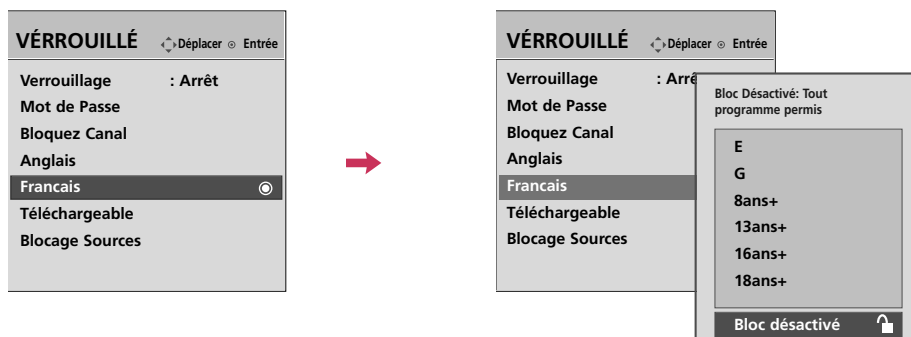

- E (Exemptés)
- C (Enfants)
- C8+ (Enfants de 8 ans et plus)
- G (Émissions générales, pour tout public)
- PG (Accord parental souhaitable)
- 14+ (Public de 14 ans et plus)
- 18+ (Émissions pour adulte)
- Bloc Désactivé (Filtrage désactivé)

COMMANDE PARENTALE /CLASSEMENT

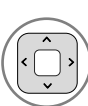
Systeme de classement en français - Pour le Canada uniquement

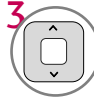
Sélection du système de classement en français (Canada).

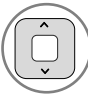

- 1    Sélectionnez **VÉRROUILLÉ**
- 2  Entrer le mot de passe.
- 3  Sélectionnez **Français**.
- 4   Sélectionnez **E, G, 8ans+, 13ans+, 16ans+, 18ans+ ou Bloc Désactivé**.
- 5  Retourner au menu précédent.
-  Retourner à l'affichage télé.

- E (Exemptés)
- G (Général)
- 8ans+ (Général-Ne convient pas aux enfants)
- 13ans+ (Ne convient pas aux moins de 13 ans)
- 16ans+ (Ne convient pas aux moins de 16 ans)
- 18ans+ (Pour adultes seulement)
- Bloc Désactivé (Tout programme permis)

TÉLÉCHARGEABLE

Il est possible que cette fonction soit disponible à l'avenir, uniquement pour les signaux de canal numérique. Cette fonction est uniquement disponible lorsque la télévision a reçu des données de classification de Région5.

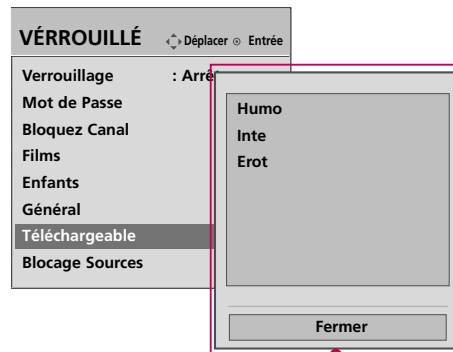
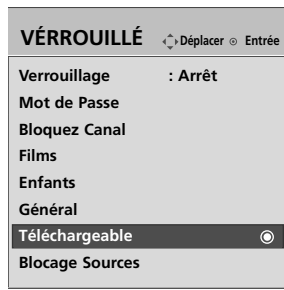



- En fonction du tableau de classification, l'affichage à l'écran de votre télévision peut différer légèrement de ce qui est illustré dans ce guide.

1    Sélectionnez **VÉRROUILLÉ**.

2  Entrer le mot de passe.

3  Sélectionnez **Téléchargeable**.

4   Sélectionnez l'option **Téléchargeable**.

5   Sélectionnez une des options et bloquez-la.

6  Retourner au menu précédent.

 Retourner à l'affichage télé.

COMMANDE PARENTALE /CLASSEMENT

BLOPAGE DE L'ENTRÉE EXTERNE

Vous permet de bloquer un signal.

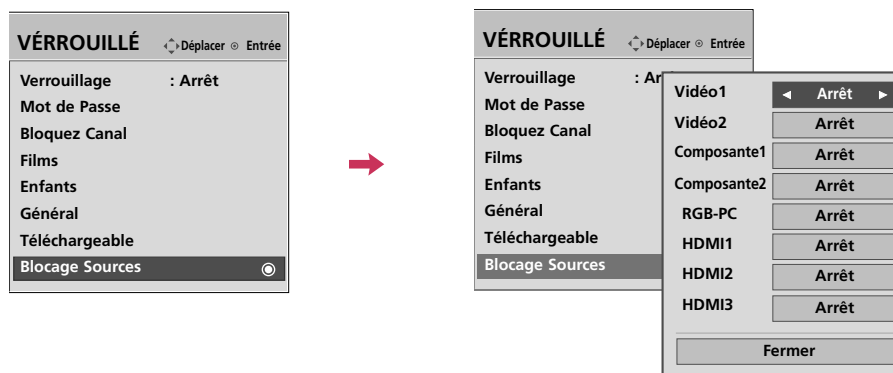

1    Sélectionnez **VÉROUILLÉ**.

2  Entrer le mot de passe.

3  Sélectionnez **Blocage Sources**.

4   Sélectionner une source.

5  Sélectionnez **Marche** ou **Arrêt**.







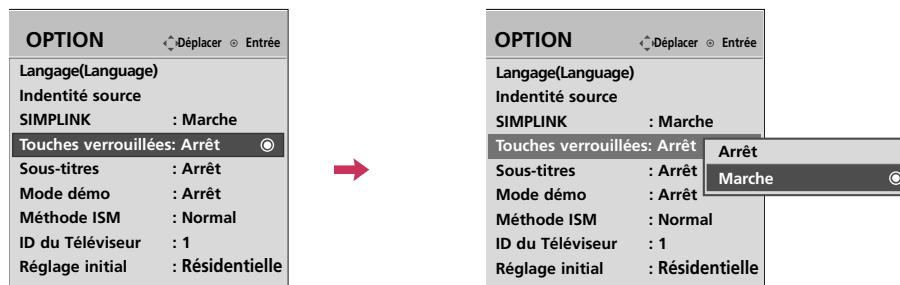

6  Retourner au menu précédent.

 Retourner à l'affichage télé.

TOUCHES VERROUILLÉES

Il est possible de régler le téléviseur de manière à ce que seule la télécommande puisse être utilisée. Cette fonction peut être utilisée afin de prévenir l'usage non autorisé en verrouillant les commandes du panneau frontal. Ce téléviseur est configuré de manière à mémoriser l'option ayant été utilisée en dernier, et ce, même lorsque vous l'éteignez.



-   Sélectionnez **OPTION**.
-   Sélectionnez **Touches verrouillées**.
-   Sélectionnez **Marche** ou **Arrêt**.
-  Retourner au menu précédent.
-  Retourner à l'affichage télé.

- Lorsque le verrouillage est activé, si le téléviseur est éteint, peser sur le bouton **INPUT**, **CH** ^, v de l'appareil ou les boutons **POWER**, **INPUT**, **CH** ^, v ou **Numériques** de la télécommande.
- Verrouillage en circuit, l'affichage '⚠ Verrouillées' figure à l'écran si toute touche (sauf ⏻/⏻ (alimentation)) sur le panneau avant est pressée.

LISTE DE VÉRIFICATION DE DÉPANNAGE

L'opération ne fonctionne pas normalement.	
La télécommande ne fonctionne pas	<ul style="list-style-type: none"> ■ Assurez-vous qu'aucun objet n'interfère entre le poste de télévision et la télécommande. Assurez-vous que vous pointez la télécommande correctement vers le poste de télévision. ■ Assurez-vous d'avoir installé les batteries en respectant la polarité (+ vers +, - vers -). ■ Assurez-vous d'avoir sélectionné le bon mode de fonctionnement à distance : TV, VCR etc. ■ Remplacez les piles. *Cette fonction n'est pas disponible pour tous les modèles.
L'unité s'est éteinte subitement	<ul style="list-style-type: none"> ■ Est-ce qu'une mise en veille a été programmée? ■ Vérifiez les paramètres de gestion de l'alimentation. Coupure de courant. ■ D'entrée ou si la télécommande est inactive pendant 15 minutes.
L'image ne fonctionne pas.	
Pas d'image ni de son	<ul style="list-style-type: none"> ■ Vérifiez que le poste est allumé. ■ Essayez une autre chaîne. Le problème peut venir de la réception d'une chaîne particulière. ■ Le câble d'alimentation est-il correctement inséré dans la prise murale? ■ Vérifiez la direction et la location de votre antenne. ■ Contrôlez la prise de courant, branchez la prise de courant d'un autre appareil dans la prise dans laquelle la prise du poste de TV était branchée.
L'image apparaît lentement après la mise sous tension	<ul style="list-style-type: none"> ■ C'est normal, l'image est absente durant le processus de démarrage du produit. Veuillez contacter votre SAV, si l'image n'apparaît toujours pas après cinq minutes.
Pas de couleur ou couleur/image terne	<ul style="list-style-type: none"> ■ Réglez les couleurs dans les options de menu. ■ Respectez une distance suffisante entre le magnétoscope et le téléviseur. ■ Essayez une autre chaîne. Le problème peut venir de la réception d'une chaîne particulière. ■ Les connexions vidéo sont-elles correctes? ■ Activez n'importe quelle fonction pour restaurer la luminosité de l'image.
Lignes horizontales/verticales ou image tremblotante	<ul style="list-style-type: none"> ■ Recherchez les causes d'interférence comme un appareil ou un outil électrique.
Mauvaise réception de certaines chaînes	<ul style="list-style-type: none"> ■ La station ou le câble du poste rencontrent des problèmes, passez sur une autre chaîne. ■ Le signal de la station est faible, orientez l'antenne pour recevoir un signal plus fort. ■ Recherchez les possibles sources d'interférence.
Lignes ou stries sur l'image	<ul style="list-style-type: none"> ■ Contrôlez l'antenne (changez l'orientation de l'antenne).
Aucune image en connectant la prise HDMI	<ul style="list-style-type: none"> ■ Vérifiez la compatibilité du câble HDMI avec la version 1.3. Les câbles HDMI ne prennent pas en charge l'HDMI version 1.3, ils causent des scintillements ou aucun affichage. Dans ce cas, utilisez des câbles plus récents qui prennent en charge HDMI version 1.3.

Le son ne fonctionne pas.

Image correcte mais pas de son	<ul style="list-style-type: none">■ Appuyez sur les touches VOL ou VOLUME.■ Son en sourdine? Appuyez sur la touche MUTE.■ Essayez avec une autre chaîne. Le problème vient peut être de la réception d'une chaîne particulière.■ Les connexions audio sont-elles correctes?
Un haut-parleur ne produit aucun son	<ul style="list-style-type: none">■ Ajustez la balance Droite/gauche dans les options de menu.
Le poste émet un son inhabituel	<ul style="list-style-type: none">■ Un changement du degré d'humidité ou de la température du milieu ambiant peut provoquer ce genre de désagrément lorsque le produit est allumé ou éteint. Il ne s'agit pas d'un dysfonctionnement du produit.
Aucun son en connectant la prise HDMI/USB	<ul style="list-style-type: none">■ Vérifiez la compatibilité du câble HDMI avec la version 1.3■ Vérifiez la compatibilité du câble USB avec la version 2.0■ Utilisez un fichier MP3 normal. *Cette fonction n'est pas disponible pour tous les modèles.

Il y a un problème en mode PC. (s'applique au Mode PC uniquement)

Le signal est en dehors de la plage (format invalide)	<ul style="list-style-type: none">■ Réglez la résolution, la fréquence horizontale, ou la fréquence verticale.■ Vérifiez la source d'entrée.
Des lignes verticales ou des rayures en fond d'écran & du bruit horizontal & une position incorrecte	<ul style="list-style-type: none">■ Lancez la configuration automatique ou réglez l'horloge, la phase, ou la position H/V. (Option)
La couleur de l'écran est instable ou couleur unique	<ul style="list-style-type: none">■ Vérifier le câble.■ Réinstallez la carte vidéo du PC.

ENTRETIEN

Il est possible de prévenir les défaillances avant qu'elles surviennent. Un nettoyage régulier et assidu peut prolonger la durée de vie de votre téléviseur.

Attention: Veillez à mettre l'appareil hors tension et à débrancher le cordon d'alimentation avant de procéder au nettoyage.

Nettoyage de l'écran

- 1 Voici un truc pour empêcher la poussière de se déposer sur l'écran pendant un certain temps. Mouillez un chiffon doux avec de l'eau tiède. Ajoutez un peu de produit assouplissant ou de détergent liquide pour vaisselle sur le chiffon. Tordez le chiffon jusqu'à ce qu'il soit presque sec et utilisez-le pour essuyer l'écran.
- 2 Ne laissez pas l'eau s'accumuler sur l'écran. Laissez sécher avant de mettre le téléviseur sous tension.

Nettoyage du boîtier

- Pour enlever la poussière ou les saletés, essuyez le boîtier avec un chiffon doux non pelucheux.
- Ne mouillez pas le chiffon.

Absence prolongée

ATTENTION

- ▶ Si vous prévoyez ne pas utiliser votre téléviseur pour une longue période (comme des vacances), il est conseillé de débrancher le cordon d'alimentation afin de ne pas risquer que la foudre ou les surtensions n'endommagent l'appareil.

SPÉCIFICATIONS DE L'APPAREIL

MODÈLES		50PK550, 50PK550C (50PK550-UD, 50PK550C-UD) (50PK550-UE)	60PK550, 60PK550C (60PK550-UD, 60PK550C-UD)
Dimensions (Largeur x Hauteur x Profondeur)	Support y compris	1171.4 mm x 786.2 mm x 309.7 mm (46.1 pouces x 30.9 pouces x 12.1 pouces)	1392 mm x 915 mm x 367 mm (54.8 pouces x 36 pouces x 14.4 pouces)
	Support non compris	1171.4 mm x 724.4 mm x 55.3 mm (46.1 pouces x 28.5 pouces x 2.1 pouces)	1392 mm x 852 mm x 55.3 mm (54.8 pouces x 33.5 pouces x 2.1 pouces)
Poids	Support y compris	31 kg (68.3 livres)	49.5 kg (109.1 livres)
	Support non compris	28.6 kg (63.0 livres)	45 kg (99.2 livres)
MODÈLES		42PJ350, 42PJ350C (42PJ350-UB, 42PJ350C-UB)	50PJ350, 50PJ350C (50PJ350-UB, 50PJ350C-UB)
Dimensions (Largeur x Hauteur x Profondeur)	Support y compris	988 mm x 688.5 mm x 260 mm (38.8 pouces x 27.1 pouces x 10.2 pouces)	1171.4 mm x 781.8 mm x 309.7 mm (46.1 pouces x 30.7 pouces x 12.1 pouces)
	Support non compris	988 mm x 617.8 mm x 55.3 mm (38.8 pouces x 24.3 pouces x 2.1 pouces)	1171.4 mm x 720.9 mm x 55.3 mm (46.1 pouces x 28.3 pouces x 2.1 pouces)
Poids	Support y compris	21.6 kg (47.6 livres)	30 kg (66.1 livres)
	Support non compris	20 kg (44 livres)	27.6 kg (60.8 livres)
MODÈLES		42PJ340 (42PJ340-UB)	50PJ340 (50PJ340-UB, 50PJ340-UC, 50PJ340-UF)
Dimensions (Largeur x Hauteur x Profondeur)	Support y compris	988 mm x 688.5 mm x 260 mm (38.8 pouces x 27.1 pouces x 10.2 pouces)	1171.4 mm x 781.8 mm x 309.7 mm (46.1 pouces x 30.7 pouces x 12.1 pouces)
	Support non compris	988 mm x 617.8 mm x 55.3 mm (38.8 pouces x 24.3 pouces x 2.1 pouces)	1171.4 mm x 720.9 mm x 55.3 mm (46.1 pouces x 28.3 pouces x 2.1 pouces)
Poids	Support y compris	21.6 kg (47.6 livres)	30 kg (66.1 livres)
	Support non compris	20 kg (44 livres)	27.6 kg (60.8 livres)
MODÈLES		50PK540 (50PK540-UE)	60PK540 (60PK540-UE)
Dimensions (Largeur x Hauteur x Profondeur)	Support y compris	1171.4 mm x 786.2 mm x 309.7 mm (46.1 pouces x 30.9 pouces x 12.1 pouces)	1392 mm x 915 mm x 367 mm (54.8 pouces x 36 pouces x 14.4 pouces)
	Support non compris	1171.4 mm x 724.4 mm x 55.3 mm (46.1 pouces x 28.5 pouces x 2.1 pouces)	1392 mm x 852 mm x 55.3 mm (54.8 pouces x 33.5 pouces x 2.1 pouces)
Poids	Support y compris	31 kg (68.3 livres)	49.5 kg (109.1 livres)
	Support non compris	28.6 kg (63.0 livres)	45 kg (99.2 livres)
Alimentation requise Système de télévision Programmation Impédance de l'antenne externe		AC 100-240V ~ 50 / 60 Hz NTSC-M, ATSC, 64 & 256 QAM VHF 2-13, UHF 14-69, CATV 1-135, DTV 2-69, CADTV 1-135 75 ohm	
Environnement	Température de fonctionnement Humidité de fonctionnement	32 ~ 104°F (0 ~ 40 °C) Inférieur à 80%	
	Température d'entreposage Humidité d'entreposage	-4 ~ 140°F (-20 ~ 60 °C) Inférieur à 80%	

ANNEXE

MODÈLES		42PJ550 (42PJ550-UD)	50PJ550 (50PJ550-UD)
Dimensions (Largeur x Hauteur x Profondeur)	Support y compris	988 mm x 692.7 mm x 260 mm (38.8 pouces x 27.2 pouces x 10.2 pouces)	1171.4 mm x 786.2 mm x 309.7 mm (46.1 pouces x 30.9 pouces x 12.1 pouces)
	Support non compris	988 mm x 621.8 mm x 55.3 mm (38.8 pouces x 24.4 pouces x 2.1 pouces)	1171.4 mm x 724.4 mm x 55.3 mm (46.1 pouces x 28.5 pouces x 2.1 pouces)
Poids	Support y compris	21.6 kg (47.6 livres)	30 kg (66.1 livres)
	Support non compris	20 kg (44.0 livres)	27.6 kg (60.8 livres)
MODÈLES		60PK290 (60PK290-UA)	50PK340 (50PK340-UB)
Dimensions (Largeur x Hauteur x Profondeur)	Support y compris	1392 mm x 910 mm x 367 mm (40.9 pouces x 28.5 pouces x 12.1 pouces)	1171.4 mm x 781.8 mm x 309.7 mm (46.1 pouces x 30.7 pouces x 12.1 pouces)
	Support non compris	1392 mm x 843 mm x 55.3 mm (40.9 pouces x 26.3 pouces x 3.0 pouces)	1171.4 mm x 720.9 mm x 55.3 mm (46.1 pouces x 28.3 pouces x 2.1 pouces)
Poids	Support y compris	49.5 kg (109.1 livres)	31 kg (68.3 livres)
	Support non compris	45 kg (99.2 livres)	28.6 kg (63.0 livres)
MODÈLES		42PJ250 (42PJ250-UA) (42PJ250-UB)	50PJ250 (50PJ250-UA)
Dimensions (Largeur x Hauteur x Profondeur)	Support y compris	988 mm x 688.5 mm x 260 mm (38.8 pouces x 27.1 pouces x 10.2 pouces)	1171.4 mm x 781.8 mm x 309.7 mm (46.1 pouces x 30.7 pouces x 12.1 pouces)
	Support non compris	988 mm x 617.8 mm x 55.3 mm (38.8 pouces x 24.3 pouces x 2.1 pouces)	1171.4 mm x 720.9 mm x 55.3 mm (46.1 pouces x 28.3 pouces x 2.1 pouces)
Poids	Support y compris	21.6 kg (47.6 livres)	30 kg (66.1 livres)
	Support non compris	20 kg (44.0 livres)	27.6 kg (60.8 livres)
Alimentation requise Système de télévision Programmation Impédance de l'antenne externe		AC 100-240V ~ 50 / 60 Hz NTSC-M, ATSC, 64 & 256 QAM VHF 2-13, UHF 14-69, CATV 1-135, DTV 2-69, CADTV 1-135 75 ohm	
Environnement	Température de fonctionnement Humidité de fonctionnement	32 ~ 104°F (0 ~ 40 °C) Inférieur à 80%	
	Température d'entreposage Humidité d'entreposage	-4 ~ 140°F (-20 ~ 60 °C) Inférieur à 85%	

MODÈLES		50PK350 (50PK350-UC)	60PK280 (60PK280-UA)
Dimensions (Largeur x Hauteur x Profondeur)	Support y compris	1171.4 mm x 781.8 mm x 309.7 mm (46.1 pouces x 30.7 pouces x 12.1 pouces)	1392 mm x 910 mm x 367 mm (40.9 pouces x 28.5 pouces x 12.1 pouces)
	Support non compris	1171.4 mm x 720.9 mm x 55.3 mm (46.1 pouces x 28.3 pouces x 2.1 pouces)	1392 mm x 843 mm x 55.3 mm (40.9 pouces x 26.3 pouces x 3.0 pouces)
Poids	Support y compris	31 kg (68.3 livres)	49.5 kg (109.1 livres)
	Support non compris	28.6 kg (63.0 livres)	45 kg (99.2 livres)
MODÈLES		50PK250 (50PK250-UA) (50PK250-UB)	60PK250 (60PK250-UA) (60PK250-UB)
Dimensions (Largeur x Hauteur x Profondeur)	Support y compris	1171.4 mm x 781.8 mm x 309.7 mm (46.1 pouces x 30.7 pouces x 12.1 pouces)	1392 mm x 910 mm x 367 mm (40.9 pouces x 28.5 pouces x 12.1 pouces)
	Support non compris	1171.4 mm x 720.9 mm x 55.3 mm (46.1 pouces x 28.3 pouces x 2.1 pouces)	1392 mm x 843 mm x 55.3 mm (40.9 pouces x 26.3 pouces x 3.0 pouces)
Poids	Support y compris	31 kg (68.3 livres)	49.5 kg (109.1 livres)
	Support non compris	28.6 kg (63.0 livres)	45 kg (99.2 livres)
Alimentation requise Système de télévision Programmation Impédance de l'antenne externe		AC 100-240V ~ 50 / 60 Hz NTSC-M, ATSC, 64 & 256 QAM VHF 2-13, UHF 14-69, CATV 1-135, DTV 2-69, CADTV 1-135 75 ohm	
Environnement	Température de fonctionnement Humidité de fonctionnement	32 ~ 104°F (0 ~ 40 °C) Inférieur à 80%	
	Température d'entreposage Humidité d'entreposage	-4 ~ 140°F (-20 ~ 60 °C) Inférieur à 85%	

■ Les spécifications qui figurent ci-dessus peuvent être modifiées sans préavis.

ANNEXE

CODES IR

(This feature is not available for all models.)

1. Comment brancher

- Brancher la télécommande à fil sur la prise télécommande du TV.

2. Code IR de la télécommande

■ Sortie onde

Impulsion simple, modulée avec signal 37.917KHz à 455KHz

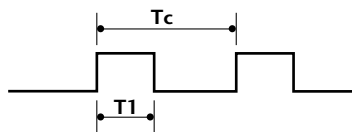

Fréquence porteuse

$$FCAR = 1/T_C = f_{OSC}/12$$

$$\text{Rapport} = T_1/T_C = 1/3$$

■ Configuration d'image

1^{re} image

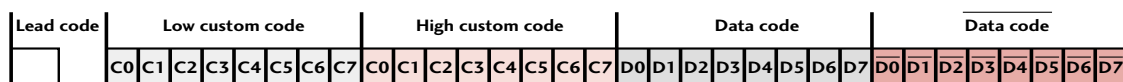

Répéter image

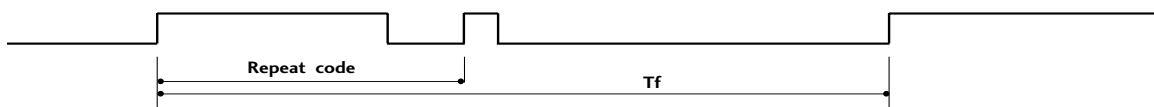

■ Code connexion

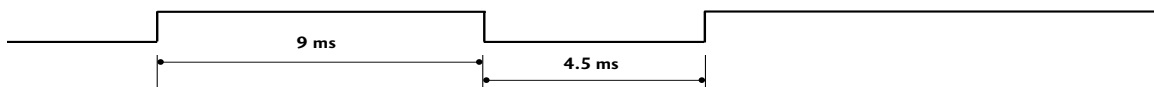

■ Code répétition

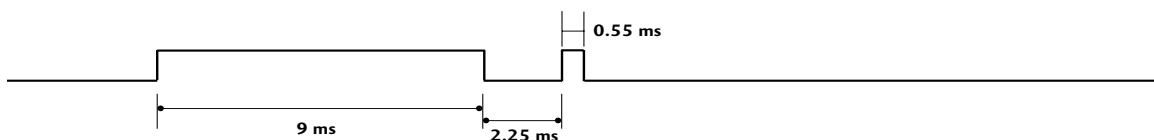

■ Intervalle image : Tf



■ Intervalle image: Tf

L'onde est transmise tant que la touche est pressée.

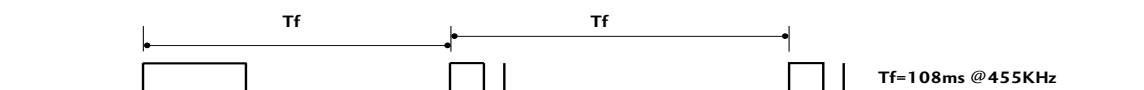

Code (Hexa)	Function	Remarque	Code (Hexa)	Function	Remarque
08	POWER	Touche télécommande (alimentation marche-arrêt)	D6	TV	Code IR discret
45	Q.MENU	Touche télécommande			(sélection entrée TV)
43	MENU	Touche télécommande	C4	POWER ON	Code IR discret
0B	INPUT	Touche télécommande			(marche seulement)
10-19	Numériques 0-9	Touche télécommande	C5	POWER OFF	Code IR discret
4C	- Tired(List)	Touche télécommande			(arrêt seulement)
1A	FLASHBK	Touche télécommande	5A	Vidéo1	Code IR discret
09	MUTE	Touche télécommande			(sélection entrée Vidéo1)
02	VOL +	Touche télécommande	D0	Vidéo2	Code IR discret
03	VOL -	Touche télécommande			(sélection entrée Vidéo2)
00	CH ^	Touche télécommande	BF	COMPOSANTE1	Code IR discret
01	CH v	Touche télécommande			(sélection entrée Composante1)
1E	FAV	Touche télécommande	D4	COMPOSANTE2	Code IR discret
40	^	Touche télécommande			(sélection entrée Composante2)
41	v	Touche télécommande	D5	RGB-PC	Code IR discret
07	<	Touche télécommande			(sélection entrée RGB-PC)
06	>	Touche télécommande	CE	HDMI1	Code IR discret
44	ENTER	Touche télécommande			(sélection entrée HDMI1)
28	BACK	Touche télécommande	CC	HDMI2	Code IR discret
7E	SIMPLINK	Touche télécommande			(sélection entrée HDMI2)
30	AV MODE	Touche télécommande	E9	HDMI3	Code IR discret
79	RATIO	Touche télécommande			(sélection entrée HDMI3)
BA	Pause II(FREEZE)	Touche télécommande	76	Ratio 4:3	Discrete IR Code
95	ENERGY	Touche télécommande			(Only 4:3 Mode)
AA	Info	Touche télécommande	77	Ratio 16:9	Discrete IR Code
72	Red	Touche télécommande			(Only 16:9 Mode)
71	Green	Touche télécommande	AF	Ratio Zoom	Discrete IR Code
63	Yellow	Touche télécommande			(Only Zoom1 Mode)
61	Blue	Touche télécommande			
8E	FF ►►	Touche télécommande			
8F	Rew ◀◀	Touche télécommande			
0F	TV	Touche télécommande			
5B	EXIT	Touche télécommande			
B1	Stop ■	Touche télécommande			
B0	Play ►	Touche télécommande			

COMMANDE EXTERNE PAR LE BIAIS DU RS-232C

Le port RS-232C vous permet de brancher la prise d'entrée RS-232C à un appareil de commande externe (comme un ordinateur ou un système de commande audiovisuel) pour commander les fonctions du téléviseur par un dispositif externe.

- Remarque: Le port RS-232C de cette unité est conçu pour être utilisé par du matériel et des logiciels RS-232C offerts par des tiers.

Les instructions ci-dessous sont fournies pour vous aider à programmer le logiciel ou pour en vérifier la fonctionnalité à l'aide du logiciel Telenet.

Réglage RS-232C

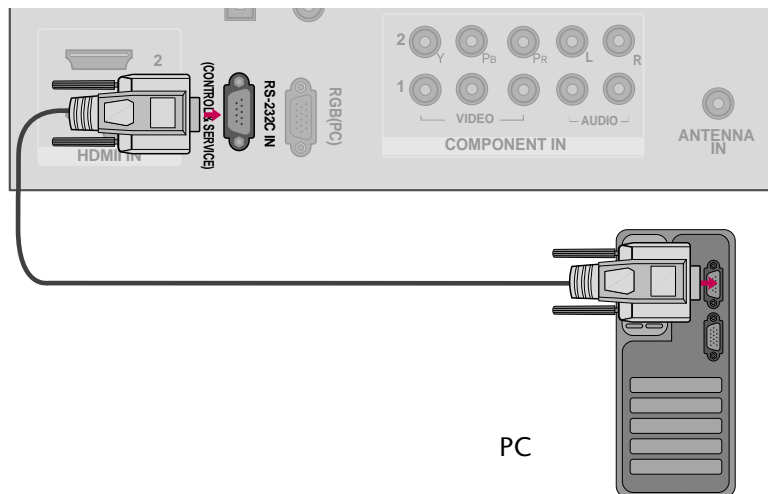

Type de connecteur ; D-sub, mâle à 9 broches Paramètres de communication

No.	Pin Name
1	Aucune connexion
2	RXD (donnée reçue)
3	TXD (donnée envoyée)
4	DTR (côté DTE prêt)
5	GND
6	DSR (côté DCE prêt)
7	RTS (prêt à envoyer)
8	CTS (prêt à envoyer)
9	Aucune connexion

- Taux baud : 9600 bps (UART)
- Longueur de donnée : 8 bits
- Parité : aucune
- Bit d'arrêt : 1 bit
- Code de communication : ASCII
- Utiliser un câble croisé (renversé).

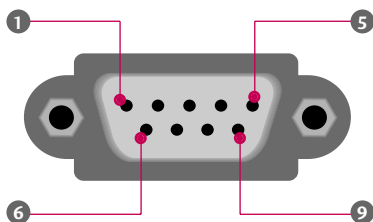

Configurations RS-232C

N'importe quel câble indiqué ci-dessous peut être utilisé.

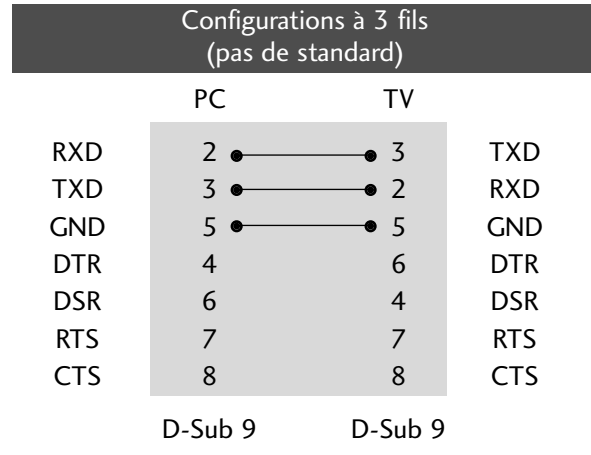
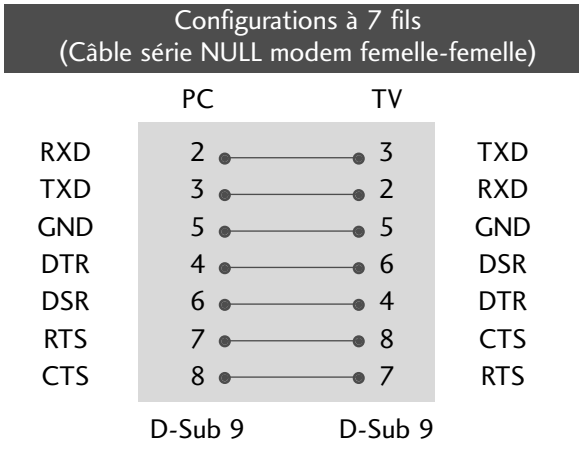

Réglage identification

Utiliser cette fonction pour spécifier un numéro d'identification du téléviseur.

Voir Planification donnée réelle.

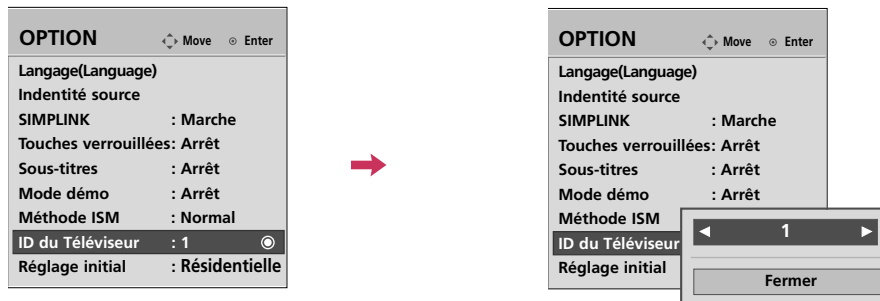

- 1 Sélectionnez **OPTION**.
- 2 Sélectionnez **ID du Téléviseur**.
- 3 Choisir le numéro désiré.
La gamme de réglage est de 1 à 99.
- 4 Retourner au menu précédent.
- Retourner à l'affichage télé.

*Planification donnée réelles

0 : Étape 0

⋮

A : Étape 10 (Identité TV 10)

⋮

F : Étape 15 (Identité TV 15)

10 : Étape 16 (Identité TV 16)

⋮

63 : Étape 99 (Identité TV99)

64 : Étape 100

Liste de référence de commande

	COMMAND1	COMMAND2	Donnée (hexadécimale)		COMMAND1	COMMAND2	Donnée (hexadécimale)
01. Alimentation	k	a	00 ~ 01	13. Verrouillage télécommande	k	m	00 ~ 01
02. Sélection entrée	x	b	(▶ p.117)	14. Aiguës	k	r	00 ~ 64
03. Allongement	k	c	(▶ p.117)	15. Basses	k	s	00 ~ 64
04. Sourdine écran	k	d	00 ~ 01	16. Équilibre	k	t	00 ~ 64
05. Volume sourdine	k	e	00 ~ 01	17. Température de Couleur	x	u	00 ~ 64
06. Volume	k	f	00 ~ 64	18. Méthode ISM	j	p	(▶ p.118)
07. Contraste	k	g	00 ~ 64	19. Économique	j	q	00 ~ 01
08. Brillance	k	h	00 ~ 64	20. Configuration auto	j	u	(▶ p.118)
09. Couleur	k	i	00 ~ 64	22. Ajout/suppression canal	m	b	00 ~ 01
10. Teinte	k	j	00 ~ 64	23. Clé	m	c	(▶ p.119)
11. Netteté	k	k	00 ~ 64				
12. Sélection affichage à l'écran	k	l	00 ~ 01				

	COMMAND1	COMMAND2	DATA00 (Hexadecimal)	DATA01 (Hexadecimal)	DATA02 (Hexadecimal)	DATA03 (Hexadecimal)	DATA04 (Hexadecimal)	DATA05 (Hexadecimal)
21. Syntonisation Canal	m	a	Programme Physique Haut	Principal Programme Bas	Principal Bas	Secondair e Haut	Secondair e Bas	Attribut

Protocole de transmission / réception

Transmission

[Command1][Command2][][Set ID][][Data][Cr]

[Commande 1] : Première commande pour contrôler l'appareil. (j, k, m ou x)

[Commande 2] : Seconde commande pour contrôler l'appareil.

[ID du Téléviseur] : pour régler l'identification pour choisir le numéro désiré pour l'ordinateur au menu réglage. Gamme de 1 à 00. En sélectionnant 0, chaque appareil branché sur le téléviseur est contrôlé. Régler comme indiqué (1 à 99) au menu et une décimale hexagonale (0x0 à 0x63) au protocole de transmission/réception.

[Donnée] : Pour transmettre donnée de commande.

Transmet 'FF' pour lire la position de la commande

* Dans ce modèle, TV n'enverra pas la statut en mode attente.

[Cr] : Retour de chariot

Code ASCII '0x0D'

[] : Code ASCII 'espace (0x20)'

Confirmation

[Command2][][Set ID][][OK][Data][x]

Le moniteur transmet ACK (reconnaissance) en fonction de ce format au moment de recevoir des données normales. À ce moment, si la donnée est en mode lecture, elle indique la donnée de position actuelle. Si en mode écriture, elle retourne la donnée de l'ordinateur.

* Dans ce modèle, TV n'enverra pas la statut en mode attente.

* Format de donnés

[Commande 2] : Utilisation comme commande.

[ID du Téléviseur] : Utilisation le petite caractère, si ID du Téléviseur est 10, il enverra '0', 'a'.

[Donnée] : Utilisation le petite caractère, si donnée est 0 x ab, il enverra 'a', 'b'.

[OK] : Utilisation le grand caractère.

Erreur de confirmation

[Command2][][Set ID][][NG][Data][x]

Le moniteur transmet ACK en fonction de ce format au moment de recevoir une donnée anormale depuis les fonctions non viables ou erreurs de communication.

Donnée1: code illégal

Donnée2: fonction non supportée

Donnée3: attendre plus

* Dans ce modèle, TV n'enverra pas la statut en mode attente.

* Format de donnés

[Commande 2] : Utilisation comme commande.

[ID du Téléviseur] : Utilisation le petite caractère, si ID du Téléviseur est 10, il enverra '0', 'a'.

[Donnée] : Utilisation le petite caractère, si donnée est 0 x ab, il enverra 'a', 'b'.

[NG] : Utilisation le grand caractère.

01. Alimentation (Commande: k a)

Contrôle marche arrêt TV

Transmission [k][a][] [ID du Téléviseur][] [Donnée][Cr]

Donnée 0 : Arrêt Donnée 1 : Marche

Confirmation [a][] [ID du Téléviseur][] [OK/NG][Donnée][x]

* De même, si d'autres fonctions transmettent une donnée FF en fonction de ce format, le retour de donnée reconnue présente la position de chaque fonction.

* Dans ce modèle, la TV enverra le reconnaissance après puissance sur traiter l'accomplissement.

Il pourrait y a un moment retardent entre la commande et la reconnaissance.

02. Sélection entrée (Commande: x b)

Pour sélectionner source entrée du TV.

Transmission [x][b][] [ID du Téléviseur][] [Donnée][Cr]

Donnée 00: DTV (Antenne) Donnée 01: DTV (Cable)

Donnée 10: Analogue (Antenne) Donnée 11: Analogue (câble)

Donnée 20: Vidéo1 Donnée 21: Vidéo2

Donnée 40: Composante 1 Donnée 41: Composante 2

Donnée 60: RGB-PC Donnée 90: HDMI1

Donnée 91: HDMI2 Donnée 92: HDMI3

Confirmation [b][] [Set ID][] [OK/NG][Data][x]

03. Allongement (Commande: k c)

Règle le format écran.

Transmission [k][c][] [ID du Téléviseur][] [Donnée][Cr]

Donnée 01: 4:3 09: Selon source
 02: 16:9 10: Zoom cinéma (1)
 04: Zoom
 06: Par programme 1f: Zoom cinéma (16)

Confirmation [c][] [ID du Téléviseur][] [OK/NG][Donnée][x]

04. Sourdine écran (Commande: k d)

Pour sélectionner sourdine marche-arrêt.

Transmission [k][d][] [ID du Téléviseur][] [Donnée][Cr]

Donnée 00: Arrêt (image marche), Video-out Mute off

Donnée 01: Marche (image arrêt)

Donnée 10: Video-out Mute on

Confirmation [d][] [ID du Téléviseur][] [OK/NG][Donnée][x]

* En cas de sortie vidéo en mode silence, l'affichage d'écran (OSD) sera opérationnel sur la télévision. Mais, en cas d'écran en mode silence, la télévision n'effectuera aucun affichage à l'écran (OSD).

05. Volume sourdine (Commande: k e)

Contrôle volume sourdine marche-arrêt.

Utiliser aussi la touche MUTE sur la télécommande.

Transmission [k][e][] [ID du Téléviseur][] [Donnée][Cr]

Donnée 00: Volume sourdine marche (Volume arrêt)

Donnée 01: Volume sourdine arrêt (Volume marche)

Confirmation [e][] [ID du Téléviseur][] [OK/NG][Donnée][x]

06. Volume (Commande: k f)

Règle le contrôle.

Utiliser aussi les touches volumes sur la télécommande.

Transmission [k][f][] [ID du Téléviseur][] [Donnée][Cr]

Donnée Min: 00 ~ Max: 64 (*Transmis par hexadécimal code)

*Voir planification de donnée réelle! ► p.116.

Confirmation [f][] [ID du Téléviseur][] [OK/NG][Donnée][x]

07. Contraste (Commande: k g)

Règle le contraste.

Aussi par le menu image.

Transmission [k][g][] [ID du Téléviseur][] [Donnée][Cr]

Donnée Min: 00 ~ Max: 64 (*Transmis par hexadécimal code)

*Voir planification de donnée réelle! ► p.116.

Confirmation [g][] [ID du Téléviseur][] [OK/NG][Donnée][x]

08. Brillance (Commande: k h)

Règle la brillance.

Aussi par le menu image.

Transmission [k][h][] [ID du Téléviseur][] [Donnée][Cr]

Donnée Min: 00 ~ Max: 64 (*Transmis par hexadécimal code)

*Voir planification de donnée réelle! ► p.116.

Confirmation [h][] [ID du Téléviseur][] [OK/NG][Donnée][x]

09. Couleur (Commande: k i)

Règle la couleur.

Aussi par le menu image.

Transmission [k][i][] [ID du Téléviseur][] [Donnée][Cr]

Donnée Min: 00 ~ Max: 64 (*Transmis par hexadécimal code)

*Voir planification de donnée réelle! ► p.116.

Confirmation [i][] [ID du Téléviseur][] [OK/NG][Donnée][x]

10. Teinte (Commande: k j)

Règle la teinte.

Aussi par le menu image

Transmission [k][j][] [ID du Téléviseur][] [Donnée][Cr]

Donnée Min: 00 ~ Max: 64 (*Transmis par hexadécimal code)

*Voir planification de donnée réelle! ► p.116.

Confirmation [j][] [Set ID][] [OK/NG][Data][x]

11. Netteté (Commande: k k)

Règle la netteté.

Aussi par le menu image.

Transmission [k][k][] [ID du Téléviseur][] [Donnée][Cr]

Donnée Min: 00 ~ Max: 64 (*Transmis par hexadécimal code)

*Voir planification de donnée réelle! ► p.116.

Confirmation [k][] [ID du Téléviseur][] [OK/NG][Donnée][x]

12. Sélection affichage à l'écran (Commande: k l)

Sélectionne marche-arrêt.

Transmission [k][l][][ID du Téléviseur][][Donnée][Cr]

Donnée 00: OSD Arrêt Donnée 01: OSD Marche

Confirmation [l][][ID du Téléviseur][][OK/NG][Donnée][x]

13. Verrouillage télécommande (Commande: k m)

Verrouille la télécommande et le panneau avant.

Transmission [k][m][][ID du Téléviseur][][Donnée][Cr]

Donnée 00: Verrouillage arrêt

Donnée 01: Verrouillage marche

Confirmation [m][][ID du Téléviseur][][OK/NG][Donnée][x]

Si l'on n'utilise pas la télécommande et les commandes du panneau avant pour le moniteur, utiliser ce mode. Lorsque l'alimentation principale est marche-arrêt, le verrouillage de télécommande est désactivé.

14. Aiguës (Commande: k r)

Pour régler le aiguës.

L'on peut aussi régler les aiguës au menu Audio.

Transmission [k][r][][ID du Téléviseur][][Donnée][Cr]

Donnée Min: 00 ~ Max: 64 (*Transmis par hexadécimal code)

*Voir planification de donnée réelle. ► p.116.

Confirmation [r][][ID du Téléviseur][][OK/NG][Donnée][x]

15. Basses (Commande: k s)

Pour régler le basses.

L'on peut aussi régler la basses au menu Audio.

Transmission [k][s][][ID du Téléviseur][][Donnée][Cr]

Donnée Min: 00 ~ Max: 64 (*Transmis par hexadécimal code)

*Voir planification de donnée réelle. ► p.116.

Confirmation [s][][ID du Téléviseur][][OK/NG][Donnée][x]

16. Équilibre (Commande: k t)

Pour régler l'équilibre

L'on peut aussi régler l'équilibre au menu Audio.

Transmission [k][t][][ID du Téléviseur][][Donnée][Cr]

Donnée Min: 00 ~ Max: 64 (*Transmis par hexadécimal code)

*Voir planification de donnée réelle. ► p.116.

Confirmation [t][][ID du Téléviseur][][OK/NG][Donnée][x]

17. Température de couleur (Commande: k u)

Pour régler la température de couleur.

L'on peut aussi régler la température de couleur au menu image.

Transmission [x][u][][Set ID][][Data][Cr]

Donnée Min: 00 ~ Max: 64 (*Transmis par hexadécimal code)

*Voir planification de donnée réelle. ► p.116.

Confirmation [u][][ID du Téléviseur][][OK/NG][Donnée][x]

18. Méthode ISM (Commande: j p)

Évite d'avoir une image fixe à l'écran.

Transmission [j][p][][ID du Téléviseur][][Donnée][Cr]

Donnée 02: Orbiteur 04: Cérusé

08: Normal 20: Tracé couleur

Confirmation [p][][ID du Téléviseur][][OK/NG][Donnée][x]

19. Économique (Commande: j q)

Pour contrôler la fonction blanc marche-arrêt.

Transmission [j][q][][ID du Téléviseur][][Donnée][Cr]

Donnée 00: Économie dénergie Arrêt

01: Économie dénergie: Minimum

02: Économie dénergie: Moyen

03: Économie dénergie: Maximum

05: Arrêt de l'écran

10: Capteur intelligent

Confirmation [q][][ID du Téléviseur][][OK/NG][Donnée][x]

20. Configuration auto (Commande: j u)

Pour contrôler la position de l'image et minimiser automatiquement le tremblement d'image. La configuration automatique marche seulement sous RGB-PC.

Transmission [j][u][][ID du Téléviseur][][Donnée][Cr]

Donnée 1: Pour régler.

Confirmation [u][][ID du Téléviseur][][OK/NG][Donnée][x]

21. Syntonisation Canal (Commande: m a)

Syntonise un canal suivant numéro physique/majeur/mineur

Transmission [m][a][][ID du Téléviseur][][Donnée0][][Donnée1][][Donnée2][][Donnée3][][Donnée4][][Donnée5][Cr]

Les canaux numériques possèdent un numéro de canal physique, majeur et mineur. Le numéro physique est le numéro de canal numérique réel, le majeur est le numéro auquel le canal doit être assigné et le mineur est le sous-canal. Comme le syntoniseur ATSC assigne automatiquement le canal au numéro majeur, le numéro physique n'est pas requis lors de la transmission d'une commande.

Donnée 0: numéro physique

NTSC air: 02~45, NTSC câble: 01, 0E~7D

ATSC air: 01~45, ATSC câble: 01~87

Donnée1 & 2: Numéro canal principal

Donnée1: byte élevé Donnée2: byte faible

Deux octets sont disponibles pour le majeur et le mineur, mais en général seul le deuxième est utilisé.

Donnée3 & 4: Numéro mineur

Non requis pour NTSC.

Donnée 05:		7 Image secondaire/princ	6 Utilisation d'un canal physique	5 Canal 2 / 1 parties	4 réservé	3	2	1	0	Réglage
0	Princ.	0	Utilisation	0	x	0	0	0	0	NTSC Air
1	Sec.	1	Aucune Utilisation	1	x	0	0	0	1	NTSC câble
					x	0	0	1	0	ATSC Air
					x	0	0	1	1	ATSC câble_std
					x	0	1	0	0	ATSC câble_hrc
					x	0	1	0	1	ATSC câble_irc
					x	0	1	1	0	ATSC câble_auto
					x	0	1	1	1	Réservé
					x	x	x	x	x	-
					x	1	1	1	1	Réservé

Le tableau ci-dessus présente le code binaire devant être converti en hexadécimales avant la transmission. Par exemple : Le code binaire pour syntoniser la source hiérarchique inférieure sur un canal par câble NTSC est "1000 0001", qui se traduit par "81" en hexadécimales.

- * 7^e bit : La source à laquelle vous désirez changer le canal.
- * 6^e bit : Utiliser un canal en deux parties ou en une partie. Dans la plupart des cas, il suffit d'utiliser 0 puisque la valeur est ignorée lors de l'utilisation du NTSC.
- * 5^e bit: Utiliser 0 avec NTSC car il ne peut être utilisé qu'avec le numéro de canal physique. Le 1 est normalement utilisé pour ATSC car dans la plupart des cas le numéro physique n'a pas d'importance.
- * 4^e bit: Définir à 0.
- * Bits 3 à 0 : Choisir le type de signal.

* Exemples de commandes de syntonisation :

1. Syntoniser sur le canal 35 par câble analogique (NTSC).

Donnée 0 = Physique de 35 = 23
 Donnée 1 & 2 = Pas de majeur = 00 00
 Donnée 3 & 4 = Pas de mineur = 00 00
 Donnée 5 = 0000 0001 en binaire = 01
 Total = ma 00 23 00 00 00 00 01

2. Syntoniser sur le canal local numérique (ATSC) 30-3

Donnée 0 = Le physique est inconnu = 00
 Donnée 1 & 2 = Le majeur est 30 = 00 1E
 Donnée 3 & 4 = Le mineur est 3 = 00 03
 Donnée 5 = 0010 0010 en binaire = 22
 Total = ma 00 00 00 1E 00 03 22

Confirmation[a][][ID du Téléviseur][][OK][Donnée0]
 [Donnée1][Donnée2][Donnée3][Donnée4][x][a][][
 [ID du Téléviseur][][NG][Donnée0][x]

22. Ajout/suppression canal (Commande: m b)

Pour ajouter ou supprimer des canaux

Transmission [m][b][][ID du Téléviseur][][Donnée][Cr]

Donnée 00: canal supprimé Donnée 01: canal ajouté

Confirmation [b][][ID du Téléviseur][][OK/NG][Donnée][x]

23. Clé (Commande: m c)

Pour envoyer le code clé de télécommande à IR

Transmission [m][c][][ID du Téléviseur][][Donnée][Cr]

► p.113.

Confirmation [c][][ID du Téléviseur][][OK/NG][Donnée][x]



Notez les numéros de modèle et de série de l'appareil qui figurent sur l'étiquette au dos du moniteur. Et inscrivez-les sur le dessus ou au verso de ce manuel.

MODÈLE _____

PUBLICATION PÉRIODIQUE _____



LG

Life's Good

MANUAL DE USUARIO TELEVISOR PLASMA

Lea atentamente este manual antes de poner en marcha su equipo y guárdelo para futuras consultas.

42PJ250
50PJ250
50PK250
60PK250
60PK280
60PK290

42PJ340
50PJ340
42PJ350
50PJ350

50PK350
50PK340
50PK540
60PK540

42PJ550
50PJ550
50PK550
60PK550

42PJ350C
50PJ350C
50PK550C
60PK550C

ADVERTENCIA / PRECAUCIÓN



ADVERTENCIA/ PRECAUCION

**RIESGO DE CHOQUE ELECTRICO
NO ABRIR**



PARA REDUCIR EL RIESGO DE DESCARGA ELECTRICA NO RETIRE LA CUBIERTA NI LA PARTE POSTERIOR DE ESTE APARATO.



El símbolo de descarga dentro del triángulo equilátero, señala al usuario la presencia de voltaje peligroso sin aislamiento en el interior del aparato de tal intensidad que podría presentar riesgo de descarga eléctrica.



El símbolo de admiración dentro del triángulo equilátero, indica al usuario que el manual que acompaña a este aparato contiene instrucciones referentes a su funcionamiento y mantenimiento.

ADVERTENCIA/PRECAUCION

PARA REDUCIR EL RIESGO DE INCENDIO O DESCARGA ELECTRICA, NO EXPONGA EL TELEVISOR A LA LLUVIA O HUMEDAD.

NOTA PARA EL INSTALADOR DE CABLE/TV

Este recordatorio cumple el propósito de llamar la atención del instalador del sistema CATV con respecto al Artículo 820-40 del Código Eléctrico Nacional (EE.UU.). El código proporciona las directrices necesarias para lograr una conexión a tierra correcta y, en particular, especifica que el cable de puesta a tierra deberá estar conectado al sistema de puesta a tierra del edificio, tan cerca del punto de entrada del cable como resulte práctico.

ADVERTENCIA / PRECAUCIÓN

No exponga este equipo a la lluvia o la humedad excesiva, a fin de evitar riesgo de incendio o choque eléctrico.

ADVERTENCIA DE LA FCC

Dispositivo digital de Clase B

Este equipo ha sido probado y se ha demostrado que cumple los límites para dispositivos digitales de Clase B, conforme a la Parte 15 de las normas FCC. Estos límites han sido diseñados para proporcionar una protección razonable contra interferencias perjudiciales en una instalación residencial. Este equipo genera, emplea, y puede radiar energía de radiofrecuencia y, si no se instala y usa conforme al manual de instrucciones, podría causar interferencias perjudiciales a las comunicaciones por radio. Sin embargo, no existe garantía de que la interferencia no ocurra en una instalación en particular. Si este equipo causara interferencias molestas a su recepción de radio o televisión, lo que podrá determinarse apagando y prendiendo el equipo, se insta al usuario a tratar de corregir las interferencias mediante una o más de las siguientes medidas:

- Reoriente o reubique la antena de recepción.
- Aumente la separación entre el producto y el receptor.
- Conecte el producto a una toma de alimentación dispuesta en un circuito distinto al del receptor.
- Póngase en contacto con su proveedor o solicite ayuda a un técnico especializado de radio/TV.

Este dispositivo cumple con lo expuesto en el apartado 15 de las normas FCC.

Su funcionamiento está sujeto a las dos condiciones siguientes: (1) Este dispositivo no puede ocasionar interferencias dañinas, y (2) este dispositivo debe aceptar cualquier interferencia recibida, incluyendo aquellas generadas por el funcionamiento no deseado (del dispositivo).

Cualquier cambio o modificación no aprobada expresamente por la parte responsable por conformidad podría anular la potestad del usuario para usar el equipo.

PRECAUCIÓN

No intente modificar este producto de ningún modo sin disponer de autorización por escrito de LG Electronics. La modificación sin autorización podría anular la potestad del usuario para usar este producto.

INSTRUCCIONES DE SEGURIDAD

INSTRUCCIONES DE SEGURIDAD IMPORTANTES

Lea estas instrucciones.

Guarde estas instrucciones.

Tenga en cuenta todas las advertencias.

Siga todas las instrucciones.



- 1 No utilice este producto cerca del agua.



- 2 Límpielo sólo con un paño seco.



- 3 No bloquee las aberturas de ventilación. Instale siguiendo las instrucciones del fabricante.



- 4 No lo coloque cerca de fuentes de calor, como radiadores, rejillas de aire caliente, estufas u otros aparatos (incluidos los amplificadores) que emitan calor.



- 5 No anule el propósito de seguridad del tomacorriente polarizado o ni del de puesta a tierra. Un tomacorriente polarizado cuenta con dos clavijas, una más ancha que la otra. Un tipo de tomacorriente con conexión a tierra dispone de dos clavijas y una tercera de puesta a tierra, el terminal ancho o la tercera clavija está puesta por su seguridad. Si el tomacorriente incluido no es adecuado para su toma de pared, póngase en contacto con un electricista para que realice el reemplazo de la toma obsoleta.

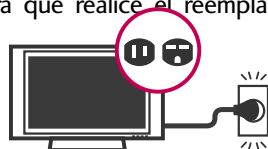

- 6 Proteja el cable de alimentación para que no lo pisen ni aplasten, especialmente en las clavijas, las tomas y el punto de salida del aparato



- 7 Utilice únicamente acoplamiento y accesorios especificados por el fabricante.



- 8 Utilícelo sólo con el estante fijo o con ruedas, trípode, soporte o mesa especificados por el fabricante o con el accesorio suministrado con el aparato. Si utiliza un carrito, tenga cuidado al moverlo junto con el aparato para evitar lesiones en caso de que éste se caiga.



- 9 Desenchufe este producto en caso de no utilizarlo durante un largo periodo de tiempo. Desenchufe este equipo durante tormentas con aparato eléctrico o si no piensa usarlo durante largos períodos de tiempo.

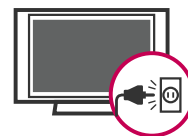

- 10 Sólo el personal calificado puede encargarse del servicio técnico. La asistencia técnica es necesaria si el aparato presenta algún daño, como por ejemplo, si el cable o la clavija de alimentación están dañados, si se derrama líquido o se introducen objetos dentro del aparato, si el aparato ha estado expuesto a la lluvia o humedad, si no opera correctamente o si se ha caído.

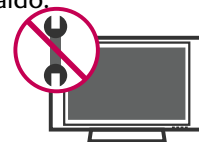

INSTRUCCIONES DE SEGURIDAD

11 No toque el aparato o la antena durante una tormenta eléctrica.

12 Cuando monte el televisor en la pared, asegúrese de no colgar el televisor en cables eléctricos y de señal de la parte trasera.

13 No golpee el producto ni permita que le caigan objetos encima ni en la pantalla.

14 **PRECAUCIÓN** en cuanto al cable de alimentación: Se recomienda colocar la mayoría de los aparatos en un circuito dedicado. Es decir, un circuito de salida única que alimenta sólo a ese aparato y que no tiene tomas o circuitos adicionales. Compruebe la página de especificaciones de este manual del propietario para estar seguro.

No conecte demasiados electrodomésticos a la misma toma de pared de corriente alterna ya que hacerlo podría suponer riesgo de incendio o choque eléctrico.

No sobrecargue las tomas de pared. Las tomas de pared sobrecargadas, sueltas o dañadas, los alargadores, los cables de alimentación deshilachados o el aislante agrietado de los cables podrían resultar peligrosos. Cualquiera de estas condiciones podría provocar un incendio o una descarga eléctrica. Examine periódicamente el cable de su aparato y si parece dañado o deteriorado, desenchúfelo, deje de usarlo y solicite al centro de servicio técnico autorizado que lo sustituyan por un nuevo equivalente. Proteja el cable de alimentación de daños físicos o mecánicos y evite doblarlo, aplastarlo, pellizcarlo o pisarlo con una puerta o caminar sobre él. Ponga especial atención en los enchufes, tomas de pared y el punto por donde el cable sale del aparato.

No manipule la TV con el cable de alimentación enchufado. No utilice cables de alimentación dañados o mal conectados. Asegúrese de desenchufar el cable de alimentación sujetando el enchufe. No tire del cable de alimentación para desenchufar la TV.

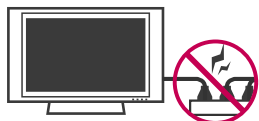

15 **ADVERTENCIA** - A fin de reducir el riesgo de incendio o choque eléctrico, no esponga este aparato a la lluvia, humedad u otros líquidos. No toque la TV con las manos mojadas. No instale este producto cerca de objetos inflamables como gasolina o velas, ni esponga la TV al flujo directo de aparatos de aire acondicionado.



16 No esponga este aparato a goteos o salpicaduras, ni coloque sobre él objetos que contengan líquidos, como floreros, tazas, etc. (por ejemplo en estantes sobre la unidad).



17 TOMA A TIERRA

Asegúrese de conectar el cable de toma a tierra para evitar posibles descargas eléctricas. (es decir, que una TV con un enchufe de tres polos, debe conectarse a una toma de pared con tres polos). Si no es posible la puesta a tierra, contacte con un electricista calificado para que instale un interruptor automático independiente. No intente conectar la unidad a tierra mediante cables telefónicos, pararrayos o tuberías de gas.

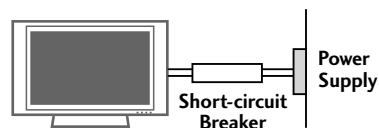

18 **DESCONECTAR EL DISPOSITIVO DE LA RED**
Este dispositivo se desconecta desenchufándolo del cable de red. El enchufe debe con tar con un acceso sin obstáculos.

19 Mientras esta unidad esté conectada a un tomacorriente de ca se desconectará de dicha fuente aunque apague la unidad mediante el INTERRUPTOR DE PRENDIDO.

20 ANTENAS

Conexión a tierra de la antena exterior

Si dispusiera de una antena exterior instalada, tome las medidas de seguridad que se exponen a continuación. Los sistemas de antenas exteriores no deben situarse cerca de tendidos eléctricos u otros circuitos de iluminación eléctrica o de suministro, ya que podrían entrar en contacto con dichos tendidos o circuitos eléctricos provocando lesiones graves e incluso la muerte.

Asegúrese de que el conjunto de la antena disponga de toma de tierra que lo proteja de posibles subidas de tensión y de acumulación de cargas estáticas.

La sección 810 del Código eléctrico nacional (NEC) de los EE.UU., proporciona información relativa a la correcta puesta a tierra del mástil y la estructura de soporte, de la parte inicial del cable a una unidad de descarga de antena, la sección de los conductores de puesta a tierra, emplazamiento de las unidades de descarga de antena, la forma de conectar los electrodos a tierra, así como los requisitos que deben cumplir dichos electrodos.

Puesta a tierra de una antena de acuerdo con el Código eléctrico nacional, ANSI/NFPA 70

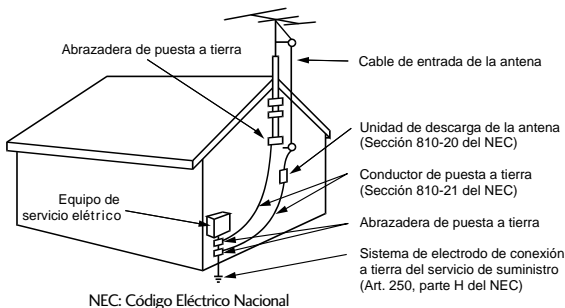

21 Limpieza

Antes de iniciar labores de limpieza, desenchufe el cable de alimentación y limpie cuidadosamente la unidad con un paño suave para evitar arañazos superficiales. No rocíe directamente agua vaporizada u otros líquidos sobre la TV para evitar posibles choques eléctricos. No limpie la unidad con productos químicos como alcoholes, disolventes o benceno.

22 Transporte

Asegúrese de que el producto esté apagado, desenchufado y que todos los cables hayan sido desconectados. Harán falta dos o más personas para transportar TVs de gran tamaño. No someta el panel frontal de la TV a presiones o esfuerzos excesivos.

23 Ventilación

Instale su TV en un lugar que disponga de ventilación apropiada. No la instale en espacios cerrados como, por ejemplo, una estantería. No cubra el producto con paños u otros materiales, como plásticos, mientras esté enchufada. No instale la unidad en lugares con exceso de polvo.

24 Tenga cuidado de no tocar las aberturas de ventilación. Al ver la televisión durante un largo período, la aberturas de ventilación pueden calentarse.

25 Si percibe olor a quemado o de cualquier otro tipo, o detecta sonidos extraños procedentes de su TV, desenchufe el cable de alimentación y contacte con el servicio técnico autorizado.

26 No presione en exceso el panel con sus manos u objetos afilados, como tornillos, lápices o bolígrafos, y evite rayarlo.

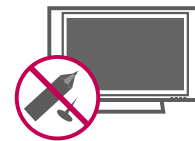

27 Mantenga el producto lejos de la luz directa del sol.

CONTENIDO

ADVERTENCIA / PRECAUCIÓN	2
ADVERTENCIA	3
FUNCIONES DE ESTE TV	8

PREPARACIÓN

Accesorios	9
Información del panel frontal	10
Información del panel posterior	13
Instrucciones	15
Organizador de cables	17
Instalación de un pedestal de escritorio	18
Soporte del eslabon giratorio	18
Montaje para la pared VESA	19
Fijación de la TV a la pared para evitar que se caiga cuando esté instalada sobre un soporte tipo pedestal	20
Conexión de la Antena o cable	21

CONEXIONES DE EQUIPO EXTERNO

Instalación del HDSTB	22
Instalación del DVD	25
Instalación del VCR	27
Configuración de otra fuente de A/V	28
Conexión USB	28
Conexión de salida de Audio	29
Instalación de la PC	30

VER LA TV / CONTROL DE CANAL

Funciones de los botones del control remoto	36
Encendido del TV	38
Ajuste del Canal	38
Ajuste del volumen	38
Configuración Inicial	39
Selección y ajuste del menú pantalla	40
Quick Menu (menú rápido)	42
Búsqueda de canales	
- Escaneo automático (Sintonización automática) ...	43

- Agregar/Eliminar los Canales (Sintonización Manual)	44
- Edición de Canal	45
Lista de Canales	46
Configuración de los canales favoritos	47
Lista de Favoritos	47
Info. Breve	48
Lista de entradas	49
Etiqueta de entrada	50
Modo AV	51
SIMPLINK	52

USB

Modos de Entrada	54
Lista de Fotos	55
Lista de Música	61

CONTROL DE IMAGEN

Tamaño de la Imagen (Control de Relacion de aspecto)	64
Asistente de Imagen	66
 Ahorro de Energía	68
Ajustes de la Imagen Prestablecida (Modo imagen)	69
Control Manual de Imagen- Modo usuario	70
Tecnología de Mejora de la Imagen	71
Control Experto de Imagen	72
Restablecimiento de la imagen	74
Modo Demo	74
Minimización de imagen fantasma	75

CONTROL DE SONIDO Y DE IDIOMA

Nivelador Automático de volumen	76
Voz Clara II	77
Ajuste de sonido preestablecido (Modo de audio) ..	78
Ajuste de sonido - Modo usuario	79
Ajuste de Balance	81
Disposición de bocinas de TV	82
Reajuste de audio	83
Disfrute de la transmisión Estéreo/SAP	84
Idioma del audio	85
Selección del lenguaje en la pantalla	86
Subtítulos	
- Sistemas de texto oculto de programas analógicos ..	87
- Sistemas de texto oculto de programas digitales ..	88
- Opciones del texto oculto	89

CONFIGURACIÓN HORARIA

Programación del reloj	
- Configuración Auto del Reloj	90
- Configuración Manual del Reloj	91
Ajustes de Encendido / Apagado Automático del temporizador	92
Configuración del temporizador de apagado automático	93

CONTROL PATERNO /CLASIFICACIONES

Establecer contraseña y bloqueo del sistema ..	94
Bloqueo de canales	97
Clasificaciones de Películas y TV	98
Clasificación Descargable	103

Bloqueo de entrada externa	104
Bloqueo de teclas	105

APÉNDICE

Lista de verificación de problemas	106
Mantenimiento	108
Especificaciones del producto	109
Códigos de IR	112
Configuración de dispositivo externo del control ...	114

FUNCIONES DE ESTE TV

- Esta característica no se encuentra disponible para todos los modelos.



Televisión de alta definición. El sistema de emisión y reproducción de TV digital de alta resolución está compuesto por casi un millón o más de píxeles, pantallas con relación de aspecto 16:9 y audio digital AC3. Un sub-equipo de TV digital, formato HDTV incluye resoluciones de 1 080 entrelazado y 720 progresivo.



Este televisor cuenta con las calibraciones concretas necesarias para la certificación profesional por parte de la Imaging Science Foundation. El usuario podrá acceder a los modos "día" y "noche" ISF resultantes a fin de aprovechar al máximo todo lo que su HDTV de LG puede ofrecer.

CALIBRE COMO UN PROFESIONAL:

El modo ISFccc permite realizar calibraciones sofisticadas y detalladas.

La realización de calibraciones detalladas debe ser realizada por un técnico certificado.

Por favor, contacte con su distribuidor local para solicitar la asistencia de un técnico certificado por ISF.



El modo AV dispone de tres ajustes preestablecidos de imagen y audio. Este permite al espectador cambiar rápidamente entre los ajustes comunes. Incluye los modos Cine, Deportes y Juego.



Mejora y amplifica automáticamente el sonido dentro del rango de frecuencia de la voz humana para ayudar a mantener audibles los diálogos ante un aumento del ruido de fondo.



Muestra una definición FULL HD 1 920 x 1 080 progresivo para una imagen mas detallada.



Fabricado bajo licencia de Dolby Laboratories. "Dolby" y el símbolo de la doble-D son marcas comerciales de Dolby Laboratories.



HDMI™, el logotipo HDMI y el interfaz multimedia de alta definición son marcas comerciales o registradas de HDMI Licensing LLC."



A diferencia de otros sensores que sólo detectan la luminosidad de la luz ambiental, el "Sensor inteligente" de LG usa 4 096 niveles de detección para evaluar su entorno. Usando un sofisticado logaritmo, el televisor LG procesa elementos relativos a la calidad de imagen incluyendo el brillo, contraste, color, nitidez y el balance de blancos. El resultado es una imagen optimizada para su entorno, más agradable para el espectador y capaz de ahorrar hasta un 50% del consumo eléctrico.



Ver vídeos, fotos y escuchar música en su TV a través de USB 2.0 ("vídeos" depende del modelo).



INFORMACIÓN IMPORTANTE PARA EVITAR EL EFECTO "DEGRADACIÓN DE LA IMAGEN POR SOBREEXPOSICIÓN / QUEMADO" EN LA PANTALLA DE SU TELEVISOR

- Al visualizar una imagen fija (Ej.: logotipos, menús de pantalla, videojuegos e imágenes procedentes de computadoras) en el televisor durante un período de tiempo prolongado, dicha imagen puede quedar impresa permanentemente sobre la pantalla. Este fenómeno se conoce como "degradación de la imagen por sobreexposición" o "quemado". Problema que no está cubierto por la garantía del fabricante.
- A fin de evitar la degradación de la imagen por sobreexposición, no permita la visualización de imágenes fijas en su pantalla durante un período de tiempo prolongado (2 horas o más para una pantalla LCD, 1 hora o más para pantallas de plasma).
- El efecto de degradación de imagen por sobreexposición también puede producirse en las zonas de bandas del formato letterbox (apaisado) de su televisor si usa el ajuste de formato de pantalla en 4:3 durante un período de tiempo prolongado.

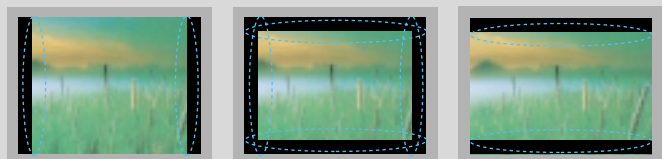

PREPARACIÓN

ACCESORIOS

Asegurese de que los siguientes accesorios estén incluidos con su TV. Si algún accesorio no está incluido, favor de contactar al distribuidor del producto en el lugar donde realizó la compra.

Los accesorios que se incluyen pueden ser diferentes a los de las imágenes a continuación.

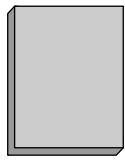

Manual de Usuario

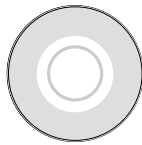

Manual en CD

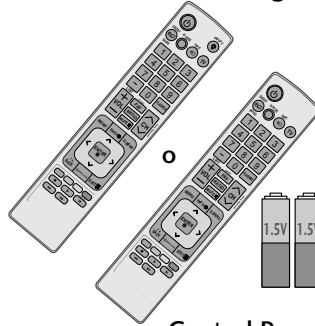

Control Remoto,
Baterías

(Excepto 60PK250, 60PK540,
60PK550, 60PK280, 60PK290,
60PK550C)



Cable de
Alimentación

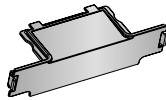

Cubierta de protección
(Refiérase a la p.16)



x 4

M4x28



x 3

M5x14

para la base
ensamblada
(Refiérase a la p.15)



x 2

Sujetacables



Paño de limpieza
(No incluido en todos los modelos)

- * Solo limpie las manchas exteriores con un paño.
- * No limpie con demasiada fuerza para intentar quitar las manchas. Tenga cuidado, ya que si limpia con demasiada fuerza podría rayar o decolorar la superficie.

Opciones Extras (Adicionales)

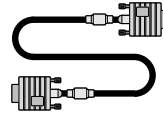

Cable D-sub de 15 ter-
minales

Cuando utilice la conexión VGA (cable D-sub de 15 pins) para la PC, el usuario debe usar cables de interfaz de señal recubiertos (cable D-sub de 15 clavijas) con núcleos de ferrita para mantener el cumplimiento estándar del producto.



Núcleo de ferrita
(Gris)
(Esta característica no se encuentra disponible para todos los modelos.)

El núcleo de ferrita se puede utilizar para reducir las ondas electromagnéticas en el cable de audio del ordenador.
Enrolle dos veces el cable de audio del ordenador al núcleo de ferrita y después, conecte los cables a la TV como indica la imagen siguiente.

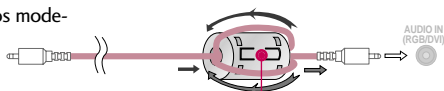

Coloque el núcleo de ferrita cerca de la toma de entrada de AUDIO (RGB/DVI) en la pantalla.



Núcleo de ferrita
(Negro)
(Esta característica no se encuentra disponible para todos los modelos.)

El núcleo de ferrita puede usarse para reducir la onda electromagnética al conectar el cable de alimentación.
Cuanto más cerca esté el núcleo de ferrita del tomacorriente, mejor será el resultado.



Introduzca firmemente el enchufe en el tomacorriente.

PREPARACIÓN

INFORMACIÓN DEL PANEL FRONTAL

■ Es probable que esta vista no coincida con su TV.

PREPARACIÓN

50/60PK550, 50/60PK540, 42/50PJ550, 50/60PK550C

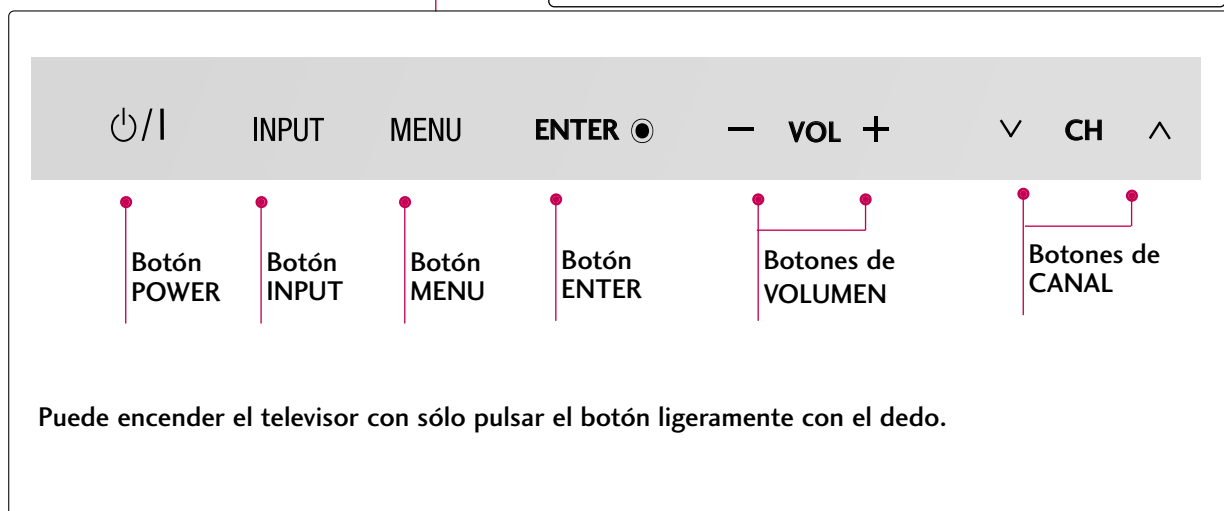
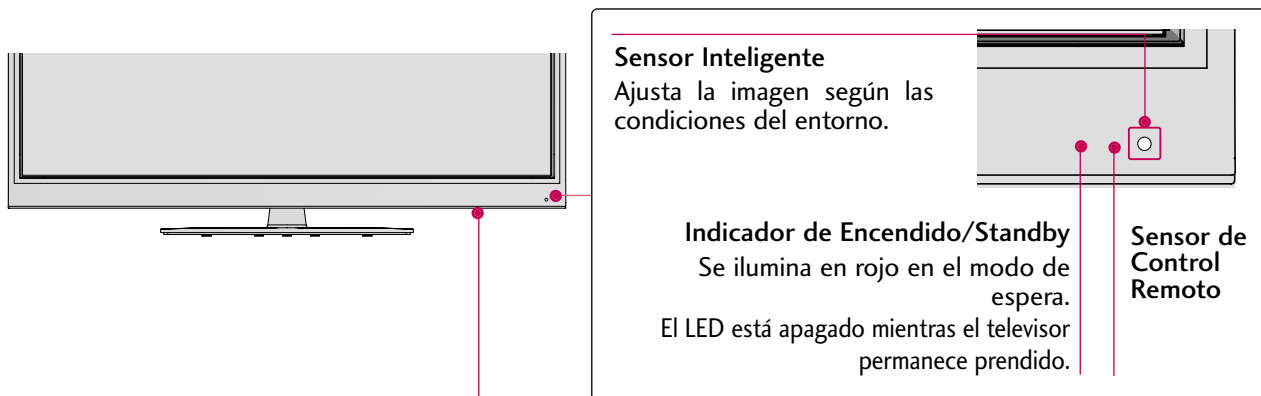

50/60PK250, 42/50PJ250, 60PK280, 60PK290

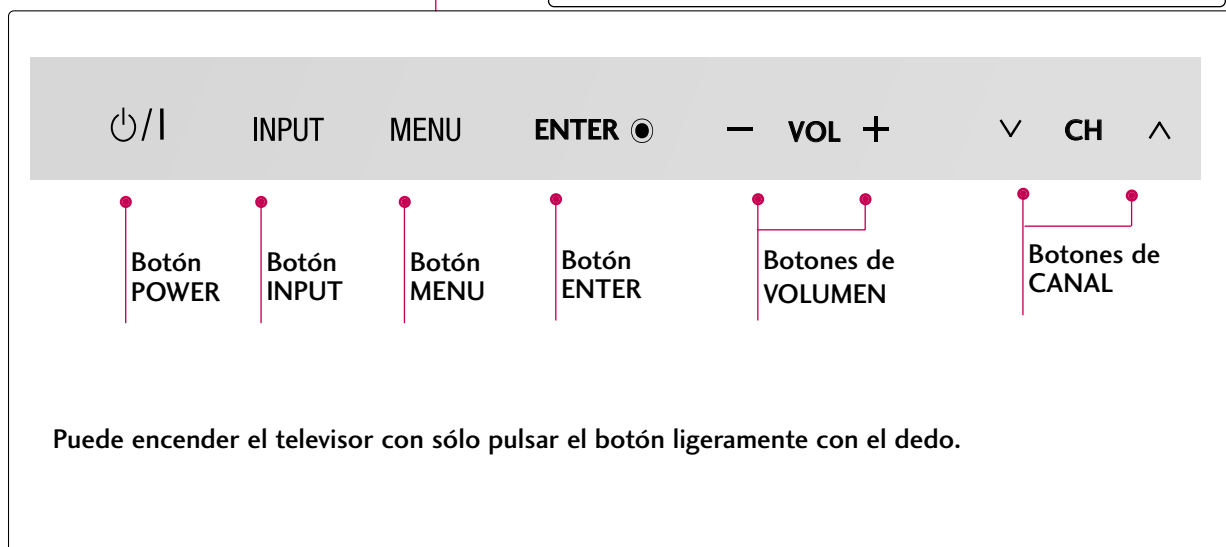
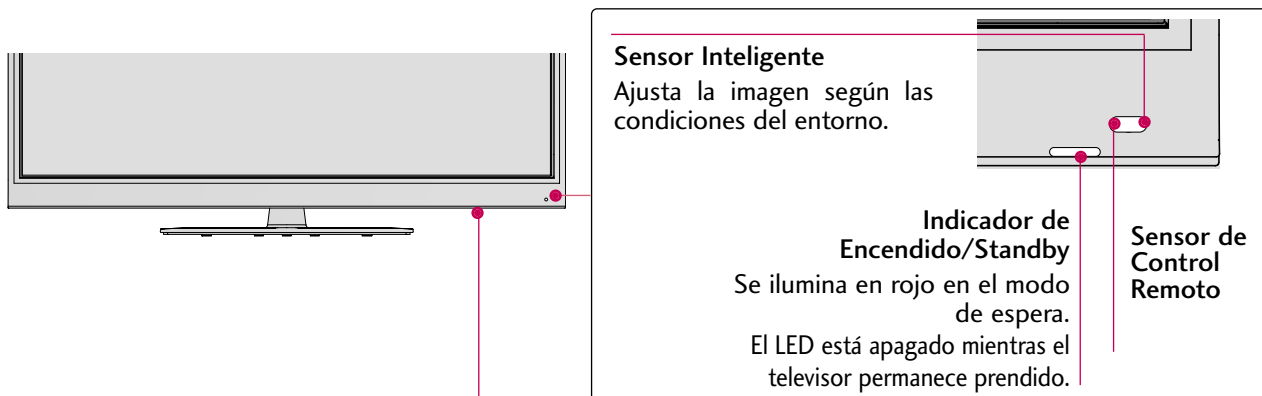

PREPARACIÓN

42/50PJ350, 42/50PJ340, 50PK340, 50PK350, 42/50PJ350C

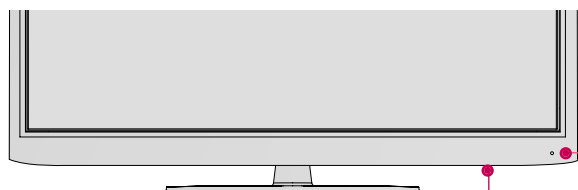

Sensor Inteligente

Ajusta la imagen según las condiciones del entorno.

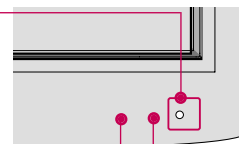

Indicador de Encendido/Standby

Se ilumina en rojo en el modo de espera. El LED está apagado mientras el televisor permanece prendido.

Sensor de Control Remoto



Botón POWER

Botón INPUT

Botón MENU

Botón ENTER

Botones de VOLUMEN

Botones de CANAL

Puede encender el televisor con sólo pulsar el botón ligeramente con el dedo.

- ▶ No se apoye sobre el cristal ni lo someta a ningún impacto. Si se rompe, los fragmentos de cristal podrían provocar lesiones o el televisor podría caer.
- ▶ No arrastre el televisor. El piso o el producto podría resultar dañado.

INFORMACIÓN DEL PANEL POSTERIOR

La imagen puede ser diferente a la de su televisor.

**42/50PJ250, 50/60PK250, 60PK280, 42/50PJ340,
50/60PK540, 50PK340**

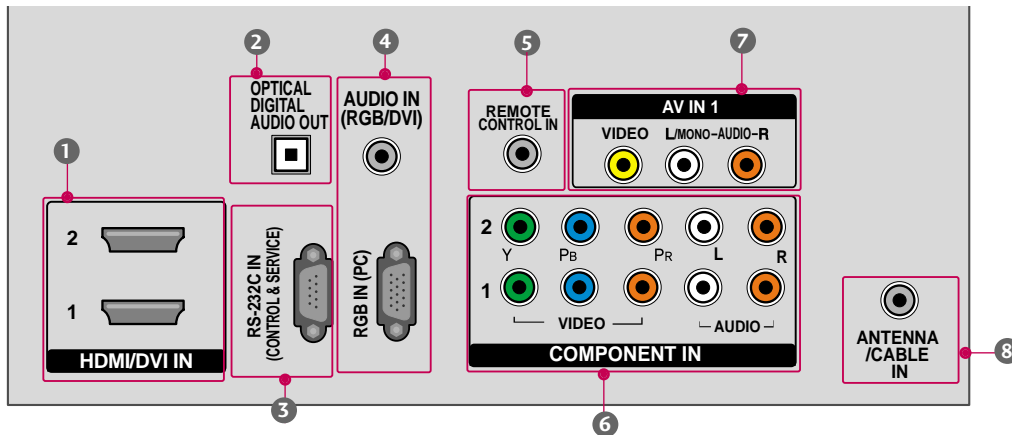
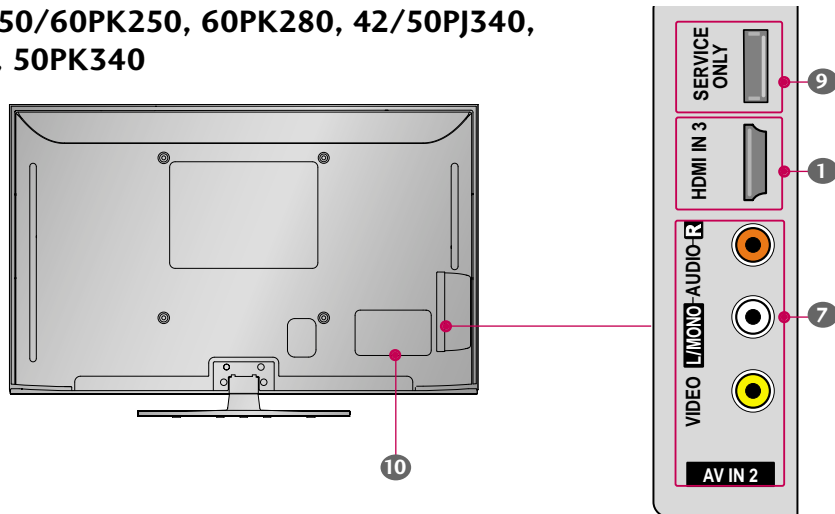

1 HDMI/DVI IN

Conexión digital. Compatible con video HD y audio digital. No es compatible con 480entrelazado.

Acepta video DVI con un adaptador o un cable de HDMI a DVI (no incluido)

2 OPTICAL DIGITAL AUDIO OUT (Salida de Audio Digital Óptico)

Salida óptica de audio digital para usar con amplificadores y sistemas de cine en casa.

Nota: En el modo de espera, este puerto no funciona.

3 RS-232C IN (CONTROL & SERVICE) PORT

Utilizado por otros fabricantes.

4 AUDIO IN (RGB)

Enchufe de auriculares 1/8" (0,3 cm) para la entrada de audio análoga de la PC.

RGB IN (PC)

Conexión análoga a la PC. Utilice un cable D-sub de 15 pins (cable VGA).

5 Puerto de Control Remoto

Para un control remoto con cables.

6 COMPONENT IN

Conexión análoga. Compatible con HD.

Utiliza un cable rojo, verde y azul para video y uno rojo y blanco para audio.

7 AV (Audio/Video) IN

Conexión análoga compuesta. Compatible solo con una definición de video estándar (480entrelazado).

8 ANTENNA/CABLE IN (Entrada de la Antena/Cable)

Conecte las señales de la transmisión a este puerto.

Conecte los cables de señal a este conector.

9 SERVICE ONLY

Utilizado para las actualizaciones de software.

10 Socket del Cordón de Alimentación

Esta TV funciona con alimentación de corriente alterna (ca) Cuidado: Nunca aplique voltaje de corriente continua (cc) a esta TV.

PREPARACIÓN

42/50PJ350, 50PK350, 50/60PK550, 42/50PJ550,
60PK290, 42/50PJ350C, 50/60PK550C

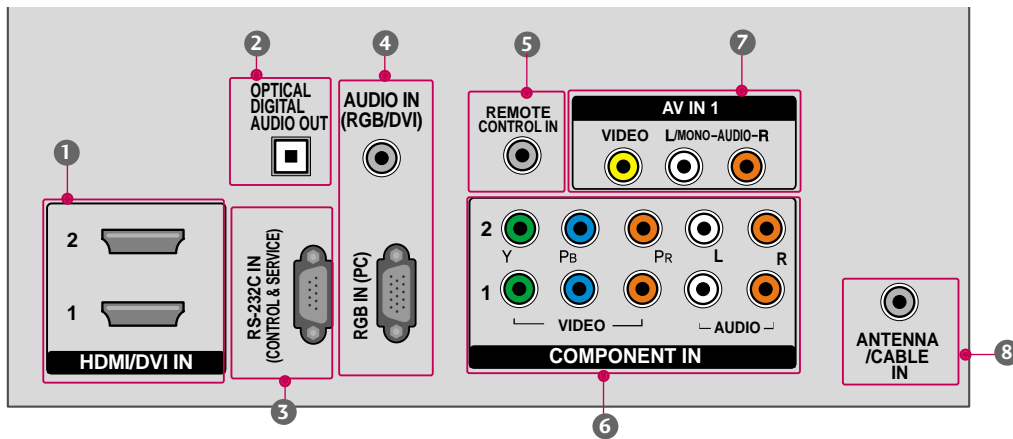
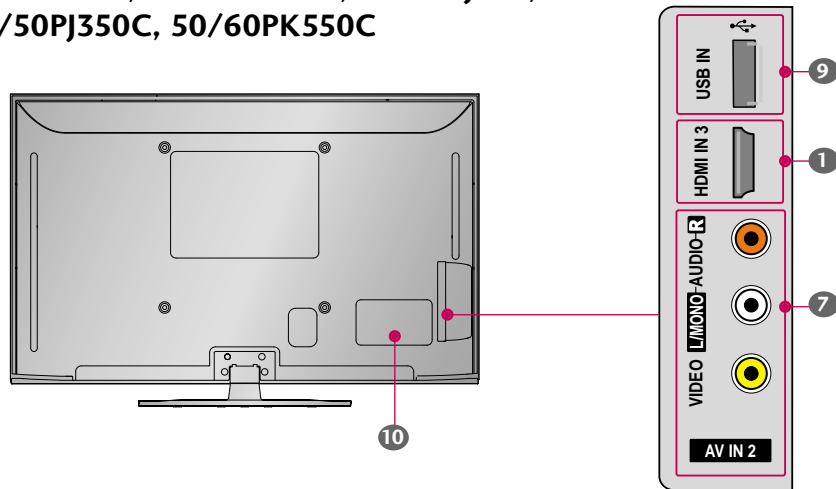

- 1 HDMI/DVI IN**
Conexión digital. Compatible con video HD y audio digital. No es compatible con 480entrelazado.
Acepta video DVI con un adaptador o un cable de HDMI a DVI (no incluido)
- 2 OPTICAL DIGITAL AUDIO OUT (Salida de Audio Digital Óptico)**
Salida óptica de audio digital para usar con amplificadores y sistemas de cine en casa.
Nota: En el modo de espera, este puerto no funciona.
- 3 RS-232C IN (CONTROL & SERVICE) PORT**
Utilizado por otros fabricantes.
- 4 AUDIO IN (RGB)**
Enchufe de auriculares 1/8" (0,3 cm) para la entrada de audio análogo de la PC.
RGB IN (PC)
Conexión análoga a la PC. Utilice un cable D-sub de 15 pins (cable VGA).
- 5 Puerto de Control Remoto**
Para un control remoto con cables.
- 6 COMPONENT IN**
Conexión análoga. Compatible con HD.
Utiliza un cable rojo, verde y azul para video y uno rojo y blanco para audio.
- 7 AV (Audio/Video) IN**
Conexión análoga compuesta. Compatible solo con una definición de video estándar (480entrelazado).
- 8 ANTENNA/CABLE IN (Entrada de la Antena/Cable)**
Conecte las señales de la transmisión a este puerto.
Conecte los cables de señal a este conector.
- 9 USB IN**
Utilizado para ver fotos, escuchar MP3.
- 10 Socket del Cordón de Alimentación**
Esta TV funciona con alimentación de corriente alterna (ca)
Cuidado: Nunca aplique voltaje de corriente continua (cc) a esta TV.

INSTRUCCIONES

- La imagen puede ser diferente a la de su televisor.

Instalación (Excepto 60PK250, 60PK540, 60PK550, 60PK280, 60PK290, 60PK550C)

- 1 Coloque con cuidado pantalla de la TV sobre una superficie acolchada que la proteja de posibles daños.

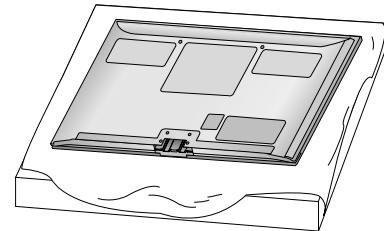

- 2 Coloque las piezas del soporte sobre la base de apoyo del televisor.

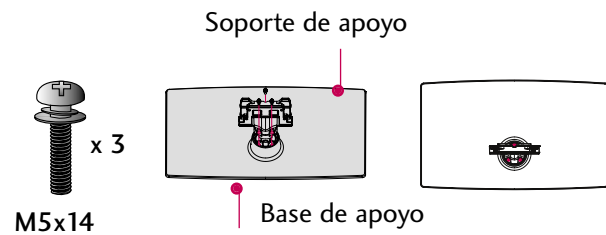

- 3 Monte la TV como se ilustra.

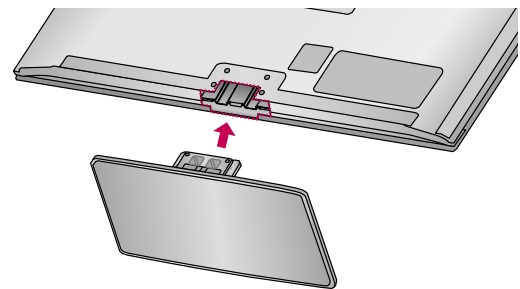

- 4 Ajuste firmemente los 4 pernos en los huecos de la parte posterior de la TV.

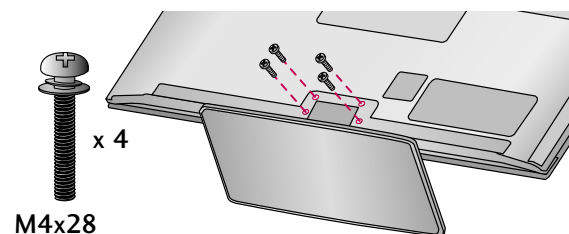

PREPARACIÓN

Separación

- 1 Coloque con cuidado pantalla de la TV sobre una superficie acolchada que la proteja de posibles daños.

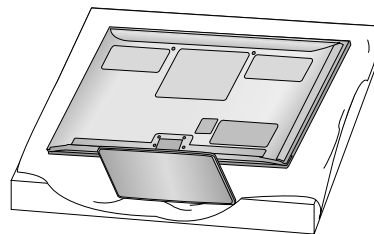

- 2 Afloje los tornillos del televisor.

(42/50PJ250, 50PK250,
42/50PJ340, 42/50PJ350,
50PK350, 50PK340, 50PK540,
42/50PJ550, 50PK550,
42/50PJ350C, 50PK550C)

(60PK250, 60PK540, 60PK550,
60PK280, 60PK290, 60PK550C)

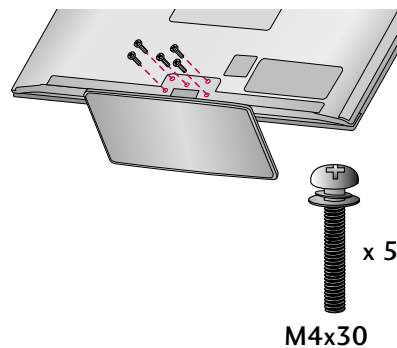
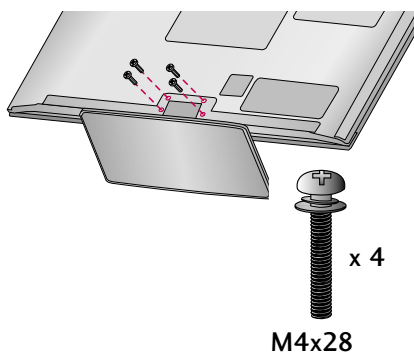

- 3 Separar el soporte del televisor

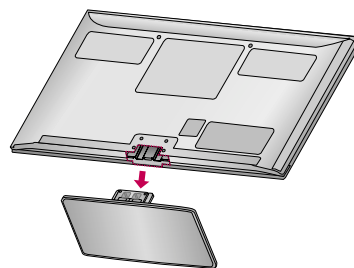

Cubierta de protección
(Fijar una guía para los exteriores).

Cubierta de protección

Tras extraer el soporte, instale la **CUBIERTA DE PROTECCIÓN** incluida sobre el hueco dejado por este.

Inserte la **CUBIERTA DE PROTECCIÓN** en el televisor hasta que escuche un sonido de chasquido.

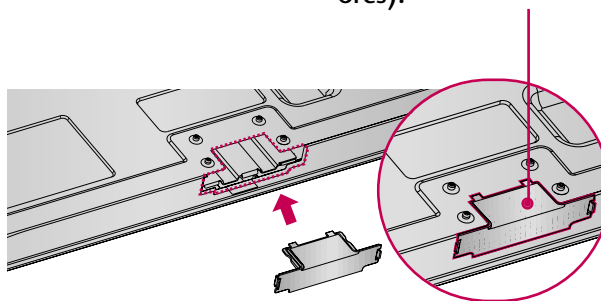

ORGANIZADOR DE CABLES

■ La imagen puede ser diferente a la de su televisor.

1 Tras conectar los cables como resulte necesario, instale el SUJETACABLES y una los cables como se muestra.

Para conectar un equipo adicional, vea la sección de **CONEXIONES DE EQUIPO EXTERNO**.

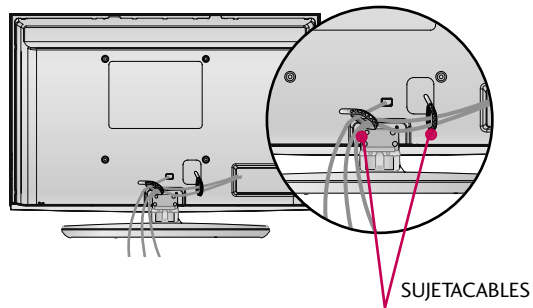

PREPARACIÓN

INSTALACIÓN DE UN PEDESTAL DE ESCRITORIO

- La imagen puede ser diferente a la de su televisor.

Para conseguir una ventilación adecuada, deje un espacio de 10,1 cm de separación entre la pared y los costados del televisor.

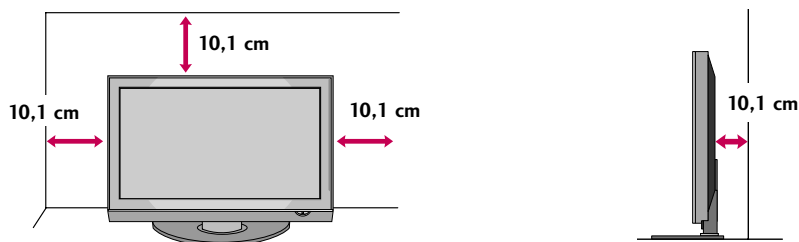

⚠ CUIDADO

- ▶ Asegure la ventilación adecuada dejando el espacio recomendado.
- ▶ No instale la unidad próxima o sobre ninguna fuente de calor.

SOPORTE DEL ESLABON GIRATORIO

(Esta característica no se encuentra disponible para todos los modelos.)

Después de instalar la TV, puede ajustar el TV manualmente 20 grados a la izquierda y derecha para satisfacer su ángulo de visión.

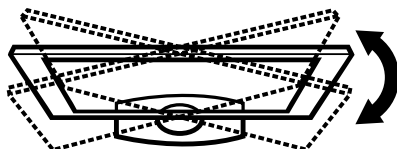

MONTAJE PARA LA PARED VESA

Realice la instalación mural sobre una pared sólida, perpendicular al suelo. Al montar sobre otros materiales de construcción, por favor, póngase en contacto con su instalador más cercano.
 En instalaciones del techo o sobre paredes inclinadas, la unidad puede caer y provocar graves daños personales. Le recomendamos que utilice un soporte de montaje de pared de la marca LG, cuando ud. ponga la TV en la pared. LG recomienda que el montaje de pared sea llevado a cabo por un instalador profesional cualificado.

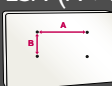
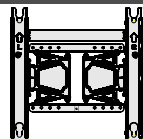
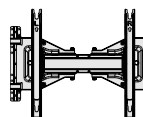
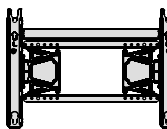
Modelos	VESA (A * B) 	Tornillo estándar	Cantidad	Soporte para instalación en pared (De venta por separado)
50PK550, 42/50PJ340 42/50PJ350, 42/50PJ250 50PK250, 50PK340, 50PK350, 50PK540, 42/50PJ550, 42/50PJ350C, 50PK550C	400 * 400	M6	4	 AW-50PG60MS  AW-50PG60M
60PK550, 60PK250, 60PK280, 60PK290, 50PK540, 60PK550C	600 * 400	M8	4	 AW-60PG60MS

! NOTA

- ▶ La longitud de los tornillos necesarios varía en función de la pared en la que se realice el montaje. Para obtener más información, consulte las instrucciones incluidas con el equipo de montaje.
- ▶ Las dimensiones estándar para el equipo de montaje mural se muestran en la tabla.
- ▶ Al adquirir nuestro equipo de montaje mural, le será suministrado un manual de instrucciones detallado y todas las piezas necesarias para la instalación.
- ▶ No utilice tornillos más largos que los de dimensión estándar mostrados, ya que podría dañar el interior de la TV.
- ▶ Para montajes murales que no cumplan con las especificaciones para tornillos del estándar VESA, la longitud de estos puede diferir dependiendo de sus especificaciones.
- ▶ No utilice tornillos que no cumplan con las especificaciones relativas a los mismos del estándar VESA. No apriete los tornillos en exceso, ya que podría dañar la TV o provocar que cayera provocando daños personales. LG no se hace responsable de este tipo de accidentes.
- ▶ LG no se hace responsable por los daños ocasionados en la TV o las lesiones personales producidas cuando no se utilice un equipo de montaje que cumpla con el estándar VESA o se monte sobre un muro que no haya sido especificado o si el cliente no sigue las instrucciones de instalación de la TV.

! PRECAUCIÓN

- ▶ No instale su equipo de montaje mural mientras la TV está encendida. Eso podría provocar lesiones personales por choques eléctricos.

FIJACIÓN DE LA TV A LA PARED PARA EVITAR QUE SE CAIGA CUANDO ESTÉ INSTALADA SOBRE UN SOPORTE TIPO PEDESTAL.

- Debe adquirir los componentes necesarios para prevenir que el televisor vuelque (cuando no se use el montaje de pared).
- La imagen puede ser diferente a la de su televisor.

Instalelo cerca de la pared así el producto no se cae cuando esté presionado hacia atrás.

Las instrucciones mostradas a continuación son más seguras para instalar el producto en la pared así no se caerá cuando el producto esté presionado hacia enfrente. Esto protegerá el producto y la gente de la caída hacia enfrente. También prevendrá el producto del daño causado por la caída.

Cuidado:Favor de estar seguro de que los niños no se suban ni se cuelguen del producto.

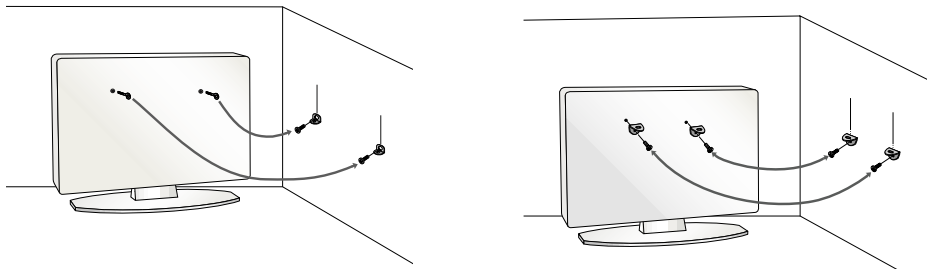

- Use los soportes y los pernos para fijar el producto en la pared como se muestra.
 - * Si el producto tiene los pernos en el lugar de los pernos de ojo antes de insertar estos últimos, afloje los pernos. Asegúrese de los soportes con los pernos (De venta por separado) en la pared que estén ajustados firmemente. Para usar el producto seguramente asegúrese de que la altura de los soportes montados en la pared sea la misma que la del producto.
- Asegúrese de que los pernos de ojo o soportes estén apretados en forma segura.

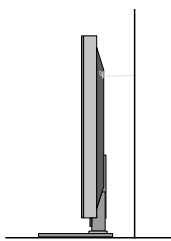

- Use un cordón fuerte (De venta por separado) para ajustar el producto. Es más seguro usar un cordón, así se quedará horizontalmente entre la pared y el producto.

! NOTA

- ▶ Utilice una plataforma o armario suficientemente fuerte y grande para soportar el tamaño y el peso de la TV.
- ▶ Para utilizar la TV con seguridad, asegúrese que la altura los soportes están a la misma altura en la pared y en el aparato de televisión.

- Para prevenir daños, no conecte a la corriente hasta que estén instaladas todas las conexiones entre los dispositivos.

CONEXIÓN DE LA ANTENA O CABLE

1. Antena (analógica o digital)

Toma de entrada de pared o antena exterior sin conexiones a caja de cables.

Para lograr la mejor calidad de imagen, ajuste la posición de la antena si fuera necesario.

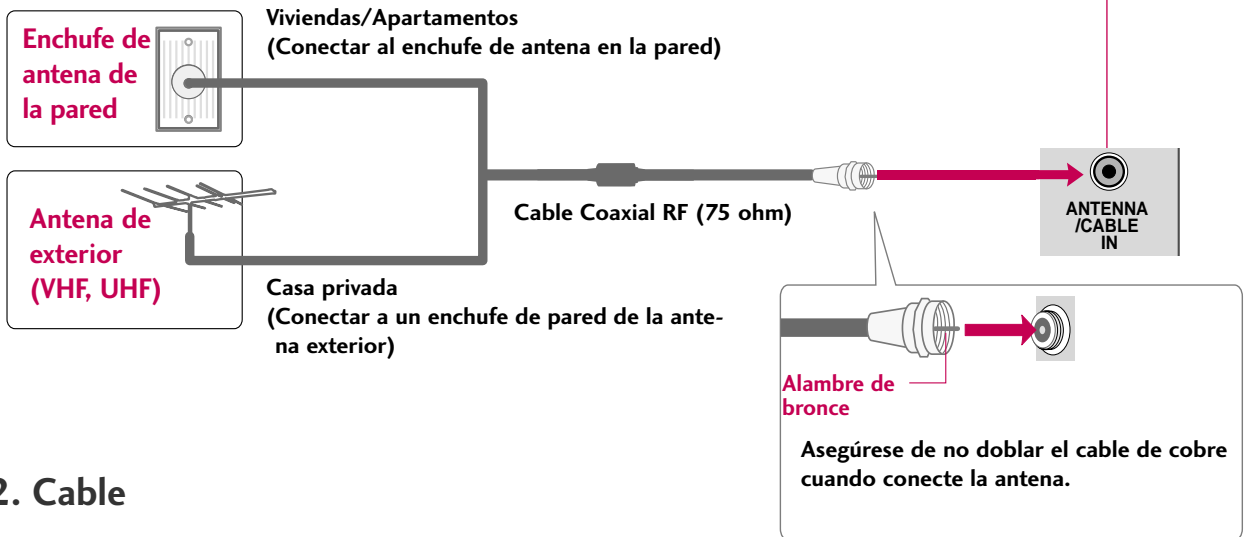

2. Cable

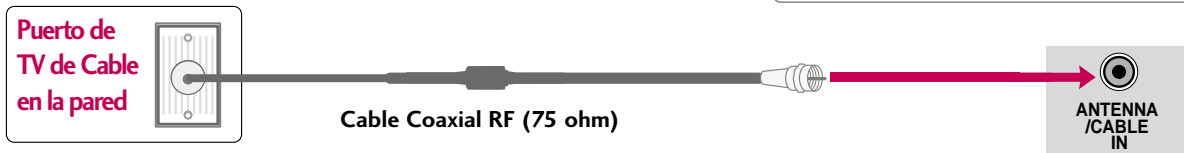

- En áreas de señal deficiente, puede obtener una mejor calidad en la imagen si instala un amplificador de señal.
- Si está siendo utilizada una antena para dos unidades, use un divisor de señal para conectarse.
- El cable y el convertidor de antena no son proporcionados con el producto.

CONEXIONES DE EQUIPO EXTERNO

- Para evitar daños en el equipo, no enchufe ningún cable de alimentación hasta haber finalizado la conexión completa de todo el equipo.
- La imagen puede ser diferente a la de su televisor.

INSTALACIÓN DEL HDSTB

Este TV puede recibir señales de la transmisión digital/cable sin una caja sintonizadora externa. Pero si ud. recibe señales digitales desde una caja sintonizadora u otro dispositivo externo digital, refiérase a las siguientes figuras.

Conexión de componentes

1. Cómo conectar

- 1 Conecte las salidas de video (Y, PB, PR) del decodificador digital a los puertos de **COMPONENT IN VIDEO 1** en la unidad. Haga coincidir los colores de los conectores (Y = Verde, PB = Azul, PR = Rojo).
- 2 Conecte la salida de audio del decodificador digital a los puertos de **COMPONENT IN AUDIO 1** en la unidad.

2. Cómo usar

- Encienda el Set-top box digital.
(Refiérase al manual de usuario del Set-top box digital.)
- Seleccione la fuente de entrada del **Componente 1** en el televisor con el botón de **INPUT** en el control remoto.
- Si está conectado a la entrada **COMPONENT IN 2** seleccione la fuente de entrada del **Componente 2** en el televisor.

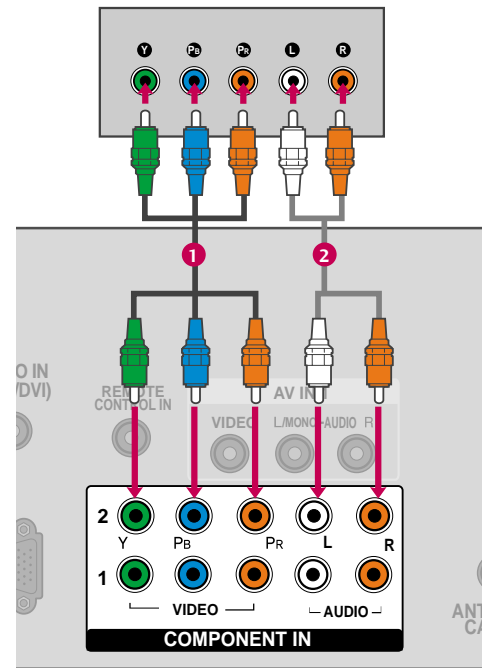

Resoluciones compatibles

Señal	Componente	HDMI
480 entrelazado	Sí	No
480 progresivo	Sí	Sí
720 progresivo	Sí	Sí
1 080 entrelazado	Sí	Sí
1 080 progresivo	Sí	Sí

Y, CB/PB, CR/PR

Resolución	Frecuencia Horizontal(kHz)	Frecuencia Vertical(Hz)
720x480 entrelazado	15.73	59.94
720x480 progresivo	31.47	60.00
1280x720 progresivo	44.96	59.94
1920x1080 entrelazado	33.72	59.94
1920x1080 progresivo	33.75	60.00
	27.00	24.00
	33.75	30.00
	67.432	59.939
	67.50	60.00
	26.97	23.94
	33.71	29.97

Conexión HDMI

1. Cómo conectar

- 1 Conecte la salida HDMI del decodificador de señales digitales al conector **HDMI/DVI IN 1, 2 o 3**.
- 2 No se necesita conexión de audio por separado. HDMI admite audio y video.

2. Cómo usar

- Encienda el decodificador digital. (Refiérase al manual de usuario del decodificador digital.)
- Seleccione la fuente de entrada del **HDMI 1, 2 o 3** en el televisor con el botón de **INPUT** en el control remoto.

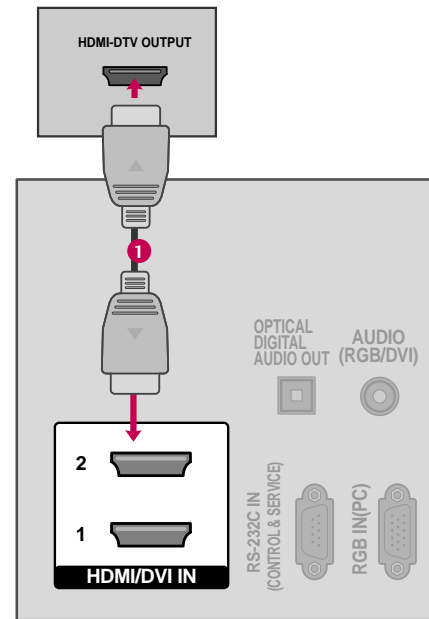

! NOTA

- ▶ Verifique que el cable HDMI admita la versión 1.3. Los cables HDMI que no admiten la versión 1.3 de HDMI, provocan parpadeos o no muestran la imagen en pantalla. Si este es el caso, utilice cables recientes que soporten la versión 1.3 de HDMI.
- ▶ El modo HDMI admite formato de audio PCM, AC-3 (Dolby Digital).

HDMI-DTV

Resolución	Frecuencia Horizontal(kHz)	Frecuencia Vertical(Hz)
720x480 progresivo	31.47	59.94
	31.47	60.00
1280x720 progresivo	44.96	59.94
	45.00	60.00
1920x1080 entrelazado	33.72	59.94
	33.75	60.00
1920x1080 progresivo	27.00	24.00
	33.75	30.00
	67.432	59.939
	67.50	60.00
	26.97	23.94
	33.71	29.97

CONEXIONES DE EQUIPO EXTERNO

Conexión de DVI a HDMI

1. Cómo conectar

- 1 Conecte la salida de DVI del decodificador digital al puerto de **HDMI/DVI IN 1, 2 o 3** en la unidad.
- 2 Conecte las salidas de audio del decodificador al puerto de **AUDIO IN (RGB/DVI)** en la unidad.

2. Cómo usar

- Encienda el decodificador digital. (Refiérase al manual de usuario del decodificador digital.)
- Seleccione la fuente de entrada del **HDMI 1, 2 o 3** en el televisor con el botón de **INPUT** en el control remoto.

! NOTA

- ▶ Se precisa un cable o adaptador de DVI a HDMI para realizar esta conexión. El DVI no es compatible con el audio, por ello, se necesita una conexión de audio por separado.

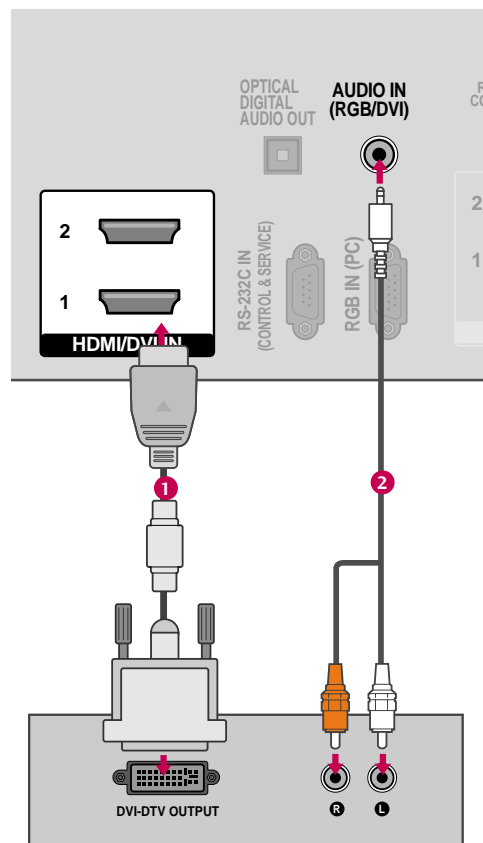

INSTALACIÓN DEL DVD

Conexión de componentes

1. Cómo conectar

- 1 Conecte las salidas de video (Y, PB, PR) del DVD a los puertos de **COMPONENT IN VIDEO 1** en la unidad. Haga coincidir los colores de los conectores (Y = Verde, PB = Azul, PR = Rojo).
- 2 Conecte las salidas de audio del DVD a los puertos de **COMPONENT IN AUDIO 1** en la unidad.

2. Cómo usar

- Encienda el reproductor de DVD, inserte un DVD.
- Seleccione la fuente de entrada del **Componente1** en el televisor con el botón de **INPUT** en el control remoto.
- Si está conectado a la entrada **COMPONENT IN 2** seleccione la fuente de entrada del **Componente2** en el televisor.
- Refiérase al manual de usuario del reproductor de DVD para seguir las instrucciones.

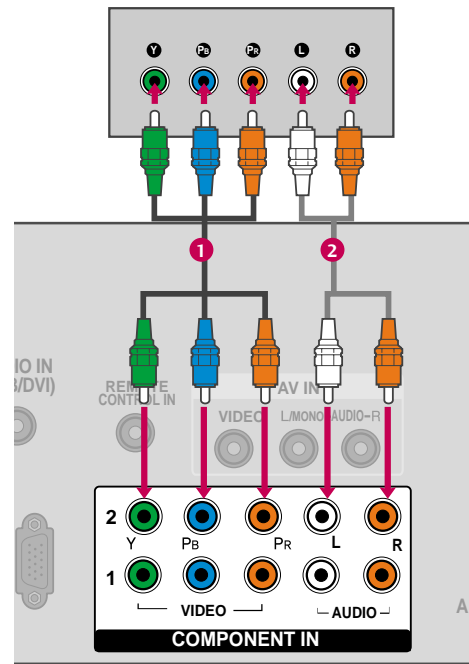

Puertos de la Entrada de Componente

Puede obtener una mejor calidad de imagen si conecta el reproductor de DVD a los puertos de la entrada del componente como la imagen mostrada.

Puertos de Componente en la TV	Y	P _B	P _R
Puertos de la salida del reproductor de DVD	Y	P _B	P _R
	Y	B-Y	R-Y
	Y	C _b	C _r
	Y	P _b	P _r

CONEXIONES DE EQUIPO EXTERNO

Conexión HDMI

1. How to connect

- 1 Conecte la salida de HDMI del DVD al puerto de **HDMI/DVI IN 1, 2 o 3** en la unidad.
- 2 No se necesita conexión de audio por separado. HDMI admite audio y video.

2. Cómo usar

- Seleccione la fuente de entrada del **HDMI1, 2 o 3** en el televisor con el botón de **INPUT** en el control remoto.
- Refiérase al manual de usuario del reproductor de DVD para seguir las instrucciones.

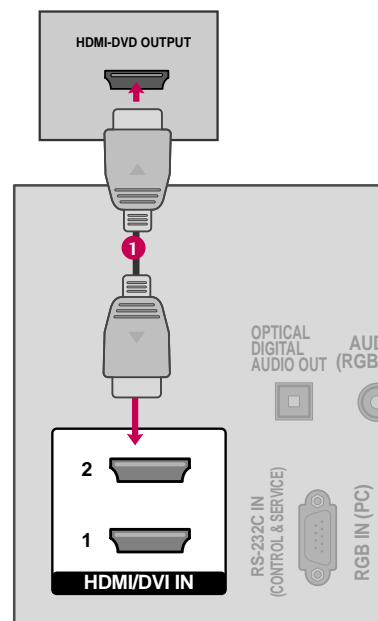

INSTALACIÓN DEL VCR

Conexión de la antena

1. Cómo conectar

- 1 Conecte el conector de la antena exterior de RF del VCR al conector de la **ANTENNA/CABLE IN** del televisor.
- 2 Conecte el cable de antena al puerto de la antena RF del VCR.

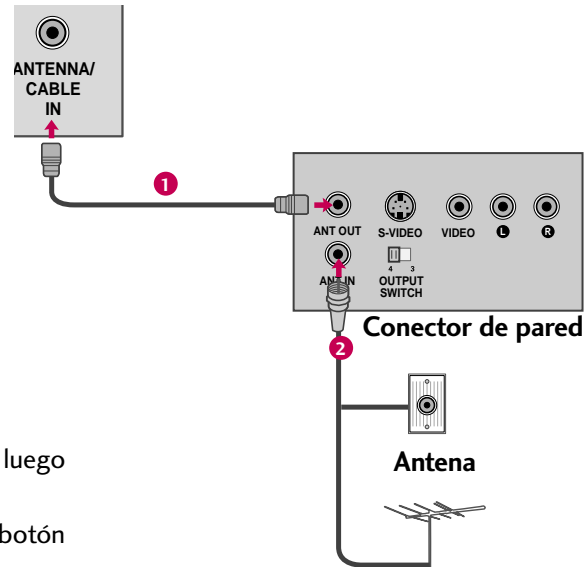

2. Cómo usar

- Ponga el interruptor de salida del VCR en 3 ó 4 y luego sintonice el televisor en el mismo número de canal.
- Inserte una cinta de video en el VCR y presione el botón **PLAY** del VCR.
(Vea el manual de usuario del VCR).

Conexión compuesta (RCA)

1. Cómo conectar

- 1 Conecte las salidas de **AUDIO/VIDEO** entre la TV y el VCR. Coincida los colores de salidas (Video = amarillo, Audio izquierdo = blanco, Audio derecho = rojo)

2. Cómo usar

- Inserte una cinta de video en el VCR y presione el botón **PLAY** del VCR. (Vea el manual de usuario del VCR).
- Seleccione la fuente de entrada del **AV1** en el televisor con el botón de **INPUT** en el control remoto.
- Si está conectado a la entrada **AV IN 2**, seleccione la fuente de entrada del **AV2** en el televisor.

! NOTA

- ▶ Si ud. tiene un VCR monofónico, conecte el cable de audio de VCR al puerto **AUDIO L/MONO** de la unidad.

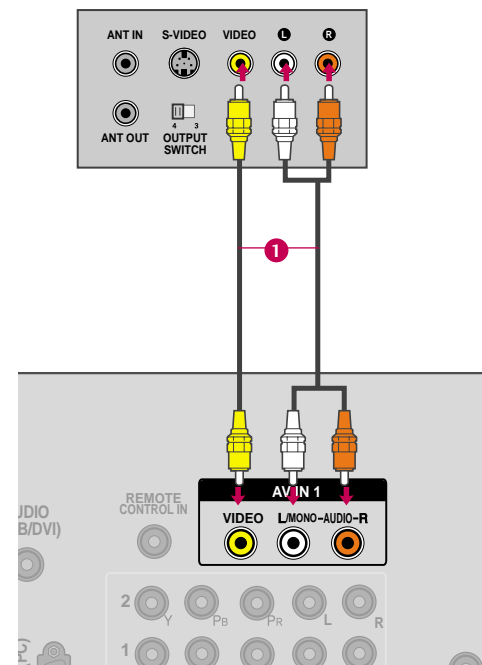

CONEXIONES DE EQUIPO EXTERNO

CONFIGURACIÓN DE OTRA FUENTE DE A/V

1. Cómo conectar

- 1 Conecte los puertos de **AUDIO/VIDEO** entre la TV y un equipo externo. Coincida los colores de puertos (Video = amarillo, Audio izquierdo = blanco, Audio derecho = rojo)

2. Cómo usar

- Seleccione la fuente de entrada del **AV 2** en el televisor con el botón de **INPUT** en el control remoto.
- Si está conectado a la entrada **AV IN 1** seleccione la fuente de entrada del **AV 1** en el televisor.
- Opere el equipo externo correspondiente. Refiérase a la guía de la operación de equipo externo.

Grabadora de video

Unidad de video juego

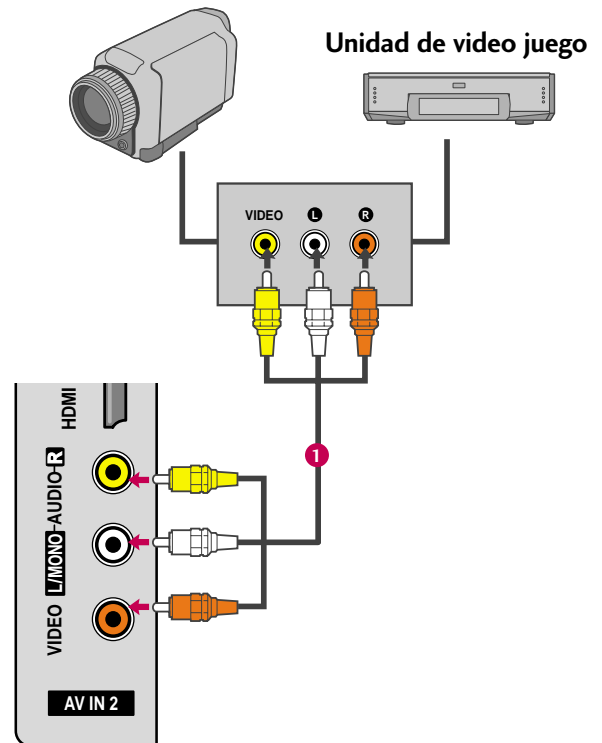

CONEXIÓN USB - Sólo 2/50PJ350, 50PK350, 42/50PJ550, 50/60PK550, 60PK290, 42/50PJ350C, 50/60PK550C models

1. Cómo conectar

- 1 Conecte el dispositivo USB a los conectores **USB IN** (Entrada de USB) en el televisor.

2. Cómo usar

- Una vez conectados los conectores **USB IN**, use la función USB. (► p.54)

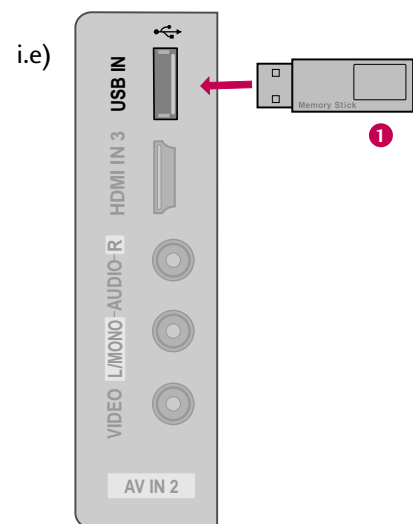

CONEXIÓN DE SALIDA DE AUDIO

Manda el audio de TV al equipo de audio externo (sistema de estéreo) por el puerto de Salida Óptica de Audio.

1. Cómo conectar

- 1 Conecte una salida del cable **OPTICAL** al puerto de TV óptico de la **DIGITAL AUDIO OUT**.
- 2 Conecte otro extremo de cable óptico a la entrada de audio digital óptico en el equipo de audio.
- 3 Ajuste la "Parlantes de TV - Apagado" en el menú **AUDIO**. (► p.82). Cuando se conecta a un equipo de audio externo como amplificadores o bocinas por favor apague las bocinas de TV.

! NOTA

- Cuando conecte equipos de audio externos, como amplificadores o bocinas, puede apagar los altoparlantes del televisor desde el menú. (► p.82)

! PRECAUCIÓN

- No mire dentro del puerto de salida óptica. Mirar el rayo láser puede dañar su vista.
- El audio con la función ACP (protección anticopia de audio) podrían bloquear la salida de audio digital.

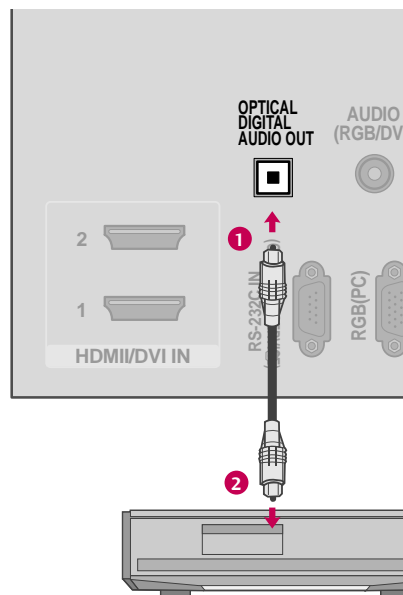

CONEXIONES DE EQUIPO EXTERNO

INSTALACIÓN DE LA PC

Esta TV proporciona la capacidad de Plug and Play, significa que la PC se ajusta automáticamente por las programaciones de la TV.

Conexión VGA (D-Sub de 15 pins)

1. Cómo conectar

- 1 Conecte la salida de VGA de la PC al puerto de **RGB IN (PC)** en la unidad.
- 2 Conecte las salidas de audio de la PC al puerto de **AUDIO IN (RGB/DVI)** en la unidad.

2. Cómo usar

- Encienda la PC y la unidad.
- Seleccione la fuente de entrada del **RGB-PC** en el televisor con el botón de **INPUT** en el control remoto.

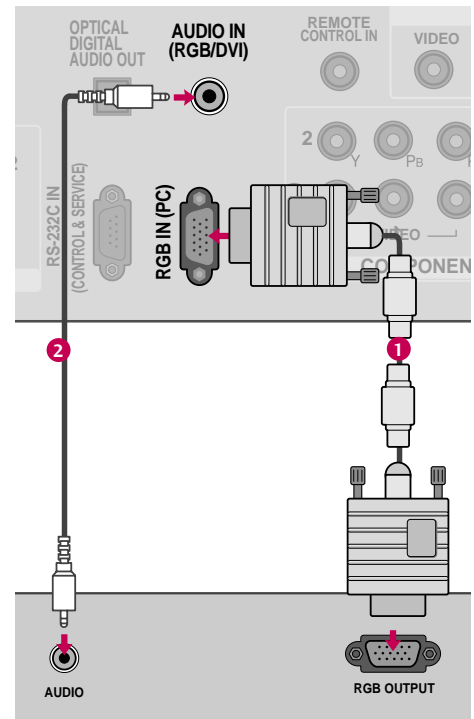

Conexión de DVI a HDMI

1. Cómo conectar

- 1 Conecte la salida de DVI de la PC al puerto de **HDMI/DVI IN 1, 2 o 3** en la unidad.
- 2 Conecte las salidas de audio de la PC al puerto de **AUDIO IN (RGB/DVI)** en la unidad.

2. Cómo usar

- Encienda la PC y la unidad.
- Seleccione la fuente de entrada del **HDMI1, 2 o 3** en el televisor con el botón de **INPUT** en el control remoto.

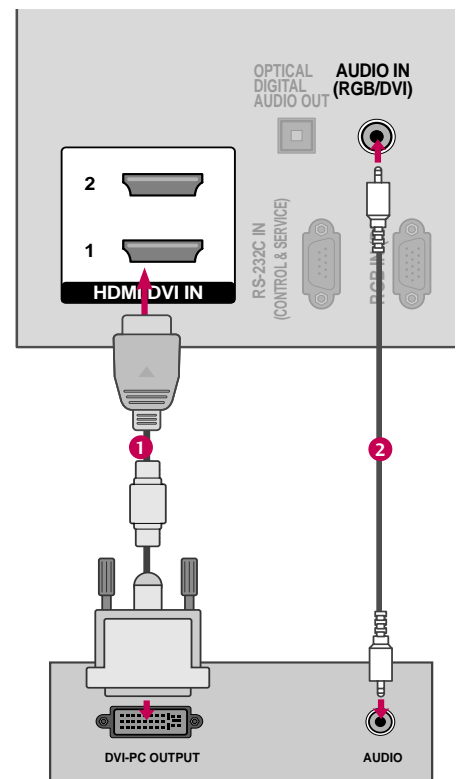

! NOTAS

- ▶ Dependiendo de la tarjeta gráfica, el modo DOS puede no funcionar si utiliza un cable HDMI a DVI.
- ▶ En el modo PC, podría verse ruido asociado con la resolución, un diseño vertical, contraste o brillo. Si observa ruidos, cambie la salida de la PC a otra resolución, cambie la tasa de actualización a otra tasa o ajuste el brillo y el contraste en el menú de IMAGEN hasta que la imagen se vea clara.
- ▶ Evite mantener una imagen fija en pantalla durante largos periodos de tiempo. La imagen fija podría grabarse permanentemente en pantalla.
- ▶ Las formas de la entrada de sincronización para la frecuencia horizontal y vertical están separadas.
- ▶ Según la tarjeta de gráficos que posea, algunas resoluciones podrían no posicionarse adecuadamente en la pantalla.

**Resolución de Despliegue
(RGB-PC, HDMI-PC)**

Resolución	Frecuencia Horizontal(kHz)	Frecuencia Vertical(Hz)
640x350	31.468	70.09
720x400	31.469	70.08
640x480	31.469	59.94
800x600	35.156	56.25
	37.879	60.31
1024x768	48.363	60.00
1280x768	47.776	59.87
1360x768	47.712	60.015
1280x1024	63.981	60.020
1600x1200	74.537	59.869
1920x1080	66.587	59.934

Excepto 42/50PJ250, 42/50PJ340, 42/50PJ350, 42/50PJ550, 42/50PJ350C

CONEXIONES DE EQUIPO EXTERNO

Configuración de pantalla para el modo PC

Seleccionar la resolución

Puede seleccionar la resolución en el modo RGB-PC.

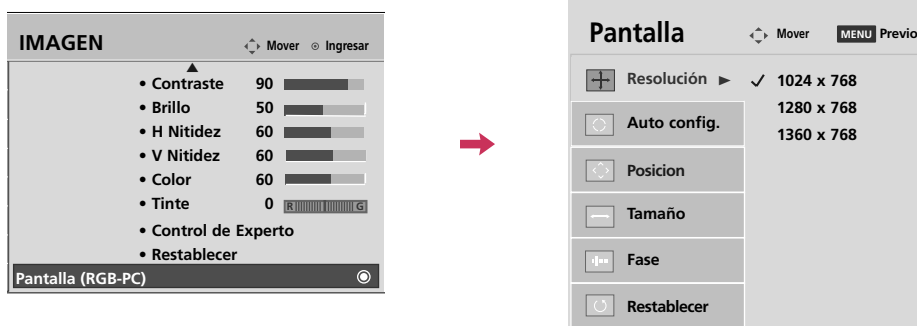

También pueden ajustarse la **Posición**, la **Fase** y el **Tamaño**.



1   Seleccione **IMAGEN**.

2   Seleccione **Pantalla (RGB-PC)**.

3   Seleccione **Resolución**.









4   Seleccione la resolución deseada.

5 

Auto configuración

Ajusta automáticamente la posición de la imagen y minimiza la inestabilidad de la imagen. Luego del ajuste, si la imagen aún no es adecuada, intente usar los ajustes manuales o una resolución diferente o actualice la tasa de la PC.



- 1   Seleccione **IMAGEN**.
- 2   Seleccione **Pantalla (RGB-PC)**.
- 3   Seleccione **Auto config.**
- 4   Seleccione **Sí**.
- 5  Iniciar la auto configuración.

- Si la posición de la imagen aún no es la adecuada, intente auto ajustar nuevamente.
- Si la imagen debe ajustarse nuevamente luego del auto ajuste en RGB-PC, puede ajustar la **Posicion**, el **Tamaño**, o la **Fase**.







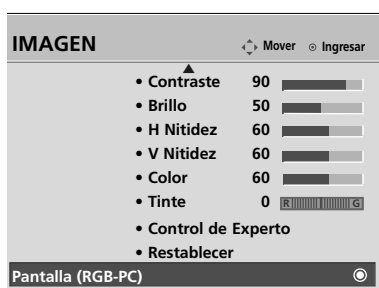

CONEXIONES DE EQUIPO EXTERNO

Ajuste para la Posición, Tamaño y Fase de la pantalla

Si la imagen no se ve clara luego del auto ajuste y, especialmente, si los caracteres aún tiemblan, ajuste la fase de la imagen manualmente.

Esta característica solo opera en modo RGB-PC.











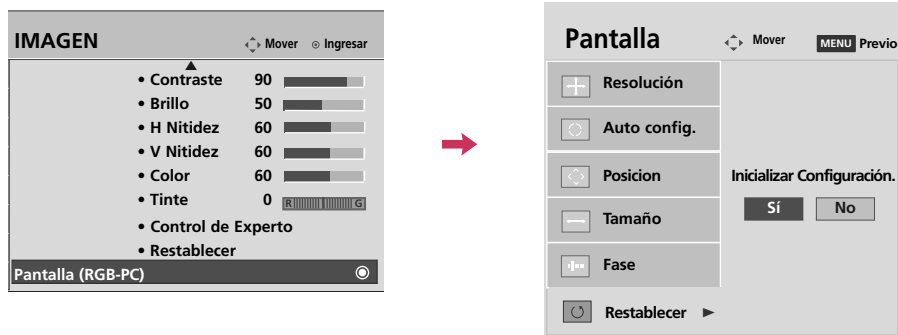

- 1   Seleccione **IMAGEN**.
- 2   Seleccione **Pantalla (RGB-PC)**.
- 3   Seleccione **Posicion, Tamaño o Fase**.
- 4   Realice los ajustes adecuados.
- 5 

- **Posicion:** Esta función es para ajustar la imagen a la izquierda/derecha y arriba/abajo a su preferencia.
- **Tamaño:** Esta función es para minimizar cualquier barra vertical o rayas visibles en el fondo de pantalla. Y también cambiará el tamaño de pantalla.
- **Fase:** Esta función le deja remover cualquier ruido horizontal y hace clara o nitida la imagen de caracteres.

Reajustar la pantalla (Regreso a los valores originales de la fábrica)

Restaura los ajustes de **Posicion**, **Tamaño** y **Fase** a los predeterminados de fábrica.
Esta característica solo opera en modo RGB-PC.



- 1   Seleccione **IMAGEN**.
- 2   Seleccione **Pantalla (RGB-PC)**.
- 3   Seleccione **Restablecer**.
- 4   Seleccione **Sí**.
- 5 

VER LA TV / CONTROL DE CANAL

FUNCIONES DE LOS BOTONES DEL CONTROL REMOTO

Cuando use el control remoto dirija el sensor del control remoto hacia panel frontal de la TV.

50/60PK250, 50/60PJ250,
42/50PJ350, 42/50PJ340,
42/50PJ550, 50PK340,
50PK350, 60PK280, 60PK290,
42/50PJ350C

POWER Prende el televisor desde el modo de espera o lo apaga poniéndolo en dicho modo.

ON/OFF Ilumina los botones del mando a distancia.

ENERGY SAVING Ajusta la función Ahorro de energía.

AV MODE Conmuta entre modos preestablecidos de video y audio. ► p.51

INPUT Alterna entre las entradas.
También prende el televisor desde el modo de espera. ► p.49

TV Selecciona los modos de operación remoto: TV

Botones NUMÉRICOS 0-9

— (GUIÓN) Entra al número de canales multiples de programa como 2 - 1, 2 - 2, etc.

LIST Muestra la lista de canales.

FLASHBK Regresa al último canal visto.

Colored buttons Edición de programa.

SIMPLINK Control buttons

- ◀◀ (Retroceso), ▶▶ (Avance rápido), ▶ (Reproducción), || (Pausa)
- Controla los dispositivos compatibles con SIMPLINK.

FREEZE Congela el fotograma actualmente en pantalla.

■ (Stop) Detiene el procesamiento de la función de tiempo de la unidad. (Reproducir, Retroceder, etc.)

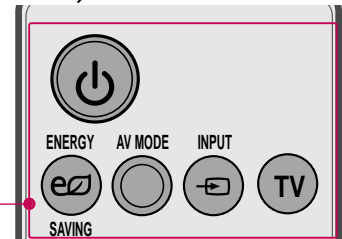

50/60PK550, 50/60PK540,
50/60PK550C

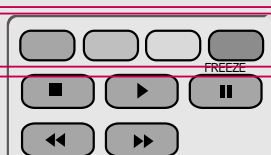
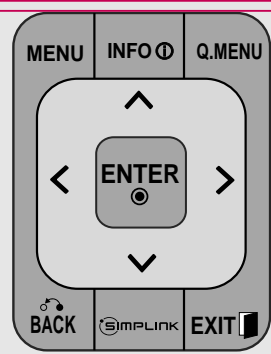
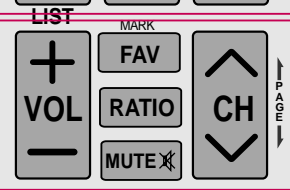
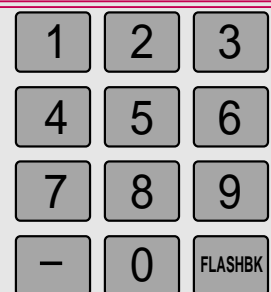
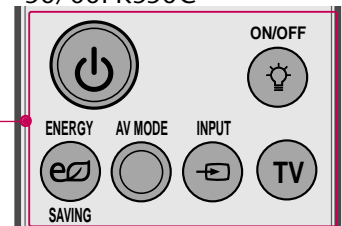

THUMBSTICK
(Arriba/Abajo/Izquierda/Derecha/ENTER)

Le permite navegar a través de los menús en la pantalla y ajustar el sistema de acuerdo a sus preferencias.

MENU

Muestra el menú principal o cierra todas las visualizaciones en pantalla y regresa al visionado del televisor.

INFO

Muestra información sobre el canal en la parte superior de la pantalla.

Q.MENU

Abre la lista de opciones del menú rápido.

BACK

Permite al usuario desplazarse un paso hacia atrás en una aplicación interactiva o en otras funciones interactivas.

SIMPLINK

Muestra información del canal en la parte superior de la pantalla.

EXIT

Borra todas las pantallas mostradas y vuelve a la visualización de TV desde cualquier menú.

**VOLUMEN
SUBIR/BAJAR**

Ajusta el volumen.

FAV

Se desplaza a través de los canales programados favoritos. ► **p.47**

RATIO

Cambia la relación de aspecto del video.

MUTE

Enciende y apaga el sonido. ► **p.38**

**CANAL
ARRIBA/ABAJO**

Cambia el canal.

**PAGINA
ARRIBA/ABAJO**

Se mueve de un conjunto de información en pantalla al siguiente.

Colocando las Baterías

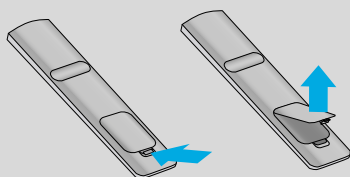

- Abra la tapa del compartimento de las baterías en la parte posterior e instale las baterías con la polaridad correcta.
- Instale dos baterías de 1,5 Vcc tipo AAA. No mezcle las baterías nuevas con las usadas.
- Cierre la tapa.

VER LA TV / CONTROL DE CANAL

ENCENDIDO DEL TV

- 1 En primer lugar, conecte correctamente el cable de alimentación.
En este momento, el TV cambia al modo en espera.
 - En el modo de espera para encender el TV, presione los botones $\phi/|$, **INPUT**, **CH** (\blacktriangle o \blacktriangledown) en el TV o presione **POWER**, **INPUT**, **CH** (\wedge o \vee), **números (0 - 9)** del control remoto.
- 2 Seleccione la fuente de visualización utilizando el botón **INPUT** en el control remoto.
- 3 Cuando deje de usar la TV, presione el botón **POWER** en el control remoto. El televisor vuelve al modo apagado.

! NOTA

- Si usted va a estar ausente en vacaciones, desconecte el TV del tomacorriente.

AJUSTE DEL CANAL

- 1 Presione el botón **CH** (\wedge o \vee) o de **NÚMERO** para seleccionar un número del canal.

AJUSTE DEL VOLUMEN

Ajuste el volumen según su preferencia personal.

- 1 Presione el botón **VOL** ($+$ o $-$) para ajustar el volumen.
- 2 Si ud. quiere apagar el sonido, presione el botón **MUTE**.
- 3 Ud. puede cancelar esta función presionando el botón **MUTE** o **VOL** ($+$ o $-$).

CONFIGURACIÓN INICIAL

Esta función guía al usuario para que pueda configurar fácilmente los elementos esenciales para ver el televisor por primera vez cuando lo adquiere. Se visualizará en la pantalla cuando encienda el televisor por primera vez. También puede activarse desde los menús del usuario.

La selección preestablecida es “Usar en Casa”. Recomendamos el establecimiento de la televisión a modo “Usar en Casa” para la mejor imagen en su entorno familiar.

- “**Demo de Tienda**” Modo sólo destinado para su utilización en entornos de venta al por menor. Los clientes pueden ajustar el “menú **IMAGEN - Modo imagen**” manualmente mientras que la inspección de la televisión, pero la televisión regresará automáticamente a la preestablecida en almacén después de 5 minutos.
- También ud. puede hacer la **Configuración Inicial** con el menú **OPCIÓN**.
Se ajustarán los valores predeterminados de fábrica al escoger “Usar en Casa”.
- Si no completa los ajustes iniciales, estos aparecerán cada vez que prenda el televisor hasta que complete dicho proceso.

Paso1. BIENVENIDO

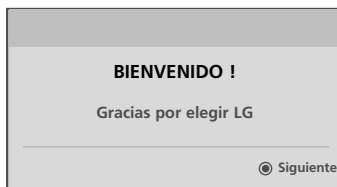

Paso2. Selección de idioma

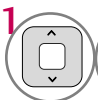
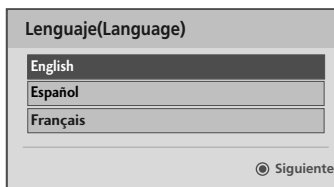

Seleccione Idioma del menú.

Paso3. Configuración de Modo

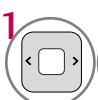
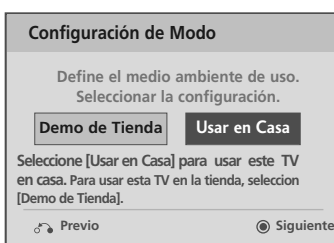

Seleccione Modo **Usar en Casa**.

Paso4. Configuración de Hora

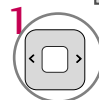
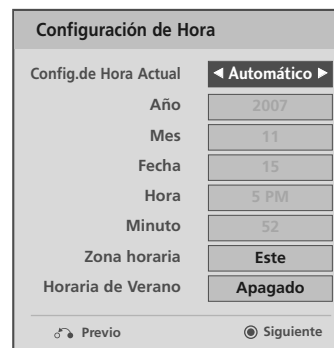

Seleccione **Automático** o **Manual**.



Seleccione la opción de tiempo deseada.

Paso5. Sintonía Automática

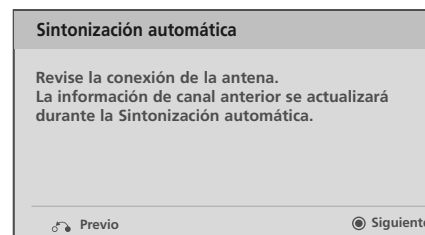

Iniciar la **Sintonización automática**.





VER LA TV / CONTROL DE CANAL

SELECCIÓN Y AJUSTE DEL MENÚ PANTALLA

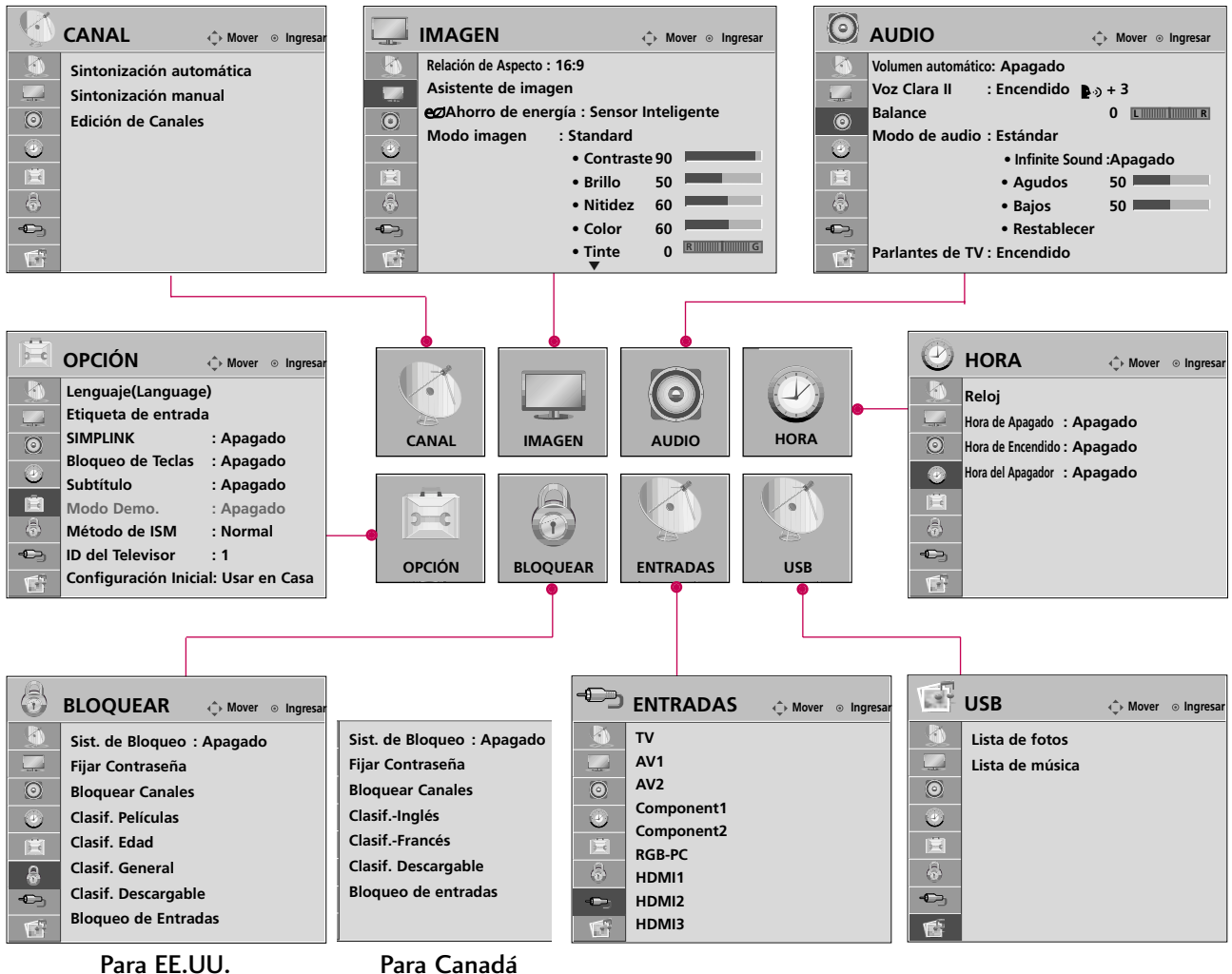
El OSD (On Screen Display, Despliegue En la Pantalla) de su TV puede ser un poco diferente que este manual.

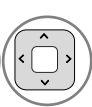
VER LA TV / CONTROL DE CANAL

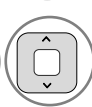





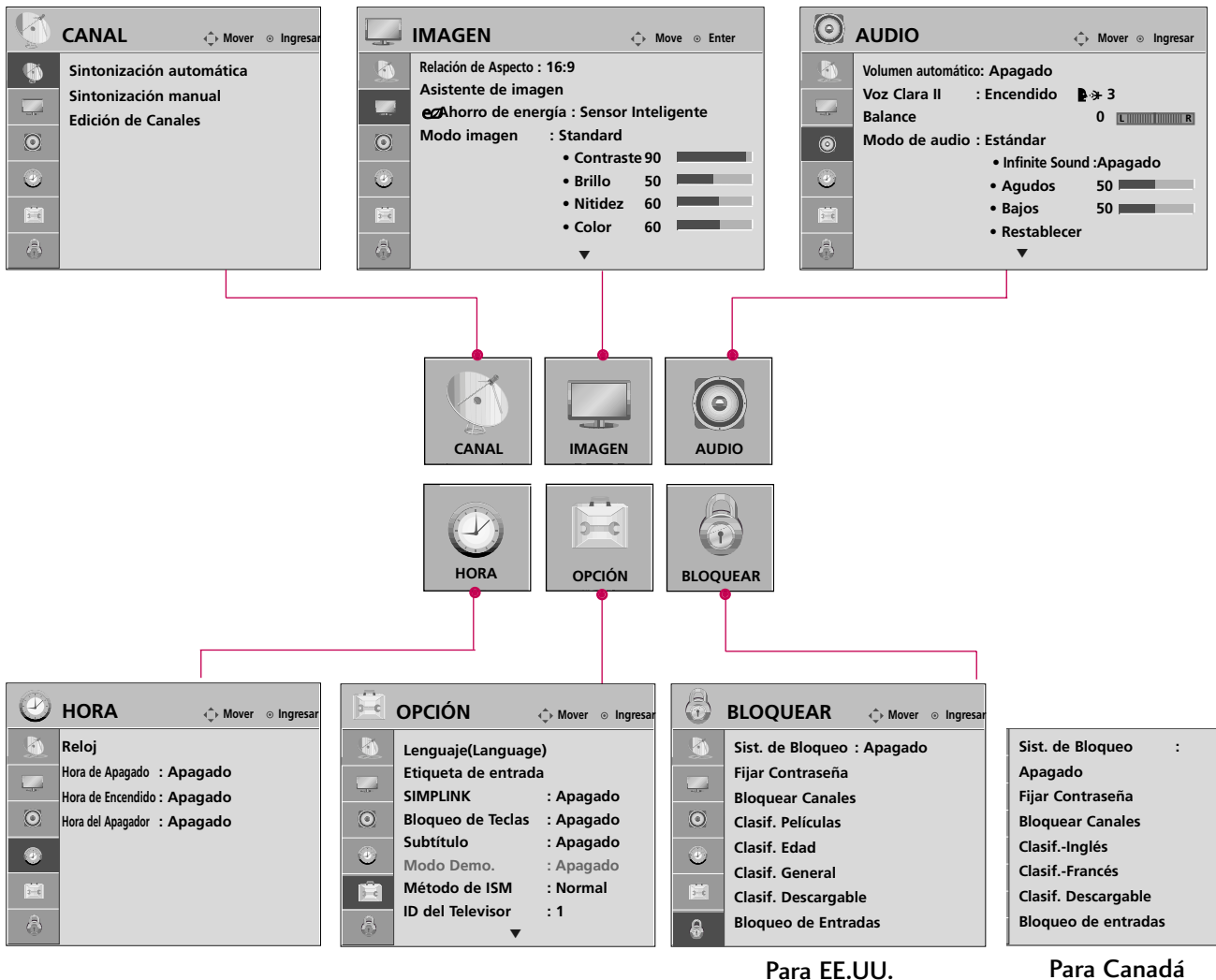

-   Visualizar todos los menús.
-   Seleccione un elemento del menú.
-  Acepte la selección actual.
-  Regresar a la pantalla del televisor.

42/50PJ250, 50/60PK250, 60PK280, 42/50PJ340, 50PK340, 50/60PK540



VER LA TV / CONTROL DE CANAL

- 1   Visualizar todos los menús.
- 2   Seleccione un elemento del menú.
- 3  Acepte la selección actual.
- 4  Regresar a la pantalla del televisor.

VER LA TV / CONTROL DE CANAL

QUICK MENU (MENÚ RÁPIDO)





Los menús de visualización en pantalla de su TV pueden diferir ligeramente de las ilustraciones mostradas en este manual.

El menú rápido (Q.Menu) es un menú destinado a las funciones que el usuario utiliza con más frecuencia.



Sólo 42/50PJ350, 50PK350,
50/60PK550, 42/50PJ550,
60PK290, 42/50PJ350C,
50/60PK550C

- ☰ **Relación de Aspecto:** Selecciona el formato de imagen que desee.
- 👁️ **Modo de Imagen:** Selects the factory preset picture depend on the viewing environment.
- 🎵 **Modo de audio:** Selecciona modos de sonido predefinidos de fábrica para los diferentes tipos de programa.
- 🗣️ **Multi Audio:** Changes the audio language (Digital signal).
- 🔊 **SAP:** Selects MTS sound (Analog signal).
- 🕒 **Hora del Apagador:** Seleccione el plazo de tiempo antes de que su TV se apague automáticamente.
- 📺 **Bor/Agr/Fav:** Seleccione el canal que desee agregar o eliminar, o agregue el canal a la lista de favoritos.
- 📺 **Subtítulo:** Seleccione encendido o apagado
- 🗑️ **Expulsar USB:** Seleccione "Expulsar" para expulsar el dispositivo USB.

- 1   Visualizar todos los menús.
- 2  Realice los ajustes adecuados.
- 3  Regresar a la pantalla del televisor.

BÚSQUEDA DE CANALES



Escaneo automático (Sintonización automática)

Busca automáticamente todos los canales disponibles por las entradas de antena o cable y los guarda en la memoria de la lista de canales.

Ejecuta esta función si cambia su residencia o mueve el televisor. Además, asegúrese de ejecutar esta función con la antena conectada durante las horas de transmisión de la TV.

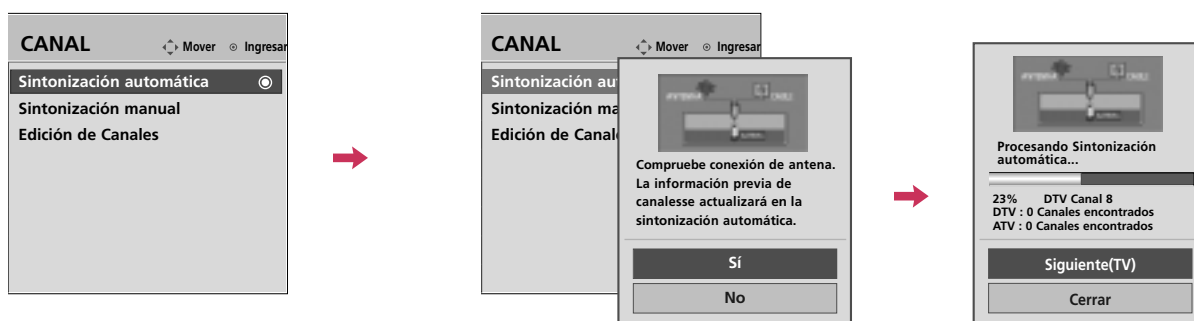
La sintonización automática memoriza sólo los canales disponibles en ese momento.





-  Seleccione **CANAL**.
-  Seleccione **Sintonización automática**.
-  Seleccione **Sí**.
-  Ejecutar la **Sintonización automática**.
-  Regresar al menú anterior.
-  Regresar a la pantalla del televisor.

- El televisor solicitará una contraseña si el control parental ha sido activado (menú de **BLOQUEAR**). Use la contraseña establecida en el menú de **BLOQUEAR** para permitir una búsqueda de canal.
- Al ajustar la **Sintonización automática** o **manual**, el número máximo de canales que podrá guardar es de 900. Este está sujeto a cambios dependiendo de las condiciones de la señal de emisión.
- Memoriza todos los canales disponibles en el orden siguiente: DTV, TV, CADTV y CATV.

Agregar/Eliminar los Canales (Sintonización manual)

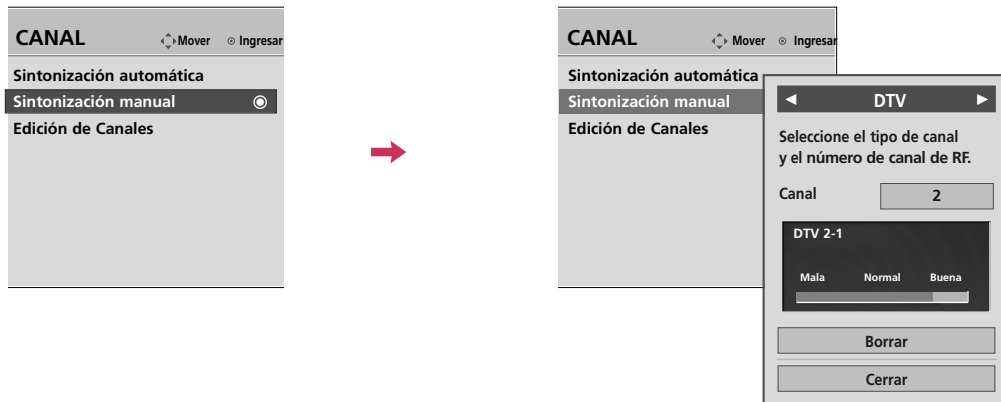
Si selecciona señal de entrada DTV o CADTV, puede visualizar el monitor de intensidad de la señal en la pantalla para ver la calidad de la señal que se recibe.



-   Seleccione **CANAL**.
-   Seleccione **Sintonización manual**.
-   Seleccione **DTV, TV, CADTV o CATV**.
-   Seleccione el canal que desee agregar o borrar.
-   Seleccione **Agregar o Borrar**.
-  Regresar al menú anterior.
-  Regresar a la pantalla del televisor.

- El televisor solicitará una contraseña si el control parental ha sido activado (menú de **BLOQUEAR**). Use la contraseña establecida en el menú de **BLOQUEAR** para permitir una búsqueda de canal.
- Al ajustar la **Sintonización automática o manual**, el número máximo de canales que podrá guardar es de 900. Este está sujeto a cambios dependiendo de las condiciones de la señal de emisión.

Edición de canal

Al omitir un número de canal, no podrá escogerlo mediante el botón CH ^, v durante la visualización del televisor. Si desea escoger el programa omitido, introduzca directamente su número mediante los botones NUMÉRICOS o escóalo en el menú Edición de canales.

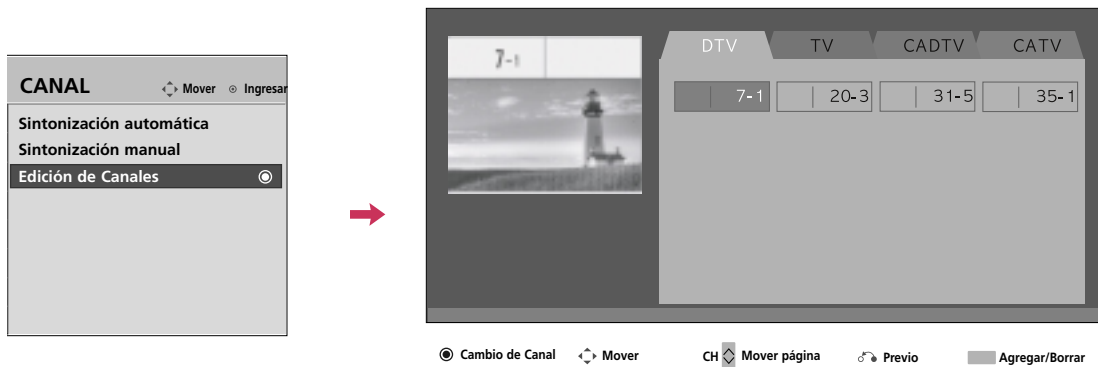

- 1   Seleccione **CANAL**.
- 2   Seleccione **Edición de Canales**.
- 3   Seleccione un canal.
- 4  Añadir o eliminar el canal.
- 5  Regresar al menú anterior.
-  Regresar a la pantalla del televisor.

VER LA TV / CONTROL DE CANAL

LISTA DE CANALES

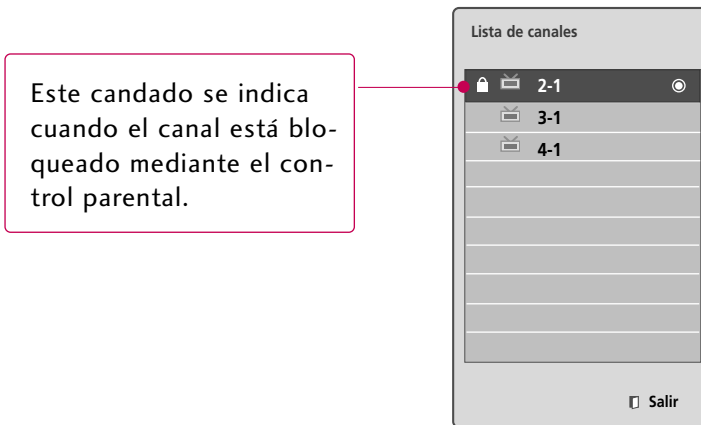

Podrá examinar los programas almacenados en la memoria visualizando la lista de canales.



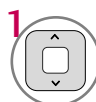

Muestra la Lista de canales

- 1  Visualización de la lista de canales.

Selección de un canal de la lista de canales

- 1  Escoja un canal.
- 2  Cambie al número de canal escogido.

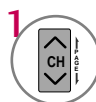
Paso de páginas de una lista de canales

- 1  Pase las páginas.
- 2  Regresar a la pantalla del televisor.

CONFIGURACIÓN DE LOS CANALES FAVORITOS

La lista de Canales favoritos es una función muy cómoda que le permitirá cambiar rápidamente entre sus canales preferidos sin tener que esperar a que el televisor sintonice todos los canales intermedios.

Presione repetidamente el botón **FAV** (Favorite) para seleccionar canales favoritos almacenados.



- 1  o  Escoja el canal que prefiera.
- 2   Seleccione **Bor/Agr/Fav**.
- 3  Seleccione **Favorito**.
- 4  Regresar a la pantalla del televisor.

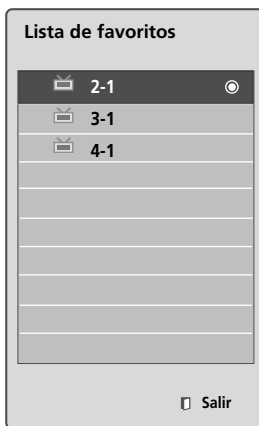

LISTA DE FAVORITOS





Visualización de la lista de canales favoritos

- 1  Muestre la lista de canales favoritos.

Selección de un canal de la lista de canales favoritos

- 1  Escoja un canal.
- 2  Cambie al número de canal escogido.



Paso de páginas de la lista de canales favoritos

- 1  Pase las páginas.
- 2  Regresar a la pantalla del televisor.

VER LA TV / CONTROL DE CANAL

INFO. BREVE

La información breve muestra la información de la pantalla actual.

1  o  Mostrar la Información breve en pantalla.

2  Regresar a la pantalla del televisor.

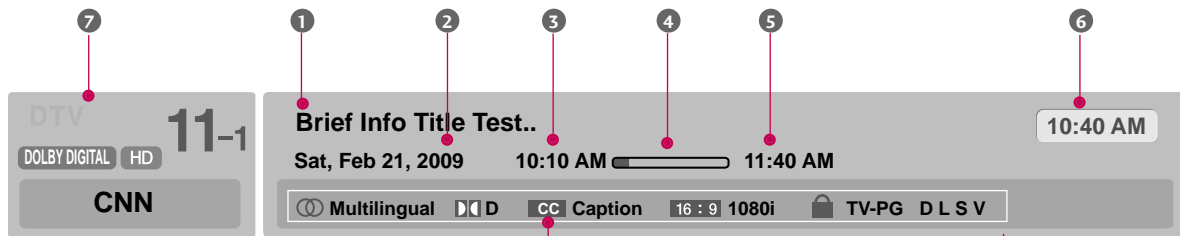

Multilingüe: El programa contiene dos o más canales de audio disponibles. Use el menú Q.MENÚ para escoger la pista de audio que desee.



Subtítulo: El programa contiene subtítulos disponibles en uno o más idiomas. Use el menú Q.MENÚ para escoger los subtítulos que desee.



Dolby Digital: El programa contiene una señal de audio Dolby Digital en la TV y en la fuente de entrada HDMI.



El formato de imagen original del video es 4:3.



El formato de imagen original del video es 16:9 (wide)

480i

La resolución de video es de 720 x 480 entrelazado.

480p

La resolución de video es de 720 x 480 progresivo.

720p

La resolución de video es de 1 280 x 720 progresivo.

1080i

La resolución de video es de 1 920 x 1 080 entrelazado.

1080p

La resolución de video es de 1 920 x 1 080 progresivo.



V-Chip: El programa contiene información V-Chip. Referente al menú de BLOQUEAR: A (Clasificación por edad), D (Diálogos provocadores), L (Lenguaje para adultos), S (Contenido sexual), V (Violencia), FV (Fantasía violenta)

- 1 Título de programa
- 2 Día de semana, Mes, Año
- 3 Hora de inicio de programa
- 4 Barra de progreso de programa
- 5 Hora de termino de Programa
- 6 Hora actual
- 7 Información de estandarte

LISTA DE ENTRADAS

Solo estas señales de entrada que están conectadas a un televisor pueden activarse y seleccionarse.



1

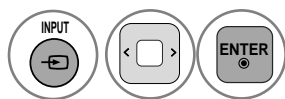

Seleccione la fuente de entrada deseada.

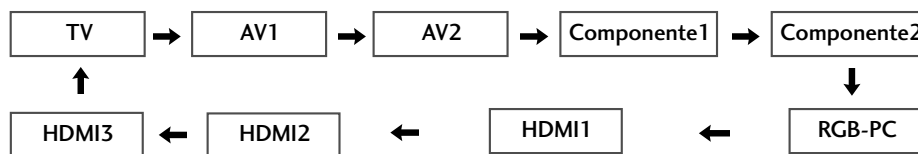

Ej.)

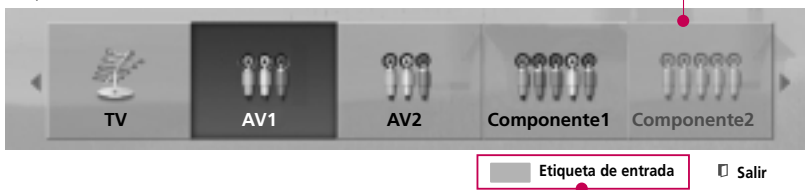

Las entradas desconectadas están inactivas (se indican en gris)

Seleccione una fuente de entrada deseada (excepto TV). puede escoger la Etiqueta de entrada que prefiera usando el botón Azul. ► p.50

Ej.) En caso de cambiar la etiqueta de entrada mediante el botón Azul.

- Cuando se encuentra conectado un dispositivo externo, este menú emergente se visualiza automáticamente. Si selecciona **Sí**, puede seleccionar la fuente de entrada que desee percibir.
- Pero, si selecciona **"SIMPLINK - Encendido"** en modo HDMI, este menú emergente podría no visualizarse.

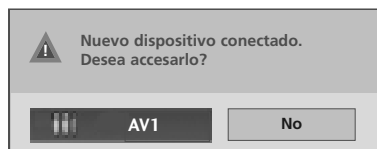

- **TV**: Selecciónela para mirar estaciones de aire, cable y digitales.
- **AV** : Selecciónelo para mirar una video casetera u otro equipo externo.
- **Componente** : Selecciónelos para mirar un DVD o un decodificador digital.
- **RGB-PC**: Selecciónelo para ver la PC.
- **HDMI1**: Selecciónelo para ver en dispositivos de alta definición.





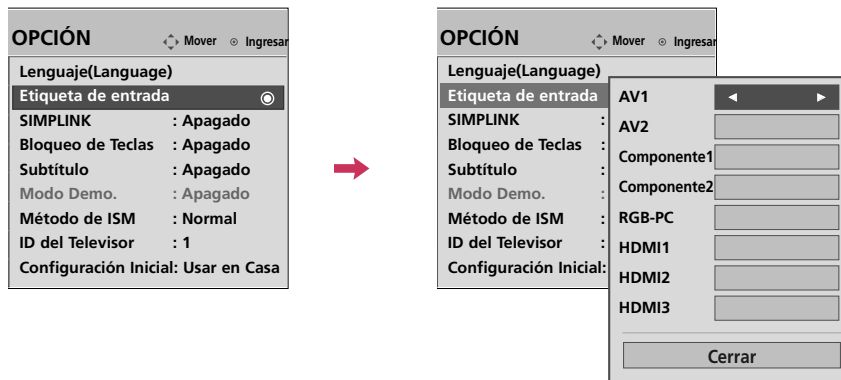

VER LA TV / CONTROL DE CANAL

ETIQUETA DE ENTRADA



Puede establecer una etiqueta para cada fuente cuando no esta en uso.



Usando el menú OPCIÓN

- 1   Seleccione **OPCIÓN**.
- 2   Seleccione **Etiqueta de entrada**.
- 3   Seleccione la fuente.
- 4  Seleccione la etiqueta.
- 5  Regresar al menú anterior.
-  Regresar a la pantalla del televisor.

Usando el botón de INPUT

- 1   Seleccione la fuente (excepto **TV**).
- 2   Seleccione la etiqueta.
- 3  Regresar al menú anterior.
-  Regresar a la pantalla del televisor.

MODO AV

El Modo AV cambia entre los ajustes de video y audio.

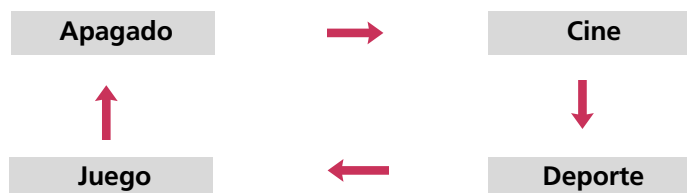

Presione repetidamente el botón **AV MODE** para seleccionar el modo que desee.



- Si selecciona "**Cine**" en modo AV, el **Cine** se seleccionará para el "menú IMAGEN - Modo imagen" y para el "menú AUDIO - Modo de audio" respectivamente.
- Si selecciona "**Apagado**" en modo AV, el "**Modo imagen**" y el "**Modo de audio**" volverán a tener el valor seleccionado anteriormente.
- **Apagado**: Desactiva el MODO AV.
- **Cine**: Optimiza video y audio para disfrutar películas.
- **Deporte**: Optimiza video y audio para disfrutar de eventos deportivos.
- **Juego**: Optimiza video y audio para jugar a videojuegos.





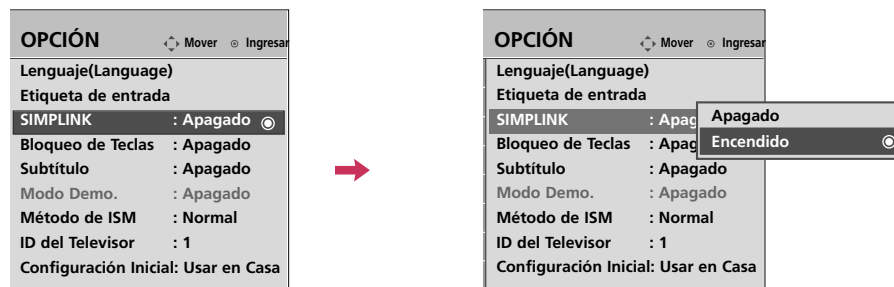

VER LA TV / CONTROL DE CANAL



La función SIMPLINK le permite controlar y leer dispositivos AV conectados mediante cable HDMI sin ningún otro cable ni ajuste adicional. Este televisor podría funcionar con dispositivos compatibles con HDMI-CEC, pero sólo serán completamente compatibles con dispositivos distinguidos con el logotipo SIMPLINK . SIMPLINK puede activarse y desactivarse desde los menús de usuario.



VER LA TV / CONTROL DE CANAL

-   Seleccione **OPCIÓN**.
-   Seleccione **SIMPLINK**.
-   Seleccione **Encendido** o **Apagado**.
-  Regresar al menú anterior.
-  Regresar a la pantalla del televisor.

! NOTA

- ▶ Conecte la terminal HDMI/DVI IN o HDMI IN del televisor a la terminal posterior (salida HDMI) del dispositivo SIMPLINK con el cable HDMI.
- ▶ Al encender la fuente de Entrada con el botón **INPUT** en el control remoto, se desactivará el dispositivo SIMPLINK.
- ▶ Al escoger un dispositivo que disponga de la función de cine en casa, la salida de sonido cambiará automáticamente a los altoparlantes del sistema de cine en casa, desactivándose los del televisor.
- ▶ Si un sistema de home theater SIMPLINK no se reproduce en el audio del televisor, conecte la terminal de SALIDA DE AUDIO DIGITAL a la parte posterior del televisor a la terminal de ENTRADA DE AUDIO DIGITAL en la parte posterior del dispositivo SIMPLINK con un cable ÓPTICO.

Funciones de SIMPLINK

- **Reproducción directa:** Luego de conectar los dispositivos AV al televisor, puede controlar directamente los dispositivos y medios de reproducción sin ninguna configuración adicional.
- **Seleccione dispositivo AV:** Le permite seleccionar uno de los dispositivos conectados al televisor y reproducirlo.
- **Reproducción del disco:** Controle los dispositivos AV conectados presionando los botones \wedge \vee \leftarrow \rightarrow , ENTER, \blacktriangleright , \blacksquare , I I , \llcorner y \blacktriangleright .
- **Apague todos los dispositivos:** Para que esta función aplique, todos los dispositivos conectados al televisor deben de estar detenidos.
- **Desconecte el audio :** Ofrece una forma fácil de desactivar el audio.
- **Sync Power on:** Al iniciar la lectura en un equipo conectado a la toma HDMI que disponga de función Simplink, el televisor se prenderá automáticamente.

(Un dispositivo, el cual se conecta al televisor a través del cable HDMI pero no es compatible con Simplink, no proporciona esta función)

Nota:Para activar el enlace simple, debe emplear el cable HDMI con el dispositivo *CEC. (*CEC: Consumer Electronics Control).

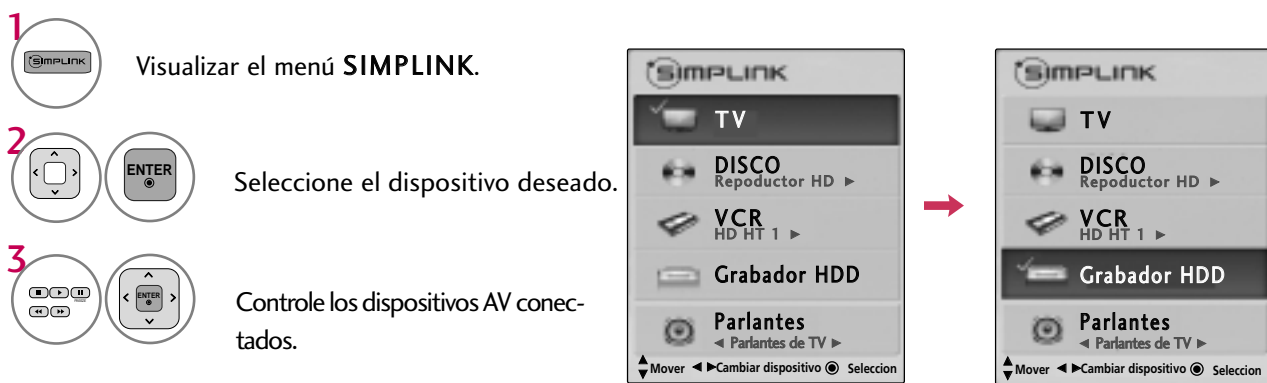

Menú SIMPLINK

- 1 **Visualización del televisor:** Cambie al canal del televisor anterior, sin importar el modo actual.

Reproducción de DISC (Disco):

Seleccione y reproduzca los discos. Cuando existan varios discos disponibles, los títulos de los discos aparecerán en la parte inferior de la pantalla.

- 3 **Reproducción de VCR:** Reproduzca y controle el VCR conectado.

- 5 **Reproducción de grabaciones HDD:** Reproduzca y controle las grabaciones almacenadas en HDD.

Salida de audio a bocina HT/ Salida de audio a televisor: Seleccione parlante HT o parlante TV para salida de audio.



- ▶ Cuando no hay dispositivos conectados (Aparece en gris)
- ▶ Dispositivo Seleccionado
- ▶ Cuando un dispositivo esta conectado (Muestra un color brillante)

USB - Sólo 42/50PJ350, 50PK350, 50/60PK550, 42/50PJ550, 60PK290, 42/50PJ350C, 50/60PK550, 50/60PK550C models

MODOS DE ENTRADA

Esta pantalla aparecerá automáticamente cuando conecte un dispositivo USB.

En el dispositivo USB, no puede agregar una nueva carpeta ni borrar la carpeta existente.

1 Conecte el dispositivo USB a las tomas **USB IN** en el lateral de la TV.

- No es compatible con USB HDD.
- Este televisor es compatible con los formatos JPG y MP3.

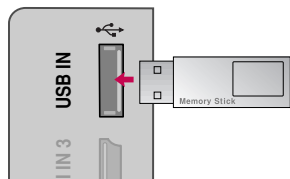

2 Seleccione **Lista de fotos**, **Lista de música** o **Lista de cine**.

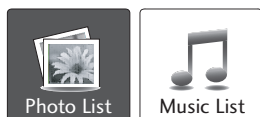

! NOTA

- ▶ Con el fin de evitar la pérdida de la memoria USB, Use el sujetador de USB para fijar la memoria USB al sujetador de la conexión de USB a la TV.

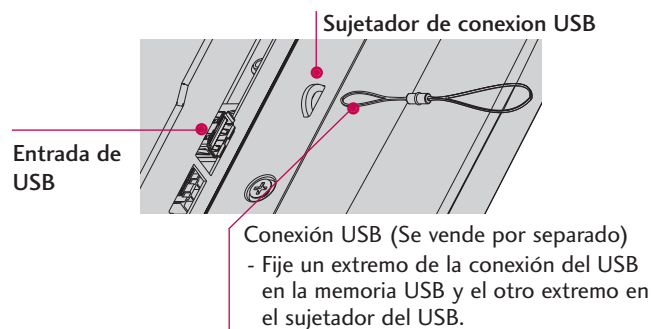

Quando desconecte el dispositivo USB

Seleccione el menú **Expulsar USB** antes de desconectar el dispositivo USB.



Seleccione **Expulsar USB**.



Seleccione **Expulsar**.

Conexión del dispositivo USB

- ▶ Sólo se puede reconocer un dispositivo de almacenamiento USB.
 - ▶ Si el dispositivo de almacenamiento USB se conecta a través del hub USB, el dispositivo no es reconocible.
 - ▶ Es posible que no se reconozca un dispositivo de almacenamiento USB mediante el programa de reconocimiento automático.
 - ▶ Es posible que no se reconozca un dispositivo de almacenamiento USB que utiliza su propio controlador.
 - ▶ En el caso de un lector de tarjetas, reconoce un máximo de cuatro tarjetas de memoria a la vez aunque el dispositivo puede no funcionar con normalidad.
 - ▶ La velocidad de reconocimiento de un dispositivo de almacenamiento USB dependerá de cada dispositivo.
 - ▶ No apague el televisor ni desconecte el dispositivo USB cuando el dispositivo de almacenamiento USB conectado esté funcionando. Al separar o desenchufar repentinamente dicho dispositivo, se pueden dañar los archivos almacenados o el dispositivo de almacenamiento USB.
 - ▶ Use únicamente un dispositivo de almacenamiento USB que contenga archivos estándar de música o imagen.
 - ▶ Use sólo un dispositivo de almacenamiento USB formateado como sistema de archivo FAT16, FAT32 o NTFS, incluido con el sistema operativo Windows. En el caso de un dispositivo de almacenamiento formateado como programa utilitario diferente no compatible con Windows, éste podría no ser reconocido.
 - ▶ Conecte la alimentación a un dispositivo de almacenamiento USB que requiera una fuente de energía externa. De no ser así, el dispositivo podría no ser reconocido.
 - ▶ Conecte un dispositivo de almacenamiento USB con un cable certificado. Si se conecta con un cable no certificado o con un cable excesivamente largo, el dispositivo podría no ser reconocido.
 - ▶ Algunos dispositivos de almacenamiento USB pueden no ser compatibles o no funcionar correctamente.
 - ▶ El televisor mostrará hasta 128 caracteres de los nombres de archivo.
 - ▶ Realice copias de seguridad de sus archivos importantes, ya que los datos almacenados en el dispositivo USB podrían resultar dañados. La gestión de datos es responsabilidad del cliente, y en consecuencia, el fabricante no cubre en garantía los daños en los datos guardados en el producto.
 - ▶ La capacidad recomendada para un disco duro externo USB es de 1TB o menos y para una memoria clave USB es de 32 GB o menos.
- Cualquier dispositivo con la capacidad más alta que la recomendada no operará apropiadamente.

LISTA DE FOTOS

Puede visualizar archivos .JPG de dispositivos de almacenamiento USB.
La visualización en la pantalla de su modelo puede variar levemente.

Archivo de foto compatible: *.JPG

- Solo puede ejecutar archivos JPG.
- Solo el escaneo baseline es compatible con JPG.

USB

Componentes de la pantalla

1 Seleccione **USB**.

2 Seleccione **LISTA DE FOTOS**.

1 Se desplaza al archivo de nivel superior.

2 Previsualizar: visualice las imágenes en miniatura o el nombre de la carpeta de las fotos en la carpeta seleccionada.

3 Página actual/Total de páginas

4 Número total de fotos en miniatura marcadas

5 Memoria USB utilizable

6 Botones correspondientes en el control remoto

LISTA DE FOTOS Página 1/1 No marcado Dispos USB Espacio Libre 150MB

Top Folder
DriveA
0 Carpeta, 4 archs.
Carpeta arriba

Mover Menú emergente CH Mover página MARK Marcar Salir

Selección de fotos y menú emergente





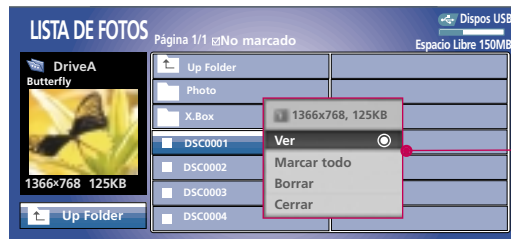



◀ Mover ● Menú emergente CH Mover página MARK Marcar Salir



◀ Mover ● Menú emergente CH Mover página MARK Marcar Salir

Quando selecciona un archivo (no una carpeta), se visualiza el menú emergente.

- ▶ **Ver:** Muestra el elemento seleccionado.
- ▶ **Marcar todo:** Marca todas las fotos de la pantalla.
- ▶ **Desmarcar todo:** Cancele la selección de las fotos marcadas.
- ▶ **Borrar:** Borra la foto seleccionada.
- ▶ **Cerrar:** Cierra el menú emergente.

- 1  Seleccione la carpeta o el disco de destino.
- 2   Seleccione las fotos deseadas.
- 3  Visualice el menú emergente.
- 4   Seleccione el menú emergente deseado.







- Utilice el botón **CH** ^ v para navegar en la página de fotos.
- Use el botón **MARK** para marcar o desmarcar una foto. Cuando se marca una o más fotos, se pueden ver las fotos en forma individual o una presentación de las fotos marcadas. Si no se marca ninguna foto, se pueden ver todas las fotos en forma individual o todas las fotos en la carpeta, como presentación.

Menú de pantalla completa

Puede cambiar la vista de la lista de fotos para que ocupe toda la pantalla. Se encuentran disponibles más funciones en el modo de pantalla completa.



La relación de aspecto de una foto puede cambiar el tamaño de la foto exhibida en pantalla completa.

- 1  Seleccione la carpeta o el disco de destino.
- 2   Seleccione las fotos deseadas.
- 3  Visualice el menú emergente.
- 4  Seleccione **Ver**.
- 5  La foto seleccionada se visualiza en el modo de pantalla completa.

- Use el botón **CH**   para navegar en la página de fotos en miniatura.

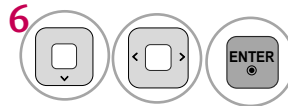
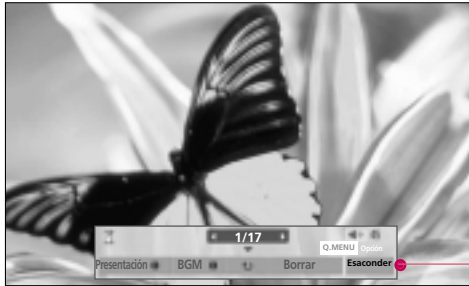

6 Seleccione **Presentación**, **BGM**, **(Girar)**, **Borrar**, **Opción** o **Esconder**.

- Use el botón < > para seleccionar la foto anterior o siguiente.
- Use el botón ^ v < > para seleccionar y controlar el menú en la pantalla completa.

- ▶ **Presentación:** Las fotos seleccionadas se visualizan durante la presentación de diapositivas. Si no se selecciona ninguna foto, todas las fotos en la carpeta actual se visualizan durante la presentación de diapositivas.
 - Defina el intervalo de tiempo de la presentación en **Opción**.
- ▶ **BGM:** Escuche música mientras ve las fotos en tamaño completo.
 - Defina el dispositivo BGM y álbum en **Opción**.
- ▶ **(Girar):** Girar fotos.
 - Gira la foto 90°, 180°, 270°, 360° en el sentido de las agujas del reloj.
- ▶ **Borrar:** Borre las fotos.
- ▶ **Esconder:** Oculte el menú en la pantalla de tamaño completo.
 - Para ver nuevamente el menú en pantalla completa, presione el botón **ENTER**.



! NOTA

- ▶ Este televisor no podrá decodificar las imágenes JPG que se guardaron utilizando la opción progresiva.

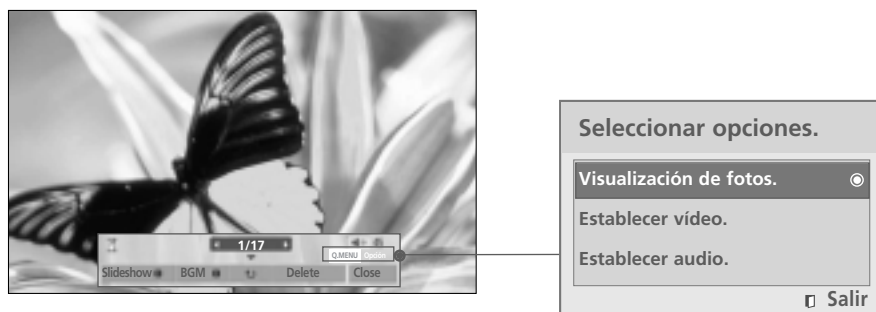
Uso de la opción Lista de fotos





1  Muestra el menú emergente.

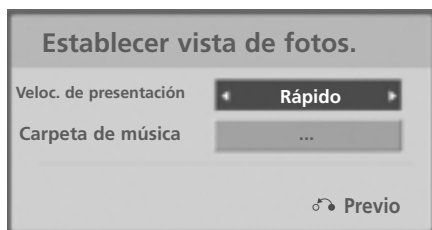

2   Seleccione Visualización de fotos, Establecer vídeo o Establecer audio.

► Al seleccionar Visualización de fotos,

- No puede cambiar a la carpeta de música durante la reproducción de BGM.





1   Mostrar Veloc. de presentación o Carpeta de música.

2   Realice los ajustes apropiados.

► Al seleccionar Establecer vídeo,





1   Mostrar el Modo imagen.

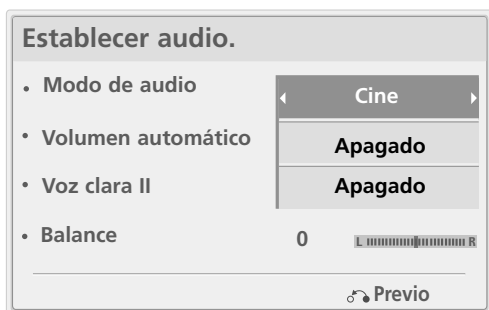

2   Realice los ajustes apropiados.

■ El modo APS no es compatible con la función Establecer vídeo.

► Al seleccionar Establecer audio,



1   Mostrar Modo de audio, Volumen automático, Voz clara II y Balance.

2   Realizar los ajustes apropiados.

LISTA DE MÚSICA

Puede utilizar el menú de listado de música para reproducir archivos MP3 de un dispositivo USB de almacenaje. Este televisor no puede reproducir archivos protegidos contra copia. La visualización en la pantalla de su modelo puede variar levemente.

Archivos de música compatibles: *.MP3

Frecuencia de tasa binaria 8 kb/s - 320 kb/s

- Frecuencia de muestreo
MPEG1 Layer 3 : 8 kHz - 48 kHz
- Frecuencia de muestreo : 999,59 segundos

USB

Componentes de la pantalla

1   Seleccione **USB**.

2    Seleccione **LISTA DE MÚSICA**.

1 Se desplaza al archivo de nivel superior.

2 Previsualizar: Mostrar el título/nombre de carpeta de la música en la carpeta seleccionada.

3 Página actual/Total de páginas

4 Número total de música en miniatura marcadas

5 Memoria USB utilizable

6 Botones correspondientes en el control remoto



Title	Duration
Carpeta arriba	
Arirang	04:12
Good Bye	05:30

Control remoto:  Mover  Menú emergente  CH  Mover página  Q.MENU  Opción  MARK  Marcar  Salir

Selección de música y menú emergente

Aparecen hasta 6 títulos de música por página.









Mover ● Menú emergente CH ◊ Mover página Q.MENU Opción MARK Marcar Salir



Mover ● Menú emergente CH ◊ Mover página Q.MENU Opción MARK Marcar Salir

- ▶ **Reproducir** (Druante la parada): Reproduzca la música seleccionada. Durante la reproducción, puede seleccionar un archivo diferente para reproducir y el archivo comenzará en forma automática. Una vez que finalice la reproducción de una música, comenzará a reproducirse la siguiente seleccionada. Cuando ya no haya música seleccionada para reproducción, se reproducirá la siguiente en la carpeta actual. Si va a una carpeta diferente y presiona el botón **ENTER**, la música actualmente en reproducción se detendrá.
- ▶ **Repr.marcados**: Reproduzca la música seleccionada. Cuando una canción termina de reproducirse, la siguiente canción seleccionada se reproducirá automáticamente.
- ▶ **Detener reprod**: Comience a reproducir la música seleccionada y luego muévase a la lista de fotos.
- ▶ **Repr.con.fotos**: Comience reproduciendo la música seleccionada y luego muévase a la lista de fotos.
- ▶ **Marcar todo**: Marque toda la música del folder.
- ▶ **Desmarcar todo**: Cancele la selección de todas las canciones.
- ▶ **Borrar**: Borrar la música seleccionada.
- ▶ **Cerrar** : Cierre el pop- up menú.

- 1  Seleccione la carpeta o el disco de destino.
- 2   Seleccione todas las canciones.
- 3  Visualice el menú emergente.
- 4   Seleccione el menú emergente deseado.
- 5  Regresar a la pantalla del televisor.

- Use el botón **CH** ^ v para navegar en la página de títulos de música.
- Use el botón **MARK** para marcar o desmarcar una música. Si no se marca ninguna música, toda la música en la carpeta se reproducirá en secuencia. Cuando uno o más archivos de música estén marcados, la música marcada se reproducirá en secuencia. Si desea escuchar sólo una música repetidamente, simplemente marque esa música y reproduzca.

Uso de la opción Lista de música



1  Mostrar el Modo de audio.

2  Realizar los ajustes apropiados.

- El cuadro de información de reproducción (como se muestra a continuación) se moverá automáticamente por toda la pantalla cuando no haya una acción por parte del usuario que evite que la imagen fija de la pantalla permanezca por un período de tiempo prolongado.



! NOTA

- ▶ Cuando se reproduce una canción, se visualiza  frente al tiempo de reproducción.
- ▶ Un archivo de música dañado o alterado muestra 00:00 como el tiempo de reproducción.
- ▶ Los archivos de música protegidos contra copia no se reproducirán.
- ▶ Pulsar el botón **ENTER**, **■**, **RETURN**, **MENÚ**, **Menú rápido**, **ATRÁS**, **SALIR** o **AHORRO DE ENERGÍA** para detener el protector de pantalla.
- ▶ Este televisor no puede reproducir archivos de música de menos de 16 kbytes.

CONTROL DE IMAGEN

TAMAÑO DE LA IMAGEN (CONTROL DE RELACION DE ASPECTO)

Esta función le permite elegir de una imagen analoga una Relación de Aspecto 4:3 mostrada en la TV.

- RGB-PC Fuente de entrada de Relación de Aspecto 4:3 ó 16:9.

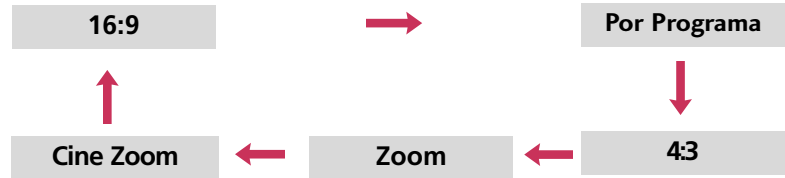

- 1 Seleccione **Relación de Aspecto**.
- 2 Seleccione el formato de imagen deseado.
- 3 Regresar a la pantalla del televisor.

- Usted también puede presionar el botón de **RATIO** repetitivamente en el control remoto.

16:9

Seleccione cuando desea ajustar la imagen horizontalmente, en una proporción lineal para llenar la pantalla completa.



Sólo búsqueda

Normalmente los bordes de las señales de video quedan recortadas un 1-2%. El modo Sólo búsqueda desactiva este recorte y muestra el video completo.

Notas: Si hubiera ruido en los bordes de la señal original, serán visibles cuando el modo Sólo búsqueda esté activado.

Esta función sólo se opera en los modos de DTV/CADTV/Component/HDMI-DTV/DVI-DTV (720 progresivo/1 080 entrelazado/1 080 progresivo).



Por Programa

Selecciona la proporción de imagen adecuada para que se corresponda con la imagen fuente.

(4:3 → 4:3)

(16:9 → 16:9)



4:3

La selección siguiente le dejará ver una imagen con la proporción original de aspecto 4:3.



Zoom

Seleccione cuando desea ver la imagen sin ninguna alteración. Sin embargo, las porciones superior e inferior de la imagen serán cortadas.

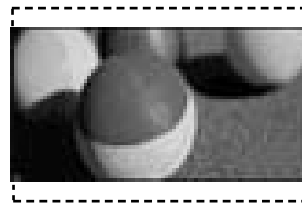

Cine Zoom

Seleccione Cine Zoom cuando desee ampliar la imagen en la proporción correcta.

Nota: La imagen puede verse distorsionada al ampliarla o reducirla.



- El rango de ajuste es de 1-16.

CONTROL DE IMAGEN

ASISTENTE DE IMAGEN



Esta función le permitirá ajustar la calidad de imagen de la imagen original.

Úsela para calibrar la calidad en pantalla ajustando el nivel de negro y blanco, etc. Podrá calibrar la calidad en pantalla siguiendo unos sencillos pasos.

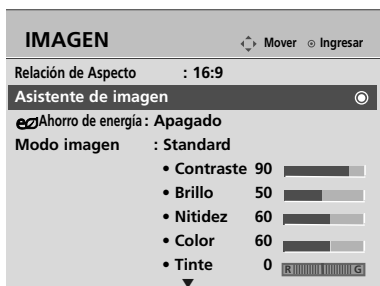
Cuando usted ajusta la imagen a **Bajo**, **Recomendado** o **Alto**, Usted puede ver el ejemplo del cambio que hizo.



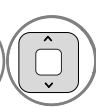

1   Seleccione **IMAGEN**.

2    Seleccione **Asistente de imagen**.



3  Ajuste el **Asistente de imagen**.

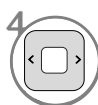

4   Ajuste el **Nivel Negro**.

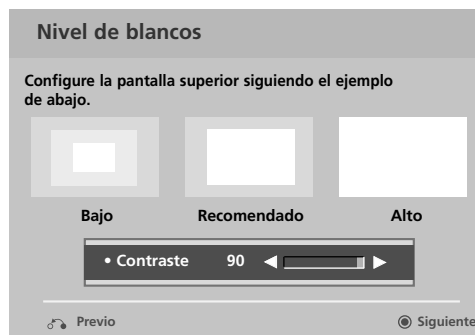

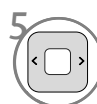
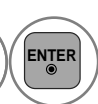
5   Ajuste el **Nivel de blancos**.





6   Ajuste el **Color**.



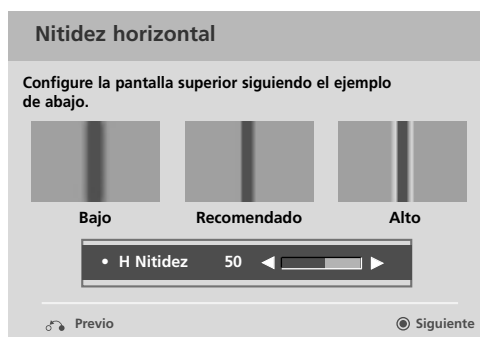

7   Ajuste el **Tinte**.





- 8   Ajuste el **Nitidez horizontal**.

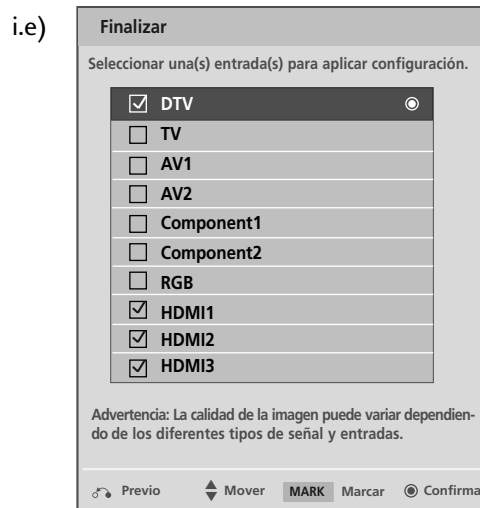

- 9   Ajuste el **Nitidez vertical**.



- 10   Escoja una fuente de entrada para aplicar los ajustes.

- 11  Guardar.

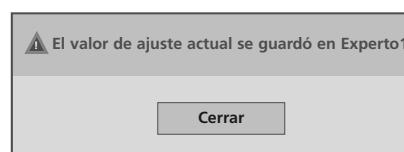

- 12  Finalice el **Asistente de imagen**.

- Si detiene los ajustes antes del paso final, dichos cambios no quedarán aplicados en el televisor.

CONTROL DE IMAGEN







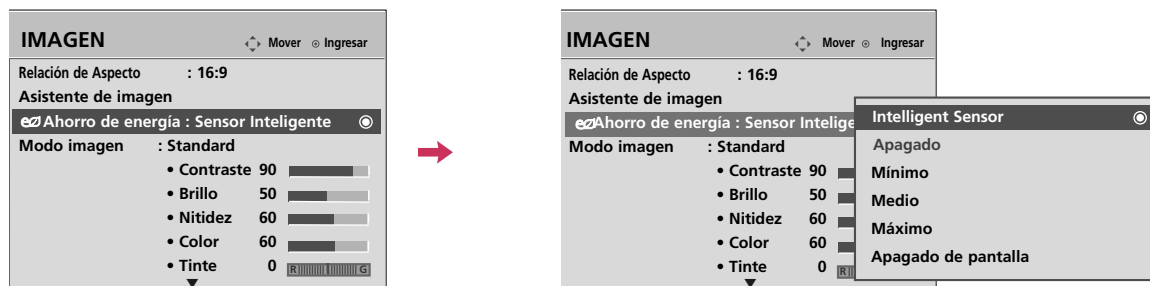

AHORRO DE ENERGÍA

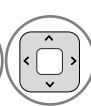
Este reduce el consumo eléctrico del televisor.

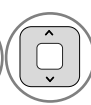
Puede incrementar el brillo de su pantalla ajustando el nivel Ahorro de Energía o Modo imagen.

Esta característica se desactiva en “Modo imagen -Cine”.



-   Seleccione **IMAGEN**.
-   Seleccione ** Ahorro de energía**.
-   Seleccione **Sensor Inteligente, Apagado, Mínimo, Medio, Máximo o Apagado de pantalla**.
-  Regresar al menú anterior.
-  Regresar a la pantalla del televisor.

■ Usted también puede presionar el botón de **ENERGY SAVING** en el control remoto.

■ Sensor Inteligente?

Si esta función está activa, la imagen se ajusta automáticamente para adecuarse lo más posible a las condiciones del entorno.

AJUSTES DE LA IMAGEN PRESTABLECIDA (MODO IMAGEN)

Hay configuraciones predeterminadas de fábrica disponibles en los menús del usuario. Puede usar una configuración predeterminada, cambiar cada configuración manualmente.

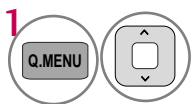

1 Seleccione **Modo imagen**.

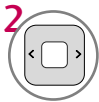

2 Seleccione **Vivo, Estándar, APS, Cine, Deporte, Juego, Experto1 o Experto2**.



3 Regresar a la pantalla del televisor.









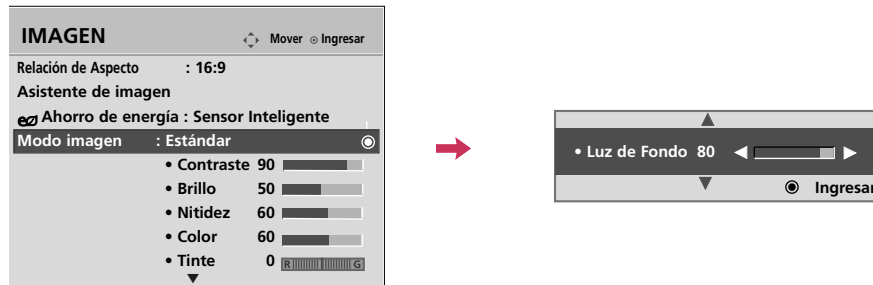



- Los ajustes **Vivo, Estándar, APS, Cine, Deporte y Juego** son preestablecidos en fábrica para lograr la mejor calidad de imagen.
- También ud. puede hacer la **Modo imagen** con el menú **IMAGEN**.
- **Vivo**: Este es el modo para maximizar el efecto del video en el expositor de la tienda. Intensifica el contraste, brillo, color y la nitidez para ofrecer imágenes vivas.
- **APS**: Este modo maximiza o reduce el consumo de energía sin afectar a la calidad de la imagen.
- **Estándar**: Este es el modo con el que se obtienen condiciones óptimas de visualización para el usuario general.
- **Cine**: Este modo optimiza el video para disfrutar películas.
- **Deporte**: Este es el modo de video para enfatizar el video dinámico y los colores primarios (ej: blanco, uniforme, césped, azul del cielo, etc.) obteniendo el ajuste óptimo de la pantalla para disfrutar los deportes.
- **Juego**: Este es el modo para obtener velocidad de respuesta rápida en una pantalla rápida de videojuego.
- **Experto**: Este es el modo para ajustar el video de forma pormenorizada para expertos en calidad de video y usuarios generales.

CONTROL DE IMAGEN

CONTROL MANUAL DE IMAGEN - MODO USUARIO

Ajuste la apariencia de la imagen según sus preferencias y situaciones de visualización.



-   Seleccione **IMAGEN**.
-   Seleccione **Modo imagen**.
-   Seleccione **Vivo, Estándar, Cine, Deporte** o **Juego**.
-   Seleccione **Contraste, Brillo, Nitidez, Color, Tinte** o Temperatura de Color .
-   Realice los ajustes adecuados.
-  Regresar al menú anterior.
-  Regresar a la pantalla del televisor.

- **Contraste:** Aumenta o disminuye el gradiente de la señal de video. (Podría usar el mando de contraste cuando las partes brillantes de la imagen queden saturadas).
- **Brillo:** Aumenta o disminuye el nivel de negro en la señal de video. Usted puede utilizar el brillo cuando el nivel de negro en la imagen no sea visible .
- **Nitidez:** Ajusta el nivel de nitidez de los bordes entre las zonas de imagen iluminadas y oscuras. Cuanto más bajo sea el nivel, más suave la imagen.
- **Color:** ajusta la intensidad de todos los colores.
- **Tinte:** Ajusta el balance entre niveles de rojo y verde.
- **Temperatura de Color:** Ajuste en cálido para mejorar los colores de gama más cálida como el rojo o en frío para dar a la imagen un tono más azulado.

TECNOLOGÍA DE MEJORA DE LA IMAGEN

Puede calibrar la pantalla para cada Modo de imagen o ajustar el valor del video de acuerdo con la pantalla especial de video.

Puede ajustar un valor de video diferente para cada entrada.

Para reiniciar a los ajustes preestablecidos de fábrica tras realizar ajustes para cada fuente de entrada, ejecute el “Restablecer” para cada Modo imagen.

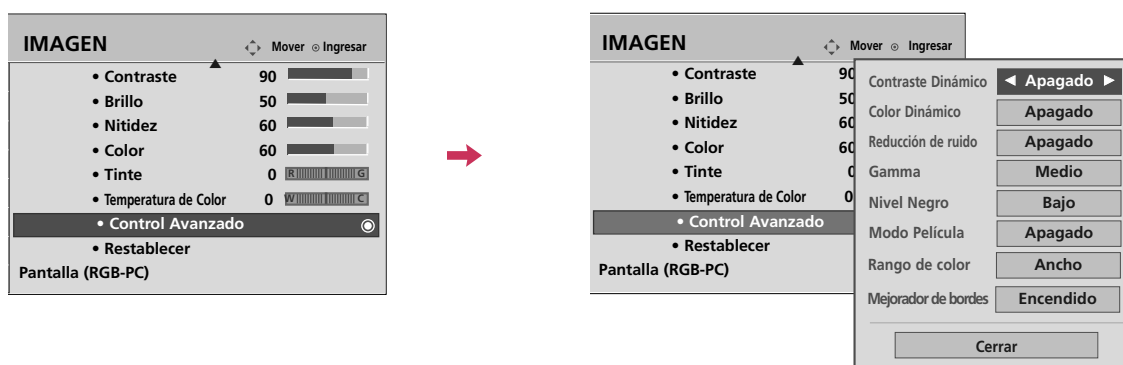

-   Seleccione **IMAGEN**.
-   Seleccione **Control Avanzado**.
-   Seleccione sus opciones deseadas.
-  Realice los ajustes adecuados.
-  Regresar al menú anterior.
-  Regresar a la pantalla del televisor.

CONTROL DE IMAGEN

CONTROL EXPERTO DE IMAGEN

Al segmentar categorías, el **Experto1** y **Experto2** proporcionan más categorías que los usuarios pueden configurar a su gusto, lo que ofrece una calidad de imagen óptima para los usuarios.

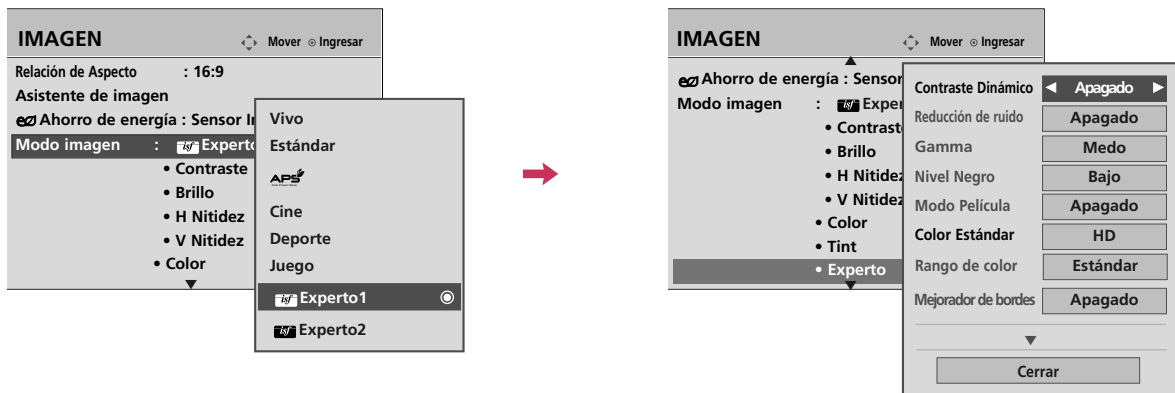

CONTROL DE IMAGEN

-   Seleccione **IMAGEN**.
-   Seleccione **Modo imagen**.
-   Seleccione  **Experto1**, o  **Experto2**.
-   Seleccione **Control de Experto**.
-   Seleccione su opción del menú deseada.
-  Realice los ajustes adecuados.
-  Regresar al menú anterior.
-  Regresar a la pantalla del televisor.

Contraste Dinámico	<ul style="list-style-type: none"> ■ Ajusta el contraste para mantenerlo en el nivel óptimo dependiendo del brillo de la pantalla. La Imagen es mejorada haciendo las partes brillantes mas brillantes y las partes oscuras mas oscuras.
Color Dinámico	<ul style="list-style-type: none"> ■ Ajusta los colores en pantalla para que aparezcan vivos, ricos y limpios. Esta función mejora el tono, saturación e iluminación de forma que rojos, azules, verdes y blancos parezcan más vivos.
Reducción de ruido	<ul style="list-style-type: none"> ■ Reduce el ruido en pantalla sin afectar la calidad de video.
Gamma	<p><i>Bajo : ilumina la zona de nivel oscuro y gris de la imagen.</i> <i>Medio: graduación rápida de la imagen original.</i> <i>Alto: oscurece la zona de nivel oscuro y gris de la imagen.</i></p> <ul style="list-style-type: none"> ■ Puede ajustar el brillo de la zona oscura y la zona del nivel de gris de la imagen.
Nivel Negro	<p><i>Bajo: La reflexión de pantalla se pone más oscura.</i> <i>Alto: La reflexión de pantalla se pone más clara.</i> <i>Automático: Cuando advierta el nivel negro en la pantalla, se establecerá en alto o bajo automáticamente.</i></p> <ul style="list-style-type: none"> ■ Ajuste el nivel de negro de la pantalla al nivel adecuado. ■ Esta función permite escoger "Bajo" o "Alto" en el siguiente modo: AV (NTSC-M), HDMI o por componentes. De lo contrario, el "Nivel Negro" se ajusta en "Automático".
Modo Película	<ul style="list-style-type: none"> ■ Hace que los videoclips grabados se vean de forma más natural. ■ Las películas en DVD y Blu-ray están filmadas a 24 fotogramas por segundo.
Rango de color	<p><i>Estándar: Muestra el color estándar del área</i> <i>Amplio: modo para usar y ajustar la zona de color rica de la pantalla.</i></p> <ul style="list-style-type: none"> ■ Maximizar el uso del color para aumentar la calidad del color: ■ Esta función se activa en "Temperatura de Color - Cálido".
Mejorador de bordes	<ul style="list-style-type: none"> ■ Mostrar las esquinas del video más claras y nítidas, pero siempre naturales.
Color Estándar	<ul style="list-style-type: none"> ■ Convierte a color HD un video que posea color diferente.
Balance Blanco	<ul style="list-style-type: none"> ■ Esta es la función para ajustar el color general de la pantalla a su gusto. <ol style="list-style-type: none"> Método : 2 puntos <ul style="list-style-type: none"> - Patrón: Interior, Exterior - Contraste Rojo/Verde/Azul, Brillo Rojo/Verde/Azul: El rango de ajuste es de -50 - +50. Método : IRE de 20 puntos <ul style="list-style-type: none"> - Patrón: Interior, Exterior - IRE (Institute of Radio Engineers: Instituto de ingenieros de radio) es la unidad para visualizar el tamaño de la señal de video y puede ajustarse entre 5, 10, 15 - 95, 100. Puede ajustar el rojo, verde o azul de acuerdo a cada valor. - Rojo/Verde/Azul: El rango de ajuste es de -50 - +50.
Sistema de Mantenimiento de Color	<ul style="list-style-type: none"> ■ Al igual que la herramienta usada por los expertos para realizar ajustes mediante los modelos de prueba, esta no afecta a otros colores, pero puede usarse para ajustar selectivamente las 6 zonas de color (Rojo/Verde/Azul/Cian/Magenta/Amarillo). La diferencia de color podría no distinguirse aun cuando realice ajustes para el video general. Ajustar Rojo/Verde/Azul/Amarillo/Cian/Magenta. <ul style="list-style-type: none"> - Color Rojo/Verde/Azul/Amarillo/Cian/Magenta: El rango de ajuste es de -30 - +30. - Tinte Rojo/Verde/Azul/Amarillo/Cian/Magenta: El rango de ajuste es de -30 - +30. - Esta característica se desactiva en modo RGB-PC y HDMI (PC) .



CONTROL DE IMAGEN

RESTABLECIMIENTO DE LA IMAGEN

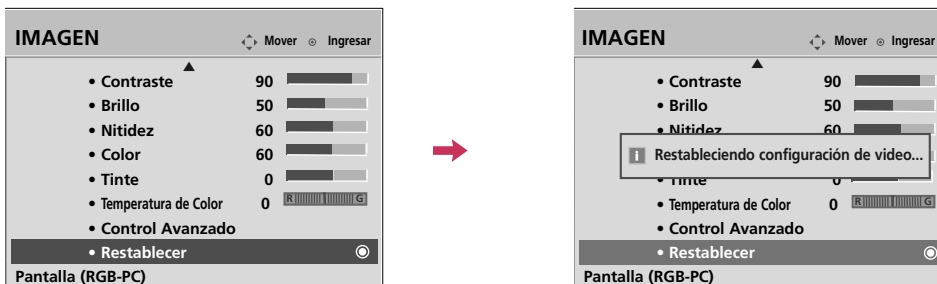
Las configuraciones de los modos de pantalla seleccionados vuelven a las configuraciones predeterminadas de fábrica.



- 1   Seleccione **IMAGEN**.
- 2   Seleccione **Restablecer**.

- 3  Inicialice el valor ajustado.
- 4  Regresar a la pantalla del televisor.

MODO DEMO

Visualice el pase de diapositivas que explica distintas funciones de este televisor. Esta característica se desactiva en “Configuración Inicial - Usar en Casa”.

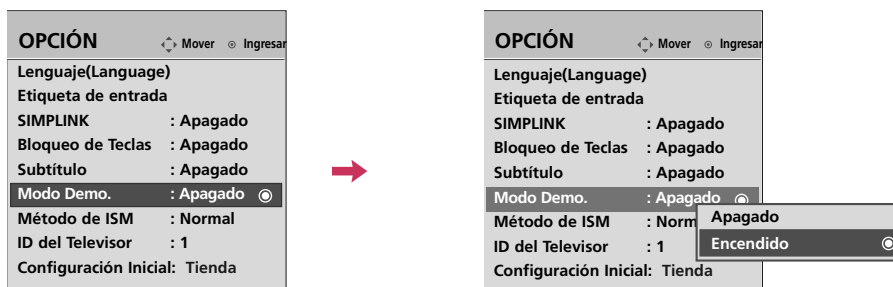







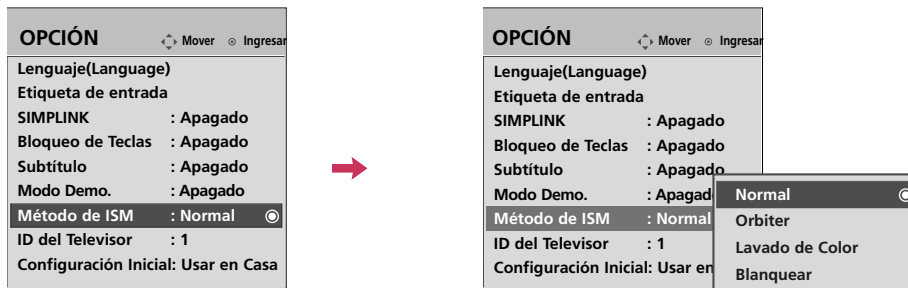

- 1   Seleccione **OPCIÓN**.
- 2   Seleccione **Modo Demo..**
- 3   Seleccione **Encendido**.

- 4  Regresar a la pantalla del televisor.
Tras un breve período de tiempo, comenzará el **Modo Demo**. Si desea detener la demostración, pulse cualquier botón. (excepto VOL o MUTE)
- 5 Mostrar la distintas funciones del televisor.
- 6 Mostrar las distintas funciones de XD Engine.

MINIMIZACIÓN DE IMAGEN FANTASMA

Una imagen congelada para que aparezca en pantalla durante un período prolongado, resultará en una imagen fantasma que permanecerá incluso al cambiar de imagen. Puede utilizar Orbiter para evitar la adherencia de la imagen. Las otras dos funciones son para eliminar las imágenes fantasma.



- 1   Seleccione **OPCIÓN**.
- 2   Seleccione **Método de ISM**.
- 3   Seleccione **Normal, Orbiter, Lavado de Color o Blanquear**.
- 4  Regresar al menú anterior.
-  Regresar a la pantalla del televisor.

- **Normal:** Si la imagen fantasma no es un problema, ISM no es necesario - Seleccione Normal.
- **Orbiter:** Esta función puede ayudar a prevenir imágenes fantasma. Sin embargo, es mejor no permitir imágenes fijas en pantalla. Para evitar que haya una imagen fija en la pantalla, la imagen se moverá cada 2 minutos.
- **Lavado de Color:** Se muestran alternativamente el bloque de color con la pantalla desplazada ligeramente y el patrón blanco. Es difícil visualizar la imagen resultante en todos los colores. Una vez corregido, no será visible en ningún color.
- **Blanquear :** Es la función que remueve las imágenes permanentes de la pantalla. Use moderadamente. Mire el televisor normalmente durante un momento antes de utilizar esta función para ver si desaparece la imagen fantasma por sí sola.

! NOTA

- ▶ Es imposible limpiar perfectamente una imagen que ha permanecido expuesta por mucho tiempo con la función de Blanquear. Para regresar a la pantalla, presione cualquier botón.

CONTROL DE SONIDO Y DE IDIOMA

NIVELADOR AUTOMÁTICO DE VOLUMEN

Volumen automático le asegura que el nivel de volumen permanece constante si está viendo anuncios o un programa de televisión.

Debido a que la señal de cada cadena de televisión dispone de características propias, podría ser preciso ajustar el volumen cada vez que cambie de canal. Esta función permite a los usuarios disfrutar de niveles uniformes de volumen realizándose ajustes automáticos para cada canal.







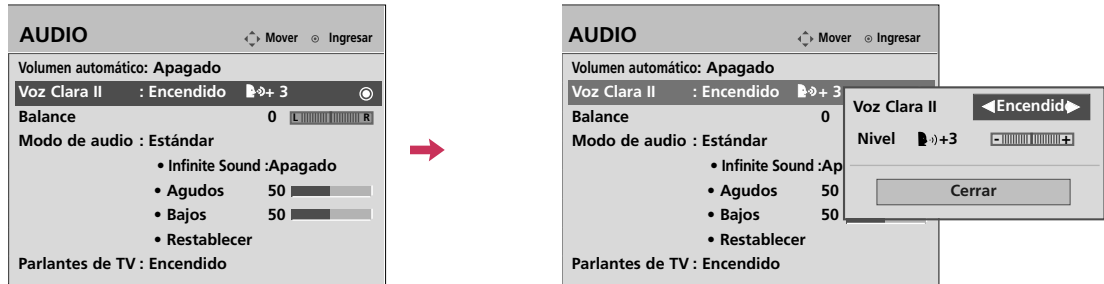

-   Seleccione **AUDIO**.
-   Seleccione **Volumen automático**.
-   Seleccione **Encendido** o **Apagado**.
-  Regresar al menú anterior.
-  Regresar a la pantalla del televisor.









VOZ CLARA II

Como diferencia el registro de sonidos de los otros, logra que la calidad de sonido de las voces sea mejor.



- 1   Seleccione **AUDIO**.
- 2   Seleccione **Voz Clara II**.
- 3   Seleccione **Encendido** o **Apagado**.

Ajuste del nivel de la función Voz Clara II Con la selección Encendido

- 4   Seleccione **Voz Clara II**.
- 5   Seleccione **Nivel**.
- 6   Realice los ajustes adecuados.
- 7  Regresar al menú anterior.
-  Regresar a la pantalla del televisor.





CONTROL DE SONIDO Y DE IDIOMA

AJUSTES DE SONIDO PREESTABLECIDOS (MODO DE AUDIO)

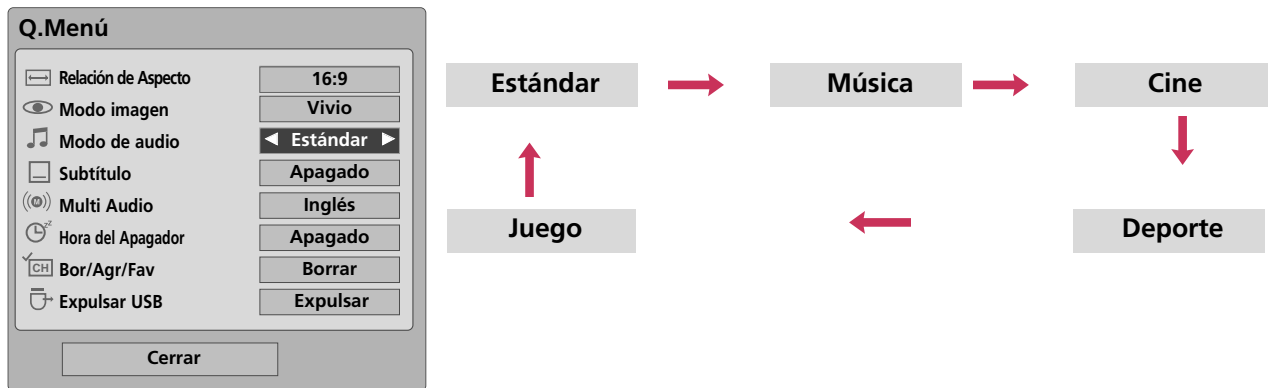
Modo de audio le permite disfrutar del mejor sonido sin ningún ajuste especial porque la televisión configura las opciones de sonido apropiadas según el contenido del programa.

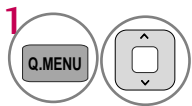
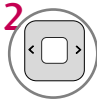

-  Seleccione **Modo de audio**.
-  Seleccione **Estándar, Música, Cine, Deporte** o **Juego**.
-  Regresar a la pantalla del televisor.

- Usted también puede ajustar el **Modo de audio** en el **AUDIO**.
- **Estándar**: Ofrece sonido de calidad estándar.
- **Música**: Optimiza el sonido para escuchar música.
- **Cine**: Optimiza el sonido para disfrutar películas.
- **Deporte**: Optimiza el sonido para disfrutar eventos deportivos.
- **Juego**: Optimiza el sonido para jugar con videojuegos.

AJUSTE DE SONIDO - MODO USUARIO

Usted puede ajustar sonidos agudos y bajos a los niveles de su preferencia.

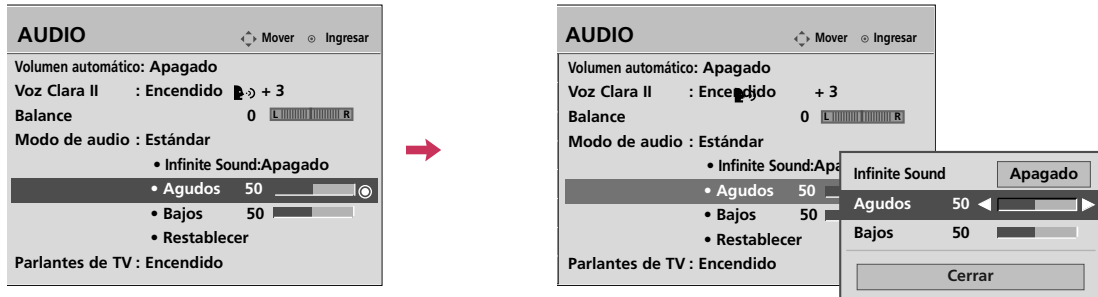

-   Seleccione **AUDIO**.
-   Seleccione **Modo de audio**.
-   Seleccione **Estándar, Música, Cine, Deporte o Juego**.
-   Seleccione **Agudos o Bajos**.
-   Realice los ajustes adecuados.
-  Regresar al menú anterior.
-  Regresar a la pantalla del televisor.

CONTROL DE SONIDO Y DE IDIOMA

INFINITE SOUND

Escoja esta opción para obtener un sonido realista.



- 1   Seleccione **AUDIO**.
- 2   Seleccione **Infinite Sound**.
- 3   Seleccione **Encendido** o **Apagado**.
- 4  Regresar al menú anterior.
-  Regresar a la pantalla del televisor.

■ Si selecciona "Clear Voice II-On" (Voz clara II-Activada), la característica Infinite Sound no funcionará.

AJUSTE DE BALANCE

Puede ajustar el balance de sonido de las bocinas a los niveles que desea ud.

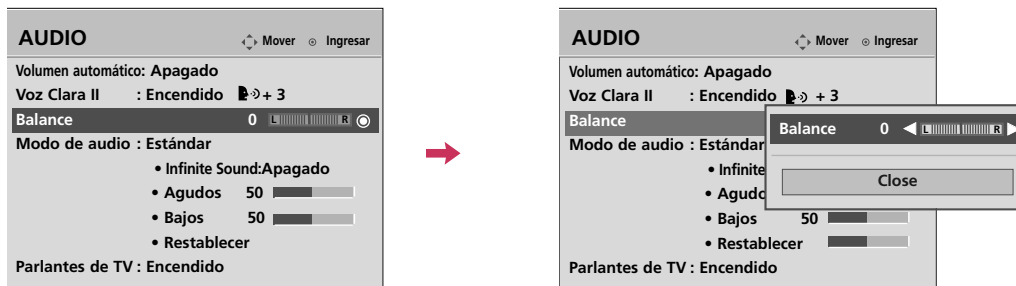

- 1   Seleccione **AUDIO**.
- 2   Seleccione **Balance**.
- 3   Realice los ajustes adecuados.
- 4  Regresar al menú anterior.
-  Regresar a la pantalla del televisor.

CONTROL DE SONIDO Y DE IDIOMA

DISPOSICIÓN DE BOCINAS DE TV

Apague los altavoces si está utilizando un equipo de audio externo.

En AV1, Component, RGB y HDMI con un cable HDMI a DVI, se puede oír el altavoz de la TV aunque no haya señal de vídeo.

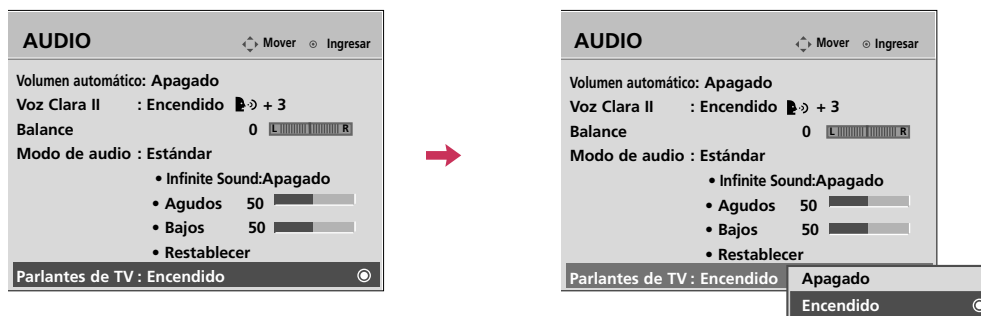

- 1   Seleccione **AUDIO**.
- 2   Seleccione **Parlantes de TV**.
- 3   Seleccione **Encendido** o **Apagado**.
- 4  Regresar al menú anterior.
-  Regresar a la pantalla del televisor.

REAJUSTE DE AUDIO

Las configuraciones de los modos de sonido seleccionados vuelven a las configuraciones predeterminadas de fábrica.

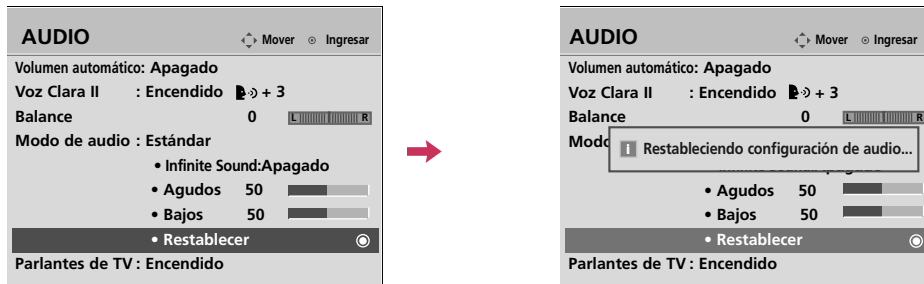

-   Seleccione **AUDIO**.
-   Seleccione **Restablecer**.
-  Inicialice el valor ajustado.
-  Regresar a la pantalla del televisor.

CONTROL DE SONIDO Y DE IDIOMA

DISFRUTE DE LA TRANSMISIÓN ESTÉREO/SAP



Solo para análogos: este televisor puede recibir programas de estéreo MTS y de cualquier SAP (programa de audio secundario) que acompañe el programa de estéreo si la estación transmite una señal de sonido adicional. El sonido mono se utiliza automáticamente si se transmite solo en mono.



Televisor análogo

-   Seleccione **SAP**.
-  Seleccione **Mono, Stereo** o **SAP**.
-  Regresar a la pantalla del televisor.

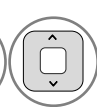
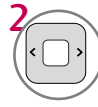

Televisor digital

-   Seleccione **Multi Audio**.
-  Seleccione otro idioma.
-  Regresar a la pantalla del televisor.

IDIOMA DEL AUDIO

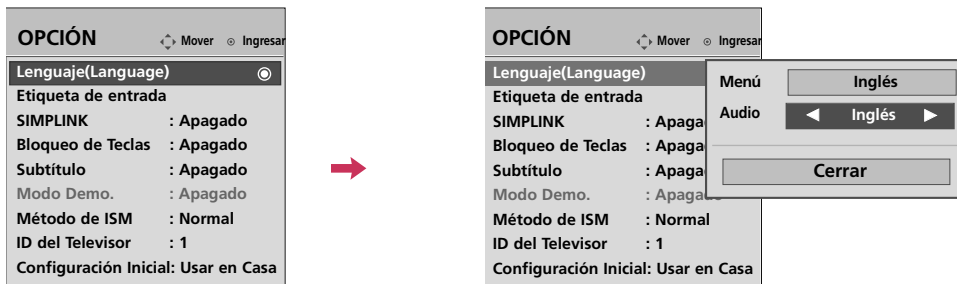
Es posible que haya otros idiomas disponibles si la emisora proporciona una señal digital.
Esta función opera sólo en modo DTV/CADTV.











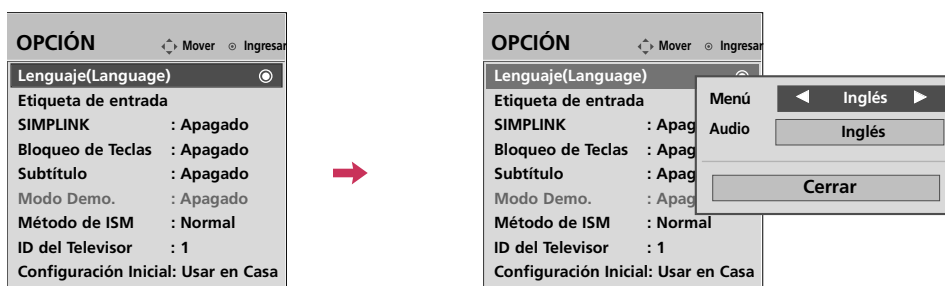

-   Seleccione **OPCIÓN**.
-   Seleccione **Lenguaje(Language)**.
-   Seleccione **Audio**.
-   Seleccione su idioma deseado.
-  Regresar al menú anterior.
-  Regresar a la pantalla del televisor.

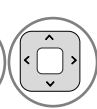
CONTROL DE SONIDO Y DE IDIOMA

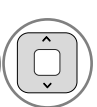
SELECCIÓN DEL LENGUAJE EN LA PANTALLA

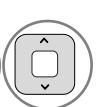
Los menus pueden ser mostrados en la pantalla en el idioma inicial seleccionado.

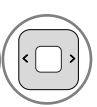





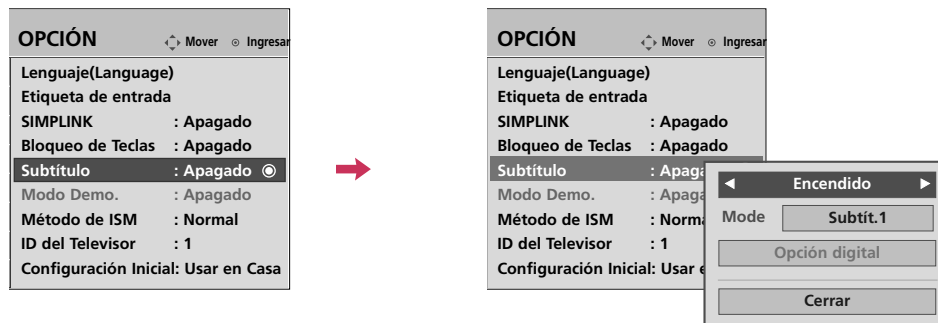

-   Seleccione **OPCIÓN**.
-   Seleccione **Lenguaje(Language)**.
-   Seleccione **Menú**.
-   Seleccione su idioma deseado.
De aquí en adelante la exhibición en la pantalla aparecerá en el idioma seleccionado.
-  Regresar al menú anterior.
-  Regresar a la pantalla del televisor.

SUBTÍTULOS

Sistemas de texto oculto de programas analógicos

Se debe proporcionar subtítulos para ayudar a ver TV a las personas que no escuchan. Seleccione un modo de subtulado para visualizar la información de subtulado si el programa lo proporciona. El subtulado análogo visualiza información en cualquier posición de la pantalla y se trata generalmente del cuadro de diálogo del programa. El subtulado o el texto, si la estación los proporciona, serían aconsejables para los canales digitales o análogos de la antena o cable. Este televisor está programado para memorizar el modo de subtulado o texto que fue configurado la última vez que apagó el equipo. Esta función sólo está disponible cuando Modo Subtítulos está definido en Encendido.



- 1   Seleccione **OPCIÓN**.
- 2   Seleccione **Subtítulo**.
- 3   Seleccione **Encendido**.
- 4   Seleccione **Subtit.1 - 4, Texto1 - 4**.
- 5  Regresar al menú anterior.
-  Regresar a la pantalla del televisor.









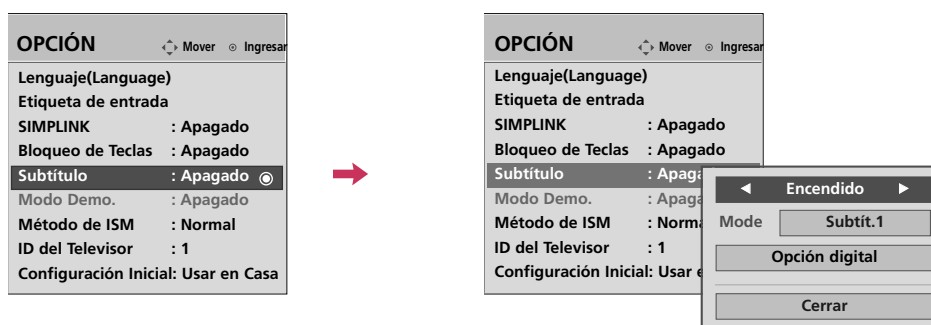

- Al seleccionar **Apagado**, se desactivan los submenús para Análogo, DTV y Opción digital.
- **SUBTÍTULO**
Término que se utiliza para las palabras que aparecen en la parte inferior de la pantalla de la televisión; Se trata normalmente de las partes de audio del programa que se proporcionan para las personas con deficiencias auditivas.
- **TEXTO**
Término que se utiliza para las palabras que aparecen en un gran marco negro y que cubren casi toda la pantalla; Se trata normalmente de los mensajes proporcionados por el proveedor del programa.

CONTROL DE SONIDO Y DE IDIOMA

Sistemas de texto oculto de programas digitales

Seleccione el idioma en el que desea que aparezcan los textos ocultos de DTV/CADTV. Sólo podrán escogerse otros idiomas para las fuentes digitales si están incluidos en el programa. Esta función sólo está disponible cuando Modo Subtítulos está definido en Encendido.



-   Seleccione **OPCIÓN**.
-   Seleccione **Subtítulo**.
-   Seleccione **Encendido**.
-   Seleccione **Subtít.1 - 4**, **Texto1 - 4** o **Servicio1 - 6**.
-  Regresar al menú anterior.
-  Regresar a la pantalla del televisor.

Opciones del texto oculto

Personalice el texto oculto de DTV/CADTV que aparece en la pantalla.

Esta función sólo está disponible cuando Modo **Subtítulos** está definido en **Encendido**.



1 Seleccione **OPCIÓN**.

2 Seleccione **Subtítulo**.

3 Seleccione **Encendido**.

4 Seleccione **Opción digital**.

5 Seleccione **Personalizar**.

6 Personalizar el **Tamaño, Letra, etc.**, según sus preferencias.

En la parte inferior de la pantalla se proporciona un icono de previsualización. Utilícelo para ver el idioma del texto oculto.

7 Regresar al menú anterior.

Regresar a la pantalla del televisor.

- **Tamaño:** Ajuste el tamaño en el que aparecerán las palabras.
- **Letra:** Seleccione un tipo de letra para las palabras.
- **Color del Texto:** Escoja un color para el texto.
- **Palidez del Texto:** Especifique la opacidad del color del texto.
- **Color de Fondo:** Seleccione un color de fondo.
- **Palidez del Fondo:** Seleccione la opacidad del color de fondo.

CONFIGURACIÓN HORARIA

PROGRAMACION DEL RELOJ

Configuración Auto del Reloj

El tiempo se selecciona automáticamente desde una señal de canal digital.

La señal del canal digital incluye información de la hora actual proporcionada por la emisora que transmite.

Si la hora actual es incorrecta, puede ajustar manualmente el reloj mediante la función de reloj automático.

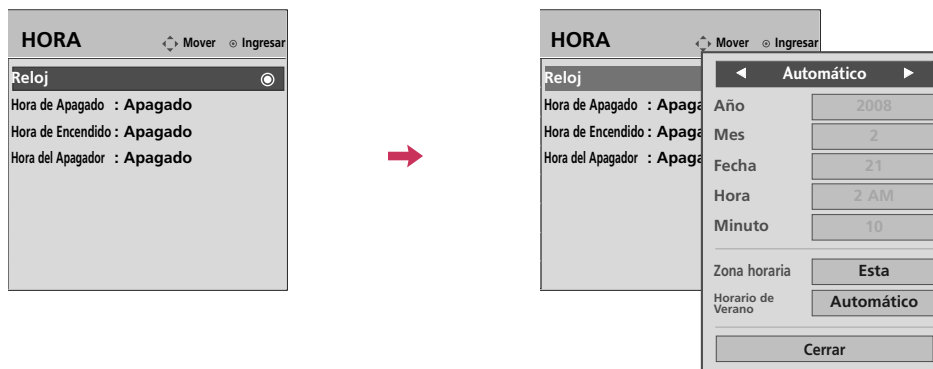







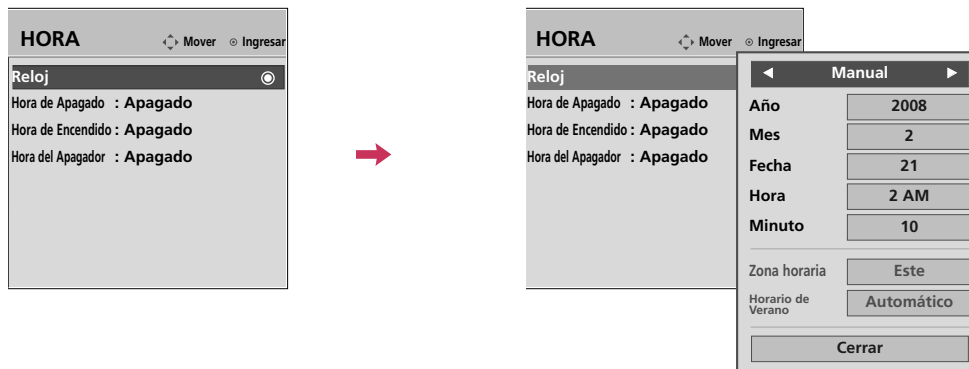



-   Seleccione **HORA**.
-   Seleccione **Reloj**.
-   Seleccione **Automático**.
-   Seleccione la zona horaria de su área de recepción:
 - EE.UU.: **Este, Central, Montaña, Pacífico, Alaska o Hawaii.**
 - Canadá: **Este, Central, Montaña, Pacífico, Terranova o Atlantico.**
-   Seleccione **Automático, Apagado, Encendido**, dependiendo de si su región hace o no uso del Horario de verano.
-  Regresar al menú anterior.
-  Regresar a la pantalla del televisor.

Configuración Manual del Reloj

Si la hora actual programada esta equivocada, restablezca el reloj manualmente.



-   Seleccione **HORA**.
-   Seleccione **Reloj**.
-   Seleccione **Manual**.
-  Seleccione bien el año, el mes, la fecha, la hora o el minuto
-  Ajustar bien el año, el mes, la fecha, la hora o el minuto
-  Regresar al menú anterior.
-  Regresar a la pantalla del televisor.

► Si este televisor se desenchufa o se apaga mediante el principal de prendido, la función reloj quedará reiniciada.

CONFIGURACIÓN HORARIA

AJUSTES DE ENCENDIDO/ APAGADO AUTOMÁTICO DEL TEMPORIZADOR











El temporizador apagado cambia la unidad automáticamente al modo de espera en el tiempo prefijo.

La función de apagado se invalida en la función de encendido si ambos están configurados para el mismo tiempo.

La unidad debe estar en el modo de espera para que funcione el temporizador encendido.







Después de dos horas de que está cambiada la unidad por la función de encendido, se cambiará al modo de espera automáticamente si no haya presionado ningún botón.



- 1   Seleccione **HORA**.
- 2   Seleccione **Hora de Apagado** o **Hora de Encendido**.
- 3   Seleccione **Repetir**.
- 4  Seleccione **Apagado, Una vez, Diariamente, Lun.~Vie., Lun.~Sáb., Fin de semana** o **Domingo**.
- 5   Seleccione y ajustar **Hora** o **Minuto**.
- 6  Regresar al menú anterior.
-  Regresar a la pantalla del televisor.

■ Para cancelar la función de **Hora de Apagado / Hora de Encendido**, seleccionar **Apagado**.

■ Sólo para la función Hora de Encendido





- 1   Seleccione **Entrada**.
- 2  Seleccione la fuente de entrada deseada.
- 3   Si selecciona **TV**: Seleccione el canal que desea.
- 4   Regresar al menú previo.

CONFIGURACIÓN DEL TEMPORIZADOR DE APAGADO AUTOMÁTICO

La Hora del Apagador para Dormir apaga el TV después de un tiempo prefijado.

Si apaga el TV después de haber programado la hora del Apagador para dormir, el ajuste se borrará.



-   Seleccione **Hora del Apagador**.
-  Seleccione **Apagado**, 10, 20, 30, 60, 90, 120, 180 o 240.
-  Regresar a la pantalla del televisor.

■ También ud. puede hacer la **Hora del Apagador** con el menú **HORA**.

CONTROL PATERNO / CLASIFICACIONES

Es posible utilizar el control paterno para bloquear los canales específicos, las clasificaciones y otras fuentes de visualización.

La función del control paterno (V-Chip) se utiliza para bloquear la visualización de un programa que se basa en las clasificaciones enviadas por la emisora. La configuración por defecto permite ver todos los programas. Es posible bloquear la visualización según el tipo de programa y las categorías que se quieran bloquear. También es posible bloquear la visualización de todos los programas durante un período de tiempo. Para utilizar esta función, debe hacer lo siguiente:

1. Configure las clasificaciones y las categorías que desee bloquear.
2. Especifique una contraseña.
3. Permita el bloqueo

Clasificaciones y categorías V-Chip

Las pautas para la clasificación las proporcionan las emisoras. La mayoría de los programas y películas de televisión se pueden bloquear mediante las clasificaciones de la televisión y/o las categorías individuales. Tanto las películas que se han emitido en los cines como las películas de salida directa de alquiler utilizan únicamente el sistema de clasificación de películas de la Asociación Americana de Películas (MPAA).

Clasificación para los programas de televisión que incluye a las películas para televisión:

- TV-G (Para todos los públicos)
- TV-PG (Se sugiere la compañía paterna)
- TV-14 (Para mayores de 14 años. Se recomienda la supervisión paterna)
- TV-MA (Sólo público adulto)
- TV-Y (Para todas las edades)
- TV-Y7 (Para niños mayores de 7 años)

ESTABLECER CONTRASEÑA Y BLOQUEO DEL SISTEMA

Configuración de su Contraseña

Le deja configurar el esquema de bloqueo para bloquear unos canales especificados, clasificación y fuentes de vista. Una contraseña es requerida para acceder a este menú si el sistema de bloqueo está activado.

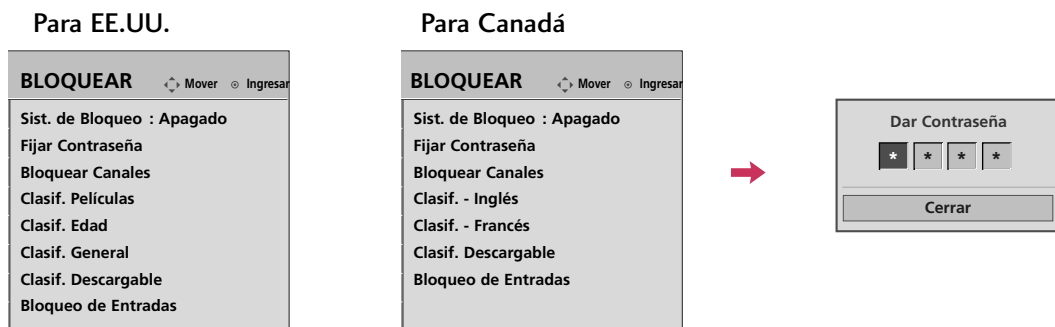

1  Seleccione **BLOQUEAR**.

2  Meter la contraseña

- Entre la contraseña requerida.
- Si usted olvida su contraseña, presione "0-3-2-5" en el control remoto.

Bloqueo Del Sistema

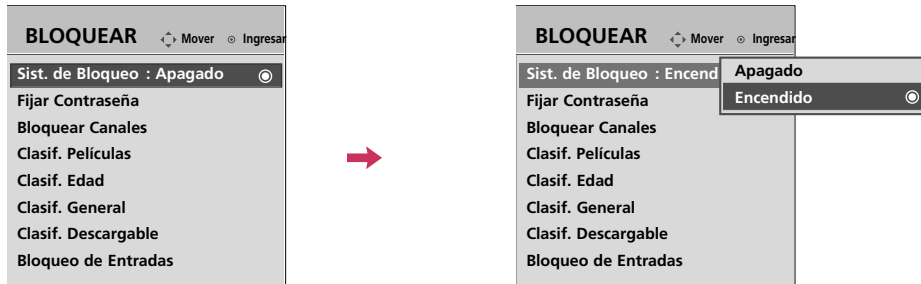

Activa o desactiva el estado de bloqueo establecido con anterioridad.





1    Seleccione **BLOQUEAR**.

2  Meter la contraseña

3  Seleccione **Sist. de Bloqueo**.

4   Seleccione **Encendido** o **Apagado**.

5  Regresar al menú anterior.

 Regresar a la pantalla del televisor.

■ Al seleccionarlo, activara el Bloqueo del sistema.

CONTROL PATERNO / CLASIFICACIONES

Establecer Contraseña

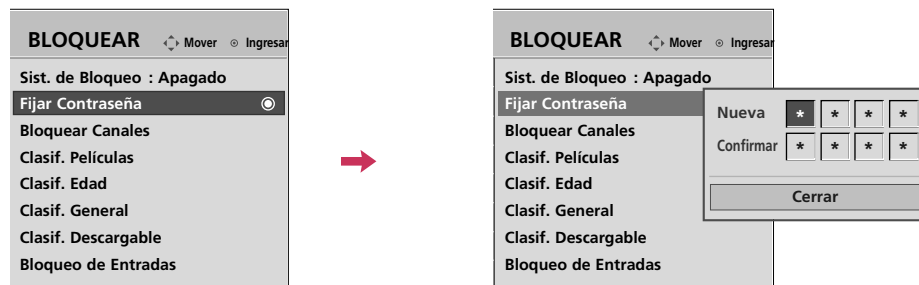

Cambie la contraseña introduciendo dos veces una nueva.





1    Seleccione **BLOQUEAR**.

2  Meter la contraseña.

3  Seleccione **Fijar Contraseña**.

4   Escoja 4 dígitos para su **Nueva** contraseña e introdúzcalos. Después de introducir los 4 dígitos, vuelva a hacerlo en el campo **Confirmar**.

5  Regresar al menú anterior.

 Regresar a la pantalla del televisor.

BLOQUEO DE CANALES



Bloquea cualquier canal que no desee visualizar o que no desea que sus hijos puedan ver.





1    Seleccione **BLOQUEAR**.

2  Meter la contraseña.

3  Seleccione **Bloquear Canales**.

4   Seleccione un canal para bloquear o desbloquear.

5  Bloquear o desbloquear un canal.

6  Regresar al menú anterior.

 Regresar a la pantalla del televisor.

CONTROL PATERNO / CLASIFICACIONES

CLASIFICACIONES DE PELÍCULAS Y TV

Clasificaciones de películas - *Sólo para EE.UU.*

Bloquea películas conforme a los límites de clasificación especificados, de tal forma que los niños no puedan ver ciertas películas. Puede configurar este límite para que bloquee todas las películas cuya clasificación sea superior a un nivel especificado. Tenga presente que este límite sólo será aplicable a las películas que aparezcan en TV, no a los propios programas de TV, como series de TV.

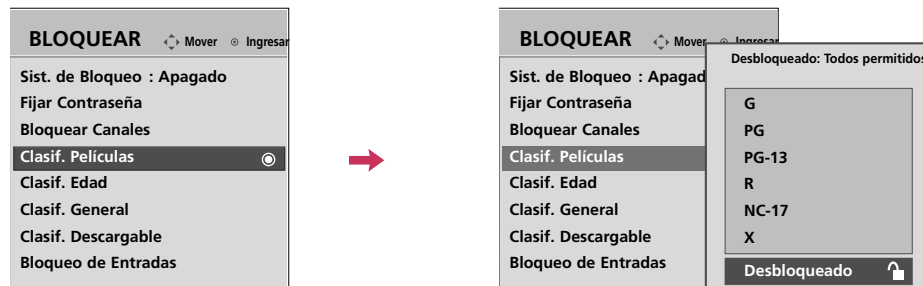



1    Seleccione **BLOQUEAR**.

2  Meter la contraseña.

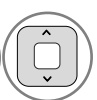
3  Seleccione **Clasif. Películas**.

4   Seleccione **G, PG, PG-13, R, NC-17, X o Desbloqueado**.

5  Regresar al menú anterior.

 Regresar a la pantalla del televisor.

- G (Para todos los públicos)
- PG (Se sugiere la compañía paterna)
- PG-13 (Para mayores de 13 años. Se recomienda la supervisión paterna)
- R (Restringido/Sólo para mayores)
- NC-17 (No recomendado a menores de 17 años)
- X (Sólo para adultos)
- Desbloqueado (Permite todos los programas)
- ▶ Si selecciona PG-13: Estarán disponibles las películas G y PG mientras que se bloquearán las PG-13, R, NC-17 y X.

Clasificación de TV- Infantil - Sólo para EE.UU.

Evita que los niños vean ciertos programas infantiles de TV, conforme al límite de clasificación establecido. Esta clasificación no es aplicable a otros programas de TV.

A menos que bloquee ciertos programas de TV pensados para audiencias maduras en el menú secundario de clasificación de la TV, sus hijos estarán expuestos a estos programas.

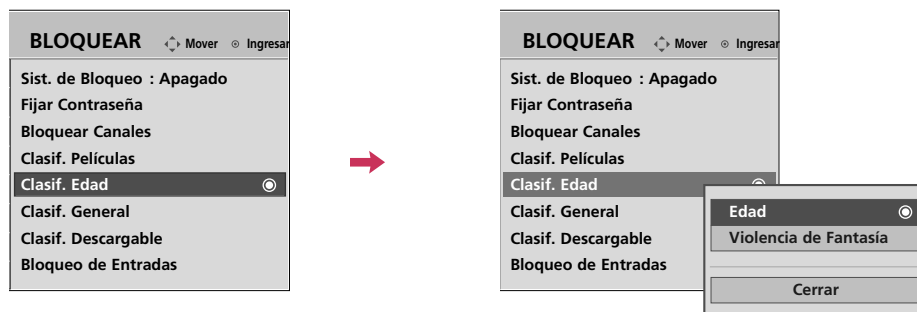



1    Seleccione **BLOQUEAR**.

2  Meter la contraseña

3  Seleccione **Clasif. Edad**.

4   Seleccione **Edad** o **Violencia de Fantasía**.

5   Seleccione las opciones de bloqueo.

6  Regresar al menú anterior.

 Regresar a la pantalla del televisor.

- Edad (se aplica a TV-Y, TV-Y7)
- Violencia de fantasía (se aplica a TV-Y7)

CONTROL PATERNO / CLASIFICACIONES

Clasificación de TV - General - Sólo para EE.UU.

En base a la Clasificación esta opción bloquea ciertos programas de TV que usted y su familia no desean ver.

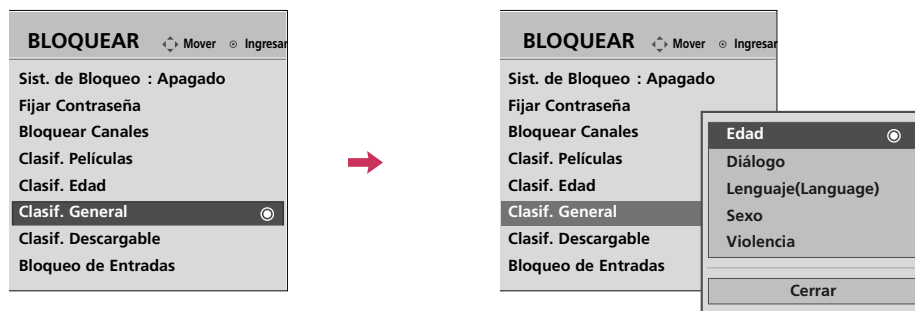



1    Seleccione **BLOQUEAR**.

2  Meter la contraseña.

3  Seleccione **Clasif. General**.

4   Seleccione **Edad, Diálogo, Lenguaje, Sexo o Violencia**.

5   Seleccione las opciones de bloque.

6  Regresar al menú anterior.

 Regresar a la pantalla del televisor.

- Edad (Edad se aplica a TV-G,TV-PG,TV-14, TV-MA)
- Diálogos- diálogos con contenido sexual (se aplica a TV-PG y TV-14)
- Lenguaje- lenguaje adulto (se aplica a TV-PG, TV-14 y TV-MA)
- Sexo - situaciones sexuales (se aplica a TV-PG, TV-14 y TV-MA)
- Violencia (se aplica a TV-PG,TV-14,TV-MA)

Clasif. - Inglés - Sólo para CANADÁ

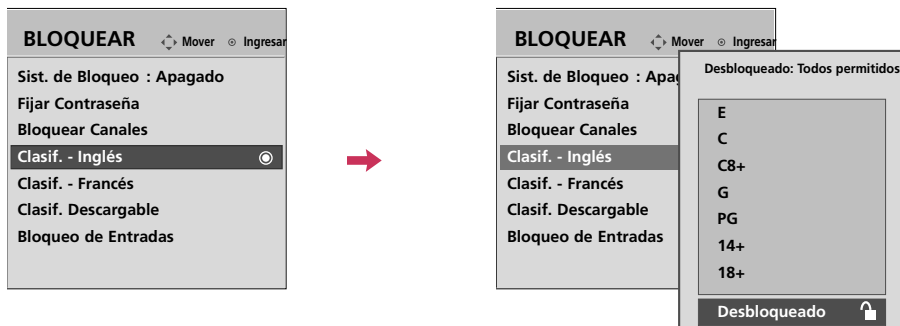

Selección del sistema de clasificación de inglés.





1    Seleccione **BLOQUEAR**.

2  Meter la contraseña.

3  Seleccione **Clasif.-Inglés**.

4   Seleccione **E, C, C8+, G, PG, 14+, 18+, o Desbloqueado**.

5  Regresar al menú anterior.

 Regresar a la pantalla del televisor.

- E (Exento)
- C (Niños)
- C8+ (Niños mayores de 8 años)
- G (Programación general, apta para todos los públicos)
- PG (Directrices parentales)
- 14+ (Apta para mayores de 14 años)
- 18+ (Programación para adultos)
- Desbloqueado (Permitidos todos los programas)

CONTROL PATERNO / CLASIFICACIONES

Clasif. - Francés - Sólo para CANADÁ

Selección del sistema de clasificación de francés canadiense.

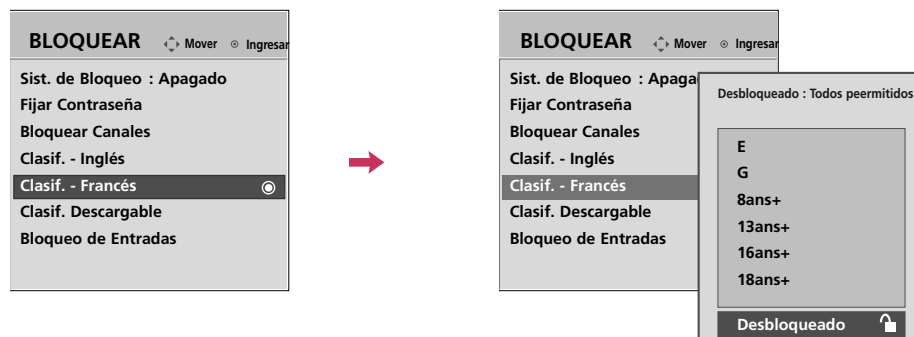



1    Seleccione **BLOQUEAR**.

2  Meter la contraseña.

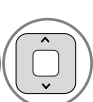
3  Seleccione **Clasif.- Francés**.

4   Seleccione **E, G, 8ans+, 13ans+, 16ans+, 18ans+, o Desbloqueado**.

5  Regresar al menú anterior.

 Regresar a la pantalla del televisor.

- E (Exento)
- G (General)
- 8ans+ (General-no apto para niños pequeños)
- 13ans+ (No apto para niños menores de 13 años)
- 16ans+ (No apto para niños menores de 16 años)
- 18ans+ (Este programa es exclusivamente para adultos)
- Desbloqueado (Permitidos todos los programas)

CLASIFICACIÓN DESCARGABLE

Esta función está disponible solamente para la señal de los canales digitales.

Esta función funciona solamente cuando la TV ha recibido datos del grado Region 5.

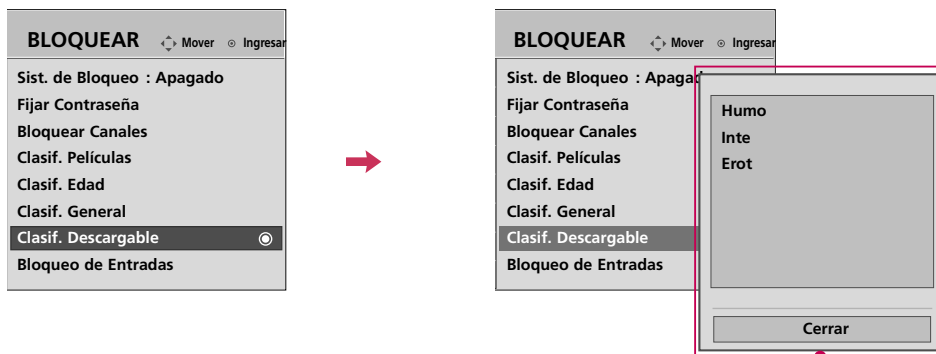

- De acuerdo con la tabla del grado, OSD (Desplegado en la pantalla) de su TV puede diferenciar levemente de lo que se muestra en este manual.





-    Seleccione **BLOQUEAR**.
-  Meter la contraseña.
-  Seleccione **Clasif. Descargable**.
-   Seleccione la opción de frecuencia de descarga deseada.
-   Seleccione la opción deseada y bloquéela.
-  Regresar al menú anterior.
-  Regresar a la pantalla del televisor.

CONTROL PATERNO / CLASIFICACIONES

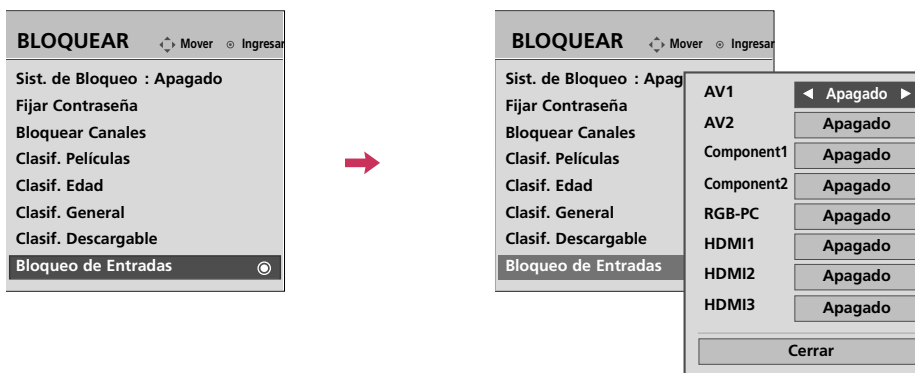
BLOQUEO DE ENTRADA EXTERNA

Le permite bloquear una entrada.



-    Seleccione **BLOQUEAR**.
-  Meter la contraseña.
-  Seleccione **Bloqueo de Entradas**.
-   Seleccione una fuente.
-  Seleccione **Apagado** o **Encendido**.
-  Regresar al menú anterior.
-  Regresar a la pantalla del televisor.





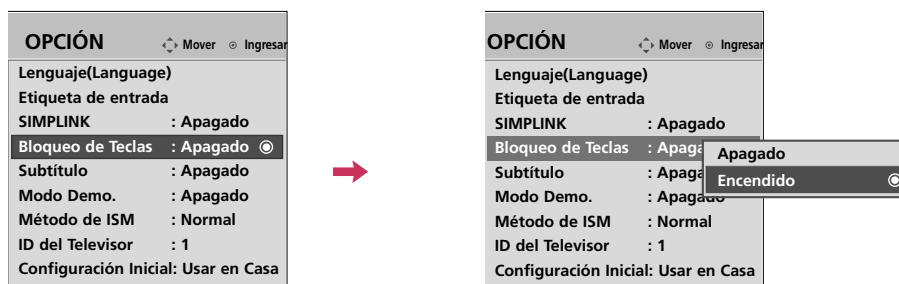

BLOQUEO DE TECLAS

El televisor se puede configurar de modo tal que se pueda usar sólo con el control remoto.

El objetivo de esta función es evitar que sea utilizado por personas no autorizadas, bloqueando los controles del panel frontal.

Este televisor está programado para recordar la última opción definida, incluso si apaga el televisor.



-   Seleccione **OPCIÓN**.
-   Seleccione **Bloqueo de Teclas**.
-   Seleccione **Apagado** o **Encendido**.
-  Regresar al menú anterior.
-  Regresar a la pantalla del televisor.

- En **Bloqueado Encendido**, si la unidad está apagada, presione el botón **INPUT, CH ▲, ▼** de la unidad o los botones de **POWER, INPUT, CH ^, v** o números del control remoto.
- Con **Bloqueado Encendido**, se aparecerá '▲ **Bloqueo de Teclas**' en la pantalla si cualquier botón (Excepto botón de ϕ /I (prendido)) del panel frontal ha presionado cuando mira la unidad.

APÉNDICE

LISTA DE VERIFICACIÓN DE PROBLEMAS

No se trabaja normalmente.	
El control remoto no funciona	<ul style="list-style-type: none"> ■ Verifique para ver si hay algún objeto entre el producto y el control remoto causando la obstrucción. Asegúrese de apuntar el control remoto directamente al televisor. ■ Están puestas las baterías con la polaridad correcta (+ con + y - con -)? ■ Está correcta la configuración del modo remoto de la operación: TV, VCR etc.? ■ Ponga nuevas baterías. * Esta característica no se encuentra disponible para todos los modelos.
De repente la TV se apaga	<ul style="list-style-type: none"> ■ Está configurado el tiempo para dormir? ■ Verifique las configuraciones de control de la potencia. La potencia interrumpida. ■ El Televisor se apagará automáticamente en 15 minutos en caso de que no haya señal.

El video no funciona	
No imagen No sonido	<ul style="list-style-type: none"> ■ Verifique si el producto está encendido. ■ Intente otro canal. El problema puede ser con la transmisión. ■ Está metido el cordón de alimentación dentro del tomacorriente de la pared? ■ Verifique la dirección y/o la ubicación de su antena. ■ Pruebe el tomacorriente, enchufe un cordón de alimentación de otro producto en el tomacorriente donde estaba enchufado el cordón de alimentación del producto.
La imagen aparece lentamente después de encender la TV	<ul style="list-style-type: none"> ■ Es normal, la imagen es muda durante el proceso de inicio del producto. Favor de contactar a su centro de servicio, si la imagen no aparece cinco minutos después.
Color o imagen deficiente, o No color	<ul style="list-style-type: none"> ■ Ajuste Color en la opción del menú. ■ Mantenga una distancia suficiente entre el producto y el VCR. ■ Intente otro canal. El problema puede ser con la transmisión. ■ Están instalados apropiadamente los cables de video? ■ Active cualquier función para restablecer el brillo de la imagen.
Bar horizontal/vertical o imagen temblante	<ul style="list-style-type: none"> ■ Verifique la interferencia local como aparatos eléctricos o herramientas de potencia.
Recepción pobre en algunos canales	<ul style="list-style-type: none"> ■ Estación o cable con problemas experimentales, sintonice a otra estación. ■ Si la señal de estación es débil, reubique la antena para recibir estación más debil. ■ Verifique las fuentes de la interferencia posible.
Lineas o rayas en las imagenes	<ul style="list-style-type: none"> ■ Verifique la antena (Cambie la dirección de la antena).
No hay recepción de imagen al conectar la toma HDMI	<ul style="list-style-type: none"> ■ Verifique que el cable HDMI admita la versión 1.3. Los cables HDMI que no admiten la versión 1.3 de HDMI, provocan parpadeos o no muestran la imagen en pantalla. Si este es el caso, utilice cables recientes que soporten la versión 1.3 de HDMI.

El audio no funciona

Imagen OK pero No sonido	<ul style="list-style-type: none">■ Presione el botón VOL +/- (o Volume).■ Sonido mudo? Presione el botón MUTE.■ Intente otro canal. El problema puede ser con la transmisión.■ Están instalados apropiadamente los cables de audio?
No salida de una de las bocinas	<ul style="list-style-type: none">■ Ajuste el Balance en la opción del menú.
Sonido raro desde interior del producto	<ul style="list-style-type: none">■ Un cambio en la ambiente de humedad o temperatura puede causar un sonido raro cuando enciende o apaga el producto y esto no significa la falla del producto.
No hay sonido al conectar tomas HDMI/USB	<ul style="list-style-type: none">■ Verifique que el cable HDMI admite la versión 1.3.■ Verifique que el cable USB admite la versión 2,0.■ Lea archivos MP3 normales.

* Esta característica no se encuentra disponible para todos los modelos.

Hay un problema en el modo PC. (Sólo se aplica en el modo PC)

La señal está fuera del rango (Formato no válido)	<ul style="list-style-type: none">■ Ajuste la resolución, la frecuencia horizontal o vertical.■ Verifique la fuente de la entrada.
Barra o raya vertical en el fondo, Ruido horizontal y posición incorrecta	<ul style="list-style-type: none">■ Ponga a trabajar auto-configuración o ajuste el reloj, la fase o la posición H/V. (opción)
El color de pantalla es inestable o color único	<ul style="list-style-type: none">■ Verifique el cable de señal.■ Reinstale la tarjeta de video de la PC.

MANTENIMIENTO

Las malfunciones anticipadas pueden ser prevenidas. La limpieza regular y cuidadosa puede extender la suma de tiempo que ud. va a tener su nueva TV. Asegurese apagar la TV y desenchufar el cordón de alimentación antes de empezar cualquier tipo de limpieza.

Limpiando la pantalla

- 1 Aquí hay una buena manera para mantener su pantalla limpia por un tiempo. Moje una tela suave en una mezcla de agua tibia con un poco de suavizante de ropa, o detergente de platos. Escurra la tela hasta que esté casi seca, luego limpie la pantalla con ella.
- 2 Asegurese que no haya exceso de agua por la pantalla, luego dejela secar por el aire antes de encender su TV.

Limpiando el gabinete

- Para remover la suciedad o polvo, limpie el gabinete con una tela suave, seca y sin pelusa.
- Favor de asegurarse no usar una tela mojada.

Ausencia Extendida

PRECAUCIÓN

- ▶ Si ud. espera dejar su TV por un tiempo largo (como las vacaciones), será buena idea desenchufar el cordón de alimentación para proteger la TV contra el daño posible por alguna descarga electrica.

ESPECIFICACIONES DEL PRODUCTO

MODELOS		50PK550, 50PK550C (50PK550-UD, 50PK550C-UD) (50PK550-UE)	60PK550, 60PK550C (60PK550-UD, 60PK550C-UD)
Dimensiones (Ancho x Altura x Profundidad)	incluyendo la base	1171.4 mm x 786.2 mm x 309.7 mm (46.1 pulgadas x 30.9 pulgadas x 12.1 pulgadas)	1392 mm x 915 mm x 367 mm (54.8 pulgadas x 36 pulgadas x 14.4 pulgadas)
	excluyendo la base	1171.4 mm x 724.4 mm x 55.3 mm (46.1 pulgadas x 28.5 pulgadas x 2.1 pulgadas)	1392 mm x 852 mm x 55.3 mm (54.8 pulgadas x 33.5 pulgadas x 2.1 pulgadas)
Peso	incluyendo la base	31 kg (68.3 libras)	49.5 kg (109.1 libras)
	excluyendo la base	28.6 kg (63.0 libras)	45 kg (99.2 libras)
MODELOS		42PJ350, 42PJ350C (42PJ350-UB, 42PJ350C-UB)	50PJ350, 50PJ350C (50PJ350-UB, 50PJ350C-UB)
Dimensiones (Ancho x Altura x Profundidad)	incluyendo la base	988 mm x 688.5 mm x 260 mm (38.8 pulgadas x 27.1 pulgadas x 10.2 pulgadas)	1171.4 mm x 781.8 mm x 309.7 mm (46.1 pulgadas x 30.7 pulgadas x 12.1 pulgadas)
	excluyendo la base	988 mm x 617.8 mm x 55.3 mm (38.8 pulgadas x 24.3 pulgadas x 2.1 pulgadas)	1171.4 mm x 720.9 mm x 55.3 mm (46.1 pulgadas x 28.3 pulgadas x 2.1 pulgadas)
Peso	incluyendo la base	21.6 kg (47.6 libras)	30 kg (66.1 libras)
	excluyendo la base	20 kg (44 libras)	27.6 kg (60.8 libras)
MODELOS		42PJ340 (42PJ340-UB)	50PJ340 (50PJ340-UB, 50PJ340-UC, 50PJ340-UH)
Dimensiones (Ancho x Altura x Profundidad)	incluyendo la base	988 mm x 688.5 mm x 260 mm (38.8 pulgadas x 27.1 pulgadas x 10.2 pulgadas)	1171.4 mm x 781.8 mm x 309.7 mm (46.1 pulgadas x 30.7 pulgadas x 12.1 pulgadas)
	excluyendo la base	988 mm x 617.8 mm x 55.3 mm (38.8 pulgadas x 24.3 pulgadas x 2.1 pulgadas)	1171.4 mm x 720.9 mm x 55.3 mm (46.1 pulgadas x 28.3 pulgadas x 2.1 pulgadas)
Peso	incluyendo la base	21.6 kg (47.6 libras)	30 kg (66.1 libras)
	excluyendo la base	20 kg (44 libras)	27.6 kg (60.8 libras)
MODELOS		50PK540 (50PK540-UE)	60PK540 (60PK540-UE)
Dimensiones (Ancho x Altura x Profundidad)	incluyendo la base	1171.4 mm x 786.2 mm x 309.7 mm (46.1 pulgadas x 30.9 pulgadas x 12.1 pulgadas)	1392 mm x 915 mm x 367 mm (54.8 pulgadas x 36 pulgadas x 14.4 pulgadas)
	excluyendo la base	1171.4 mm x 724.4 mm x 55.3 mm (46.1 pulgadas x 28.5 pulgadas x 2.1 pulgadas)	1392 mm x 852 mm x 55.3 mm (54.8 pulgadas x 33.5 pulgadas x 2.1 pulgadas)
Peso	incluyendo la base	31 kg (68.3 libras)	49.5 kg (109.1 libras)
	excluyendo la base	28.6 kg (63.0 libras)	45 kg (99.2 libras)
Potencia requerida Sistema de la TV Cobertura de programas Impedancia de Antena Externa		AC 100-240 V ~ 50 / 60 Hz NTSC-M, ATSC, 64 & 256 QAM VHF 2-13, UHF 14-69, CATV 1-135, DTV 2-69, CADTV 1-135 75 ohm	
Condición de ambiente	Temp.de operación Humedad de operación	32 ~ 104°F (0 ~ 40 °C) Menos de 80%	
	Temp.para almacenar Humedad para almacenar	-4 ~ 140°F (-20 ~ 60 °C) Menos de 85%	

APÉNDICE

MODELOS		42PJ550 (42PJ550-UD)	50PJ550 (50PJ550-UD)
Dimensiones (Ancho x Altura x Profundidad)	incluyendo la base	988 mm x 692.7 mm x 260 mm (38.8 pulgadas x 27.2 pulgadas x 10.2 pulgadas)	1171.4 mm x 786.2 mm x 309.7 mm (46.1 pulgadas x 30.9 pulgadas x 12.1 pulgadas)
	excluyendo la base	988 mm x 621.8 mm x 55.3 mm (38.8 pulgadas x 24.4 pulgadas x 2.1 pulgadas)	1171.4 mm x 724.4 mm x 55.3 mm (46.1 pulgadas x 28.5 pulgadas x 2.1 pulgadas)
Peso	incluyendo la base	21.6 kg (47.6 libras)	30 kg (66.1 libras)
	excluyendo la base	20 kg (44.0 libras)	27.6 kg (60.8 libras)
MODELOS		60PK290 (60PK290-UA)	50PK340 (50PK340-UB)
Dimensiones (Ancho x Altura x Profundidad)	incluyendo la base	1392 mm x 910 mm x 367 mm (40.9 pulgadas x 28.5 pulgadas x 12.1 pulgadas)	1171.4 mm x 781.8 mm x 309.7 mm (46.1 pulgadas x 30.7 pulgadas x 12.1 pulgadas)
	excluyendo la base	1392 mm x 843 mm x 55.3 mm (40.9 pulgadas x 26.3 pulgadas x 3.0 pulgadas)	1171.4 mm x 720.9 mm x 55.3 mm (46.1 pulgadas x 28.3 pulgadas x 2.1 pulgadas)
Peso	incluyendo la base	49.5 kg (109.1 libras)	31 kg (68.3 libras)
	excluyendo la base	45 kg (99.2 libras)	28.6 kg (63.0 libras)
MODELOS		42PJ250 (42PJ250-UA) (42PJ250-UB)	50PJ250 (50PJ250-UA)
Dimensiones (Ancho x Altura x Profundidad)	incluyendo la base	988 mm x 688.5 mm x 260 mm (38.8 pulgadas x 27.1 pulgadas x 10.2 pulgadas)	1171.4 mm x 781.8 mm x 309.7 mm (46.1 pulgadas x 30.7 pulgadas x 12.1 pulgadas)
	excluyendo la base	988 mm x 617.8 mm x 55.3 mm (38.8 pulgadas x 24.3 pulgadas x 2.1 pulgadas)	1171.4 mm x 720.9 mm x 55.3 mm (46.1 pulgadas x 28.3 pulgadas x 2.1 pulgadas)
Peso	incluyendo la base	21.6 kg (47.6 libras)	30 kg (66.1 libras)
	excluyendo la base	20 kg (44.0 libras)	27.6 kg (60.8 libras)
Potencia requerida Sistema de la TV Cobertura de programas Impedancia de Antena Externa		AC 100-240 V ~ 50 / 60 Hz NTSC-M, ATSC, 64 & 256 QAM VHF 2-13, UHF 14-69, CATV 1-135, DTV 2-69, CADTV 1-135 75 ohm	
Condición de ambiente	Temp.de operación Humedad de operación	32 ~ 104°F (0 ~ 40 °C) Menos de 80%	
	Temp.para almacenar Humedad para almacenar	-4 ~ 140°F (-20 ~ 60 °C) Menos de 85%	

MODELOS		50PK350 (50PK350-UC)	60PK280 (60PK280-UA)
Dimensiones (Ancho x Altura x Profundidad)	incluyendo la base	1171.4 mm x 781.8 mm x 309.7 mm (46.1 pulgadas x 30.7 pulgadas x 12.1 pulgadas)	1392 mm x 910 mm x 367 mm (40.9 pulgadas x 28.5 pulgadas x 12.1 pulgadas)
	excluyendo la base	1171.4 mm x 720.9 mm x 55.3 mm (46.1 pulgadas x 28.3 pulgadas x 2.1 pulgadas)	1392 mm x 843 mm x 55.3 mm (40.9 pulgadas x 26.3 pulgadas x 3.0 pulgadas)
Peso	incluyendo la base	31 kg (68.3 libras)	49.5 kg (109.1 libras)
	excluyendo la base	28.6 kg (63.0 libras)	45 kg (99.2 libras)
MODELOS		50PK250 (50PK250-UA) (50PK250-UB)	60PK250 (60PK250-UA) (60PK250-UB)
Dimensiones (Ancho x Altura x Profundidad)	incluyendo la base	1171.4 mm x 781.8 mm x 309.7 mm (46.1 pulgadas x 30.7 pulgadas x 12.1 pulgadas)	1392 mm x 910 mm x 367 mm (40.9 pulgadas x 28.5 pulgadas x 12.1 pulgadas)
	excluyendo la base	1171.4 mm x 720.9 mm x 55.3 mm (46.1 pulgadas x 28.3 pulgadas x 2.1 pulgadas)	1392 mm x 843 mm x 55.3 mm (40.9 pulgadas x 26.3 pulgadas x 3.0 pulgadas)
Peso	incluyendo la base	31 kg (68.3 libras)	49.5 kg (109.1 libras)
	excluyendo la base	28.6 kg (63.0 libras)	45 kg (99.2 libras)
Potencia requerida Sistema de la TV Cobertura de programas Impedancia de Antena Externa		AC 100-240 V ~ 50 / 60 Hz NTSC-M, ATSC, 64 & 256 QAM VHF 2-13, UHF 14-69, CATV 1-135, DTV 2-69, CADTV 1-135 75 ohm	
Condición de ambiente	Temp.de operación Humedad de operación	32 ~ 104°F (0 ~ 40 °C) Menos de 80%	
	Temp.para almacenar Humedad para almacenar	-4 ~ 140°F (-20 ~ 60 °C) Menos de 85%	

- Las especificaciones mostradas arriba se pueden cambiar sin previo aviso para la mejora de calidad.

APÉNDICE

CÓDIGOS DE IR

(Esta característica no se encuentra disponible para todos los modelos.)

1. Cómo conectar

- Conecte su control remoto de cable al puerto de control remoto en la TV.

2. Códigos de IR de Control Remoto

■ Salida de la forma de onda

Pulso simple, modulado con la señal de 37,917 kHz en 455 kHz

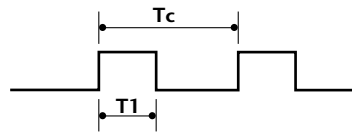

Frecuencia de transportador
 $FCAR = 1/T_C = f_{OSC}/12$
 Proporción debida = $T_1/T_C = 1/3$

■ Configuración de cuadro

1 r cuadro

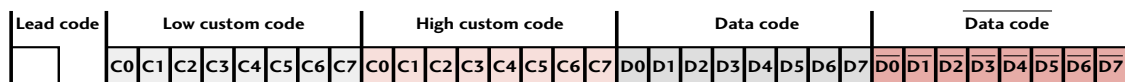

Cuadro repetido

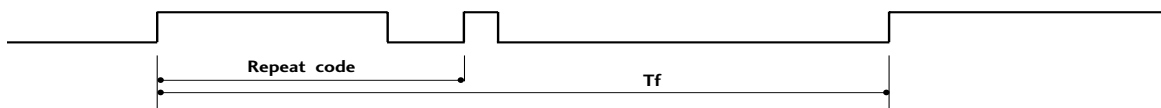

■ Código de líder

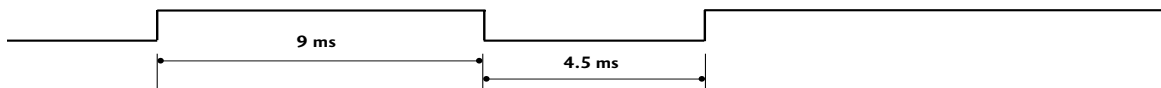

■ Código de repetición

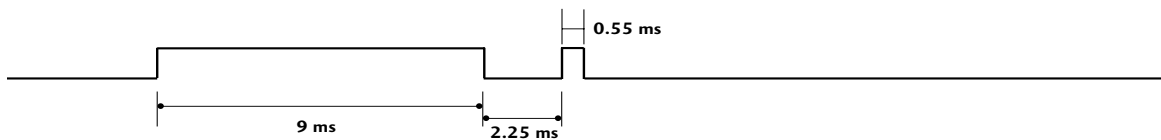

■ Descripción de bits



■ Intervalo de cuadros: Tf

La forma de onda es transmitida mientras una tecla está presionado.

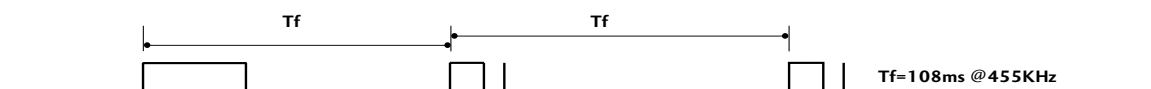

Código (Hexa)	Función	Nota	Código (Hexa)	Función	Nota
08	POWER	RBotón control Remoto (Encendido/apagado)	D6	TV	Código discreto IR (TV de entrada)
45	Q.MENU	Botón control Remoto	C4	POWER encendido	Código discreto IR (Sólo encendido)
43	MENU	Botón control Remoto			
0B	INPUT	Botón control Remoto			
10-19	Teclas de números 0-9	Botón control Remoto	C5	POWER apagado	Código discreto IR (Sólo apagado)
4C	- Guión(List)	Botón control Remoto			
1A	FLASHBK	Botón control Remoto	5A	AV1	Código discreto IR (AV1 de entrada)
09	MUTE	Botón control Remoto			
02	VOL +	Botón control Remoto			
03	VOL -	Botón control Remoto	D0	AV2	Código discreto IR (AV2 de entrada)
00	CH ^	Botón control Remoto			
01	CH v	Botón control Remoto	BF	COMPONENT1	Código discreto IR (Componente1 de entrada)
1E	FAV	Botón control Remoto			
40	^	Botón control Remoto			
41	v	Botón control Remoto	D5	RGB-PC	Código discreto IR (RGB-PC de entrada)
07	<	Botón control Remoto			
06	>	Botón control Remoto	CE	HDMI1	Código discreto IR (HDMI1 de entrada)
44	ENTER	Botón control Remoto			
28	BACK	Botón control Remoto			
7E	SIMPLINK	Botón control Remoto	CC	HDMI2	Código discreto IR (HDMI2 de entrada)
30	AV MODE	Botón control Remoto			
79	RATIO	Botón control Remoto	E9	HDMI3	Código discreto IR (HDMI3 de entrada)
BA	Pause (FREEZE)	Botón control Remoto			
95	ENERGY	Botón control Remoto	76	Ratio 4:3	Código discreto IR (Sólo modo 4:3)
AA	Info	Botón control Remoto			
72	Red	Botón control Remoto	77	Ratio 16:9	Código discreto IR (Sólo modo 16:9)
71	Green	Botón control Remoto			
63	Yellow	Botón control Remoto	AF	Ratio Zoom	Código discreto IR (Sólo modo Zoom1)
61	Blue	Botón control Remoto			
8E	FF ►►	Botón control Remoto			
8F	Rew ◀◀	Botón control Remoto			
0F	TV	Botón control Remoto			
5B	EXIT	Botón control Remoto			
B1	Stop ■	Botón control Remoto			
B0	Play ►	Botón control Remoto			

CONFIGURACIÓN DE DISPOSITIVO EXTERNO DEL CONTROL

El puerto RS-232 permite conectar el conector de entrada RS-232C a un dispositivo de control externo (como una computadora o un sistema de control de A/V) para controlar en forma externa las funciones del televisor.

- Nota: El RS-232 de esta unidad está diseñado para ser utilizado con hardware y software de control de RS-232 de terceros.

Las instrucciones que aparecen a continuación se entregan para servir de ayuda con el software de programación o para probar la funcionalidad del uso de software telenet.

Instalación de RS-232C

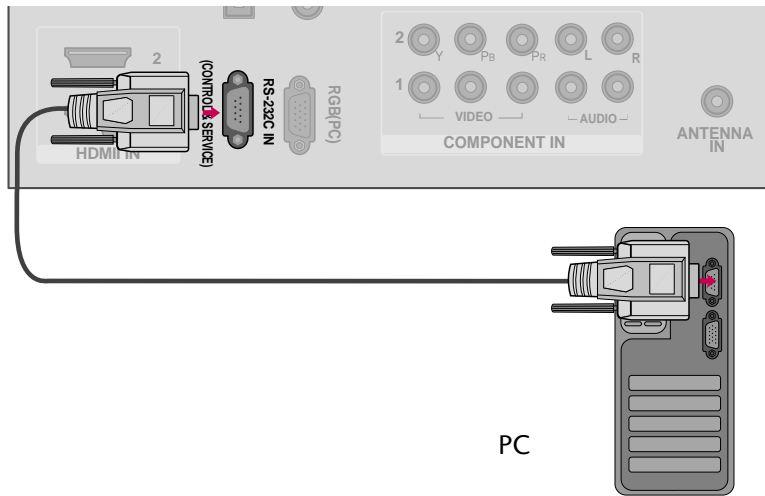

Tipo del Conector; Macho D-Sub 9-Pines

No.	Nombre de Pin
1	No conexión
2	RXD (Recepción de datos)
3	TXD (Transmisión de datos)
4	DTR (Lado DTE listo)
5	GND
6	DSR (Lado DCE listo)
7	RTS (Listo para enviar)
8	CTS (Aprobado para enviar)
9	No Conexión

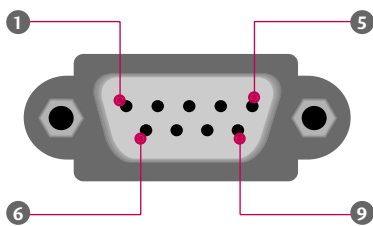

Comunicación de los Parámetros

- Velocidad de banda : 9 600 b/s (UART)
- Longitud de datos : 8 bits
- Paridad : No se aplica
- Bit de detención : 1 bit
- Código de comunicación : Código ASCII
- Use un cable cruzado (reverso).

Configuraciones de RS-232C

Se puede utilizar cualquiera de los cables a continuación.

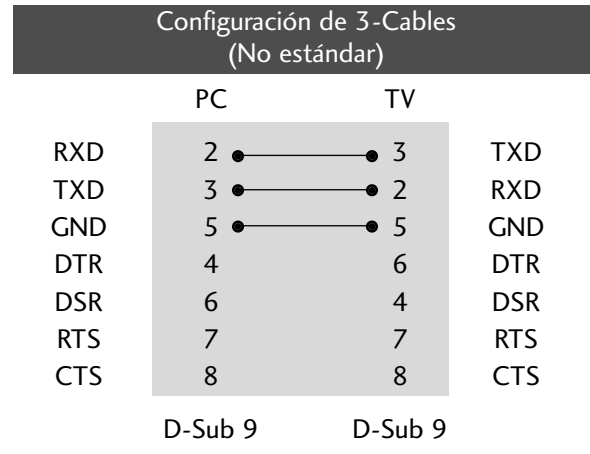
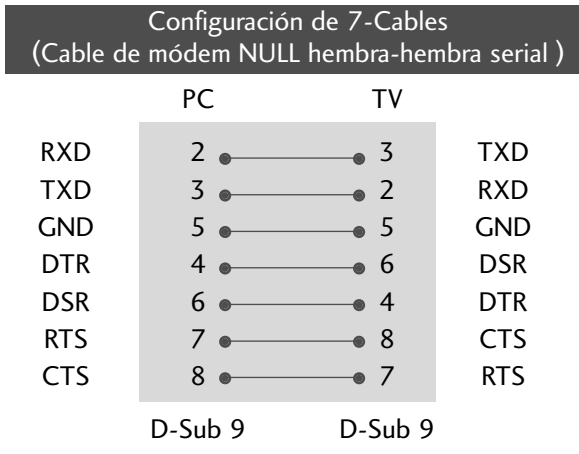

Configuración de ID

Use esta función para especificar un número de ID de la unidad.

Refiérase a “Mapeo de datos reales”.

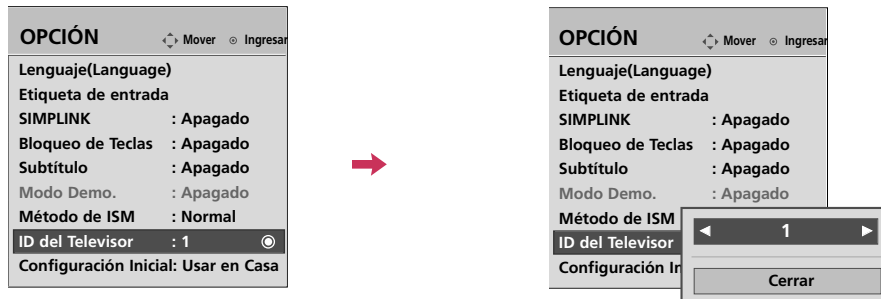

- 1 Seleccione **OPCIÓN**.
- 2 Seleccione **ID del Televisor**.
- 3 Seleccione el número deseado de ID del monitor. Rango de ajuste de **ID del Televisor 1 - 99**.
- 4 Regresar al menú anterior.
- Regresar a la pantalla del televisor.

*Mapeo de datos reales

0: Paso 0
:
A: Paso 10 (ID del Televisor 10)
:
F: Paso 15 (ID del Televisor 15)
10: Paso 16 (ID del Televisor 16)
:
63: Paso 99 (ID del Televisor 99)
64: Paso 100

Lista de Referencia de los Comandos

	COMANDO 1	COMANDO 2	DATO (Hexadecimal)		COMANDO 1	COMANDO 2	DATO (Hexadecimal)
01. Alimentación	k	a	00 - 01	13. Modo bloqueado de control remoto	k	m	00 ~ 01
02. Selección de Entrada	x	b	(▶ p.117)	14. Agudos	k	r	00 - 64
03. Relación de Aspecto	k	c	(▶ p.117)	15. Bajos	k	s	00 - 64
04. Modo Pantalla	k	d	00 - 01	16. Balance	k	t	00 - 64
05. Silenciador de volumen	k	e	00 - 01	17. Temperatura de color	x	u	00 ~ 64
06. Control de volumen	k	f	00 - 64	18. Método de ISM	j	p	(▶ p.118)
07. Contraste	k	g	00 - 64	19. Ahorro de Energía	j	q	00 - 01
08. Brillo	k	h	00 - 64	20. Auto Configuración	j	u	(▶ p.118)
09. Color	k	i	00 - 64	22. Agr./Eli. de canal	m	b	00 - 01
10. Tinte	k	j	00 - 64	23. Botones	m	c	(▶ p.119)
11. Nitidez	k	k	00 - 64				
12. Selección de OSD	k	l	00 - 01				

	COMANDO 1	COMANDO 2	DATO 00 (Hexadecimal)	DATO 01 (Hexadecimal)	DATO 02 (Hexadecimal)	DATO 03 (Hexadecimal)	DATO 04 (Hexadecimal)	DATO 05 (Hexadecimal)
21. Sintonización de canales	m	a	Programa físicoalto	Programa mayor bajo	mayor bajo	menor alto	menor bajo	atributo

Protocolo de Transmisión /Recepción

Transmisión

[Comando1][Comando2][][ID del Televisor][][Dato][Cr]

[Comando 1] : Primer comando para controlar la TV.(j,k,m o x)

[Comando 2] : Segundo comando para controlar la TV.

[ID del Televisor]: Ud. puede ajustar la ID de unidad para seleccionar el número deseado de ID de la TV en el menú Especial. Rango de ajuste es de 1 a 99. Cuando seleccione la ID de unidad '0', cada TV conectada será controlada. ID de unidad está indicado en decimal (1 - 99) en el menú en Hexadecimal (0x0 - 0x63) en la transmisión/recibiendo el protocolo.

[DATO] : Para transmitir los datos de comando.

Transmite el dato 'FF' a leer estados de comando

[Cr] : Retorno

Código ASCII como '0x0D'

[] : Código ASCII como 'espacio (0x20)'

* En este modelo, el televisor no enviará el estado durante el modo apagado.

Reconocimiento de OK

[Comando2][][Set ID][][OK][Data][x]

La TV transmite ACK (reconocimiento) basando en este formato cuando recibe un dato normal. En este momento, si el dato está en el modo de leer, esto indica el estado de dato

actual. Si el dato está en el modo de escribir, esto regresa los datos de la computadora.

* En este modelo, el televisor no enviará el estado durante el modo apagado.

* Formato de datos

[Comando 2] : Use como comando.

[ID del Televisor] : Use el carácter pequeño, si la ID definida es 10, enviará '0'; 'a'

[DATO] : Use el carácter pequeño, si los datos son 0 x ab, enviará 'a', 'b'.

[OK] : Use el carácter grande

Reconocimiento de NG

[Comando2][][ID del Televisor][][NG][Dato][x]

La TV transmite ACK (reconocimiento) basando en este formato cuando recibe un dato anormal de funciones no-viable o errores de comunicación.

Dato1: Código ilegal.

Dato2: Función no soportada.

Dato3: Esperar más tiempo.

* En este modelo, el televisor no enviará el estado durante el modo apagado.

* Formato de datos

[Comando 2] : Use como comando.

[ID del Televisor] : Use el carácter pequeño, si la ID definida es 10, enviará '0'; 'a'

[DATO] : Use el carácter pequeño, si los datos son 0xab, enviará 'a', 'b'.

[NG] : Use el carácter grande

01. Alimentación (Comando: k a)

Para controlar la potencia Encendida/Apagada de la TV.

Transmisión [k][a][][ID del Televisor][][Data][Cr]

Dato 00 : Apagado Dato 01 : Encendido

Reconocimiento [a][][ID del Televisor][][OK/NG][Dato][x]

* Si otras funciones transmiten datos 'FF' basados en este formato, el reconocimiento de retroalimentación de datos, presenta un estado acerca de cada función.

* En este modelo, el televisor enviará la Información después de la finalización del procesamiento de encendido.

Es posible que exista un retraso entre el comando y la información.

02. Selección de entrada (Comando: x b)

Para seleccionar la fuente de entrada para la TV.

Transmisión [x][b][][ID del Televisor][][Dato][Cr]

Dato 00: DTV (Antena) Dato 01: DTV (Cable)

Dato 10: Análogo (Antena) Dato 11: Análogo (Cable)

Data 20: AV1 Data 21: AV2

Data 40: Componente 1 Data 41: Componente 2

Data 60: RGB-PC Data 90: HDMI1

Data 91: HDMI2 Data 92: HDMI3

Reconocimiento [b][][ID del Televisor][][OK/NG][Dato][x]

03. Relación de Aspecto (Comando: k c)

Para ajustar el formato de la pantalla.

Transmisión [k][c][][ID del Televisor][][Dato][Cr]

Dato 01: 4:3 09: Sólo búsqueda

02: 16:9 10: Cine Zoom (1)

04: Zoom ⋮

06: Por Programa 1f: Cine Zoom (16)

Reconocimiento [c][][ID del Televisor][][OK/NG][Dato][x]

04. Modo Pantalla (Comando: k d)

Para seleccionar modo de pantalla encendido/apagado.

Transmisión [k][d][][ID del Televisor][][Dato][Cr]

Dato 00: Modo apagado de pantalla (Imagen encendida),
Silencio de la salida de video off (desc.)

Dato 01: Modo encendido de pantalla (Imagen apagada)

Dato 10: Silencio de la salida de video on (act.)

Reconocimiento [d][][ID del Televisor][][OK/NG][Dato][x]

* Sólo en el caso de que la función Silencio de la salida de video esté activada, el televisor mostrará la visualización en pantalla (OSD) Pero en el caso de que la función Silencio de la salida de video esté desactivada, el televisor no mostrará la visualización en pantalla (OSD).

05. Silenciador de volumen (Comando: k e)

Para controlar el encendido/apagado del silenciador de volumen, También puede ajustar el silenciador utilizando el botón MUTE en el control remoto.

Transmisión [k][e][][ID del Televisor][][Dato][Cr]

Dato 00: Encendido del silenciador de volumen (Sin volumen)

Dato 01: Apagado del silenciador de volumen (Con volumen)

Reconocimiento [e][][ID del Televisor][][OK/NG][Dato][x]

06. Control de volumen (Comando: k f)

Para ajustar el volumen.

También puede ajustar el volumen con los botones de volumen en el control remoto.

Transmisión [k][f][][ID del Televisor][][Dato][Cr]

Dato Min: 00 - Max: 64 (*transmitir por código hexadecimal)

Véase 'Mapeo de datos reales' ► p.116.

Reconocimiento [f][][ID del Televisor][][OK/NG][Dato][x]

07. Contraste (Comando: k g)

Para ajustar el contraste de la pantalla.

También puede ajustar el contraste en el menú Imagen.

Transmisión [k][g][][ID del Televisor][][Dato][Cr]

Dato Min: 00 - Max: 64 (*transmitir por código hexadecimal)

Véase 'Mapeo de datos reales' ► p.116.

Reconocimiento [g][][ID del Televisor][][OK/NG][Dato][x]

08. Brillo (Comando: k h)

Para ajustar el brillo de la pantalla.

También puede ajustar el brillo en el menú Imagen.

Transmisión [k][h][][ID del Televisor][][Dato][Cr]

Dato Min: 00 - Max: 64 (*transmitir por código hexadecimal)

Véase 'Mapeo de datos reales' ► p.116.

Reconocimiento [h][][ID del Televisor][][OK/NG][Dato][x]

09. Color (Comando: k i)

Para ajustar el color de pantalla.

También puede ajustar el brillo en el menú Imagen.

Transmisión [k][i][][ID del Televisor][][Dato][Cr]

Dato Min: 00 - Max: 64 (*transmitir por código hexadecimal)

Véase 'Mapeo de datos reales' ► p.116.

Reconocimiento [i][][ID del Televisor][][OK/NG][Dato][x]

10. Tinte (Comando: k j)

Para ajustar el tinte de la pantalla.

Ud. puede ajustar el tinte en el menú Imagen.

Transmisión [k][j][][ID del Televisor][][Dato][Cr]

Dato Rojo : 00 - Verde : 64 (*transmitir por código hexadecimal)

Véase 'Mapeo de datos reales' ► p.116.

Reconocimiento [j][][ID del Televisor][][OK/NG][Dato][x]

11. Nitidez (Comando: k k)

Para ajustar la nitidez de la pantalla.

También puede ajustar la nitidez en el menú Imagen.

Transmisión [k][k][][ID del Televisor][][Dato][Cr]

Dato Min: 00 - Max: 64 (*transmitir por código hexadecimal)

Véase 'Mapeo de datos reales' ► p.116.

Reconocimiento [k][][ID del Televisor][][OK/NG][Dato][x]

12. Selección de OSD (Comando: k l)

Para seleccionar OSD (On Screen Display) encendido/apagado.

Transmisión [k][l][][ID del Televisor][][Dato][Cr]

Dato 00: Apagado de OSD Dato 01: Encendido de OSD

Reconocimiento [l][][ID del Televisor][][OK/NG][Dato][x]

13. Modo de bloqueo de control remoto (Comando: k m)

Para bloquear los mandos del panel frontal en el monitor y en el mando a distancia.

Transmisión [k][m][][ID del Televisor][][Dato][Cr]

Dato 00: Bloquear Apagado, 01: Bloquear Encendido

Reconocimiento [m][][ID del Televisor][][OK/NG][Dato][x]

Si ud. no está usando el control remoto y tampoco los controles del panel frontal en la unidad, use este modo. Cuando la potencia principal enciende y apaga, el bloqueo de control remoto será liberado.

14. Agudos (Comando: k r)

Para ajustar los agudos.

También puede ajustar los agudos en el menú audio.

Transmisión [k][r][][ID del Televisor][][Dato][Cr]

Dato Min: 00 - Max: 64 (*transmitir por código hexadecimal)

Véase 'Mapeo de datos reales' ► p.116.

Reconocimiento [r][][ID del Televisor][][OK/NG][Dato][x]

15. Bajos (Comando: k s)

Para ajustar los bajos.

También puede ajustar los graves en el menú audio.

Transmisión [k][s][][ID del Televisor][][Dato][Cr]

Dato Min: 00 - Max: 64 (*transmitir por código hexadecimal)

Véase 'Mapeo de datos reales' ► p.116.

Reconocimiento [s][][ID del Televisor][][OK/NG][Dato][x]

16. Balance (Comando: k t)

Para ajustar el balance.

También puede ajustarse el balance en el menú audio.

Transmisión [k][t][][ID del Televisor][][Dato][Cr]

Dato Min: 00 - Max: 64 (*transmitir por código hexadecimal)

Véase 'Mapeo de datos reales' ► p.116.

Reconocimiento [t][][ID del Televisor][][OK/NG][Dato][x]

17. Temperatura de color (Comando: x u)

Para ajustar la temperatura de color.

También puede ajustar la temperatura de color en el Menú Imagen.

Transmisión [x][u][][ID del Televisor][][Dato][Cr]

Dato Min: 00 - Max: 64 (*transmitir por código hexadecimal)

Véase 'Mapeo de datos reales' ► p.116.

Reconocimiento [u][][ID del Televisor][][OK/NG][Dato][x]

18. Método de ISM (Comando: j p)

Para evitar tener una imagen fija permanente en pantalla.

Transmisión [j][p][][ID del Televisor][][Dato][Cr]

Dato 02: Orbiter

04: Blanquear

08: Normal

20: Lavado de Color

Reconocimiento [p][][ID del Televisor][][OK/NG][Dato][x]

19. Ahorro de Energía (Comando: j q)

Para controlar la función de encendido/apagado de ahorro de Energía.

Transmisión [j][q][][ID del Televisor][][Dato][Cr]

Dato 00: Ahorro de energía Apagado

01: Ahorro de energía: Mínimo

02: Ahorro de energía: Medio

03: Ahorro de energía: Máximo

05: Desconexión de pantalla

10: Sensor Inteligente

Reconocimiento [q][][ID del Televisor][][OK/NG][Dato][x]

20. Auto Configuración (Comando: j u)

Ajustar la posición de la imagen y reducir el temblor de la imagen en forma automática. La auto configuración sólo funciona con RGB-PC.

Transmisión [j][u][][ID del Televisor][][Dato][Cr]

Dato 1: Para configurar

Reconocimiento [u][][ID del Televisor][][OK/NG][Dato][x]

21. Sintonización de canales (Comando: m a)

Para sintonizar los canales en el siguiente número físico/mayor/menor.

Transmisión [m][a][][ID del Televisor][][Dato00][][Dato01][][Dato02][][Dato03][][Dato04][][Dato05][Cr]

Los canales digitales poseen un número de canal Físico, Mayor y Menor. El número Físico es el número de canal digital real, el Mayor es el número al cual el canal se debe asociar y el Menor es el subcanal. Dado que el sintonizador ATSC automáticamente asocia el canal al número Mayor, el número Físico no se requiere.

Dato 00: Número de canal físico

NTSC aéreo: 02 - 45, NTSC cable: 01, 0E - 7D

ATSC aéreo: 01 - 45, ATSC cable: 01 - 87

Dato 01 & 02: Mayor número de canal

Dato 01: Bytes altos

Dato 02: Bytes bajos

Se encuentran disponibles dos bytes para el Mayor y Menor, y normalmente sólo se usa el segundo byte.

Dato 03 & 04: Número de canal menor

No se necesita para NTSC.

Dato 05:

7	Imagen principal/secundaria	6	Canal de dos/una parte	5	Uso de canal físico	4	Reservado	3	2	1	0	Paso
0	Principal	0	Dos	0	Uso	x		0	0	0	0	NTSC Air
1	Secundaria	1	Uno	1	Sin uso	x		0	0	0	1	NTSC Cable
						x		0	0	1	0	ATSC Air
						x		0	0	1	1	ATSC Cable_std
						x		0	1	0	0	ATSC Cable_hrc
						x		0	1	0	1	ATSC Cable_irc
						x		0	1	1	0	ATSC cable_auto
						x		0	1	1	1	Reservado
						x		x	x	x	x	...
						x		1	1	1	1	Reservado

En la tabla anterior aparece el código binario que se debe convertir a Hexadecimal antes del envío. Por ejemplo: El código binario para sintonizar la subfuente en un canal de cable NTSC es "1000 0001", el cual se traduce a "81" en Hex.

- * 7° bit: Para qué fuente desea cambiar el canal.
- * 6° bit: Use un canal de dos partes o de una parte. En la mayoría de los casos use simplemente 0, ya que se ignora cuando se utiliza NTSC.
- * 5° bit: Use 0 con NTSC, ya que sólo puede utilizar el número de canal físico. Normalmente use 1 para ATSC, ya que la mayoría de las veces no importa cuál sea el número físico.
- * 4° bit: Ajuste en 0.
- * Bits 3-0: Elija el tipo de señal.

* Ejemplos de comando de sintonización:

1. Sintonice en canal de cable análogo (NTSC) 35.

Dato 00 = Físico de 35 = 23
 Dato 01 & 02 = Sin Mayor = 00 00
 Dato 03 & 04 = Sin Menor = 00 00
 Dato 05 = 0000 0001 en binario = 01
 Total = ma 00 23 00 00 00 00 01

2. Sintonice en el canal local digital (ATSC) 30 -3.

Dato 00 = No se conoce el Físico = 00
 Dato 01 & 02 = Mayor es 30 = 00 1E
 Dato 03 & 04 = Menor es 3 = 00 03
 Dato 05 = 0010 0010 en binario = 22
 Total = ma 00 00 00 1E 00 03 22

```
Reconocimiento[a][ ][ID del Televisor][ ][OK][Dato00]
[Dato01][Dato02][Dato03][Dato04][x][a][ ][ID del Televisor]
[ ][NG][Dato00][x]
```

22. Agr./Eli. de canal (Comando: m b)

Para agregar y eliminar canales.

Transmisión [m][b][][ID del Televisor][][Dato][Cr]

Dato 00: Borrar programa Dato 01: Memorizar programa

Reconocimiento [b][][ID del Televisor][][OK/NG][Dato][x]

23. Botones (Comando: m c)

Para mandar el código de botón remotó IR.

Transmisión [m][c][][ID del Televisor][][Dato][Cr]

► p.113.

Reconocimiento [c][][ID del Televisor][][OK/NG][Dato][x]



El número de modelo y serie del televisor se encuentra en la parte posterior y en un lateral del televisor respectivamente.
Anótelos a continuación para tenerlos disponibles en caso de necesitar asistencia.

MODELO _____

SERIE _____