



Washing Machine

Owner's manual

F1256LD(1)	F1258LD(1)	F1257LD(1)	F1259LD(1)
F1056LD(1)	F1058LD(1)	F1057LD(1)	F1059LD(1)
F8056LD(1)	F8058LD(1)	F1257ND(1)	F1259ND(1)
F1256ND(1)	F1258ND(1)	F1057ND(1)	F1059ND(1)
F1056ND(1)	F1058ND(1)	F1257QD(1)	F1259QD(1)
F8056ND(1)	F8058ND(1)	F1057QD(1)	F1059QD(1)
F1256QD(1)	F1258QD(1)		
F1056QD(1)	F1058QD(1)		
F8056QD(1)	F8058QD(1)		

Thank you for buying a LG Fully Automatic Washing machine.
Please read your owner's manual carefully, it provides instructions
on safe installation, use and maintenance.
Retain it for future reference.
Record the model and serial numbers of your washing machine.

P roduct Features



■ Protection against creases

With the alternate rotation of the drum, creasing in the laundry is minimized.



■ More economical by Intelligent Wash System

Intelligent Wash System detects the amount of load and water temperature, and then determines the optimum water level and washing time to minimize energy and water consumption.



■ Child-Lock

The child-lock system is to be used for preventing children from pressing any button to change the program during operation.



■ Low noise speed control system

By sensing the amount of load and balance, it evenly distributes load to minimize the spinning noise level.

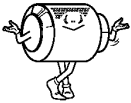

■ Direct Drive System

The advanced Brushless DD motor rotates the drum directly without belt and pulley.

C ontents

Warnings.....	3
Specifications.....	4
Installation.....	5
Function / How to use washer:	
F12/10/8056LD/ND/QD(1) / F12/10/8058LD/ND/QD(1).....	11
F12/1057LD/ND/QD(1) / F12/1059LD/ND/QD(1).....	17
Care before washing.....	24
Adding detergent.....	25
Maintenance.....	26
Troubleshooting guide.....	28
Terms of Warranty.....	31

Warnings

READ ALL INSTRUCTIONS AND EXPLANATION OF THE INSTALLATION BEFORE USE



WARNING!

For your safety, the information in this manual must be followed to minimize the risk of fire or explosion, electric shock, or to prevent property damage, personal injury, or loss of life.

IMPORTANT SAFETY INSTRUCTIONS

WARNING: To reduce the risk of fire, electric shock, or injury to persons when using the washer, follow basic precautions, including the following:

- Before installation, check exterior damages. If it has, do not install.
- Do not install or store the washer where it will be exposed to the weather.
- Do not tamper with controls.
- Do not repair or replace any part of the washer or attempt any servicing unless specifically recommended in the user-maintenance instructions or published user-repair instructions that you understand and have the skills to carry out.
- Keep the area underneath and around your appliances free of combustible materials such as lint, paper, rags, hemicals, etc.
- Close supervision is necessary if this appliance is used by or near children. Do not allow children to play on, with, or inside this or any other appliances.
- Keep small animals away from the appliance.
- Do not leave the washer door open.
An open door could entice children to hang on the door or crawl inside the washer.
- Never reach into washer while it is moving. Wait until the drum has completely stopped.
- The laundry process can reduce the flame retardant of fabrics.
- Do not install your washing machine in rooms where temperature below freezing may occur. Frozen hoses may burst under pressure. The reliability of the electronic control unit may be impaired at temperatures below freezing point.
- To avoid such a result, carefully follow the garment manufacturer's wash and care instructions.
- Do not wash or dry articles that have been cleaned in, washed in, soaked in, or spotted with combustible or explosive substances (such as wax, oil, paint, gasoline, degreasers, dry-cleaning solvents, kerosene, etc.) which may ignite or explode. Oil may remain in the tub after a whole cycle resulting in fire during drying. So, do not load oiled clothes.
- Do not slam the washer door closed or try to force the door open when locked. This could result in damage to the washer.
- When the machine runs high temperature, the front door may be very hot. Don't touch it.
- To minimize the possibility of electric shock, unplug this appliance from the power supply or disconnect the washer at the household distribution panel by removing the fuse or switching off the circuit breaker before attempting any maintenance or cleaning.
- When unplugging power cord, do not pull out by grasping the cord. Otherwise, the power cord may be damaged.
- Never attempt to operate this appliance if it is damaged, malfunctioning, partially disassembled, or has missing or broken parts, including a damaged cord or plug.
- Before discarding an old machine unplug it. Render the plug useless. Cut off the cable directly behind the appliance to prevent misuse.
- When a product was under water, please call service center. There is a risk of electric shock and fire.

*** Do not push down the door excessively, when washer door open.
This could topple over the washer.**

SAVE THESE INSTRUCTIONS

S pecifications

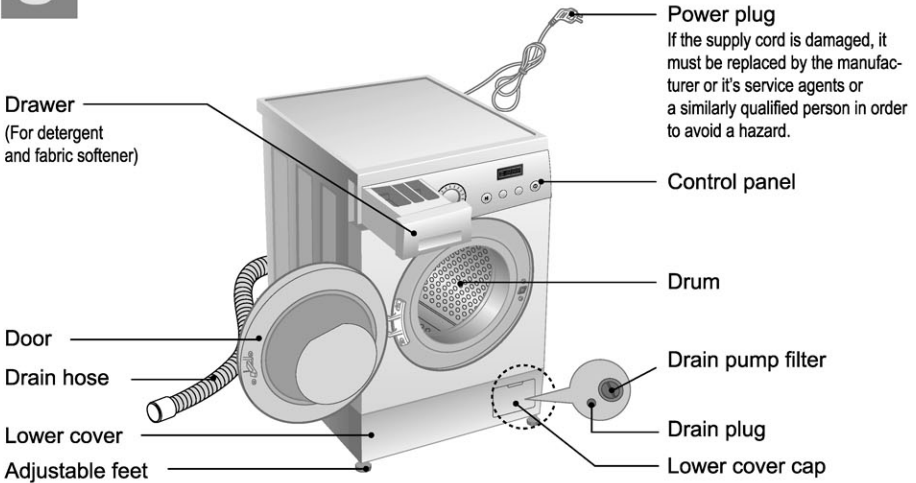

Name	FRONT LOADING WASHING MACHINE					
Model	F12/10/8056LD(1) F12/10/8058LD(1)	F12/1057LD(1) F12/1059LD(1)	F12/10/8056ND(1)	F12/10/8058ND(1) F12/1057ND(1) F12/1059ND(1)	F12/10/8056QD(1)	F12/10/8058QD(1) F12/1057QD(1) F12/1059QD(1)
Wash capacity	5,0 kr		6,0 kr		7,0 kr	
Water consumption	48 ℓ	60 ℓ	56 ℓ	55 ℓ	49 ℓ	56 ℓ
Size (W)x(D)x(H)	600mm x 440mm x 850mm				600mm x 550mm x 850mm	
Weight/Max.Watt	59kg / 1700 W				65kg / 2100 W	
Power supply	220 – 240 V ~, 50 Hz					
Spin speed	No spin / 400 / 600 / 800 / 1000 / 1200 (Spin speed can be different according to model)					
Permissible water pressure	0,3 – 10 kgf/cm ² (30-1000 kPa)					

The appearance and specifications may be varied without notice to raise the units quality.

■ Accessories



Inlet hose 1EA



Spanner

I nstallation

CAUTION!

For installation and use of the machine, read the instruction booklet carefully. Only correct installation will ensure smooth and safe use of the appliance.

■ Electrical connection

1. For this washing machine is used single-phase pressure 220-240V, 50 Hz.
2. Be convinced that your electric wiring is capable to sustain the maximum loading considering work of other electrodevices.
3. Connect a washing machine only to the earthed socket.
4. This appliance is equipped with a cord having an equipment-grounding conductor and grounding plug. Be convinced of that, the electric system has a ground connector. In the absence of grounding, it is necessary to invite the qualified electrician or serviceman, who will perform all necessary works according to local norms and requirements.
5. Most appliances recommend they be placed upon a dedicated circuit; that is, a single outlet circuit which powers only that appliance and has no additional outlets or branch circuits. Check the specification page of this owner's manual to be certain. It is forbidden to use tee or the extension piece.
6. If you don't have the proper outlet, consult an electrician.
7. Always unplug the machine and turn off the water supply after use.
8. The appliance must be positioned so that the plug is easily accessible.
9. If the appliance is delivered in the winter months and temperatures are below freezing, place the washing machine at room temperature for a few hours before putting it into operation.

WARNING

CONCERNING THE POWER CORD

Do not overload wall outlets. Overloaded wall outlets, loose or damaged wall outlets, extension cords, frayed power cords, or damaged or cracked wire insulation are dangerous. Any of these conditions could result in electric shock or fire. Periodically examine the cord of your appliance, and if its appearance indicates damage or deterioration, unplug it, discontinue use of the appliance, and have the cord replaced with an exact replacement part by an authorized servicer.

Protect the power cord from physical or mechanical abuse, such as being twisted, kinked, pinched, closed in a door, or walked upon. Pay particular attention to plugs, wall outlets, and the point where the cord exits the appliance.



Improper connection of the equipment-grounding conductor can result in risk of electric shock. Do not modify the plug provided with the appliance - if it does not fit the outlet, have a proper outlet installed by a qualified electrician.

Repairs to the washing machine must only be carried out by qualified personnel.

Repairs carried out by inexperienced persons may cause injury or serious malfunctioning. Contact your local service center.

The manufacturer is released from any damage liability to people or property in case of default of the above-stated precautions.

I nstallation

■ Positioning

Before unpacking the washer have to determine the installation place.

- ▶ Identify the additional clearance for both side is 20 mm and for rear is 100mm. The washer should not adjoin walls or furniture.
 - ▶ Make sure that installation place have flat and hard floor:
 - at installation on carpets, rug etc. ensure that air circulation freely between the adjustable feet and the floor;
 - at installation on tile enclose under legs rubber cups;
 - at installation on wooden floors we recommend to enclose under each leg rubber cups, at least 15 mm thick secured by screws at least to two floor boards.
- * You can obtain the rubber cups (P/No.: 4620ER3001B) from the LG spares dept.*
- ▶ Never try to correct any unevenness in the floor with pieces of wood, card board or similar materials under the washer.
 - ▶ If it is impossible to avoid positioning the washer next to a gas cooker or coal burning stove, an insulating (85x60cm) covered with aluminum foil on the side facing the cooker or stove, must be inserted between the two appliance.
 - ▶ The washer must not be installed in rooms where the temperature can drop below 0°C.
 - ▶ The installation surface must be clean and dry.
 - ▶ Please ensure that when the washer is installed, it is easily accessible for the engineer in the event of a breakdown.
 - ▶ In countries where there are areas which may be subject to infestation by cockroaches or other vermin, pay particular attention to keeping the appliance and its surroundings in clean condition at all times. Any damage which may be cause by cockroaches or other vermin will not be covered by the appliance guarantee.

■ Unpacking

Remove all packing parts and check that is not any damage. If in doubt, do not use washer, and immediately contact the retailer.

Installation

■ Unpacking



When unpacking the base, be sure to remove the additional packing support in the middle of the base packing.

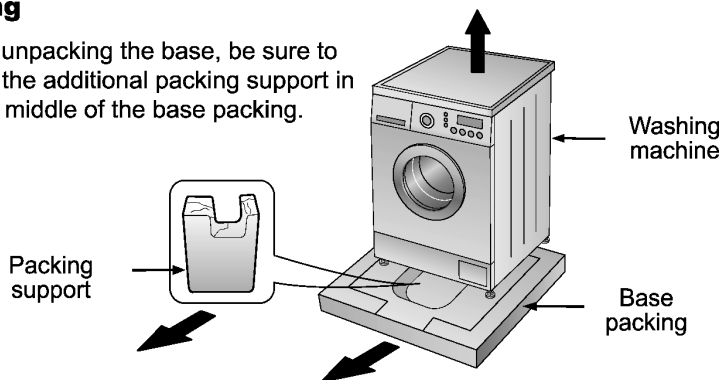

CAUTION: The packaging components (e.g. plastic film, polystyrene) can be dangerous to children - danger of suffocation! Keep them out of children's reach.

■ Removing transit bolts

Transit bolts must be removed before using the washer.

- ▶ Unscrew the 4 transit bolts with the spanner supplied, and take them out with the rubber bungs.

If the transit bolts are not removed, it may cause heavy vibration, noise and malfunction.

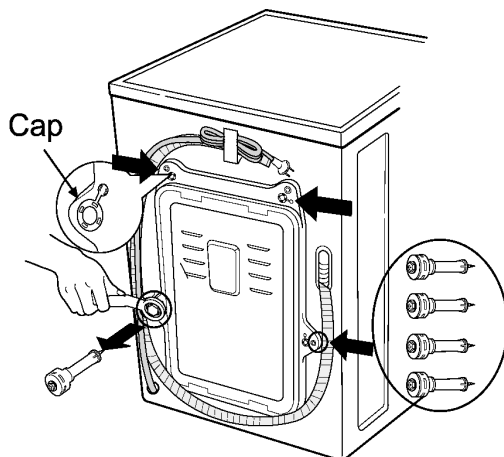

We recommend to keep all transportation parts for using it next time, whenever the appliance is transported.

Installation

■ Connecting water supply hose

Washing Machine is to be connected to the water mains using new hose-sets and that old hose-sets should not be used.

- ▶ Make sure that water supply pressure have admissible limits:

- The value of hydraulic pressure should lay within the limits of from 1 up to 10 bar (it is mean, that for one minute should follow from completely open water crane a minimum of 8 litres of water).
- If the water supply pressure is more than indicated, should be installed a decompression device.

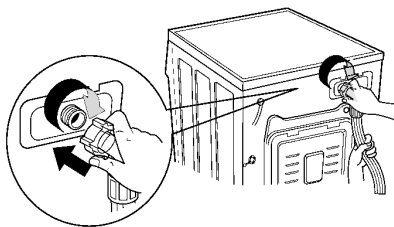

- ▶ One end of a hose of water delivery connect to the machine, having turned it in the direction necessary to you. To develop a hose it is enough to weaken muff to connect for a hose and an owl to tighten muff having convinced in absence of outflow of water.



Before connecting up the washer to new pipe-work or to pipe-work that has not been used for some time, run off a reasonable amount of water to flush out any debris that may have collected in the pipes.

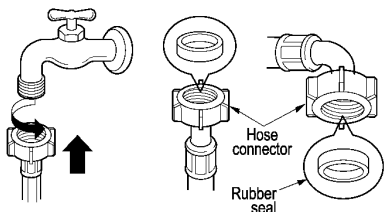

- ▶ Other end of a hose of water delivery connect to the water crane.
- ▶ Two rubber seals are supplied with the water inlet hoses. They are used for preventing water leaks.

- ▶ Make sure the connection to taps is tight enough.
- ▶ Periodically check the condition of the hose and replace the hose if necessary.

The hose of water delivery is not a subject to lengthening. If it too short and you do not wish to move the water crane, you should buy the new longer hose specially intended for this purpose.

Installation

■ Level adjustment

Adjusting the washing machine level properly prevents excessive noise and vibration. Install the appliance on a solid and level floor surface, preferably in a corner of the room.

- ▶ Make sure that all four feet are stable and resting on the floor and then check that the appliance is perfectly level (use a spirit level). Adjust the washer position with adjustable feet.
- ▶ In the case that the washing machine is established on a raised platform, it must be securely fastened in order to eliminate the risk that it might fall off.

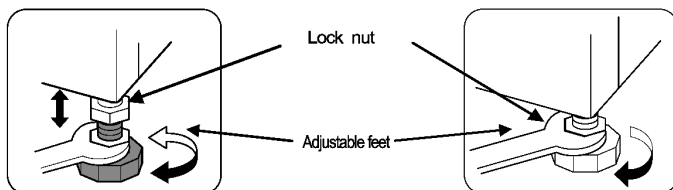
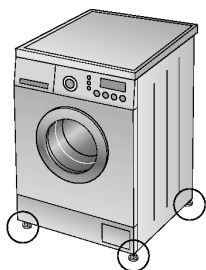
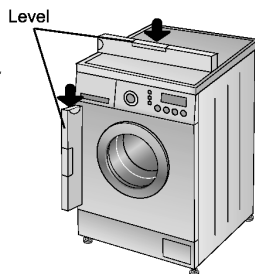

- ▶ Carefully level by screwing the adjustable feet in or out. Never place cardboard, wool or similar materials under the washer to compensate for any unevenness in the floor.
- ▶ After the washer is level, tighten the lock nuts up towards the base of the washer. All lock nuts must be tightened.

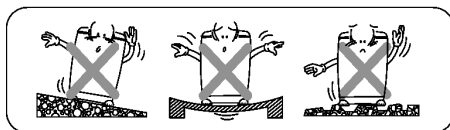

- ▶ Make sure that the washer is standing firmly.
- ▶ If the machine rocks when pushing the machine top plate diagonally, adjust the feet again.

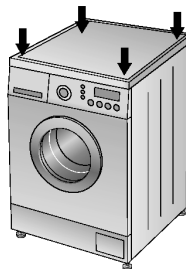

Proper placement and levelling of the washer ensure long, regular and reliable operation.

Installation

CAUTION

This equipment is not designed for maritime use or for use mobile installations such as caravans, aircraft etc. Turn off the stopcock if the machine is to be left for any length of time (e.g. holiday), especially if there is no floor drain (gully) in the immediate vicinity.

When disposing of the appliance, cut off the mains cable, and destroy the plug. Disable the door lock to prevent young children being trapped inside.

Packaging material (e.g. Films, Styrofoam) can be dangerous for children. There is a risk of suffocation! Keep all packaging well away from children.

Installation of drain hose

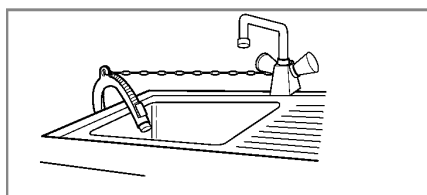
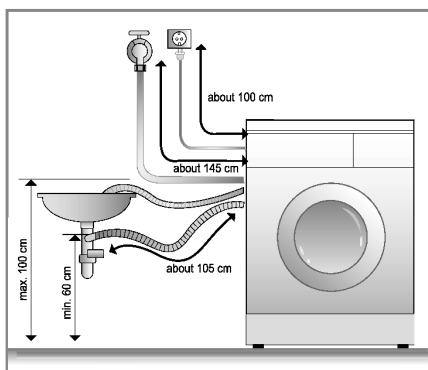

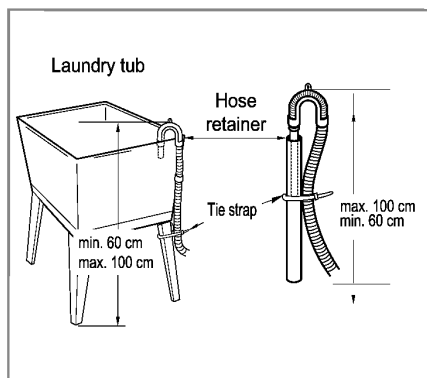
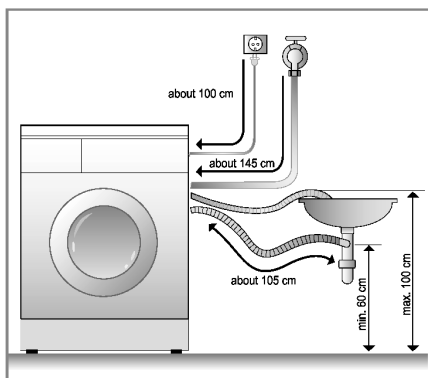

- When installing the drain hose sink, secure it tightly with a string.
- Proper securing of the drain hose will protect the floor from damage due to water leakage.



- The drain hose should not be placed higher than 100 cm above the floor otherwise the water would not drain or would drain slowly.
- Proper securing of the drain hose will protect the floor from damage due to water leakage. When the drain hose is too long, do not force back into the washer. This will cause abnormal noise.

■ Recommended courses according to the laundry type

Program	Fabric Type	Proper Temperature	Option	Maximum Load
COTTON	First check if laundry is machine washable. (white cotton, linen towel, and sheets...)	95°C	MEDIC RINSE INTENSIVE PRE WASH CREASE CARE	Rating
	Color fast garments (shirts, night dresses, pajamas...) and lightly soiled white cotton (underwear...)	60°C (Cold, 30°C, 40°C)		
COTTON QUICK	Cotton which is lightly soiled.			
SYNTHETIC	Polyamide, Acrylic, Polyester	40°C (Cold, 30°C, 60°C)	INTENSIVE	Less than 2.0 kg
QUICK 30	Colored Laundry which is lightly soiled fast.			Less than 1.5 kg
HAND WASH  / WOOL 	"Hand Wash" marked laundry or machine washable woolens	30°C (Cold, 40°C)	INTENSIVE	Less than 1.5 kg
DELICATE	Delicate laundry easily damaged (silk, curtains...)			Rating
BULKY	Thick laundry absorbing much water (Jumper)	30°C (Cold)		Less than 1.5 kg
BLANKET	Cotton bedding with filling, duvet, pillow, blanket, sofa cover with light filling.	60°C (95°C)	MEDIC RINSE INTENSIVE CREASE CARE	1 king size (9 Tog)
BIO CARE	For elimination of protein stains	60°C (95°C)	MEDIC RINSE INTENSIVE PRE WASH CREASE CARE	Rating
BABY CARE 	Laundry for infant			Less than 4.0 kg
WHITE	For elimination of remnant detergent after boiling wash.	95°C		Rating
BLANKET	Cotton bedding with filling, duvet, pillow, blanket, sofa cover with light filling.	60°C (95°C)	MEDIC RINSE INTENSIVE CREASE CARE	Rating

- **WATER TEMPERATURE:** Select the water temperature to the wash cycles. Always follow garment manufacture's care label or instructions when laundering.
- **PRE WASH:** If the laundry is heavily soiled, and soak only is not enough, Pre Wash course is effective. Put detergent into the special container.
- **INTENSIVE:** If the laundry is heavily soiled Intensive option is effective. By selecting the Intensive option wash is performed according to EN 60456 and IEC 60456 standards.
- Program setting with "COTTON 60°C+INTENSIVE" option for test in accordance or in conformity with IEC60456 and EN60456.
- **MEDIC RINSE:** For high effectiveness or more purity in rinse operation you can choose Medic Rinse option, which performs three additional rinses. The last rinse cycle uses warm water.
- **CREASE CARE:** If you want to prevent crease, select this button with spin speed.



The wool wash cycle of this machine has been approved by Woolmark for the washing of machine washable Woolmark products provided that the products are washed according to the instructions on the garment label.

How to use washer

F1256LD/ND/QD(1) / F1056LD/ND/QD(1) / F8056LD/ND/QD(1)
 F1258LD/ND/QD(1) / F1058LD/ND/QD(1) / F8058LD/ND/QD(1)

★ Control Panel for models F1256ND(1) / F1056ND(1) / F8056ND(1) / F1258ND(1) / F1058ND(1) / F8058ND(1).

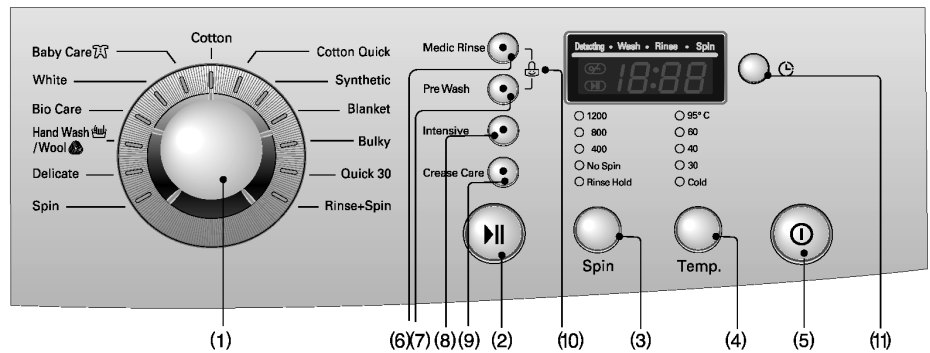

- (1) Dial : Program
- (2) Button : Start / Pause
- (3) Button : Spin
- (4) Button : Temperature
- (5) Button : Power
- (6) Button : Medic Rinse
- (7) Button : Pre Wash
- (8) Button : Intensive
- (9) Button : Crease Care
- (10) Child Lock
- (11) Button : Time Delay

Options

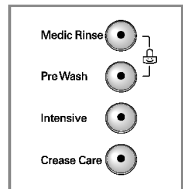

Needed **Option** can be activated by pressing a specific button.

1. Medic Rinse

- For high effectiveness or more purity in rinse operation you can choose **Medic Rinse** option.

2. Pre Wash

- If the laundry is heavily soiled, **Pre Wash** course is effective.
- Pre Wash** is available in COTTON, SYNTHETIC, BIO CARE, BABY CARE and BOILING CARE.

3. Intensive

- If the laundry is heavily soiled **Intensive** option is effective.
- By selecting the Intensive option, the wash time may be extended, depending on the program selected.

4. Crease Care

- If you want to prevent crease, select this button with spin speed.
- The required lamp will light up for identification.**

How to use washer

F1256LD/ND/QD(1) / F1056LD/ND/QD(1) / F8056LD/ND/QD(1)
 F1258LD/ND/QD(1) / F1058LD/ND/QD(1) / F8058LD/ND/QD(1)

* **Control Panel for models F1256LD/QD(1) / F1056LD/QD(1) / F8056LD/QD(1) / F1258LD/QD(1) / F1058LD/QD(1) / F8058LD/QD(1).**



Power



1. Power

- Press the **Power** button to turn power on and off.
- To cancel the **Time Delay** function, the **Power** button should be pressed.

2. Initial Program

- Press the **Power** button to start.
- Press the **Start/Pause** button.

INITIAL CONDITIONS:

- **Wash: Cotton, 60°C**
- **Rinse: 3 times**
- **Spin:**
 - **800 rpm**
[F8056LD/INDI/QD(1), F8058LD/INDI/QD(1)]
 - **1000 rpm**
[F1056LD/INDI/QD(1), F1058LD/INDI/QD(1)]
 - **1200 rpm**
[F1256LD/INDI/QD(1), F1258LD/INDI/QD(1)]

Door lock

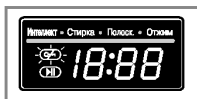

- Lights whenever the door of the washer is locked.
- The door can be unlocked by pressing (▶||).

- The door can be opened after a short delay.

Start/Pause



1. Start / Pause

- **Start/Pause** button is used to start wash cycle or pause the wash cycle.
- If temporary stop of wash cycle is needed, press the **Start/Pause** button.
- When in pause, the power is turned off automatically **after 4 minutes**.

Time delay

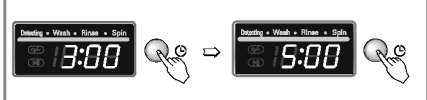

- You can use **Time Delay** function if you want to delay washing cycle for a long time.
- **Time Delay** is "expected time" from the present to the completion of washing cycle or selected process: wash, rinse, spin (from 3 to 19 hours).
- Each pressing of the button advances on **Time delay** by one hour.
- To set the **Time Delay**, press (▶||).
- To cancel the **Time Delay**, press (⓪).
- According to the condition of water supply and temperature, the delayed time and the actual washing time may vary.

H ow to use washer

F1256LD/ND/QD(1) / F1056LD/ND/QD(1) / F8056LD/ND/QD(1)
F1258LD/ND/QD(1) / F1058LD/ND/QD(1) / F8058LD/ND/QD(1)

Program

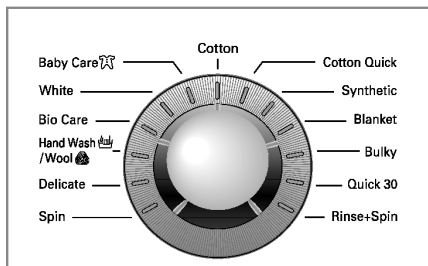

- 13 programs are available according to the laundry type.
- Lamp will light up to indicate selected program.
- When **Start/Pause** button is pressed, the COTTON program is automatically selected.
- By turning the Program dial, the program is selected in order of
COTTON – COTTON QUICK – SYNTHETIC –
BLANKET – BULKY – QUICK 30 –
RINSE+SPIN – SPIN – DELICATE – HAND
WASH/WOOL – BIO CARE – WHITE – BABY
CARE.

Regarding to the laundry type for each program Please refer to the page11.

Detecting



- While the **Detecting** is shown in the display the machine rotates slowly and detects how many laundries are loaded in the drum. It will take a few seconds.
- Available in COTTON, COTTON QUICK and SYNTHETIC.

Lamp will light up to indicate selected program.

How to use washer

F1256LD/ND/QD(1) / F1056LD/ND/QD(1) / F8056LD/ND/QD(1)
F1258LD/ND/QD(1) / F1058LD/ND/QD(1) / F8058LD/ND/QD(1)

Display

1. Special function display

- When Child Lock is selected "CL" is displayed.
- When **Time Delay** is selected, it shows the remaining time to finish the selected program.

2. Self diagnosis display

- If the machine encounters a fault during operation, the associated fault will be displayed.
- "PE": Water pressure sensing error
"FE": Problem of overfilling water
"dE": ("Door open"): Door is not closed
"LE": Over load in motor
"EE": Over load in motor
"IE": ("No water supply"): Water inlet trouble
"NF": ("Not draining"): Drainage trouble
"UE": ("No spinning"): Unbalanced load
"tE": Water temperature trouble
"PF": The washer experienced a power failure.

If these error letters are displayed, please refer to the troubleshooting page 30 and follow the guide.

3. Completion of washing

- When washing cycle is completed, "End" is displayed on the "Multi display".

Child Lock



If you choose to lock the buttons on the control assembly to prevent tampering this function may be selected.

- **Child Lock** can be set by pressing the **Medic Rinse** button and **Pre Wash** buttons simultaneously. (About three seconds)



- When **Child Lock** is set, all buttons are in operable except for **Power** button.
- To deactivate **Child Lock** system, press **Medic Rinse** and **Pre Wash** buttons simultaneously again. (About three seconds)



- To change to the desired program, while in **Child Lock** mode is set.
 - Press both **Medic Rinse** and **Pre Wash** together once again. (About three seconds)
 - Press the **Start/Pause** button.
 - Select the desired program and press the **Start/Pause** button again.



- The **Child Lock** can be set at any time and it is automatically canceled when operational errors occur.

How to use washer

F1256LD/ND/QD(1) / F1056LD/ND/QD(1) / F8056LD/ND/QD(1)
F1258LD/ND/QD(1) / F1058LD/ND/QD(1) / F8058LD/ND/QD(1)

Spin

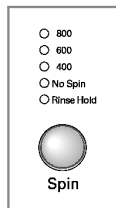

F8056LD/ND/QD(1) F1056LD/ND/QD(1) F1256LD/ND/QD(1)
F8058LD/ND/QD(1) F1058LD/ND/QD(1) F1258LD/ND/QD(1)

- After selecting the spin course, the spin speed can be chosen by pressing the **Spin** button.

1. Spin selection

- Spin speed is available according to the program as follows.

F8056LD/ND/QD(1), F8058LD/ND/QD(1)

- **COTTON, RINSE+SPIN, QUICK 30, BIO CARE, BULKY**
Rinse Hold - No Spin - 400 - 600 - 800

- **DELICATE, BLANKET, BABY CARE, WHITE, COTTON QUICK, SYNTHETIC, HAND WASH/WOOL**

Rinse Hold - No Spin - 400 - 600

- **SPIN**

No Spin - 400 - 600 - 800

F1056LD/ND/QD(1), F1058LD/ND/QD(1)

- **COTTON, RINSE+SPIN, QUICK 30, BIO CARE, BULKY**
Rinse Hold - No Spin - 400 - 800 - 1000

- **DELICATE, BLANKET, BABY CARE, WHITE, COTTON QUICK, SYNTHETIC, HAND WASH/WOOL**

Rinse Hold - No Spin - 400 - 800

- **SPIN**

No Spin - 400 - 800 - 1000

F1256LD/ND/QD(1), F1258LD/ND/QD(1)

- **COTTON, RINSE+SPIN, QUICK 30, BIO CARE, BULKY**
Rinse Hold - No Spin - 400 - 800 - 1200

- **DELICATE, BLANKET, BABY CARE, WHITE, COTTON QUICK, SYNTHETIC, HAND WASH/WOOL**

Rinse Hold - No Spin - 400 - 800

- **SPIN**

No Spin - 400 - 800 - 1200

2. No spin

- If No spin is selected, the washer stops after draining water.

3. Rinse Hold

- Rinse Hold is selected by pressing the spin button repeatedly this function leaves clothes in the machine; suspended in the water after a rinse without entering into spin.
- To proceed through to a drain or spin, once the rinse hold function is completed using to Program dial and Spin button to the required program. (Spin)

The required lamp will light up for identification.

Water Temp.

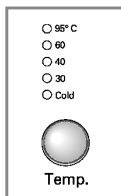

- By pressing the **Temp.** button, the water temperature can be selected.

- **Cold**

- **30°C / 40°C / 60°C / 95°C**

Water temperature can be selected according to the program.

For the more detailed information, please refer to the page 11.

The required temperature lamp will light up for identification.



■ Recommended courses according to the laundry type

Program	Fabric Type	Proper Temperature	Option	Maximum Load
COTTON	First check if laundry is machine washable. (white cotton, linen towel, and sheets...)	95°C	BIO SOAK PRE WASH SPIN ONLY RINSE+ SPIN	Rating
	Color fast garments (shirts, night dresses, pajamas...) and lightly soiled white cotton (underwear...)	60°C (Cold, 30°C, 40°C)		
COTTON QUICK	Cotton which is lightly soiled.	60°C (40°C)		Rating
SYNTHETIC	Polyamide, Acrylic, Polyester	60°C (Cold, 30°C, 40°C)		Less than 2.0 kg
BABY CARE	Laundry for infant	95°C (40°C, 60°C)	RINSE+ SPIN SPIN ONLY	Less than 4.0 kg
DELICATE	Delicate laundry easily damaged (silk, curtains...)	40°C (Cold, 30°C)		Less than 1.5 kg
WOOL / SILK	Machine washable woolsens with pure new wool only.			Less than 1.5 kg
HAND WASH	"Hand Wash " marked delicate and wool laundry.			Less than 1.5 kg
QUICK 30	Colored Laundry which is lightly soiled fast.			Less than 1.5 kg
BLANKET	Cotton bedding with filling, duvet, pillow, blanket, sofa cover with light filling.			60°C (95°C)

- * WATER TEMPERATURE: Select the water temperature to the wash cycles.
Always follow garment manufacture's care label or instructions when laundering.
- * PRE WASH: If the laundry is heavily soiled, "PRE WASH" Course is recommended.
- * BIO: If the laundry is heavily soiled, Pre Wash course is recommended.
- * MEDIC RINSE: For high effectiveness or more purity in rinse operation you can choose MEDIC RINSE option.
- * INTENSIVE: When washing heavily soiled laundry you can increase effectiveness by choosing INTENSIVE option.
- * SOAK: Use this mode to wash normal clothes or thick and heavy clothes which are excessively dirty.
After adding detergent your laundry stays in the water for two hours and more.
- * RINSE+: Used to additional rinse, which may assist in removing traces of detergent residue.
By selecting Rinse+ function, the rinse time and the rinse water are increased.



WOOLMARK

The wool wash cycle of this machine has been approved by Woolmark for the washing of machine washable Woolmark products provided that the products are washed according to the instructions on the garment label.



* Control Panel for models F1257ND(1) / F1057ND(1) / F1259ND(1) / F1059ND(1).

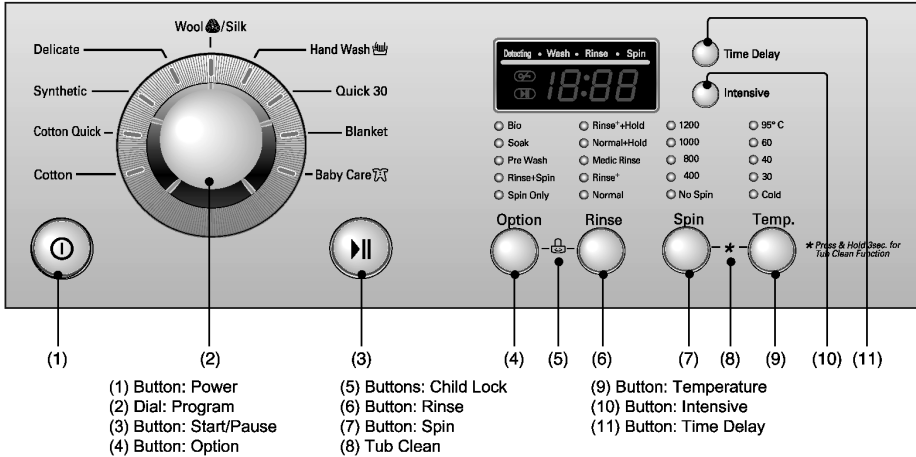

Program

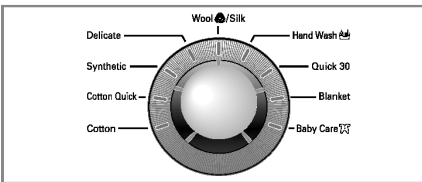

- 9 programs are available according to the laundry type.
- Lamp will light up to indicate selected program.
- When **Start/Pause** button is pressed, the COTTON program is automatically selected.
- By turning the Program dial, the program is selected in order of

COTTON - COTTON QUICK - SYNTHETIC - DELICATE - WOOL/SILK - HAND WASH - QUICK 30 - BLANKET - BABY CARE

To find a description for the each option, please refer to the page 17.

1. Cotton automatically selected upon power on.

- Press the **Power** button to start.
- Press the **Start/Pause** button.

INITIAL CONDITIONS:

- **Wash: Cotton, 60°C**
- **Rinse: 3 times**
- **Spin:**
 - **1000 rpm**
[F1057LD/ND/QD(1), F1059LD/ND/QD(1)]
 - **1200 rpm**
[F1257LD/ND/QD(1), F1259LD/ND/QD(1)]

2. Manual Selecting

- Press the **Power** button to start.
- Select the conditions which you want to use, by turning the Program dial and pressing each button.
- Press the **Start/Pause** button.

For selecting the each conditions, please refer to the page 17-22.

How to use washer

F1257LD/ND/QD(1) / F1057LD/ND/QD(1)
F1259LD/ND/QD(1) / F1059LD/ND/QD(1)

* Control Panel for models F1257LD/QD(1) | F1057LD/QD(1) | F1259LD/QD(1) | F1059LD/QD(1).

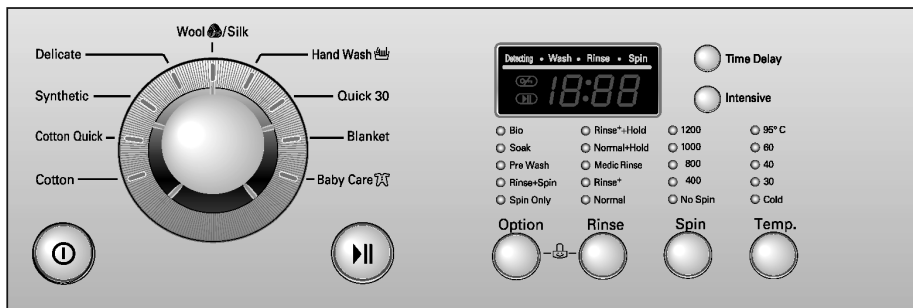

Power



- Press the **Power** button to turn power on and off.
- To cancel the **Time Delay** function, the **Power** button should be pressed.

Start / Pause



- **Start/Pause** button is used to start wash cycle or pause the wash cycle.
- If temporary stop of wash cycle is needed, press the **Start/Pause** button.
- When in pause, the power is turned off automatically **after 4 minutes**.

Door lock



- Lights whenever the door of the washer is locked.
- The door can be unlocked by pressing (II).

- The door can be opened after a short delay.

Detecting



- While the **Detecting** is shown in the display the machine rotates slowly and detects how many laundries are loaded in the drum. It will take a few seconds.
- Available in **COTTON**, **COTTON QUICK** and **SYNTHETIC**.

Time delay

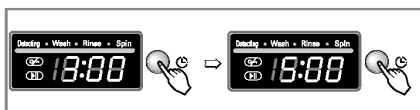

- You can use **Time Delay** function if you want to delay washing cycle for a long time.
- **Time Delay** is "expected time" from the present to the completion of washing cycle or selected process: wash, rinse, spin (from 3 to 19 hours).
- Each pressing of the button advances on **Time delay** by one hour.
- To set the **Time Delay**, press (II).
- To cancel the **Time Delay**, press (I).
- According to the condition of water supply and temperature, the delayed time and the actual washing time may vary.

Tub Clean

Tub Clean Function is available only for models: **F1257ND(1), F1057ND(1), F8057ND(1), F1259ND(1), F1059ND(1), F8059ND(1).**

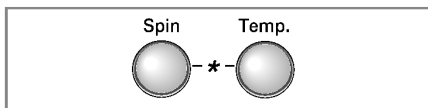

Tub Clean course can be set by pressing and holding **Spin** and **Temperature** buttons simultaneously.

When **Tub Clean** course is set, display **Tub Clean**, and all buttons are inoperable.

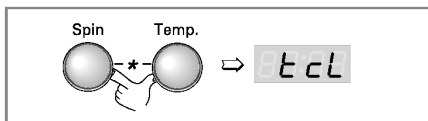

Tub Clean is special cycle to clean the inside of the washer. This cycle uses higher water level with higher spin speed. Perform this cycle regularly.

How to use the **Tub Clean** cycle:

1. Remove any clothing or items from the washer and close the door.
2. Open the dispenser drawer and add Anti limescale (Calgon) to the Main wash compartment.

NOTE: Do not add any detergent to the detergent compartments. Excessive suds may generate and leak from the washer.

3. Close the dispenser drawer slowly.
4. Power On and then press and hold **Spin** and **Temperature** buttons for 3 seconds then **Tub Clean** is displayed in LED.
5. Press the **Start/Pause** button to start.
6. After the cycle is complete, leave the door open to dry around the washer door opening, flexible gasket and door glass.

Option

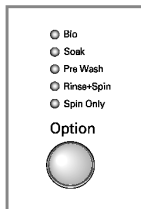

• By pressing the **Option** button, all Option functions may be selected.

1. Bio

- If you want to eliminate protein stains (milk, blood, chocolate...), you may select **Bio** function by pressing the **Option** button. (You can select **Bio** function when temperature is higher than 60°C in COTTON, COTTON QUICK and SYNTHETIC).

2. Soak

- Use this mode to wash normal clothes or thick and heavy clothes which are excessively dirty.
- Available in COTTON, COTTON QUICK and SYNTHETIC.

3. Pre Wash

- Use this option for load that need pretreatment.
- When using **Pre Wash** option, do not use liquid detergent in the main wash compartment. Use powder for the main wash.
- Available in COTTON, COTTON QUICK and SYNTHETIC.

4. Rinse+Spin

- Use this option to **Rinse** and then **Spin**.

5. Spin Only

- When you want **Spin Only**, select this option.



Rinse

- By pressing the **Rinse** button, the Rinse type can be selected.

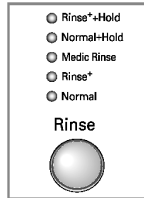

1. Rinse+Hold

- Is selected by pressing the **Rinse +Hold** button repeatedly this function leaves clothes in the washer; suspended in the water after a rinse without entering into spin.
- To proceed through to a **Spin**, once the **Rinse +Hold** function is completed using to **Program** dial scroll to the required program.

2. Normal+Hold

- Using **Normal+Hold** button the additional **Hold** function leaves clothes in the washer.

3. Medic Rinse

- For high effectiveness or more purity in rinse operation you can choose **Medic Rinse** option.

4. Rinse+

- Used to additional rinse, which may assist in removing traces of detergent residue.
- By selecting **Rinse+** function, the rinse time and the rinse water are increased.

5. Normal

- COTTON / COTTON QUICK / SYNTHETIC / BABY CARE
performs 3 Rinses
- WOOL/SILK / HAND WASH /QUICK 30 / DELICATE / BLANKET
performs 2 Rinses

The required lamp will light up for identification.

How to use washer

F1257LD/ND/QD(1) / F1057LD/ND/QD(1)
F1259LD/ND/QD(1) / F1059LD/ND/QD(1)

Water Temp.

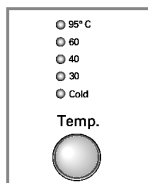

- By pressing the **Temp.** button, the water temperature can be selected.

- **Cold**
- 30°C / 40°C / 60°C / 95°C

- Water temperature can be selected as below according to the program.

- **COTTON QUICK**
40°C - 60°C
- **COTTON**
Cold - 30°C - 40°C - 60°C - 95°C
- **SYNTHETIC**
Cold - 30°C - 40°C - 60°C
- **DELICATE / WOOL/SILK / QUICK 30 / HAND WASH / BLANKET**
Cold - 30°C - 40°C
- **BABY CARE**
40°C - 60°C - 95°C

*For the more detailed information, please refer to the page 17.
The required temperature lamp will light up for identification.*

Intensive



- If the laundry is heavily soiled **Intensive** option is effective.
- By selecting the **Intensive** option, the wash time may be extended, depending on the program selected.
- To use this option press the **Intensive** button once before the wash program is started.

Spin

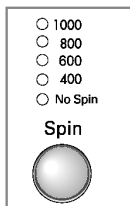

[F1057LD/ND(1), F1059LD/ND(1)]

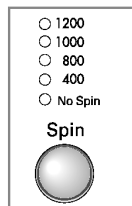

[F1257LD/ND(1), F1259LD/ND(1)]

- By pressing the **Spin** button, the spin speed can be chosen.

1. Spin selection

- Spin speed is available according to the program as follows.

F1057LD/ND/QD(1), F1059LD/ND/QD(1)

- **COTTON / COTTON QUICK / QUICK 30 / SYNTHETIC.**
No Spin - 400 - 600 - 800 - 1000
- **WOOL/SILK / HAND WASH / BLANKET / BABY CARE / DELICATE.**
No Spin - 400 - 600 - 800

F1257LD/ND/QD(1), F1259LD/ND/QD(1)

- **COTTON / COTTON QUICK / QUICK 30 / SYNTHETIC.**
No Spin - 400 - 800 - 1000 - 1200
- **WOOL/SILK / HAND WASH / BLANKET.**
No Spin - 400 - 800 - 1000
- **BABY CARE / DELICATE.**
No Spin - 400 - 800

2. No spin

- If **No Spin** is selected, the washer stops after draining water.

The required lamp will light up for identification.

How to use washer

F1257LD/ND/QD(1) / F1057LD/ND/QD(1)
F1259LD/ND/QD(1) / F1059LD/ND/QD(1)

Display

1. Special function display

- When **Child Lock** is selected, the “**CL**” is displayed
- When **Time Delay** is selected, it shows the remaining time to finish the selected program.

2. Self diagnosis display

- If the machine encounters a fault during operation, the associated fault will be displayed.

- " **PE** ": Water pressure sensing error
- " **FE** ": Problem of overfilling water
- " **dE** ": ("Door open"): Door is not closed
- " **LE** ": Over load in motor
- " **CE** ": Over load in motor
- " **IE** ": ("No water supply"): Water inlet trouble
- " **DE** ": ("Not draining"): Drainage trouble
- " **UE** ": ("No spinning"): Unbalanced load
- " **TE** ": Water temperature trouble
- " **PF** ": The washer experienced a power failure.

If these error letters are displayed, please refer to the troubleshooting page 30 and follow the guide.

3. Completion of washing

- When washing cycle is completed, “**End**” is displayed on the “Multi display”.

Child lock

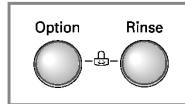

If you choose to lock the buttons on the control assembly to prevent tampering this function may be selected.

- **Child Lock** can be set by pressing the **Option** and **Rinse** button simultaneously. (About three seconds)

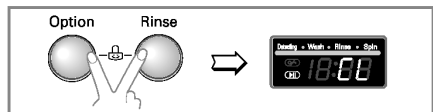

- When **Child Lock** is set, all buttons are locked.
- To deactivate **Child Lock** system, press and hold the **Option** and **Rinse** button simultaneously again (About three seconds).

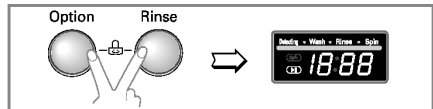

- To change to the desired program, while **Child Lock** mode is set.
 - Press both **Option** and **Rinse** together once again. (About three seconds)
 - Press the **Start/Pause** button.
 - Select the desired program and press the **Start/Pause** button again.

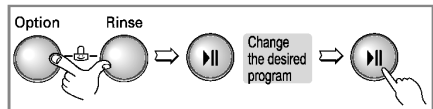

- The **Child Lock** can be set at any time and it is automatically canceled when operational errors occur.

Care before washing

■ Before the first washing

Select a cycle (COTTON 60°C, add a half load of detergent) allow the unit to wash without clothing. This will remove residues and water from the drum that may have been left during manufacturing.

■ Caring before washing

1. Care Labels

Look for a care label on your clothes. This will tell you about the fabric content of your garment and how it should be washed.

2. Sorting

To get the best results, sort clothes into loads that can be washed with the same wash cycle. Water temperature and spin speed and different fabrics need to be washed in different ways. Always sort dark colors from pale colors and whites. Wash separately as dye and lint transfer can occur causing discoloration of white etc. If possible, do not wash heavily soiled items with lightly soiled one.

Soil (Heavy, Normal, Light)	Color (White, Lights, Dark)	Lint (Lint producers, Collectors)
Separate clothes according to amount of soil.	Separate white fabrics from colored fabrics.	Wash lint producers and lint collectors separately.
Lint producers: bathrobes, towels. Lint collectors: Synthetic, velveteen, socks.		

3. Caring before loading

■ Combine large and small items in a load. Load large items first. Large items should not be more than half the total wash load.

Do not wash single items. This may cause an out-of-balance load. Add one or two similar items.



- Check all pockets to make sure that they are empty. Items such as nails, hair clip, matches, pens, coins and keys can damage both your washer and your clothes.



- Close zippers, hooks and strings to make sure that these items don't snag on other clothes.

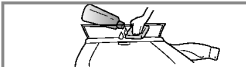

- Pre treat dirt and stains by brushing a little detergent dissolved in water onto stains like collars and cuffs to help shift dirt.

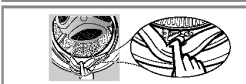

- Check the folds of the flexible gasket (gray) and remove any small articles, if any.



- Check inside of the drum and remove any left items in it for next wash cycle.



- Remove any clothing or items on the flexible gasket to prevent clothing and the gasket damages.

A dding detergent

■ Adding detergent and fabric softener

1. The Dispenser Drawer

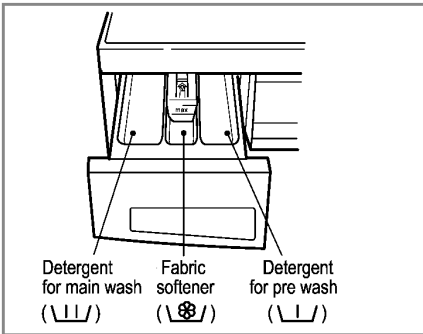

- Main wash only → \ \ /
- Pre Wash + Main Wash → \ / \ \ /

2. Adding Fabric Softener

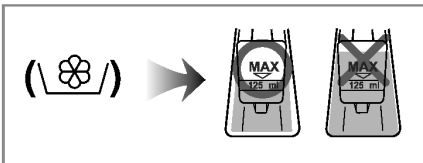

- Do not exceed the maximum fill line. Overfilling can cause early dispensing of the fabric softener which could stain clothes.
- Do not leave the fabric softener in the detergent drawer for more than 2 days. (Fabric softener could harden)
- Softener will automatically be added during the last rinse cycle.
- Do not open the drawer when water is supplied.
- Solvents (benzene, etc) are not allowable.

NOTE Do not pour fabric softener directly on the clothes.

3. Detergent dosage

- The detergent should be used according to the instruction of the detergent manufacture.
- If too much detergent is used, too many suds can occur and this will decrease the washing result or cause heavy load to the motor.
- Use powder detergent only for the front loading washer.
- * If suds occur too much, please reduce the detergent amount.
- Detergent usage may need to be adjusted for water temperature, water hardness, size and soil level of the load. For best results, avoid oversudsing.

4. Water softener

- A water softener, such as Anti limescale (Calgon) can be used to cut down on the use of detergent in extremely hard water areas. Dispense according to the amount specified on the packaging. First add detergent and then the water softener.
- Use the quantity of detergent as for soft water.

* Tips

Full load : according to manufacturer's recommendation.

Part load : 3/4 of the normal amount.

Minimum load : 1/2 of full load.

- Detergent is flushed from the dispenser at the beginning of the cycle.

Maintenance

- * Before cleaning the washer interior, unplug the electrical power cord to avoid electrical shock hazards.
- * When disposing of the appliance, cut off the mains cable, and destroy the plug.
- * Disable the door lock to prevent young children being trapped inside.

■ The water inlet filter

- "No water supply" (iE) error message will blink on the control panel when water does not enter the detergent drawer.
- If your water is very hard or contains traces of lime deposit, the water inlet filter may become clogged. It is therefore a good idea to clean it from time to time.

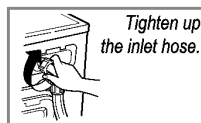
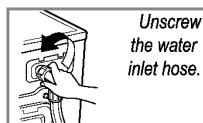
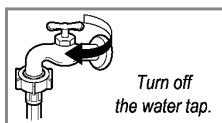

■ The drain pump filter

- * The drain filter collects threads and small objects left in the laundry. Check regularly that the filter is clean to ensure smooth running of your machine.

⚠ CAUTION

Open the pump filter to remove whatever any threads or objects. Be careful when draining if the water is hot.

1. Open the lower cover cap (①) by using a coin. Drain plug (②) to pull out the hose.
2. Unplug the drain plug (②), allowing the water to flow out. At this time use a vessel to prevent water flowing on to the floor. When water does not flow any more, turn the pump filter (③) open to the left.
3. Remove any foreign material from the pump filter (③). After cleaning, turn the pump filter (③) clockwise and insert the drain plug (②) to the original place. Close the lower cover cap.

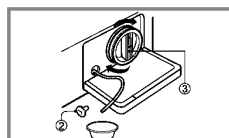
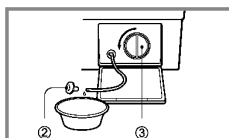
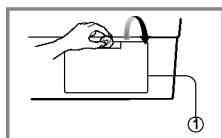

■ Cold condition

If the washer is stored in an area where freezing may occur or moved in freezing temperatures, follow these instructions to prevent damage to the washer:

1. Turn off water supply tap.
2. Disconnect hoses from water supply and drain water from hoses.
3. Plug electrical cord into a properly grounded electrical outlet.
4. Add 1gallon(3.8L) of nontoxic recreational vehicle (RV) antifreeze into an empty wash drum. Close the door.
5. Set spin cycle and let washer spin for 1minute to drain out all water. Not all of the RV antifreeze will be expelled.
6. Unplug electrical power cord, dry the drum interior, and close the door.
7. Remove dispenser drawer, drain and dry excessive water from the compartments.
8. Store washer in an upright position.
9. To remove antifreeze from washer after storage, run empty washer through a complete cycle using detergent. Do not add wash load.

Maintenance

■ Dispenser drawer

- * After a while detergents and fabric softeners leave a deposit in the drawer.
- It should be cleaned from time to time with a jet of running water.
- If necessary it can be removed completely from the machine by pressing the catch downwards and by pulling it out.
- To facilitate cleaning, the upper part of the fabric softener compartment can be removed.

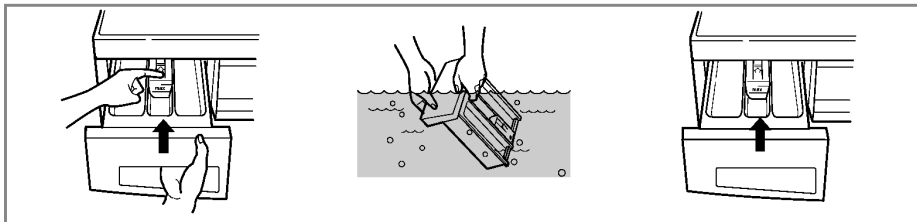

■ The drawer recess

- * Detergent can also accumulate inside the recess which should be cleaned occasionally.
- Once you have finished cleaning, replace the drawer and run a rinse cycle without laundry.

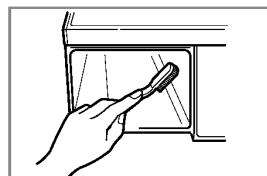

■ The washing drum

- If you live in a hard water area, limescale may continuously build up in places where it cannot be seen and thus not easily removed.
- Over time the build up of scale clogs appliances, and if it is not kept in check these may have to be replaced.
- Although the washing drum is made of Stainless steel, specks of rust can be caused by small metal articles (paper clips, safety pins) which have been left in the drum.
- The washing drum should be cleaned from time to time.
- If you use descaling agents, dyes or bleaches, make sure they are suitable for washing machine use.
- * Descaler may contain chemicals that may damage part of your washing machine.
- * Remove any spots with a stainless steel cleaning agent.
- * Never use steel wool.

■ Cleaning your washer

1. Exterior

Proper care of your washer can extend its life. The outside of the machine can be cleaned with warm water and a neutral non abrasive household detergent. Immediately wipe off any spills. Wipe with damp cloth. Try not to hit surface with sharp objects.



WARNINGS

Do not use methylated spirits, diluents or similar products.

2. Interior

Dry around the washer door opening, flexible gasket and door glass. Run washer through a complete cycle using hot water. Repeat process if necessary.

ЗАМЕЧАНИЕ

Remove hard water deposits using only cleaners labeled as safe for washing machine.

T

roubleshooting guide

* This washing machine is equipped with automatic safety functions which detect and diagnose faults at an early stage and react appropriately
 When the machine does not function properly or does not function at all, check the following points before you contact your service provider.











Symptom	Possible Cause	Solution
Rattling and clanking noise	<ul style="list-style-type: none"> Foreign objects such as coins or safety pins maybe in drum or pump. 	Stop washer and check drum and drain filter. If noise continues after washer is restarted, call your authorised service centre.
Thumping sound	<ul style="list-style-type: none"> Heavy wash loads may produce a thumping sound. This is usually normal. 	If sound continues, washer is probably out of balance. Stop and redistribute wash load.
Vibrating noise	<ul style="list-style-type: none"> Have all the transit bolts and packing been removed? Are all the feet resting firmly on the ground? Wash load may be unevenly distributed in drum. 	If not removed during installation. Refer to Installation guide for removing transit bolts. Adjusting washing horizontal level. Stop washer and rearrange wash load.
Water leaks	<ul style="list-style-type: none"> Fill hoses or drain hose are loose at tap or washer. House drain pipes are clogged. 	Check and tighten hose connections. Unclog drain pipe. Contact plumber if necessary.
Oversudsing	<ul style="list-style-type: none"> Too much detergent or unsuitable detergent may cause excessive foaming which may result in water leaks. 	It is necessary to decrease the quantity of detergent. The type of detergent should match the washing machine type. Oversudsing may provoke water leaking.
Water does not enter washer or it enters slowly	<ul style="list-style-type: none"> Water supply is not adequate in area. Water supply tap is not completely open. Water inlet hose(s) are kinked. 	Check another tap in the house. Fully open tap. Straighten hose.
Water in the washer does not drain or drains slowly	<ul style="list-style-type: none"> The filter of the inlet hose(s) clogged. Drain hose is kinked or clogged. The drain filter is clogged. 	Check the filter of the inlet hose. Clean and straighten the drain hose. Clean the drain filter.

T

roubleshooting guide

Symptom	Possible Cause	Solution
Washer does not start	<ul style="list-style-type: none"> • Electrical power cord may not be plugged in or connection may be loose. • House fuse blown, circuit breaker tripped, or a power outage has occurred. 	<p>Make sure plug fits tightly in wall outlet.</p> <p>Reset circuit breaker or replace fuse. Do not increase fuse capacity. If problem is a circuit overload, have it corrected by a qualified electrician.</p>
Washer will not spin	<ul style="list-style-type: none"> • Water supply tap is not turned on. • Check that the door is firmly shut. 	<p>Turn on water supply tap.</p> <p>Close the door and press the Start/Pause button. After pressing the Start/Pause button, it may take a few moments before the clothes washer begins to spin. The door must lock before spin can be achieved.</p>
Door does not open		<p>Once started, the door can not be opened for safety reasons. Wait one or two minutes before opening the door to give the electric locking mechanism time to release.</p>
Wash cycle time delayed		<p>The washing time may vary by the amount of laundry, water pressure, water temperature and other usage conditions. If the imbalance is detected or if the suds removing program works, the wash time shall be increased.</p>

Troubleshooting guide

Symptom	Possible Cause	Solution
 ("No water supply")	<ul style="list-style-type: none"> • Water supply is not adequate in area. • Water supply taps are not completely open. • Water inlet hose(s) are kinked. • The filter of the inlet hose(s) are clogged. 	Check another tap in the house. Fully open tap. Straighten hose(s). Check the filter of the inlet hose.
 ("Not draining")	<ul style="list-style-type: none"> • Drain hose is kinked or clogged. • The drain filter is clogged. 	Clean and straighten the drain hose. Clean the drain filter.
 ("No spinning")	<ul style="list-style-type: none"> • Load is too small. • Load is out of balance. • The appliance has an imbalance detection and correction system. If individual heavy articles are loaded (ex. bath mat, bath robe, etc.) this system may stop spinning or even interrupt the spin cycle altogether. 	Add 1 or 2 similar items to help balance the load. Rearrange load to allow proper spinning. If the laundry is still too wet at the end of the cycle, add smaller articles of laundry to balance the load and repeat the spin cycle.
 ("Door open")	 <ul style="list-style-type: none"> • Is the door opened? 	Close the door. If "dE" is not released, call for service.
 	<ul style="list-style-type: none"> • The thermistor is out of order. 	Unplug the power plug and call for service.
 	<ul style="list-style-type: none"> • Water overfills due to the faulty water valve. 	Close the water tap. Unplug the power plug. Call for service.
 	<ul style="list-style-type: none"> • Water level sensor has malfunctioned. 	
 	<ul style="list-style-type: none"> • Over load in motor. 	
 	<ul style="list-style-type: none"> • Over load in motor. 	
 	<ul style="list-style-type: none"> • The washer experienced a power failure. 	Restart the cycle.

Terms of Warranty

DISPOSAL OF YOUR OLD APPLIANCE

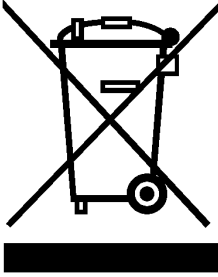

1. When this crossed-out wheeled bin symbol is attached to a product it means the product is covered by the European Directive 2002/96/EC.
2. All electrical and electronic products should be disposed of separately from the municipal waste stream via designated collection facilities appointed by the government or the local authorities.
3. The correct disposal of your old appliance will help prevent potential negative consequences for the environment and human health.
4. For more detailed information about disposal of your old appliance, please contact your city office, waste disposal service or the shop where you purchased the product.

What Is Not Covered:

- Service trips to your home to teach you how to use the product.
- If the product is connected to any voltage other than that shown on the rating plate.
- If the fault is caused by accident, neglect, misuse or Act of God.
- If the fault is caused by factors other than normal domestic use or use in accordance with the owner's manual.
- Provide instruction on use of product or change the set-up of the product.
- If the fault is caused by pests for example, rats or cockroaches etc..
- Noise or vibration that is considered normal for example water drain sound, spin sound, or warming beeps.
- Correcting the installation for example, levelling the product, adjustment of drain.
- Normal maintenance which recommended by the owner's manual.
- Removal of foreign objects / substances from the machine, including the pump and inlet hose filter for example, grit, nails, bra wires, buttons etc.
- Replace fuses in or correct house wiring or correct house plumbing.
- Correction of unauthorized repairs.
- Incidental or consequential damage to personal property caused by possible defects with this appliance.
- If this product is used for commercial purpose, it is not warranted.
(Example: Public places such as public bathroom, lodging house, training center, dormitory)
- If the product is installed outside the normal service area, any cost of transportation involved in the repair of the product, or the replacement of a defective part, shall be borne by the owner.



LG Electronics Inc.