



Owner's Manual

F1403YD(1~9)



Before use please read carefully the safety instructions!

Thank you for buying an LG fully automatic washing machine. It provides instructions on safe installation, use and maintenance. Keep it handy for future reference of this machine. Make a note of the model and serial numbers of your washing machine.

For the U.K. customer
CUSTOMER SERVICES Tel. : +44-(0) 844 847 LGLG(5454) Fax. : +44-(0) 844 847 1413
LGEUK SERVICE WEB-SITE : <http://www.lge.co.uk>

P/No.: MFL6283846

Troubleshooting

	<ul style="list-style-type: none"> Water supply is not adequate in area Water supply taps are not completely open. Water inlet hose(s) are kinked. The filter of the inlet hose(s) are clogged. 	<p>Check another tap in the house. Fully open tap.</p> <p>Straighten hose(s). Check the filter of the inlet hose(s).</p>
	<ul style="list-style-type: none"> Drain hose is kinked or clogged. The drain filter is clogged. 	<p>Clean and straighten the drain hose. Clean the drain filter. For more detailed information, please refer to "Cleaning the drain pump filter"</p> <p>Add 1 or 2 similar items to help balance the load. Rearrange load to allow proper spinning</p>
	<ul style="list-style-type: none"> Load is too small. Load is out of balance. The appliance has an unbalance detection and correction system. If individual heavy articles are loaded (ex. bath mat, both robe, etc.), this system may stop spinning or even interrupt the spin cycle altogether. If the laundry is still too wet at the end of the cycle, add smaller articles of laundry to balance the load and repeat the spin cycle. Floor is unstable. Feet are not adjusted 	<p>The floor should be a solid surface. Adjust the feet so that the machine does not rock from side to side or front to back.</p>
	<ul style="list-style-type: none"> Is the door opened or not completely closed? 	<p>Close the door completely. * If the "dE" does not clear, call for service.</p>
		<p>Unplug the power plug and call for service.</p>
	<ul style="list-style-type: none"> Water overfills due to the faulty water valve. 	<p>Close the water tap. Unplug the power plug. Call for service.</p>
	<ul style="list-style-type: none"> Water level sensor has malfunctioned. 	
	<ul style="list-style-type: none"> Over load in motor. 	
	<ul style="list-style-type: none"> The washer experienced a power failure. 	<p>Restart the cycle.</p>
	<ul style="list-style-type: none"> Check water supply. 	<p>Turn the tap on. * If "dHE" is not released, unplug power plug and call for service.</p>

Rattling and clanking noise	Extraneous objects such as coins or safety pins maybe in drum or pump.
Thumping sound	Heavy wash loads may produce a thumping sound. This is usually normal.
Vibrating noise	Have all transit bolts and packing been removed?
Water leaks.	Check and tighten hose connections. Unclog drain pipe. Contact plumber if necessary.
Excessive suds	Too much detergent or unsuitable detergent.
Washing machine does not start	Power cord may not be plugged in or connection may be loose.
Washing machine won't spin	Check that the door is shut. Check that foreign objects may be blocking the drain causing the water not to drain out. Once started, the door can not be opened for safety reasons. At the end of the cycle or when Start/Pause is pressed, wait one or two minutes before opening the door to allow the electric locking mechanism time to release.
Door does not open	

Safety instructions for the installation

Install or store the appliance where it will not be exposed to sub-zero temperatures or exposed to the weather. Fit the power plug to a grounded wall socket that complies with all statutory regulations and ordinances. Ensure that the base opening is free from obstruction by carpeting if the washing machine is installed on a carpeted floor. In countries where there is a risk of cockroach infestation or other vermin, pay particular attention to keep the appliance and its surroundings in a clean condition at all times. Any damage which may be caused by cockroaches or other vermin is not covered by the appliance guarantee.

CAUTION about positioning the appliance
Install the washing machine on a flat hard floor. Make sure that air circulation around the washing machine is not impeded by carpets, rug etc.

- Never try to correct any unevenness in the floor using pieces of wood, cardboard or similar materials under the washing machine.
- If it is not possible to position the washing machine away from a gas cooker or coal burning stove, an insulation panel (85x60cm) covered with aluminum foil on the side facing the cooker or stove, must be inserted between the two appliances.
- The washing machine must not be installed in rooms where the temperature may drop below 0°C.
- Please ensure that when the washing machine is installed, that a Service Technician can gain easy access in the event of a breakdown.
- Adjust all four feet using the transit bolt spanner provided to ensure that the appliance is stable, with 20mm clearance between the top of the washing machine and underside of the worktop.

CAUTION about the power cord
We recommend connecting most appliances to a dedicated circuit which is protected by a mains fuse. That is, a single outlet supplying power only to the appliance concerned, without any additional outlets or branch circuits. Check the specifications of this owner's manual. Do not overload wall sockets. Overloaded wall sockets, loose or damaged wall sockets or extension cords, frayed power cords, damaged or cracked wire insulation are dangerous. Any of these conditions could result in electric shock or fire. Periodically examine the cord of your appliance, and if its appearance indicates damage or deterioration, unplug it, discontinue use of the appliance, and have the cord replaced with an exact replacement part by an authorized servicer. Protect the power cord from physical or mechanical abuse, such as being twisted, kinked, pinched, squashed in a jamb of a door, or walked upon. Pay particular attention to plugs, wall outlets, and the point where the cord exits the appliance.

CAUTION about location and moving
This equipment is not designed for maritime use or for use mobile installations such as caravans, aircraft etc. Turn off the stopcock if the machine is to be left for any length of time (e.g. if you are going on holiday), especially if there is no floor drain (gully) in the immediate vicinity. If relocating the appliance use the original packing material. Packaging material (e.g. plastic film, Styrofoam) can be dangerous for children. There is a risk of suffocation! Keep all packaging well away from children and do not allow children to play inside the bowl as they may become trapped.

CAUTION about the floor surface

- The installation surface must be clean, dry and level.
- Install washing machine on a flat hard floor. Poorly constructed timber base floors can contribute to excessive noise and vibration.
- Proper placement and levelling of the washing machine ensure long, regular and reliable operation.
- The washing machine must be perfectly level and firmly in position.
- It must not "see-saw" across corners under load.
- The installation surface must be clean, free from floor wax and other lubricant coatings.
- Do not allow the feet of the washing machine to get wet. If feet of the washing machine get wet, slipping may occur.

Technical Specification

Name of product	Front loading washing machine	Max. Watt	2100 W (Wash) / 1500 W (Dry)
Power supply	220-240 V~, 50 Hz	Capacity	Refer to the Rating Label
Size WxDxH mm:	600 x 640 x 850	Water consumption	90 ℓ
Weight	72 kg	Permissible water pressure	1.0-10 bar (100-1000kPa)

Safety instructions for use

Read all instructions and explanations of the installation before use. Follow the instructions carefully. Keep the operating instructions handy for later use. If the appliance is sold or passed on then ensure that the new owner always receives these operating instructions. The following warnings must be strictly observed for safety reasons. They must be read before installing the appliance and putting it into operation.

- Intended use: This appliance has been designed exclusively for use in dry-*interior* households. Use the appliance only with cold drinking water and only for washing textiles with washing detergents designed for washing machines. Every other use is improper and may lead to injuries, whereby the liability of the manufacturer will cease.
- This appliance may only be used by adults. Do not allow children to touch the controls or to play with the product.
- Never modify the appliance on your own, as this is dangerous.
- This appliance is heavy. Transporting with care.
- Remove all packaging and transport bolts before using the appliance. Otherwise serious damage may result.
- All installation work must be carried out by a qualified fitter or technician.
- Have electrical connections done by a qualified electrician.
- Never place the appliance on the power cord.
- If the appliance is placed on a carpet then place the feet so that air can circulate underneath the appliance.
- Always unplug the machine and turn off the water supply after use. Disconnect appliance by pulling only the plug - never disconnect by pulling the power cord. Never touch the plug with wet fingers or hands.
- Do not overload the appliance.
- Wash only machine-washable textiles. If you have doubts regarding this, then observe the markings on the label.
- Never place electrical heaters, candles etc. in the vicinity of the appliance. They could cause the appliance to ignite or parts to warp.
- Protect the appliance from wet and damp. Otherwise, there is danger of electric shock and fire.
- Connect the appliance to a suitable wall socket for 220-240V. Never use an extension cord or double adapter.
- Empty all pockets. Hard or sharp objects such as coins, needles, nails, screws or stones may cause serious damage. Unbalanced mass may create heavy vibrations. If heavy vibrations remain also without load, call for an authorized customer service.
- Do not wash or dry articles that have been cleaned in, washed in, soaked in, or dabbed with combustible or explosive substances (such as wax, oil, paint, gasoline, degreasers, dry-cleaning solvents, kerosene, etc.). This may result in fire or explosion.
- Never insert products coated with mineral oils (e.g. nylon coating, plastic belts, etc.) into the machine. If a stain remover has been used then make sure that the solvent has been carefully washed out before inserting the clothes into the appliance. Oil may remain in the tub after a whole cycle resulting in fire during drying. So, do not load oily clothes.
- Do not operate the appliance at locations where flammable substances are present such as oil, benzene or highly inflammable gas. Such materials may cause fire or explosion. Never use combustible detergents.
- Only add the prescribed amount of softener. Excessive amounts may damage the clothes.
- After washing, keep the drum door open to protect the door seal.
- Make sure that all water has run off before opening the door. Never open the door if water still remains. Danger of scalding.
- Animals and children may get into the washing machine. So always check the appliance before using it.
- During washing, the glass door becomes very hot. Keep children away from the appliance when in operation.
- Never try to repair the machine yourself. Incorrect repairs may result in injuries and/or serious defects to the machine.
- The product should be serviced and repaired only by the authorised customer service using original replacement parts.
- When disposing of your old machine, the power cable must be capped and the door lock must be made unusable in order to protect children.
- When placing on a carpeted floor, make sure that the opening in the socket is not blocked.
- If the appliance has been under water then contact the customer service. There is danger of electric shock and fire.
- The cover cup of the filter as well as the dispenser drawer may not be opened during the operation.
- Keep all washing powder and detergents away from children. Danger of poisoning.

Disposal

- When this crossed-out wheeled bin symbol is attached to a product it means the product is covered by European Directive 2002/96/EC.
- All electrical and electronic products should be disposed of separately from municipal waste stream via designated collection facilities appointed by the government or the local authorities.
- The correct disposal of your old appliance will help prevent potential adverse consequences for the environment and human health.
- For more detailed information about disposal of your old appliance, please contact your city office, waste disposal service or the shop where you purchased the product.

Safety instructions for use

To minimize the risk of fire within the inner bowl, the following should be observed:

- Items that have been spotted or soaked with vegetable or cooking oil constitute a fire hazard and should not be placed in a tumble dryer.
- Oil-affected items can ignite spontaneously, especially when exposed to heat sources Such as in a tumble dryer. The items become warm, causing an oxidation reaction in the oil. Oxidation creates heat. If the heat cannot escape, the items can become hot enough to catch fire. Piling, stacking or storing oil-affected items can prevent heat from escaping and so create a fire hazard.
- If it is unavoidable that fabrics that contain vegetable or cooking oil or have been contaminated by hair care products be placed in a tumble dryer they should first be washed in hot water with extra detergent-this will reduce, but not eliminate, the hazard. The 'cool down' cycle of tumble dryers should be used to reduce the temperature of the items. They should not be removed from the tumble dryer or piled or stacked while hot.
- Items that have been previously cleaned in, washed in or spotted with petrol/gasoline, dry-cleaning solvents or other flammable or explosive substances should not be placed in a tumble dryer. Highly flammable substances commonly used in domestic environments include acetone, denatured alcohol, petrol/gasoline, kerosene, spot removers (some brands), turpentine, waxes and wax removers.
- Items containing foam rubber (also known as latex foam) or similarly textured rubber like materials should not be dried in a tumble dryer on a heat setting. Foam rubber materials can, when heated, produce fire by spontaneous combustion.
- Fabric softeners or similar products should not be used during a drying cycle, to eliminate the effects of static electricity unless this practice is specifically recommended by the manufacturer of the fabric softener or product.
- Undergarments that contain metal reinforcements should not be placed in a tumble dryer. Damage to the tumble dryer can result if metal reinforcements come loose during drying. When available a drying rack could be used for such items.
- Plastic articles such as shower caps or babies waterproof napkin covers should not be placed in a tumble dryer.
- Rubber-backed articles, clothes fitted with foam rubber pads, pillows, rubber boots and rubber-coated tennis shoes should not be placed in a tumble dryer.

BS Plug Safety Details (For U.K. User)

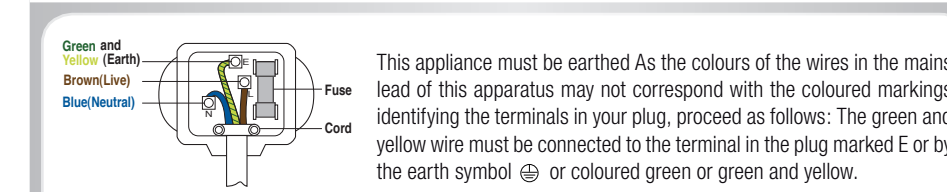

This appliance must be earthed As the colours of the wires in the mains lead of this apparatus may not correspond with the coloured markings identifying the terminals in your plug, proceed as follows: The green and yellow wire must be connected to the terminal in the plug marked E or by the earth symbol or coloured green or green and yellow.

The wire coloured blue must be connected to the terminal marked with the letter N or coloured black. The wire coloured brown must be connected to the terminal marked with the letter L or coloured red. If a 13 amp (BS 1363) plug is used, fit a 13 amp BS 1362 fuse.

Cleaning and Maintenance

Warning: Before cleaning the washing machine interior, unplug the electrical power cord to avoid the risk of electric shock.

Cleaning the water inlet filter

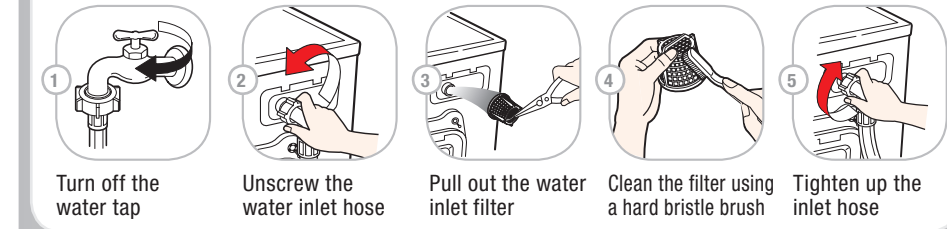

Cleaning the drain pump filter

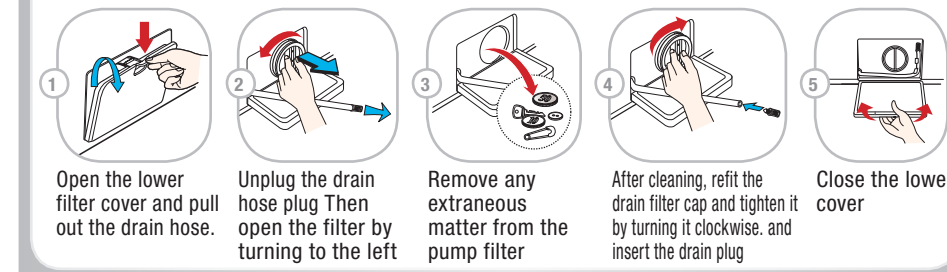

Cleaning the dispenser drawer

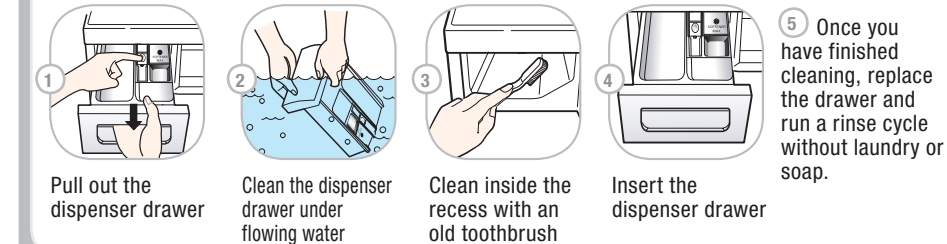

Cleaning in general

Important: Do not use methylated spirits, solvents or similar products.

Exterior
Proper care of your washing machine can extend its service life. The outside of the machine can be cleaned with warm water and a neutral non-abrasive household detergent. Immediately wipe off any spillage. Wipe with damp cloth. Avoid striking the surface with sharp objects. Never hose down the machine!

Interior
Dry around the washing machine door opening, flexible gasket and door glass. Run washing machine through a complete cycle using hot water. Repeat process if necessary.

Electrical connection

- Do not use an extension cord or double adapter.
 - Have damaged supply cords replaced by the manufacturer or its service agents or a similarly qualified person to prevent danger.
 - Always unplug the machine and turn off the water supply after use.
 - Connect the machine to an earthed socket in accordance with current wiring regulations.
 - The appliance must be positioned so that the plug is easily accessible.
- Repairs to the washing machine must only be carried out by qualified personnel. Repairs carried out by inexperienced persons may cause injury or serious malfunctioning. Contact your local service centre.
 - Do not install your washing machine in rooms where temperature below freezing may occur. Frozen hoses may burst under pressure. The electronic control unit may become unreliable at temperatures below freezing point.
 - If the appliance is delivered in the winter months and temperatures are below freezing: Leave the washing machine standing at room temperature for a few hours before putting it into operation.

CAUTION

- The hose supplied with the machine must be used.
- Old hoses may not be reused.
- The appliance is not intended for use by young children or infirm persons without supervision.
- Young Children should be supervised to ensure that they do not play with appliance.

Installation of drain hose

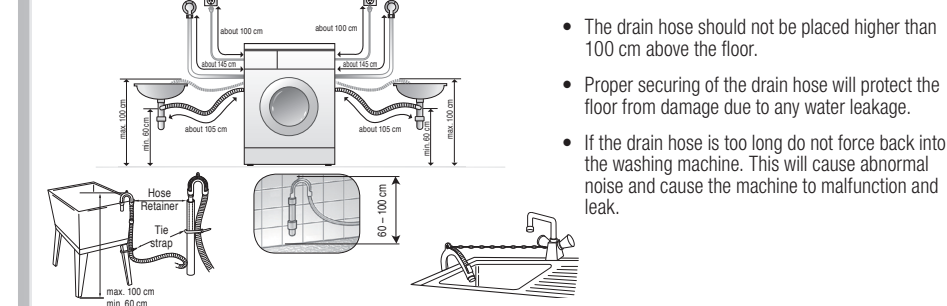

Level adjustment

- Proper level-adjustment of the washing machine prevents excessive noise and vibration. Install the appliance on a solid and level floor surface, preferably in a corner of the room.
- If the floor is uneven, adjust feet as required. (Do not insert pieces of wood etc. under the feet). Make sure that all four feet are stable and resting on the floor. Then check that the appliance is perfectly level. (Use a spirit level).

Wooden floors (Suspended floors)

- Wooden floors are particularly susceptible to vibration.
- To prevent vibration we recommend you place rubber cups under each foot, at least 15mm thick under the washer, secured to at least 2 floor beams with screws.
- If possible install the washer in one of the corners of the room, where the floor is more stable.
- Insert the rubber cups to reduce vibration.
- You can obtain the rubber cups from the LG spares dept.

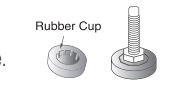



Preparation

CHECKING THE MACHINE

Never use a defective machine! In case of any failure, first unplug the machine and turn off the water tap.

WATER CONNECTION

Turn on the water tap

HANG UP WASTE WATER HOSE

Hose elbow connection e.g. attach to water tap

INSERT PLUS INTO THE MAINS SOCKET

Never touch the plug with wet hands! Never remove the plug from the socket by pulling on the cord.

DOING LAUNDRY AND USING MACHINE WITH CARE

- empty all pockets
- remove all metal parts
- place the delicate textiles into the laundry net
- close zippers

LAUNDRY WITH DIFFERENT AMOUNTS OF SOILING

- lightly - wash new textiles separately
- medium - do not prewash
- heavily - pretreat dirty spots
- pre wash

WATER TREATMENT

- with hardness III water
- use water softening agent

DRUM CARE

- remove extraneous objects
- leave door open to dry the drum
- check the rubber seals regularly

ECOLOGICAL WASHING

- make use of the max. washing quantity
- do not "pre wash" if possible
- use short program if possible

Washing symbols

- Washing temperature
- Medium hot ironing
- Do not tumble dry
- Dry flat
- Do not wash
- Hot ironing
- Hang to dry
- Do not bleach
- Luke warm ironing
- Do not iron
- Drip dry
- Handy to bleach

Dispenser drawer

- A Pre Wash**
The Pre wash compartment can be used for Normal to heavy soiled clothes, by adding a prewash or normal detergent to this compartment before selecting this wash option with the Cycle.
- B Main Wash**
For Laundry requiring detergent, place recommended dosage in to this compartment. Please note that liquid detergent will enter the tub as it is poured and may not be suitable for a delay start.
- C Softener**
Do not exceed the MAX-Level. Highly dosed softeners are to be diluted with some water. Excessive softener can cause brown or grey spotting on the clothes.

Washing program table

Program	Fabric Type	Water Temp. (Option)	Option	Dry (Option)	Maximum Load
Cotton	Color fast garments (shirts, nightdresses, pajamas...and lightly soiled white cotton (underwear))	60°C (Cold, 30°C, 40°C, 95°C)	- Time Delay - Intensive - Medic Rinse		Rating
Cotton Quick	Lightly soiled clothing and small loads	40°C (Cold, 30°C, 60°C)	- Pre Wash - Rinse+ - Rinse+Spin		Less than 7 kg
Synthetic	Polyamide, Acrylic, Polyester	60°C (40°C, 95°C)	- Rinse+ - Normal+Hold	- Low Temp. - Iron Dry - Cupboard Dry - Eco Dry - Time	Less than 4.5 kg
Baby Care	Lightly soiled baby wear	60°C (40°C, 95°C)	- Time Delay - Intensive - Medic Rinse - Pre Wash - Rinse+ - Rinse+Spin		Less than 4 kg
Wash+Dry (4kg/4kg)	A small amount of laundry which can be dried.	60°C (Cold, 30°C, 40°C, 95°C)	- Time Delay - Intensive - Medic Rinse - Pre Wash - Rinse+ - Rinse+Spin		Less than 2 kg
Quick 30	Colored laundry which is lightly soiled fast	30°C (Cold, 40°C)	- Time Delay - Intensive - Rinse+ - Rinse+Spin - Normal+Hold		1 single size
Delicate	Delicate laundry easily damaged	40°C (Cold, 30°C)			
Hand Wash / Wool	"Hand wash" marked delicate and wool laundry				
Duvet	Cotton bedding with filling duvet, pillow, blanket, sofa cover with light filling				

Water Temperature: Select water temperature to suit wash cycles. Always follow garment manufacturer's care label or instructions when washing.

Intensive: If the laundry is heavily soiled "Intensive" option is effective.

Pre Wash: If the laundry is heavily soiled, "Pre Wash" Cotton is recommended.

Pre Wash is available in the Cotton, Cotton Quick, Synthetic, Baby Care and Wash+Dry (4kg/4kg) programs.

Rinse+ : Used to introduce an additional rinse, which may assist in removing traces of detergent residue.

Medic Rinse: For best results or for cleaner rinsing, you can choose this heated Rinse option. Medic Rinse is automatically selected on Baby Care program.

Notes
Neutral detergent is recommended. The wool cycle features gentle tumbling and low-speed spin for garment care.

Warning: Keep all washing powder and detergents away from children. Danger of poisoning

Sort the laundry
note washing instruction symbols - Degree of soiling - Type of textile / colour -

Loading the Drum
Check the folds of the flexible gasket (grey) - and remove any small articles or foreign objects that may have fallen from items in the previous wash - Check all garments for loose items before loading and ensure that clothes are clear of the door gasket before closing the door so that the clothes or door gasket are not damaged during the wash.

Fill detergent
Refer to the written information on the detergent's packaging

Turn the machine ON
by pressing the Power button

Select a Program

Select an Option
Pre Wash / Rinse+Spin / Rinse+ / Normal+Hold

Select Spinning speed and Washing temperature

Select the Dry mode

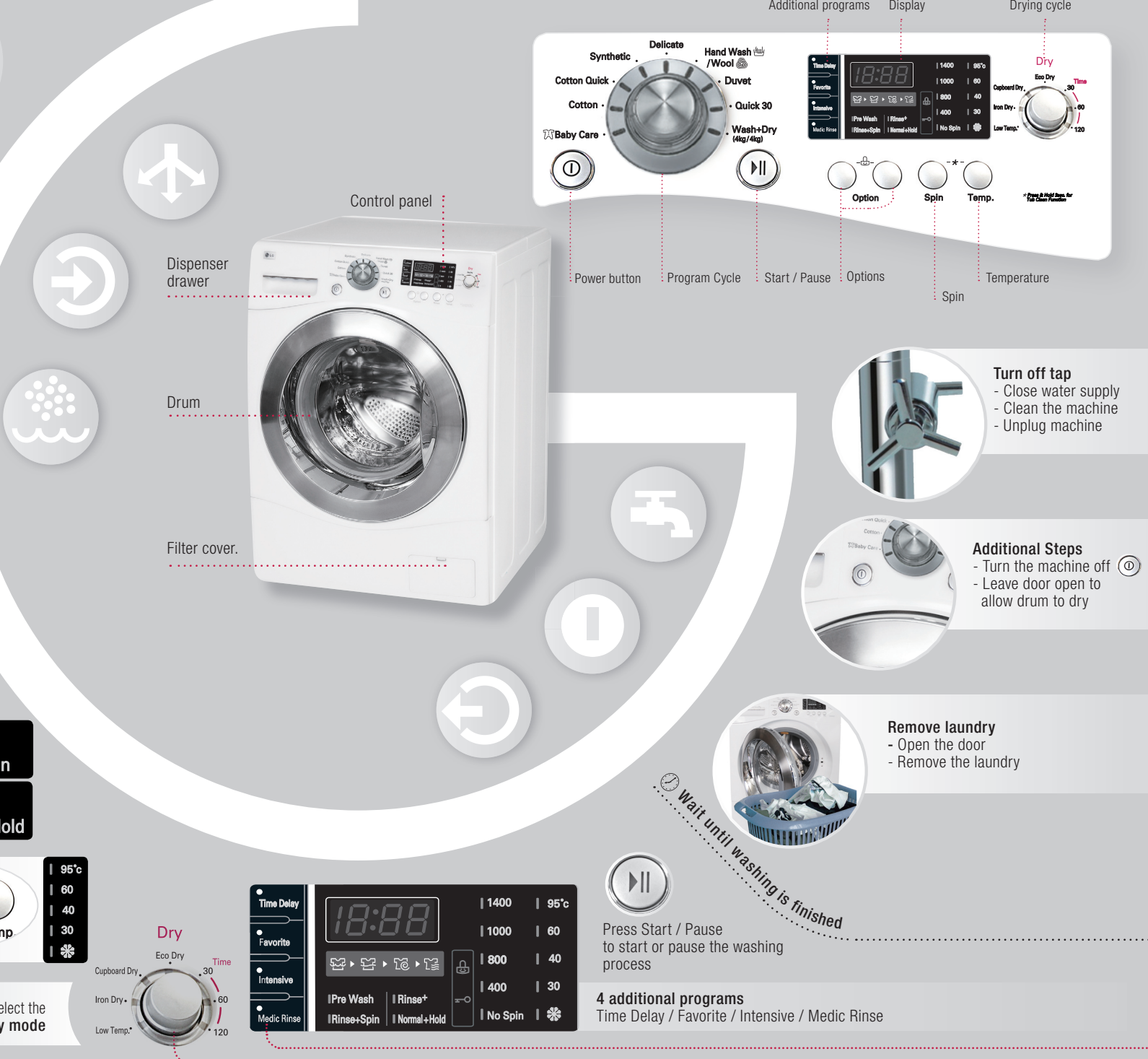

Additional programs

Time Delay

Allows you to set the cycle's ending time (by hourly increments) in advance.

How to set "Time Delay"

- Press **Power** button.
- Turn the **Program** dial to select the program you require.
- Press **Time Delay** button and set the finishing time. The machine will then automatically work out the turn on time based on the chosen cycle.
- Press the **Start/Pause** button.

Favorite

- Favorite program allows you to store a customized wash cycle for future use.

- To make a Favorite program:

- Select a cycle.
- Select the course, washing method, number of rinses, spin speed, water temperature etc.
- Press and hold Favorite program button 3 seconds (2 beep sounds). The Favorite program is now stored for future use.

To reuse the program, select Favorite program and press Start/Pause.

Intensive

If the laundry is heavily soiled "Intensive" option is effective.

- By selecting the Intensive option, the washing duration may be extended, depending on the program selected.
- To use this option, press the intensive button once before the wash program is started.

Medic Rinse

For best results or for cleaner rinsing, select the "Medic Rinse" option.

This allows the final rinse to be heated to 40 degrees.

Available in the Cotton, Cotton Quick, Synthetic, Baby Care and Wash+Dry (4kg/4kg) programs. Medic Rinse is set by default in the Baby Care program. The respective temperature indicator will light up.

Dry

Cold water tap must be left on during drying cycles.

- This washer-dryer's automatic process from washing to drying can be selected easily.
- For most even drying, make sure all articles in the clothes load are similar in material and thickness.
- Do not overload dryer by stuffing too many articles into drum. Items must be able to tumble freely.
- If you open door and remove load before dryer has finished its cycle, remember to press the Start/Pause button.
- By turning the DRY dial, you can select :
Cupboard Dry - Eco Dry - 30 - 60 - 120 - Low Temp. - Iron Dry
- After the end of dry, "Cd" is displayed. By pressing the "Start/Pause" button the program can be ended. If you not press the "Start/Pause" button, the program is ended after about 4 hours. "Cd" Cooling Cycle.

1. Drying Automatic guide

- Use your Automatic Cycles to dry most loads. Electronic sensors measures the temperature of the exhaust to increase or decrease drying temperatures for faster reaction time and tighter temperature control.
- Recommend Automatic drying course as a kind of clothes.
 - Low Temp. : For Synthetics select
 - Iron Dry : If you want to iron clothes
 - Cupboard Dry : For Cottons select
 - Eco Dry : A special cycle to reduce water usage during the dry cycle.
 - Time (30/60/120 minutes) - 30 min. : Cotton 1.5 kg - 60 min. : Cotton 3 kg - 120 min. : Towel 5 kg

Note: The estimated drying time varies from the actual drying time with an Automatic. The type of fabric, size of the load, and the dryness selected affect drying time.

Note: The last 6 minutes of drying time, A sensor (Thermistor) detects clothes drying conditions. When the dryness is low, cycle time will be added by max. 30 mins with "6" mins remaining window display.

2. Drying time guide

- By turning the DRY dial, the drying time can be selected.
- Drying course can last up to 150min. When selecting drying only, drying course will start after spinning.
- These drying times are given as a guide to help you set your dryer for manual drying. Drying times can vary greatly depending on dampness, room temperature and type of fabric and your own experience will be your best guide.

Woolen Articles

- Do not tumble dry woolen articles. Pull them to their original shape and dry them flat.

Woven and Loopknit Materials

- Some woven and loopknit materials may shrink, by varying amounts, depending on their quality.
- Always stretch them out immediately after drying.

Permanent Press and Synthetics

- Do not overload your dryer
- Take out permanent press articles as soon as the dryer stops to reduce wrinkles.

Fiber or Leather Materials

- Always check the manufacturer's instructions.

3. Completion of Drying

- When drying cycle is completed, "Cd" [Cool Down] is displayed on the Multi display.
- The Cool Down is setting automatically when a drying cycle is complete.
- When you are not remove a load of clothes from the dryer as soon as it stops, wrinkles can form.
- The Cool Down operating periodically tumbles, rearranges and fluffs the load to tumbles, rearranges and fluffs the load to hours.
- The "Cd" message will continue to display until the clothes are removed or the Start/Pause button is pressed.

Child Lock

Select this function to lock the buttons on the control panel and to prevent tampering.

Change to the desired program, whilst in child lock mode:

- To activate: press and hold the Option buttons simultaneously until "CL" appears in the display.
- To deactivate: press and hold the Option buttons simultaneously for 3 seconds until the "CL" is removed from the display.
- Press and hold the Option buttons simultaneously
- Press Start/Pause
- Select the desired program
- Press Start/Pause

Tub Clean

TUB CLEAN is special cycle to clean the inside of the washing machine. A higher water level is used in this cycle at higher spin speed. Perform this cycle regularly.

- Empty the drum completely and close the door
- Add anti-limescale (Calgon) to the main wash compartment. Close the disp. drawer
- Power ON with Spin Temp. button
- Press the Start/Pause button to start Tub Clean process
- After the cycle is complete, leave the door open to dry

Beep on / off

The Beep on/off function can be set only during the washing cycle. To set the Beep On/Off function follow the below steps.

- Turn on the washing machine (by pressing the Power button).
- Press the Start/Pause button.
- Press and hold the Option and Spin button simultaneously for three seconds to set Beep on/off function.

Once the Beep on/off function is set, the setting is memorized even after Power is off.