



Owner's Manual

F1403ND(P)(1-9)
F1203ND(P)(1-9)
F1003ND(P)(1-9)



Before use please read carefully the safety instructions!

Thank you for buying an LG fully automatic washing machine. Please read this owner's manual carefully, it provides instructions on safe installation, use and maintenance. Keep it handy for future reference of this machine. Make a note of the model and serial numbers of your washing machine.

Troubleshooting

	<ul style="list-style-type: none"> Water supply is not adequate in area Water supply taps are not completely open. Water inlet hose(s) are kinked. The filter of the inlet hose(s) are clogged. 	<p>Check another tap in the house.</p> <p>Fully open tap.</p> <p>Straighten hose(s).</p> <p>Check the filter of the inlet hose(s).</p>
	<ul style="list-style-type: none"> Drain hose is kinked or clogged. The drain filter is clogged. 	<p>Clean and straighten the drain hose.</p> <p>Clean the drain filter.</p> <p>For more detailed information, please refer to "Cleaning the drain pump filter"</p>
	<ul style="list-style-type: none"> Load is too small Load is out of balance. The appliance has an unbalance detection and correction system. If individual heavy articles are loaded (ex. bath mat, both robe, etc.), this system may stop spinning or even interrupt the spin cycle altogether. If the laundry is still too wet at the end of the cycle, add smaller articles of laundry to balance the load and repeat the spin cycle. 	<p>Add 1 or 2 similar items to help balance the load.</p> <p>Rearrange load to allow proper spinning</p>
	<ul style="list-style-type: none"> Is the door opened or not completely closed? 	<p>Close the door completely.</p> <p>* If "dE" is not released, call for service.</p>
		<p>Unplug the power plug and call for service.</p>
	<ul style="list-style-type: none"> Water overfills due to the faulty water valve. 	<p>Close the water tap.</p> <p>Unplug the power plug.</p> <p>Call for service.</p>
	<ul style="list-style-type: none"> Water level sensor has malfunctioned. 	
	<ul style="list-style-type: none"> Over load in motor. 	
	<ul style="list-style-type: none"> The washer experienced a power failure. 	<p>Restart the cycle.</p>

Rattling and clanking noise	Extraneous objects such as coins or safety pins maybe in drum or pump.
Thumping sound	Heavy wash loads may produce a thumping sound. This is usually normal.
Vibrating noise	Have all transit bolts and packing been removed?
Water leaks.	Check and tighten hose connections. Unclog drain pipe. Contact plumber if necessary.
Excessive suds	Too much detergent or unsuitable detergent.
Washing machine does not start	Power cord may not be plugged in or connection may be loose.
Washing machine won't spin	Check that the door is firmly shut.
Door does not open	Once started, the door can not be opened for safety reasons. Wait one or two minutes before opening the door to allow the electric locking mechanism time to release.

Safety instructions for use

Read all instructions and explanations of the installation before use. Follow the instructions carefully. Keep the operating instructions handy for later use. If the appliance is sold or passed on then ensure that the new owner always receives these operating instructions. The following warnings must be strictly observed for safety reasons. They must be read before installing the appliance and putting it into operation.

- Intended use: This appliance has been designed exclusively for use in dry-interior households. Use the appliance only with cold drinking water and only for washing textiles with washing detergents designed with washing machines. Every other use is improper and may lead to injuries, whereby the liability of the manufacturer will cease.
- This appliance may only be used by adults. Do not allow children to touch the controls or to play with the product.
- Never modify the appliance on your own, as this is dangerous.
- This appliance is heavy. Transporting with care.
- Remove all packaging and transport bolts before using the appliance. Otherwise serious damage may result.
- All installation work must be carried out by a qualified fitter or technician.
- Have electrical connections done by a qualified electrician.
- Never place the appliance on the power cord.
- If the appliance is placed on a carpet then place the feet so that air can circulate underneath the appliance.
- Always unplug the machine and turn off the water supply after use. Disconnect appliance by pulling only the plug - never disconnect by pulling the power cord. Never touch the plug with wet fingers or hands.
- Do not overload the appliance.
- Wash only machine-washable textiles. If you have doubts regarding this, then observe the markings on the label.
- Never place electrical heaters, candles etc. in the vicinity of the appliance. They could cause the appliance to ignite or parts to warp.
- Protect the appliance from wet and damp. Otherwise, there is danger of electric shock and fire.
- Connect the appliance to a suitable wall socket for 220-240V. Never use an extension cord or double adapter.
- Empty all pockets. Hard or sharp objects such as coins, needles, nails, screws or stones may cause serious damage. Unbalanced mass may create heavy vibrations. If heavy vibrations remain also without load, call for an authorized customer service.
- Do not wash or dry articles that have been cleaned in, washed in, soaked in, or dabbed with combustible or explosive substances (such as wax, oil, paint, gasoline, degreasers, dry-cleaning solvents, kerosene, etc.). This may result in fire or explosion.
- Never insert products coated with mineral oils (e.g. nylon coating, plastic belts, etc.) into the machine. If a stain remover has been used then make sure that the solvent has been carefully washed out before inserting the clothes into the appliance. Oil may remain in the tub after a whole cycle resulting in fire during drying. So, do not load oily clothes.
- Do not operate the appliance at locations where flammable substances are present such as oil, benzene or highly inflammable gas. Such materials may cause fire or explosion. Never use combustible detergents.
- Only add the prescribed amount of softener. Excessive amounts may damage the clothes.
- After washing, keep the drum door open to protect the door seal.
- Make sure that all water has run off before opening the door. Never open the door if water still remains. Danger of scalding.
- Animals and children may get into the washing machine. So always check the appliance before using it.
- During washing, the glass door becomes very hot. Keep children away from the appliance when in operation.
- Never try to repair the machine yourself. Incorrect repairs may result in injuries and/or serious defects to the machine.
- The product should be serviced and repaired only by the authorised customer service using original replacement parts.
- When disposing of your old machine, the power cable must be capped and the door lock must be made unusable in order to protect children.
- When placing on a carpeted floor, make sure that the opening in the socket is not blocked.
- If the appliance has been under water then contact the customer service. There is danger of electric shock and fire.
- The cover cup of the filter as well as the dispenser drawer may not be opened during the operation.
- Keep all washing powder and detergents away from children. Danger of poisoning.

Disposal

- When this crossed-out wheeled bin symbol is attached to a product it means the product is covered by European Directive 2002/96/EC.
- All electrical and electronic products should be disposed of separately from municipal waste stream via designated collection facilities appointed by the government or the local authorities.
- The correct disposal of your old appliance will help prevent potential adverse consequences for the environment and human health.
- For more detailed information about disposal of your old appliance, please contact your city office, waste disposal service or the shop where you purchased the product.

Safety instructions for the installation

Install or store appliance where it will not be exposed to sub-zero temperatures or exposed to the weather. Fit ground of the washing machine correctly to conform with all statutory regulations and ordinances. Ensure that the base opening is free from obstruction by carpeting if the washing machine is installed on a carpeted floor. In countries where there is a risk of cockroach infestation or other vermin, pay particular attention to keep the appliance and its surroundings in a clean condition at all times. Any damage which may be caused by cockroaches or other vermin is not covered by the appliance guarantee.

CAUTION about positioning the appliance

Install the washing machine on a flat hard floor. Make sure that air circulation around the washing machine is not impeded by carpets, rug etc.

- Never try to correct any unevenness in the floor using pieces of wood, cardboard or similar materials under the washing machine.
- If it is not possible to position the washing machine away from a gas cooker or coal burning stove, an insulation panel (85x60cm) covered with aluminum foil on the side facing the cooker or stove, must be inserted between the two appliances.
- The washing machine must not be installed in rooms where the temperature may drop below 0°C.
- Please ensure that when the washing machine is installed an engineer can gain easy access in the event of a breakdown.
- Adjust all four feet using the transit bolt spanner provided to ensure that the appliance is stable, with 20mm clearance between the top of the washing machine and underside of the worktop.

CAUTION about the power cord

We recommend connecting most appliances to a dedicated circuit. That is, a single outlet supplying power only to the appliance concerned, without any additional outlets or branch circuits. Check the specifications of this owner's manual. Do not overload wall sockets. Overloaded wall sockets, loose or damaged wall sockets or extension cords, frayed power cords, damaged or cracked wire insulation are dangerous. Any of these conditions could result in electric shock or fire. Periodically examine the cord of your appliance, and if its appearance indicates damage or deterioration, unplug it, discontinue use of the appliance, and have the cord replaced with an exact replacement part by an authorized service. Protect the power cord from physical or mechanical abuse, such as being twisted, kinked, pinched, squashed in a jamb of a door, or walked upon. Pay particular attention to plugs, wall outlets, and the point where the cord exits the appliance. We recommend to use a residual current operated device in the mains supply

CAUTION about location and moving

This equipment is not designed for maritime use or for use mobile installations such as caravans, aircraft etc. Turn off the stop-cock if the machine is to be left for any length of time (e.g. if you are going on holiday), especially if there is no floor drain (gully) in the immediate vicinity. If relocating the appliance use the original packing material. Disable the door lock to prevent young children becoming trapped inside. Packaging material (e.g. plastic film, Styrofoam) can be dangerous for children. There is a risk of suffocation! Keep all packaging well away from children.

CAUTION about the floor surface

- The installation surface must be clean, dry and level.
- Install washing machine on a flat hard floor.
- Proper placement and levelling of the washing machine ensure long, regular and reliable operation.
- The washing machine must be perfectly level and firmly in position.
- It must not "see-saw" across corners under load.
- The installation surface must be clean, free from floor wax and other lubricant coatings.
- Do not allow the feet of the washing machine to get wet. If feet of the washing machine get wet, slipping may occur.

Technical Specification

Name of product	Front loading washing machine	Max. Watt	1700 W
Power supply	220-240V~, 50Hz	Wash capacity	6 kg
Size WxDxH mm:	600 x 440 x 850	Water consumption	56 l
Weight	60 kg	Permissible water pressure	1.0-10 bar (100-1000kPa)

Installation of drain hose

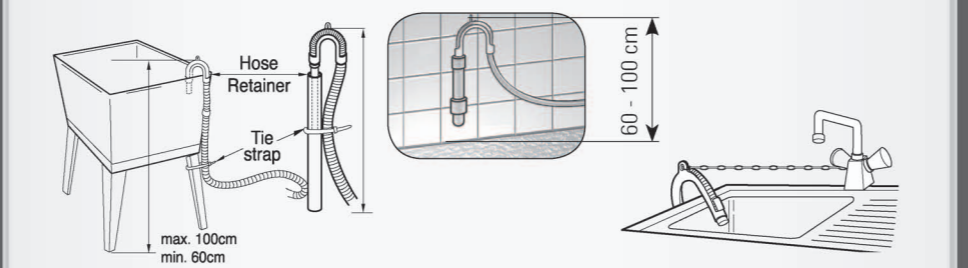
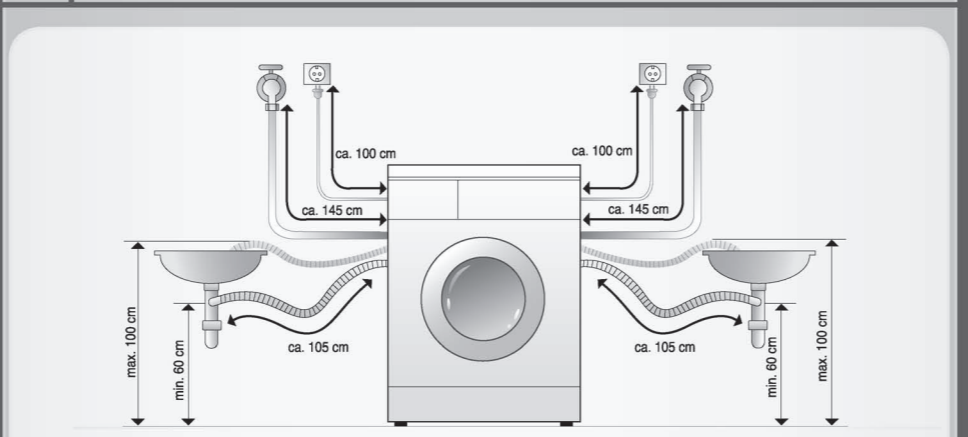

- The drain hose should not be placed higher than 100 cm above the floor.
- Proper securing of the drain hose will protect the floor from damage due to any water leakage.
- If the drain hose is too long do not force back into the washing machine. This will cause unusual noise.

Level adjustment

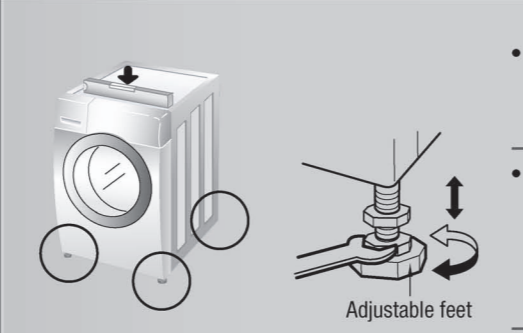

- Proper level-adjustment of the washing machine prevents excessive noise and vibration. Install the appliance on a solid and level floor surface, preferably in a corner of the room.
- If the floor is uneven, adjust feet as required. (Do not insert pieces of wood etc. under the feet). Make sure that all four feet are stable and resting on the floor. Then check that the appliance is perfectly level. (Use a spirit level).

Electrical connection

- Do not use an extension cord or double adapter.
 - Have damaged supply cords replaced by the manufacturer or its service agents or a similarly qualified person to prevent danger.
 - Always unplug the machine and turn off the water supply after use.
 - Connect the machine to an earthed socket in accordance with current wiring regulations.
 - The appliance must be positioned so that the plug is easily accessible.
- Repairs to the washing machine must only be carried out by qualified personnel. Repairs carried out by inexperienced persons may cause injury or serious malfunctioning. Contact your local service centre.
 - Do not install your washing machine in rooms where temperature below freezing may occur. Frozen hoses may burst under pressure. The electronic control unit may become unreliable at temperatures below freezing point.
 - If the appliance is delivered in the winter months and temperatures are below freezing: Leave the washing machine standing at room temperature for a few hours before putting it into operation.

Connecting water supply hose

The hose supplied with the machine must be used. Old hoses may not be reused

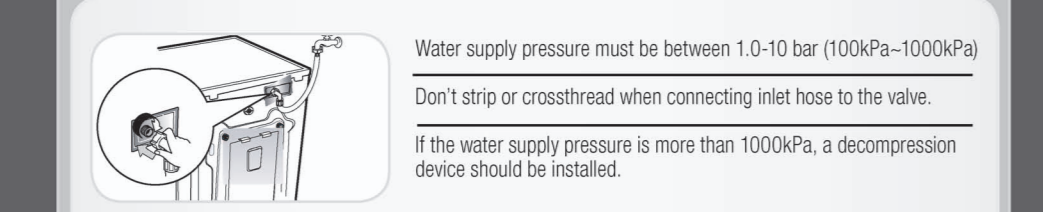

- Water supply pressure must be between 1.0-10 bar (100kPa-1000kPa)
- Don't strip or crossthread when connecting inlet hose to the valve.
- If the water supply pressure is more than 1000kPa, a decompression device should be installed.
- Two rubber seals are supplied with the water inlet hoses. They are used for preventing water leaks.
- Make sure the connection to taps is tight enough.
- Periodically check the condition of the hose and replace the hose if necessary.
- Make sure that there is no kink on the hose and that it is not crushed.

- If after completing connection water leaks from the hose, repeat the same steps. Use the most conventional type of tap for water supply. In case the faucet is square or too big, remove the spacing ring before inserting the tap into the adaptor.

Remove Packaging

-
- The appliance is fitted with transit bolts to prevent internal damage during transport. Be careful, heavy load!
 - Packing and all transit bolts must be removed before using the washing machine.
 - When unpacking the base, be sure to remove the additional packing support in the middle of the base packing.
- Store original packing for future move. Dispose of packing material according to local regulations.

Transit bolts

- To prevent internal damage during transport, the special 4 bolts are locked. If they are not removed, it may cause heavy vibration, noise and machine to malfunction.
- Remove the 4 bolts along with the rubber bungs by slightly twisting the bung.

- Unscrew the 4 bolts using the spanner supplied.
- Close the holes with the caps supplied.

Keep the 4 bolts and the spanner for the future use. Refit transit bolts before transporting the appliance.

Requirements for installation site

-
- Level floor:** Permissible floor gradient under entire washing machine is 1°.
 - Power socket:** Must be within 100 cm of either side of location of washing machine. Do not overload the socket with more than one appliance.
 - Additional Clearance:** For wall, floor and door space is needed. (10cm: rear / 2cm:right & left side). Do not place or store laundry products on top of the washing machine at any times. They can damage the finish or controls of the machine.

Preparation

CHECKING THE MACHINE

Never use a defective machine! In case of any failure, first unplug the machine and turn off the water tap.

WATER CONNECTION

Turn on the water tap.

HANG UP WASTE WATER HOSE

Hose elbow connection e.g. attach to water tap

INSERT PLUS INTO THE MAINS SOCKET

Never touch the plug with wet hands!
Never remove the plug from the socket by pulling on the cord.

DOING LAUNDRY AND USING MACHINE WITH CARE

- empty all pockets
- remove all metal parts
- place the delicate textiles into the laundry net
- close zippers

LAUNDRY WITH DIFFERENT AMOUNTS OF SOILING

- lightly wash new textiles separately
- do not prewash
- heavily pretreat dirty spots
- pre wash

WATER TREATMENT

- with hardness III water
- use water softening agent

DRUM CARE

- remove extraneous objects
- leave door open to dry the drum
- check the rubber seals regularly

ECOLOGICAL WASHING

- make use of the max. washing quantity
- do not "pre wash" if possible
- use short program if possible

Washing symbols

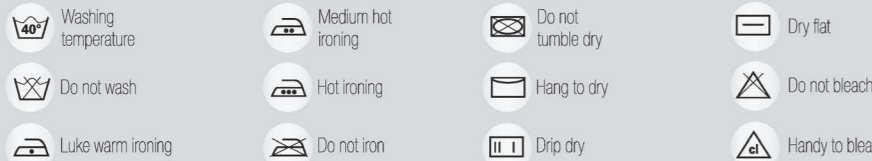

Dispenser drawer

A Main Wash

For very dirty clothes fill 1/4 of the portion of detergent in here and select a prewashing program

B Softener

Do not exceed the MAX-Level. Highly dosed softeners are to be diluted with some water.

C Pre Wash

For normal dirty clothes use a small amount of detergent. Don't pre wash. Mount the level plate to use fluid detergents.

Washing program table

Program	Fabric Type	Water Temp. (Option)	Option	Maximum Load
Cotton	Color fast garments (shirts, nightdresses, pajamas...) and lightly soiled white cotton (underwear)	60°C (Cold, 30°C, 40°C, 95°C)	- Time Delay - Intensive - Soak - Pre Wash - Crease Care - Medic Rinse	6.0kg
Cotton Quick	Lightly soiled clothing and small loads	40°C (Cold, 30°C, 60°C)		Less than 6.0kg
Synthetic	Polyamide, Acrylic, Polyester	60°C (40°C, 95°C)		Less than 3.0kg
Baby Care	Lightly soiled baby wear	60°C (40°C, 95°C)		Less than 4.0kg
Duvet	Cotton bedding with filling duvet, pillow, blanket, sofa cover with light filling	40°C (Cold, 30°C)	- Time Delay - Intensive - Crease Care	1 single size
Delicate	Delicate laundry easily damaged	30°C (Cold, 40°C)		Less than 2.0kg
Hand Wash	"Hand wash" marked delicate and wool laundry	40°C (Cold, 30°C)		
Wool	Machine washable woolsens with pure new wool only	40°C (Cold, 30°C)		
Quick 30	Colored laundry which is lightly soiled fast	30°C (Cold, 40°C)		

Water Temperature: Select water temperature to suit wash cycles. Always follow garment manufacturer's care label or instructions when washing.

Intensive: If the laundry is heavily soiled "Intensive" option is effective.

Set program at "Cotton 60°C + Intensive" option for test in accordance or in conformity with IEC60456 and EN60456.

Pre Wash: If the laundry is heavily soiled, "Pre Wash" Cotton is recommended. Pre Wash is available in the Cotton, Cotton Quick, Synthetic and Baby Care program.

Crease Care: If you want to prevent creasing, select Crease Care option.

Medic Rinse: For best results or for cleaner rinsing, you can choose Medic Rinse option. Medic Rinse is set by default in the Baby Care program.

The wool wash cycle of this machine has been approved by Woolmark for the washing of machine washable Woolmark products provided that the products are washed according to the instructions on the garment label and those issued by the manufacturer of this washing machine M0808.

Neutral detergent is recommended. The wool cycle features gentle tumbling and low-speed spin for garment care.

Warning: Keep all washing powder and detergents away from children. Danger of poisoning

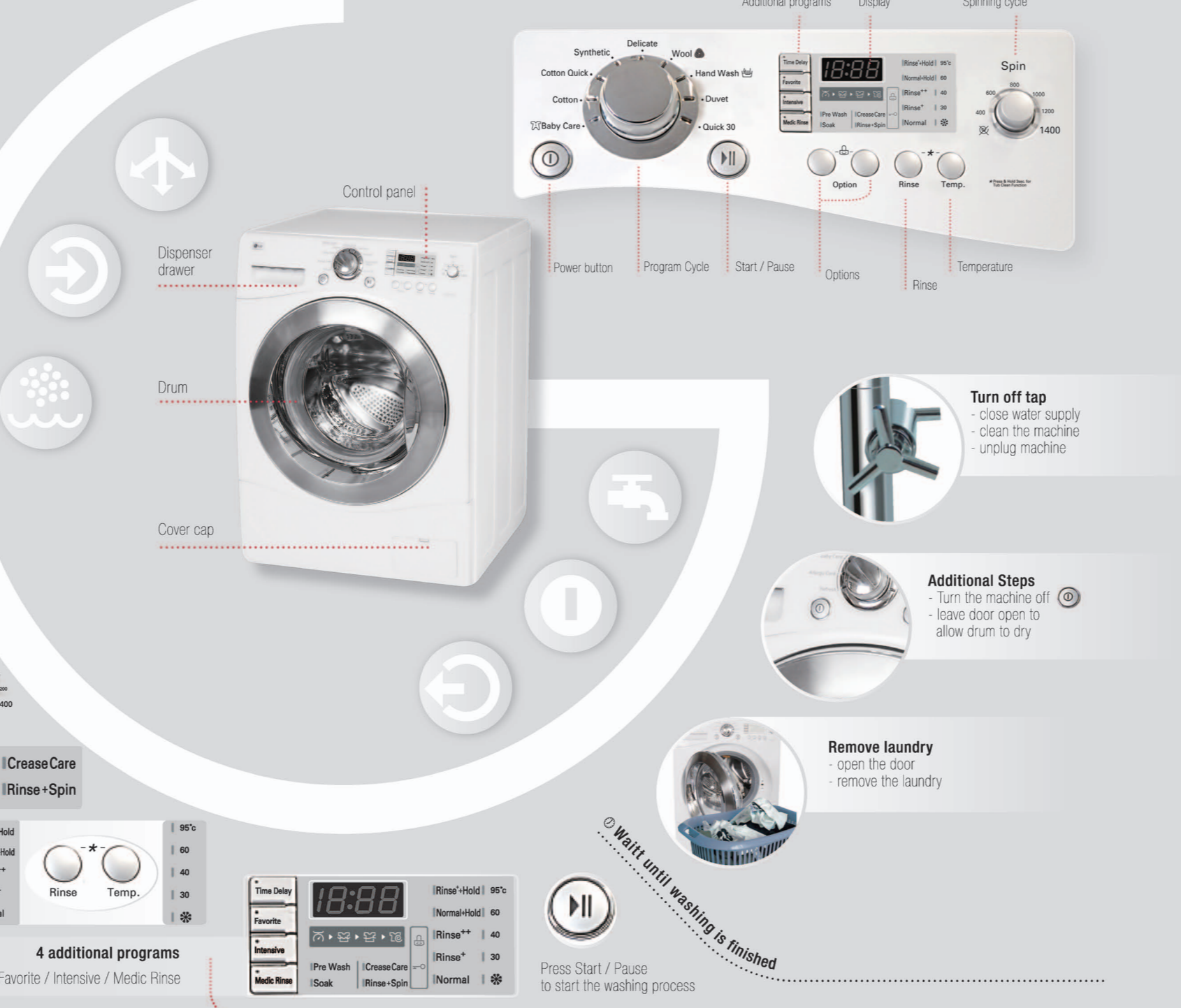
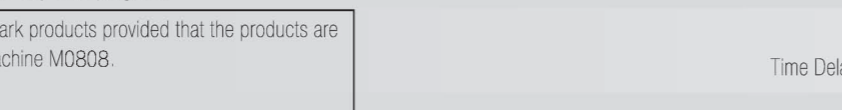
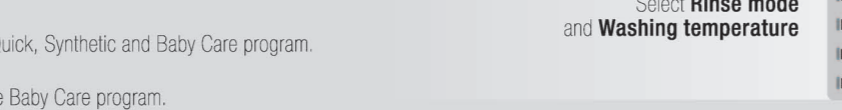
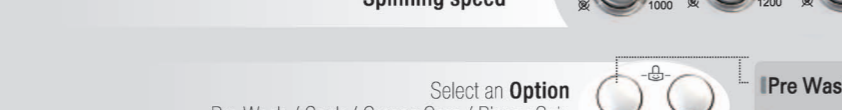
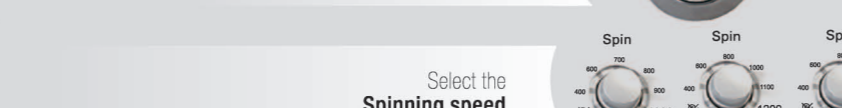
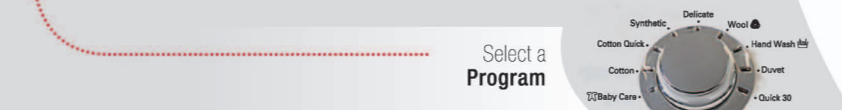
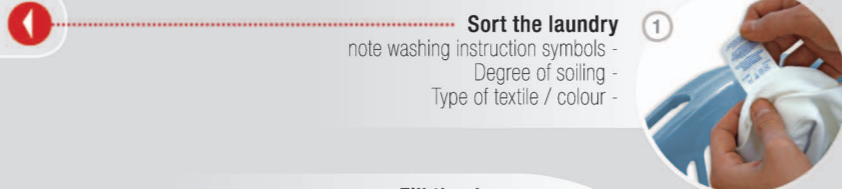

Additional programs

Time Delay

Setting "Time Delay" determines when machine stops.

How to set "Time Delay"

- Press **Power** button.
- Turn the **Program** dial to select the program you require.
- Press **Time Delay** button and set time required.
- Press the **Start/Pause** button.

Favorite

- Favorite program allows you to store a customized wash cycle for future use.

- To make a Favorite program:

(1) Select a cycle.

(2) Select

The course, washing method, number of rinses, spin speed, water temperature, turbo steam etc.

(3) Press and hold Favorite program button 3 seconds (2 beep sounds).

The Favorite program is now stored for future use.

To reuse the program, select Favorite program and press Start/Pause.

Intensive

If the laundry is heavily soiled "Intensive" option is effective.

- By selecting the Intensive option, the washing duration may be extended, depending on the program selected.

- To use this option, press the Intensive button once before the wash program is started.

Medic Rinse

For best results or for cleaner rinsing, select the "Medic Rinse" option.

- Available in the Cotton, Cotton Quick, Synthetic and Baby Care programs (Except Cold).

- Medic Rinse is set by default in the Baby Care program.

- The respective temperature indicator will light up.

Child Lock

Select this function to lock the buttons on the control panel and to prevent tampering.

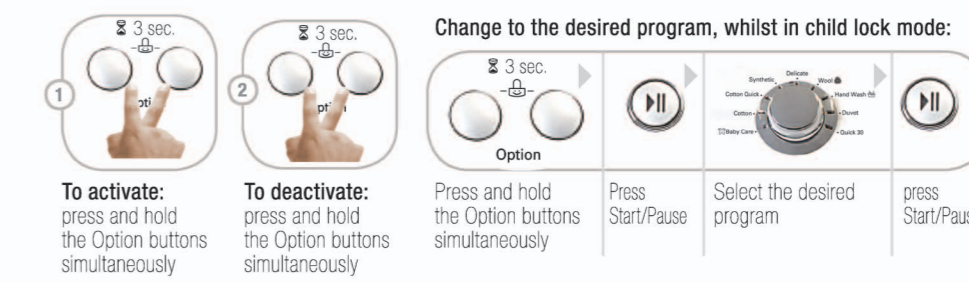

To activate: press and hold the Option buttons simultaneously

To deactivate: press and hold the Option buttons simultaneously

Change to the desired program, whilst in child lock mode:

Press and hold the Option buttons simultaneously

Press Start/Pause

Select the desired program

press Start/Pause

Tub Clean

TUB CLEAN is special cycle to clean the inside of the washing machine.

A higher water level is used in this cycle at higher spin speed. **Perform this cycle regularly.**



Empty the drum completely and close the door

Add anti-limescale (Calgon) to the main wash compartment. Close the disp. drawer

Power ON with Then press and hold Rinse and Temp. button

Press the button to start Tub Clean process

After the cycle is complete, leave the door open to dry

Beep on / off



The Beep on/off function can be set by pressing and holding the **Option** and **Rinse** button simultaneously.

The Beep on/off function can be set at any time and it is automatically cancelled in the event of a power cut. The Beep on/off function also works when power is off.

Cleaning and Maintenance

Warning: Before cleaning the washing machine interior, unplug the electrical power cord to avoid the risk of electric shock.

Cleaning the water inlet filter

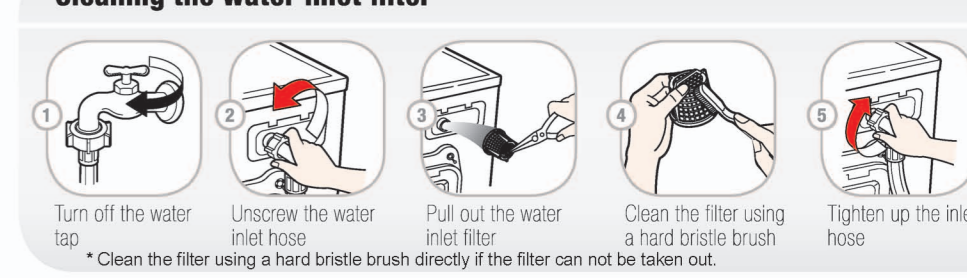

* Clean the filter using a hard bristle brush directly if the filter can not be taken out.

Cleaning the drain pump filter

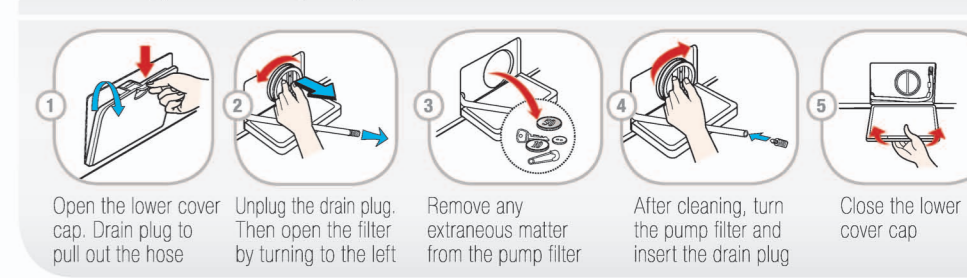

After cleaning, turn the pump filter and insert the drain plug

Cleaning the dispenser drawer

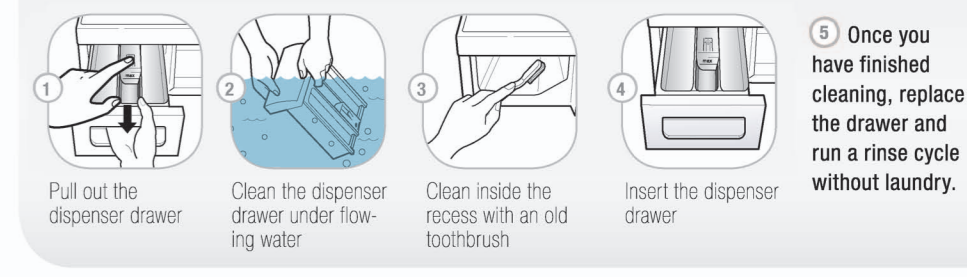

Once you have finished cleaning, replace the drawer and run a rinse cycle without laundry.

Cleaning in general

Important: Do not use methylated spirits, solvents or similar products.

Exterior
Proper care of your washing machine can extend its service life. The outside of the machine can be cleaned with warm water and a neutral non-abrasive household detergent. Immediately wipe off any spillage. Wipe with damp cloth. Avoid striking the surface with sharp objects. Never hose down the machine!

Interior
Dry around the washing machine door opening, flexible gasket and door glass. Run washing machine through a complete cycle using hot water. Repeat process if necessary.