



Color Video Camera User Manual

Model: LS521N-B1
LS521P-B1
LS521P-C



Before installing, operating or adjusting this product, please read this instruction booklet carefully and completely.



CAUTION: TO REDUCE THE RISK OF ELECTRIC SHOCK
DO NOT REMOVE COVER (OR BACK)
NO USER-SERVICEABLE PARTS INSIDE
REFER SERVICING TO QUALIFIED SERVICE PERSONNEL.



This lightning flash with arrowhead symbol within an equilateral triangle is intended to alert the user to the presence of uninsulated dangerous voltage within the product's enclosure that may be of sufficient magnitude to constitute a risk of electric shock to persons.



The exclamation point within an equilateral triangle is intended to alert the user to the presence of important operating and maintenance (servicing) instructions in the literature accompanying the product.

FCC WARNING: This equipment may generate or use radio frequency energy. Changes or modifications to this equipment may cause harmful interference unless the modifications are expressly approved in the instruction manual. The user could lose the authority to operate this equipment if an unauthorized change or modification is made.

REGULATORY INFORMATION: FCC Part 15

This equipment has been tested and found to comply with the limits for a Class A digital device, pursuant to Part 15 of the FCC Rules. These limits are designed to provide reasonable protection against harmful interference when the equipment is operated in a commercial environment.

This equipment generates, uses, and can radiate radio frequency energy and, if not installed and used in accordance with the instruction manual, may cause harmful interference to radio communications.

Operation of this equipment in a residential area is likely to cause harmful interference in which case the user will be required to correct the interference at his own expense.

- A suitable conduit entries, knock-outs or glands shall be provided in the cable entries of this product in the end user.

- **Caution:** Danger of explosion if battery is incorrectly replaced. Replaced only with the same or equivalent type recommended by the manufacturer. Dispose of used batteries according to the manufacturer's instructions.
- Holes in metal, through which insulated wires pass, shall have smooth well rounded surfaces or shall be provided with brushings.

This Class A digital apparatus complies with Canadian ICES-003.

Cet appareil numérique de la classe A est conforme à la norme NMB-003 du Canada.

Warning: Do not install this equipment in a confined space such as a bookcase or similar unit.

Warning: Wiring methods shall be in accordance with the National Electric Code, ANSI/NFPA 70.

Warning: This is a class A product. In a domestic environment this product may cause radio interference in which case the user may be required to take adequate measures.

Warning: To reduce a risk of fire or electric shock, do not expose this product to rain or moisture.

Caution: This installation should be made by a qualified service person and should conform to all local codes.

Caution: To avoid electrical shock, do not open the cabinet. Refer servicing to qualified personnel only.

Caution: The apparatus shall not be exposed to water (dripping or splashing) and no objects filled with liquids, such as vases, shall be placed on the apparatus.

To disconnect power from mains, pull out the mains cord plug. When installing the product, ensure that the plug is easily accessible.

Disposal of your old appliance



1. When this crossed-out wheeled bin symbol is attached to a product it means the product is covered by the European Directive 2002/96/EC.
2. All electrical and electronic products should be disposed of separately from the municipal waste stream via designated collection facilities appointed by the government or the local authorities.
3. The correct disposal of your old appliance will help prevent potential negative consequences for the environment and human health.
4. For more detailed information about disposal of your old appliance, please contact your city office, waste disposal service or the shop where you purchased the product.

CE This product is manufactured to comply with EMC Directive 2004/108/EC and Low Voltage Directive 2006/95/EC.

European representative :

LG Electronics Service Europe B.V.
Veluwezoom 15, 1327 AE Almere,
The Netherlands (Tel : +31-036-547-8940)

Important Safety Instructions

1. Read these instructions.
2. Keep these instructions.
3. Heed all warnings.
4. Follow all instructions.
5. Do not use this apparatus near water.
6. Clean only with dry cloth.
7. Do not block any ventilation openings. Install in accordance with the manufacturer's instructions.
8. Do not install near any heat sources such as radiators, heat registers, stoves, or other apparatus (including amplifiers) that produce heat.
9. Do not defeat the safety purpose of the polarized or grounding-type plug. A polarized plug has two blades with one wider than the other. A grounding type plug has two blades and a third grounding prong. The wide blade or the third prong are provided for your safety. If the provided plug does not fit into your outlet, consult an electrician for replacement of the obsolete outlet.
10. Protect the power cord from being walked on or pinched particularly at plugs, convenience receptacles, and the point where they exit from the apparatus.
11. Only use attachments/accessories specified by the manufacturer.
12. Use only with the cart, stand, tripod, bracket, or table specified by the manufacturer, or sold with the apparatus. When a cart is used, use caution when moving the cart/apparatus combination to avoid injury from tip-over.
13. Unplug this apparatus during lightning storms or when unused for long periods of time.
14. Refer all servicing to qualified service personnel. Servicing is required when the apparatus has been damaged in any way, such as power-supply cord or plug is damaged, liquid has been spilled or objects have fallen into the apparatus, the apparatus has been exposed to rain or moisture, does not operate normally, or has been dropped.



Cautions for Safe Operation

Power Supply

LS521P-B1/LS521N-B1:

This camera must always be operated a AC 24 V or DC 12 V Certified/Listed, class 2 power supply only.

LS521P-C:

This camera must always be operated a AC 230 V.

Note:

Be careful of AC frequency when the camera is operated with Line lock mode.

Handling of the unit

Be careful not to spill water or other liquids on the unit. Be cautions not to get combustible or metallic material inside the body. If used with foreign matter inside, the camera is liable to fail or to get cause of fire or electric shock.

- Remove dust or dirt on the surface of the lens with a blower.
- Use a dry soft cloth to clean the body. If it is very dirty,

use a cloth dampened with a small quantity of neutral detergent then wipe dry.

- Avoid the use of volatile solvents such as thinners, alcohol, benzene and insecticides. They may damage the surface finish and/or impair the operation of the camera.

Operating and storage location

Avoid viewing a very bright object (such as light fittings) during an extended period. Avoid operating or storing the unit in the following locations.

- Extremely hot or cold places (operating temperature -10 °C to 50 °C, however, we recommend that the unit be used within a temperature range of 0 °C to 45 °C)
- Damp or dust place
- Places exposed to rain
- Places subject to strong vibration
- Close to generators of powerful electromagnetic radiation such as radio or TV transmitters.

Contents

Features	8
-----------------------	----------

Part Names and Functions	9
---------------------------------------	----------

Connections	12
--------------------------	-----------

Precautions	12
Connection Overview	12
Connecting Display device.....	13
Connecting Power Source	13
Mounting the Lens.....	14
Concerning Auto-Iris Lenses.....	16
Flange-back Adjustment	17
Mounting the camera	18

Menu Operation	19
-----------------------------	-----------

OSD Menu control buttons.....	19
OSD Menu Overview	20
General Operation.....	23

Camera Identification Settings	23
Exposure Settings.....	24
White Balance settings	27
Day/Night Setting.....	28
Motion Detection Setting.....	29
3D-DNR Setting	30
Privacy Setting.....	31
Special Menu Settings.....	32

Specification	38
----------------------------	-----------

Features

This Color Video Camera is designed for installation in an video surveillance system.

This manual contains instructions on how to install and manage the Color Video Camera in your video surveillance system.

Should you require any technical assistance, please contact authorized service center.

- High resolution and high sensitivity with a 6 mm Super HAD CCD II.
- 650 TV lines of horizontal resolution.
- Day & Night function.
- C/CS Mount.
- Line Lock when using AC 24 V.
- Line Lock when using AC 230 V. (LS521P-C model only)
- Automatically switch between DC 12 V and AC 24 V.

Part Names and Functions

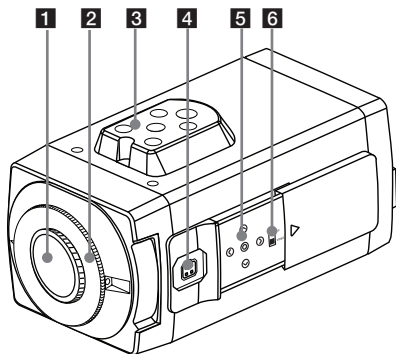

1 Lens mount cap

The lens mount of the camera is covered using a cap to protect it. Remove the lens cap covering the lens.

2 Flange-back adjustment ring

3 Camera installation bracket

The bracket can be fixed at the top or bottom of the camera.

4 Lens iris output connector (LENS)

This 4-pin connector is used to send the Iris control signal and power supply to an auto-iris type lens.

5 Setup menu control buttons

Use these buttons to set the menu options.

6 ALC Lens Setting Switch

- DC: When you attach an Auto Iris lens requiring the DC control signal, please put this switch in the DC position.
- VIDEO: When you attach an Auto Iris lens requiring the video control signal, please put this switch in the VIDEO position.

Part Names and Functions

LS521N-B1 / LS521P-B1

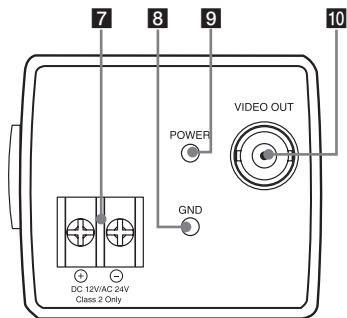

7 Power input terminal

Supplies AC 24 V or DC 12 V from an external power source.

8 GND

9 Power indicator

Lights when the camera is powered.

10 Video output connector (BNC type)

Supplies analog video signal (composite) to the connected device such as a DVR or monitor.

Part Names and Functions

LS521P-C

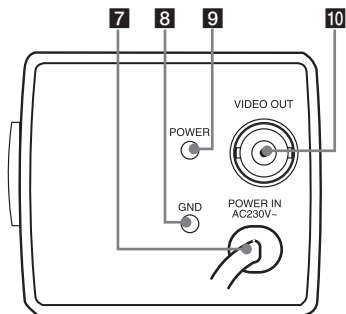

7 Power input cable (AC 230 V)

8 GND

9 Power indicator

Lights when the camera is powered.

10 Video output connector (BNC type)

Supplies analog video signal (composite) to the connected device such as a DVR or monitor.

Connections

Precautions

- Be sure to switch off the unit before installation and connection.
- A qualified service person, complying with all applicable codes, should perform all required hardware installation.
- Do not expose the power and connection cable to moisture, which may cause damage to the unit.

Connection Overview

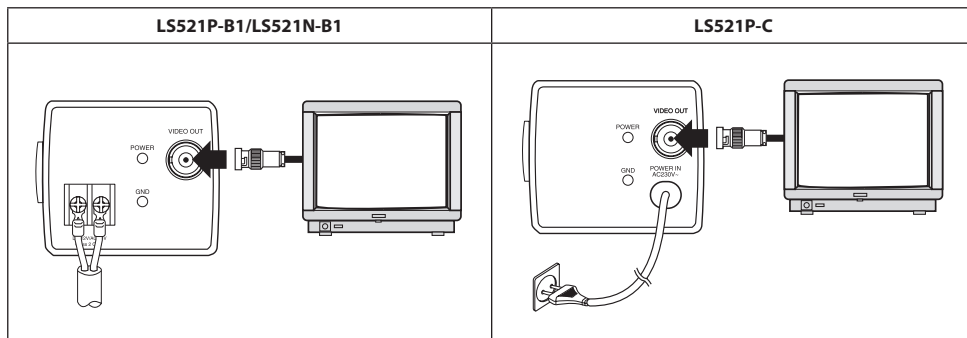

Connections

Connecting Display device

The video signal connection between the camera and the monitor.

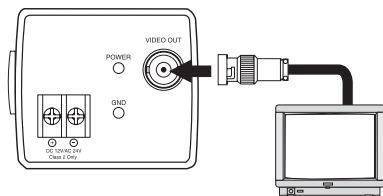

Connecting Power Source

LS521P-B1/LS521N-B1

Connect power, using the method listed below:

1. Remove the insulation on the power cable as illustrated. **(1)**
2. Attach the terminal tips. **(2)**

3. Connect to the DC 12 V / AC 24 V UL Listed, Class 2 Power Supply only on the unit.

Note:

Just make sure that the DC power tips are connected with (+) and (-) matched correctly. Mismatch can be the cause of failure or malfunction.

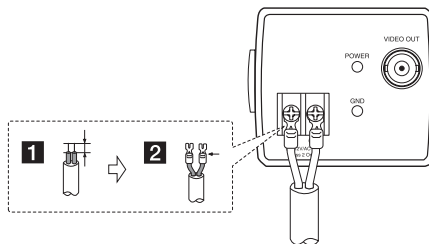

Connections

LS521P-C

Insert the plug of the power cord into a wall outlet. The POWER indicator will light.

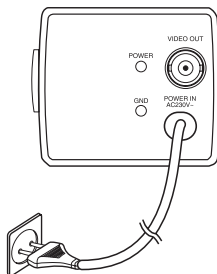

Mounting the Lens

1. Remove the lens mount cap from the camera.

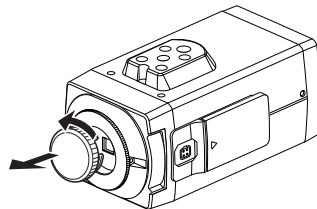

2. Install the auto-iris lens.

2-1. CS mount type lens

Carefully align the lens mount with the camera opening, then turn the lens slowly to install it.

2-2. C mount type lens

To allow for flange-back adjustment, install the C-mount adaptor (option) on the lens mount, then carefully align the lens mount with the camera opening and turn the lens slowly to install it.

Connections

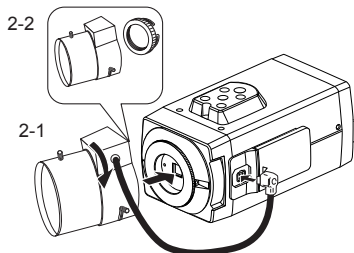

3. Connect the lens plug to the lens iris output connector (LENS) on the side of the camera.

When using lenses from other makers, the plug shape may not correspond to the terminal on the camera.

In such a case, remove the original plug and using a soldering iron, connect a lens iris plug according to the diagram. (Refer to next page.)

lens iris output connector

Pin layout for the lens iris output connector.

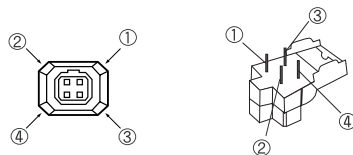

No.	DC type lenses	VIDEO type lenses
1	Damping -	Vcc (+9 V)
2	Damping +	Not used
3	Drive +	Video
4	Drive -	Ground

Connections

Rewire the lens iris plug

1. Cut off the plug of the lens cable, cut off approximately 8 mm of the insulation, and then strip approximately 2 mm of the ends of the cable sheaths.

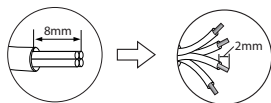

2. Solder the ends of the cable wires to the ends of the pins, and then attach the cover of the lens iris plug.

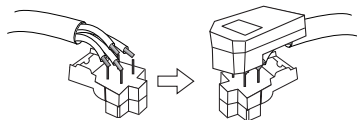

Concerning Auto-Iris Lenses

DC type auto-iris lens

A lens without driver circuit that operates only on a DC power source. In general, this type of lens is referred to as DC type coil lens. (Set the ALC Lens Setting Switch to the DC position.)

CAUTION:

Depending on the type of lens used, the lens may not perform properly.

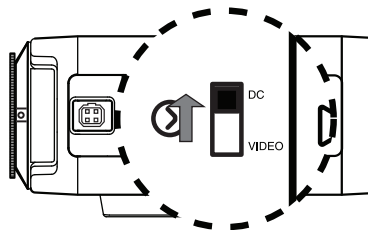

Connections

VIDEO type auto-iris lens

A lens with amplifier circuit that operates on video signal and DC power source. In general, this type of lens is referred to as EE amplifier type lens. ALC and LEVEL volume level controls are available on the lens for iris adjustments. (Set the ALC Lens Setting Switch to the VIDEO position.)

CAUTION:

Be cautious not to use Auto Iris Lens with over 35 mA.

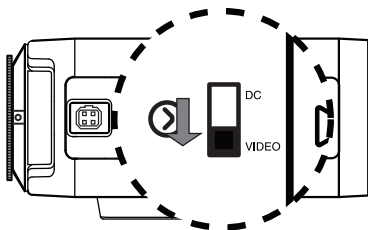

Flange-back Adjustment

The adjustment is required only when a lens without focus-adjusting mechanism is mounted, or when a lens with adjusting mechanism is mounted and focus that is more accurate is needed.

1. Loosen the flange-back fixing screws.

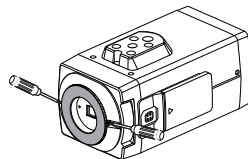

2. Use the flange-back adjusting ring to obtain a focused point while watching the monitor screen.

Connections

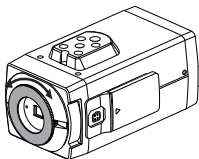

3. Tighten the flange-back fixing screws.

Note:

The object may be out of focus when using a source of near-infrared light than using the visible light.

Mounting the camera

The mounting bracket can be secured on either the top or bottom of the camera. Use the same set of screws to attach the mounting bracket on the camera.

Note:

If using a camera mounting bracket, select a location that is strong enough to bear the full weight of the camera and the mounting bracket for long periods, and install the camera and mounting bracket securely.

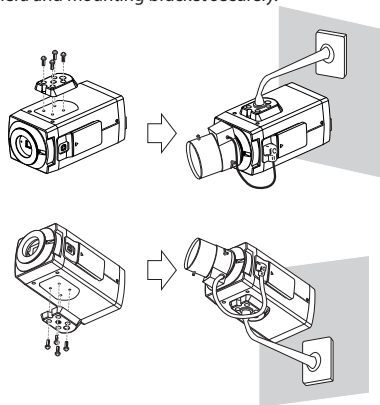





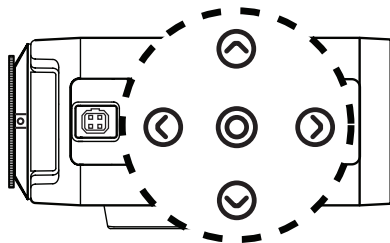

Menu Operation

OSD Menu control buttons

This camera utilizes an on-screen user MENU. To set items on the menu, use the following buttons.



BUTTON	Description
 UP button	Used to move upper direction on the menu screen. Use this button to select an item or adjust the parameters.
 DOWN button	Used to move lower direction on the menu screen. Use this button to select an item or adjust the parameters.
 RIGHT button	Moves the cursor to the right. Used to increment the value selected in the menu. The parameter changes each time this button is pressed.
 LEFT button	Moves the cursor to the left. Used to decrement the value selected in the menu. The parameter changes each time this button is pressed.
 SET button	Executes selections and displays a submenu for an item with the  mark.

Menu Operation

OSD Menu Overview

The following table shows the list of menu items and options. You can adapt the camera to your requirements by setting up the respective items in these menus.

Main Menu	Sub Menu	Contents	
CAMERA ID	-	OFF, 1 to 255	
EXPOSURE	ALC/ ELC	BACKLIGHT	OFF/BLC/HSBLC
		BRIGHTNESS	0 to 100
		AGC	OFF/LOW/MIDDLE/ HIGH
		SHUTTER	X512, to, x2, AUTO, OFF, A.FLK, 1/160, to, 1/90 000
		SENS-UP	OFF
			AUTO
		EXIT	RET/TOP/END

Main Menu	Sub Menu	Contents		
WHITE BAL	ATW			
	AWC → PUSH			
	MANUAL	COLOR TEMP	INDOOR, OUTDOOR	
		RED	-100 to 100	
		BLUE	-100 to 100	
EXIT		RET/TOP/END		
DAY/NIGHT	AUTO	LEVEL	LOW/ MIDDLE/ HIGH	
		DWELL TIME	5, 10, 15, 30, 60 s	
		EXIT	RET/TOP/END	
	DAY			
	NIGHT			

Menu Operation

Main Menu	Sub Menu	Contents	
MOTION DET	ON	ZONE NUMBER	AREA1 to AREA4
		ZONE STATE	ON/OFF
		HEIGHT	12 to 100
		WIDTH	16 to 100
		MOVE Y	6 to 94
		MOVE X	8 to 92
		SENSITIVITY	0 to 100
	EXIT	RET/TOP/END	
	OFF		
3D-DNR	OFF		-
	LOW		-
	MIDDLE		-
	HIGH		-

Main Menu	Sub Menu	Contents	
PRIVACY	OFF		-
	ON	MASK NUMBER	AREA1 to AREA8
		DISPLAY	ON/OFF
		COLOR	GRAY, WHITE, BLACK
		HEIGHT	4 to 100
		WIDTH	4 to 100
		MOVE Y	2 to 98
		MOVE X	2 to 98
		EXIT	RET/TOP/END

Menu Operation

Main Menu	Sub Menu	Contents	
SPECIAL	D-ZOOM	OFF	
		ON	ZOOM
			PAN
			TILT
		EXIT	
	D-EFFECT	OFF/V-FLIP/ MIRROR/ ROTATE	
	SHARPNESS	0 to 68	
	STABILIZER	OFF/ ON	
	COLOR	OFF/ ON	
	SYNC	INT / LL	
USER TITLE	OFF/ ON		
LANGUAGE	English (The supported language can be different depending on the model.)		
EXIT	RET/TOP/END		

Main Menu	Sub Menu	Contents
RESET	CAMERA REBOOT	-
	FACTORY RESET	-
	EXIT	RET/TOP/END
EXIT	-	-

Menu Operation

General Operation

1. Press **[SET]** button.

The setup menu screen appears on the monitor.

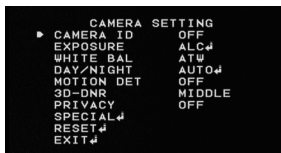

2. Use **[UP]** or **[DOWN]** button to select an option then press **[SET]** button.
Submenu appears on the monitor.
3. Use **[UP]** or **[DOWN]** button to select a submenu option.
4. Use **[LEFT]** or **[RIGHT]** button to select a value.
5. Select **[EXIT]** option then press **[SET]** to exit the setup menu. In the submenu, use **[UP]** or **[DOWN]** button to select the **[EXIT]** then use **[LEFT]** or **[RIGHT]** button to select a mode and press **[SET]** to exit the setup menu.
 - **RET:** Return to the previous.

- **TOP:** Return to the CAMERA SETTING menu screen.
- **END:** Exit the setup menu.

Camera Identification Settings

You can use the camera identification (CAMERA ID) to assign a number to the camera.



1. Select **[CAMERA ID]** option on the **[CAMERA SETTING]** menu.
2. Use **[LEFT]** or **[RIGHT]** to select a CAMERA ID (OFF, 1 to 255).

Menu Operation

Exposure Settings

You can set the exposure options using the EXPOSURE menu.

1. Select [EXPOSURE] option on the [CAMERA SETTING] menu.
2. Use [LEFT] or [RIGHT] button to select a mode (ALC ↔ ELC).
3. Press [SET] button and the EXPOSURE menu appears.

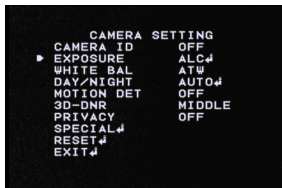

BACKLIGHT setting

Use BACKLIGHT option to view the object clearly in backlight conditions.



1. Select [BACKLIGHT] option.
2. Use [LEFT] or [RIGHT] button to select a mode then press [SET].
 - BLC: Camera's backlight compensation feature helps alleviate issues of visibility in high contrast areas. Set the BLC limit.
 - > BLC LIMIT: LOW ↔ MIDDLE ↔ HIGH

Menu Operation

- HSBL: Use for masking brightness of the specific area to view the subject more clearly. The HSBL mode is automatically activated only in low luminance scene.
 - > AREA SETTING: Use **[LEFT]** or **[RIGHT]** button to select an area then use **[UP]** or **[DOWN]** button to select ON or OFF. Press **[SET]** to exit the Area setting menu.
 - > GRAY SCALE: Use **[LEFT]** or **[RIGHT]** button to select a gray scale.
(GRAY ↔ D.GRAY ↔ BLACK).
 - > USER SCALE: Use **[LEFT]** or **[RIGHT]** button to select a bright level.(5 level)
 - > MASK: Use **[LEFT]** or **[RIGHT]** button to select [ON] or [OFF].
If you set the MASK to ON, the mask function is activated only when the HSBL is automatically activated in low luminance scene.
- OFF: Not used.

Brightness setting

You can increase the brightness of the darkened video. If you set the brightness to a lower value, the image is darkened. If you set the brightness to a higher value, the image gets bright.



1. Select [BRIGHTNESS] option.
2. Use **[LEFT]** or **[RIGHT]** button to set the bright level.

Menu Operation

AGC (Automatic Gain Control) setting

If the images are too dark, change the maximum [AGC] value to make the images brighter.



1. Select [AGC] option.
2. Use **[LEFT]** or **[RIGHT]** button to select a mode.
(OFF ↔ LOW ↔ MIDDLE ↔ HIGH)

SHUTTER (Shutter Speed) setting

Select the desired shutter speed for camera exposure. You can change the shutter speed to higher speed to capture fast-moving subjects, though the image becomes darker.



1. Select [SHUTTER] option.
2. Use **[LEFT]** or **[RIGHT]** button to set shutter speed.
(AUTO ↔ OFF ↔ A.FLK ↔ 1/160 to 1/90 000 ↔ x512 to x2)

Menu Operation

SENS-UP setting

If pictures are not clear due to darkness, this SENS-UP operation would increase the sensitivity of picture.



1. Use **[UP]** or **[DOWN]** button to select [SENS-UP] option.
2. Use **[LEFT]** or **[RIGHT]** button to select mode.
 - AUTO: Adjust the sensitivity of the picture automatically.
 - > SENS-UP LIMIT: Use **[LEFT]** or **[RIGHT]** button to set the SENS-UP limit.
 - > EXIT: Select a mode and press **[SET]** to exit the menu.
 - OFF: Not used.

Note:

If you set to one of the SHUTTER options except AUTO on the [SHUTTER] menu or [AGC] to [OFF], the [SENS-UP] setting is not available and [--] mark is displayed.

White Balance settings

Select the method by which the camera shifts its output colors to compensate for the color of a light source.

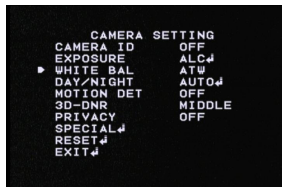

Menu Operation

1. Select [WHITE BAL] option.
2. Use [LEFT] or [RIGHT] button to select a mode then press [SET].
 - ATW (Auto-Tracing White Balance): The color temperature range for the proper white balance is approximately 1 700 to 11 000 K. Proper white balance may not be obtained under the following conditions:
 - > The color temperature is out of the 1 700 to 11 000 K range.
 - > When the scene contains mostly high color temperature objects, such as a blue sky or sunset.
 - > When the scene is dim.
 - AWC➡PUSH: If you select the AWC➡PUSH mode, you will be able to set up the White Balance automatically using [SET] button.
 - MANUAL: You can set the white balance options manually.
 - > COLOR TEMP: Use [LEFT] or [RIGHT] button to select a function.
 - INDOOR: The color temperature range for the proper white balance is approximately 3 200 K.
 - OUTDOOR: The color temperature range for the proper white balance is approximately 5 100 K.
 - > RED: Obtains the optimum amount of red gain.
 - > BLUE: Obtains the optimum amount of blue gain.

Day/Night Setting

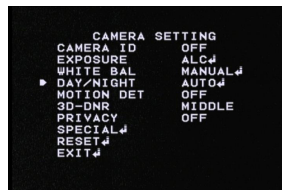

Menu Operation

1. Select [DAY/NIGHT] option.
2. Use [**LEFT**] or [**RIGHT**] button to select mode for day/night function.

- AUTO: You will be able to change the Day/Night mode automatically.

Note:

If you set the AGC to [OFF] on the [EXPOSURE] menu, the AUTO mode of the DAY/NIGHT function is not available and [---] mark is displayed.

- > LEVEL: Use [**LEFT**] or [**RIGHT**] button to select a level.
(LOW ↔ MIDDLE ↔ HIGH)
- > DWELL TIME: Use [**LEFT**] or [**RIGHT**] button to select a dwell time.
(5, 10, 15, 30 or 60 s)
- DAY: Color mode enabled.
- NIGHT: Black-and-white mode enabled.

Motion Detection Setting

The motion detection detects the moving objects in the scene by monitoring changes in brightness level. You can select the level of sensitivity for motion detection to 4 zone.

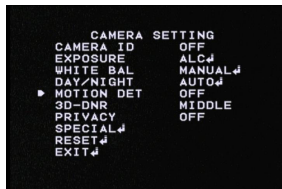

1. Select [MOTION DET] option.
2. Use [**LEFT**] or [**RIGHT**] button to select a [ON] and press [**SET**].
The MOTION DETECTION menu appears.
3. Use [**LEFT**] or [**RIGHT**] button to select a zone number (AREA1 to AREA4) on the [ZONE NUMBER].
4. Use [**LEFT**] or [**RIGHT**] button to set up the ON or OFF on the ZONE STATE.

Menu Operation

- Use **[UP]** or **[DOWN]** to select an option then use **[LEFT]** or **[RIGHT]** button to adjust the option.
 - HEIGHT:** Enlarge or decrease the vertical size of the mask.
 - WIDTH:** Enlarge or decrease the horizontal size of the mask.
 - MOVE Y:** Moves vertical position of the mask.
 - MOVE X:** Moves horizontal position of the mask.
- Use **[SENSITIVITY]** option to obtain the optimum detection level.

3D-DNR Setting

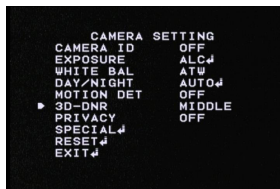

- Select **[3D-DNR]** option.
If pictures are not clear due to brightness, this option would reduce the noise of picture.
- Use **[LEFT]** or **[RIGHT]** button to select an option.
(OFF ↔ LOW ↔ MIDDLE ↔ HIGH)

Notes:

- If you set the AGC to **[OFF]** on the **[EXPOSURE]** menu, the **[3D-DNR]** function is not available and **[---**] mark is displayed.
- When you use this function, the afterimage may occur.

Menu Operation

Privacy Setting

This function is aiming at the protection of personal privacy, selecting a screen part black not to be displayed in the screen. Up to 8 zones can be registered.

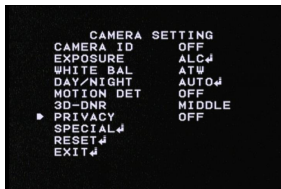

1. Select [PRIVACY] option.
2. Use [LEFT] or [RIGHT] button to select a [ON] and press [SET]. The PRIVACY SETUP menu appears.
3. Use [LEFT] or [RIGHT] button to select a mask (AREA1 to AREA8) on the [MASK NUMBER].
4. Use [LEFT] or [RIGHT] button to set up the ON or OFF on the DISPLAY option.
5. Use [LEFT] or [RIGHT] button to set up the GRAY,

WHITE or BLACK on the COLOR option.

6. Use [UP] or [DOWN] to select an option then use [LEFT] or [RIGHT] button to adjust the option.
 - HEIGHT: Enlarge or decrease the vertical size of the mask.
 - WIDTH: Enlarge or decrease the horizontal size of the mask.
 - MOVE Y: Moves vertical position of the mask.
 - MOVE X: Moves horizontal position of the mask.

Note:

The parts with the registered mask numbers from AREA1 to AREA4 have the same color. (So do the parts with the numbers from AREA5 to AREA8). If you change the mask color, the registered mask color will be changed automatically with the same color for each of group (AREA1 to 4, AREA5 to 8).

Menu Operation

Special Menu Settings

This menu lets you adjust and set up D-ZOOM, D-EFFECT, SHARPNESS, STABILIZER, COLOR, SYNC, USER TITLE, LANGUAGE function by yourself in the SPECIAL menu.

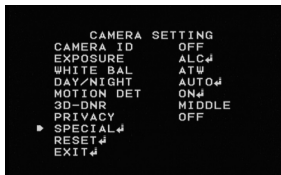

1. Select [SPECIAL] option.
2. Press [SET] button and the SPECIAL menu appears.

Setting the D-ZOOM (Digital Zoom) level

You can select the digital zoom level.

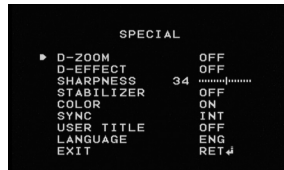

1. Select [D-ZOOM] option on the [SPECIAL] menu.
2. Use [LEFT] or [RIGHT] button to select a [ON] then press [SET] the DIGITAL ZOOM menu appears. When you set to ON, the displayed image can be shaking.
3. Use [UP] or [DOWN] to select a option then use [LEFT] or [RIGHT] button to select a level.
 - ZOOM: Use [LEFT] or [RIGHT] button to enlarge the screen.
 - PAN: Use [LEFT] or [RIGHT] button to move the screen. (left or right)
 - TILT: Use [LEFT] or [RIGHT] button to move the screen. (up or down)

Menu Operation

Setting the D-EFFECT (Digital effect)

You can select the digital effect.

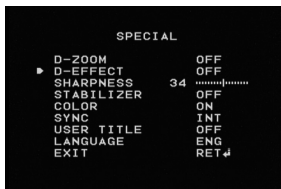

1. Select [D-EFFECT] option on the [SPECIAL] menu.
2. Use **[LEFT]** or **[RIGHT]** button to select a digital effect.
 - V-FLIP: Flip the picture vertically.
 - MIRROR: Turn on the mirror effect.
 - ROTATE: Rotate the picture. (180°)
 - OFF: Turn off the digital effect.

Setting the SHARPNESS effect

The degree to which the boundary of the two portions is clearly distinguished.



1. Select [SHARPNESS] option on the [SPECIAL] menu.
2. Use **[LEFT]** or **[RIGHT]** button to change a adjust the option. If you set the sharpness value to higher, the image outline becomes sharp. If you set to lower value, the image outline becomes dim.

Menu Operation

Stabilizer setting

The image stabilizer function minimizes the appearance of shaky images caused by low-frequency vibration.

This function is useful for outdoor surveillance.

Select [STABILIZER] option and set to ON or OFF.



Note:

If you set the [STABILIZER] to ON, the Digital zoom is set to [x1.1] automatically.

Setting the COLOR effect

You can switch the displayed picture to gray scale or color.

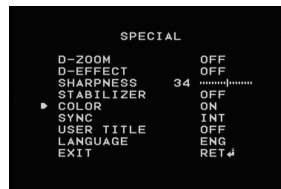

1. Select [COLOR] option on the [SPECIAL] menu.
2. Use [LEFT] or [RIGHT] button to change a color effect.
 - ON: To display the picture with color.
 - OFF: To display the picture with grayscale.

Menu Operation

Setting the SYNC (Synchronization)

The SYNC function is available only with AC power source.

1. Select [SYNC] option on the [SPECIAL] menu.
 2. Use [LEFT] or [RIGHT] button to select [INT] or [LL] (Line Lock).
- INT: Selects for using the internal synchronization.



- LL (Line Lock): Selects for the operation of multi cameras because it synchronizes the camera phase by using the external signal (AC power signal).

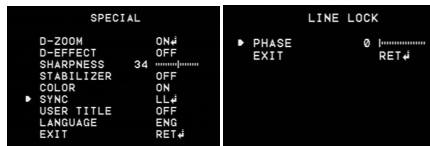

- 2-1. Select [LL] mode and press [SET].
- 2-2. Select a desired phase using the [LEFT] or [RIGHT] button.

Note:

When you use the DC 12 V power, the [SYNC] option is fixed to [INT] mode only.

Setting the USER TITLE

You can use the camera identification to assign a number and character to the camera (0 to 9, A to Z, a to z). The USER TITLE is displayed on the upper left of the screen. To disappear the user title, select [OFF].

1. Select [USER TITLE] option on the [SPECIAL] screen.

Menu Operation

- Use **[LEFT]** or **[RIGHT]** button to select a **[ON]** then press **[SET]**. The USER TITLE menu appears.

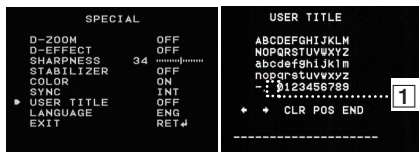

- Use **[UP]**, **[DOWN]**, **[LEFT]** or **[RIGHT]** button to select a character or number then press **[SET]** button.
 - CLR: Clear all entered characters and numbers.
 - POS: Move the USER TITLE position on the screen using the arrow buttons.
 - END: Confirm your selection or exit the setting.
 - []** (Blank): Inserts a space at the cursor position.
 - [←]**/**[→]**: Moves cursor to left or right.

Language Setting

Select the viewer language for the camera setup menu and OSD information display.



- Select **[LANGUAGE]** option on the **[SPECIAL]** screen.
- Press **[LEFT]** or **[RIGHT]** button to select a language.

Menu Operation

Reset Settings

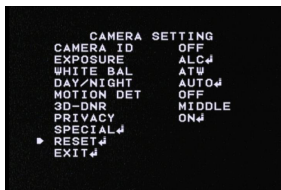

1. Select [RESET] option.
2. Press **[SET]** button and the RESET menu appears.
3. Use **[UP]** or **[DOWN]** to select option.



- CAMERA REBOOT: To reboot the camera system.
 - FACTORY RESET: To reset the camera setting to factory setting, select [FACTORY RESET] option.
4. Press **[SET]** button to confirm your selection.

Specification

ITEM		LS521N-B1	LS521P-B1	LS521P-C
Signal System		NTSC	PAL	
Total/Effective Pixels		410 K / 380 K Pixels	470 K / 440 K Pixels	
Pick-up Device		6 mm SUPER HAD CCD II		
Lens		C/CS Mount Lens		
Signal Process		XDI-S2		
Synchronization System		Internal / Line Lock		
Scanning Frequency (H)		15.734 kHz	15.625 kHz	
Scanning Frequency (V)		59.94 Hz(VD)	50 Hz(VD)	
Resolution		More than 650 TV Lines		
S/N Ratio		More than 50 dB (AGC Off, F1.2)		
Video Output Signal		1 Vp-p Composite (75 Ω)		
Minimum Illumination	Day	0.0001 lx (Sens-up Auto, F1.2) (0.06 lx: Sens-Up Off, F1.2)		
	Night	0.00003 lx (Sens-up Auto, F1.2) (0.03 lx: Sens-Up Off, F1.2)		

Specification

ITEM	LS521N-B1	LS521P-B1	LS521P-C
Iris Control	DC/VIDEO		
Day & Night	Digital Day & Night		
Gain Control	OFF/LOW/MIDDLE/HIGH		
Exposure	ALC/ELC		
Shutter Speed	1/60 to 1/90 000	1/50 to 1/90 000	
White Balance	ATW/ AWC➔PUSH /MANUAL		
Power Source	DC 12 V / AC 24 V		AC 230 V
Power Consumption	4.4 W		
Operation Temperature	-10 °C to 50 °C (Humidity: 0 % RH to 80 % RH)		
Storage Temperature	-20 °C to 60 °C (Humidity: 0 % RH to 85 % RH)		
Weight	380 g		472 g
Dimension (W x H x D)	67.4 x 61.5 x 135.5 mm		



P/NO: MFL62723727