



OWNER'S MANUAL

DVD Receiver System

Please read this manual carefully before operating your set and retain it for future reference.

MODEL

HT355SD (HT355SD, SH35SD-S/W)

P/NO : MFL63284784

1

Safety Information



CAUTION: TO REDUCE THE RISK OF ELECTRIC SHOCK DO NOT REMOVE COVER (OR BACK) NO USER-SERVICEABLE PARTS INSIDE REFER SERVICING TO QUALIFIED SERVICE PERSONNEL.



This lightning flash with arrowhead symbol within an equilateral triangle is intended to alert the user to the presence of uninsulated dangerous voltage within the product's enclosure that may be of sufficient magnitude to constitute a risk of electric shock to persons.



The exclamation point within an equilateral triangle is intended to alert the user to the presence of important operating and maintenance (servicing) instructions in the literature accompanying the product.

WARNING: TO PREVENT FIRE OR ELECTRIC SHOCK HAZARD, DO NOT EXPOSE THIS PRODUCT TO RAIN OR MOISTURE.

WARNING: Do not install this equipment in a confined space such as a book case or similar unit.

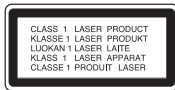

CAUTION: This product employs a Laser System. To ensure proper use of this product, please read this owner's manual carefully and retain it for future reference. Shall the unit require maintenance, contact an authorized service center.

Use of controls, adjustments or the performance of procedures other than those specified herein may result in hazardous radiation exposure.

To prevent direct exposure to laser beam, do not try to open the enclosure. Visible laser radiation when open. DO NOT STARE INTO BEAM.

CAUTION: The apparatus shall not be exposed to water (dripping or splashing) and no objects filled with liquids, such as vases, shall be placed on the apparatus.

CAUTION concerning the Power Cord

Most appliances recommend they be placed upon a dedicated circuit;

That is, a single outlet circuit which powers only that appliance and has no additional outlets or branch circuits. Check the specification page of this owner's manual to be certain. Do not overload wall outlets. Overloaded wall outlets, loose or damaged wall outlets, extension cords, frayed power cords, or damaged or cracked wire insulation are dangerous. Any of these conditions could result in electric shock or fire. Periodically examine the cord of your appliance, and if its appearance indicates damage or deterioration, unplug it, discontinue use of the appliance, and have the cord replaced with an exact replacement part by an authorized service center. Protect the power cord from physical or mechanical abuse, such as being twisted, kinked, pinched, closed in a door, or walked upon. Pay particular attention to plugs, wall outlets, and the point where the cord exits the appliance. To disconnect power from the mains, pull out the mains cord plug. When installing the product, ensure that the plug is easily accessible.

- The appliance is not intended for use by young children or infirm persons without supervision.
- Young Children should be supervised to ensure that they do not play with appliance.
- If the appliance is supplied from a cord extension set or an electrical portable outlet device, the cord extension set on electrical portable outlet device must be positioned so that it is not subject to splashing or ingress of moisture.

This device is equipped with a portable battery or accumulator.

Safe way to remove the battery or the battery from the equipment:

Remove the old battery pack, follow the steps in reverse order than the assembly. To prevent contamination of the environment and bring on possible threat to human and animal health, the old battery or the battery put in the appropriate container at designated collection points. Do not dispose of batteries or battery together with other waste. It is recommended that you use local, free reimbursement system batteries and accumulators. The battery shall not be exposed to excessive heat such as sunshine, fire or the like.

Copyrights

It is forbidden by law to copy, broadcast, show, broadcast via cable, play in public, or rent copyrighted material without permission. This product features the copy protection function developed by Macrovision. Copy protection signals are recorded on some discs. When recording and playing the pictures of these discs picture noise will appear. This product incorporates copyright protection technology that is protected by U.S. patents and other intellectual property rights. Use of this copyright protection technology must be authorized by Macrovision, and is intended for home and other limited viewing uses only unless otherwise authorized by Macrovision. Reverse engineering or disassembly is prohibited.

CONSUMERS SHOULD NOTE THAT NOT ALL HIGH DEFINITION TELEVISION SETS ARE FULLY COMPATIBLE WITH THIS PRODUCT AND MAY CAUSE ARTIFACTS TO BE DISPLAYED IN THE PICTURE. IN CASE OF 525 OR 625 PROGRESSIVE SCAN PICTURE PROBLEMS, IT IS RECOMMENDED THAT THE USER SWITCH THE CONNECTION TO THE 'STANDARD DEFINITION' OUTPUT. IF THERE ARE QUESTIONS REGARDING OUR TV SET COMPATIBILITY WITH THIS MODEL 525p AND 625p UNIT, PLEASE CONTACT OUR CUSTOMER SERVICE CENTER.

You have to set the disc format option to [Mastered] in order to make the discs compatible with the LG players when formatting rewritable discs. When setting the option to Live File System, you cannot use it on LG players.

(Mastered/ Live File System : Disc format system for Windows Vista)

1
Safety Information

- 2 CAUTION
- 3 Copyrights

2
Preparation

- 6 Unique Features
- 6 Accessories
- 6 Playable Discs
- 7 Playable file Requirement
- 9 Front panel
- 9 Rear panel
- 10 Remote Control

3
Installation

- 12 Connecting the speakers
 - 12 Attaching the speakers to the unit
 - 12 Positioning the System
- 13 Connections to Your TV
 - 13 Component Video Connection
 - 14 Video Connection
 - 14 Optional Equipment Connection
 - 14 AUX IN Connection
 - 14 AUDIO IN (Portable IN) Connection
 - 15 USB Connection
 - 15 Antenna Connection
 - 16 Adjust the Setup settings
 - 16 OSD Initial language settings
 - Optional

- 16 To display and exit the Setup Menu
- 16 LANGUAGE
- 17 DISPLAY
- 17 AUDIO
 - 18 5.1 Speaker Setup
- 18 LOCK (Parental Control)
- 19 OTHERS

4
Operation

- 20 Basic Operations
- 21 Other Operations
 - 21 Displaying Disc Information on-screen
 - 21 To display the DVD Menu
 - 21 To display the DVD Title
 - 21 Selecting a subtitle language
 - 21 1.5 times speed playback
 - 22 Starting play from selected time
 - 22 Last Scene Memory
 - 22 Changing the character set to display DivX® subtitle correctly
 - 22 Programmed Playback

- 23 Viewing a PHOTO file
- 23 Viewing photo files as a slide show
- 23 Listening to music during slide show
- 23 Sleep Timer Setting
- 24 Dimmer
- 24 Turn off the sound temporarily
- 24 Screen Saver
- 24 System Select - Optional
- 24 Displaying file information (ID3 TAG)
- 24 Radio Operations
 - 24 Listening to the Radio
 - 24 Presetting the Radio Stations
 - 25 Deleting all the saved stations
 - 25 Improving poor FM reception
- 25 Sound adjustment
 - 25 Setting the surround mode
- 26 Advanced Operations
 - 26 Listening to music from your portable player or external device
 - 26 Recording to USB

5 Maintenance

- 27 Handling the Unit
- 27 When shipping the Unit
- 27 Keeping the exterior surfaces clean
- 27 Cleaning the Unit
- 27 Maintaining the Unit
- 27 Notes on Discs
 - 27 Handling Discs
 - 27 Storing Discs
 - 27 Cleaning Discs

6 Troubleshooting

- 28 Troubleshooting

7 Appendix

- 29 Language Codes
- 30 Area Codes
- 31 Specifications

1

2

3

4

5

6

7

2 Preparation

2

Preparation

Unique Features

Portable In

Listen to music from your portable device. (MP3, Notebook, etc)

USB Direct Recording

Record music from CD to your USB device.

Accessories

Please check and identify the supplied accessories.

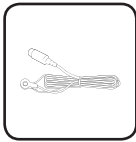

FM Antenna (1)



Remote Control (1)/
Battery (1)



Video Cable (1)

Playable Discs

This unit plays DVD±R/RW and CD-R/RW that contains audio titles, DivX, MP3, WMA and/or JPEG files. Some DVD±RW/DVD±R or CD-RW/CD-R cannot be played on this unit due to the recording quality or physical condition of the disc, or the characteristics of the recording device and authoring software.



DVD-VIDEO (8 cm / 12 cm disc)
Discs such as movies that can be purchased or rented.



DVD±R (8 cm / 12 cm disc)
Video mode and finalized only.



DVD-RW (8 cm / 12 cm disc)
Video mode and finalized only.
DVD VR format that have been finalized can not be played in this unit



DVD+R: Video mode only.
Supports the double layer disc also



DVD+RW (8 cm / 12 cm disc)
Video mode and finalized only.



Audio CD: Music CDs or CD-R/CD-RW in music CD format that can be purchased.

"Dolby", "Pro Logic", and the double-D symbol are trademarks of Dolby Laboratories. Manufactured under license from Dolby Laboratories.

About the Symbol Display

"" may appear on your TV display during operation and indicates that the function explained in this owner's manual is not available on that disc.

Symbol Used in this Manual

All discs and file listed below

MP3 files

DVD and finalized DVD±R/RW

WMA files

DivX files

Audio CDs

JPG files









Regional Codes

This unit has a regional code printed on the rear of the unit. This unit can play only DVD discs labeled same as the rear of the unit or "ALL".

- Most DVD discs have a globe with one or more numbers in it clearly visible on the cover. This number must match your unit's regional code; or the disc cannot play.
- If you try to play a DVD with a different regional code from your unit, the message "Check Regional Code" appears on the TV screen.

Playable file Requirement

MP3/ WMA music file requirement

MP3/ WMA file compatibility with this unit is limited as follows :

- Sampling frequency : between 32 to 48 kHz (MP3), between 32 to 48 kHz (WMA)
- Bit rate : between 32 to 320 kbps (MP3), 40 to 320 kbps (WMA)
- Support Version : v2, v7, v8, v9
- Maximum files : Under 999
- File extensions : ".mp3"/ ".wma"
- CD-ROM file format : ISO9660/ JOLIET
- We recommend that you use Easy-CD Creator, which creates an ISO 9660 file system.

Photo file requirement

JPEG disc compatibility with this unit is limited as follows :

- Max pixel in width : 2 760 x 2 048 pixel
- Maximum files : Under 999
- Some discs may not operate due to a different recording format or the condition of disc.
- File extensions: ".jpg"
- CD-ROM file format : ISO9660/ JOLIET

DivX file requirement

DivX file compatibility with this unit is limited as follows :

- Available resolution: up to 720x576 (W x H) pixels.
- The file name of the DivX subtitle should be 45 characters or less.
- If there is a code impossible to express in the DivX file, it may be displayed as a " _ " mark on the display.
- Frame rate : less than 30 fps
- If the video and audio structure of recorded files are not interleaved, either video or audio is output.
- Playable DivX file : ".avi", ".mpg", ".mpeg", ".divx"
- Playable Subtitle format : SubRip (*.srt/ *.txt), SAMI (*.smi), SubStation Alpha (*.ssa/ *.txt), MicroDVD (*.sub/ *.txt), SubViewer 2.0 (*.sub/ *.txt)
- Playable Codec format : "DIVX3.xx", "DIVX4.xx", "DIVX5.xx", "MP4V3", "3IVX".
- Playable Audio format : "AC3", "PCM", "MP3", "WMA".
- For Discs formatted in Live file system, you can not play it on this player.
- If the name of a movie file is different from that of the subtitle file, during playback of a DivX file, the subtitle may not be displayed.
- If you play a DivX file different from the DivX spec, it may not operate normally.

Compatible USB Devices

- MP3 Player : Flash type MP3 player.
- USB Flash Drive : Devices that support USB 2.0 or USB 1.1.
- The USB function of this unit does not support some USB devices.

USB device requirement

- Devices which require additional program installation when connected to a computer, are not supported.
- Do not extract the USB device while in operation.
- For a large capacity USB, it may take longer than a few minute to be searched.
- To prevent data loss, back up all data.
- If you use a USB extension cable or USB hub, the USB device may not be recognized.
- Using NTFS file system is not supported. (Only FAT(16/32) file system is supported.)
- This unit is not supported when the total number of files is 1 000 or more.
- External HDD, Card readers, Locked devices, or hard type USB devices are not supported.
- USB port of the unit cannot be connected to PC. The unit can not be used as a storage device.

Front panel

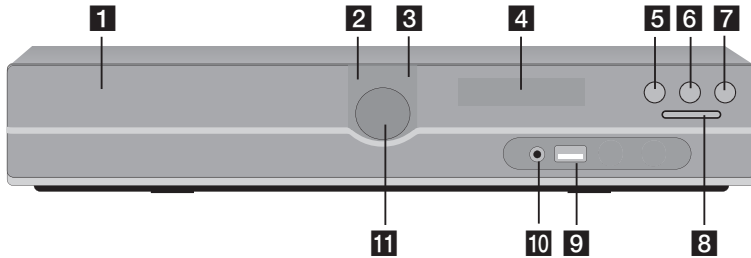

- 1** DVD/CD Disc Drawer
- 2** Power (⏻/⏿)
- 3** Open/Close (⏏)
- 4** Display window
- 5** Play/Pause (▶/⏸), MONO/ST.
- 6** Stop (■)
- 7** Function (F)
Selects the function or input source.
- 8** TUNING (-/+)(◀◀▶▶), Skip/Search
You can search by pressing and holding TUNING.
- 9** USB port
You can play video, image and sound files by connecting the USB device.
- 10** P.(Portable) IN port
You can enjoy music from portable device on your unit.
- 11** Volume (VOL.)

Rear panel

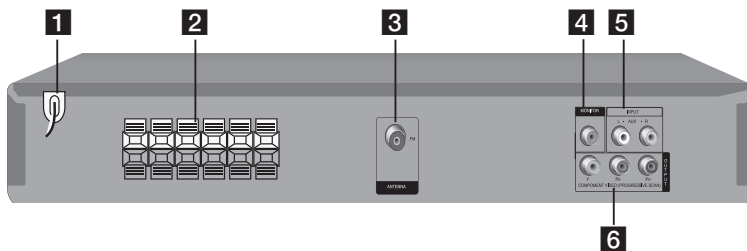

- 1** Power cord.
- 2** Speaker terminal
- 3** ANTENNA connector (FM)
- 4** VIDEO OUT connector
Connect to a TV with video inputs.
- 5** AUX connector
- 6** COMPONENT VIDEO OUT (Y PB PR)
Connect to a TV with Y Pb Pr inputs.

Remote Control

2 Preparation

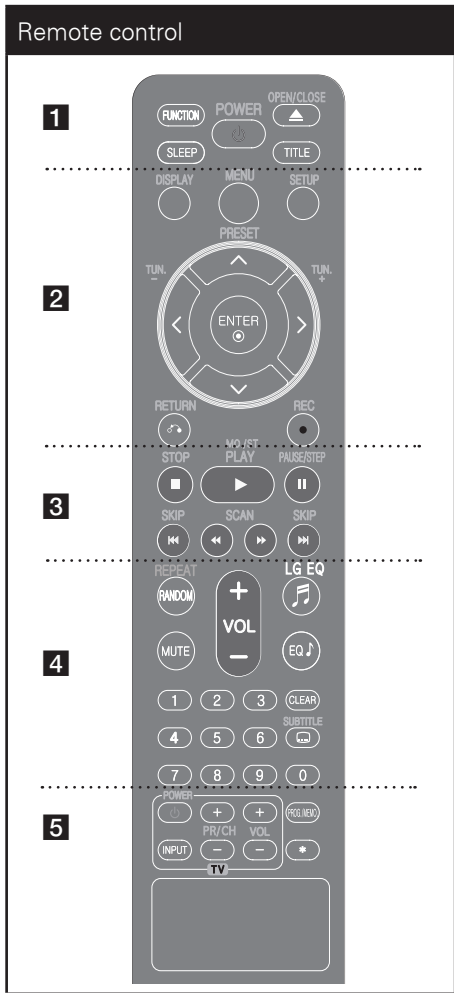

..... 1

FUNCTION : Selects the function and input source. (DVD/CD, USB, AUX, PORTABLE, FM,)

SLEEP : Sets the system to turn off automatically at a specified time. (Dimmer : The display window brightness will be reduced by half)

POWER : Switches the unit ON or OFF.

OPEN/CLOSE : Opens and closes the disc Drawer.

TITLE : If the current DVD title has a menu, the title menu appears on the screen. Otherwise, the disc menu may not appear.

..... 2

DISPLAY : Accesses On-Screen Display.

MENU : Accesses the menu on a DVD disc.

SETUP : Accesses or removes setup menu.

PRESET (Λ∨) : Selects preset Radio program.

TUN. (-/+) : Tunes in the desired radio station.

Λ/∨/</> (up/ down/ left/ right): Used to navigate on-screen displays.

ENTER : Acknowledges menu selection.

RETURN (↶) : Moves backwards in the menu or exits the setup menu.

REC (●) : USB Direct Recording.

..... 3

STOP (■) : Stops playback or recording.

PLAY (▶), MO./ST. : Starts playback. Selects Mono/ Stereo.

PAUSE/STEP (⏸) : Pauses playback.

SKIP (◀◀ / ▶▶) : Goes to next or previous chapter/ track/ file.

SCAN (◀◀/▶▶) : Searches backward or forward.

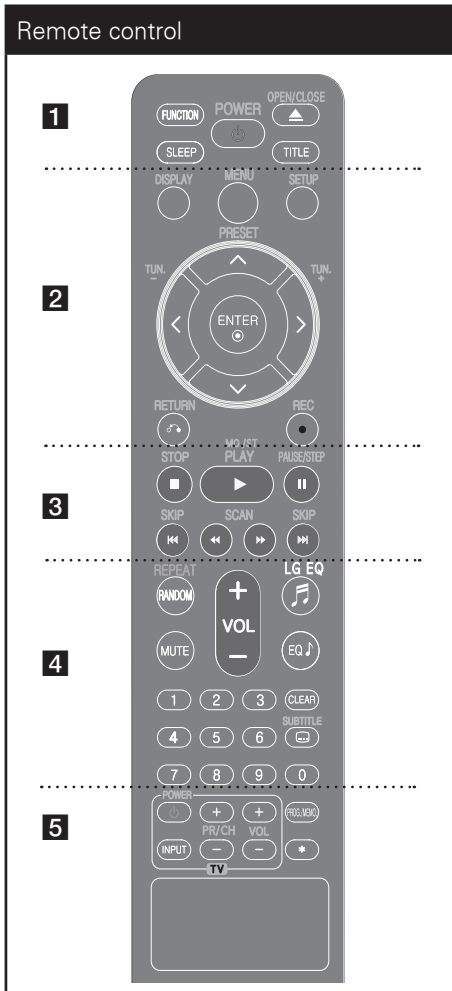

..... 4

REPEAT/RANDOM : Selects a play mode.(Random, repeat)

MUTE : Mutes the sound.

VOL (Volume) (+/-) : Adjusts speaker volume.

LG EQ : Selects a Natural or Local Specialization equalizer effect by using LG EQ.

EQ (EQUALIZER effect) : Chooses sound impressions.

CLEAR : Removes a track number on the Program List.

SUBTITLE : During playback, press **SUBTITLE** repeatedly to select a desired subtitle language .

0 to 9 numerical buttons : Selects numbered options in a menu.

..... 5

TV Control buttons : Controls the TV. (LG TV only)

Controlling the TV

You can control the sound level, input source, and power switching of LG TVs as well. Hold **POWER (TV)** and press **PR/CH (+/-)** button repeatedly until the TV turns on or off.

PROG./MEMO. : Accesses or removes Program menu.

★ : This button is not available.

Put the battery into the remote control

Make sure the + (plus) and – (minus) on the battery are positioned as indicated in the remote control.

2 Preparation

3 Installation

3

Installation

Connecting the speakers

Attaching the speakers to the unit

To connect the cable to the unit, press each plastic finger pad to open the connection terminals on the unit. Insert the wire and release the finger pad.

Connect the black end of each wire to the terminals marked - (minus) and the other end to the terminals marked + (plus).

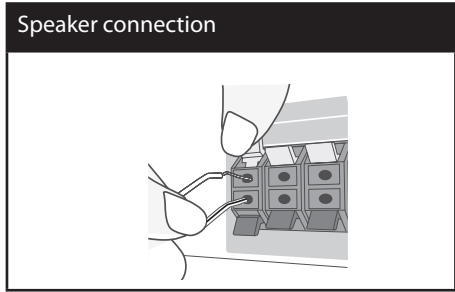

CAUTION

- Be careful to make sure children do not put their hands or any objects into the *speaker duct.
*Speaker duct: A hole that enhances bass sound on speaker cabinet (enclosure).
- The speakers contain magnet parts, so color irregularity may occur on the TV screen or PC monitor screen. Please use the speakers far away from either TV screen or PC monitor.

Positioning the System

The following illustration shows an example of positioning the system.

Note that the illustrations in these instructions differ from the actual unit for explanation purposes.

For the best possible surround sound, all the speakers other than the subwoofer should be placed at the same distance from the listening position (A).

- (A) Front left speaker (L)/ (B) Front right speaker (R):
Place the front speakers to the sides of the monitor or screen and as flush with the screen surface as possible.
- (C) Center speaker: Place the center speaker above or below the monitor or screen.
- (D) Surround left speaker (L)/ (E) Surround right speaker (R):
Place these speakers behind your listening position, facing slightly inwards.
- (F) Subwoofer: The position of the subwoofer is not so critical, because low bass sounds are not highly directional. But it is better to place the subwoofer near the front speakers. Turn it slightly toward the center of the room to reduce the wall reflections.
- (G) Unit.

Speaker Positioning

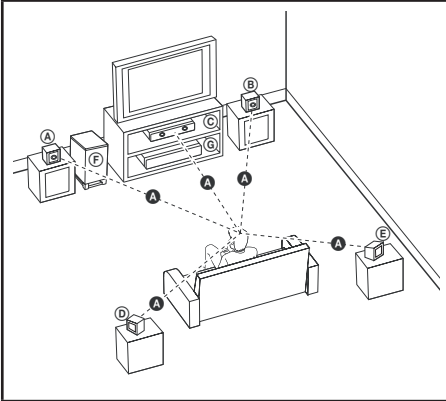

NOTE

If the picture on nearby TV sets becomes distorted, keep the speaker away from your TV

CAUTION

- Make sure the unit is connected directly to the TV. Tune the TV to the correct video input channel.
- Do not connect your unit via your VCR. The image could be distorted by the copy protection encoding on the source material.

Component Video Connection

Connect the COMPONENT VIDEO (PROGRESSIVE SCAN) OUTPUT jacks on the unit to the corresponding input jacks on the TV using Y Pb Pr cables.

You can hear the sound through the system's speakers.

Component Video Connection

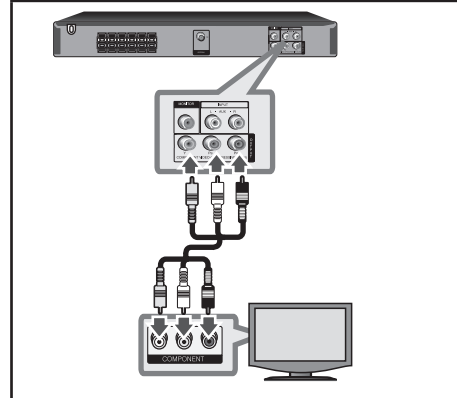

NOTE

If your TV accepts progressive format signals, you must use this connection and set [Progressive Scan] in [Display] setup to [On] (See page 17).

Connections to Your TV

Make one of the following connections, depending on the capabilities of your existing equipment.

NOTE

- Depending on your TV and other equipment you wish to connect, there are various ways you could connect the player. Use only one of the connections described in this manual.
- Please refer to the manuals of your TV, Stereo System or other devices as necessary to make the best connections.

Video Connection

Connect the VIDEO OUT (MONITOR) jack on the unit to the video in jack on the TV using a video cable.

You can hear the sound through the system's speakers.

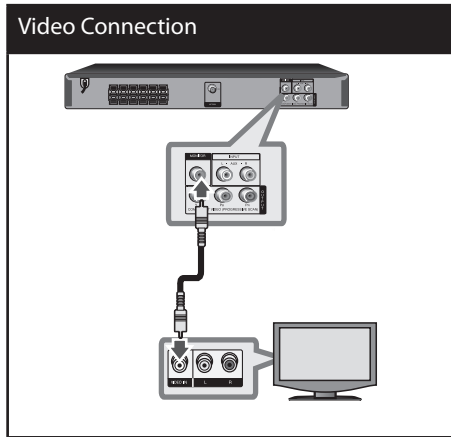

Optional Equipment Connection

AUX IN Connection

Connect the Output of an auxiliary device to the AUX Input (L/R) Connector. If your TV has only one output for audio (mono), connect it to the left (white) audio jack on the unit.

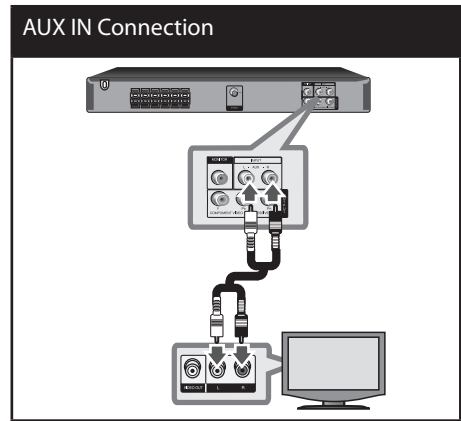

AUDIO IN (Portable IN) Connection

Connect the OUTPUT of a portable device (MP3 or PMP etc) to the P. IN input connector.

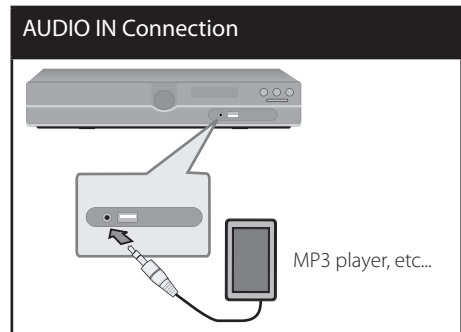

3

Installation

USB Connection

Connect the USB plug of a USB Memory (or MP3 player, etc.) to the USB port on the front of the unit.

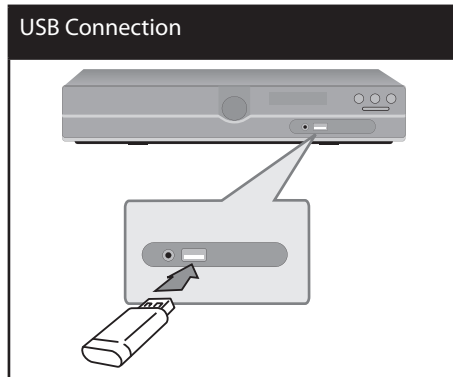

Removing the USB Device from the unit

1. Choose a different function mode or press STOP (■) twice in a row.
2. Remove the USB device from the unit.

Antenna Connection

Connect the supplied FM antenna for listening to the radio.

Connect the FM Wire antenna to the FM antenna connector.

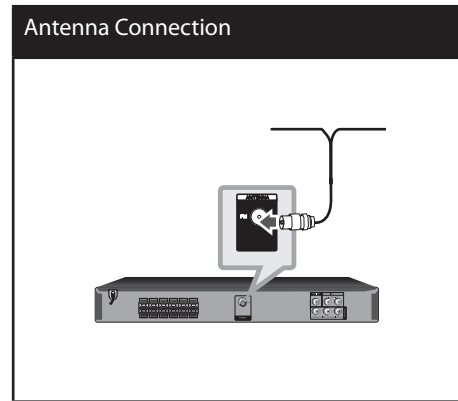

! NOTE

Be sure to fully extend the FM wire antenna. After connecting the FM wire antenna, keep it as horizontal as possible.

Adjust the Setup settings

By using the Setup menu, you can make various adjustments to items such as picture and sound. You can also set a language for the subtitles and the Setup menu, among other things. For details on each Setup menu item, see pages 16 to 19.

3 Installation

OSD Initial language settings - Optional

During the first use of this unit, the initial language setup menu appears on your TV screen. You must complete initial language selection before using the unit. English will be selected as the initial language.

1. Press **POWER** to turn the unit on. The language setup menu will appear on the screen.

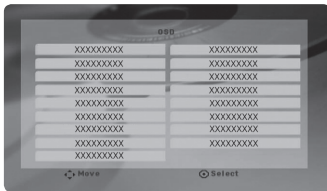

2. Use **^ V < >** to select a language then press **ENTER**. The confirm menu will appear.



3. Use **< >** to select [Enter] then press **ENTER** to finish the language setup.

To display and exit the Setup Menu

1. Select the DVD/CD or USB function by pressing **FUNCTION**.
2. Press **SETUP**. Displays the [SETUP] Menu.
3. Press **SETUP** or **RETURN** to exit the [SETUP] Menu.

About help menu for Setup

Menu	Buttons	Operation
▲/▼ Move	^ V	Moving to another menu.
◀ Prev.	<	Moving to previous level.
▶ Select	>	Moving to next level or selecting menu.
	RETURN	To exit the [Setup] menu or [5.1 Speaker Setup].
	ENTER	To confirm menu.

LANGUAGE

Menu Language

Select a language for the Setup menu and then on screen display.

Disc Audio / Disc Subtitle / Disc Menu

Select the language you prefer for the audio track (disc audio), subtitles, and the disc menu.

Original – Refers to the original language in which the disc was recorded.

Other – To select another language, press numeric buttons and then **ENTER** to enter the corresponding 4-digit number according to the language code list on the page 29. If you enter the wrong language code, press **CLEAR**.

Off (for Disc Subtitle) – Turn off Subtitle.

DISPLAY

TV Aspect

Select which screen aspect to use based on the shape of your TV screen.

4:3 – Select when a standard 4:3 TV is connected.

16:9 – Select when a 16:9 wide TV is connected.

Display Mode

The Display Mode setting works only when the TV Aspect mode is set to 4:3.

Letterbox – Displays a wide picture with bands on the upper and lower portions of the screen.

Panscan – Automatically displays the wide picture on the entire screen and cuts off the portions that do not fit. (If the disc/file is not compatible with Pan Scan, the picture is displayed at Letterbox ratio.)

Progressive Scan (For Component Video connections)

Selects whether the COMPONENT VIDEO(PROGRESSIVE SCAN) OUTPUT jacks output progressive signal. If your TV accepts progressive format signals, you will enjoy accurate color reproduction and high quality image by selecting [On]. If your TV does not accept progressive format signals, select [Off]. If you set Progressive Scan to [On] in error, you must reset the unit. First, remove the disc from the unit. Next, press and hold **STOP** for

five seconds. The video output will be restored to the standard setting, and a picture will be visible on your TV.

AUDIO

DRC (Dynamic Range Control)

Make the sound clear when the volume is turned down (Dolby Digital only). Set to [On] for this effect.

Vocal

Select [On] to mix karaoke channels into normal stereo.

This function is effective for multi-channel karaoke DVDs only.

5.1 Speaker Setup

Make the following settings for the built-in 5.1 channel surround decoder.

1. Press **SETUP**.
2. Use $\wedge \vee$ to select AUDIO menu and then press \triangleright .
3. Use $\wedge \vee$ to select [5.1 Speaker setup] menu and then press \triangleright .
4. Press **ENTER**
The [5.1 Speaker setup] appears.



5. Use $\triangleleft \triangleright$ to select the desired speaker.
6. Adjust options using $\wedge \vee \triangleleft \triangleright$ buttons.
7. Press **RETURN** to confirm your selection.
Return to the previous menu.

Speaker selection

Select a speaker that you want to adjust.



NOTE

Certain speaker settings are prohibited by the Dolby Digital licensing agreement.

Size – Since the speaker settings are fixed, you cannot change the settings.

Volume – Press $\triangleleft \triangleright$ to adjust the output level of the selected speaker.

Distance – After you connect the speakers to your unit, set the Distance between the speakers and your listening point if the distance of Center or Rear speakers is bigger than the distance of Front speakers. This allows the sound from each speaker to reach the listener at the same time. Press $\triangleleft \triangleright$ to adjust the Distance of the selected speaker. This distance is equivalent to the difference between the Center or Rear speaker and Front speakers.

Test – Press $\triangleleft \triangleright$ to test the signals of each speaker. Adjust the volume to match the volume of test signals memorized in the system.

LOCK (Parental Control)

Initial Setting of the Area Code:

When you use this unit for the first time, you have to set the Area Code.

1. Select the [LOCK] menu and then press \triangleright .
2. Press \triangleright .
To access the [LOCK] options, you must input the password you have created. Input a password and press **ENTER**. Enter it again and press **ENTER** to verify. If you make a mistake before pressing **ENTER**, press **CLEAR**.
3. Select the first character using $\wedge \vee$ buttons.
4. Press **ENTER** and select the second character using $\wedge \vee$ buttons.
5. Press **ENTER** to confirm your Area code selection.

Rating

Blocks playback of rated DVDs based on their contents. Not all discs are rated.

1. Select [Rating] on the [LOCK] menu then press **>**
2. Input a password and press **ENTER**.
3. Select a rating from 1 to 8 using the **▲ ▼** buttons.

Rating 1-8 – Rating one (1) has the most restrictions and rating eight (8) is the least restrictive.

Unlock – If you select unlock, parental control is not active and the disc plays in full.

4. Press **ENTER** to confirm your rating selection.

Password

You can enter or change password.

1. Select [Password] on the [LOCK] menu and then press **>**.
2. Input a password and press **ENTER**.

To change the password, press **ENTER** when the [Change] option is highlighted. Input a password and press **ENTER**. Enter it again and press **ENTER** to verify.

3. Press **SETUP** to exit the menu.



NOTE

If you forget your password, you can clear it using the following steps:

1. Press **SETUP** to display the Setup menu.
2. Input the 6-digit number "210499" and press **ENTER**. The password is cleared.

Area Code

Enter the code of the area whose standards were used to rate the DVD video disc, based on the list on page 30.

1. Select [Area Code] on the [LOCK] menu then press **>**.
2. Input a password and press **ENTER**.
3. Select the first character using **▲ ▼** buttons.
4. Press **ENTER** and select the second character using **▲ ▼** buttons.
5. Press **ENTER** to confirm your Area code selection.

OTHERS

DivX(R) VOD

We provide you with the DivX® VOD (Video On Demand) registration code that allows you to rent and purchase videos using the DivX® VOD service.

For more information, visit www.divx.com/vod.

Press **ENTER** when [DivX(R) VOD] is highlighted and you can view the registration code of the unit.



NOTE

All the downloaded videos from DivX® VOD can only be played back on this unit.

4 Operation

Basic Operations

1. Insert the disc by Pressing **OPEN/CLOSE** or connect the USB device to the USB port.
2. Select the DVD/CD or USB function by pressing **FUNCTION**.
3. Select a file (or track/ title) you want to play by pressing **▲ ▼ < >**.

NOTE

When playing a disc or USB Flash Drive containing DivX, MP3/ WMA and JPEG files together, you can select menu of files which you would like to play by pressing **MENU**. If "This file has non-supported type on the unit" pops up, select an appropriate file by pressing **MENU**.

To	Do this
Stop	Press ■
Playback	Press ▶
Pause	Press PAUSE/STEP
Frame-by-Frame playback	Press PAUSE/STEP repeatedly to play title Frame-by-Frame.
Skipping to the next/ previous chapter/ track/ file	During playback, press ⏮ or ⏭ to go to the next chapter/track or to return to the beginning of the current chapter/track. Press ⏮ twice briefly to step back to the previous chapter/track.
Locating a point quickly by playing a file in fast forward or fast reverse	During playback, press ⏩ or ⏪ repeatedly to select the required scan speed. To return to normal speed, press PLAY .
Playing repeatedly or randomly	Press REPEAT/RANDOM repeatedly, and the current title, chapter or track will be played back repeatedly or randomly. - Random play mode : only music files.
Slowing down the playing speed	In the pause mode, press SCAN (⏩ or ⏪) to select the required speed.

4

Operation

Other Operations

Displaying Disc Information on-screen

You can display various information about the disc loaded on-screen.

1. Press **DISPLAY** to show various playback information.
The displayed items differ depending on the disc type or playing status.
2. You can select an item by pressing $\wedge \vee$ and change or select the setting by pressing $< >$.

 Title – Current title number/ total number of titles.

 1/23 Chapter – Current chapter number/ total number of chapters.

 0:03:24 Time – Elapsed playing time.

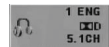
 1 ENG 5.1CH Audio – Selected audio language or channel.

 Off Subtitle – Selected subtitle.

 1/1 Angle – Selected angle/total number of angles.

 BYPASS Sound – Selected sound mode



NOTE

If no button is pressed for a few seconds, the onscreen display disappears.

To display the DVD Menu **DVD**

When you play a DVD which contains several menus, you can select the menu you want using the Menu.

1. Press **MENU**.
The disc's menu appears.
2. Select the menu by using $\wedge \vee < >$.
3. Press **PLAY** to confirm.

To display the DVD Title **DVD**

When you play a DVD which contains several titles, you can select the title you want using the Menu.

1. Press **TITLE**.
The disc's title appears.
2. Select the menu by pressing $\wedge \vee < >$.
3. Press **PLAY** to confirm.



Selecting a subtitle language

DVD DivX

During playback, press **SUBTITLE** () repeatedly to select a desired subtitle language.

1.5 times speed playback **DVD**

The 1.5 speed allows you to watch the pictures and listen to the sound quicker than playing at a normal speed.

1. During playback, press **PLAY** () to play at 1.5 times speed. "▶X1.5" appears on the screen.
2. Press **PLAY** () again to exit.

Starting play from selected time **DVD** **DivX**

To start playing at any chosen time on the file or title.

1. Press **DISPLAY** during playback.
2. Press **Λ V** to select the time clock icon and “--:--:--” appears.
3. Input the required start time in hours, minutes, and seconds from left to right. If you enter the wrong numbers, press **CLEAR** to remove the numbers you entered. Then input the correct numbers.
For example, to find a scene at 1 hour, 10 minutes, and 20 seconds, enter “11020” by using numerical buttons.
4. Press **ENTER** to confirm. Playback starts from the selected time.

4

Operation

Last Scene Memory **DVD**

This unit memorizes the last scene from the last disc that is viewed. The last scene remains in memory even if you remove the disc from the player or switch off (Stand-by mode) the unit. If you load a disc that has the scene memorized, the scene is automatically recalled

Changing the character set to display DivX® subtitle correctly

DivX

If the subtitle does not display properly during playback press and hold **SUBTITLE** for about 3 seconds then press **< >** or **SUBTITLE** to select another language code until the subtitle is displayed properly and then press **ENTER**.

Programmed Playback **ACD**

MP3 **WMA**

The program function enables you to store your favourite files from any disc or USB device.

A program can contain 30 tracks/files.

1. Select the DVD/CD or USB function by pressing **FUNCTION**.
2. To add music on the program list, press **PROG./MEMO**. to enter the program edit mode (E mark appears on the menu).
3. Select a desired music title on the [List] by using the **Λ V** then press **ENTER** to add the music to the program list.
4. Select music from the program list then press **ENTER** to start programmed playback.

Erasing a file from Program List

1. Use **Λ V** to select the track that you wish to erase from the Program list.
2. Press **CLEAR**.

Erasing the Complete Program List

Use **Λ V < >** to select [Clear All] then press **ENTER**.

**NOTE**

The programs are also cleared when the disc or USB device is removed, the unit is switched to power off or the function is switched to others.

Viewing a PHOTO file **JPG**

This unit can play discs with photo files.

1. Select the DVD/CD or USB function by pressing **FUNCTION**.
2. Press **▲ ▼** to select a folder, and then press **ENTER**.
A list of files in the folder appears.
If you are in a file list and want to return to the previous folder list, use the **▲ ▼** buttons on the remote to highlight **■...** and press **ENTER**.
3. If you want to view a particular file, press **▲ ▼** to highlight a file and press **ENTER** or **PLAY**. While viewing a file, you can press **STOP** to move to the previous menu (JPEG menu).

Viewing photo files as a slide show **JPG**

1. Highlight the file (not folder) which you like to choose to begin the slide show.
2. Use **▲ ▼ < >** to highlight the Speed. Then, use **< >** to select the (>/ >>/ >>>) option you want to use and then press **ENTER**.
3. Use **▲ ▼ < >** to highlight the (Slide Show) then press **ENTER**.

About help menu for slide show

Menu	Buttons	Operation
▲/▼	▲/▼	Rotating the picture
◀◀/ ▶▶ Prev./ Next	</>	Moving to another file
■	STOP	Closing the slide show
↶	RETURN	Closing the help menu

Listening to music during slide show **JPG**

You can listen to music during slide show, if the disc contain music and photo files together. Use **▲ ▼ < >** to highlight (**🎵**) icon then press **ENTER** to start slide show.

! NOTE

This function is available only in disc mode.

Sleep Timer Setting

Press **SLEEP** one or more times to select the delay time between 10 and 180 minutes, after which the unit will turn off.

To check the remaining time, press **SLEEP**.

To cancel the sleep function, press **SLEEP** repeatedly until "SLEEP 10" appears, and then press **SLEEP** once again while "SLEEP 10" is displayed.

! NOTE

You can check the remaining time before the unit turns off.

Dimmer

Press **SLEEP** once. The display window brightness will be reduced by half. To cancel it, press **SLEEP** repeatedly until dim off.

Turn off the sound temporarily

Press **MUTE** to mute your unit.

You can mute your unit, for example, to answer the telephone, "MUTE" will be displayed in the display window.

Screen Saver

The screen saver appears when you leave the unit in Stop mode for about five minutes.

System Select - Optional

You must select the appropriate system mode for your TV system. If "NO DISC" appears in the display window, press and hold **PAUSE/STEP** (II) for more than five seconds to be able to select a system. (AUTO/ PAL/ NTSC)

Displaying file information (ID3 TAG)

While playing an MP3 file containing file information, you can display the information by pressing **DISPLAY**.

Radio Operations

Be sure that FM aerial is connected.
(Refer to the page 15)

Listening to the Radio

1. Press **FUNCTION** until FM appears in the display window.
The last received station is tuned in.
2. Press and hold **TUN.(-/+)** for about two seconds until the frequency indication starts to change, then release. Scanning stops when the unit tunes in a station.

or

Press **TUN.(-/+)** repeatedly.

3. Adjust the volume by rotating **VOL.** on the front panel or by pressing **VOL +** or **-** on the remote control repeatedly.

Presetting the Radio Stations

You can preset 50 stations for FM .

Before tuning, make sure that you have turned down the volume.

1. Press **FUNCTION** until FM appears in the display window.
2. Select the desired frequency by using **TUN.(-/+)**
3. Press **PROG./MEMO**. a preset number will flash in the display window.
4. Press **PRESET (^V)** to select the preset number you want.
5. Press **PROG./MEMO**.
The station is stored.
6. Repeat the steps 2 to 5 to store other stations.

Deleting all the saved stations

1. Press and hold **PROG./MEMO.** for two seconds.
"ERASE ALL" will flash up on the unit display.
2. Press **PROG./MEMO.** to erase all of the saved radio stations.

Improving poor FM reception

Press **PLAY** (▶) (MO./ST.) on the remote control. This will change the tuner from stereo to mono and usually improve the reception.

Sound adjustment

Setting the surround mode

This system has a number of pre-set surround sound fields. You can select a desired sound mode by using **EQ/ LG EQ**. You can change the **EQ/ LG EQ** using < > arrow key while the **EQ/ LG EQ** information is displayed.

The displayed items for the Equalizer may be different depending on sound sources and effects.

On Display	Description
NAT PLUS	You can enjoy the natural sound effect same as a 5.1-channel.
NATURAL	You can enjoy comfortable and natural sound.
Local Specialization equalizer	Regionally optimized sound effect. (DANGDUT/ ARABIC/ PERSIAN/ INDIA/ REGUETON/ MERENGUE/ SALSA/ SAMBA/ CUMBIA/ AFRO)

On Display	Description
AUTO EQ	Sets the sound equalizer to the mode that is the most similar to the genre which is included in the MP3 ID3 tag of song files.
POP CLASSIC JAZZ ROCK	This program lends an enthusiastic atmosphere to the sound, giving you the feeling you are at an actual rock pop, jazz or classic concert.
MP3 OPT	This function is optimized for compressible MP3 file. It improves the treble sound.
BASS	During playback, Reinforces the treble, bass and surround sound effect.
VIRTUAL	You can enjoy more virtual surround sound.
PLII MOVIE PLII MUSIC	Dolby Pro Logic II enables you to play stereo source on 5.1-channel.
BYPASS	You can enjoy the sound without equalizer effect.



NOTE

- In some surround modes, on some speakers, there's no sound or low sound. it, depends on the mode of surround and the source of audio, it is not defective.
- You may need to reset the surround mode, after switching the input, sometimes even after the sound track is changed.

Advanced Operations

Listening to music from your portable player or external device

The unit can be used to play the music from many types of portable player or external devices. (Refer to the page 14)

1. Connect the portable player to the P. IN(PORTABLE IN) connector on the unit.

Or

Connect the external device to the AUX connector of the unit.

2. Turn the power on by pressing **POWER**.
3. Select the PORTABLE or AUX function by pressing **FUNCTION**.
4. Turn the portable player or external device on and start it playing.

Recording to USB

1. Connect the USB device to the unit.
2. Select the DVD/ CD function by pressing **FUNCTION**.

One track recording - You can record to USB while playing the wanted file.

All tracks recording - You can record to USB after stopping playback.

Program list recording - After moving to the programmed list you can record it to USB.

3. Start the recording by pressing ● **REC**.
4. To stop recording, press ■ **STOP**.



NOTE

- You can check the recording percentage rate for the USB record on the screen during the recording.
- When you stop recording during playback, the file that has been recorded at that time will be stored.
- Do not remove the USB device during USB recording. It will result in an incomplete file being made and may not be deleted on a PC.
- If USB recording does not work, messages like "NO USB", "ERROR", "USB FULL" or "NO REC" will be displayed on the display window.
- When you stop recording during playback, the file will not be stored.
- USB record is not possible from CD-G discs.
- You may not store more than 999 files.
- It'll be stored as TRK_001 on CD FOLDER.

The making of unauthorized copies of copy-protected material, including computer programs, files, broadcasts and sound recordings, may be an infringement of copyrights and constitute a criminal offense. This equipment should not be used for such purposes.

**Be responsible
Respect copyrights**

5 Maintenance

Handling the Unit

When shipping the Unit

Please save the original shipping carton and packing materials. If you need to ship the unit, for maximum protection, re-pack the unit as it was originally packed at the factory.

Keeping the exterior surfaces clean

- Do not use volatile liquids such as insecticide spray near the unit.
- Wiping with strong pressure may damage the surface. Do not leave rubber or plastic products in contact with the unit for a long period of time.

Cleaning the Unit

To clean the unit, use a soft, dry cloth. If the surfaces are extremely dirty, use a soft cloth lightly moistened with a mild detergent solution.

Do not use strong solvents such as alcohol, benzene, or thinner, as these might damage the surface of the unit.

Maintaining the Unit

The unit is a high-tech, precision device. If the optical pick-up lens and disc drive parts are dirty or worn, the picture quality could be diminished. For details, please contact your nearest authorized service center.

Notes on Discs

Handling Discs

Never stick paper or tape on the disc.



Storing Discs

After playing, store the disc in its case. Do not expose the disc to direct sunlight or sources of heat and never leave it in a parked car exposed to direct sunlight.

Cleaning Discs

Fingerprints and dust on the disc can cause poor picture quality and sound distortion. Before playing, clean the disc with a clean cloth. Wipe the disc from the center out. Do not use strong solvents such as alcohol, benzene, thinner, commercially available cleaners, or anti-static spray intended for older vinyl records.



6 Troubleshooting

PROBLEM	CAUSE	CORRECTION
No Power	The power cord is disconnected.	Plug the power cord into the wall outlet securely.
No Picture	The TV is not set to receive the DVD signal.	Select the appropriate video input mode on the TV so the picture from the DVD Receiver appears on the TV screen.
	The video cables are not connected securely.	Connect the video cables securely to both the TV and DVD Receiver.
There is little or no sound	Equipment connected via the audio cable is not set to receive DVD signal output.	Select the correct input mode of the audio receiver so you can hear the sound from the DVD receiver.
	The audio cables are not connected to the speakers or receiver securely.	Connect the audio cables into the connection terminals correctly.
	If not, connect speaker cables correctly.	Speaker cables connected correctly.
The DVD picture quality is poor	The disc is dirty.	Clean the disc using a soft cloth with outward strokes.
A DVD/CD will not play	No disc is inserted.	Insert a disc.
	An unplayable disc is inserted.	Insert a playable disc (check the disc type, colour system and regional code).
	The disc is inserted upside down.	Place the disc with the label or printed side facing upwards.
	The menu is open on screen.	Press SETUP to close the menu screen.
	There is a parental lock which prevents the playback of DVDs with a certain rating.	Enter your password or change the rating level.
Humming noise heard while a DVD or CD is playing	The disc is dirty.	Clean the disc using a soft cloth with outward strokes.
	The DVD receiver is located too close to the TV, causing feedback.	Move DVD receiver and audio components further away from your TV.
Radio stations can't be tuned in properly	The antenna is positioned or connected poorly.	Check the antenna connection and adjust its position. Attach an external aerial if necessary.
	The signal strength of the radio station is too weak.	Tune to the station manually.
	No stations have been preset or preset stations have been cleared (when tuning by scanning preset channels).	Preset some radio stations, see page 24 for details.
The remote control doesn't work well / at all	The remote is not pointed directly at the unit.	Point the remote directly at the unit.
	The remote is too far from the unit.	Use the remote within 23 feet (7m) of the DVD receiver.
	There is an obstacle in the path between the remote control and the unit.	Remove the obstacle.
	The battery in the remote control is flat.	Replace the battery with new ones.

6

Troubleshooting

7

Appendix

Language Codes

Use this list to input your desired language for the following initial settings: Disc Audio, Disc Subtitle, Disc Menu.

Language	Code	Language	Code	Language	Code	Language	Code
Afar	6565	French	7082	Lithuanian	7684	Singhalese	8373
Afrikaans	6570	Frisian	7089	Macedonian	7775	Slovak	8375
Albanian	8381	Galician	7176	Malagasy	7771	Slovenian	8376
Ameharic	6577	Georgian	7565	Malay	7783	Spanish	6983
Arabic	6582	German	6869	Malayalam	7776	Sudanese	8385
Armenian	7289	Greek	6976	Maori	7773	Swahili	8387
Assamese	6583	Greenlandic	7576	Marathi	7782	Swedish	8386
Aymara	6588	Guarani	7178	Moldavian	7779	Tagalog	8476
Azerbaijani	6590	Gujarati	7185	Mongolian	7778	Tajik	8471
Bashkir	6665	Hausa	7265	Nauru	7865	Tamil	8465
Basque	6985	Hebrew	7387	Nepali	7869	Telugu	8469
Bengali; Bangla	6678	Hindi	7273	Norwegian	7879	Thai	8472
Bhutani	6890	Hungarian	7285	Oriya	7982	Tonga	8479
Bihari	6672	Icelandic	7383	Panjabi	8065	Turkish	8482
Breton	6682	Indonesian	7378	Pashto, Pushto	8083	Turkmen	8475
Bulgarian	6671	Interlingua	7365	Persian	7065	Twi	8487
Burmese	7789	Irish	7165	Polish	8076	Ukrainian	8575
Byelorussian	6669	Italian	7384	Portuguese	8084	Urdu	8582
Chinese	9072	Javanese	7487	Quechua	8185	Uzbek	8590
Croatian	7282	Kannada	7578	Rhaeto-Romance	8277	Vietnamese	8673
Czech	6783	Kashmiri	7583	Rumanian	8279	Volapük	8679
Danish	6865	Kazakh	7575	Russian	8285	Welsh	6789
Dutch	7876	Kirghiz	7589	Samoan	8377	Wolof	8779
English	6978	Korean	7579	Sanskrit	8365	Xhosa	8872
Esperanto	6979	Kurdish	7585	Scots Gaelic	7168	Yiddish	7473
Estonian	6984	Laothian	7679	Serbian	8382	Yoruba	8979
Faroese	7079	Latin	7665	Serbo-Croatian	8372	Zulu	9085
Fiji	7074	Latvian, Lettish	7686	Shona	8378		
Finnish	7073	Lingala	7678	Sindhi	8368		

Area Codes

Choose a area code from this list.

Area	Code	Area	Code	Area	Code
Afghanistan	AF	Hong Kong	HK	Poland	PL
Argentina	AR	Hungary	HU	Portugal	PT
Australia	AU	India	IN	Romania	RO
Austria	AT	Indonesia	ID	Russian Federation	RU
Belgium	BE	Israel	IL	Saudi Arabia	SA
Bhutan	BT	Italy	IT	Senegal	SN
Bolivia	BO	Jamaica	JM	Singapore	SG
Brazil	BR	Japan	JP	Slovak Republic	SK
Cambodia	KH	Kenya	KE	Slovenia	SI
Canada	CA	Kuwait	KW	South Africa	ZA
Chile	CL	Libya	LY	South Korea	KR
China	CN	Luxembourg	LU	Spain	ES
Colombia	CO	Malaysia	MY	Sri Lanka	LK
Congo	CG	Maldives	MV	Sweden	SE
Costa Rica	CR	Mexico	MX	Switzerland	CH
Croatia	HR	Monaco	MC	Taiwan	TW
Czech Republic	CZ	Mongolia	MN	Thailand	TH
Denmark	DK	Morocco	MA	Turkey	TR
Ecuador	EC	Nepal	NP	Uganda	UG
Egypt	EG	Netherlands	NL	Ukraine	UA
El Salvador	SV	Netherlands Antilles	AN	United States	US
Ethiopia	ET	New Zealand	NZ	Uruguay	UY
Fiji	FJ	Nigeria	NG	Uzbekistan	UZ
Finland	FI	Norway	NO	Vietnam	VN
France	FR	Oman	OM	Zimbabwe	ZW
Germany	DE	Pakistan	PK		
Great Britain	GB	Panama	PA		
Greece	GR	Paraguay	PY		
Greenland	GL	Philippines	PH		

Specifications

General

Power supply	Refer to main label.
Power consumption	Refer to main label.
Net Weight	2.5 kg
External dimensions (W x H x D)	360 x 65 x 320 mm
Bus Power Suply (USB)	DC 5 V $\overline{\text{---}}$ 500 mA
Operating conditions Temperature	5 °C to 35 °C, Operation status: Horizontal
Operating humidity	5 % to 85 %
Laser	Semiconductor laser, wavelength 650 nm

Tuner FM

FM Tuning Range	87.5 to 108.0 MHz or 87.50 to 108.00 MHz
FM Intermediate Frequency	128 kHz

Amplifier

Stereo mode	45 W + 45 W (4 Ω at 1 kHz, THD 10 %)
Surround mode Front	45 W + 45 W (THD 10 %)
Center	45 W
Surround	45 W + 45 W (4 Ω at 1 kHz, THD 10 %)
Subwoofer	75 W (8 Ω at 30 Hz, THD 10 %)

Speakers

	Front/Rear/Center Speaker	Passive Subwoofer
Type	1 Way 1 Speaker	1 Way 1 Speaker
Impedance	4 Ω	8 Ω
Rated Input Power	45 W	75 W
Max. Input Power	90 W	150 W
Net Dimensions (W x H x D)	103 x 111 x 94 mm	156 x 325 x 320 mm
Net Weight	0.39 kg	3.6 kg

Designs and specifications are subject to change without prior notice.

