



LG

Life's Good

ENGLISH

FRANÇAIS

ESPAÑOL

OWNER'S MANUAL

SXS

REFRIGERATOR

Please read this owner's manual thoroughly before operating and keep it handy for reference at all times.

LSSC 243ST

Table of contents

Introduction	Model/Serial record	3
	Basic safety precautions	3
	Identification of parts	10
Installation	Where to install	11
	Door removal	12
	Mount the freezer and refrigerator compartment doors	13
	Water supply installation	13
	Water connection instruction guide	14
	Height adjustment	17
	Dimensions	19
Operation	Starting	20
	Adjusting the temperatures and functions	20
	Adjusting the temperatures and display	21
	Operating the dispenser	22
	Setting the functions	23
	Shelf	27
	Egg holder	27
	Nano charcoal deodorizer	27
	Fresh compartment	28
	Push 'N Seal Crisper compartment	29
	Freezer/Refrigerator basket	30
	Dairy corner	30
	How to exchange the water purifier filter	31
Suggestion on food storage	Location of foods	32
	Storing foods	33
Care and maintenance	General information	34
	Cleaning	34
	Troubleshooting	35
	It is normal...	40

Model/Serial record

The model and serial numbers are found on the inner case or back of refrigerator compartment of this unit. These numbers are unique to this unit and not available to others. You should record requested information here and retain this guide as a permanent record of your purchase. Staple your receipt here.

Date of purchase : _____
 Dealer purchased from : _____
 Dealer address : _____
 Dealer phone no. : _____
 Model no. : _____
 Serial no. : _____

Basic safety precautions

This guide contains many important safety messages.
 Always read and obey all safety messages.



This is the safety alert symbol. It alerts you to safety messages that inform you of hazards that can kill or hurt you or others or cause damage to the product. All safety messages will be preceded by the safety alert symbol and the hazard signal word DANGER, WARNING, or CAUTION. These words mean:



DANGER

You may be killed or seriously injured if you don't follow instructions.



WARNING

You can be killed or seriously injured if you don't follow instructions.



CAUTION

Indicates an imminently hazardous situation which, if not avoided, may result in minor or moderate injury, or product damage only.

All safety messages will identify the hazard, tell you how to reduce the chance of injury, and tell you what can happen if the instructions are not followed.

WARNING

To reduce the risk of fire, electric shock, or personal injury when using your product, basic safety precautions should be followed, including the following. Read all instructions before using this appliance.

1. When connecting the power

Use a dedicated outlet.

- Using several devices at one outlet may cause a fire.

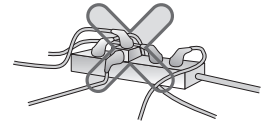

Do not allow the power plug to face upward or to be squeezed at the back of the refrigerator.

Water may be flown into or the plug may be damaged, which causes fire or electric shock.

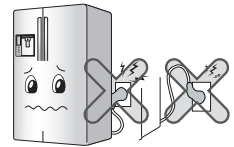

Prevent the power cord from being squeezed or crushed if the refrigerator is pushed in after the power plug is extracted during the installation.

When moving your appliance away from the wall, be careful not to roll over the power cord or to damage it in any way.

It can cause fire or electric shock.

Do not allow the power cord to be bent, crushed, or damaged. Do not run the power cord under heavy objects like furniture, other appliances, or in traffic areas.

It may damage the power cord to cause fire or electric shock.

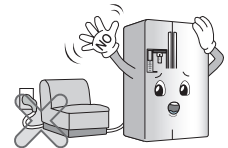

Do not extend or modify the length of the power plug.

Use only an exact factory replacement part to avoid electrical issues, fire, or shock.

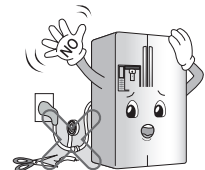

Unplug the power cord when cleaning or moving the refrigerator.

- It may cause electric shock or injury.

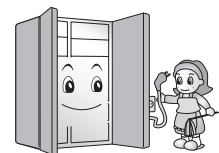

Do not pull out the cord or touch the power plug with wet hands.

It may cause electric shock or injury.

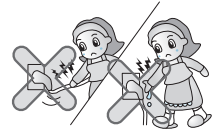

Remove water or dust from the power plug and insert it with the ends of the pins securely connected.

Dust, water, a loose connection may cause a fire or electric shock.

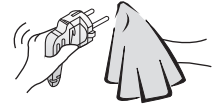

Pull out the power plug not by grasping the cord but the plug of its end.

It may cause electric shock or short circuit to fire.



This grounding method is in violation of the NEC(National Electrical Code.)

Do not show this drawing or offer this advice because it will put us under great liability.

When the power cord or the power plug is damaged or the holes of the outlet are loosed, do not use them.

It may cause electric shock or short circuit to make fire.

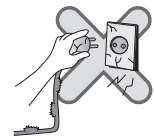

Wait for 5 minutes or longer when reconnecting the plug.

Give the compressor time to cycle before re-starting.

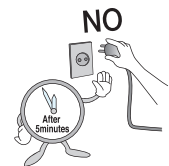

If the supply cord is damaged, it must be replaced by the manufacturer or its service agent or a similarly qualified person in order to avoid a hazard.

2. When using the refrigerator

Do not place the heavy object or the dangerous object (container with liquid) on the refrigerator.

It may fall and cause injury, fire, electric shock when opening or closing the door.



Do not install the refrigerator in a damp place or a place where water drips or splashes, like near a sink or a downspout.

Deterioration of insulation of electric parts may cause electric leakage.

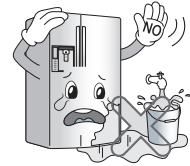

Do not allow children to hang on the refrigerator doors or shelves.

It may cause the refrigerator to tip.



Prevent children from entering the product.

It may endanger the life of a child if the child enters the refrigerator.

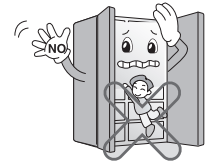

Opening and closing the door of the refrigerator vigorously may cause the stored food in the door basket to fall, damaging the items and possibly the user's foot.

Do not use or store flammable materials like ether, benzene, alcohol, medicine, LP gas, spray, cosmetics near or in the refrigerator.

It may cause explosion or fire.

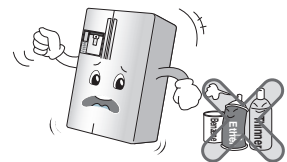

Do not use a hair drier to dry the inside, nor light a candle to remove odor.

It may cause explosion or fire.

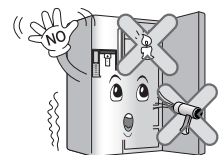

Do not use (Combustible sprays include cooking sprays, oils, and other aerosol products. sometimes both the propellant and the product are flammable. Use caution with these items.)

It may cause fire.

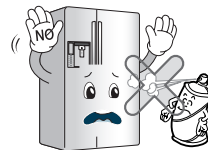

Install the refrigerator where it is not near gas stoves, heaters, water heaters, and other sources of ignition and possible gas leaks.

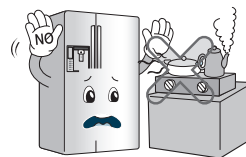

If your model is equipped with a home bar, do not store heavy items on it. They could fall, causing spills, damage, and injury.

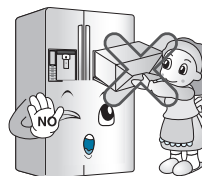

Unplug the refrigerator for extended periods of non-use or in the event of severe electrical storms.

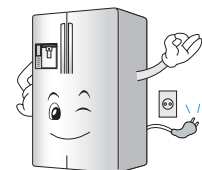

If your refrigerator is submerged or inundated, have it checked by an authorized servicer before operating it.

It may cause electric shock or fire.

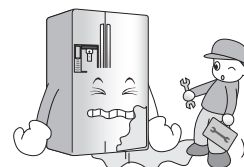

Do not spray water inside or outside the refrigerator, do not clean it with benzene or thinner.

Deterioration of insulation of electric parts may cause electric shock or fire.

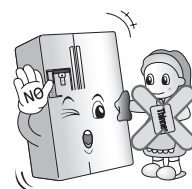

When a strange smell or smoke is detected from the refrigerator, disconnect the power plug immediately and contact the service center.

It may cause fire.



Do not allow any person except an authorized servicer to disassemble, repair, alter the refrigerator.

It may cause injury, electric shock, fire.

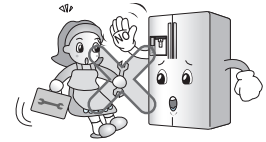

Do not use the refrigerator for non-domestic purpose (storing medicine or testing material, installed in vehicles, aircraft, or maritime vessels.)

It may cause an unexpected risk such as fire, electric shock, deterioration of stored material, chemical reaction.

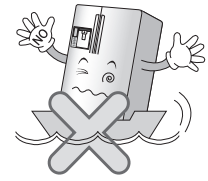

When disposing the refrigerator, remove the packing materials from the door or take off the doors but leave the shelves in place so that children may not easily climb inside.

Child entrapment generally results in death by suffocation.

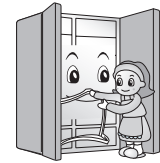

This appliance is not intended for use by persons (including children) with reduced physical, sensory, mental capabilities, or lack of experience and knowledge, unless they have been given supervision or instruction concerning use of the appliance by a person responsible for their safety.

Children should be supervised to ensure that they do not play with the appliance.

Install the refrigerator on the solid and level floor.

If the refrigerator tips when opening or closing the door, it could fall over, causing property damage and personal injury.

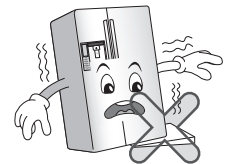

Do not insert the hands or the metal stick into the exit of cool air, the cover, the bottom of the refrigerator, or the vent grille on the back.

It may cause electric shock or injury.

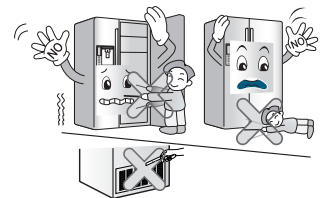

CAUTION

Violating this direction may cause personal injury or property damage. Always be careful, please.

Do not insert the hands into the ice bucket or the ice dispenser.

Operating the ice maker may cause injury.



Do not touch food or containers in the freezer with wet hands.

It may cause frostbite.

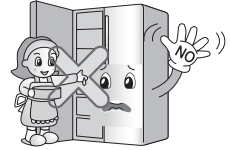

Do not put ice in a thin crystal cup or ceramic ware.

The glass may shatter and present a hazard.

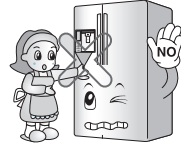

When the electricity is off, remove ice from the ice bucket (only for the model with the dispenser).

If the power is off long enough, the ice will melt and the water will run onto the floor. In the event of a long-term power outage, dump the ice to prevent this.

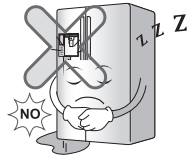

Supply the automatic ice maker with drinkable water only (only for the model with the dispenser).

Non-potable water can cause health risks.

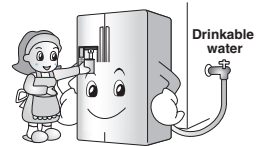

Do not remove the cover of the automatic dispenser. (Only for the models with automatic icemaker)

The operation mechanic parts of the icemaker may hurt people.

Place food items and containers carefully on the shelves in the refrigerator.

The food may fall during opening and closing the door of the refrigerator and hurt people.

Do not put glass bottles or containers in the freezer.

It may freeze the contents to break the bottle, causing injury.



Do not stick your hands under the refrigerator.

Sharp edges, fans, and wires may cause an injury.



Be careful to avoid opening the doors over a pet or someone's feet.

It might cause an injury.

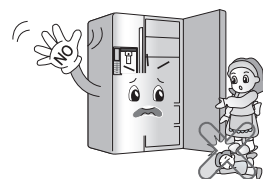

Do not put pets into the refrigerator.



Identification of parts

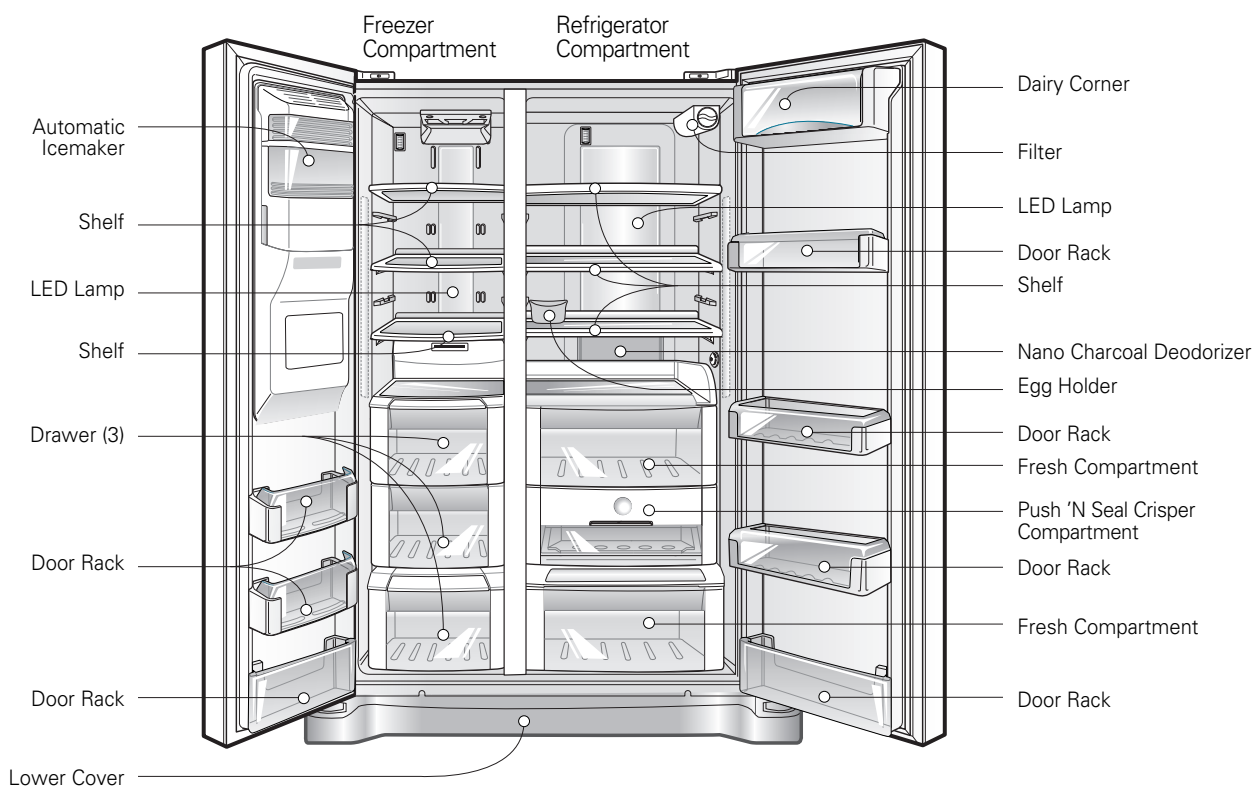

NOTE

- Parts, features, and options vary by model. Your model may not include every option.

Where to install

Strong and even floor

Unstable installation may cause vibration and noise. If the floor to install the refrigerator on is not even, make the refrigerator level by rotating the height adjusting screw. Carpet or floor covering on which a refrigerator is installed may be discolored by heat from the bottom of the refrigerator. Do not allow carpet or flooring to block airflow under the refrigerator.

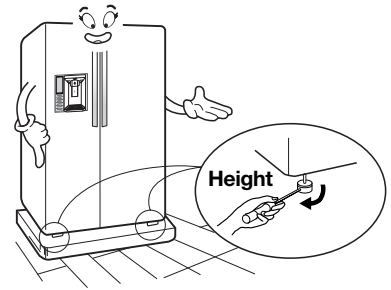

A proper distance from adjacent items

To ensure proper air circulation around the refrigerator-freezer, please maintain sufficient space on both the sides as well as top and maintain at least 2 inches (5 cm) from the rear wall.

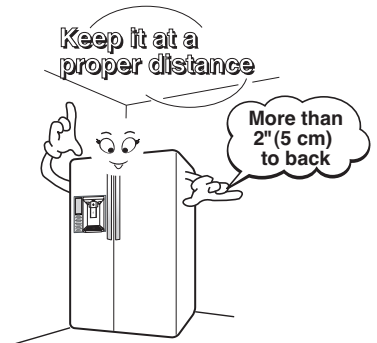

Where water supply can be easily connected in a dry place

Select a place where a water supply can be easily connected between the automatic icemaker and dispenser. Installing the refrigerator in a wet or damp area may cause rust and may be an electrical hazard.

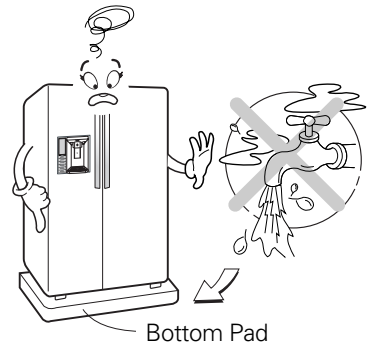

Where it is free from heat

If this refrigerator is installed where the ambient temperature is high, the freezing capacity is deteriorated and the cost of electricity used increases.

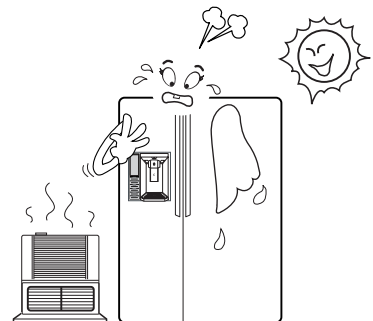

NOTE

- Install the refrigerator at a place where the ambient temperature is 41°F~110°F (5°C ~ 43°C). Ambient temperature outside this range may cause product malfunction. Also, the tube between the dispenser and automatic ice maker may freeze.

WARNING

Door removal

Electric Shock Hazard

Disconnect electrical supply to refrigerator before installing. Failure to do so could result in death or serious injury.

If your access door is too narrow for the refrigerator to pass through, remove the refrigerator door take the refrigerator through sideways.

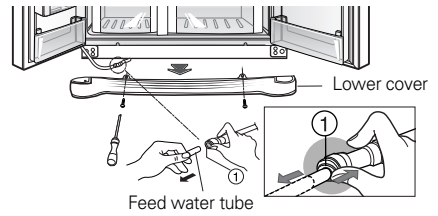

Remove lower cover and then feed water tube

Remove 2 screws holding the lower cover in place. Pull up the feed water tube while pressing area ① shown in the figure to the right.

NOTE

- If a tube end is deformed or abraded, cut the damaged part away to leave a clean, square end.

Remove the freezer compartment door

1) Removing the hinge cover by loosening the screws. Separate all connection wires except the ground wire.

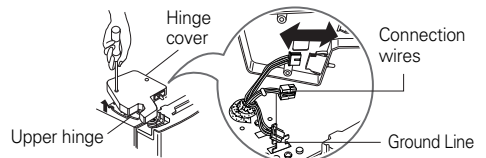

2) Remove the keeper by rotating it counter clockwise (①) and then lifting the upper hinge up (②).

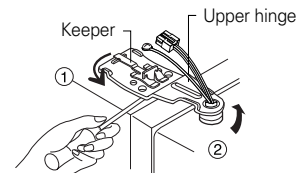

NOTE

- When removing the upper hinge, be careful that the door does not fall forwards .

3) Remove the freezer compartment door by lifting it. This time, the door should be lifted enough for the water tube to be pulled out completely.

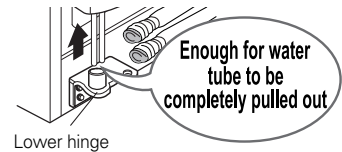

NOTE

- Move the freezer compartment door passing through the access door and lay it down, but be careful not to damage the feed water pipe tube.

Remove the refrigerator compartment door

1) Loosen the hinge cover screws and remove the cover. Remove all connections except the ground wire.

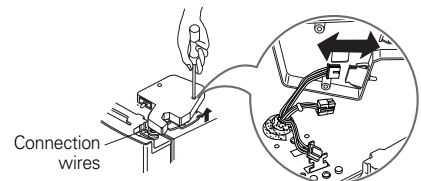

2) Remove keeper by rotating it clockwise (①) and then remove the upper hinge by lifting it up (②).

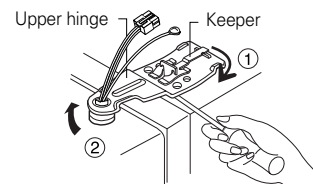

3) Remove the refrigerator compartment door by lifting it up.

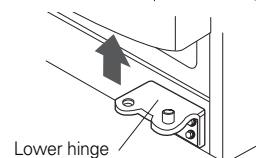

Pass the refrigerator

Take the refrigerator sideways through the access door as shown.

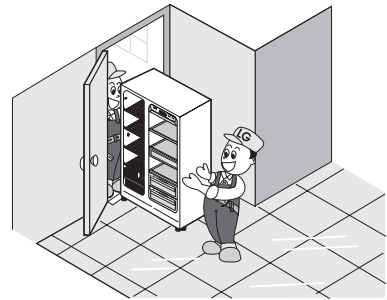

Mount the freezer and refrigerator compartment doors

Mount them in the reverse sequence of removal after the refrigerator is in the kitchen.

Water supply installation

Before installation

- Automatic icemaker operation needs water pressure of 21~121 psi (1.5~8.5 kgf/cm²) (That is, a paper cup (6 oz. or 180 cc) will be fully filled within 3 seconds.)
- If water pressure does not reach the rating 21 psi (1.5 kgf/cm²) or below, it is necessary to purchase a separate pressure pump for normal automatic icemaking and cool water feed.
- Keep the total length of the feed water pipe tube within 26 ft (8 m). Be careful for the tube to avoid being kinked. If the tube is 26 ft (8 m) or longer it may cause trouble in water feed.
- Install the water supply line where it will not be affected by heat.

Connecting the refrigerator to a water source

WARNING

Water connection instruction guide

Read all directions carefully before you begin.

Connect to a potable water supply only.

IMPORTANT

- If operating the refrigerator before installing the water connection, turn icemaker to the **OFF** position to prevent operation without water.
- All installations must be in accordance with local plumbing code requirements.
- Use copper tubing and check for leaks.
- Install copper tubing only in areas where temperatures will remain above freezing.
- It may take up to 24 hours for your icemaker to begin producing ice.

Tools required

- Standard screwdriver
- 7/16-inch and 1/2-inch open-end wrenches or two adjustable wrenches
- 1/4-inch nut driver
- 1/4-inch drill bit
- Hand drill or electric drill (properly grounded)

NOTE

- Your refrigerator dealer has a kit available with a 1/4-inch saddle-type shut-off valve, a union, and copper tubing. Before purchasing, make sure a saddle-type valve complies with your local plumbing codes. Do not use a piercing-type or 3/16-inch saddle valve which reduces water flow and clogs more easily.

We suggest instead of using copper tubing and compression fittings, use a braided, reinforced vinyl line with threaded fittings crimped onto each end. This eliminates the need for plumbing skills on the part of the customer and makes a leakproof installation virtually guaranteed.

Cold water supply

The icemaker water valve contains a flow washer which is used as a water pressure regulator.

The icemaker needs to be connected to a cold water line with water pressure 21 ~ 121 psi (1.5~8.5 kgf/cm²).

Connect the tubing to water line

1. Unplug refrigerator or disconnect power.
2. Turn OFF main water supply. Turn on the nearest faucet to relieve the pressure on the line. It may help to open an outside faucet to allow the water to drain from the line in the house.
3. Find a 1/2-inch vertical COLD water pipe near the refrigerator.

NOTE

- Horizontal pipe will work, but the following precaution must be taken: Drill on the top of the pipe, not the bottom. This will help keep water away from the drill. This also keeps normal sediment from collecting in the valve.

4. To determine length of copper tubing you will need, measure from the connection on the lower left rear of the refrigerator to the water pipe. Add 7 feet (2.1 m) to allow for moving refrigerator for cleaning. Use 1/4-inch O.D. (outside diameter) copper tubing. Be sure both ends of copper tubing are cut square.
5. Using a drill, drill a 1/4-inch hole in the cold water pipe you have selected.
6. Fasten shut-off valve to cold water pipe with pipe clamp. Be sure the outlet end is solidly in the 1/4" drilled hole in the water pipe and the washer is under the pipe clamp. Tighten the packing nut. Tighten the pipe clamp screws carefully and evenly so the washer makes a watertight seal. Do not overtighten or you may crush the copper tubing, especially if soft (coiled) copper tubing is used. Now you are ready to connect the copper tubing.
7. Slip the compression sleeve and the compression nut onto the copper tubing as shown. Insert the end of the tubing into the outlet end squarely as far as it will go. Screw compression nut onto the outlet end with a wrench. A flare nut wrench works best, but an open end wrench will suffice. Do not overtighten.
8. Place the free end of the tubing into a container or sink, and turn on the main water supply. Flush out the tubing until the water is clear. Turn off the shutoff valve on the water pipe. Coil the copper tubing as shown below.

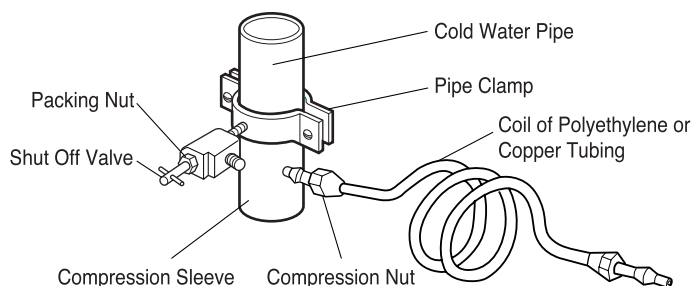

Connect the tubing to the refrigerator

Before making the connection to the refrigerator, be sure the refrigerator power cord is not plugged into the wall outlet.

- If your refrigerator does not have a water filter, we recommend installing one. If your water supply has sand or particles, that could clog the screen of the refrigerator's water valve. Install the filter in the water line near the refrigerator.

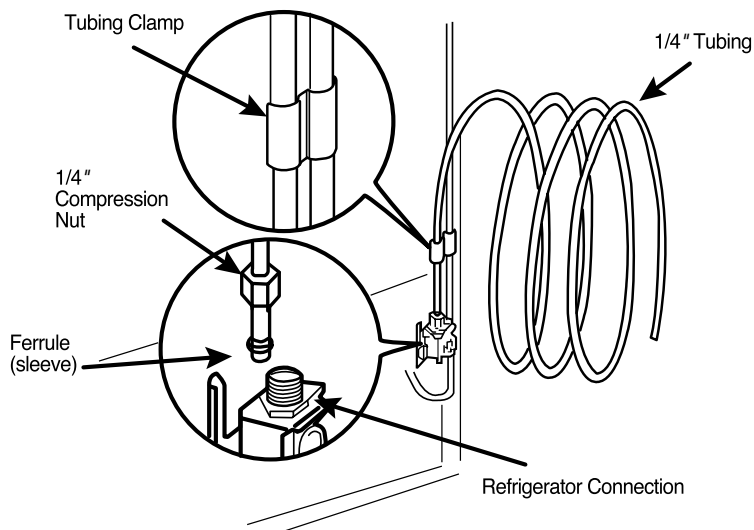

1. Remove the plastic flexible cap from the water valve.
2. Place the compression nut and ferrule (sleeve) onto the end of the tubing as shown.
3. Insert the end of the copper tubing into the connection as far as possible. While holding the tubing, tighten the fitting.

Turn the water on at the shutoff valve

Tighten any connections that leak.

■ Plug In the Refrigerator

Arrange the coil of copper tubing behind the refrigerator so it does not vibrate against the back of the refrigerator or against the wall. Push the refrigerator back to the wall.

■ Start the Icemaker

Set the icemaker switch to the ON position. The icemaker will not begin to operate until it reaches its operating temperature of 15 °F (-9 °C). It will then begin operation automatically.

Height adjustment

When the floor is not leveled

- To level the door when the floor not level.

► When the freezer door is lower – ①

Use the (-) driver or wrench to turn the groove or nut of the height adjustment screw on the left to the clockwise direction to level the door.

► When the refrigerator door is lower – ②

Use the (-) driver or spanner to turn the groove or nut of the height adjustment screw on the right to the clockwise direction to level the door.

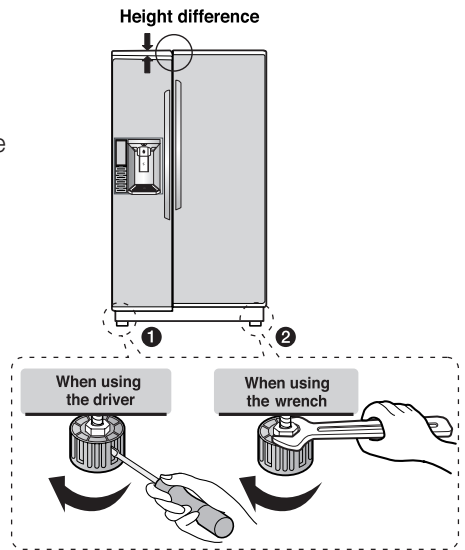

When the refrigerator door is lower than the freezer door

► When the refrigerator door is lower than the freezer door while using the refrigerator, level the doors.

1. Use the ③ tool for adjustment on the wide side to turn nut ① (↻) in the clockwise direction to loosen the keeper nut.
2. Use the ③ tool for adjustment on the narrow side to turn the adjustment hinge pin ② in (↻) clockwise direction or (↻) counterclockwise direction to adjust the height of the refrigerator and freezer doors.
3. After aligning the height of the door, turn the keeper nut counterclockwise tightly.

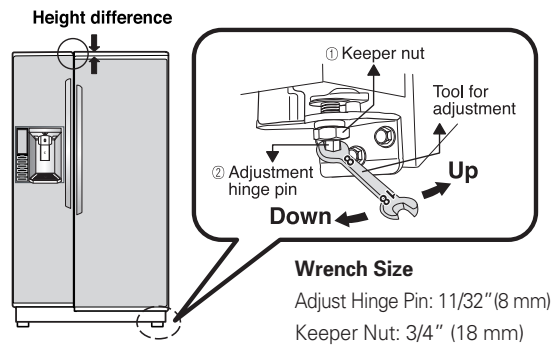

⚠ CAUTION

Do not force too hard to level the height. The hinge pin can be pulled out. (Adjustable range of height is a maximum of 2" (5 cm). The period goes between the parentheses. (Unusual construction))

After leveling the door height

The refrigerator doors will close smoothly by heightening the front side by adjusting the height adjusting screw. If the doors do not close correctly, performance may be affected.

Next

1. Wipe off all dust accumulated during shipping and clean your appliance thoroughly.
2. Install accessories such as the ice cube box, cover evaporating tray, etc., in their proper places. They are packed together to prevent possible damage during shipping.
3. Connect the power supply cord (or plug) to the outlet. Don't double up with other appliances on the same outlet. Use a dedicated outlet and circuit.

Handle removal

To move the refrigerator through a door, it may be necessary to remove the refrigerator door handles.

NOTE

- Handle appearance may vary from illustrations on this page.

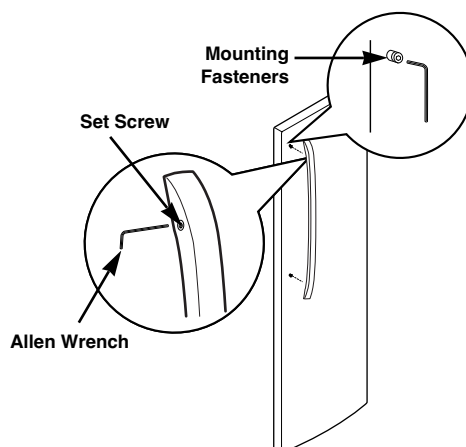

Loosen the set screws with a 3/32" (2.5 mm) Allen wrench and remove the handle.

NOTE

- If the handle mounting fasteners need to be tightened or removed, use a 1/4" Allen wrench.

Handle reinstallation

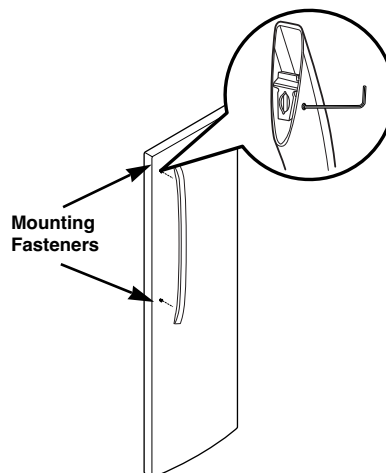

Place the handle on the door by aligning handle footprints to fit mounting fasteners and tighten the set screws with a 3/32" (2.5 mm) Allen wrench.

NOTE

- If the handle mounting fasteners need to be tightened or removed use a 1/4" Allen wrench

Dimensions

► Overall Dimensions

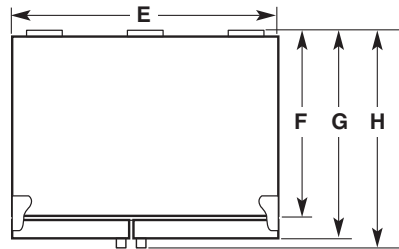
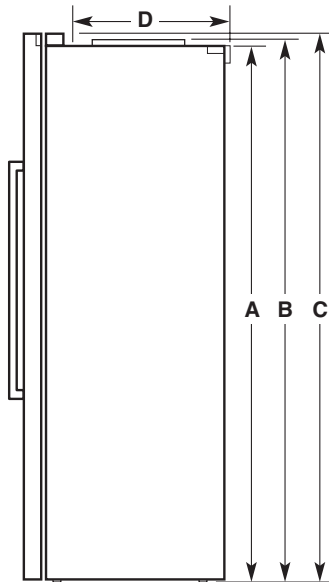

LSSC243**	
A	68 7/8"
B	68 15/16"
C	70 1/4"
D	-
E	35 13/16"
F	24 1/4"
G	28 1/8"
H	31"

► Door Swing Dimension

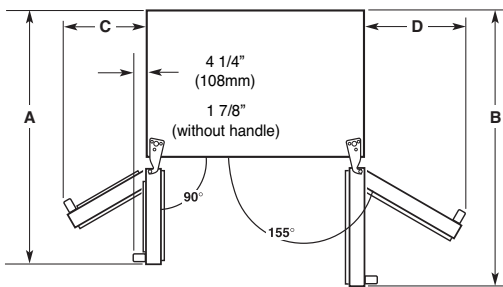

Model	A	B	C	D
LSSC243**	40 1/4"	44 7/8"	13 7/8"	18"

► Cabinet Dimensions

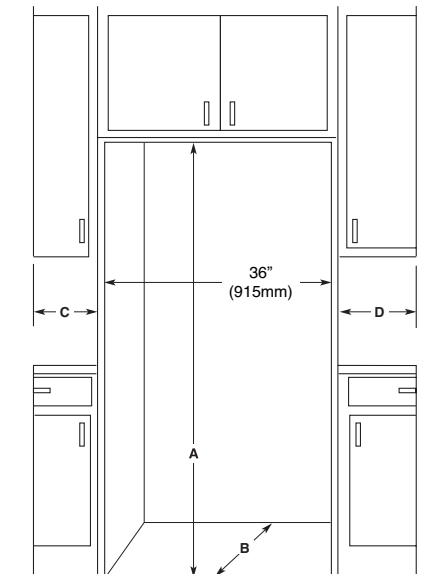

Model	A	B	C	D
LSSC243**	70"	24"	13 7/8"	18"

Starting

When your refrigerator is first installed, allow it to stabilize at normal operating temperatures for 2-3 hours prior to filling it with fresh or frozen foods. If operation is interrupted, wait 5 minutes before restarting.

Adjusting the temperatures and functions

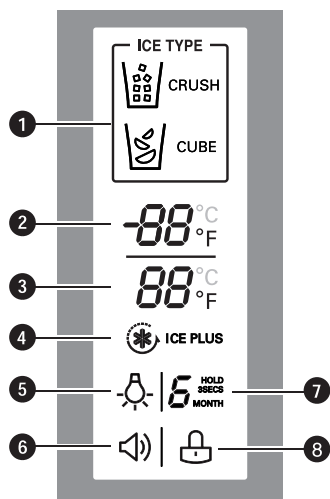
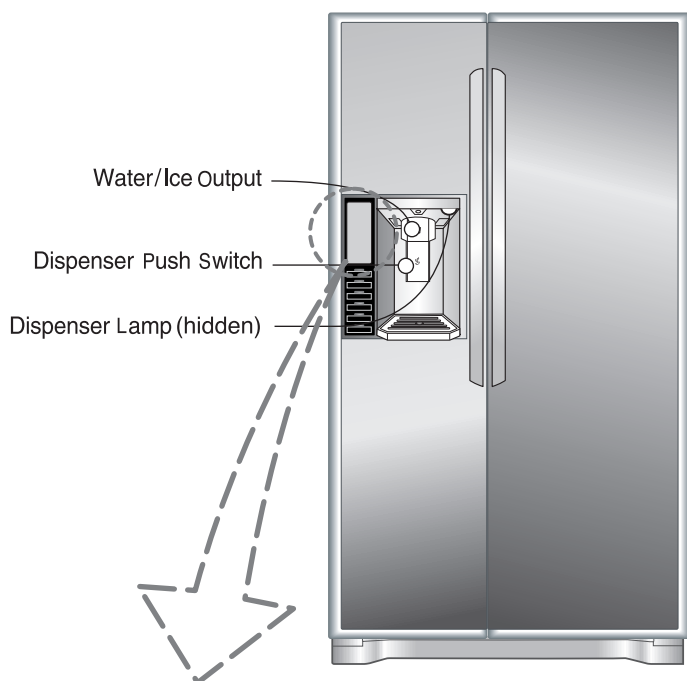

1 DISPENSER SELECTION INDICATOR
Shows cubed ice or crushed Ice selection that will be dispensed when the push switch is pressed.

2 FREEZER TEMPERATURE
Indicates the set temperature of the freezer compartment in Celsius or Fahrenheit.

3 REFRIGERATOR TEMPERATURE
Indicates the set temperature of the refrigerator compartment in Celsius or Fahrenheit.

4 ICE PLUS
When the ICE PLUS button is pressed, the display will indicate the selected function has been activated.

5 DISPENSER LIGHT INDICATOR
When the LIGHT button is pressed, the display will indicate the selected function: The dispenser light is on, this indicator will appear on the display panel.

6 DOOR ALARM INDICATOR
This indicator shows that the door-open warning alarm is activated.

7 WATER FILTER STATUS
This indicator shows the current status for the water filter. See Resetting the Filter Indicator.

8 LOCK STATUS
This indicator shows the current status for the control panel functions is set to LOCK.

NOTE

- Your model may not include every option.

Adjusting The Temperatures And Display

Adjust freezer temperature

To adjust the temperature in the freezer compartment, press the FREEZER button to cycle through the range of available settings.



0°F

Adjust refrigerator temperature

To adjust the temperature in the refrigerator compartment, press the REFRIGERATOR button to cycle through the range of available settings.



37°F

How to adjust the temperature in the freezer compartment

Freezer Compartment temperature adjustment



---> Setting temperature

8°F 6°F 5°F 4°F 3°F 2°F 1°F 0°F -1°F -2°F -3°F -4°F -6°F

How to adjust the temperature in the refrigerator compartment

Refrigerator Compartment temperature adjustment



---> Setting temperature

46°F 45°F 44°F 43°F 42°F 41°F 40°F 39°F 38°F 37°F 36°F 35°F 34°F 33°F

NOTE

- The actual inner temperature varies depending on the food status, since the indicated temperature setting is the target temperature and not the actual temperature within the refrigerator.

Initially set the REFRIGERATOR CONTROL at 37 °F and the FREEZER CONTROL at 0 °F. Leave them at these setting for 24 hours (one day) to stabilize. Then adjust the compartment temperature as illustrated above.

- To change temperature display from Fahrenheit to Celsius press and hold FREEZER and REFRIGERATOR buttons simultaneously for more than 5 seconds. Do the same to convert back to Celsius.

Operating The Dispenser

Dispensing crushed ice

Press the ICE TYPE button to illuminate the Crushed Ice icon. Press the ice switch with a glass or other container and crushed ice will be dispensed.



Dispensing cubed ice

Press the ICE TYPE button to illuminate the Cubed Ice icon. Press the ice switch with a glass or other container and cubed ice will be dispensed.



NOTE

- Hold the glass or other container in place for a couple of seconds after dispensing ice or water to catch the last few cubes or drops. The dispenser is designed to not operate while either refrigerator door is open.

Controlling the dispenser light

Press the LIGHT/FILTER button to turn the dispenser light on and off.

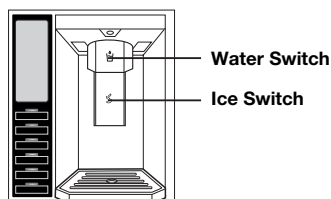

CAUTION

- When filling the container with a small opening, use it near the opening of the water or ice dispenser as close as possible.
- Do not dispense ice into fine china or crystal glasses. China or crystal can be broken.

Incorrect



Correct

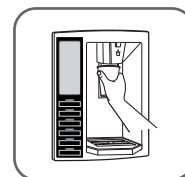

Ice

Setting The Functions

Press the button for the desired function to view and select other settings.

Setting the dispenser lock



Press and hold the ALARM/LOCK button for three seconds to lock the dispenser and all of the other control panel functions.

Press and hold again for 3 seconds to unlock.

Setting the door alarm



The ALARM/LOCK button also controls the door alarm that sounds three times in 30-second intervals when a compartment door is left open for more than 60 seconds.

The alarm stops sounding when the door is closed.

Press the ALARM/LOCK button once to activate and deactivate the door alarm function.

NOTE

- Contact your local service center if the alarm continues to sound after the doors are closed.

Resetting the filter indicator



Press and hold the LIGHT/FILTER button for more than 3 seconds to reset the filter indicator after the water filter has been replaced.

NOTE

- It is recommended that you replace the water filter approximately every 6 months, when the water filter indicator light reaches 0 or whenever the water or ice cube taste deteriorates noticeably.

Activating ICE PLUS



Press the ICE PLUS button once to activate the ICE PLUS function. The ICE PLUS icon on the display panel will illuminate when activated. The ICE PLUS function runs the freezer compartment at the coldest setting for a 24-hour period to increase icemaking by up to about 20%, and then turns off automatically.

NOTE

- Press the button again to cancel the ICE PLUS function.

**After dispenser
is used**

The water collector has no self-drainage function, so it should be cleaned regularly. Remove the cover by pulling the front of the water collector cover and dry it with a cloth.

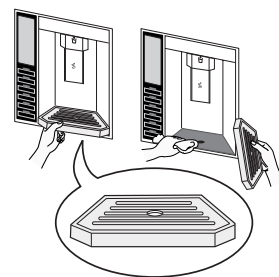
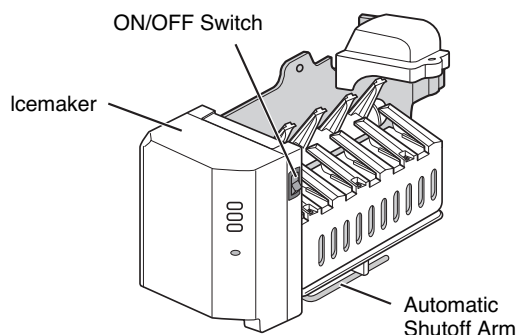
**Automatic
icemaker**

- The automatic icemaker can automatically make 6 cubes at a time, 70~120 pieces per day. This quantity may vary by circumstance, including ambient temperature, door opening, freezer load. etc.
- Icemaking stops when the ice storage bin is full.
- If you don't want to use the automatic icemaker, turn the icemaker switch to OFF. If you want to use automatic icemaker again, change the switch to ON.

NOTE

- It is normal that a noise is produced when ice drops into the ice storage bin.
- Sometimes level the surface so that the ice storage bin is fully filled with ice. Ice is piled up just near the ice maker. So, such status may be considered, by the ice maker, that the ice storage bin is fully filled and ice making operation may stop.

! WARNING

- Do not insert your hands into the maker in operation. It may cause injury.

When icemaker does not operate smoothly**Ice is lumped together**

- When ice is lumped together, take the ice lumps out of the ice storage bin, break them into small pieces, and then place them into the ice storage bin again.
- When the icemaker produces too small or lumped together ice, the amount of water supplied to the ice maker need to adjusted. Contact the service center.
- ※ If ice is not used frequently, it may lump together.

Power failure

- Ice may drop into the freezer compartment. Take the ice storage bin out and discard all the ice then dry it and place it back. After the machine is powered on again, crushed ice will be selected automatically.

The unit is newly installed

- It takes about 12 hours for a newly installed refrigerator to make ice in the freezer compartment.

The other functions***Door open warning***

- A warning tone will sound 3 times at thirty-second intervals if the refrigerator or freezer door is left open for more than sixty seconds.
- Please contact with the local service center if warning continue to sound even after closing the door.

How ice/cold water is supplied

Water is cooled while stored in the water tank in freezer door, and then sent to the dispenser.

Ice is made in the automatic ice maker and sent to the dispenser.

NOTE

- It is normal that the water is not very cold at first. If you want colder water, add ice into the glass.

CAUTION

Throw away the ice (about 20 pieces) and water (about 7 glasses) first made after refrigerator installation.

The first ice and water may include particles or odor from the feed water pipe or feed water box. This is necessary in case that the refrigerator has not been used for a long time.

Children should be supervised when using the dispenser.

Be careful that food does not block the ice passage.

If foods are placed at the entrance of ice passage, ice may not be dispensed. The ice passage may also be covered with ice powder if only crushed ice is used. This time, remove the ice powder accumulated.

Never store beverage cans or other foods in ice storage bin for the purpose of rapid cooling.

Such actions may damage the automatic ice maker.

Never use thin crystal glass or crockery to collect ice.

Such glasses or containers may be broken.

Put ice first into a glass before filling water or other beverages.

Water may be splashed if ice is added to existing liquid in a glass.

Never place a tool or hand in the ice outlet.

Part breakage or injury may occur.

Never remove the ice maker cover.

If discolored ice is dispensed, immediately contact service center and discontinue use.

Never use a narrow or deep glass.

Ice may clog the ice chute and cause the refrigerator to malfunction.

Keep the glass at a proper distance from ice outlet.

A glass too close to the outlet may hinder ice from coming out.

Shelf

How to use

You can store side dish or refrigerated food on the shelf with sufficient space in between the containers.

How to disassemble

1. Hold the front part of the shelf and pull it out until it reaches the catch.
2. When you cannot pull out the shelf any more, lift it up slightly.
3. While holding the shelf slightly, tilt the shelf to pull it out.

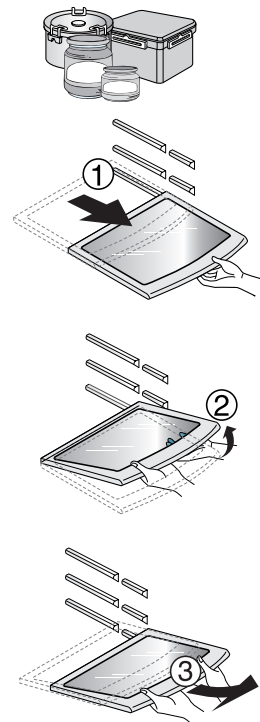

Egg holder

You can move the egg holder to wherever you want.

NOTE

- Never use the egg holder as an ice storage bin. It can be broken.
- Never store the egg holder in the freezer compartment or fresh compartment.

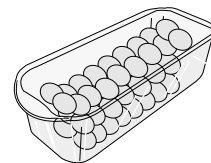

Nano charcoal deodorizer

How to use

With the Nano charcoal deodorizer system, you can deodorize the refrigerator and the deodorizer can be reused.

How to disassemble

Use the (-) driver on the bottom grooved part of the deodorizer cover to separate it while pushing to the front.

► How to reuse the deodorizer

You can reuse the deodorizer by drying it with the hair dryer.

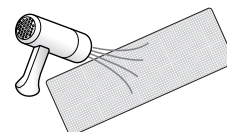
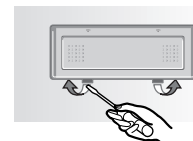

How to use

You can store fruits or vegetables.

How to disassemble the upper fresh compartment

1. Hold the front handle of the fresh compartment and pull it out until it stops.

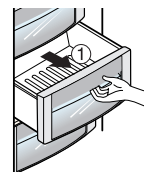

2. When you cannot pull out the fresh compartment any more, lift it up slightly to pull it out completely to the front (outer side).

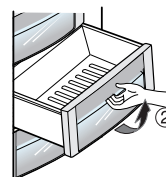

* The fresh compartment can be reassembled in the reverse order.

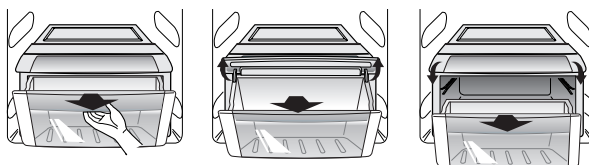
How to disassemble the lower fresh compartment**► When pulling out the lower fresh compartment**

1. Hold the front handle of the fresh compartment and pull it forward.

2. When you cannot pull out the fresh compartment any more, lift it up slightly to pull it out to the front.

► When inserting the lower fresh compartment

* When inserting the fresh compartment, always lift the cover up to push it in.

- Always disassemble the fresh compartment using two hands.
You can be injured from the weight of the compartment when filled with food.

! WARNING**How to disassemble upper/lower fresh compartment cover**

Hold the cover with both hands and pull it out.

* When disassembling the cover, always remove the fresh compartment first.

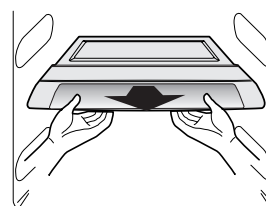

Push 'N Seal Crisper compartment

How to use

You can store vegetables or fruits freshly for a long period of time.

- In the middle Push 'N Seal Crisper compartment, you can store the vegetable or fruit for a longer period of time with the improved seal and vacuum effect.

How to disassemble the Push 'N Seal Crisper compartment

1. Hold the front handle of the Push 'N Seal Crisper compartment and pull it out until it stops.
2. When you cannot pull out the Push 'N Seal Crisper compartment any more, lift it up slightly to pull it out completely to the front side (outer side).

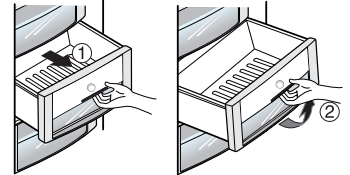

NOTE

- You can disassemble/reassemble the freezer drawer in the same method.
- When disassembling/reassembling the fresh compartment or Push 'N Seal Crisper compartment of the refrigerator, open the refrigerator door fully.

How to disassemble the Push 'N Seal Crisper compartment case

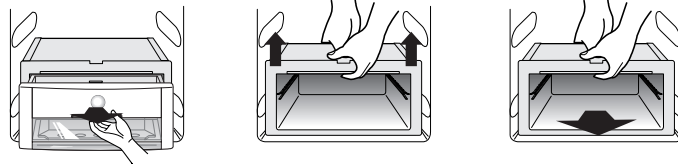

1. Pull the Push 'N Seal Crisper compartment to the front and slightly lift it up to pull it out.
2. Hold the Push 'N Seal Crisper compartment case with both hands and slightly lift it up.
* To disassemble the case, you must first disassemble the upper fresh compartment.
3. Pull it out to the front.

How to reassemble the Push 'N Seal Crisper compartment

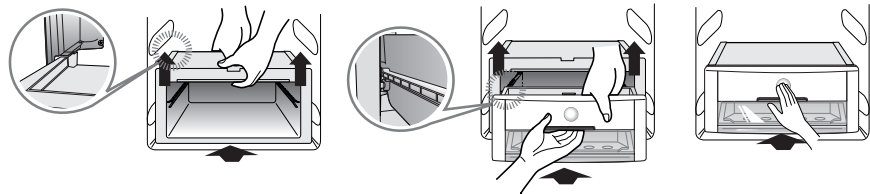

1. Align the top of the case to the side rails and push while slightly holding it up.
2. Align the bottom of the case on top of the rails and push while slightly holding it up.
3. Push the case until you hear the Click.

Freezer/Refrigerator basket

How to use

You can store small packaged frozen food (freezer basket), small packaged refrigerated food or beverages (refrigerator basket) such as milk, etc.

But, do not store ice cream or food to store for a long period of time (Freezer basket) etc.

How to disassemble

Hold the basket with both hands and slightly lift up the front part to pull it out.

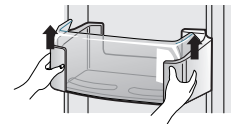

How to reassemble

Hold the basket with both hands and reassemble one side at a time by pushing it in.

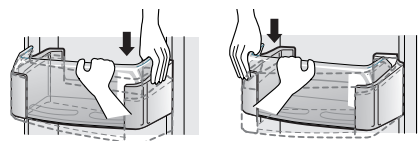

Dairy corner

How to use

You can store dairy goods like butter, cheese etc.

How to disassemble

Hold the basket with both hands and pull it up to get it out.

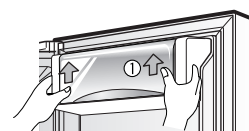

- ▶ If you close the refrigerator door with the dairy corner left open on the door side, the refrigerator door may not be closed properly. Be careful to avoid damaging the cover.

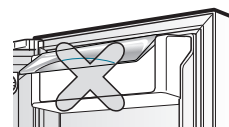

Exchanging the water filter

How to exchange

How to exchange the water purifier filter

It is recommended that you replace the water filter approximately every 6 months, when the water filter indicator light reaches 0, or whenever the water or ice cube taste deteriorates noticeably.

1. Remove the water purifier filter.

- Turn the filter to exchange in counterclockwise direction by 90 degrees. (1) Pull out the filter to the front (2).

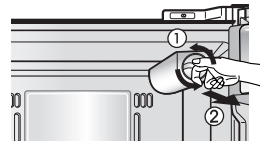

- Because water collected in the filter may drip, put a bowl slightly larger than the size of the filter underneath the filter when disassembling the filter.

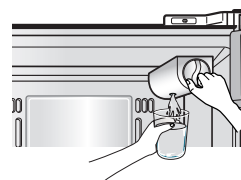

2. Insert the new filter.

- Align the filter on the indicated line on the control box (1) and then push it in. After checking whether the indicated line and the indicated locking line are aligned, turn the filter in clockwise direction (2).

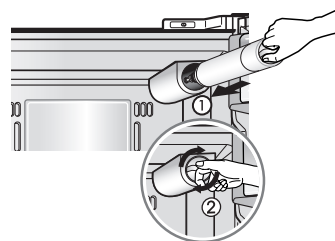

- When you have install the filter for the first time or when you have exchanged the filter, press the dispenser button once again to dispense the water for about 3 minutes (or about 1 liter) to remove any air or residual charcoal. (Charcoal is not hazardous to the human body.)

Location of foods

(Refer to identification of parts)

Freezer compartment shelf

Store various frozen foods such as meat, fish, ice cream, frozen snacks, etc.

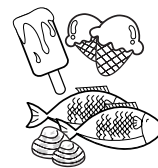

Freezer compartment door rack

- Store small packed frozen food.
- Temperature is likely to increase as door opens. So, do not store long-term food such as ice cream, etc.



Freezer compartment drawer

- Store meat, fish, chicken, etc. after wrapping them with thin foil.
- Store dry.



Dairy corner

Store milk products like butter, cheese, etc.



Egg holder

Look for the proper location.



Refreshment center

Store foods of frequent use such as beverage, etc.



Refrigerator compartment shelf

Store side dishes or other foods at a proper distance.

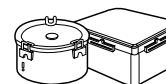

Refrigerator compartment door rack

Store small packed food or beverages such as milk, juice, etc.

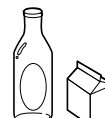

Vegetable drawer

Store vegetables or fruits.

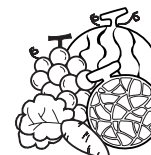

Storing foods

- Store fresh food in the refrigerator compartment. How food is frozen and thawed is an important factor in maintaining its freshness and flavor.
- Do not store food which spoils bad easily at low temperatures, such as bananas and melons.
- Allow hot food to cool prior to storing, placing hot food in the refrigerator could spoil other food, and lead to higher energy consumption.
- When storing the food, cover it with vinyl wrap or store in a container with a lid. This prevents moisture from evaporating, and helps food to keep its taste and nutrients.
- Do not block air vents with food. Smooth circulation of chilled air keeps refrigerator temperatures even.
- Do not open the door frequently. Opening the door lets warm air enter the refrigerator and cause temperatures to rise.
- Never keep too much food in door rack because they may push against by inner racks so that the door cannot be fully closed.

Freezer compartment

- Do not store bottles in the freezer compartment - they may be broken when frozen.
- Do not refreeze food that has been thawed. This causes loss of taste and nutrient.
- When storing frozen food like ice cream for a long period, place it on the freezer shelf, not in the door rack.
- Do not touch the cold foods or containers made of metal, with wet hands and place glass products in the freezer compartment.

Refrigerator compartment

- Always clean food prior to refrigeration. Vegetables and fruits should be washed and dried. Packed food should be wiped to prevent adjacent food from spoiling.
- When storing eggs in their storage rack or box, ensure that they are fresh, and always store them in an upright position, which keeps them fresh longer.

NOTE

- If you keep the refrigerator in a hot and humid place, frequent opening of the door or storing a lot of vegetables in it may cause condensation to form which has no effect on its performance. Remove the condensation with a paper or kitchen towel.

General information

Vacation time

During average length vacations, you will probably find it best to leave the refrigerator in operation. Place freezable items in freezer for longer life.

When you plan not to operate, remove all food, disconnect the power cord, clean the interior thoroughly, and leave each door OPEN to prevent odor formation.

Power failure

Most power failures that are corrected in an hour or two will not affect your refrigerator temperatures.

However, you should minimize the number of door openings while the power is off.

If you move

Remove or securely fasten down all loose items inside the refrigerator.

To avoid damaging the height adjusting screws, turn them all the way into the base.

Anti condensation pipe

The outside wall of the refrigerator cabinet may sometimes get warm, especially just after installation. This is due to the anti-condensation pipe, which pumps hot refrigerant to prevent sweating on the outer cabinet wall.

When LED lamp doesn't light up

Is LED lamp turned on?

- LED lamp is not a user-serviceable item.

If the LED array fails, contact LG for service.

Cleaning

It is important that your refrigerator be kept clean to prevent undesirable odors. Spilled food should be wiped up immediately, since it may acidify and stain plastic surfaces if allowed to settle.

Exterior

Use a lukewarm solution of mild soap or detergent to clean the durable finish of your refrigerator.

Wipe with a clean damp cloth and then dry.

Interior

Regular cleaning is recommended. Wash all compartments a baking soda solution or a mild detergent and warm water. Rinse and dry.

NOTE

- Please do not use a dishwasher to clean the lower drawers; the high temperature may cause damage to the baskets, making them unusable.

After cleaning

Please verify that the power cord is not damaged or overheated. Also verify the power plug is inserted completely into power outlet.

WARNING

Always remove power cord from the wall outlet prior to cleaning in the vicinity of electrical parts (lamps, switches, controls, etc.).

Wipe up excess moisture with a sponge or cloth to prevent water or liquid from getting into any electrical part and causing an electric shock.

Never use metallic scouring pads, brushes, coarse abrasive cleaners, strong alkaline solutions, flammable or toxic cleaning liquids on any surface.

Do not touch frozen surfaces with wet or damp hands, because they could stick or adhere to extremely cold surfaces.

Troubleshooting

Before calling for service, review this list. It may save you both time and expense. This list includes common occurrences that are not the result of defective workmanship or materials in this appliance.

Occurrence	Possible cause	Solution
Runing of refrigerator		
Refrigerator compressor does not run.	Refrigerator control is off.	Set refrigerator control. See setting the controls.
	Refrigerator is in defrost cycle.	This is normal for a fully automatic defrosting refrigerator. The defrost cycle occurs periodically.
	Plug at wall outlet is disconnected.	Make sure plug is tightly pushed into outlet.
	Power outage. Check house lights.	Call local electric company.
Refrigerator runs too much or too long	Refrigerator is larger than the previous one you owned.	This is normal. Larger, more efficient units run longer in these conditions.
	Room or outside weather is hot.	It is normal for the refrigerator to work longer under these conditions.
	Refrigerator has recently been disconnected for a period of time.	It takes some hours for the refrigerator to cool down completely.
	Large amounts of warm or hot food may have been stored recently.	Warm food will cause the refrigerator to run longer until the desired temperature is reached.
	Doors are opened too frequently or too long.	Warm air entering the refrigerator causes it to run longer. Open the door less often.
	Refrigerator or freezer door may be slightly open.	Make sure the refrigerator is level. Keep food and containers from blocking door. See problem section OPENING/CLOSING of doors.
	Refrigerator control is set too cold.	Set the refrigerator control to a warmer setting until the refrigerator temperature is satisfactory.
	Refrigerator or freezer gasket is dirty, worn, cracked, or poorly fitted.	Clean or change gasket. Leaks in the door seal will cause refrigerator to run longer in order to maintain desired temperatures.
	Thermostat is keeping the refrigerator at a constant temperature.	This is normal. Refrigerator goes on and off to keep the temperature constant.

Occurrence	Possible cause	Solution
Temperatures are too cold		
Temperature in the freezer is too cold but the refrigerator temperature is satisfactory.	Freezer control is set too cold	Set the freezer control to a warmer setting until the freezer temperature is satisfactory.
Temperature in the refrigerator is too cold but the freezer temperature is satisfactory.	Refrigerator control is set too cold.	Set the refrigerator control to a warmer setting until the refrigerator temperature is satisfactory.
Food stored in drawers freezes.	Refrigerator control is set too cold.	See above solution.
Temperatures are too warm		
Temperatures in the refrigerator or freezer are too warm.	Freezer control is set too warm.	Set the freezer or refrigerator control to a colder setting until the freezer or refrigerator temperature is satisfactory.
	Doors are opened too frequently or too long.	Warm air enters the refrigerator/ freezer whenever the door is opened. Open the door less often.
	Door is slightly open.	Close the door completely.
	Large amounts of warm or hot food may have been stored recently.	Wait until the refrigerator or freezer has a chance to reach its selected temperature.
	Refrigerator has recently been disconnected for a period of time.	A refrigerator requires some hours to cool down completely.
Temperature in the refrigerator is too warm but the freezer temperature is satisfactory.	Refrigerator control is set too warm.	Set the refrigerator control to a colder setting until the refrigerator temperature is satisfactory.

Occurrence	Possible cause	Solution
Sound and noise		
Louder sound levels when refrigerator is on.	Today's refrigerators have increased storage capacity and maintain more even temperatures.	It is normal for sound levels to be higher.
Louder sound levels when compressor comes on.	Refrigerator operates at higher pressures during the start of the ON cycle.	This is normal. The sound will level off as the refrigerator continues to run.
Vibrating or rattling noise.	Floor is uneven or weak. Refrigerator rocks on the floor when it is moved slightly.	Be sure floor is level and solid and can adequately support refrigerator.
	Items placed on the top of the refrigerator are vibrating.	Remove items.
	Dishes are vibrating on the shelves in the refrigerator.	It is normal for dishes to vibrate slightly. Move dishes slightly. Make sure refrigerator is level and firmly set on floor.
	Refrigerator is touching wall or cabinets.	Move refrigerator so that it does not touch the wall or cabinets.
Water/Moisture /Ice inside refrigerator		
Moisture collects on the inside walls of the refrigerator.	The weather is hot and humid which increases the rate of frost buildup and internal sweating.	This is normal.
	Door is slightly open.	See problem section opening/closing of doors.
	Door is opened too often or too long.	Open the door less often.
Water/Moisture /Ice outside refrigerator		
Moisture forms on the outside of the refrigerator or between doors.	Weather is humid.	This is normal in humid weather. When humidity is lower, the moisture should disappear.
	Door is slightly open, causing cold air from the inside the refrigerator to meet warm air from the outside.	Close the door completely.

Occurrence	Possible cause	Solution
Odors in refrigerator	Interior needs to be cleaned.	Clean interior with sponge, warm water and baking soda.
	Food with strong odor is in the refrigerator.	Cover food completely.
	Some containers and wrapping materials produce odors.	Use a different container or brand of wrapping materials.
Opening/Closing of doors/Drawers		
Door(s) will not close.	Food package is keeping door open.	Move packages that keep door from closing.
	Door was closed too hard, causing other door to open slightly.	Close both doors gently.
	Refrigerator is not level. It rocks on the floor when it is moved slightly.	Adjust the leveling legs.
	Floor is uneven or weak. Refrigerator rocks on the floor when it is moved slightly.	Be sure floor is level and can adequately support refrigerator. Contact carpenter to correct sagging or sloping floor.
	Refrigerator is touching wall or cabinets.	Move refrigerator.
Drawers are difficult to move.	Food is touching shelf on top of the drawer	Keep less food in drawer.
	Track that drawer slides on is dirty.	Clean drawer and track.
Dispenser		
Dispenser will not dispense ice	Ice storage bin is empty.	When the first supply of ice is dropped into the bin, the dispenser should operate.
	Freezer temperature is set too warm.	Set the freezer control to a colder setting so that ice cubes will be made. When the first supply of ice is made, the dispenser should operate.
	Household water line valve is not open.	Open household water line valve and allow sufficient time for ice to be made. When ice is made, dispenser should operate.
	Refrigerator or freezer door is not closed.	Be sure both doors are closed.

Occurrence	Possible cause	Solution
Dispenser will not dispense ice.	Ice has melted and frozen around the auger due to infrequent use, temperature fluctuations and/or power outages.	Remove ice storage bin, and thaw and the contents. Clean bin, wipe dry and replace in proper position. When new ice is made, dispenser should operate.
Ice dispenser is jammed.	Ice cubes are jammed between the ice maker arm and back of the bin.	Remove the ice cubes that are jamming the dispenser.
	Ice cubes are frozen together.	Use the dispenser often so that cubes do not freeze together.
	Ice cubes that have been purchased or made in some other way have been used in the dispenser.	Only the ice cubes made by the icemaker should be used with the dispenser.
Dispenser will not dispense water.	Household water line valve is not open. See problem <i>Ice maker is not making any ice.</i>	Open household water line valve.
	Refrigerator or freezer door is not closed.	Be sure both doors are closed.
Water has an odd taste and/or odor.	Water has been in the tank for too long.	Draw and discard 7 glasses of water to freshen the supply. Draw and discard an additional 7 glasses to completely rinse out tank.
	Unit not properly connected to cold water line.	Connect unit to cold water line which supplies water to kitchen faucet.
Sound of ice dropping	This sound is normally made when automatically made ice is dropped into ice storage bin. Volume may vary according to refrigerator's location.	
Sound of water supply	This sound is normally made when ice maker is supplied with water after dropping the automatically made ice.	
Other	Please thoroughly read <i>Automatic ice maker and dispenser</i> in this manual.	

It is Normal...

The following occurrences are normal.

	Occurrence	Solution
Noise	When you hear Tick or Click sound	This is the sound of various parts expanding/contracting or various control devices operating depending on the temperature change within the refrigerator.
	When you hear Duddle-lunk, Bla-dunk, or Varroom	This is the count of compressor or fan operating when the operation of the refrigerator is starting or ending. This is the same phenomenon of the sound generated when starting or turning off the engine of a car.
	When you hear sound of water flowing	This is the sound of refrigerant changing the condition in the freezer/refrigerator. When the liquid changes to gas, you will hear the sound of water flowing and when gas changes to liquid, you will hear the sound.
	When you hear the sound of air moving like Valoosh or ZZZip or Whoosh when closing or opening the door.	This is the sound generated when the internal pressure is temporarily lowered when the warm air entered through the refrigerator or freezer is cooled fast.
	When you hear a vibrating sound	If the refrigerator is installed a wooden floor or next to a wooden wall, or if the refrigerator is not leveled properly, the sound can be loud from the vibration.
	When you hear a loud sound after installing the product for the first time	When you operate the refrigerator for the first time, the refrigerator will operate at high speed to cool fast and the sound can seem louder. When the internal temperature falls below a certain level, the noise will subside.
Door open	When the door is slightly opened after the door	Depending on the force or speed of closing the refrigerator or freezer door, the door can be bumped open from the pressure. Be careful not to close the door to hard.
Icing/ Dew drops	When there is icing or condensation formed on the inner or outer side of the refrigerator	When external air flows into the cool inner surface of the refrigerator, icing/condensation can be formed. This will happen more easily when you open and close the refrigerator door more frequently. Also, if the humidity of the installed location is high or during the rainy season or on a rainy day, condensation can form on the outer side of the refrigerator. This is a natural phenomenon that occurs during the humid weather. Wipe the water drops with a dry cloth.
Temperature	When the front of the refrigerator is warm	Heat pipes are installed around the front part of the refrigerator and on the divider of the freezer and refrigerator to prevent the condensation from forming. The refrigerator may feel warmer after the installation or during the hot summer, but this is not a problem.

**LG ELECTRONICS U.S.A., INC.
LG REFRIGERATOR LIMITED WARRANTY - U.S.A.**

Should your LG Refrigerator ("Product") fail due to a defect in materials or workmanship under normal home use, during the warranty period set forth below, LG will at its option repair or replace the product. This limited warranty is valid only to the original retail purchaser of the product and applies only when purchased and used within the United States including U.S. Territories. Proof of original retail purchase is required to obtain warranty service under this limited warranty.

WARRANTY PERIOD
Refrigerator
Two (2) years from the date of original retail purchase
Parts and Labor

Noises associated with normal operation and failure to follow instructions found in the use and care and installation guides or operating the unit in an unsuitable environment will not be covered under this warranty.

- ▶ Replacement products and parts are warranted for the remaining portion of the original warranty period or ninety (90) days, whichever is greater.
- ▶ Replacement products and parts may be new or remanufactured.

THIS WARRANTY IS IN LIEU OF ANY OTHER WARRANTY, EXPRESS OR IMPLIED, INCLUDING WITHOUT LIMITATION, ANY WARRANTY OF MERCHANTABILITY OR FITNESS FOR A PARTICULAR PURPOSE. TO THE EXTENT ANY IMPLIED WARRANTY IS REQUIRED BY LAW, IT IS LIMITED IN DURATION TO THE EXPRESS WARRANTY PERIOD ABOVE. NEITHER THE MANUFACTURER NOR ITS U.S. DISTRIBUTOR SHALL BE LIABLE FOR ANY INCIDENTAL, CONSEQUENTIAL, INDIRECT, SPECIAL, OR PUNITIVE DAMAGES OF ANY NATURE, INCLUDING WITHOUT LIMITATION, LOST REVENUES OR PROFITS, OR ANY OTHER DAMAGE WHETHER BASED IN CONTRACT, TORT, OR OTHERWISE. Some states do not allow the exclusion or limitation of incidental or consequential damages or limitations on how long an implied warranty lasts, so the above exclusion or limitation may not apply to you. This warranty gives you specific legal rights and you may also have other rights that vary from state to state.

THIS LIMITED WARRANTY DOES NOT COVER:

1. Service trips to deliver, pick up, install, or repair the product; instruct the customer on operation of the product; repair or replace fuses or correct wiring or plumbing, or correction of unauthorized repairs/installation.
2. Failure of product to perform during power failures and interruptions or inadequate electrical service.
3. Damage caused by leaky or broken water pipes, frozen water pipes, restricted drain lines, inadequate or interrupted water supply or inadequate supply of air.
4. Damage resulting from operating the product in a corrosive atmosphere or contrary to the instructions outlined in the product owner's manual.
5. Damage to the product caused by accidents, pests and vermin, lightning, wind, fire, floods, or acts of God.
6. Damage resulting from misuse, abuse, improper installation, repair, or maintenance. Improper repair includes use of parts not approved or specified by LG.
7. Damage or failure caused by unauthorized modification or alteration, or if it is used for other than the intended purpose, or any water leakage where the unit was not properly installed.
8. Damage or failure caused by incorrect electrical current, voltage, or plumbing codes, commercial or industrial use, or use of accessories, components, or consumable cleaning products that are not approved by LG.
9. Damage caused by transportation and handling, including scratches, dents, chips, and/or other damage to the finish of your product, unless such damage results from defects in materials or workmanship and is reported within one (1) week of delivery (Call: 1-800-243-0000).
10. Damage or missing items to any display, open box, discounted, or refurbished product.
11. Products with original serial numbers that have been removed, altered, or can not be readily determined. Model and Serial numbers, along with original retail sales receipt, are required for warranty validation.
12. Increases in utility costs and additional utility expenses.
13. Replacement of light bulbs, filters, or any consumable parts.
14. Repairs when your product is used in other than normal and usual household use (e.g. commercial use, offices, and recreational facilities) or contrary to the instructions outlined in the product owner's manual.
15. Costs associated with removal of your product from your home for repairs.
16. The removal and reinstallation of the product if it is installed in an inaccessible location or is not installed in accordance with published installation instructions, including LG's owner's and installation manuals.
17. Shelves, door bins, drawers, handles, accessories, and other parts besides those that were originally included with this particular model.

The cost of repair or replacement under these excluded circumstances shall be borne by the consumer.

For complete warranty details and customer assistance, please call or visit our website:
 Call 1-800-243-0000 (24 hours a day, 365 days a year) and select the appropriate option from the menu, or visit our website at www.lg.com
 Or by mail: LG Customer Information Center:
 P. O. Box 240007, 201 James Record Road Huntsville, Alabama 35813
 ATTN: CIC

Write your warranty information below:

Product Registration Information:

Model: _____

Serial Number: _____

Date of Purchase: _____

**LG ELECTRONICS CANADA, INC.
LG REFRIGERATOR LIMITED WARRANTY - Canada**

ENGLISH

WARRANTY: Should your LG Refrigerator ("Product") fail due to a defect in material or workmanship under normal home use during the warranty period set forth below, LG Canada will at its option repair or replace the Product upon receipt of proof of original retail purchase. This warranty is valid only to the original retail purchaser of the product and applies only to a Product distributed in Canada by LG Canada or an authorized Canadian distributor thereof. The warranty only applies to Products located and used within Canada.

WARRANTY PERIOD: (Note: If the original date of purchase can not be verified, the warranty will begin sixty (60) days from the date of manufacture)
Refrigerator/Freezer
Two (2) years from the date of original retail purchase
Parts and Labor

Noises associated with normal operation and failure to follow instructions found in the use and care and installation guides or operating the unit in an unsuitable environment will not be covered under this warranty.

- ▶ Replacement products and parts are warranted for the remaining portion of the original warranty period or ninety (90) days, whichever is greater.
- ▶ Replacement products and parts may be new or remanufactured.
- ▶ LG Authorized Service Center warranties their repair work for thirty (30) days.

LG CANADA'S SOLE LIABILITY IS LIMITED TO THE WARRANTY SET OUT ABOVE. EXCEPT AS EXPRESSLY PROVIDED ABOVE, LG CANADA MAKES NO AND HEREBY DISCLAIMS ALL OTHER WARRANTIES AND CONDITIONS RESPECTING THE PRODUCT, WHETHER EXPRESS OR IMPLIED, INCLUDING, BUT NOT LIMITED TO, ANY IMPLIED WARRANTY OR CONDITION OF MERCHANTABILITY OR FITNESS FOR A PARTICULAR PURPOSE, AND NO REPRESENTATIONS SHALL BE BINDING ON LG CANADA. LG CANADA DOES NOT AUTHORIZE ANY PERSON TO CREATE OR ASSUME FOR IT ANY OTHER WARRANTY OBLIGATION OR LIABILITY IN CONNECTION WITH THE PRODUCT. TO THE EXTENT THAT ANY WARRANTY OR CONDITION IS IMPLIED BY LAW, IT IS LIMITED TO THE EXPRESS WARRANTY PERIOD ABOVE. LG CANADA, THE MANUFACTURER OR DISTRIBUTOR SHALL NOT BE LIABLE FOR ANY INCIDENTAL, CONSEQUENTIAL, SPECIAL, DIRECT OR INDIRECT DAMAGES, LOSS OF GOODWILL, LOST PROFITS, PUNITIVE OR EXEMPLARY DAMAGES OR ANY OTHER DAMAGE, WHETHER ARISING DIRECTLY OR INDIRECTLY FROM ANY CONTRACTUAL BREACH, FUNDAMENTAL OR OTHERWISE, OR FROM ANY ACTS OR OMISSIONS, TORT, OR OTHERWISE. This warranty gives you specific legal rights. You may have other rights which may vary from province to province depending on applicable provincial laws. Any term of this warranty that negates or varies any implied condition or warranty under provincial law is severable where it conflicts with provincial law without affecting the remainder of this warranty's terms.

THIS LIMITED WARRANTY DOES NOT COVER:

1. Service trips to deliver, pick up, or install the product; instructing a customer on operation of the product; repair or replacement of fuses or correction of wiring or plumbing, or correction of unauthorized repairs/installation.
2. Failure of the product to perform during power failures and interruptions or inadequate electrical service.
3. Damage caused by leaky or broken water pipes, frozen water pipes, restricted drain lines, inadequate or interrupted water supply or inadequate supply of air.
4. Damage resulting from operating the Product in a corrosive atmosphere or contrary to the instructions outlined in the Product owner's manual.
5. Damage to the Product caused by accidents, pests and vermin, lightning, wind, fire, floods, or acts of God.
6. Damage resulting from the misuse, abuse, improper installation, repair, or maintenance of the Product. Improper repair includes use of parts not approved or specified by LG Canada.
7. Damage or product failure caused by unauthorized modification or alteration, or use for other than its intended purpose, or resulting from any water leakage due to improper installation.
8. Damage or Product failure caused by incorrect electrical current, voltage, or plumbing codes, commercial or industrial use, or use of accessories, components, or cleaning products that are not approved by LG Canada.
9. Damage caused by transportation and handling, including scratches, dents, chips, and/or other damage to the finish of your product, unless such damage results from defects in materials or workmanship and is reported within one (1) week of delivery.
10. Damage or missing items to any display, open box, discounted, or refurbished Product.
11. Products with original serial numbers that have been removed, altered, or cannot be readily determined. Model and Serial numbers, along with original retail sales receipt, are required for warranty validation.
12. Increases in utility costs and additional utility expenses.
13. Replacement of light bulbs, filters, or any consumable parts.
14. Repairs when your Product is used in other than normal and usual household use (including, without limitation, commercial use, in offices or recreational facilities) or contrary to the instructions outlined in the Product owner's manual.
15. Costs associated with removal of the Product from your home for repairs.
16. The removal and reinstallation of the Product if it is installed in an inaccessible location or is not installed in accordance with published installation instructions, including the Product owner's and installation manuals.
17. Shelves, door bins, drawers, handles, and accessories to the Product. Also excluded are parts besides those that were originally included with the Product.

All costs associated with the above excluded circumstances shall be borne by the consumer.

For complete warranty details and customer assistance, please call or visit our website:
Call 1-888-542-2623 (24 hours a day, 365 days a year) and select the appropriate option from the menu, or visit our website at www.lg.com

Write your warranty information below: _____
Product Registration Information: _____
Model: _____ **Serial Number:** _____
Date of Purchase: _____



LG Customer Information Center

For inquires or comments, visit www.lg.com or call;

1-800-243-0000 USA, Consumer User

1-888-865-3026 USA, Commercial User

1-888-542-2623 CANADA

Register your product Online!

www.lg.com

