



# Owner's Manual

## F1403RD(1~9) WD-1409RD(1~9)



Before use please read carefully the safety instructions!

Thank you for buying an LG fully automatic washing machine. Please read this owner's manual carefully, it provides instructions on safe installation, use and maintenance. Keep it handy for future reference of this machine. Make a note of the model and serial numbers of your washing machine.

Troubleshooting		
	<ul style="list-style-type: none"> <li>Water supply is not adequate in area</li> <li>Water supply taps are not completely open.</li> <li>Water inlet hose(s) are kinked.</li> <li>The filter of the inlet hose(s) are clogged.</li> </ul>	Check another tap in the house. Fully open tap.  Straighten hose(s). Check the filter of the inlet hose(s).
	<ul style="list-style-type: none"> <li>Drain hose is kinked or clogged.</li> <li>The drain filter is clogged.</li> </ul>	Clean and straighten the drain hose. Clean the drain filter. For more detailed information, please refer to "Cleaning the drain pump filter"
	<ul style="list-style-type: none"> <li>Load is too small.</li> <li>Load is out of balance.</li> <li>The appliance has an unbalance detection and correction system. If individual heavy articles are loaded (ex. bath mat, both robe, etc.), this system may stop spinning or even interrupt the spin cycle altogether.</li> <li>If the laundry is still too wet at the end of the cycle, add smaller articles of laundry to balance the load and repeat the spin cycle. Floor is unstable.</li> <li>Feet are not adjusted</li> </ul>	Add 1 or 2 similar items to help balance the load. Rearrange load to allow proper spinning  The floor should be a solid surface. Adjust the feet so that the machine does not rock from side to side or front to back.
	<ul style="list-style-type: none"> <li>Is the door opened or not completely closed?</li> </ul>	Close the door completely. * If the "dE" does not clear, call for service.
		Unplug the power plug and call for service.
	<ul style="list-style-type: none"> <li>Water overfills due to the faulty water valve.</li> </ul>	Close the water tap. Unplug the power plug. Call for service.
	<ul style="list-style-type: none"> <li>Water level sensor has malfunctioned.</li> </ul>	
	<ul style="list-style-type: none"> <li>Over load in motor.</li> </ul>	
	<ul style="list-style-type: none"> <li>The washer experienced a power failure.</li> </ul>	Restart the cycle.
	<ul style="list-style-type: none"> <li>Check water supply.</li> </ul>	Turn the tap on. * If "dHE" is not released, unplug power plug and call for service.

Rattling and clanking noise	Extraneous objects such as coins or safety pins maybe in drum or pump.
Thumping sound	Heavy wash loads may produce a thumping sound. This is usually normal.
Vibrating noise	Have all transit bolts and packing been removed?
Water leaks.	Check and tighten hose connections. Unclog drain pipe. Contact plumber if necessary.
Excessive suds	Too much detergent or unsuitable detergent.
Washing machine does not start	Power cord may not be plugged in or connection may be loose.
Washing machine won't spin	Check that the door is shut. Check that foreign objects may be blocking the drain causing the water not to drain out. Once started, the door can not be opened for safety reasons. At the end of the cycle or when Start/Pause is pressed, wait one or two minutes before opening the door to allow the electric locking mechanism time to release.
Door does not open	

### Safety instructions for the installation

Install or store the appliance where it will not be exposed to sub-zero temperatures or exposed to the weather. Fit the power plug to a grounded wall socket that complies with all statutory regulations and ordinances. Ensure that the base opening is free from obstruction by carpeting if the washing machine is installed on a carpeted floor. In countries where there is a risk of cockroach infestation or other vermin, pay particular attention to keep the appliance and its surroundings in a clean condition at all times. Any damage which may be caused by cockroaches or other vermin is not covered by the appliance guarantee.

#### CAUTION about positioning the appliance

Install the washing machine on a flat hard floor. Make sure that air circulation around the washing machine is not impeded by carpets, rug etc.

- Never try to correct any unevenness in the floor using pieces of wood, cardboard or similar materials under the washing machine.
- If it is not possible to position the washing machine away from a gas cooker or coal burning stove, an insulation panel (85x60cm) covered with aluminum foil on the side facing the cooker or stove, must be inserted between the two appliances.
- The washing machine must not be installed in rooms where the temperature may drop below 0°C.
- Please ensure that when the washing machine is installed, that a Service Technician can gain easy access in the event of a breakdown.
- Adjust all four feet using the transit bolt spanner provided to ensure that the appliance is stable, with 20mm clearance between the top of the washing machine and underside of the worktop.

#### CAUTION about the power cord

We recommend connecting most appliances to a dedicated circuit which is protected by a mains fuse. That is, a single outlet supplying power only to the appliance concerned, without any additional outlets or branch circuits. Check the specifications of this owner's manual. Do not overload wall sockets. Overloaded wall sockets, loose or damaged wall sockets or extension cords, frayed power cords, damaged or cracked wire insulation are dangerous. Any of these conditions could result in electric shock or fire. Periodically examine the cord of your appliance, and if its appearance indicates damage or deterioration, unplug it, discontinue use of the appliance, and have the cord replaced with an exact replacement part by an authorized servicer. Protect the power cord from physical or mechanical abuse, such as being twisted, kinked, pinched, squashed in a jamb of a door, or walked upon. Pay particular attention to plugs, wall outlets, and the point where the cord exits the appliance.

#### CAUTION about location and moving

This equipment is not designed for maritime use or for use mobile installations such as caravans, aircraft etc. Turn off the stopcock if the machine is to be left for any length of time (e.g. if you are going on holiday), especially if there is no floor drain (gully) in the immediate vicinity. If relocating the appliance use the original packing material. Packaging material (e.g. plastic film, Styrofoam) can be dangerous for children. There is a risk of suffocation! Keep all packaging well away from children and do not allow children to play inside the bowl as they may become trapped.

#### CAUTION about the floor surface

- The installation surface must be clean, dry and level.
- Install washing machine on a flat hard floor. Poorly constructed timber base floors can contribute to excessive noise and vibration.
- Proper placement and levelling of the washing machine ensure long, regular and reliable operation.
- The washing machine must be perfectly level and firmly in position.
- It must not "see-saw" across corners under load.
- The installation surface must be clean, free from floor wax and other lubricant coatings.
- Do not allow the feet of the washing machine to get wet. If feet of the washing machine get wet, slipping may occur.

### Technical Specification

<b>Name of product</b>	Front loading washing machine	<b>Spin speed</b>	1400 rpm max.
<b>Power supply</b>	120 V~, 60 Hz	<b>Capacity (Wash)</b>	10.5 kg (23.14 lbs)
<b>Size WxDxH mm:</b>	600 x 640 x 850	<b>Capacity (Dry)</b>	5 kg (11.02 lbs)
<b>Weight</b>	72 kg (158.7 lbs)	<b>Permissible water pressure</b>	1.0-10 bar (100-1000kPa)

### Safety instructions for use

Read all instructions and explanations of the installation before use. Follow the instructions carefully. Keep the operating instructions handy for later use. If the appliance is sold or passed on then ensure that the new owner always receives these operating instructions. The following warnings must be strictly observed for safety reasons. They must be read before installing the appliance and putting it into operation.

Intended use: This appliance has been designed exclusively for use in dry-interior households. Use the appliance only with cold drinking water and only for washing textiles with washing detergents designed for washing machines. Every other use is improper and may lead to injuries, whereby the liability of the manufacturer will cease.

- This appliance may only be used by adults. Do not allow children to touch the controls or to play with the product.
- Never modify the appliance on your own, as this is dangerous.
- This appliance is heavy. Transporting with care.
- Remove all packaging and transport bolts before using the appliance. Otherwise serious damage may result.
- All installation work must be carried out by a qualified fitter or technician.
- Have electrical connections done by a qualified electrician.
- Never place the appliance on the power cord.
- If the appliance is placed on a carpet then place the feet so that air can circulate underneath the appliance.
- Always unplug the machine and turn off the water supply after use. Disconnect appliance by pulling only the plug - never disconnect by pulling the power cord. Never touch the plug with wet fingers or hands.
- Do not overload the appliance.
- Wash only machine-washable textiles. If you have doubts regarding this, then observe the markings on the label.
- Never place electrical heaters, candles etc. in the vicinity of the appliance. They could cause the appliance to ignite or parts to warp.
- Protect the appliance from wet and damp. Otherwise, there is danger of electric shock and fire.
- Connect the appliance to a suitable wall socket for 120V. Never use an extension cord or double adapter.
- Empty all pockets. Hard or sharp objects such as coins, needles, nails, screws or stones may cause serious damage. Unbalanced mass may create heavy vibrations. If heavy vibrations remain also without load, call for an authorized customer service.
- Do not wash or dry articles that have been cleaned in, washed in, soaked in, or dabbed with combustible or explosive substances (such as wax, oil, paint, gasoline, degreasers, dry-cleaning solvents, kerosene, etc.). This may result in fire or explosion.
- Never insert products coated with mineral oils (e.g. nylon coating, plastic belts, etc.) into the machine. If a stain remover has been used then make sure that the solvent has been carefully washed out before inserting the clothes into the appliance. Oil may remain in the tub after a whole cycle resulting in fire during drying. So, do not load oily clothes.
- Do not operate the appliance at locations where flammable substances are present such as oil, benzene or highly inflammable gas. Such materials may cause fire or explosion. Never use combustible detergents.
- Only add the prescribed amount of softener. Excessive amounts may damage the clothes.
- After washing, keep the drum door open to protect the door seal.
- Make sure that all water has run off before opening the door. Never open the door if water still remains. Danger of scalding.
- Animals and children may get into the washing machine. So always check the appliance before using it.
- During washing, the glass door becomes very hot. Keep children away from the appliance when in operation.
- Never try to repair the machine yourself. Incorrect repairs may result in injuries and/or serious defects to the machine.
- The product should be serviced and repaired only by the authorised customer service using original replacement parts.
- When disposing of your old machine, the power cable must be capped and the door lock must be made unusable in order to protect children.
- When placing on a carpeted floor, make sure that the opening in the socket is not blocked.
- If the appliance has been under water then contact the customer service. There is danger of electric shock and fire.
- The cover cup of the filter as well as the dispenser drawer may not be opened during the operation.
- Keep all washing powder and detergents away from children. Danger of poisoning

### Electrical connection

- Do not use an extension cord or double adapter.
- Have damaged supply cords replaced by the manufacturer or its service agents or a similarly qualified person to prevent danger.
- Always unplug the machine and turn off the water supply after use.
- Connect the machine to an earthed socket in accordance with current wiring regulations.
- The appliance must be positioned so that the plug is easily accessible.
  - Repairs to the washing machine must only be carried out by qualified personnel. Repairs carried out by inexperienced persons may cause injury or serious malfunctioning. Contact your local service centre.
  - Do not install your washing machine in rooms where temperature below freezing may occur. Frozen hoses may burst under pressure. The electronic control unit may become unreliable at temperatures below freezing point.
  - If the appliance is delivered in the winter months and temperatures are below freezing: Leave the washing machine standing at room temperature for a few hours before putting it into operation.

### CAUTION

The hose supplied with the machine must be used. Old hoses may not be reused.

### CAUTION

- The appliance is not intended for use by young children or infirm persons without supervision.
- Young Children should be supervised to ensure that they do not play with appliance.

### Installation of drain hose

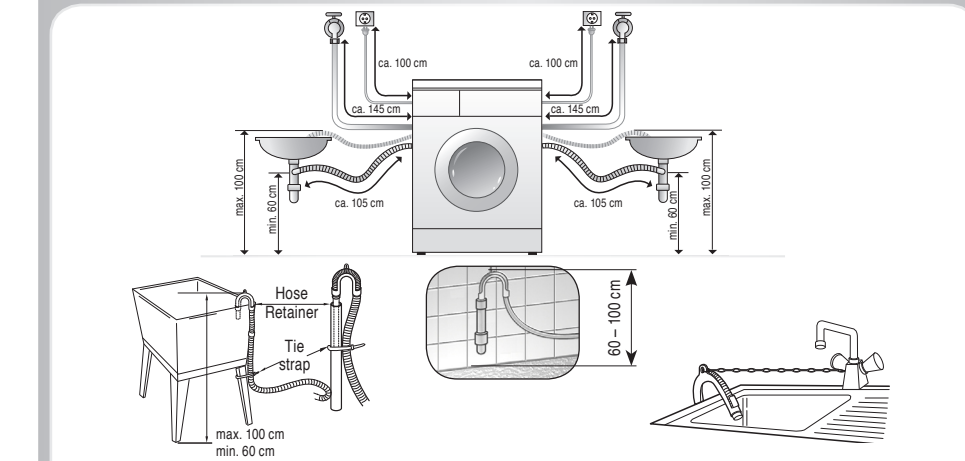

- The drain hose should not be placed higher than 100 cm above the floor.
- Proper securing of the drain hose will protect the floor from damage due to any water leakage.
- If the drain hose is too long do not force back into the washing machine. This will cause abnormal noise and cause the machine to malfunction and leak.

### Cleaning and Maintenance

**Warning:** Before cleaning the washing machine interior, unplug the electrical power cord to avoid the risk of electric shock.

#### Cleaning the water inlet filter

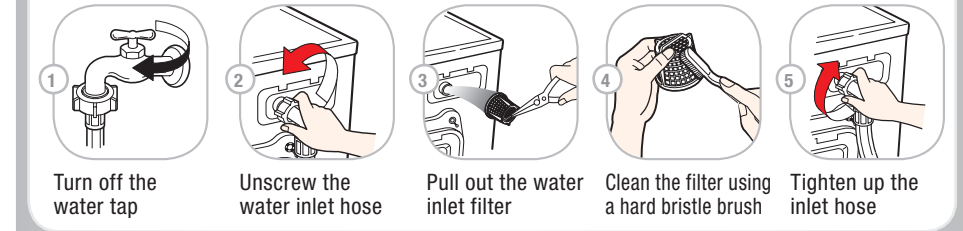

#### Cleaning the drain pump filter

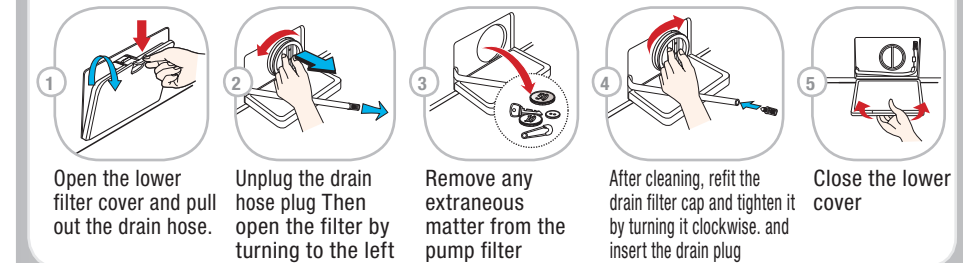

#### Cleaning the dispenser drawer

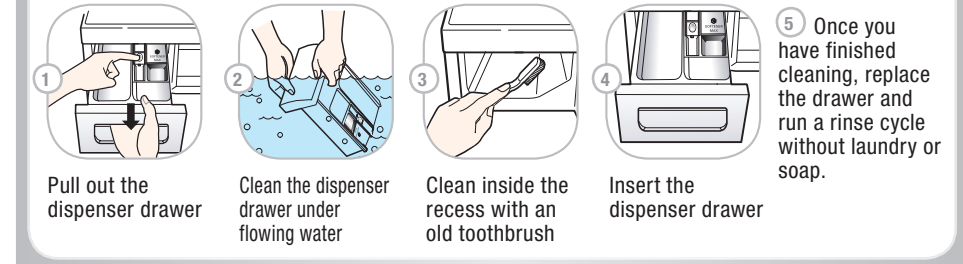

#### Cleaning in general

**Important:** Do not use methylated spirits, solvents or similar products.

**Exterior**  
Proper care of your washing machine can extend its service life. The outside of the machine can be cleaned with warm water and a neutral non-abrasive household detergent. Immediately wipe off any spillage. Wipe with damp cloth. Avoid striking the surface with sharp objects. Never hose down the machine!

**Interior**  
Dry opening the washing machine door around, flexible gasket and door glass. Run washing machine through a complete cycle using hot water. Repeat process if necessary.



## Preparation

### CHECKING THE MACHINE

Never use a defective machine! In case of any failure, first unplug the machine and turn off the water tap.

### WATER CONNECTION

Turn on the water tap

### HANG UP WASTE WATER HOSE

Hose elbow connection e.g. attach to water tap

### INSERT PLUS INTO THE MAINS SOCKET

Never touch the plug with wet hands!  
Never remove the plug from the socket by pulling on the cord.

### DOING LAUNDRY AND USING MACHINE WITH CARE

- empty all pockets
- remove all metal parts
- place the delicate textiles into the laundry net
- close zippers

### LAUNDRY WITH DIFFERENT AMOUNTS OF SOILING

- wash new textiles separately
- do not prewash
- pretreat dirty spots
- pre wash

### WATER TREATMENT

- with hardness III water
- use water softening agent

### DRUM CARE

- remove extraneous objects
- leave door open to dry the drum
- check the rubber seals regularly

### ECOLOGICAL WASHING

- make use of the max. washing quantity
- do not "pre wash" if possible
- use short program if possible

## Washing symbols

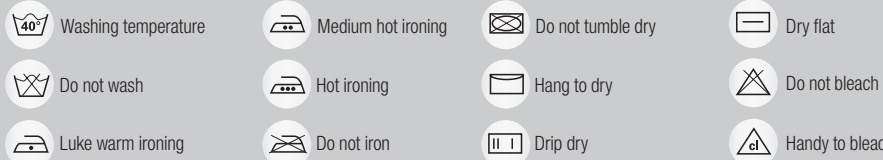

## Dispenser drawer

### A Pre Wash

The Pre wash compartment can be used for Normal to heavy soiled clothes, by adding a prewash or normal detergent to this compartment before selecting this wash option with the Cycle.

### B Main Wash

For Laundry requiring detergent, place recommended dosage in to this compartment. Please note that liquid detergent will enter the tub as it is poured and may not be suitable for a delay start.

### C Softener

Do not exceed the MAX-Level. Highly densified softeners are to be diluted with some water. Excessive softener can cause brown or grey spotting on the clothes.

## Washing program table

Program	Fabric Type	Water Temp. (Option)	Option	Dry (Option)	Maximum Load
Cotton	Color fast garments (shirts, nightdresses, pajamas...) and lightly soiled white cotton (underwear)	60°C (Cold, 30°C, 40°C, 50°C)	- Time Delay - Intensive - Medic Rinse - Pre Wash - Cupboard Dry - Rinse+ - Rinse+Spin - Normal+Hold	- Low Temp. - Iron Dry - Cupboard Dry - Very Dry - Time	Rating
Cotton Quick	Lightly soiled clothing and small loads	40°C (Cold, 30°C, 50°C)			Less than 7.0 Kg
Synthetic	Polyamide, Acrylic, Polyester	60°C (40°C, 50°C)			Less than 4.5Kg
Baby Care	Lightly soiled baby wear	60°C (40°C, 50°C)			
Quick 30	Colored laundry which is lightly soiled fast	30°C (Cold, 40°C)			Less than 2.0kg
Delicate	Delicate laundry easily damaged	30°C (Cold, 40°C)			
Hand Wash	"Hand wash" marked delicate and wool laundry	40°C (Cold, 30°C)	- Time Delay - Intensive - Rinse+ - Rinse+Spin - Normal+Hold		
Wool	Machine washable woolsens with pure new wool only	40°C (Cold, 30°C)			
Duvet	Cotton bedding with filling duvet, pillow, blanket, sofa cover with light filling				1 king size (9 Tog)

**Water Temperature:** Select water temperature to suit wash cycles. Always follow garment manufacturer's care label or instructions when washing.

**Intensive:** If the laundry is heavily soiled "Intensive" option is effective.

**Pre Wash:** If the laundry is heavily soiled, "Pre Wash" Cotton is recommended. Pre Wash is available in the Cotton, Cotton Quick, Synthetic and Baby Care program.

**Rinse+ :** Used to introduce an additional rinse, which may assist in removing traces of detergent residue.

**Medic Rinse:** For best results or for cleaner rinsing, you can choose this heated Rinse option. Medic Rinse is automatically selected on Baby Care program.

**Notes**  
Neutral detergent is recommended. The wool cycle features gentle tumbling and low-speed spin for garment care.

**Warning:** Keep all washing powder and detergents away from children. Danger of poisoning

## Sort the laundry

note washing instruction symbols - Degree of soiling - Type of textile / colour -

## Loading the Drum

Check the folds of the flexible gasket (grey) - and remove any small articles or foreign objects that may have fallen from items in the previous wash. Check all garments for loose items before loading and ensure that clothes are clear of the door gasket before closing the door so that the clothes or door gasket are not damaged during the wash.



## Fill detergent

Refer to the written information on the detergent's packaging

## Turn the machine ON

by pressing the Power button

## Select a Program

Pre Wash / Rinse+Spin / Rinse+ / Normal+Hold

## Select an Option

Pre Wash / Rinse+Spin / Rinse+ / Normal+Hold

## Select Spinning speed and Washing temperature

1400, 1000, 800, 400, No Spin

## Select the Dry mode

Cupboard Dry, Iron Dry, Very Dry, Low Temp.

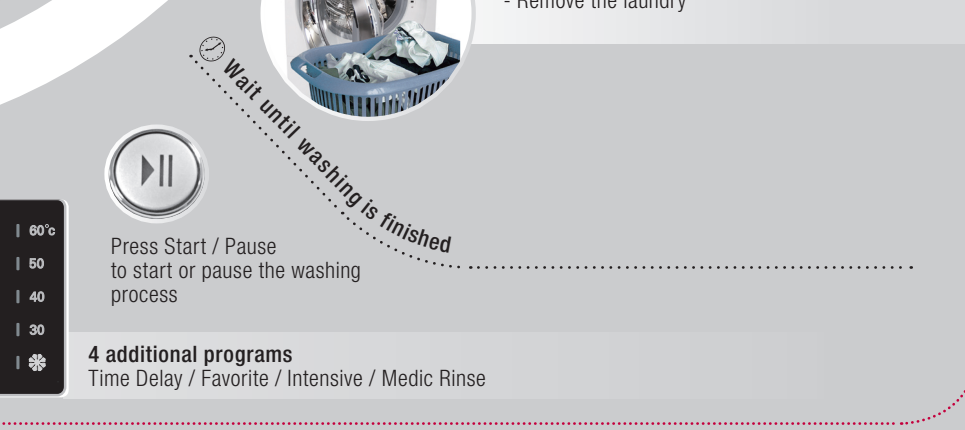
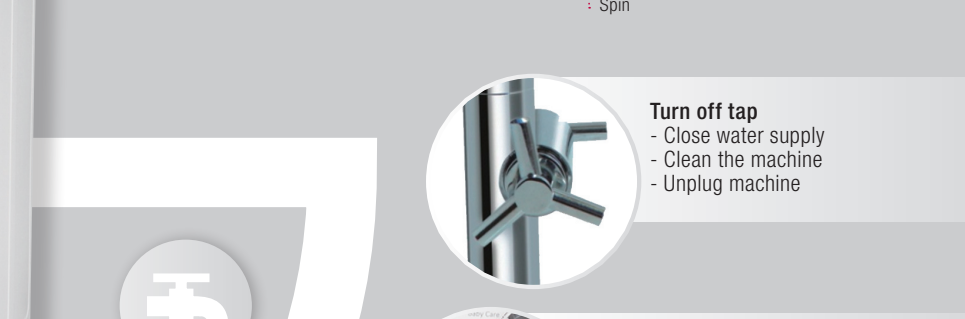
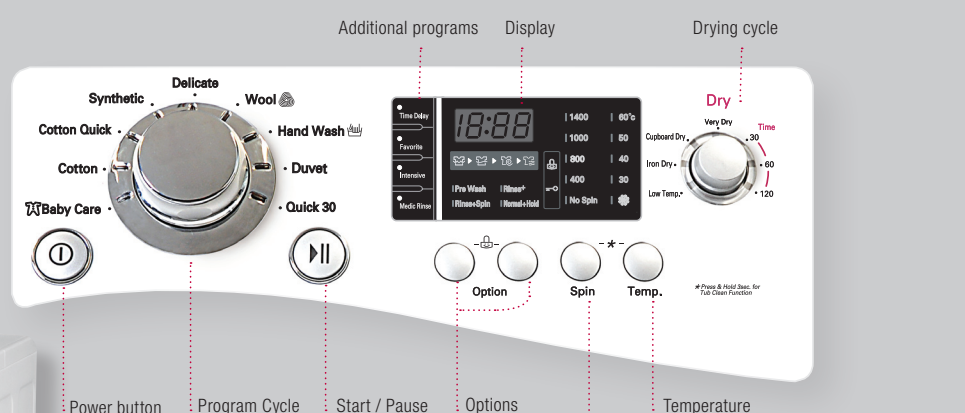
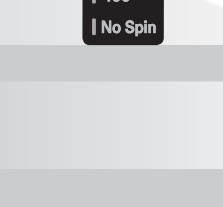
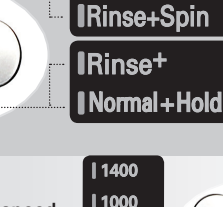

## Additional programs

### Time Delay

Allows you to set the cycle's ending time (by hourly increments) in advance.

### How to set "Time Delay"

- Press Power button.
- Turn the Program dial to select the program you require.
- Press Time Delay button and set the finishing time. The machine will then automatically work out the turn on time based on the chosen cycle.
- Press the Start/Pause button.

### Favorite

- Favorite program allows you to store a customized wash cycle for future use.

- To make a Favorite program:

- (1) Select a cycle.
- (2) Select the course, washing method, number of rinses, spin speed, water temperature etc.
- (3) Press and hold Favorite program button 3 seconds (2 beep sounds). The Favorite program is now stored for future use.

To reuse the program, select Favorite program and press Start/Pause.

### Intensive

If the laundry is heavily soiled "Intensive" option is effective.

- By selecting the Intensive option, the washing duration may be extended, depending on the program selected.
- To use this option, press the intensive button once before the wash program is started.

### Medic Rinse

For best results or for cleaner rinsing, select the "Medic Rinse" option.

This allows the final rinse to be heated to 40 degrees.

Available in the Cotton, Cotton Quick, Synthetic and Baby Care programs. Medic Rinse is set by default in the Baby Care program. The respective temperature indicator will light up.

### Woolen Articles

- Do not tumble dry woolen articles. Pull them to their original shape and dry them flat.

### Woven and Loopknit Materials

- Some woven and loopknit materials may shrink, by varying amounts, depending on their quality.

- Always stretch them out immediately after drying.

### Permanent Press and Synthetics

- Do not overload your dryer

- Take out permanent press articles as soon as the dryer stops to reduce wrinkles.

### Fiber or Leather Materials

- Always check the manufacturer's instructions.

### Child Lock

Select this function to lock the buttons on the control panel and to prevent tampering.

### Change to the desired program, whilst in child lock mode:

To activate: press and hold the Option buttons simultaneously until "CL" appears in the display.

To deactivate: press and hold the Option buttons simultaneously for 3 seconds until the "CL" is removed from the display.

Press and hold the Option buttons simultaneously

Press Start/Pause

Select the desired program

Press Start/Pause

## Dry

Cold water tap must be left on during drying cycles.

This washer-dryer's automatic process from washing to drying can be selected easily.

For most even drying, make sure all articles in the clothes load are similar in material and thickness.

Do not overload dryer by stuffing too many articles into drum. Items must be able to tumble freely

If you open door and remove load before dryer has finished its cycle, remember to press the Start/Pause button.

By turning the DRY dial, you can select:

Cupboard Dry → Very Dry → 30 → 60 → 120 → Low Temp. → Iron Dry

After the end of dry, "CL" is displayed. By pressing the "Start/Pause" button the program can be ended. If you not press the "Start/Pause" button, the program is ended after about 4 hours. "CL" Cooling Cycle.

### 1. Drying Automatic guide

Use your Automatic Cycles to dry most loads. Electronic sensors measures the temperature of the exhaust to increase or decrease drying temperatures for faster reaction time and tighter temperature control.

Recommend Automatic drying course as a kind of clothes.

a) Low Temp. : For Synthetics select

b) Iron Dry : If you want to iron clothes

c) Cupboard Dry : For Cottons select

d) Very Dry : A special cycle to reduce water usage during the dry cycle.

e) Time (30/60/120 minutes) - 30 min. : Cotton 1.5 kg

- 60 min. : Cotton 3 kg

- 120 min. : Towel 4.5 kg

**Note:** The estimated drying time varies from the actual drying time with an Automatic. The type of fabric, size of the load, and the dryness selected affect drying time.

### 2. Drying time guide

By turning the DRY dial, the drying time can be selected.

Drying course can last up to 150min.

When selecting drying only, drying course will start after spinning.

These drying times are given as a guide to help you set your dryer for manual drying.

Drying times can vary greatly depending on dampness, room temperature and type of fabric and your own experience will be your best guide.

### Woolen Articles

- Do not tumble dry woolen articles. Pull them to their original shape and dry them flat.

### Woven and Loopknit Materials

- Some woven and loopknit materials may shrink, by varying amounts, depending on their quality.

- Always stretch them out immediately after drying.

### Permanent Press and Synthetics

- Do not overload your dryer

- Take out permanent press articles as soon as the dryer stops to reduce wrinkles.

### Fiber or Leather Materials

- Always check the manufacturer's instructions.

### Child Lock

Select this function to lock the buttons on the control panel and to prevent tampering.

Change to the desired program, whilst in child lock mode:

To activate: press and hold the Option buttons simultaneously until "CL" appears in the display.

To deactivate: press and hold the Option buttons simultaneously for 3 seconds until the "CL" is removed from the display.

Press and hold the Option buttons simultaneously

Press Start/Pause

Select the desired program

Press Start/Pause

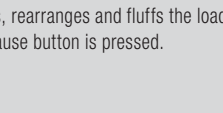
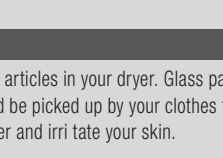
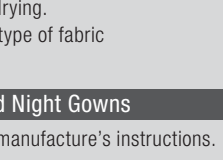
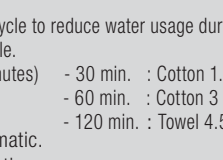

**To activate:** press and hold the Option buttons simultaneously until "CL" appears in the display.

**To deactivate:** press and hold the Option buttons simultaneously for 3 seconds until the "CL" is removed from the display.

Press and hold the Option buttons simultaneously

Press Start/Pause

Select the desired program

Press Start/Pause

Select the desired program

Press Start/Pause

Press Start/Pause

**Note:** The estimated drying time varies from the actual drying time with an Automatic. The type of fabric, size of the load, and the dryness selected affect drying time.

**Note:** The estimated drying time varies from the actual drying time with an Automatic. The type of fabric, size of the load, and the dryness selected affect drying time.

**Note:** The estimated drying time varies from the actual drying time with an Automatic. The type of fabric, size of the load, and the dryness selected affect drying time.

**Note:** The estimated drying time varies from the actual drying time with an Automatic. The type of fabric, size of the load, and the dryness selected affect drying time.

**Note:** The estimated drying time varies from the actual drying time with an Automatic. The type of fabric, size of the load, and the dryness selected affect drying time.

**Note:** The estimated drying time varies from the actual drying time with an Automatic. The type of fabric, size of the load, and the dryness selected affect drying time.

**Note:** The estimated drying time varies from the actual drying time with an Automatic. The type of fabric, size of the load, and the dryness selected affect drying time.

**Note:** The estimated drying time varies from the actual drying time with an Automatic. The type of fabric, size of the load, and the dryness selected affect drying time.

**Note:** The estimated drying time varies from the actual drying time with an Automatic. The type of fabric, size of the load, and the dryness selected affect drying time.

**Note:** The estimated drying time varies from the actual drying time with an Automatic. The type of fabric, size of the load, and the dryness selected affect drying time.

**Note:** The estimated drying time varies from the actual drying time with an Automatic. The type of fabric, size of the load, and the dryness selected affect drying time.

**Note:** The estimated drying time varies from the actual drying time with an Automatic. The type of fabric, size of the load, and the dryness selected affect drying time.

**Note:** The estimated drying time varies from the actual drying time with an Automatic. The type of fabric, size of the load, and the dryness selected affect drying time.

**Note:** The estimated drying time varies from the actual drying time with an Automatic. The type of fabric, size of the load, and the dryness selected affect drying time.

**Note:** The estimated drying time varies from the actual drying time with an Automatic. The type of fabric, size of the load, and the dryness selected affect drying time.

**Note:** The estimated drying time varies from the actual drying time with an Automatic. The type of fabric, size of the load, and the dryness selected affect drying time.

**Note:** The estimated drying time varies from the actual drying time with an Automatic. The type of fabric, size of the load, and the dryness selected affect drying time.

**Note:** The estimated drying time varies from the actual drying time with an Automatic. The type of fabric, size of the load, and the dryness selected affect drying time.

**Note:** The estimated drying time varies from the actual drying time with an Automatic. The type of fabric, size of the load, and the dryness selected affect drying time.

**Note:** The estimated drying time varies from the actual drying time with an Automatic. The type of fabric, size of the load, and the dryness selected affect drying time.

**Note:** The estimated drying time varies from the actual drying time with an Automatic. The type of fabric, size of the load, and the dryness selected affect drying time.

**Note:** The estimated drying time varies from the actual drying time with an Automatic. The type of fabric, size of the load, and the dryness selected affect drying time.

**Note:** The estimated drying time varies from the actual drying time with an Automatic. The type of fabric, size of the load, and the dryness selected affect drying time.

**Note:** The estimated drying time varies from the actual drying time with an Automatic. The type of fabric, size of the load, and the dryness selected affect drying time.

**Note:** The estimated drying time varies from the actual drying time with an Automatic. The type of fabric, size of the load, and the dryness selected affect drying time.

**Note:** The estimated drying time varies from the actual drying time with an Automatic. The type of fabric, size of the load, and the dryness selected affect drying time.

**Note:** The estimated drying time varies from the actual drying time with an Automatic. The type of fabric, size of the load, and the dryness selected affect drying time.

**Note:** The estimated drying time varies from the actual drying time with an Automatic. The type of fabric, size of the load, and the dryness selected affect drying time.

**Note:** The estimated drying time varies from the actual drying time with an Automatic. The type of fabric, size of the load, and the dryness selected affect drying time.

**Note:** The estimated drying time varies from the actual drying time with an Automatic. The type of fabric, size of the load, and the dryness selected affect drying time.

**Note:** The estimated drying time varies from the actual drying time with an Automatic. The type of fabric, size of the load, and the dryness selected affect drying time.

**Note:** The estimated drying time varies from the actual drying time with an Automatic. The type of fabric, size of the load, and the dryness selected affect drying time.

**Note:** The estimated drying time varies from the actual drying time with an Automatic. The type of fabric, size of the load, and the dryness selected affect drying time.

**Note:** The estimated drying time varies from the actual drying time with an Automatic. The type of fabric, size of the load, and the dryness selected affect drying time.

**Note:** The estimated drying time varies from the actual drying time with an Automatic. The type of fabric, size of the load, and the dryness selected affect drying time.

**Note:** The estimated drying time varies from the actual drying time with an Automatic. The type of fabric, size of the load, and the dryness selected affect drying time.

**Note:** The estimated drying time varies from the actual drying time with an Automatic. The type of fabric, size of the load, and the dryness selected affect drying time.

**Note:** The estimated drying time varies from the actual drying time with an Automatic. The type of fabric, size of the load, and the dryness selected affect drying time.

**Note:** The estimated drying time varies from the actual drying time with an Automatic. The type of fabric, size of the load, and the dryness selected affect drying time.

**Note:** The estimated drying time varies from the actual drying time with an Automatic. The type of fabric, size of the load, and the dryness selected affect drying time.

**Note:** The estimated drying time varies from the actual drying time with an Automatic. The type of fabric, size of the load, and the dryness selected affect drying time.

**Note:** The estimated drying time varies from the actual drying time with an Automatic. The type of fabric, size of the load, and the dryness selected affect drying time.