



The model and serial number of the TV is located on the back and one side of the TV. Record it below should you ever need service.

MODEL \_\_\_\_\_

SERIAL \_\_\_\_\_

(For LED LCD TV)



This product qualifies for ENERGY STAR in the "factory default (Home Use)" setting. Changing the factory default settings or enabling other features may increase power consumption that could exceed the limits necessary to qualify for ENERGY STAR.

## OWNER'S MANUAL

# LED LCD TV / PLASMA TV

Please read this manual carefully before operating your set and retain it for future reference.

#### LED LCD TV MODELS

47LX9500  
55LX9500  
47LEX8  
55LEX8  
60LEX9  
72LEX9

#### PLASMA TV MODELS

50PK950  
60PK950  
50PX950  
60PX950

P/NO : MFL62882734 (1008-REV00)

[www.lg.com](http://www.lg.com)

# WARNING / CAUTION



**WARNING / CAUTION**  
RISK OF ELECTRIC SHOCK  
DO NOT OPEN



TO REDUCE THE RISK OF ELECTRIC SHOCK DO NOT REMOVE COVER (OR BACK). NO USER SERVICEABLE PARTS INSIDE. REFER TO QUALIFIED SERVICE PERSONNEL.



The lightning flash with arrowhead symbol, within an equilateral triangle, is intended to alert the user to the presence of uninsulated "dangerous voltage" within the product's enclosure that may be of sufficient magnitude to constitute a risk of electric shock to persons.



The exclamation point within an equilateral triangle is intended to alert the user to the presence of important operating and maintenance (servicing) instructions in the literature accompanying the appliance.

## WARNING/CAUTION

TO REDUCE THE RISK OF FIRE AND ELECTRIC SHOCK, DO NOT EXPOSE THIS PRODUCT TO RAIN OR MOISTURE.

# SAFETY INSTRUCTIONS

## IMPORTANT SAFETY INSTRUCTIONS

Read these instructions.

Keep these instructions.

Heed all warnings.

Follow all instructions.



- 1** Do not use this apparatus near water.



- 2** Clean only with dry cloth.



- 3** Do not block any ventilation openings. Install in accordance with the manufacturer's instructions.



- 4** Do not install near any heat sources such as radiators, heat registers, stoves, or other apparatus (including amplifiers) that produce heat.



- 5** Protect the power cord from being walked on or pinched particularly at plugs, convenience receptacles, and the point where they exit from the apparatus.



- 6** Only use attachments/accessories specified by the manufacturer.



- 7** Use only with the cart, stand, tripod, bracket, or table specified by the manufacturer, or sold with the apparatus. When a cart is used, use caution when moving the cart/apparatus combination to avoid injury from tip-over.



SS125A

- 8** Unplug this apparatus during lighting storms or when unused for long periods of time.

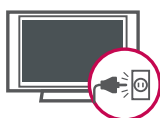

- 9** Refer all servicing to qualified service personnel. Servicing is required when the apparatus has been damaged in any way, such as power-supply cord or plug is damaged, liquid has been spilled or objects have fallen into the apparatus, the apparatus has been exposed to rain or moisture, does not operate normally, or has been dropped.



- 10** Never touch this apparatus or antenna during a thunder or lightning storm.

- 11** When mounting a TV on the wall, make sure not to install the TV by the hanging power and signal cables on the back of the TV.

- 12** Do not allow an impact shock or any objects to fall into the product, and do not drop onto the screen with something.

- 13** CAUTION concerning the Power Cord: It is recommend that appliances be placed upon a dedicated circuit; that is, a single outlet circuit which powers only that appliance and has no additional outlets or branch circuits. Check the specification page of this owner's manual to be certain. Do not connect too many appliances to the same AC power outlet as this could result in fire or electric shock.

Do not overload wall outlets. Overloaded wall outlets, loose or damaged wall outlets, extension cords, frayed power cords, or damaged or cracked wire insulation are dangerous. Any of these conditions could result in electric shock or fire. Periodically examine the cord of your appliance, and if its appearance indicates damage or deterioration, unplug it, discontinue use of the appliance, and have the cord replaced with an exact replacement part by an authorized servicer. Protect the power cord from physical or mechanical abuse, such as being twisted, kinked, pinched, closed in a door, or walked upon. Pay particular attention to plugs, wall outlets, and the point where the cord exits the appliance.

Do not make the TV with the power cord plugged in. Do not use a damaged or loose power cord. Be sure do grasp the plug when unplugging the power cord. Do not pull on the power cord to unplug the TV.



# SAFETY INSTRUCTIONS

- 14** **WARNING** - To reduce the risk of fire or electrical shock, do not expose this product to rain, moisture or other liquids. Do not touch the TV with wet hands. Do not install this product near flammable objects such as gasoline or candles or expose the TV to direct air conditioning.



- 15** Do not expose to dripping or splashing and do not place objects filled with liquids, such as vases, cups, etc. on or over the apparatus (e.g. on shelves above the unit).



## **16** **GROUNDING**

Ensure that you connect the earth ground wire to prevent possible electric shock (i.e. a TV with a three-prong grounded AC plug must be connected to a three-prong grounded AC outlet). If grounding methods are not possible, have a qualified electrician install a separate circuit breaker.

Do not try to ground the unit by connecting it to telephone wires, lightening rods, or gas pipes.

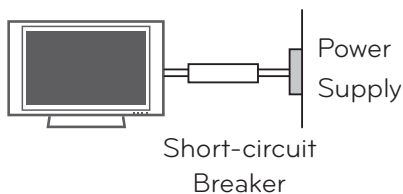

## **17** **DISCONNECTING DEVICE FROM MAINS**

Mains plug is the disconnecting device. The plug must remain readily operable.

- 18** As long as this unit is connected to the AC wall outlet, it is not disconnected from the AC power source even if you turn off this unit by SWITCH.

## **19** **Cleaning**

When cleaning, unplug the power cord and scrub gently with a soft cloth to prevent scratching. Do not spray water or other liquids directly on the TV as electric shock may occur. Do not clean with chemicals such as alcohol, thinners or benzene.

## **20** **Moving**

Make sure the product is turned off, unplugged and all cables have been removed. It may take 2 or more people to carry larger TVs. Do not press against or put stress on the front panel of the TV.

## **21** **Ventilation**

Install your TV where there is proper ventilation. Do not install in a confined space such as a bookcase. Do not cover the product with cloth or other materials (e.g.) plastic while plugged in. Do not install in excessively dusty places.

- 22** Take care not to touch the ventilation openings. When watching the TV for a long period, the ventilation openings may become hot.

- 23** If you smell smoke or other odors coming from the TV, unplug the power cord contact and authorized service center.

- 24** Do not press strongly upon the panel with hand or sharp object such as nail, pencil or pen, or make a scratch on it.

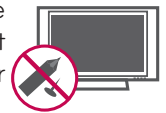

- 25** Keep the product away from direct sunlight.

## **26** **Dot Defect**

The Plasma or LCD panel is a high technology product with resolution of two million to six million pixels. In a very few cases, you could see fine dots on the screen while you're viewing the TV. Those dots are deactivated pixels and do not affect the performance and reliability of the TV.

## 27 Generated Sound

"Cracking" noise: A cracking noise that occurs when watching or turning off the TV is generated by plastic thermal contraction due to temperature and humidity. This noise is common for products where thermal deformation is required.

Electrical circuit humming/panel buzzing: A low level noise is generated from a high-speed switching circuit, which supplies a large amount of current to operate a product. It varies depending on the product.

This generated sound does not affect the performance and reliability of the product.

## 28 For LED LCD TV/LCD TV

If the TV feels cold to the touch, there may be a small "flicker" when it is turned on. This is normal, there is nothing wrong with TV.

Some minute dot defects may be visible on the screen, appearing as tiny red, green, or blue spots. However, they have no adverse effect on the monitor's performance.

Avoid touching the LCD screen or holding your finger(s) against it for long periods of time. Doing so may produce some temporary distortion effects on the screen.

## 31 Viewing 3D Imaging (For 3D TV)

- ▶ When viewing 3D imaging, watch the TV from an effective viewing angle and within the appropriate distance. If you exceed this viewing angle or distance, you may not be able to view the 3D imaging. Furthermore, the 3D imaging may not display if it is viewed while you are lying down.
- ▶ If you watch the 3D imaging too closely or for a long period of time, it may harm your eyesight.
- ▶ Watching the TV or playing video games that incorporate 3D imaging with the 3D glasses for a long period of time can cause drowsiness, headaches or fatigue to you and/or your eyes. If you have a headache, or otherwise feel fatigued or drowsy, stop watching the TV and take a rest.
- ▶ Pregnant woman, seniors, persons with heart problems or persons who experience frequent drowsiness should refrain from watching 3D TV.
- ▶ Some 3D imaging may cause you to duck or dodge the image displayed in the video. Therefore, it is best if you do not watch 3D TV near fragile objects or near any objects that can be knocked over easily.
- ▶ Please prevent children under the age of 5 from watching 3D TV. It may affect their vision development.
- ▶ Warning for photosensitization seizure: Some viewers may experience a seizure or epilepsy when exposed to certain factors, including flashing lights or images in TV or video games. If you or anybody from your family has a history of epilepsy or seizure, please consult with your doctor before watching 3D TV.

# SAFETY INSTRUCTIONS

Also certain symptoms can occur in unspecified conditions without any previous history. If you experience any of the following symptoms, immediately stop watching the 3D imaging and consult a doctor: dizziness or lightheadedness, visual transition or altered vision, visual or facial instability, such as eye or muscle twitching, unconscious action, convulsion, loss of conscience, confusion or disorientation, loss of directional sense, cramps, or nausea. Parents should monitor their children, including teenagers, for these symptoms as they may be more sensitive to the effects of watching 3D TV.

Risk of photosensitization seizure can be reduced with the following actions.

- Take frequent breaks from watching 3D TV.
- For those who have vision that is different in each eye, they should watch the TV after taking vision correction measures.
- Watch the TV so that your eyes are on the same level as the 3D screen and refrain from sitting too closely to the TV
- Do not watch the 3D imaging when tired or sick, and avoid watching the 3D imaging for a long period of time.
- Do not wear the 3D glasses for any other purpose than viewing 3D imaging on a 3D TV.
- Some viewers may feel disoriented after watching 3D TV. Therefore, after you watch 3D TV, take a moment to regain awareness of your situation before moving.

## **ON DISPOSAL**

### **(Only Hg lamp used LCD TV)**

The fluorescent lamp used in this product contains a small amount of mercury. Do not dispose of this product with general household waste. Disposal of this product must be carried out in accordance to the regulations of your local authority.

# CONTENTS

<b>WARNING / CAUTION</b> .....	2
<b>SAFETY INSTRUCTIONS</b> .....	3
<b>CONTENTS</b> .....	7
<b>FEATURE OF THIS TV</b> .....	9

## PREPARATION

Accessories .....	10
Optional Extras .....	11
Front Panel Information .....	12
Back Panel Information .....	15
Stand Instructions .....	18
VESA Wall Mounting .....	22
Cable Management .....	24
Desktop Pedestal Installation .....	26
Swivel Stand .....	26
Kensington Security System .....	26
Securing the TV to the wall to prevent falling when the tv is used on a stand .....	27
Antenna or Cable Connection .....	28

## EXTERNAL EQUIPMENT SETUP

HD Receiver Setup .....	29
DVD SETUP .....	33
VCR SETUP .....	36
Other A/V Source Setup .....	38
USB Connection .....	38
Headphone Setup .....	39
Audio Out Connection .....	40
External Equipment Wireless Connection (Optional Extras) .....	41
PC Setup .....	42
Network Setup .....	47

## WATCHING TV / CHANNEL CONTROL

Remote Control Functions .....	55
Magic Motion Remote Control Functions .....	58
Turning on the TV .....	61
Channel Selection .....	61
Volume Adjustment .....	61
Initial Setting .....	62

On-Screen Menus Selection .....	64
Quick Menu .....	66
Home Menu .....	67
Customer Support	
- Software Update .....	68
- Picture Test/Sound Test .....	69
- Product/Service Info .....	70
- Network Test .....	71
Simple Manual .....	72
Channel Setup	
- Auto Scan (Auto Tuning) .....	73
- Add/Delete Channel (Manual Tuning) .....	74
- Channel Editing .....	75
Channel List .....	76
Favorite Channel Setup .....	77
Channel Information .....	78
Channel Brief Information .....	79
Input List .....	80
Input Label .....	81
Reset to Factory Default (Initial Setting) .....	82
Mode Setting .....	83
Demo Mode .....	84
AV Mode .....	85
Game/Schedule .....	86
SIMPLINK .....	90

## 3D VIDEO

3D Video .....	92
Watching 3D Video .....	94

## MY MEDIA

Entry Mode .....	96
Connection Method .....	97
Movie list .....	102
Photo list .....	109
Music list .....	115
DivX Registration Code .....	120
Deactivation .....	121

## NETWORK

Legal Notice .....	122
--------------------	-----

## NETCAST

Netcast Menu.....	123
YOUTUBE.....	124
PICASA.....	126

## PICTURE CONTROL

Picture Size (Aspect Ratio) Control.....	128
Picture Wizard.....	130
 Energy Saving .....	132
Preset Picture Settings (Picture Mode).....	133
Manual Picture Adjustment - User Mode	134
Picture Improvement Technology (Advanced Control) .....	135
Expert Picture control.....	136
Picture Reset.....	139
TruMotion .....	140
LED Local Dimming .....	141
Power Indicator .....	142
Image Sticking Minimization (ISM) Method .	143

## SOUND & LANGUAGE CONTROL

Auto Volume.....	144
Clear Voice II .....	145
Balance .....	146
Preset Sound Settings (Sound Mode) .....	147
Sound Setting Adjustment - User Mode.	148
Audio Reset.....	149
TV Speakers On/Off Setup .....	150
Stereo/SAP Broadcast Setup .....	151
Audio Language .....	152
On-screen Menus Language Selection....	153
Caption Mode	
- Analog Broadcasting System Captions.	154
- Digital Broadcasting System Captions...	155
- Caption Option.....	156

## TIME SETTING

Clock Setting	
- Auto Clock Setup .....	157
- Manual Clock Setup .....	158
Auto On/Off Time Setting .....	159
Sleep Timer Setting .....	160

## PARENTAL CONTROL / RATINGS

Set Password & Lock System	
- Setting up Your Password.....	161
- Set Password .....	162
Lock System.....	163
Channel Blocking.....	164
Movie & TV Rating .....	165
Downloadable Rating.....	170
External Input Blocking .....	171
Key Lock.....	172

## APPENDIX

Troubleshooting.....	173
Maintenance.....	176
Product Specifications .....	177
IR Codes.....	180
External Control Through RS-232C .....	182
Open Source Software Notice.....	188



# FEATURE OF THIS TV

- Some of these features are not available on all models.



High-definition television. High-resolution digital television broadcast and playback system composed of roughly a million or more pixels, 16:9 aspect-ratio screens, and AC3 digital audio. A subset of digital television, HDTV formats include 1080p, 1080i, and 720p resolutions.



Manufactured under license from Dolby Laboratories. "Dolby" and the double-D symbol are trademarks of Dolby Laboratories.



HDMI, the HDMI logo and High-Definition Multimedia Interface are trademarks or registered trademarks of HDMI Licensing LLC."



**ABOUT DIVX VIDEO:** DivX® is a digital video format created by DivX, Inc. This is an official DivX Certified device that plays DivX video. Visit [www.divx.com](http://www.divx.com) for more information and software tools to convert your files into DivX video.

**ABOUT DIVX VIDEO-ON-DEMAND:** This DivX Certified® device must be registered in order to play DivX Video-on-Demand (VOD) content. To generate the registration code, locate the DivX VOD section in the device setup menu. Go to [vod.divx.com](http://vod.divx.com) with this code to complete the registration process and learn more about DivX VOD.

"DivX Certified to play DivX video up to HD 1080p, including premium content"

"Pat. 7,295,673; 7,460,668; 7,515,710; 7,519,274"



This TV contains the detailed calibrations necessary for professional certification by the Imaging Science Foundation. The resulting ISF "day" and "night" modes will then be accessible by the user to experience the best their LG HDTV has to offer.

Sophisticated and detailed calibrations can be made through the ISFccc mode. Detailed calibration requires a licensed technician.

Please contact your local dealer to inquire about an ISF certified technician.



THX (Thomlinson Holman's Experiment) is an audio and video certification standard established by George Lucas and Thomlinson. A THX certified display guarantees screen quality that exceeds the display standard specification in both hardware and software.



View videos and photos and listen to music on your TV through USB 2.0 ('videos' dependent on model).



Displays HDTV programs in full 1920 x 1080p resolution for a more detailed picture.



## IMPORTANT INFORMATION TO PREVENT "IMAGE BURN / BURN-IN" ON YOUR TV SCREEN

- When a fixed image (e.g. logos, screen menus, video game, and computer display) is displayed on the TV for an extended period, it can become permanently imprinted on the screen. This phenomenon is known as "image burn" or "burn-in." Image burn is not covered under the manufacturer's warranty.
- In order to prevent image burn, avoid displaying a fixed image on your TV screen for a prolonged period (2 or more hours for LCD, 1 or more hours for Plasma).
- Image burn can also occur on the letter-boxed areas of your TV if you use the 4:3 aspect ratio setting for an extended period.

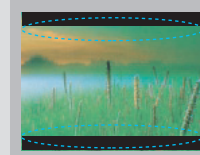
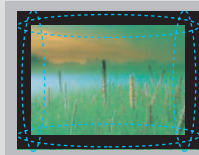
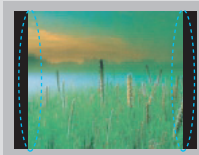

# PREPARATION

PREPARATION

## ACCESSORIES

Ensure that the following accessories are included with your TV. If an accessory is missing, please contact the dealer where you purchased the TV.

The accessories included may differ from the images below.



Owner's Manual



Nero MediaHome 4  
Essentials CD

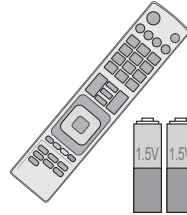

Remote Control,  
Batteries (AAA)

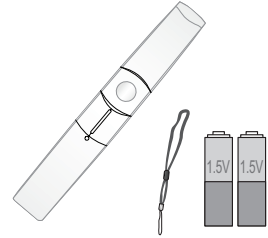

Motion Remote Control,  
Strap,  
Batteries (AA)

### Not included with all models

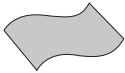

Polishing Cloth

- \* Wipe spots on the exterior only with the polishing cloth.
- \* Do not wipe roughly when removing stains. Excessive pressure may cause scratches or discoloration.

### Option Extras

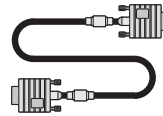

D-sub 15 pin Cable

When using the VGA (D-sub 15 pin cable) PC connection, the user must use shielded signal interface cables with ferrite cores to maintain standards compliance.

### Not included with all models



Ferrite Core  
(Black)

Ferrite core can be used to reduce the electromagnetic waves that may interfere with the TV. Install the Ferrite core on the power cable close to the wall plug.



Ferrite Core  
(White)

Ferrite core can be used to reduce the electromagnetic wave when connecting the LAN cable. Place the ferrite core far from TV and wind the LAN cable in the ferrite core once.

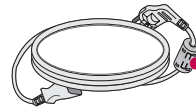

Close to the wall plug.



47/55LX9500, 47/55LEX8, 60/72LEX9

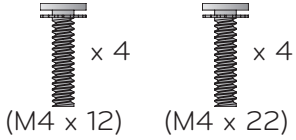

Screws for stand assembly  
(Refer to P.20)



Cable Holder  
(Refer to p.25)

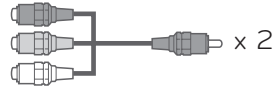

Component gender cable,  
AV gender cable

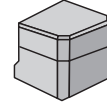

Stand Rear Cover

(For 47/55LX9500)



3D Glasses

Plasma TV

(For 50PK950, 50PX950)

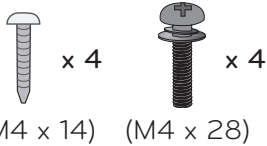

Screws for stand assembly  
(Refer to P.18)



Cable Holder  
(Refer to P.24)



Power Cord

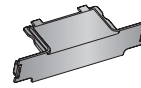

Protection Cover  
(Refer to P.19)

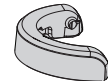

Cable  
Management Clip  
(Refer to P.24)



Wireless LAN for  
Broadband/DLNA Adaptor

(For 50/60PX950)



Cleansing Cloths  
(mitt)

(For 50/60PX950)



3D Glasses

OPTIONAL EXTRAS

Optional extras can be changed or modified for quality improvement without any notification.

Contact your dealer for buying these items.

These devices only work with compatible LG LED LCD TV and Plasma TV.

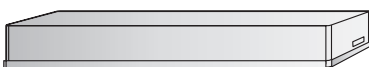

Wireless Media Box  
(AN-WL100W)



Wireless LAN for Broadband/  
DLNA Adaptor  
(AN-WF100)

# PREPARATION

## FRONT PANEL INFORMATION

PREPARATION

■ Image shown may differ from your TV.

50/60PK950, 50/60PX950

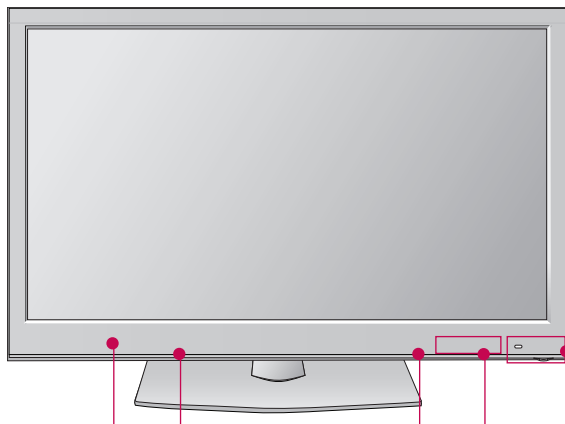

SPEAKER

### Emitter (For 50/60PX950)

It is the part equipped with the emitter exchanging signal with 3D glasses.

Please be careful not to block the screen with objects or people while watching a 3D Video.

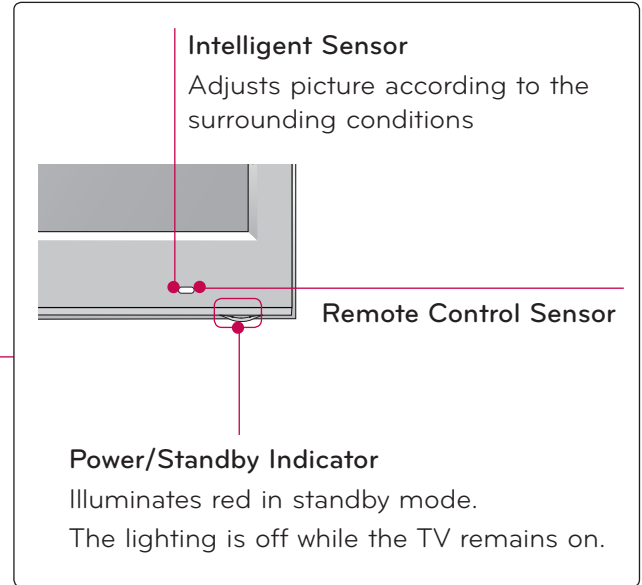

### Intelligent Sensor

Adjusts picture according to the surrounding conditions

Remote Control Sensor

### Power/Standby Indicator

Illuminates red in standby mode.  
The lighting is off while the TV remains on.

### Touch Button

You can operate the button just by touching the button lightly with your finger.

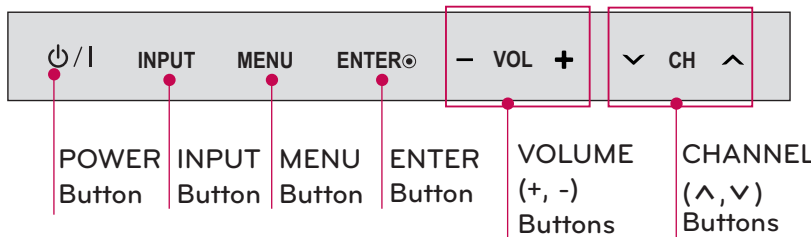

POWER  
Button

INPUT  
Button

MENU  
Button

ENTER  
Button

VOLUME  
(+, -)  
Buttons

CHANNEL  
(^, v)  
Buttons

47/55LX9500

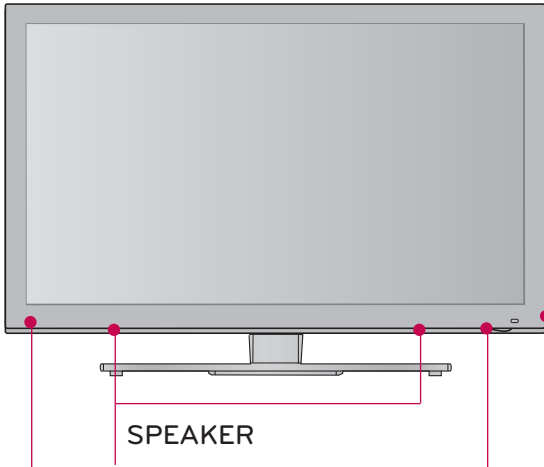

**Emitter**

It is the part equipped with the emitter exchanging signal with 3D glasses.

Please be careful not to block the screen with objects or people while watching a 3D Video.

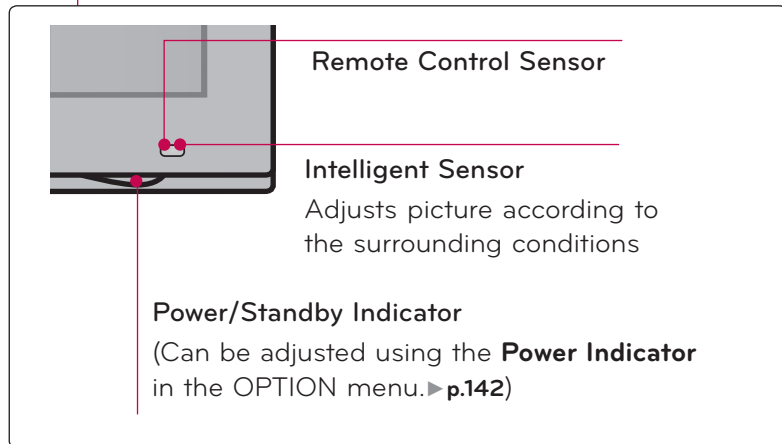
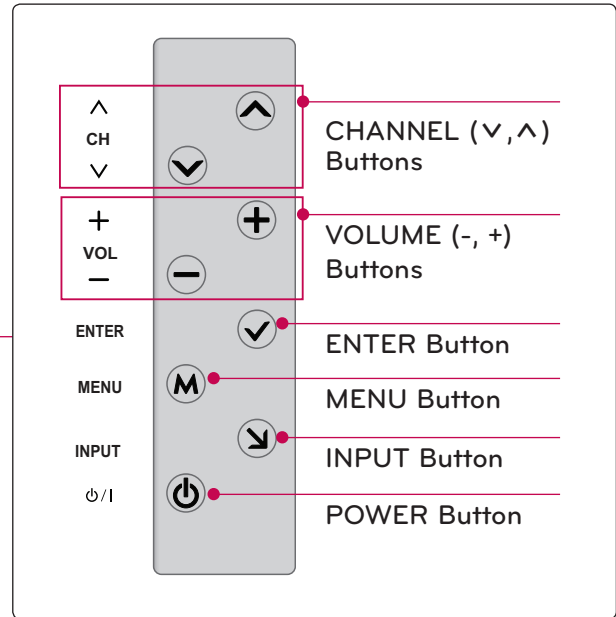

# PREPARATION

■ Image shown may differ from your TV.

47/55LEX8, 60/72LEX9

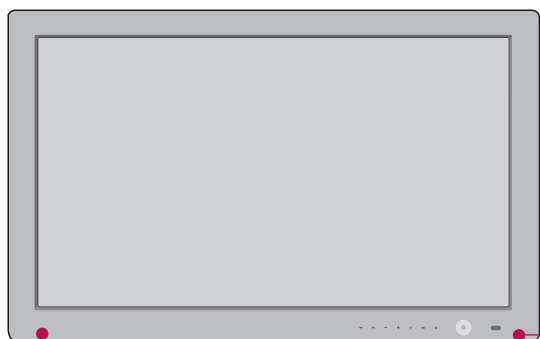

A diagram of the top-left corner of the TV. Three red lines point to specific features: one to a lens labeled 'Remote Control Sensor', one to a small red dot labeled 'Intelligent Sensor', and one to a small red dot labeled 'Power/Standby Indicator'.

**Remote Control Sensor**

**Intelligent Sensor**  
Adjusts picture according to the surrounding conditions

**Power/Standby Indicator**  
(Can be adjusted using the **Power Indicator** in the **OPTION** menu. ▶p.142)

**Touch Button**  
You can operate the button just by touching the button lightly with your finger.

CH ∨ ∨	VOL - +	ENTER ∨	MENU M	INPUT ↘	∅/I ∅
CHANNEL (∨, ∨) Buttons	VOLUME (-, +) Buttons	ENTER Button	MENU Button	INPUT Button	POWER Button

# BACK PANEL INFORMATION

■ Image shown may differ from your TV.

50/60PK950, 50/60PX950

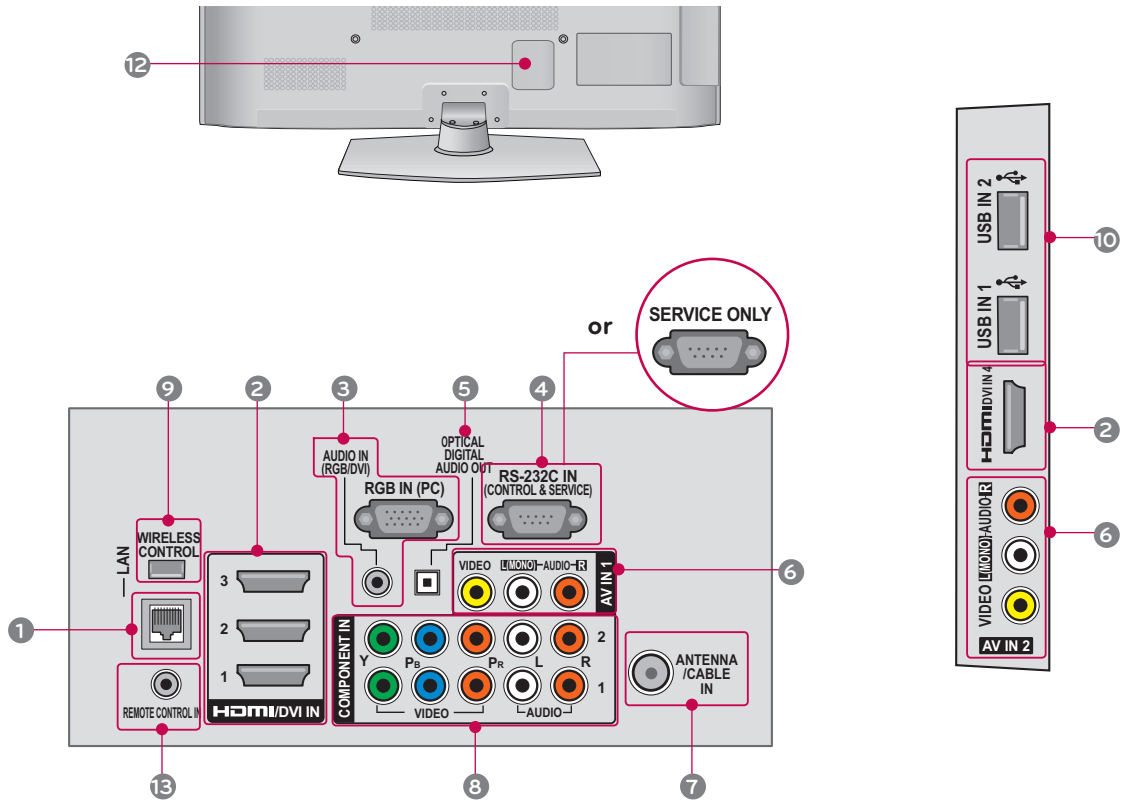

# PREPARATION

PREPARATION

47/55LX9500, 47/55LEX8, 60/72LEX9

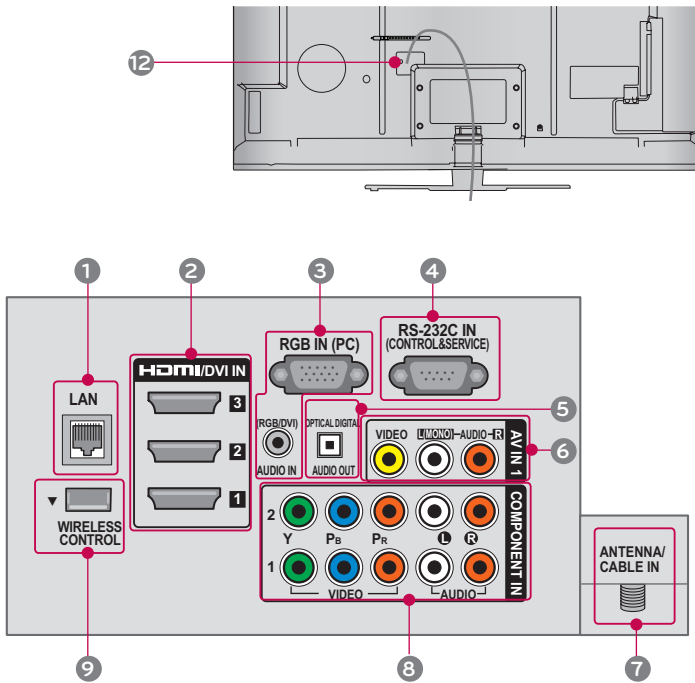

**⚠ CAUTION**

**For HDMI IN 4 and USB IN 1, 2**

- ▶ For an optimal connection, HDMI cables and USB devices should have bezels less than 10 mm (0.39 inches) thick.

\*A ≤ 10 mm (0.39 inches)



**1 LAN**

Network connection for Netflix, Yahoo! TV Widgets, etc (for USA).

Also used for video, photo and music files on a local network.

**2 HDMI/DVI IN, HDMI IN**

Digital Connection.

Supports HD video and Digital audio. Doesn't support 480i.

Accepts DVI video using an adapter or HDMI to DVI cable (not included).

**3 RGB IN (PC)**

Analog PC Connection. Uses a D-sub 15 pin cable (VGA cable).

**AUDIO IN (RGB/DVI)**

0.32 cm (1/8 inch) headphone jack for analog PC audio input.

**4 RS-232C IN (CONTROL & SERVICE) or SERVICE ONLY**

Used by third party devices.

This port is used for service or Hotel mode.

**5 OPTICAL DIGITAL AUDIO OUT**

Digital optical audio output for use with amps and home theater systems.

Note: In standby mode, this port doesn't work.

**6 AV (Audio/Video) IN**

Analog composite connection.

Supports standard definition video only (480i).

**7 ANTENNA/CABLE IN**

Connect over-the-air or cable signals to this jack.

**8 COMPONENT IN**

Analog Connection.

Supports HD.

Uses a red, green, and blue cable for video & red and white for audio.

**9 WIRELESS CONTROL**

Connect the Wireless Ready Dongle to the TV to control the external input devices connected to Media Box wirelessly.

**10 USB INPUT**

Used for viewing photos, watching movies and listening to MP3s.

**11 HEADPHONE**

0.32 cm (1/8 inch) headphone jack

Impedance 16  $\Omega$  , Maximum audio out 15 mW

**12 Power Cord or Socket**

For operation with AC power.

Caution: Never attempt to operate the TV on DC power.

**13 REMOTE CONTROL IN**

For a wired remote control.

# PREPARATION

PREPARATION

## STAND INSTRUCTIONS (For 50/60PK950, 50/60PX950)

■ Image shown may differ from your TV.

### INSTALLATION

**1** Carefully place the TV screen side down on a cushioned surface to protect the screen from damage.

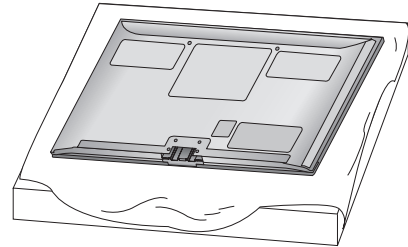

**2** Assemble the parts of the **STAND BODY** with the **STAND BASE** of the TV.

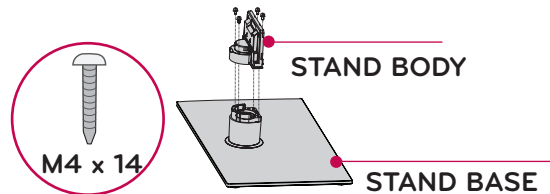

**50PK950, 50PX950**  
(provided as parts of the product)

**3** Assemble the parts of the **CABLE MANAGEMENT CLIP** with the **STAND BODY**.

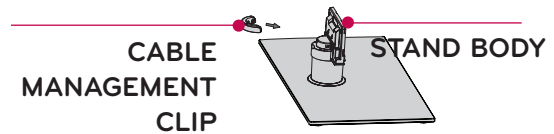

**4** Assemble the TV as shown.

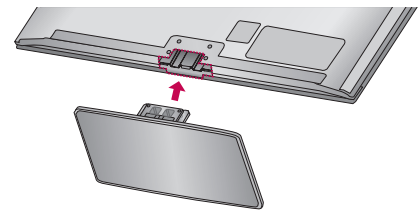

**5** Install the 4 screws into the holes shown.

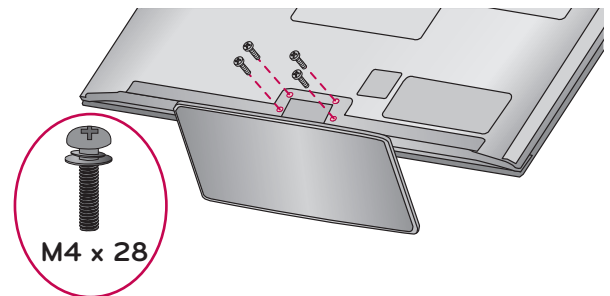

#### NOTE

▶ When assembling the desk type stand, make sure the screws are fully tightened (If not tightened fully, the TV can tilt forward after the product installation). Do not over tighten.

## DETACHMENT

- 1 Carefully place the TV screen side down on a cushioned surface to protect the screen from damage.

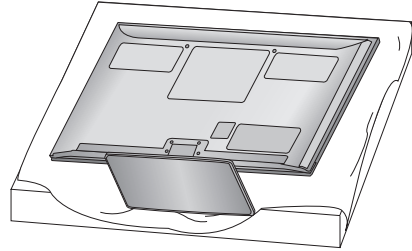

- 2 Remove the screws that hold the stand on.

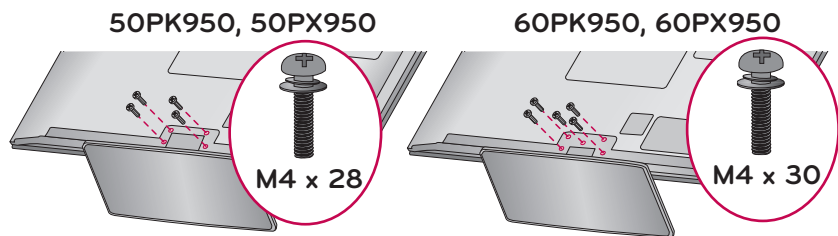

- 3 Detach the stand from TV.

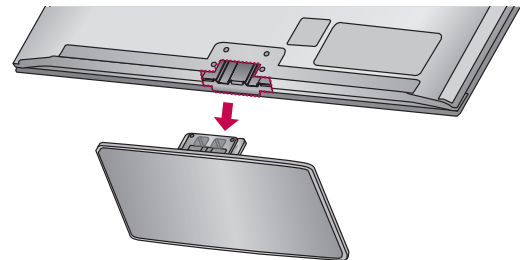

## PROTECTION COVER

After removing the stand, install the included **PROTECTION COVER** over the hole for the stand.

Press the **PROTECTION COVER** into the TV until you hear it click.

When installing the wall mounting bracket, use the **PROTECTION COVER**.

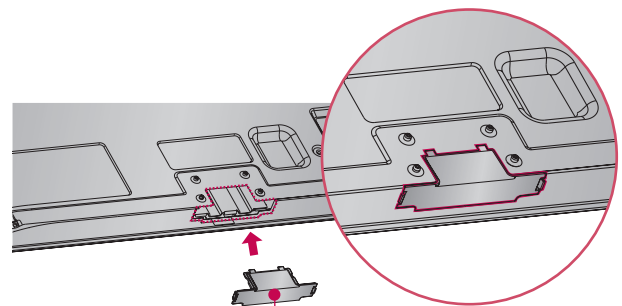

**PROTECTION COVER**

Fix a guide to the outside.

# PREPARATION

## STAND INSTRUCTIONS (For 47/55LX9500, 47/55LEX8)

- Image shown may differ from your TV.

### INSTALLATION

- 1 Carefully place the TV screen side down on a cushioned surface to protect the screen from damage.

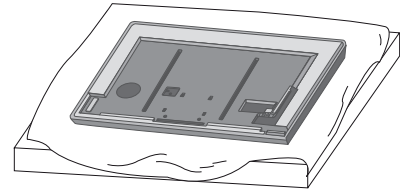

- 2 Assemble the parts of the **STAND BODY** with the **STAND BASE** of the TV.  
At this time, tighten the screws that hold the **STAND BODY** on.

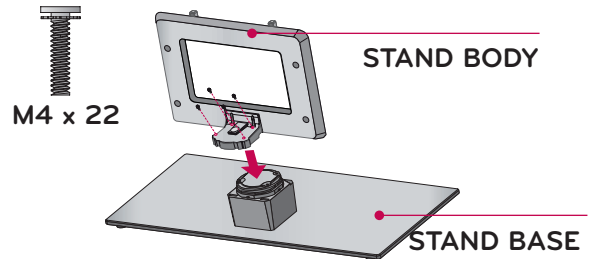

- 3 Install the 4 screws into the holes shown.

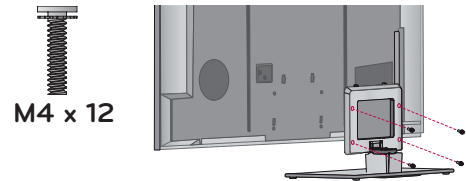

- 4 Assemble the part of the **STAND REAR COVER** with the TV.

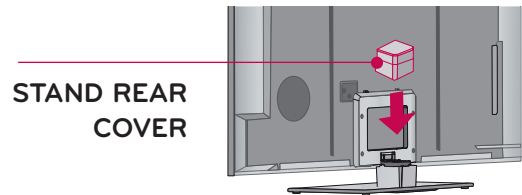

#### NOTE

- ▶ When assembling the desk type stand, make sure the screws are fully tightened (If not tightened fully, the TV can tilt forward after the product installation). Do not over tighten.

## DETACHMENT

- 1 Carefully place the TV screen side down on a cushioned surface to protect the screen from damage.

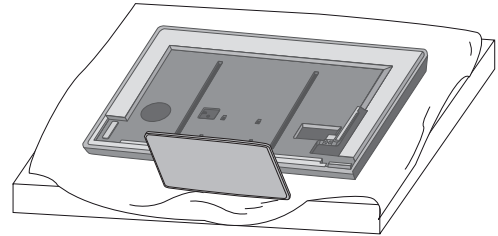

- 2 Detach the **STAND REAR COVER** from TV.

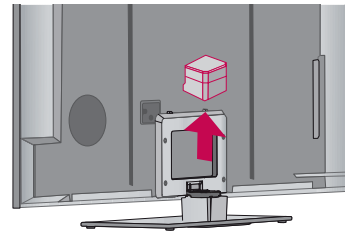

- 3 Remove the screws that hold the stand on.

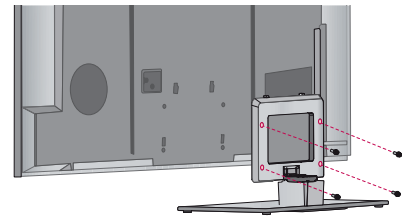

- 4 Detach the stand from TV.

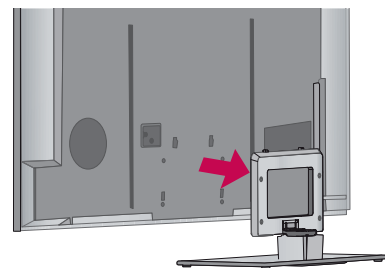

# PREPARATION

## VESA WALL MOUNTING

PREPARATION

Install your wall mount onto wooden studs perpendicular to the floor. When attaching to other building materials, please contact a professional.

If installed on a ceiling or slanted wall, it may fall and result in severe personal injury.

We recommend that you use an LG brand wall mount when mounting the TV to a wall.

LG recommends that wall mounting be performed by a qualified professional installer.

Model	VESA (A * B) 	Standard Screw	Quantity	Wall Mounting Bracket (sold separately)
47LX9500, 47LEX8	200 * 200	M6	4	LSW200B, LSW200BG, LSW200BX, LSW200BXG
55LX9500, 55LEX8	400 * 400	M6	4	LSW400B, LSW400BG, DSW400BG
50PK950, 50PX950	400 * 400	M6	4	PSW400B, PSW400BG
60PK950, 60PX950	600 * 400	M8	4	PSW600B, PSW600BG

**NOTE**

- ▶ Screw length needed depends on the wall mount used. For further information, refer to the instructions included with the mount.
- ▶ Standard dimensions for wall mount kits are shown in the table.
- ▶ When purchasing our wall mount kit, a detailed installation manual and all parts necessary for assembly are provided.
- ▶ Do not use screws longer than the standard dimension, as they may cause damage to the inside to the TV.
- ▶ For wall mounts that do not comply with the VESA standard screw specifications, the length of the screws may differ depending on their specifications.
- ▶ Do not use screws that do not comply with the VESA standard screw specifications.  
Do not use fasten the screws too strongly, this may damage the TV or cause the TV to a fall, leading to personal injury. LG is not liable for these kinds of accidents.
- ▶ LG is not liable for TV damage or personal injury when a non-VESA or non specified wall mount is used or the consumer fails to follow the TV installation instructions.

**CAUTION**

- ▶ Do not install your wall mount kit while your TV is turned on. It may result in personal injury due to electric shock.

# PREPARATION

## CABLE MANAGEMENT

■ Image shown may differ from your TV.

### Plasma TV

#### How to use the CABLE HOLDER

- 1 After connecting the cables as necessary, install the **CABLE HOLDER** as shown and bundle the cables.

In case of the LAN cable, install as shown to reduce the electromagnetic wave.

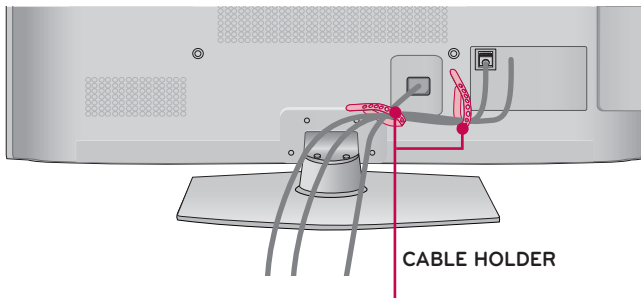

#### How to use the CABLE MANAGEMENT CLIP

- 1 Connect the cables as necessary.  
To connect additional equipment, see the **EXTERNAL EQUIPMENT SETUP** section.

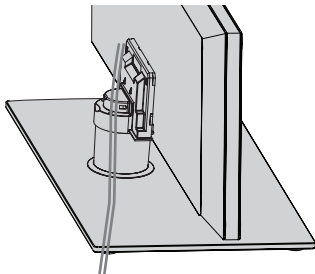

- 2 Install the **CABLE MANAGEMENT CLIP** into the TV until clicking sound.

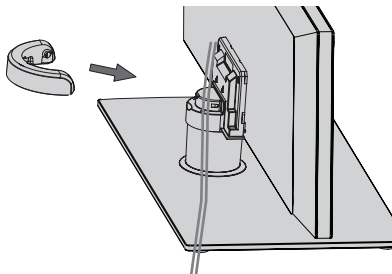

#### HOW TO REMOVE THE CABLE MANAGEMENT CLIP

- ▶ Hold the **CABLE MANAGEMENT CLIP** with both hands and pull it backward as shown.

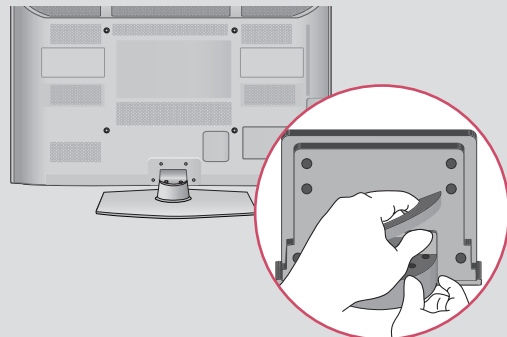



■ Image shown may differ from your TV.

**47/55LX9500, 47/55LEX8, 60/72LEX9**

- 1 Secure the power cord with the **CABLE HOLDER** on the TV back cover. It will help prevent the power cable from being removed by accident.

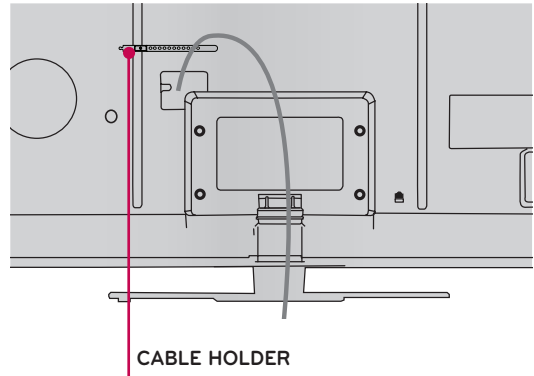

- 2 After connecting the cables as necessary, install the **CABLE HOLDER** as shown and bundle the cables.

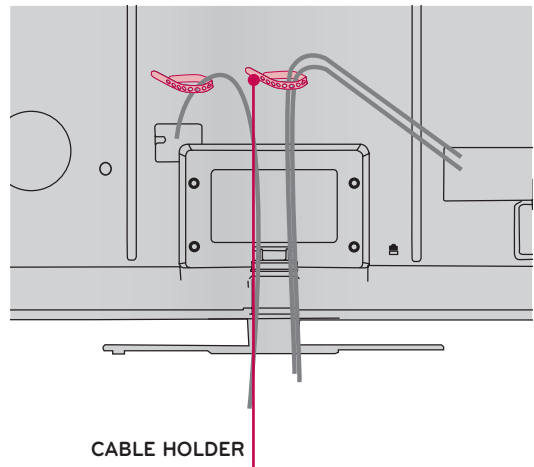

# PREPARATION

## DESKTOP PEDESTAL INSTALLATION

- Image shown may differ from your TV.

For proper ventilation, allow a clearance of 10.1 cm (4 inch) on all four sides from the wall.

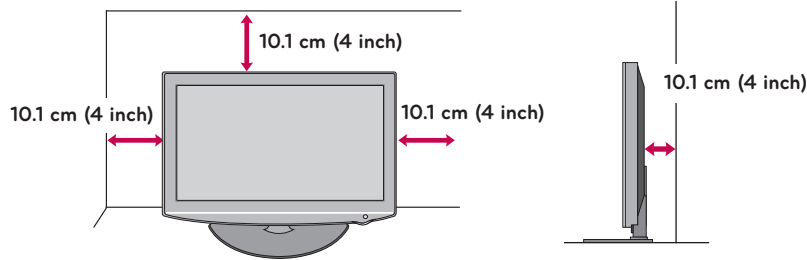

### CAUTION

- Ensure adequate ventilation by following the clearance recommendations.
- Do not mount near or above any type of heat source.

## SWIVEL STAND

After installing the TV, you can adjust the TV set manually to the left or right direction by 20 ° to suit your viewing position.

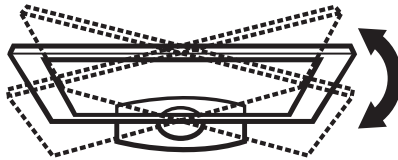

## KENSINGTON SECURITY SYSTEM

- This feature is not available for all models.
- The TV is equipped with a Kensington Security System connector on the back panel. Connect the Kensington Security System cable as shown below.
- For the detailed installation and use of the Kensington Security System, refer to the user's guide provided with the Kensington Security System.  
For further information, contact <http://www.kensington.com>, the internet homepage of the Kensington company. Kensington sells security systems for expensive electronic equipment such as notebook PCs and LCD projectors.

NOTE: The Kensington Security System is an optional accessory.

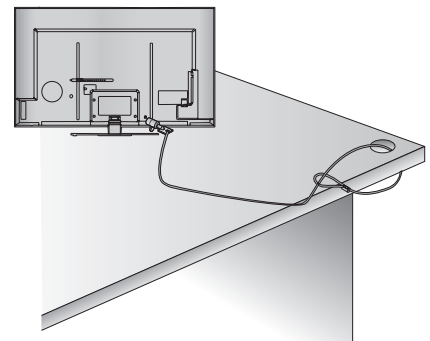

## SECURING THE TV TO THE WALL TO PREVENT FALLING WHEN THE TV IS USED ON A STAND

- You should purchase necessary components to prevent the TV from tipping over (when not using a wall mount).
- Image shown may differ from your TV.

We recommend that you set up the TV close to a wall so it cannot fall over if pushed backwards. Additionally, we recommend that the TV be attached to a wall so it cannot be pulled in a forward direction, potentially causing injury or damaging the product.

Caution: Please make sure that children don't climb on or hang from the TV.

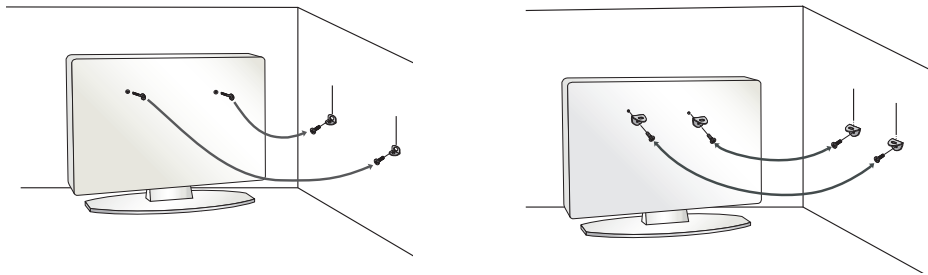

- Insert the eye-bolts (or TV brackets and bolts) to tighten the product to the wall as shown in the picture.
    - \* If your product has the bolts in the eye-bolts position before inserting the eye-bolts, loosen the bolts.
    - \* Insert the eye-bolts or TV brackets/bolts and tighten them securely in the upper holes.
- Secure the wall brackets with the bolts (sold separately) to the wall. Match the height of the bracket that is mounted on the wall to the holes in the product.
- Ensure the eye-bolts or brackets are tightened securely.

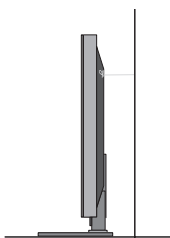

- Use a sturdy rope (sold separately) to tie the product. It is safer to tie the rope so it becomes horizontal between the wall and the product.

### NOTE

- ▶ Use a platform or cabinet strong enough and large enough to support the size and weight of the TV.
- ▶ To use the TV safely make sure that the height of the bracket on the wall and the one on the TV are the same.

# PREPARATION

- To prevent damage do not connect to the power outlet until all connections are made between the devices.
- Image shown may differ from your TV.

## ANTENNA OR CABLE CONNECTION

### 1. Antenna (Analog or Digital)

Wall Antenna Socket or Outdoor Antenna without a Cable Box Connections.  
For optimum picture quality, adjust antenna direction if needed.

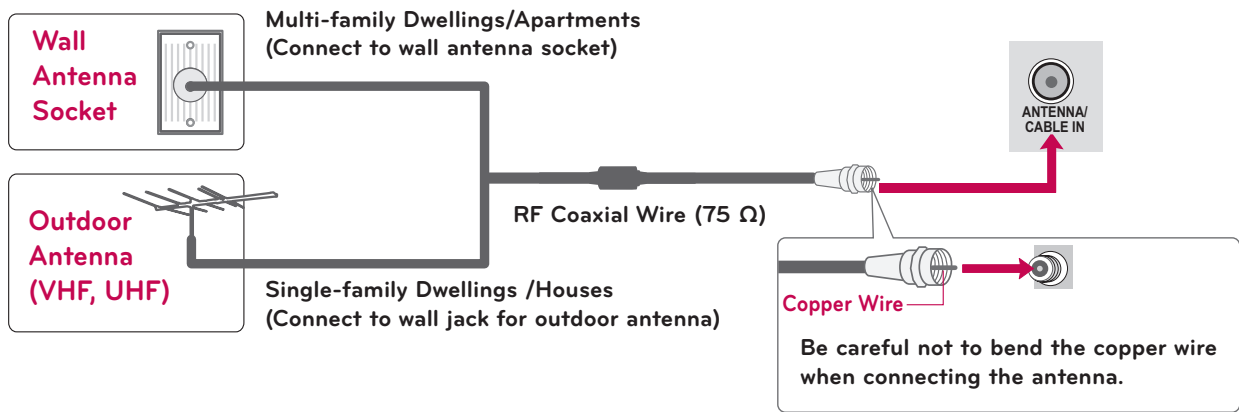

### 2. Cable

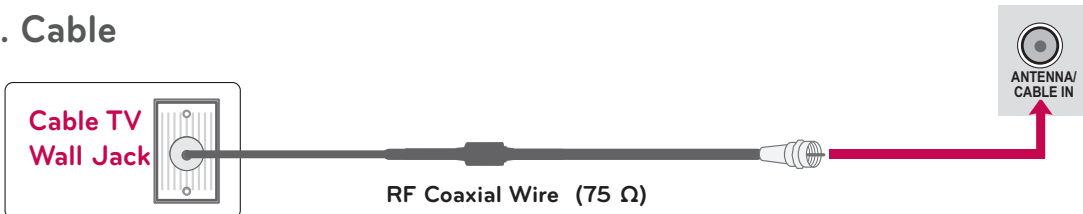

- If the antenna needs to be split for two TV's, install a 2-Way Signal Splitter.
- For much more information about antennas visit our Knowledgebase at <http://lgknowledgebase.com>. Search for antenna.

# EXTERNAL EQUIPMENT SETUP

- To prevent the equipment damage, never plug in any power cords until you have finished connecting all equipment.
- Image shown may differ from your TV.

## HD RECEIVER SETUP

This TV can receive digital over-the-air/digital cable signals without an external digital set-top box. However, if you do receive digital signals from a digital set-top box or other digital external device.

### Component Connection

#### 1. How to connect

- 1 Connect the video outputs (Y, PB, PR) of the digital set-top box to the **COMPONENT IN VIDEO 1, 2, or 3\*** jacks on the TV. Match the jack colors (Y = green, PB = blue, and PR = red).
- 2 Connect the audio output of the digital set-top box to the **COMPONENT IN AUDIO 1, 2, or 3\*** jacks on the TV.

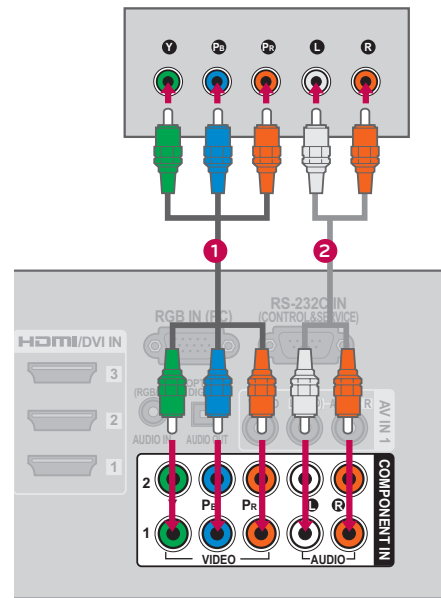

#### 2. How to use

- Turn on the digital set-top box.  
(Refer to the owner's manual for the digital set-top box operation.)
- Select the **Component1**, **Component2**, or **Component3** input source on the TV using the **INPUT** button on the remote control.

\* Component3: For LED LCD TV

Y, CB/PB, CR/PR

Resolution	Horizontal Frequency(KHz)	Vertical Frequency(Hz)
720x480i	15.73	59.94
	15.73	60.00
720x480p	31.47	59.94
	31.50	60.00
1280x720p	44.96	59.94
	45.00	60.00
1920x1080i	33.72	59.94
	33.75	60.00
1920x1080p	26.97	23.976
	27.00	24.00
	33.71	29.97
	33.75	30.00
	67.432	59.94
	67.50	60.00

# EXTERNAL EQUIPMENT SETUP

For LED LCD TV

EXTERNAL EQUIPMENT SETUP

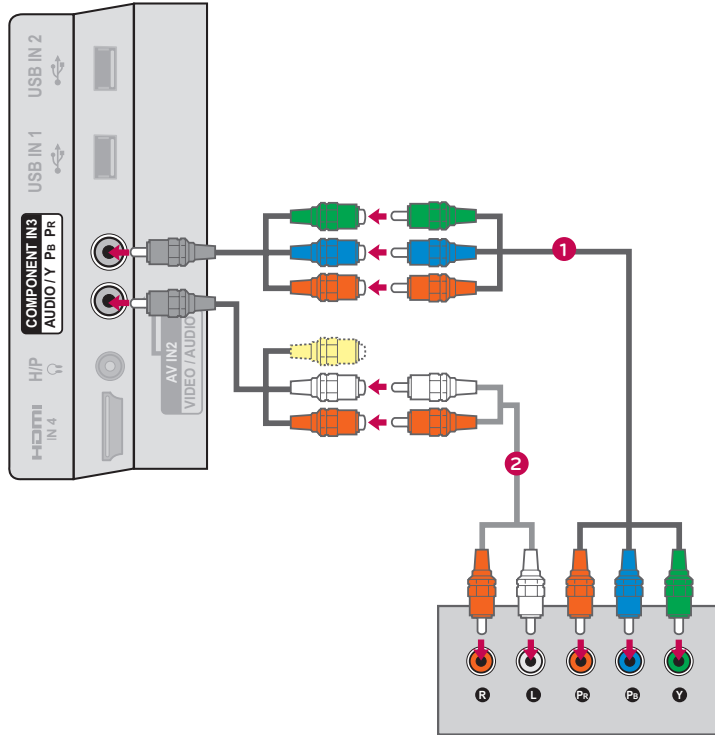

## HDMI Connection

### 1. How to connect

- 1 Connect the digital set-top box to **HDMI/DVI IN 1, 2, 3, or 4** jack on the TV.
- 2 No separate audio connection is necessary. HDMI supports both audio and video.

### 2. How to use

- Turn on the digital set-top box.  
(Refer to the owner's manual for the digital set-top box.)
- Select the **HDMI1, HDMI2, HDMI3, or HDMI4** input source on the TV using the **INPUT** button on the remote control.

#### NOTE

- ▶ If an HDMI cable doesn't support High Speed HDMI, it can cause flickers or no screen display. In this case use the latest cables that support High Speed HDMI.
- ▶ HDMI Audio Supported Format: Dolby Digital (32 KHz, 44.1 KHz, 48 KHz), Linear PCM (32 KHz, 44.1 KHz, 48 KHz)

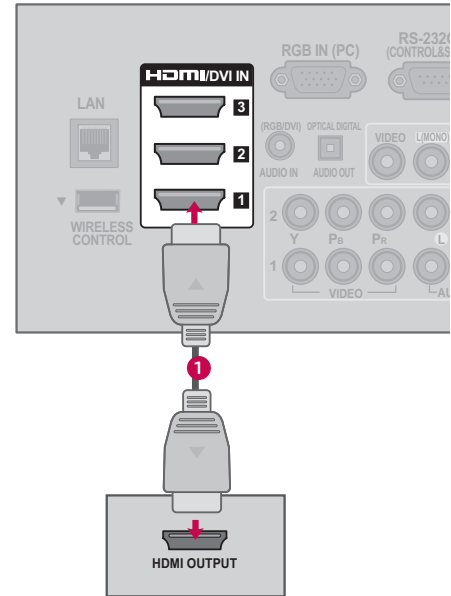

### HDMI-DTV

Resolution	Horizontal Frequency(KHz)	Vertical Frequency(Hz)
720x480p	31.47	59.94
	31.50	60.00
1280x720p	44.96	59.94
	45.00	60.00
1920x1080i	33.72	59.94
	33.75	60.00
1920x1080p	26.97	23.976
	27.00	24.00
	33.71	29.97
	33.75	30.00
	67.432	59.94
	67.50	60.00

# EXTERNAL EQUIPMENT SETUP

## DVI to HDMI Connection

### 1. How to connect

- 1 Connect the DVI output of the digital set-top box to the **HDMI/DVI IN 1, 2, 3, or 4\*** jack on the TV.
- 2 Connect the digital set-top box audio output to the **AUDIO IN (RGB/DVI)** jack on the TV.

### 2. How to use

- Turn on the digital set-top box.  
(Refer to the owner's manual for the digital set-top box.)
- Select the **HDMI1, HDMI2, HDMI3, or HDMI4\*** input source on the TV using the **INPUT** button on the remote control.

\* *HDMI4: For Plasma TV*

#### NOTE

- ▶ A DVI to HDMI cable or adapter is required for this connection. DVI doesn't support audio, so a separate audio connection is necessary.

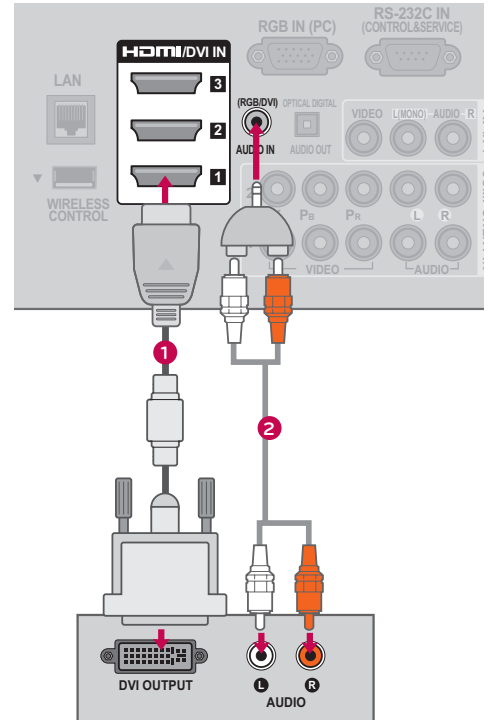



# DVD SETUP

## Component Connection

### 1. How to connect

- 1
 Connect the video outputs (Y, PB, PR) of the DVD to the **COMPONENT IN VIDEO 1, 2, or 3\*** jacks on the TV. Match the jack colors (Y = green, PB = blue, and PR = red).
- 2
 Connect the audio outputs of the DVD to the **COMPONENT IN AUDIO 1, 2, or 3\*** jacks on the TV.

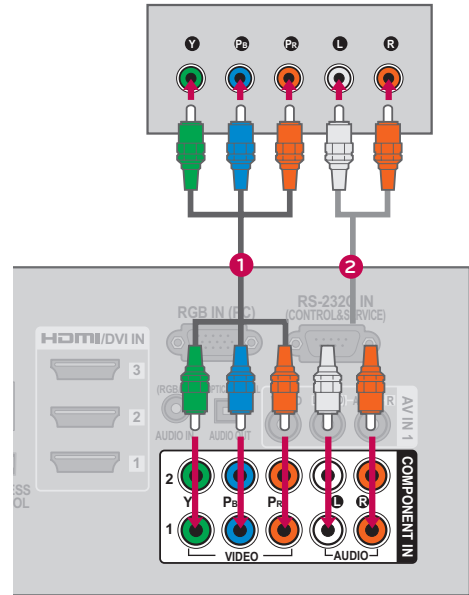

### 2. How to use

- Turn on the DVD player, insert a DVD.
- Select the **Component1**, **Component2**, or **Component3** input source on the TV using the **INPUT** button on the remote control.
- Refer to the DVD player's manual for operating instructions.

\* Component3: For LED LCD TV

For LED LCD TV

### Component Input ports

To get better picture quality, connect a DVD player to the component input ports as shown below.

Component ports on the TV	Y	P <sub>B</sub>	P <sub>R</sub>
Video output ports on DVD player	Y	P <sub>B</sub>	P <sub>R</sub>
	Y	B-Y	R-Y
	Y	C <sub>b</sub>	C <sub>r</sub>
	Y	P <sub>b</sub>	P <sub>r</sub>

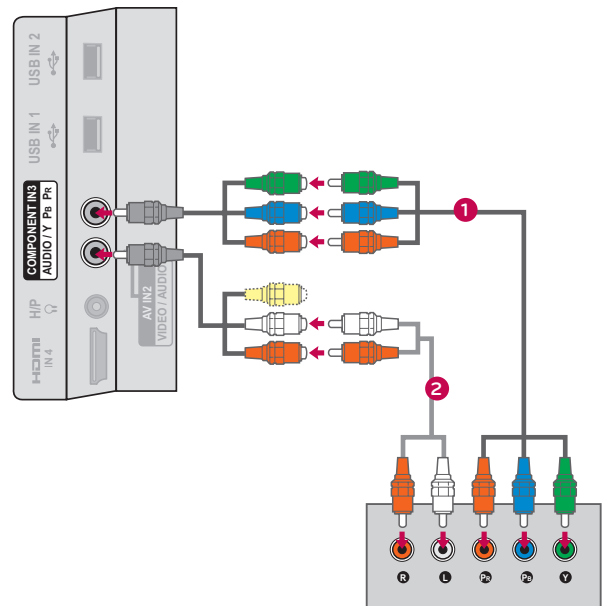

# EXTERNAL EQUIPMENT SETUP

## Composite (RCA) Connection

### 1. How to connect

- 1 Connect the **AUDIO/VIDEO** jacks between TV and DVD. Match the jack colors (Video = yellow, Audio Left = white, and Audio Right = red)

### 2. How to use

- Turn on the DVD player, insert a DVD.
- Select the **AV1** or **AV2** input source on the TV using the **INPUT** button on the remote control.
- Refer to the DVD player's manual for operating instructions.

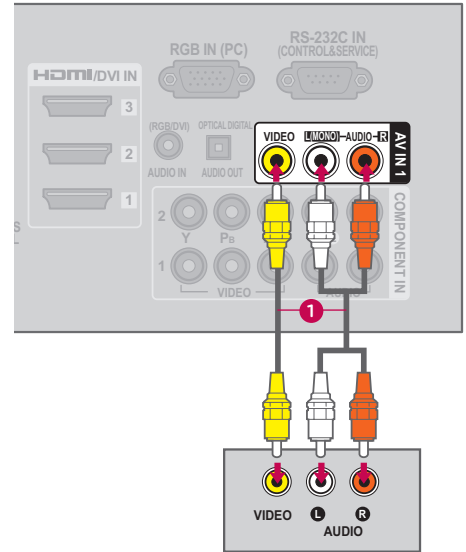

### For LED LCD TV

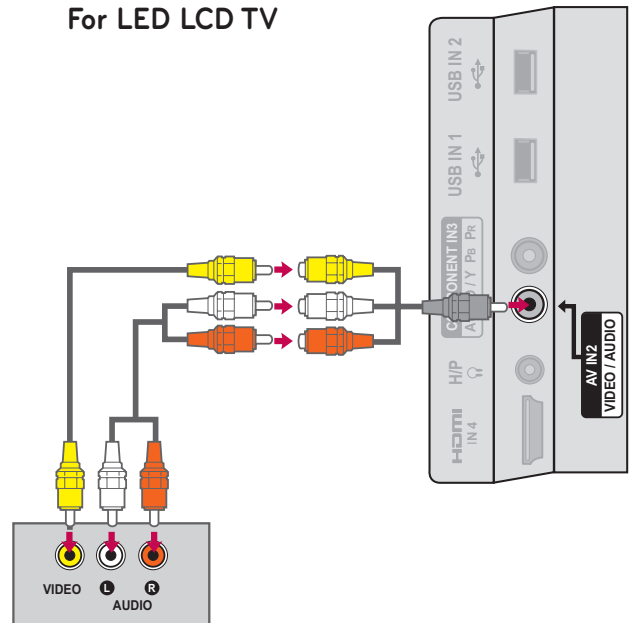

## HDMI Connection

### 1. How to connect

- 1 Connect the HDMI output of the DVD to the **HDMI/DVI IN 1, 2, 3** or **4** jack on the TV.
- 2 No separate audio connection is necessary. HDMI supports both audio and video.

### 2. How to use

- Select the **HDMI1**, **HDMI2**, **HDMI3**, or **HDMI4** input source on the TV using the **INPUT** button on the remote control.
- Refer to the DVD player's manual for operating instructions.

#### NOTE

- ▶ If an HDMI cable doesn't support High Speed HDMI, it can cause flickers or no screen display. In this case use the latest cables that support High Speed HDMI.
- ▶ HDMI Audio Supported Format: Dolby Digital (32 KHz, 44.1 KHz, 48 KHz), Linear PCM (32 KHz, 44.1 KHz, 48 KHz)

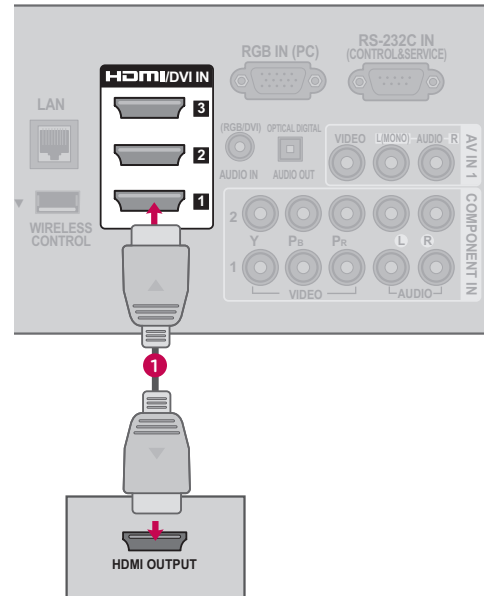

# EXTERNAL EQUIPMENT SETUP

## VCR SETUP

### Antenna Connection

#### 1. How to connect

- 1 Connect the RF antenna out socket of the VCR to the **ANTENNA/CABLE IN** socket on the TV.
- 2 Connect the antenna cable to the RF antenna in socket of the VCR.

#### 2. How to use

- Set VCR output switch to 3 or 4 and then tune TV to the same channel number.
- Insert a video tape into the VCR and press PLAY on the VCR (Refer to the VCR owner's manual).

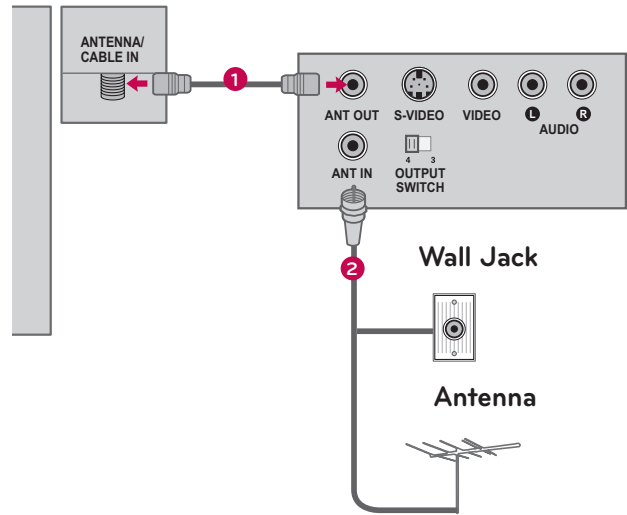

## Composite (RCA) Connection

### 1. How to connect

- 1 Connect the **AUDIO/VIDEO** jacks between TV and VCR. Match the jack colors (Video = yellow, Audio Left = white, and Audio Right = red)

### 2. How to use

- Insert a video tape into the VCR and press PLAY on the VCR. (Refer to the VCR owner's manual.)
- Select the **AV1** or **AV2** input source on the TV using the **INPUT** button on the remote control.

#### NOTE

- ▶ If you have a mono VCR, connect the audio cable from the VCR to the **AUDIO L/MONO** jack of the TV.

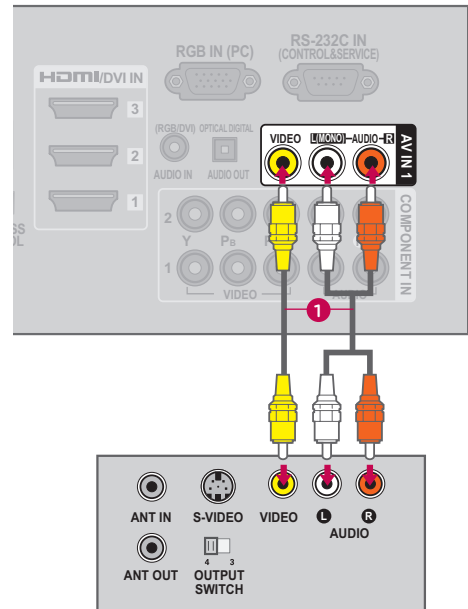

### For LED LCD TV

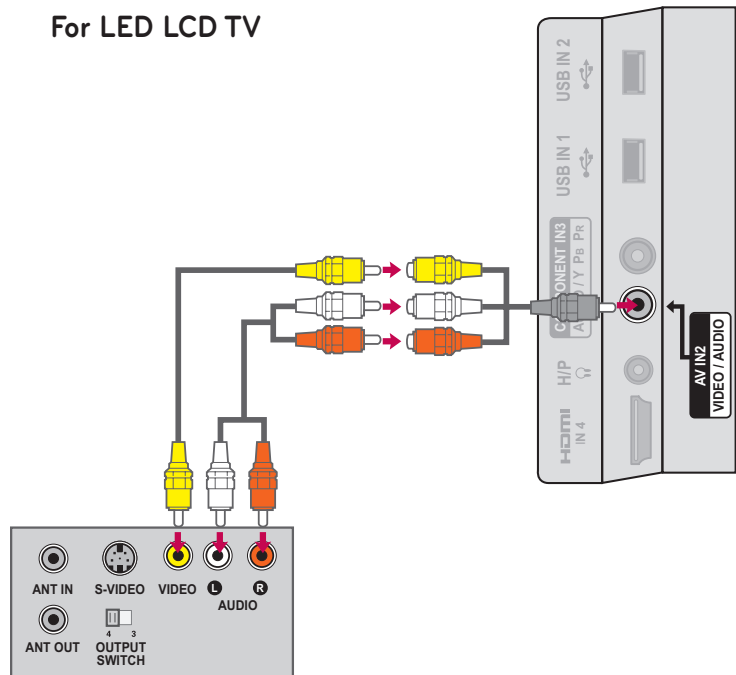

# EXTERNAL EQUIPMENT SETUP

## OTHER A/V SOURCE SETUP

### 1. How to connect

- 1 Connect the **AUDIO/VIDEO** jacks between TV and external equipment. Match the jack colors. (Video = yellow, Audio Left = white, and Audio Right = red)

### 2. How to use

- Select the **AV1** or **AV2** input source on the TV using the **INPUT** button on the remote control.
- Operate the corresponding external equipment.

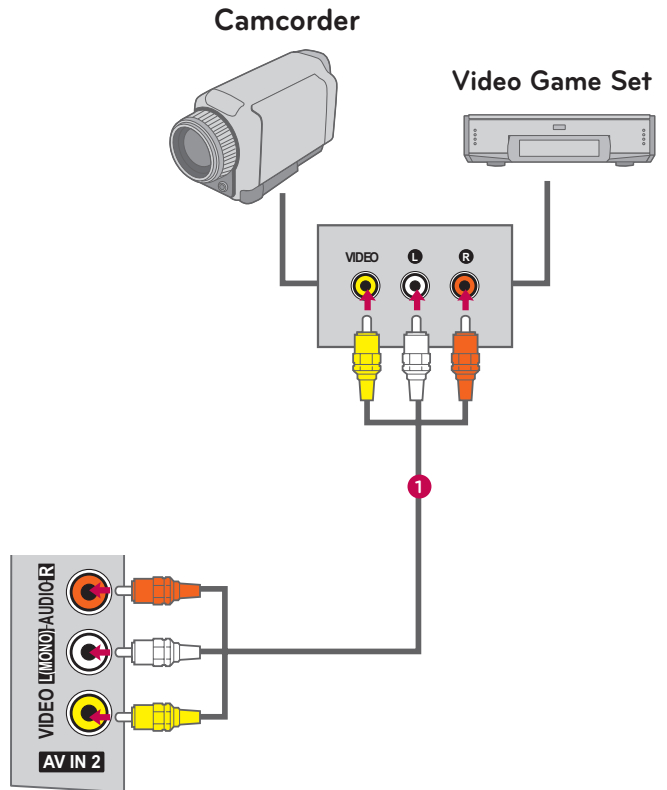

## USB CONNECTION

### 1. How to connect

- 1 Connect the USB device to the **USB IN 1** or **2** jack on the side of TV.

### 2. How to use

- After connecting the **USB IN** jack, you use the USB function. (▶ p.97)

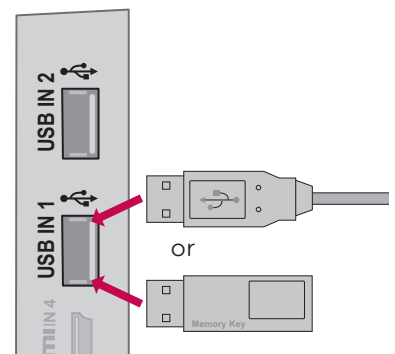

# HEADPHONE SETUP (FOR LED LCD TV)

You can listen to the sound through headphones.

## 1. How to connect

- 1 Plug headphones into the headphone socket.
- 2 To adjust the headphone volume, press the **VOL +/-** button. If you press the **MUTE** button, the sound from the headphone is switched off.

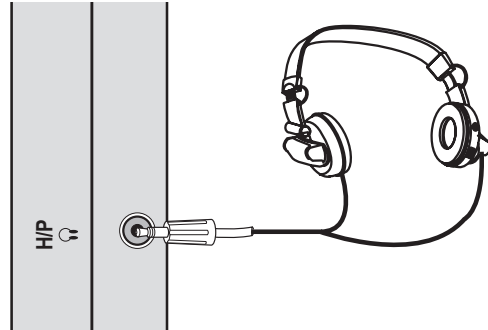

### NOTE

- ▶ AUDIO menu options are disabled when connecting headphones.
- ▶ When changing AV MODE with headphones connected, the change is applied to video but not to audio.
- ▶ Optical Digital Audio Out is not available with headphones connected.

# EXTERNAL EQUIPMENT SETUP

## AUDIO OUT CONNECTION

Send the TV's audio to external audio equipment via the Audio Output port.

If you want to enjoy digital broadcasting through 5.1-channel speakers, connect the OPTICAL DIGITAL AUDIO OUT terminal on the back of TV to a Home Theater (or amp).

### 1. How to connect

- 1 Connect one end of the optical cable to the TV port of **OPTICAL DIGITAL AUDIO OUT**.
- 2 Connect the other end of the optical cable to the digital audio input on the audio equipment.
- 3 Set the "TV Speaker option - Off" in the AUDIO menu. (▶ p.150). See the external audio equipment instruction manual for operation.

#### NOTE

- ▶ When connecting with external audio equipment, such as amplifiers or speakers, you can turn the TV speakers off in the menu. (▶ p.150)

#### CAUTION

- ▶ Do not look into the optical output port. Looking at the laser beam may damage your vision.
- ▶ Audio with ACP (Audio Copy Protection) function may block digital audio output.

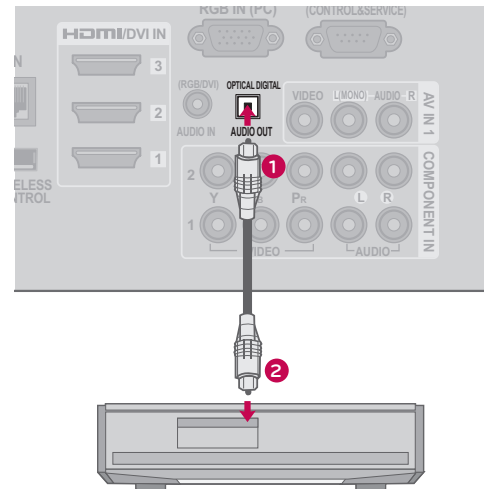



## EXTERNAL EQUIPMENT WIRELESS CONNECTION (OPTIONAL EXTRAS)

LG TVs with a Wireless Control port support the LG Wireless Media Box, which is sold separately. When you connect the wireless ready dongle (included with the media box) to the TV, external devices can be connected to the LG Wireless Media Box and video and audio will be sent to the TV wirelessly.

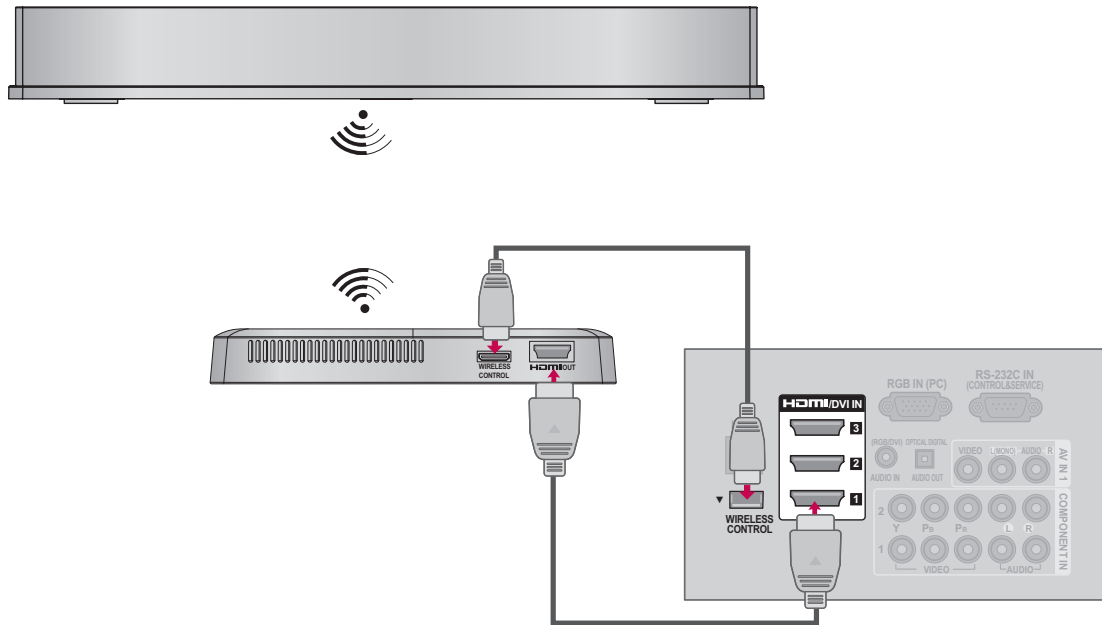

### 1. How to connect

- 1 Connect the **WIRELESS CONTROL** jack of the Wireless Ready Dongle to the **WIRELESS CONTROL** jack on the TV.
- 2 Connect **HDMI OUT** jack of the Wireless Ready Dongle to the **HDMI IN** jack on the TV.

### 2. How to use

- Select the desired input source on the TV using the **INPUT** button on the remote control.
- Refer to the Wireless Media Box manual for operating instructions.

#### NOTE

- ▶ When using the external device connected to the Wireless Media Box, some functions of the TV menu may not work.

# EXTERNAL EQUIPMENT SETUP

## PC SETUP

This TV provides Plug and Play capability, meaning that a PC adjusts automatically to the TV's settings.

### VGA (D-Sub 15 Pin) Connection

#### 1. How to connect

- 1 Connect the VGA output of the PC to the **RGB IN (PC)** jack on the TV.
- 2 Connect PC audio output to the **AUDIO IN (RGB/DVI)** jack on the TV.

#### 2. How to use

- Turn on the PC and the TV.
- Select the **RGB-PC** input source on the TV using the **INPUT** button on the remote control.

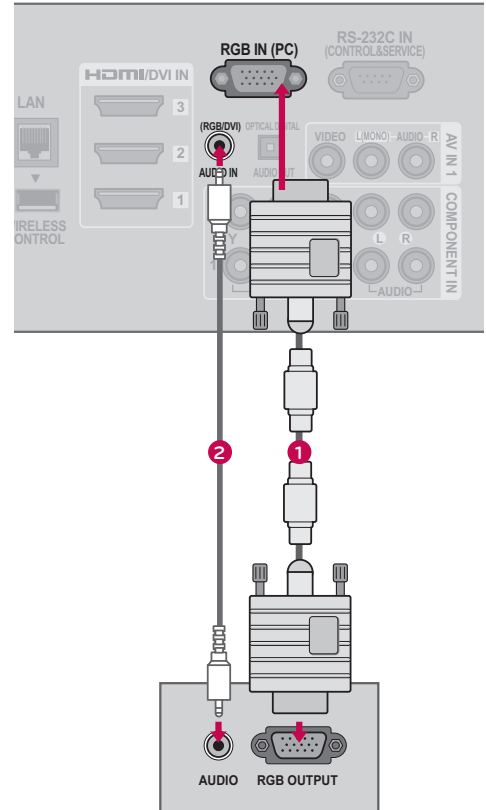

### DVI to HDMI Connection

#### 1. How to connect

- 1 Connect the DVI output of the PC to the **HDMI/DVI IN 1, 2, 3, or 4\*** jack on the TV.
- 2 Connect the PC audio output to the **AUDIO IN (RGB/DVI)** jack on the TV.

#### 2. How to use

- Turn on the PC and the TV.
- Select the **HDMI1, HDMI2, HDMI3, or HDMI4\*** input source on the TV using the **INPUT** button on the remote control.

\* HDMI4: For Plasma TV

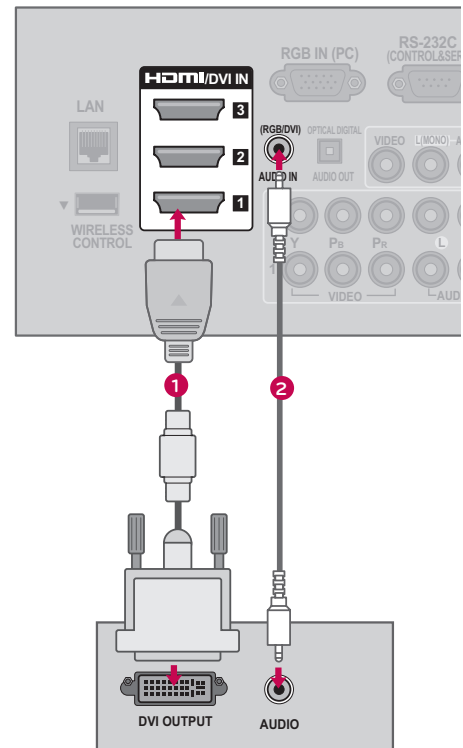

**NOTE**

- ▶ To get the the best picture quality, adjust the PC graphics card to **1920x1080**.
- ▶ Depending on the graphics card, DOS mode may not work if a HDMI to DVI Cable is in use.
- ▶ In PC mode, there may be noise associated with the resolution, vertical pattern, contrast or brightness. If noise is present, change the PC output to another resolution, change the refresh rate to another rate or adjust the brightness and contrast on the PICTURE menu until the picture is clear.
- ▶ Avoid keeping a fixed image on the screen for a long period of time. The fixed image may become permanently imprinted on the screen.
- ▶ The synchronization input form for Horizontal and Vertical frequencies is separate.
- ▶ Depending on the graphics card, some resolution settings may not allow the image to be positioned on the screen properly.
- ▶ If you experience overscan issues when using HDMI-PC 1920x1080, change aspect ratio to **Just scan**.
- ▶ When selecting HDMI-PC, set the "Input Label - PC" in the OPTION menu.

**Supported Display Specifications (RGB-PC, HDMI-PC)**

Resolution	Horizontal Frequency (KHz)	Vertical Frequency (Hz)
640x350	31.468	70.09
720x400	31.469	70.08
640x480	31.469	59.94
800x600	37.879	60.31
1024x768	48.363	60.00
1280x768	47.776	59.87
1360x768	47.712	60.015
1280x1024	63.981	60.02
1920x1080 RGB-PC	66.587	59.934
1920x1080 HDMI-PC	67.50	60.00

# EXTERNAL EQUIPMENT SETUP

## Screen Setup for PC mode







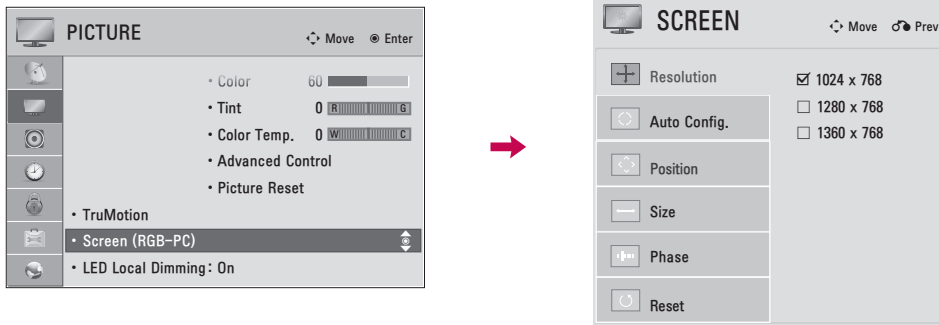

### Selecting Resolution

You can choose the resolution in RGB-PC mode.

The Position, Phase, and Size can also be adjusted.

You can choose this option only when the PC resolution is set to 1024X768, 1280X768 or 1360X768.



- 1   Select **PICTURE**.
- 2   Select **Screen (RGB-PC)**.
- 3   Select **Resolution**.
- 4   Select the desired resolution.
- 5 

## Auto Configure







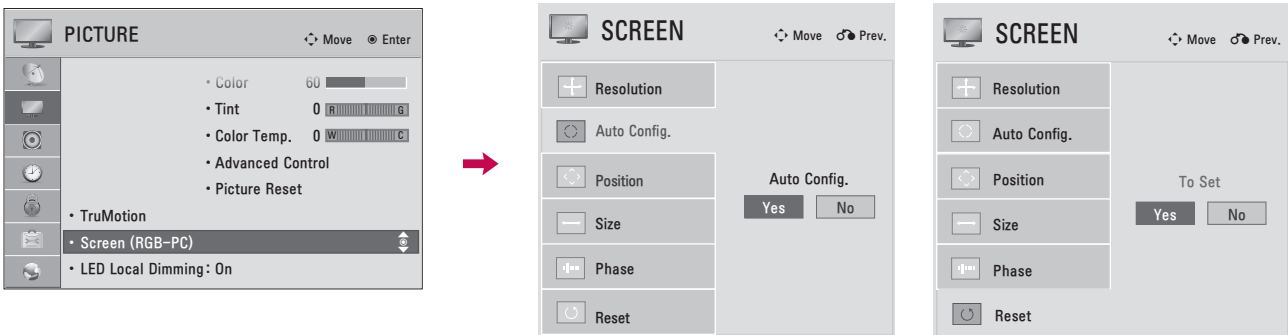

Automatically adjusts picture position and minimizes image instability. After adjustment, if the image is still not correct, try using the manual settings or a different resolution or refresh rate on the PC.

## Screen Reset (Reset to original initial values)

Returns **Position**, **Size**, and **Phase** to the default initial settings.

This feature operates only in RGB-PC mode.



- 1   Select **PICTURE**.
- 2   Select **Screen (RGB-PC)**.
- 3   Select **Auto Config.** or **Reset**.
- 4   Select **Yes**.
- 5 







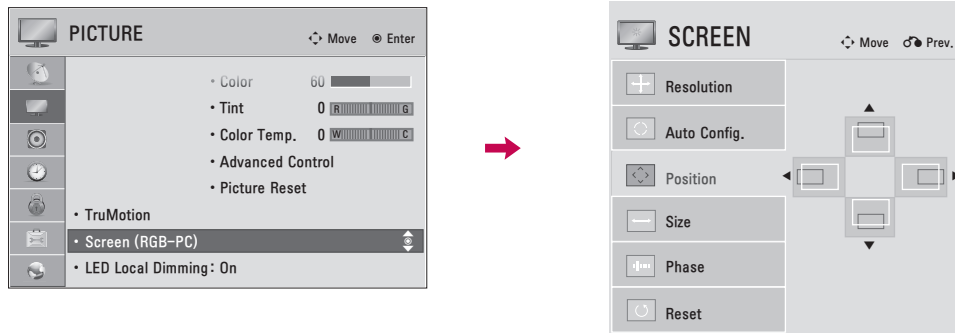

- If the position of the image is still not correct, try Auto adjustment again.
- If picture needs to be adjusted again after Auto adjustment in RGB-PC, you can adjust the **Position**, **Size** or **Phase**.

# EXTERNAL EQUIPMENT SETUP

## Adjustment for screen Position, Size, and Phase

If the picture is not clear after auto adjustment or if text is shaking, adjust the picture phase manually. This feature operates only in RGB-PC mode.



- 1   Select **PICTURE**.
- 2   Select **Screen (RGB-PC)**.
- 3   Select **Position, Size, or Phase**.
- 4   Make appropriate adjustments.
- 5 

- **Position:** This function is to adjust picture to left/right and up/down as you prefer.
- **Size:** This function is to minimize any vertical bars or stripes visible on the screen background. And the horizontal screen size will also change.
- **Phase:** This function allows you to remove any horizontal noise and clear or sharpen the image of characters.

# NETWORK SETUP

## Wired Network Connection

This TV can be connected to a local area network (LAN) via the LAN port. After making the physical connection, the TV needs to be set up for network communication.

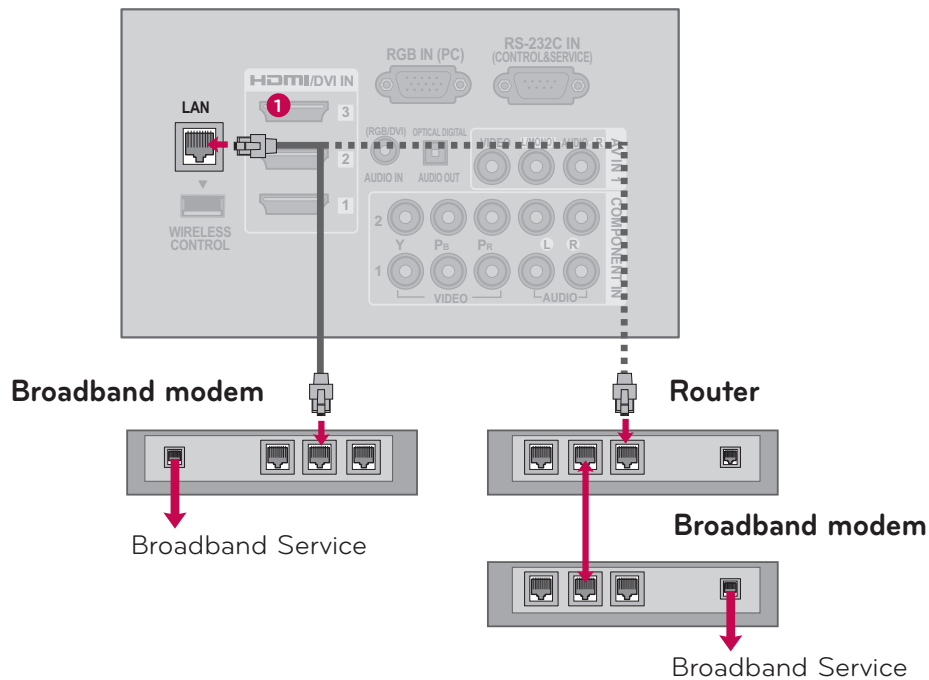

### 1. How to connect

- 1 Connect the LAN port of the Modem or Router to the **LAN** port on the TV.

### 2. How to use

- Select "**Network Setting**" in the NETWORK menu.
- After connecting the **LAN** port, use the NETCAST menu.
- For more information about NETCAST setup and troubleshooting, visit <http://lgknowledgebase.com>. Search for NETCAST.

#### ⚠ CAUTION

- ▶ Do not connect a modular phone cable to the LAN port.
- ▶ Since there are various connection methods, please follow the specifications of your telecommunication carrier or internet service provider.

# EXTERNAL EQUIPMENT SETUP

## Wired Network Setup

If wired and wireless networks are both available, wired is the preferred method.

After making a physical connection, a small number of home networks may require the TV network settings to be adjusted.

For detail information, contact your internet provider or router manual.

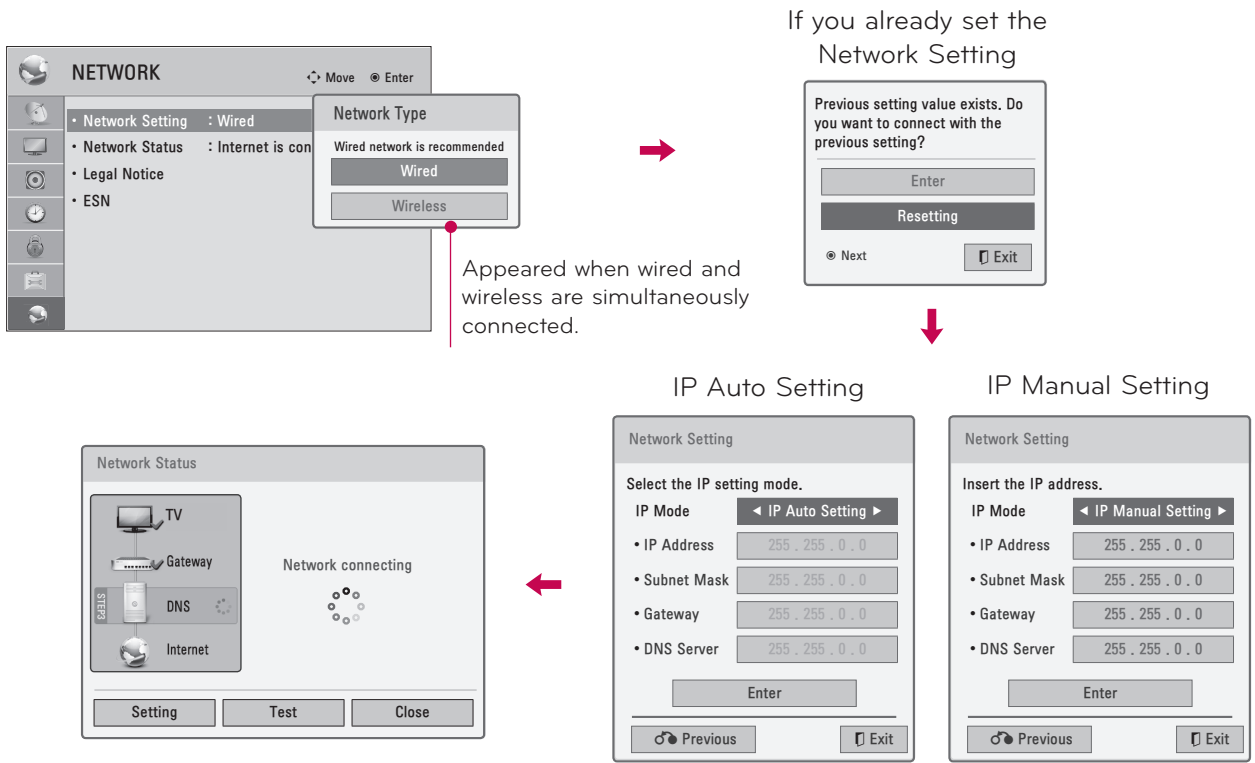

- Select **NETWORK**.
- Select **Network Setting**.
- Select **Wired**.
- If you already set Network Setting: Select **Resetting**. The new connection settings resets the current network settings.
- Select **IP Auto Setting** or **IP Manual Setting**.
- When Selecting **IP Manual Setting**: IP addresses will need to be input manually.
- Select **Enter**.

- This feature requires an always-on broadband internet connection.
- You do not need to connect to a PC to use this function.
- If **Network Setting** is not working, check your network conditions. Check the LAN cable and make sure your router has DHCP turned on if you wish to use the Auto Setting.
- If the **Network Setting** is not completed, network may not operate normally.
- **IP Auto Setting**: Select it if there is a DHCP server on the local area network (LAN) via wired connection, the TV will automatically be allocated an IP address. If you are using a router, it (normally) will have the DHCP server activated by default.
- **IP Manual Setting**: Select it if there is no DHCP server on the network and you want to set the IP address manually.



## NOTE

- ▶ For more information about NETCAST setup and troubleshooting, visit <http://lgknowledgebase.com>. Search for NETCAST.
- ▶ Use a standard LAN cable with this TV. Cat5 or better with a RJ45 connector.
- ▶ Many network connection problems during set up can often be fixed by re-setting the router or modem. After connecting the player to the home network, quickly power off and/or disconnect the power cable of the home network router or cable modem. Then power on and/or connect the power cable again.
- ▶ Depending on the internet service provider (ISP), the number of devices that can receive internet service may be limited by the applicable terms of service. For details, contact your ISP.
- ▶ LG is not responsible for any malfunction of the TV and/or the internet connection feature due to communication errors/malfunctions associated with your broadband internet connection, or other connected equipment.
- ▶ LG is not responsible for problems within your internet connection.
- ▶ Some content available through the network connection may not be compatible with the TV. If you have questions about such content, please contact the producer of the content.
- ▶ You may experience undesired results if the network connection speed does not meet the requirements of the content being accessed.
- ▶ Some internet connection operations may not be possible due to certain restrictions set by the Internet service provider (ISP) supplying your broadband Internet connection.
- ▶ Any fees charged by an ISP including, without limitation, connection charges are your responsibility.
- ▶ A 10 Base-T or 100 Base-TX LAN port is required for connection to this TV. If your internet service does not allow for such a connection, you will not be able to connect the TV.
- ▶ A DSL modem is required to use DSL service and a cable modem is required to use cable modem service. Depending on the access method of and subscriber agreement with your ISP, you may not be able to use the internet connection feature contained in this TV or you may be limited to the number of devices you can connect at the same time. (If your ISP limits subscription to one device, this TV may not be allowed to connect when a PC is already connected.)
- ▶ The use of a "Router" may not be allowed or its usage may be limited depending on the policies and restrictions of your ISP. For details, contact your ISP directly.
- ▶ The wireless network operates at 2.4 GHz radio frequencies that are also used by other household devices such as cordless telephone, Bluetooth® devices, microwave oven, and can be affected by interference from them. It can be interrupted by the device using 5Ghz radio frequencies. It is same device with LG wireless media box, cordless telephone, other Wi-Fi device.
- ▶ It may decrease the service speed using Wireless network by surrounding wireless condition.
- ▶ Turn off all unused network equipment in your local home network. Some devices may generate network traffic.
- ▶ In some instances, placing the access point or wireless router higher up away from the floor may improve the reception.
- ▶ The reception quality over wireless depends on many factors such as type of the access point, distance between the TV and access point, and the location of the TV.
- ▶ When connecting internet through the wired/wireless sharing machine, it may interrupt the connection because of the use limitation and confirmation of service company.
- ▶ To connect wireless AP, an AP that supports the wireless connection is necessary, and the wireless connection function of the AP needs to be activated. Please enquire to the AP supplier for the possibility of AP wireless connections.
- ▶ Please verify the security settings of AP SSID for wireless AP connection, and enquire to the AP supplier for the AP SSID security settings.
- ▶ The TV can become slower or malfunction with wrong settings of network equipments (wired/wireless router, hub, etc). Please install correctly by referring to the manual of the equipment, and set the network.
- ▶ When AP is set to include 802.11 n, and if Encryption is designated as WEP(64/128bit) or WPA(TKIP/AES), the connection may not be possible. There may be different connection methods according to the AP manufacturers.

# EXTERNAL EQUIPMENT SETUP

## Wireless Network Connection

The LG Wireless LAN for Broadband/DLNA Adaptor, which is sold separately, allows the TV to connect to a wireless lan network.

The network configuration and connection method may vary depending on the equipment in use and the network environment. Refer to the setup instructions supplied with your access point or wireless router for detailed connection steps and network settings.

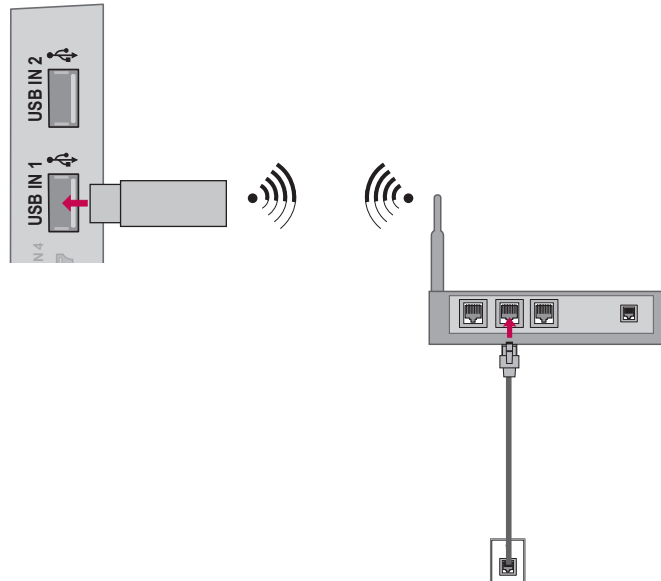

### 1. How to connect

- 1 Connect the "LG Wireless LAN for Broadband/DLNA Adaptor (LED LCD TV: sold separately)" to the **USB IN 1** or **2** port on the TV.

### 2. How to use

- Select "**Network Setting**" in the NETWORK menu.
- After connecting, you can use the NETCAST menu.

#### NOTE

- ▶ We recommend you use a wired network connection when available when viewing movies over the network connection.
- ▶ When the wireless port of the router is used, there may be restrictions for some functions.

## Wireless Network Setup

Setting up the AP (Access Point) or the wireless router is required before connecting the TV to the network.

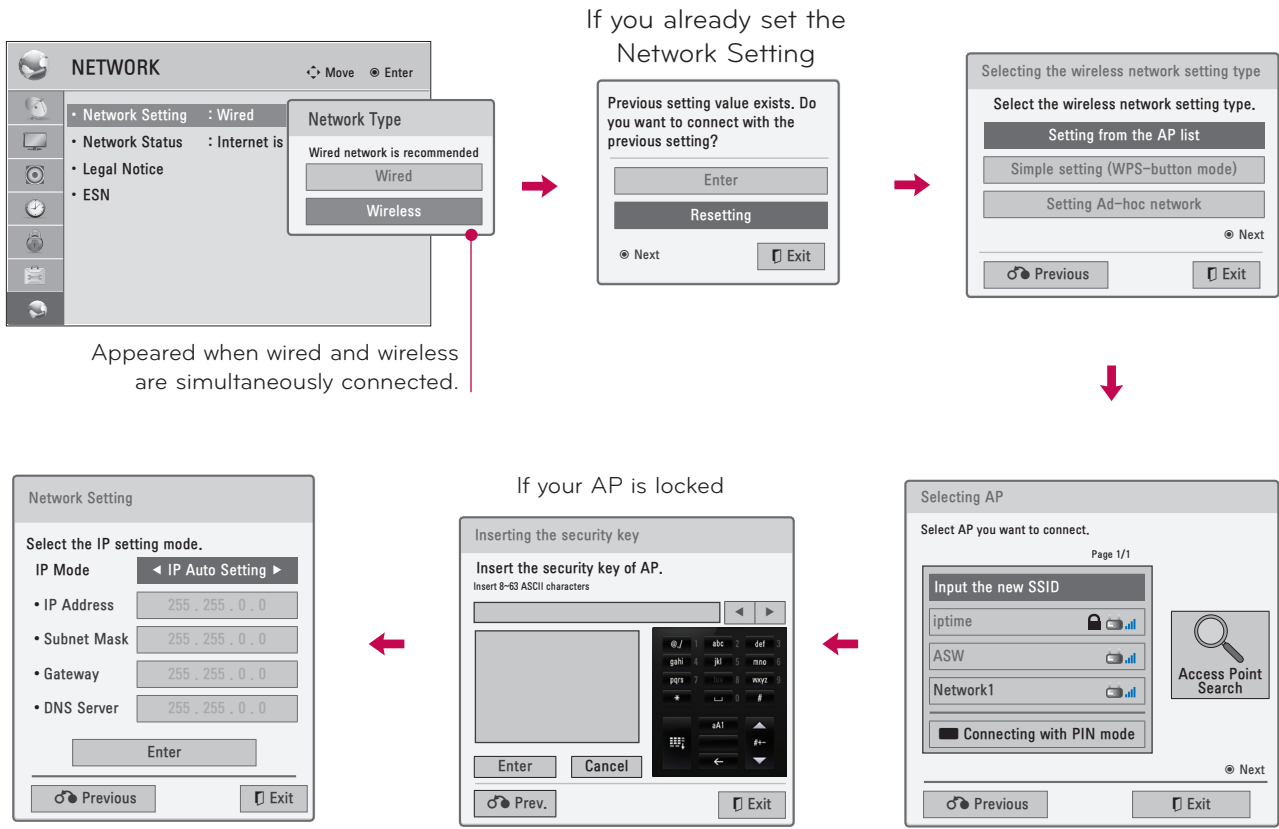

1 Select **NETWORK**.

2 Select **Network Setting**.

3 Select **Wireless**.

4 If you already set Network Setting: Select **Resetting**.  
The new connection settings resets the current network settings.

5 Select **Setting from the AP list**.

6 Scan the all available AP (Access Point) or wireless routers within range and display them as a list.

7 Select an AP (Access Point) or wireless router on the list.  
(If your AP is locked, insert the security key of AP).

8 Input the security key of AP.

9 Repeat step 4-5 on P.48.

# EXTERNAL EQUIPMENT SETUP

## When a security code is already set

### PIN (Personal Identification Number)

If you want to connect the AP (Access Point) or router with PIN, use this feature.

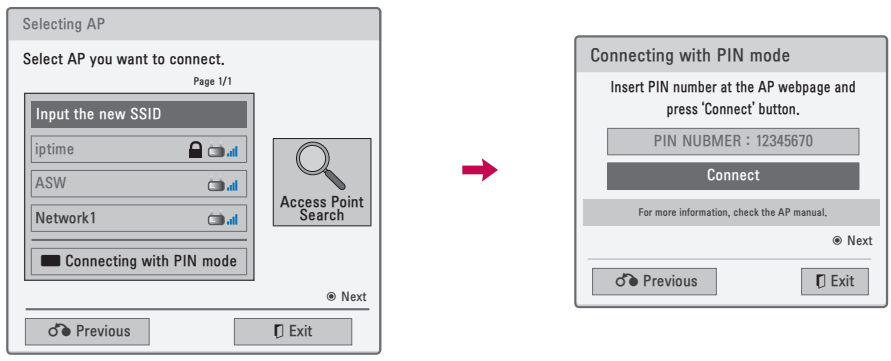

1 Repeat step 1-6 on P.51.

2  Connect the access point with **PIN** mode.

3 You can see the Network ID and Security Key on your TV screen.  
Enter the PIN number to your device.

4  Select **Connect**.

5 Repeat step 4-5 on P.48.

■ PIN number is the unique 8 digit number of the dongle.

## Simple setting (WPS-button mode)

Use the simple setting if your access point or wireless router supports a PIN or WPS (Wi-Fi Protected Setup)

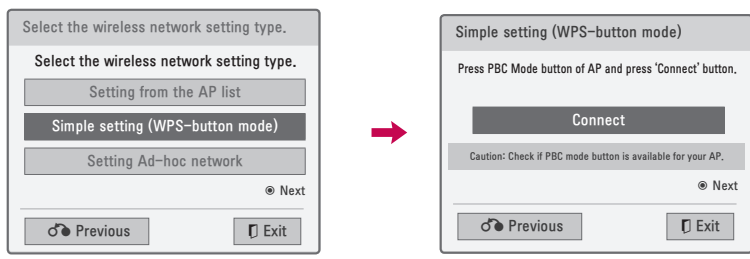

1 Repeat step 1-4 on P.51.

2   Select **Simple setting (WPS-button mode)**.

3  Select **Connect**.

4 Repeat step 4-5 on P.48.

## AD-hoc Mode

The below settings are only for connecting directly to a PC.

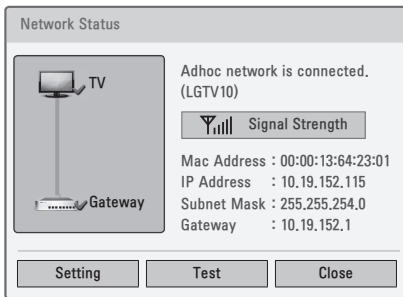
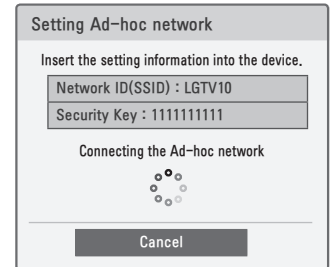
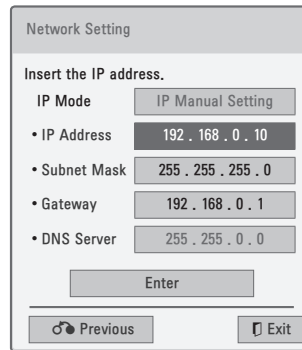
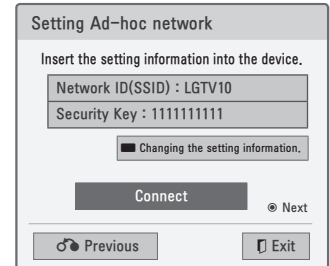
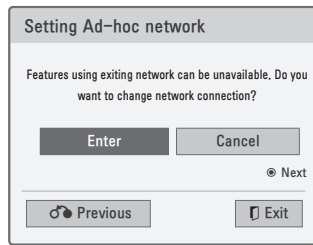
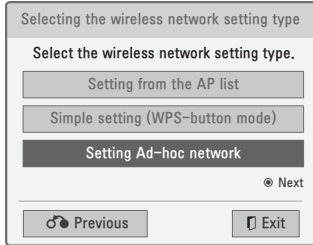

This is the same as connecting two PCs with a cross-over cable.



- PC Setting  
Internet Protocol(TCP/IP) of PC needs to be set manually.  
IP address, Subnet Mask, and default Gateway can be set with your own discretion.  
i.e) IP address: 192.168.0.1 / Subnet Mask: 255.255.255.0 / default Gateway: 192.168.0.10
- TV Setting  
Verify IP address and gateway of PC.  
Input Gateway address of PC to IP Address, and IP Address of PC to Gateway, and select **Enter**.  
i.e) IP address: 192.168.0.10 / Subnet Mask: 255.255.255.0 / default Gateway: 192.168.0.1

- Example of the PC setting that supports a wireless network
1. Find a wireless network device in your PC.
  2. Select LGTV10 that appears in the list. (Select the same name as the network ID that appears on your TV screen.)
  3. Type 1111111111 in the Inserting the security key dialog. (Type the security key that appears on your TV screen.)

1 Repeat step 1-3 on P.51.

2   Select **Setting AD-hoc network**.

3    Select **Enter**.

4  Select **Connect** to connect Ad-hoc network.

You can see the Network ID and Security Key on your TV screen.  
Enter this Network ID and Security Key to your device.

If a network may not operate, change the setting information using the RED button.





5   Insert the IP address.

6   Network setting is completed. Select **Close**.

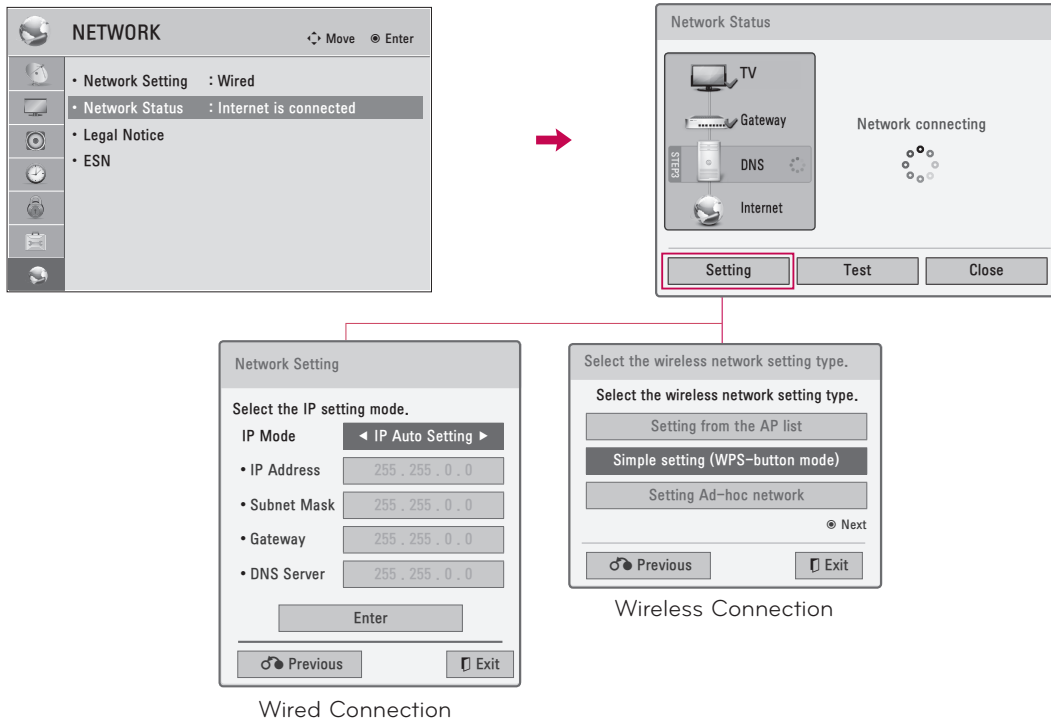
# EXTERNAL EQUIPMENT SETUP

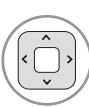
## Network Status

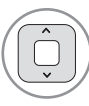

-   Select **NETWORK**.
-   Select **Network Status**.
-  Check the network status.

- **Setting:** Return to the network setting menu or wireless network setting type menu.
- **Test:** Test the current network status after setting the network.
- **Close:** Return to the previous menu.

# WATCHING TV / CHANNEL CONTROL

## REMOTE CONTROL FUNCTIONS

When using the remote control, aim it at the remote control sensor on the TV.  
The remote control may differ from the images below.

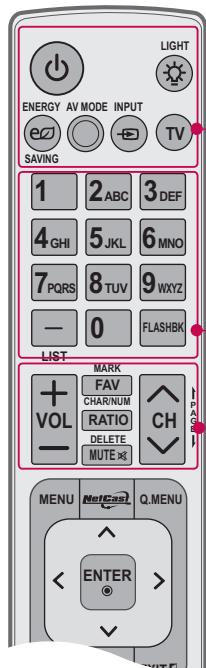

- POWER** Turns the TV on from standby or off to standby.
- LIGHT** Illuminates the remote control buttons.
- ENERGY SAVING** Adjusts the Energy Saving setting. ▶ p.132
- AV MODE** Toggles through preset Video and Audio modes. ▶ p.85
- INPUT** Rotates through inputs. Also switches the TV on from standby.
- TV** Returns to the last TV channel.

- NUMBER button**
  - (DASH)** Used to enter a program number for multiple program channels such as 2-1, 2-2, etc.
  - LIST** Displays the channel table.
  - FLASHBK** Tunes to the last channel viewed.

- VOLUME UP/DOWN** Adjusts the volume.
- FAV** Set up desired favorite channels list.
- MARK** Select the input to apply the Picture Wizard settings. ▶ p.131  
Use to mark or unmark a photo/music/movie. ▶ p.105, 110, 116
- RATIO** Changes the aspect ratio. ▶ p.128
- 3D** Used for viewing 3D video. ▶ p.94
- CHAR/NUM** Shifts the Character or Number in internet settings.
- MUTE** Switches the sound on or off.
- DELETE** Delete the character or number on the screen.
- CHANNEL UP/DOWN** Changes the channel.
- PAGE UP/DOWN** Moves from one full set of screen information to the next one.

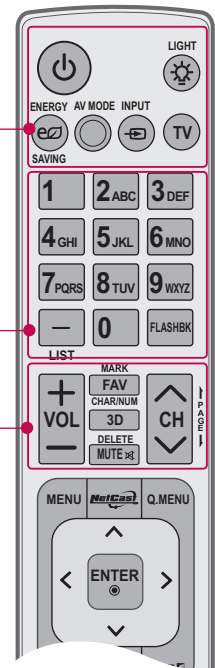

# WATCHING TV / CHANNEL CONTROL

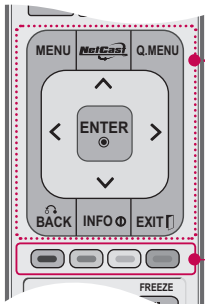
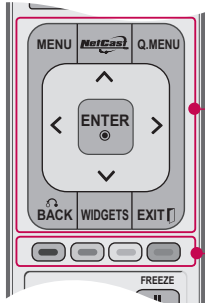

- MENU** Displays the main menu or clears all on-screen displays and return to TV viewing.
- NETCAST** Select the desired NETCAST menu source. ▶ **p.123**
- Q.MENU** Opens the list of Quick Menu options. ▶ **p.66**
- THUMBSTICK (Up/Down/Left Right/ENTER)** Navigates the on-screen menus and adjusts the system settings to your preference.
- BACK** Allows the user to move return one step in an interactive application or other user interaction function.
- WIDGETS** WIDGETS for showing or hiding the Yahoo! Dock and accessing the Yahoo! TV Widgets user experience.
- INFO** Displays channel information at the bottom of the screen. ▶ **p.78**
- EXIT** Clears all on-screen displays and return to TV viewing.

- COLOR BUTTON** Access special functions in some menus.
- L/R SELECT** Used for viewing 3D video. ▶ **p.95**

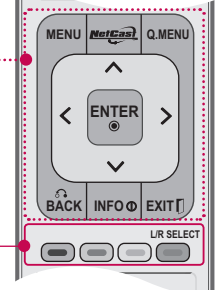
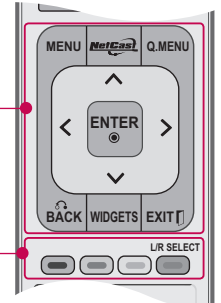





### USB, SIMPLINK Control buttons

- Controls MY MEDIA menu (Movie List, Photo List, Music List)
- Controls the SIMPLINK compatible devices.

### FREEZE (For Plasma TV)

Pause the present picture at the screen. (It doesn't work at USB Mode and Simplink.)

The TV returns to normal viewing automatically if no signal is received or no operation is performed for 5 minutes. If you keep the screen in Freeze condition, the residual image can exist.

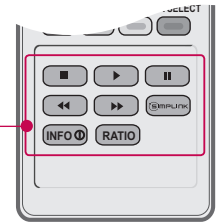

### SIMPLINK

See a list of AV devices connected to TV.

When you toggle this button, the SIMPLINK menu appears at the screen.

▶ p.90

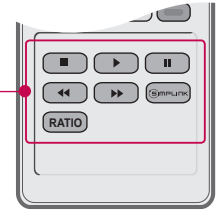

### RATIO

Changes the aspect ratio. ▶ p.128

## Installing Batteries

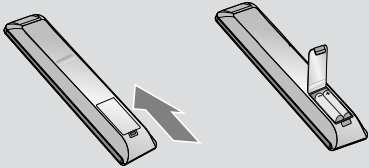

- Open the battery compartment cover on the back side and install the batteries matching correct polarity.
- Install two 1.5V AAA batteries. Don't mix old or used batteries with new ones.
- Close cover.

# WATCHING TV / CHANNEL CONTROL

## MAGIC MOTION REMOTE CONTROL FUNCTIONS

WATCHING TV / CHANNEL CONTROL

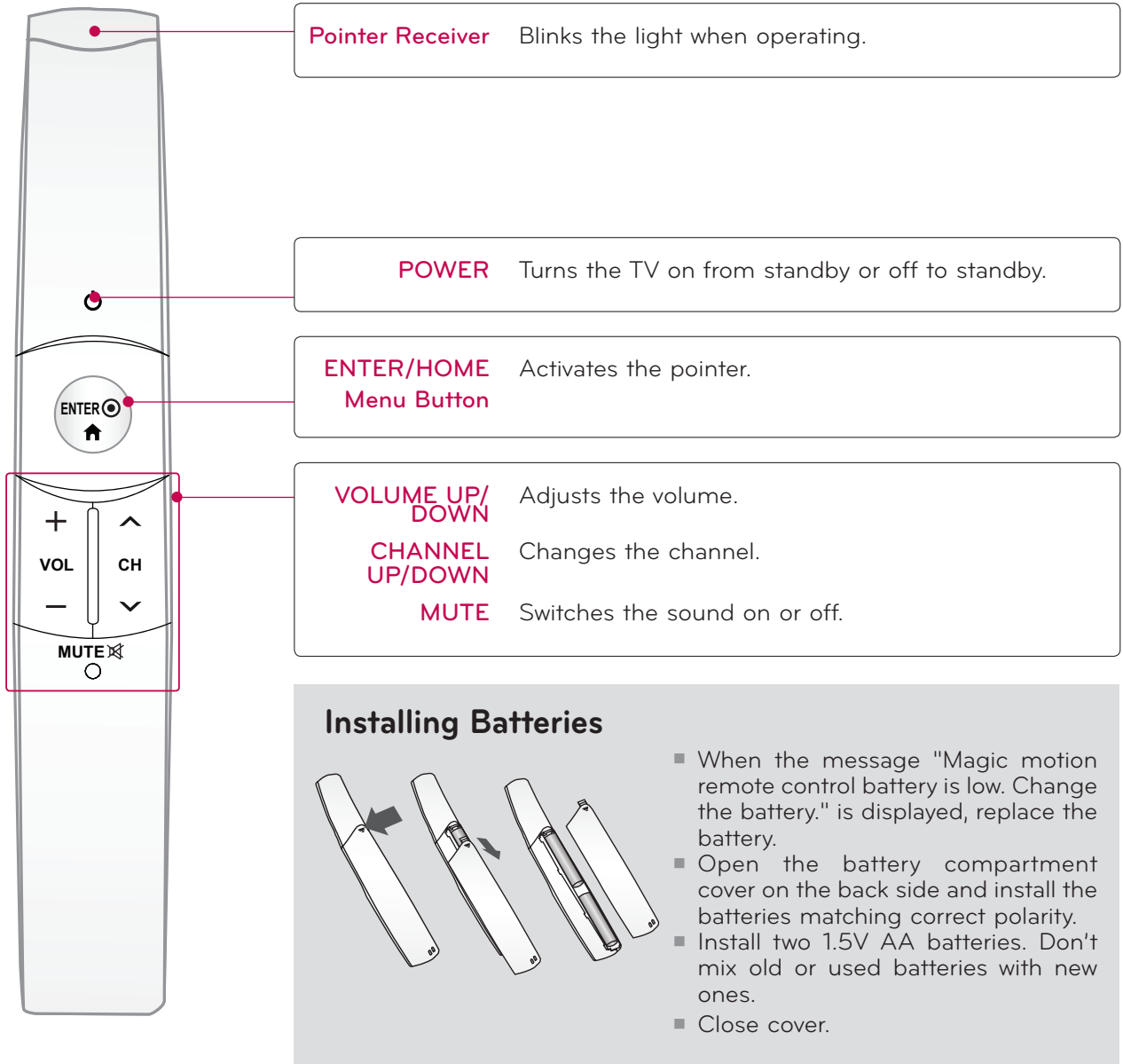

**Pointer Receiver** Blinks the light when operating.

**POWER** Turns the TV on from standby or off to standby.

**ENTER/HOME Menu Button** Activates the pointer.

**VOLUME UP/DOWN** Adjusts the volume.  
**CHANNEL UP/DOWN** Changes the channel.  
**MUTE** Switches the sound on or off.

### Installing Batteries

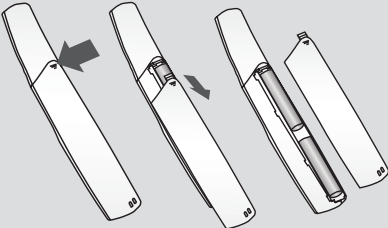

- When the message "Magic motion remote control battery is low. Change the battery." is displayed, replace the battery.
- Open the battery compartment cover on the back side and install the batteries matching correct polarity.
- Install two 1.5V AA batteries. Don't mix old or used batteries with new ones.
- Close cover.

### RF Specification of the Magic Motion Remote Control

The Magic Motion Remote Control communicates with your TV by using a 2.4 GHz bandwidth radio frequency (RF).

- Output: 1 dBm or lower
- Maximum Communication Distance: 10 m (30 ft) in an open space
- Bandwidth: 2.4 GHz (2.4035 GHz - 2.4783 GHz)
- Transfer Rate: 250 kbps

## Magic Motion Remote Control Registration

The Magic Motion Remote Control operates by pairing with your TV. Register the Magic Motion Remote Control after purchasing the TV.

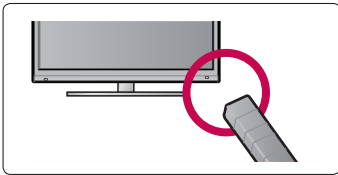

### How to register the Magic Motion Remote Control

To register the Remote Control, press the **ENTER** button on the Remote Control while aiming it at your TV.



### How to Re-register the Magic Motion Remote Control after Registration Failure

Reset the remote control by pressing and holding both the **ENTER** and **MUTE** buttons for 5 seconds. (Once the reset is complete, the light on the Pointer RF Receiver blinks.) Then repeat the above procedure to register the remote control.

## How to use Magic Motion Remote Control



**1** Press this button if there is no pointer on your TV screen. The pointer will then appear on the screen. If the pointer has not been used for a certain period of time, it will disappear.

**2**

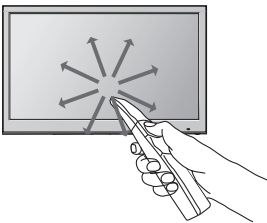

You can move the pointer by aiming the Pointer Receiver of the remote control at your TV then move it left, right, up or down. If the pointer does not work properly after clicking the ENTER button, leave the remote control for 10 seconds then use it again.

## Precautions to Take when Using the Magic Motion Remote Control

- Use the remote control within the maximum communication distance (10 m). Using the remote control beyond this distance, or with an object obstructing it, may cause a communication failure.
- A communication failure may occur due to nearby devices. Electrical devices such as a microwave oven or wireless LAN product may cause interference, as this will use the same bandwidth (2.4 GHz) as the Magic Motion Remote Control.
- The Magic Motion Remote Control may be damaged or may malfunction if it is dropped or receives a heavy impact.
- When playing a game using the Magic Motion Remote Control, hold it securely by wrapping its strap around your wrist and adjusting the length with the adjustable ring.
- Take care not to bump into nearby furniture or other people when using the Magic Motion Remote Control.
- Manufacturer and installer cannot provide service related to human safety as the applicable wireless device has possibility of electric wave interference.

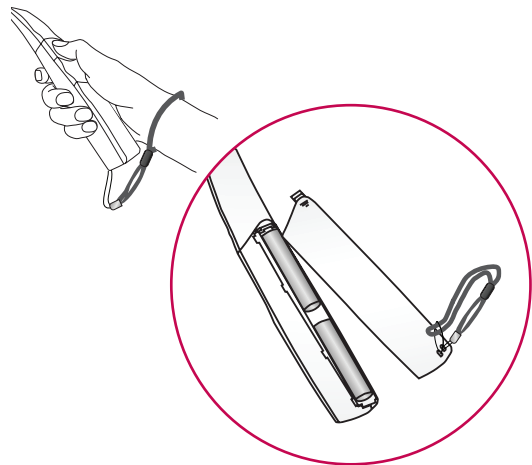

# WATCHING TV / CHANNEL CONTROL

## Pointer Menu Options

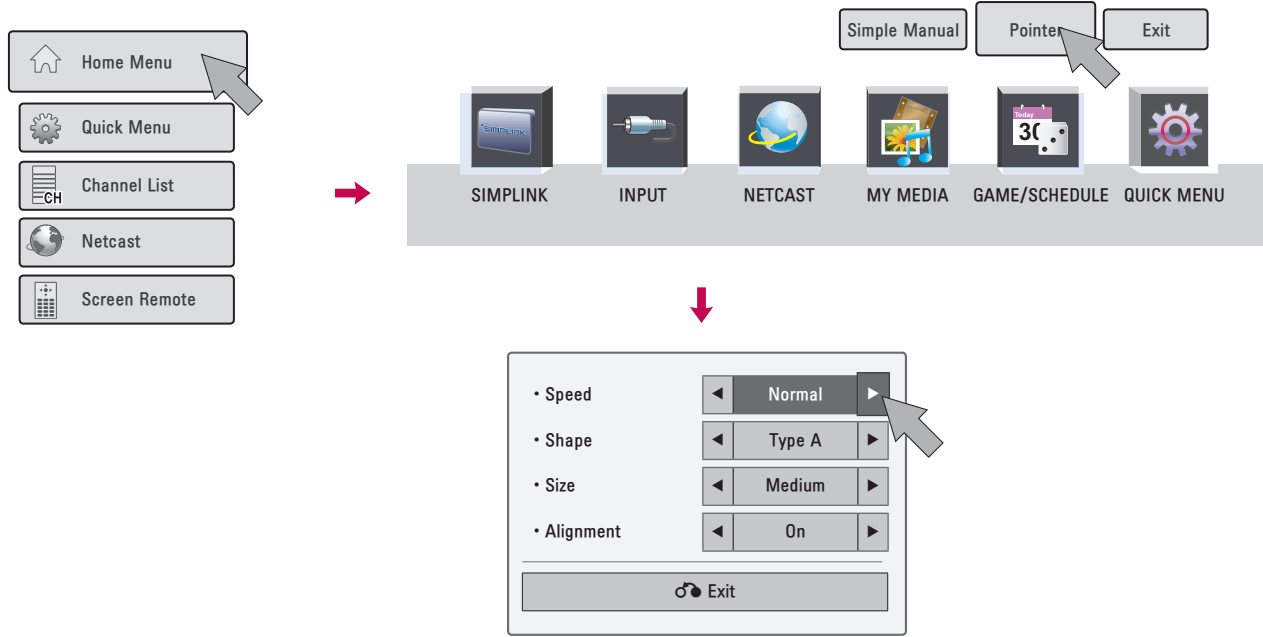

- 1 Select **Home Menu**.
- 2 Select **Pointer**.
- 3 Make appropriate adjustments.
- 4 Select **Exit**.

- **Speed:** Changed the pointer speed.
- **Shape:** Select the pointer shape.
- **Size:** Changes the pointer size.
- **Alignment:** When Alignment is On, you can easily align the remote control's direction with the pointer on your TV screen by shaking the remote control left and right. Then, the pointer automatically moves to the center of the screen.

## TURNING ON THE TV

---

- 1 First, connect power cord correctly.  
At this moment, the TV switches to standby mode.
    - In standby mode to turn TV on, press the **⏻ / I**, **INPUT, CH (▲ or ▼)** button on the TV or press the **⏻**, **INPUT, CH (▲ or ▼)**, **Number (0-9)** button on the remote control.
  - 2 Select the viewing source by using the **INPUT** button on the remote control.
  - 3 When finished using the TV, press the **POWER** button on the remote control. The TV reverts to standby mode.
- 

### NOTE

- ▶ If you intend to be away on vacation, disconnect the power plug from the wall power outlet.
- ▶ If you do not complete the **Initial setting**, it will appear whenever the TV is switched on until the **Initial setting** procedure is completed.

## CHANNEL SELECTION

---

- 1 Press the **CH (▲ or ▼)** or **NUMBER** buttons to select a channel number.
- 

## VOLUME ADJUSTMENT

Adjust the volume to suit your personal preference.

---

- 1 Press the **VOL (+ or -)** button to adjust the volume.
  - 2 If you want to switch the sound off, press the **MUTE** button.
  - 3 You can cancel the Mute function by pressing the **MUTE** or **VOL (+ or -)** button.
-

# WATCHING TV / CHANNEL CONTROL

## INITIAL SETTING

This Function guides the user to easily set the essential items for viewing the TV for the first time when purchasing the TV. It will be displayed on the screen when turning the TV on for the first time. It can also be activated from the user menus.

- Default selection is "**Home Use**". We recommend setting the TV to "**Home Use**" mode for the best picture in your home environment.
- "**Store Demo**" Mode is only intended for use in retail environments. Customers can adjust the "**Picture** menu - **Picture mode**" manually while inspecting the TV, but the TV will automatically return to preset in-store mode after 5 minutes.
- "**Store Demo**" Mode is an optimal setting for displaying at stores. "Store Demo" mode initializes the TV to set the image quality:

### Step 1. Selecting Language



Select Menu Language.

### Step 2. Mode setting

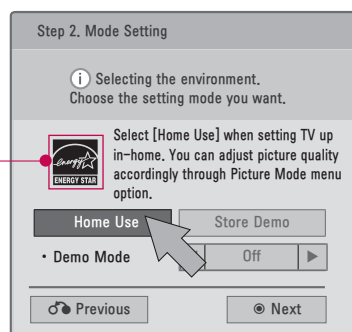

Select **Home Use**.

Only LED LCD TV for USA/Canada

### Step 3. Power Indicator (For LED LCD TV)

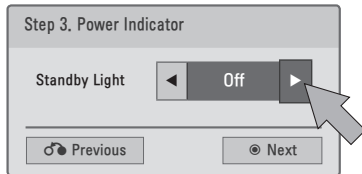

- This function is disabled in "Step2. Mode Setting - Store Demo".

### Step 4. Time Zone

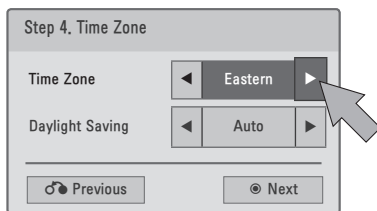

### Step 5. Auto Tuning

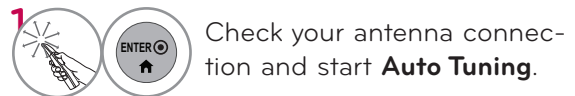
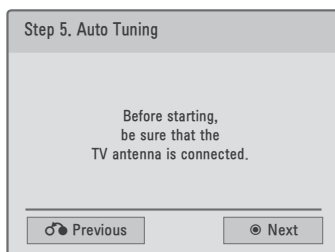

# WATCHING TV / CHANNEL CONTROL

## ON-SCREEN MENUS SELECTION

Your TV's OSD (On Screen Display) may differ slightly from that shown in this manual.

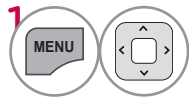

1 Display each menu.

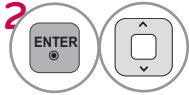

2 Select a menu item.



3 Accept the current selection.



4 Return to TV viewing.

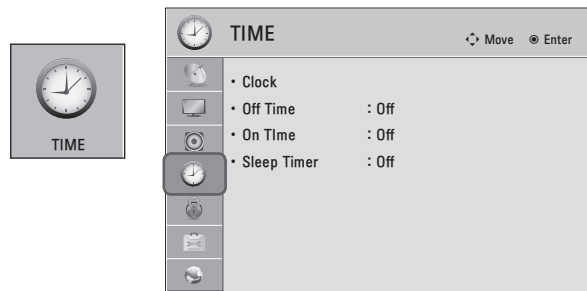
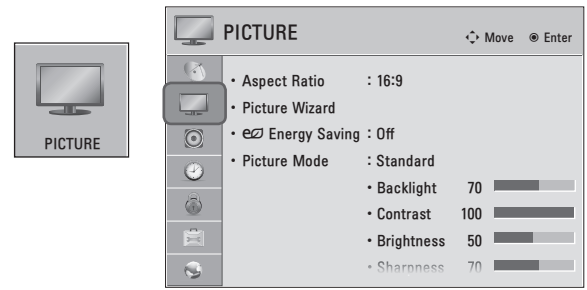

### For USA

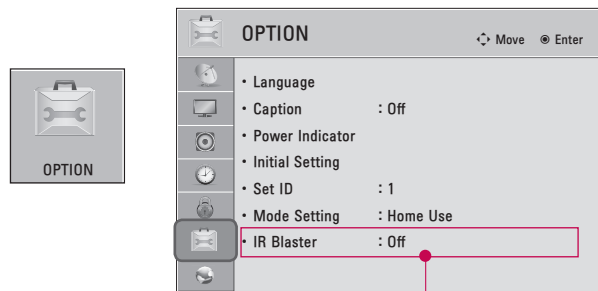
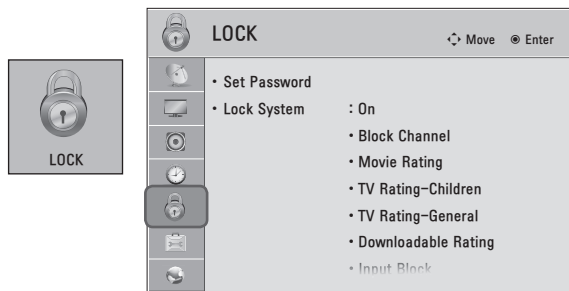

### For Canada, Philippines

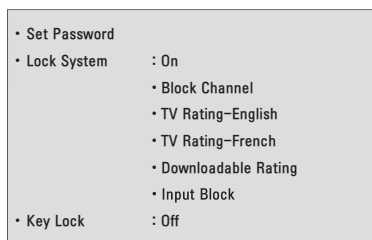

■ For further information, refer to the optional "Wireless Media Box" manual for operating instructions.

### NOTE

- ▶ **ISM Method:** For Plasma TV.
- ▶ **Backlight, TruMotion, LED Local Dimming, Power Indicator:** For LED LCD TV.





**NETWORK** Move Enter

- Network Setting : None
- Network Status : Not connected
- Legal Notice
- ESN

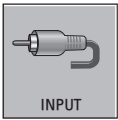

**Input List** Move Enter

TV	USB1	USB2	AV 1	AV 2	Component1
Component2	RGB-PC	HDMI1	HDMI2	HDMI3	HDMI4

Input Label



**MY MEDIA**

Movie List Photo List Music List











**GAME/SCHEDULE**

WORLD TIME	SCHEDULE	JUMP	HOLE IN ONE	WHACK A MOLE
SUDOKU	JIGSAW	COOKING BURGER	BALLOON HUNTER	SAVING CRYSTAL
INVADER	URGENT SURVIVAL			





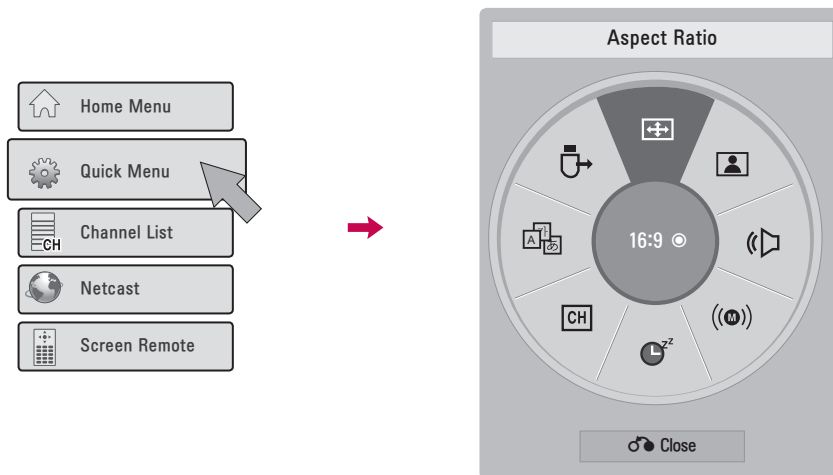

# WATCHING TV / CHANNEL CONTROL

## QUICK MENU

Your TV's OSD (On Screen Display) may differ slightly from what is shown in this manual. Q.Menu (Quick Menu) is a menu of features which users might use frequently.

-  **Aspect Ratio:** Selects your desired picture format.
-  **Picture Mode:** Selects the desired preset picture setting.
-  **Sound Mode:** Selects the desired preset sound setting.
-  **Multi Audio:** Changes the audio language (Digital signal).
-  **SAP:** Selects MTS sound (Analog signal).
-  **Sleep Timer:** Select the amount of time before your TV turns off automatically.
-  **Del/Add:** Select channel you want to add or delete.
-  **Caption:** Select on or off.
-  **USB Device:** Select "Eject" in order to eject a USB device.











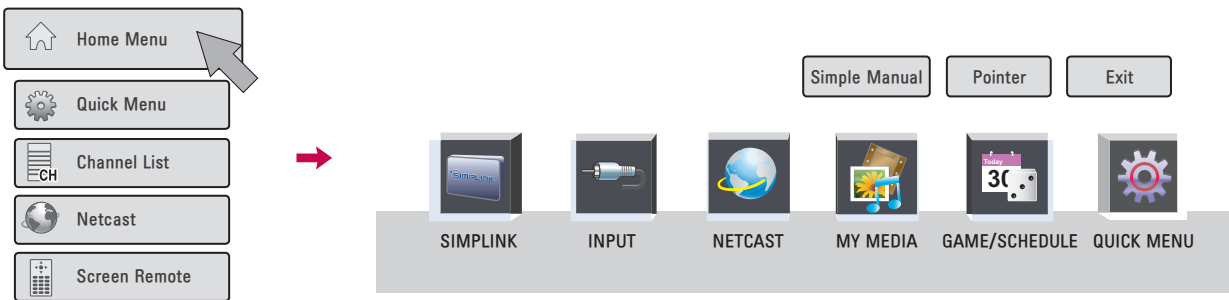

-    Select **Quick Menu**.
-   Select a menu item.
-   Select **Close**.

■ **Quick Menu** can be selected either by pressing the **Q.MENU** button on a standard remote control, or by selecting on the **Home Menu** screen.

# HOME MENU

Your TV's OSD (On Screen Display) may differ slightly from that shown in this manual.

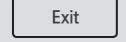

 SIMPLINK	SIMPLINK allows you to control and play other AV devices connected with HDMI cable without additional cables and settings. This TV may work with devices with HDMI-CEC support, but only devices with the  logo are fully supported.
 INPUT	Select the desired input source.
 NETCAST	Select NETCAST menu option and enjoy Online Service.
 MY MEDIA	Used for viewing photos, watching movies and listening to MP3s.
 GAME/SCHEDULE	Allows you to enjoy the games installed on the TV or set the schedule.
 QUICK MENU	Q.Menu (Quick Menu) is a menu of features which users might use frequently.
 Simple Manual	You can easily and effectively access the TV information by viewing a simple manual on the TV.
 Pointer	Set up the Magic Motion Remote Control setting.
 Exit	Close the Home menu.

# WATCHING TV / CHANNEL CONTROL

## CUSTOMER SUPPORT





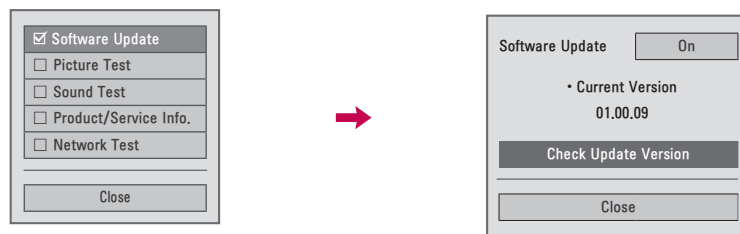

### Software Update

You can update the TV with the latest software to enhance the product operation and/or add new features.

You can update the software by connecting the TV directly to the software update server.

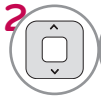
The Software Update function may not work properly depending on your internet environment. In this case, you can obtain the latest software from the authorized LG Electronics Service Center then update your TV.

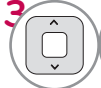

-   Select **Customer Support**.
-   Select **Software Update**.
-   Select **Check Update Version** to check the newest version.

When selecting "Software Update-On"







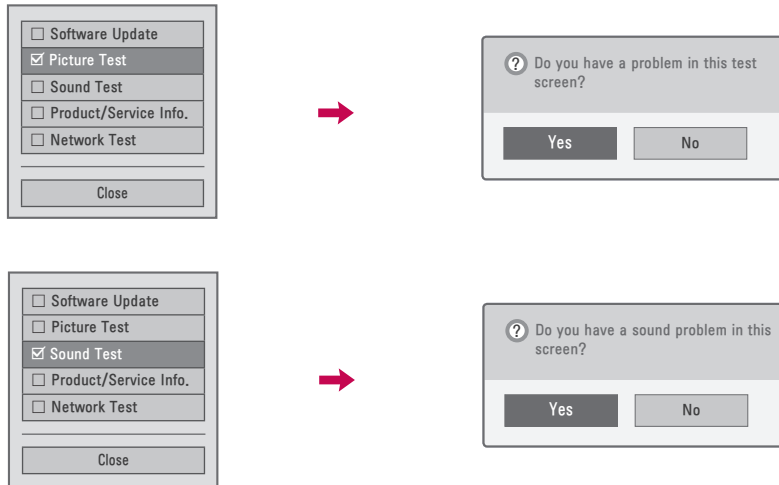

- If the TV is connected to the internet and it finds a software update on the LG server, the update popup menu will appear automatically.
- If the updated digital software information is transmitted, the update popup menu will appear automatically.

- The software downloading time will vary depending on the software size and network conditions.
- During the software update procedure, do not turn off the TV or disconnect AC power, or disconnect the LAN cable.
- After software update, you can confirm the update software version at software Update menu.
- When update is completed, the TV will restart automatically in 5 seconds.
- The TV functions may be improved or changed by software update.
- The available time or functionality of NetCast menu may be depends on your ISP network conditions.
- When an update is completed, some CHANNEL, PICTURE, and AUDIO menu settings may need resetting.
- This TV cannot be updated to previous software version.
- Use the "Check Update Version" button to update the latest software on the Network server manually.
- You cannot open NetCast while the software is being updated.

## Picture Test/Sound Test

This function is a customer support function that can execute picture and sound tests.







- 1   Select **Customer Support**.
- 2   Select **Picture Test** or **Sound Test**.
- 3   Select **Yes**.
- 4  Return to the previous menu.
-  Return to TV viewing.

# WATCHING TV / CHANNEL CONTROL

## Product/Service Info.

This function shows support and product information.

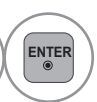



Customer Service Center can differ by country.

-   Select **Customer Support**.
-   Select **Product/Service Info..**  
You can check the various product/Service information based on your model.
-  Return to the previous menu.
-  Return to TV viewing.

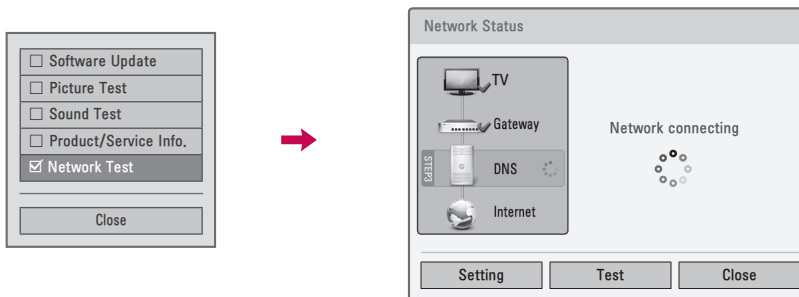
## Network Test

Check the network status.





- 1   Select **Customer Support**.
- 2   Select **Network Test**.
- 3  Check the network status.

# WATCHING TV / CHANNEL CONTROL

## SIMPLE MANUAL

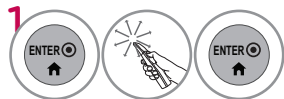
You can easily and effectively access the TV information by viewing a simple manual on the TV. During the Simple Manual operation, audio will be muted.

- 1  Select **Home Menu**.
- 2  Select **Simple Manual**.
- 3  Select the part of the manual you would like to see.
- 3  Select **Exit**.

- **RED**: Go to the **Index** page.
- **BLUE**: Play the **Simple Manual** automatically or manually.



# CHANNEL SETUP

\* The Digital broadcasting (DTV, Cable DTV) is not available for Philippines.







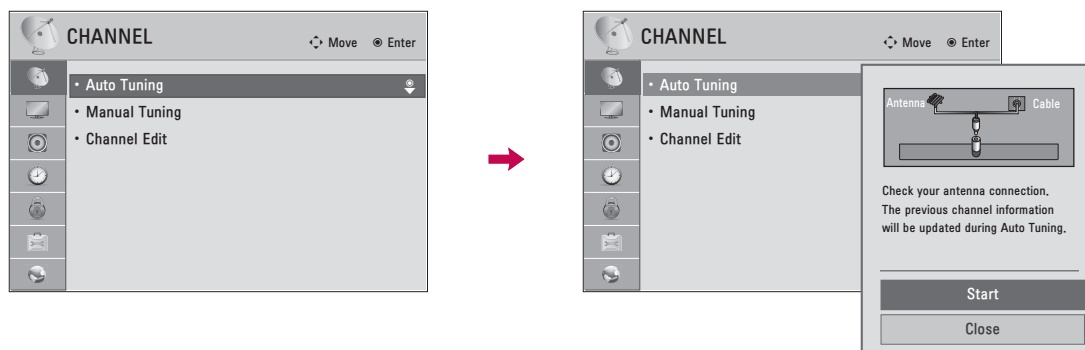

## Auto Scan (Auto Tuning)

Automatically finds all channels available through antenna or cable inputs, and stores them in memory on the channel list.

Run this function if you change your residence or move the TV.

Auto Tuning memorizes only the channels available at the time.



- 1   Select **CHANNEL**.
- 2   Select **Auto Tuning**.
- 3   Select **Start**.
- 4  Run **Auto tuning**.
- 5  Return to the previous menu.
-  Return to TV viewing.









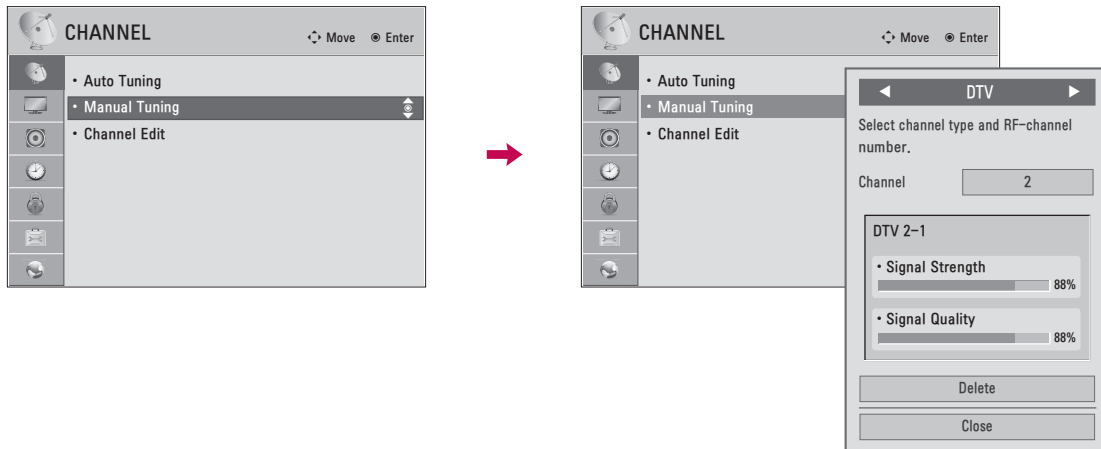

- The TV will ask for a password if parental control has been activated (LOCK Menu). Use the password you set up in the LOCK Menu to allow a channel search.
- The maximum number of channels the TV can store is 1000.
- Found channels are grouped in the order of DTV, TV, Cable DTV and Cable TV.

# WATCHING TV / CHANNEL CONTROL

## Add/Delete Channel (Manual Tuning)

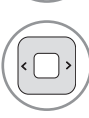
When selecting DTV or Cable DTV input signal in **Manual Tuning**, you can view the on-screen signal strength monitor to see the quality of the signal being received.



-   Select **CHANNEL**.
-   Select **Manual Tuning**.
-   Select **DTV**, **TV**, **Cable DTV**, or **Cable TV**.
-   Select channel you want to add or delete.
-   Select **Add** or **Delete**.
-  Return to the previous menu.
-  Return to TV viewing.

- The TV will ask for a password if parental control has been activated (LOCK Menu). Use the password you set up in the LOCK Menu to allow a channel search.
- The maximum number of channels the TV can store is 1000.

## Channel Editing

The channels in the Channel Edit List are displayed in black and the channels deleted from the Channel Edit List are displayed in blue.

When a channel number is deleted, it means that you will be unable to select it using CH $\wedge$ V button during TV viewing. If you wish to select the deleted channel, directly enter the channel number with the NUMBER buttons or select it in the Channel Edit menu.

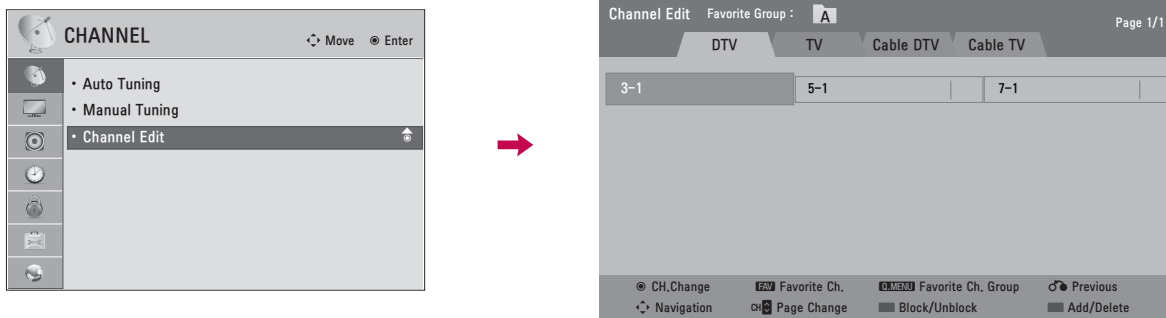

1 Select **CHANNEL**.

2 Select **Channel Edit**.

3 Select a channel.

4 Add or delete a channel.

Block or unblock the channel.  
You can block/unblock channels even if you select "Lock system-Off" in the LOCK menu.

Switch to the chosen channel number.

Move the pages when the channel list is too long.

5 Return to the previous menu.

Return to TV viewing.

- Keep pressing the  $\wedge$  button and use the  $\leftarrow$  or  $\rightarrow$  buttons to move between DTV, TV, Cable DTV and Cable TV.

# WATCHING TV / CHANNEL CONTROL

## CHANNEL LIST

You can check which channels are stored in the memory by displaying the channel list.



-  Select **Channel List**.
-  Select a channel you want to switch.  
 Tune to the "**CHANNEL** menu - **Channel Edit**".
-  Select **Exit**.

# FAVORITE CHANNEL SETUP

Favorite Channels are a convenient feature that lets you quickly select channels of your choice without waiting for the TV to select all the in-between channels.

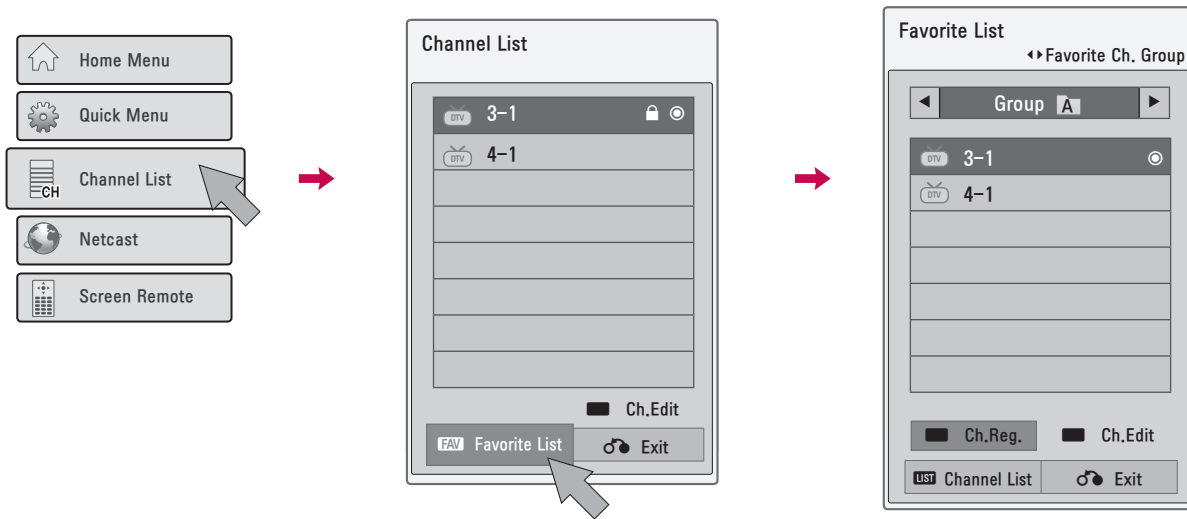

- 1 Select **Channel List**.
- 2 Select **Favorite List**.
- 3 Select your desired favorite channel group from A to D.
- 4 Select your desired channel.
- 5 Select **Ch.Reg** to register or cancel the current channel in favorite channel list.
- 6 Select **Exit**.



■ You can also setup **Favorite List** in the **CHANNEL** menu - **Channel Edit**.

# WATCHING TV / CHANNEL CONTROL

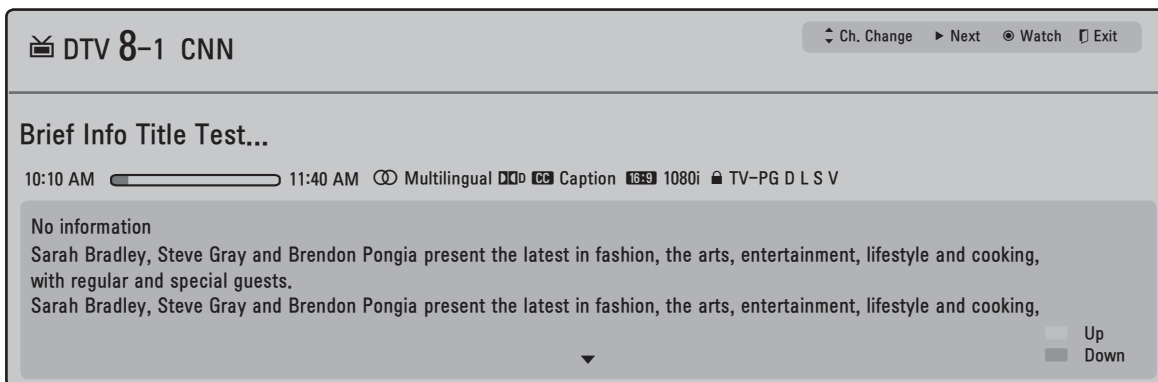
## CHANNEL INFORMATION





### Displaying Channel Information

-  Show the current channel program Information on the screen.
-  Show a previous or next channel's program information
-  Return to TV viewing.









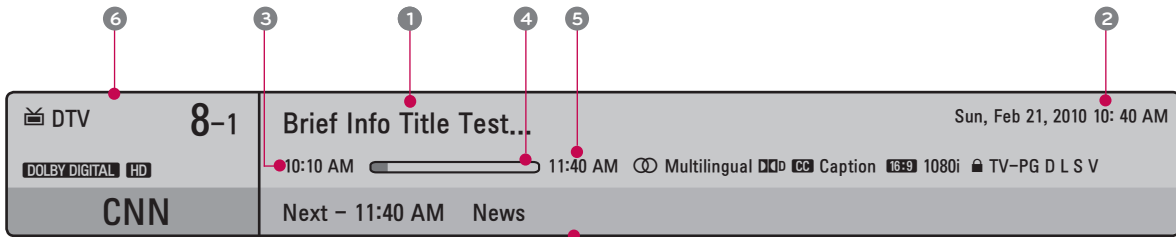

# CHANNEL BRIEF INFORMATION

Brief Info shows the present screen information.

**1**  Shows the current channel's brief info screen.

**2**  Return to TV viewing.



	<b>Multilingual</b> : The program contains two or more audio services. Use the <b>Q.MENU</b> menu to select wanted Audio.
	<b>Caption</b> : The program contains one or more caption services. Use the <b>Q.MENU</b> menu to select wanted Closed caption.
	<b>Dolby Digital</b> : The program contains a Dolby Digital audio signal in TV and HDMI input source.
	The original aspect ratio of the video is 4:3
	The original aspect ratio of the video is 16:9 (wide)
	The video resolution is 720x480i
	The video resolution is 720x480p
	The video resolution is 1280x720p
	The video resolution is 1920x1080i
	The video resolution is 1920x1080p
	<b>V-Chip</b> : The program contains V-Chip information. Refer to the LOCK menu: A (Age), D (Dialogue), L (Language), S (Sex), V (Violence), FV (Fantasy Violence)

- 1** Program title
- 2** Day, Month, Year, Present time
- 3** Program start time
- 4** Program progress bar
- 5** Program finish time
- 6** Banner information

# WATCHING TV / CHANNEL CONTROL

## INPUT LIST

Only these input signals which are connected to a TV can be activated and selected.

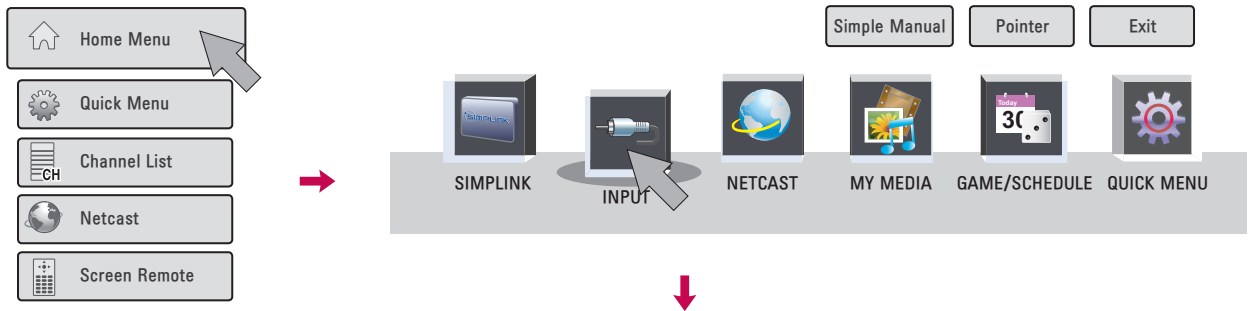

i.e)

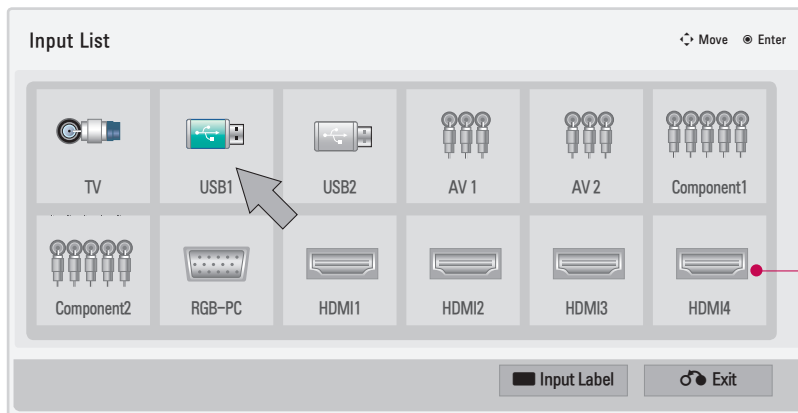

Disconnected inputs are inactive (grayed out)

- 1 Select **Home Menu**.
- 2 Select **INPUT**.
- 3 Select the desired input source.
- 4 Select **Exit**.

- **TV**: Select it to watch over-the-air, cable and digital cable broadcasts.
- **USB**: Select it to use movie, photo, or music files.
- **AV**: Select them to watch a VCR or other external equipment.
- **Component**: Select them to watch DVD or a Digital set-top box.
- **RGB-PC**: Select it to view PC input.
- **HDMI**: Select them to watch high definition devices.

- When new external device is connected, this popup menu is displayed automatically. If selecting **Yes**, you can select input source that you want to appreciate.
- But, when selecting "**SIMPLINK - On**", popup menu for HDMI input will not be displayed.

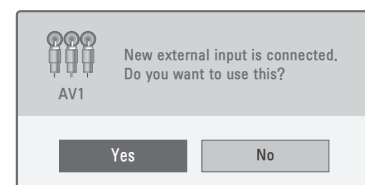



# INPUT LABEL

This indicates which device is connected to which input port.

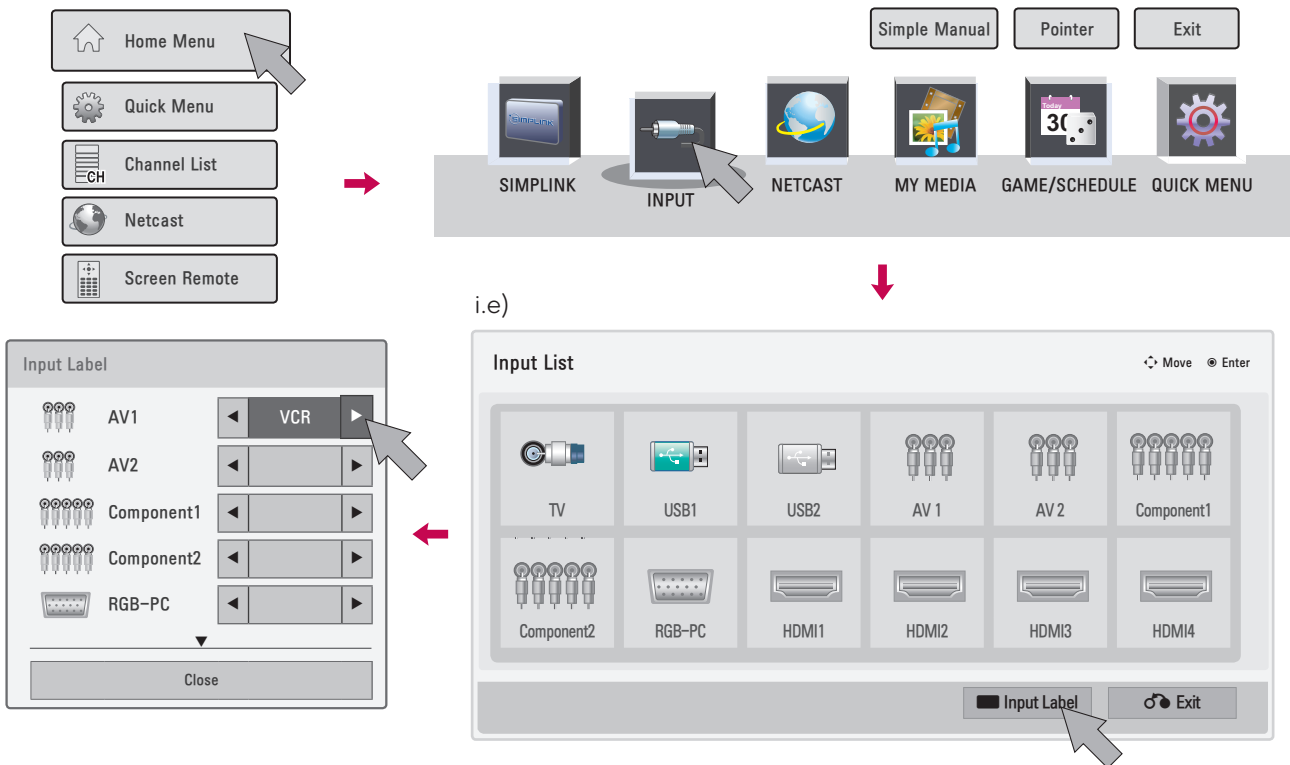

- 1 Select **Home Menu**.
- 2 Select **INPUT**.
- 3 Select **Input Label**.
- 4 Select the desired input source and then select to choose the input label.
- 5 Select **Exit**.





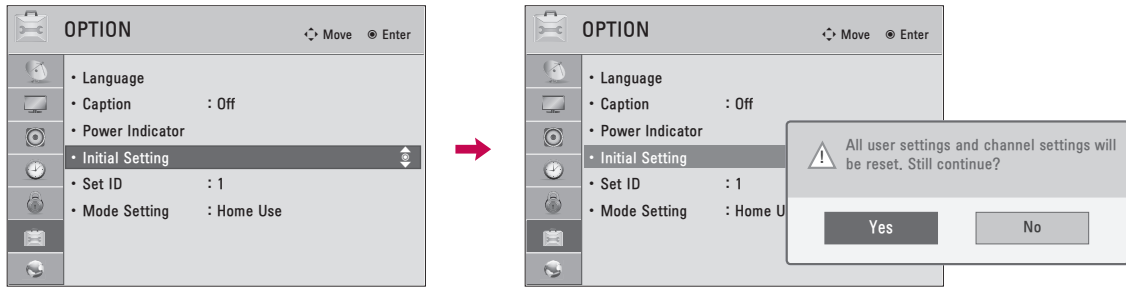

■ You can also select the **Input label** using the BLUE button on the TV remote control.

# WATCHING TV / CHANNEL CONTROL

## RESET TO FACTORY DEFAULT (INITIAL SETTING)

This function resets the TV to factory default and erases all stored channels.



-   Select **OPTION**.
-   Select **Initial Setting**.
-   Select **Yes**.
-  TV turns off automatically and starts factory reset.







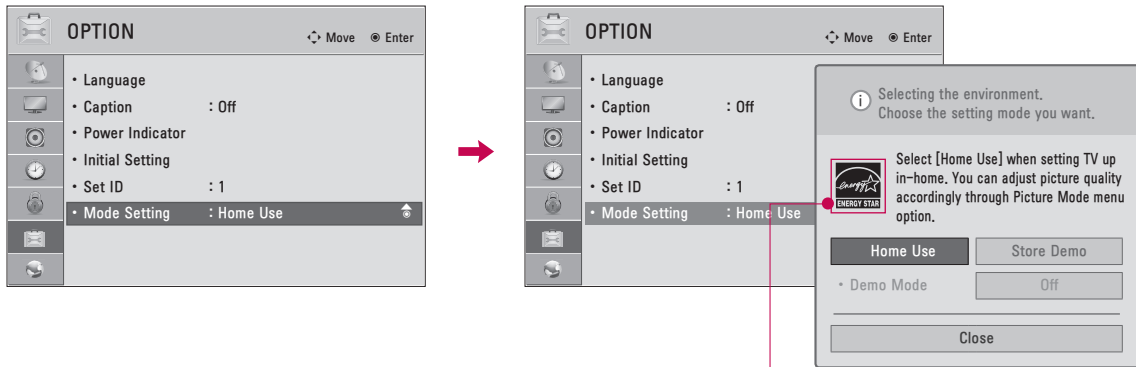

- When selecting "**Lock System - On**" in the LOCK menu, the message to enter the password appears.
- If you forget your password, press "0-3-2-5" on the remote control.

## MODE SETTING

Default selection is "Home Use". We recommend setting the TV to "Home Use" mode for the best picture in your home environment.



Only LED LCD TV for USA/Canada

- 1   Select **OPTION**.
- 2   Select **Mode Setting**.
- 3   Select **Home Use**.
- 4  Return to the previous menu.
-  Return to TV viewing.









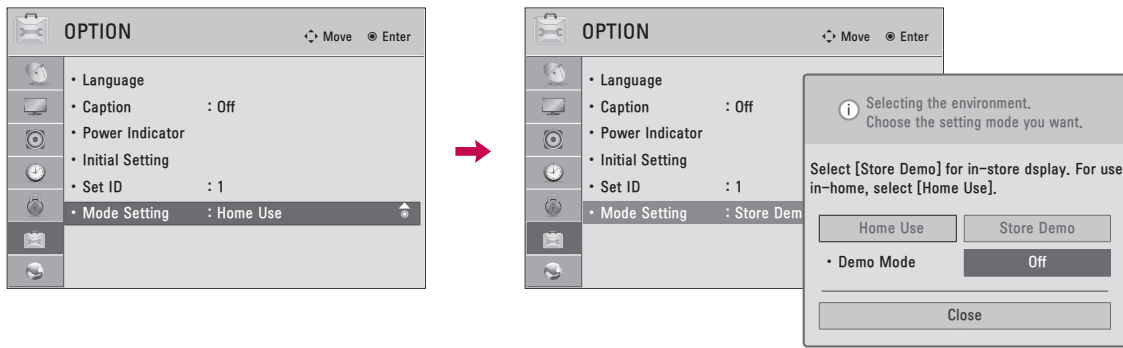

- "Store Demo" Mode is only intended for use in retail environments. Customers can adjust the "Picture menu - Picture mode" manually while inspecting the TV, but the TV will automatically return to preset in-store mode after 5 minutes.
- "Store Demo" Mode is an optimal setting for displaying at stores. "Store Demo" mode initializes the TV to set the image quality:

# WATCHING TV / CHANNEL CONTROL

## DEMO MODE

Displays a slide show to explain the various feature of this TV.



- 1   Select **OPTION**.
- 2   Select **Mode Setting**.
- 3   Select **Store Demo**.
- 4    Select **On**.
- 5  Return to TV viewing.  
After a while, **Demo Mode** starts.





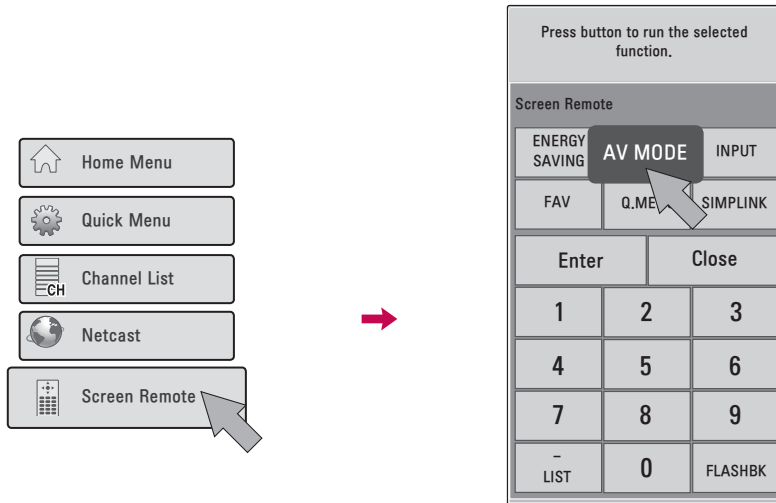

■ This feature is disabled in "Home Use".

If you want to stop the demo, press any button (Except VOL +, - and MUTE button).

# AV MODE

AV Mode toggles through preset Video and Audio settings.



- 1    Select **Screen Remote**.
- 2   Select **AV MODE**.
- 3   Select **AV MODE** repeatedly to select your desired menu option.

- If you select "**Cinema / THX Cinema**" in AV mode, **Cinema / THX Cinema** will be selected both for "PICTURE menu - Picture Mode" and "AUDIO menu - Sound Mode" respectively.
- If you select "**Off**" in AV mode, the "**Picture Mode**" and "**Sound Mode**" return to previous selected value.
- **Off**: Disables the AV MODE.
- **Cinema / THX Cinema**: Optimizes video and audio for watching movies.
- **Sport**: Optimizes video and audio for watching sports events.
- **Game**: Optimizes video and audio for playing games.  
When playing a video game using PlayStation or Xbox, it is recommended to use the **Game** mode.  
When in **Game** mode, functions related to picture quality will be optimized for playing games.
- Press the **AV MODE** button repeatedly to select your desired menu option.

# WATCHING TV / CHANNEL CONTROL

## GAME/SCHEDULE

### World Time

This function operates only if the current time has been set.

WATCHING TV / CHANNEL CONTROL

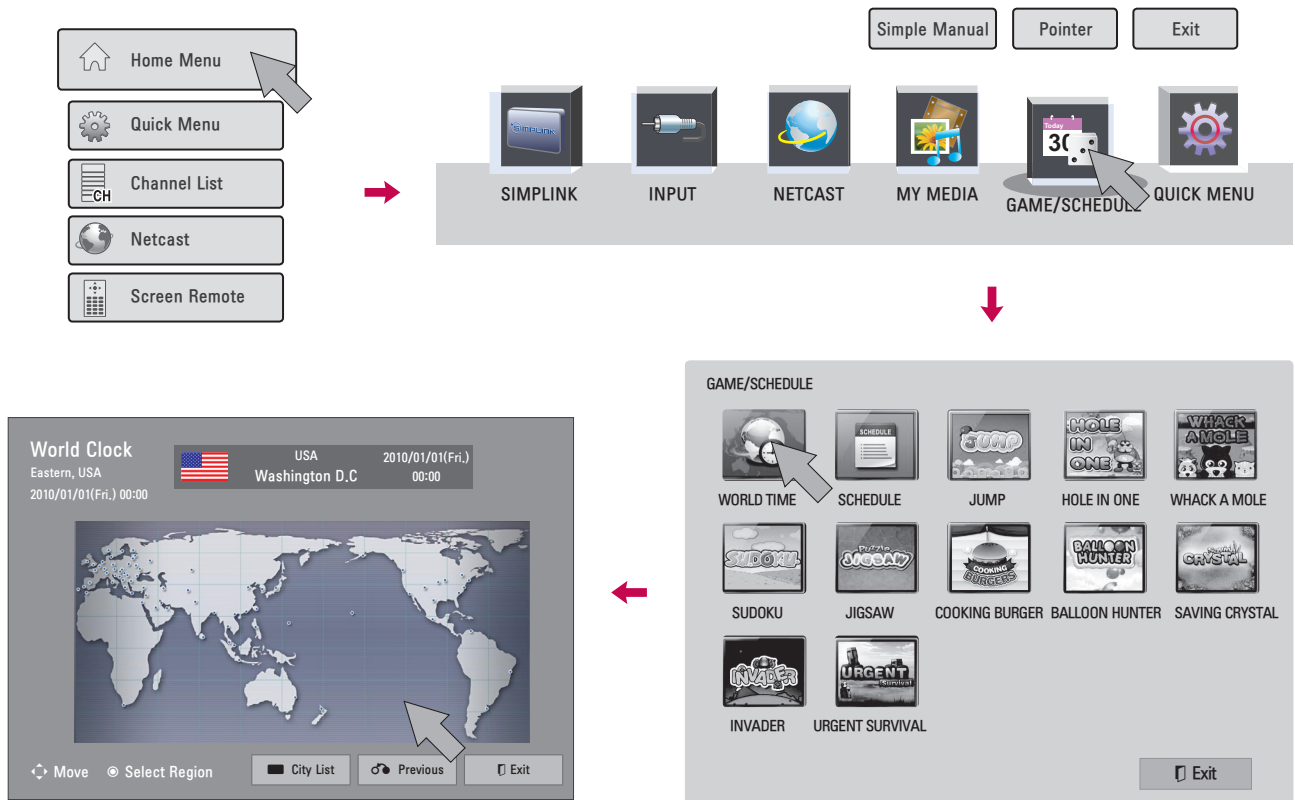





- 1 Select **Home Menu**.
- 2 Select **GAME/SCHEDULE**.
- 3 Select **WORLD TIME**.
- 4 Select a desired city.  
You can check the world time.
- 5 Select **Exit**.

■ The day light saving is not shown at the world clock.

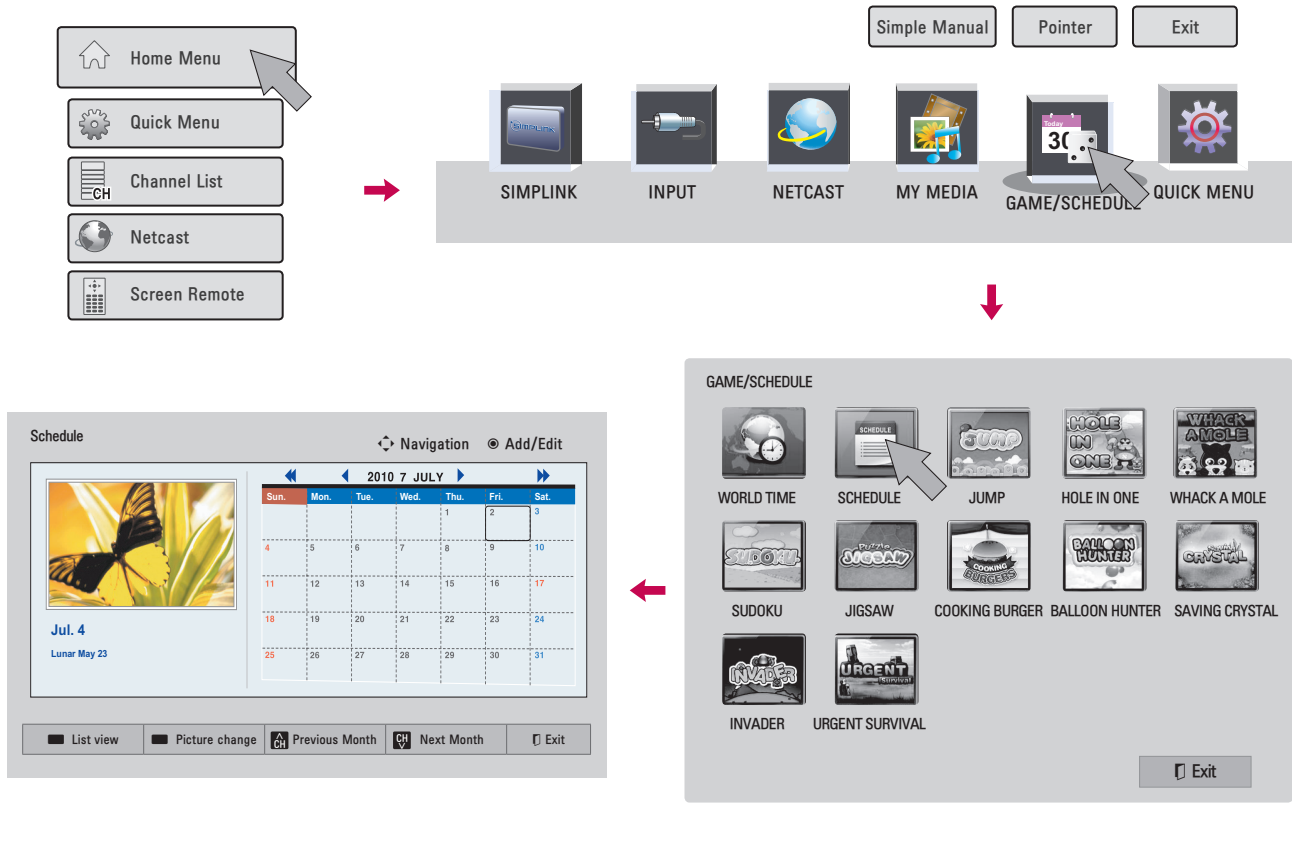
## Schedule

This function operates only if the current time has been set.

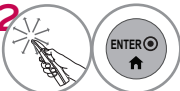
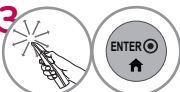







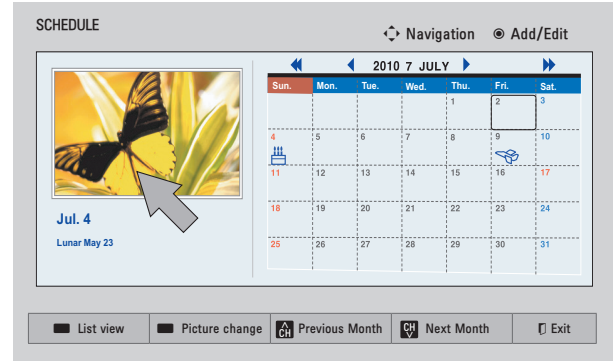
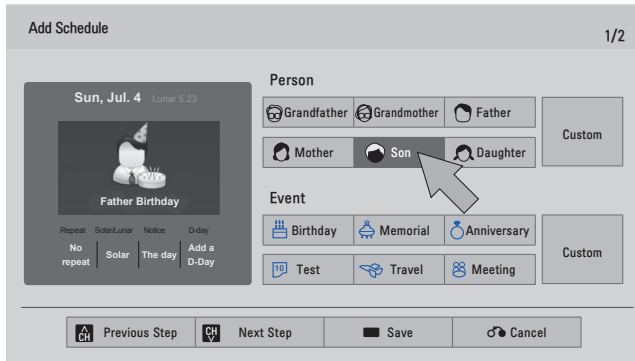

- 1  Select **Home Menu**.
- 2  Select **GAME/SCHEDULE**.
- 3  Select **Schedule**.
- 4  Select a desired date.  
You can check the schedule.

# WATCHING TV / CHANNEL CONTROL

## Schedule Registration

i.e)







- 5   Select the desired menu option.
- 6   The icon is displayed.
- 7   Select **List View** to use schedule.
- 8   Select **Exit**.

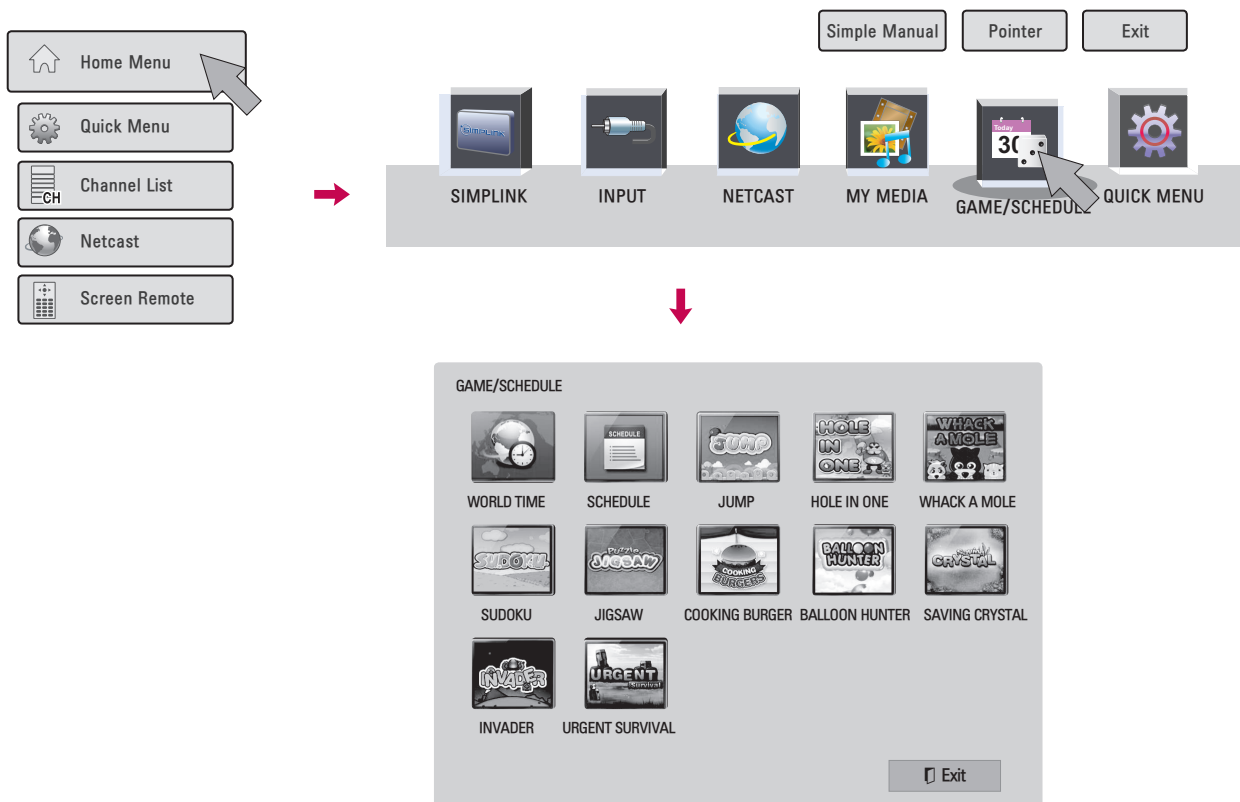

## Game

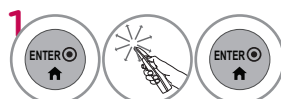
Allows you to enjoy the games installed on the TV.



-  Select **Home Menu**.
-  Select **GAME/SCHEDULE**.
-  Enter the selected game mode.
-  Select **Exit**.





# WATCHING TV / CHANNEL CONTROL

## SIMPLINK

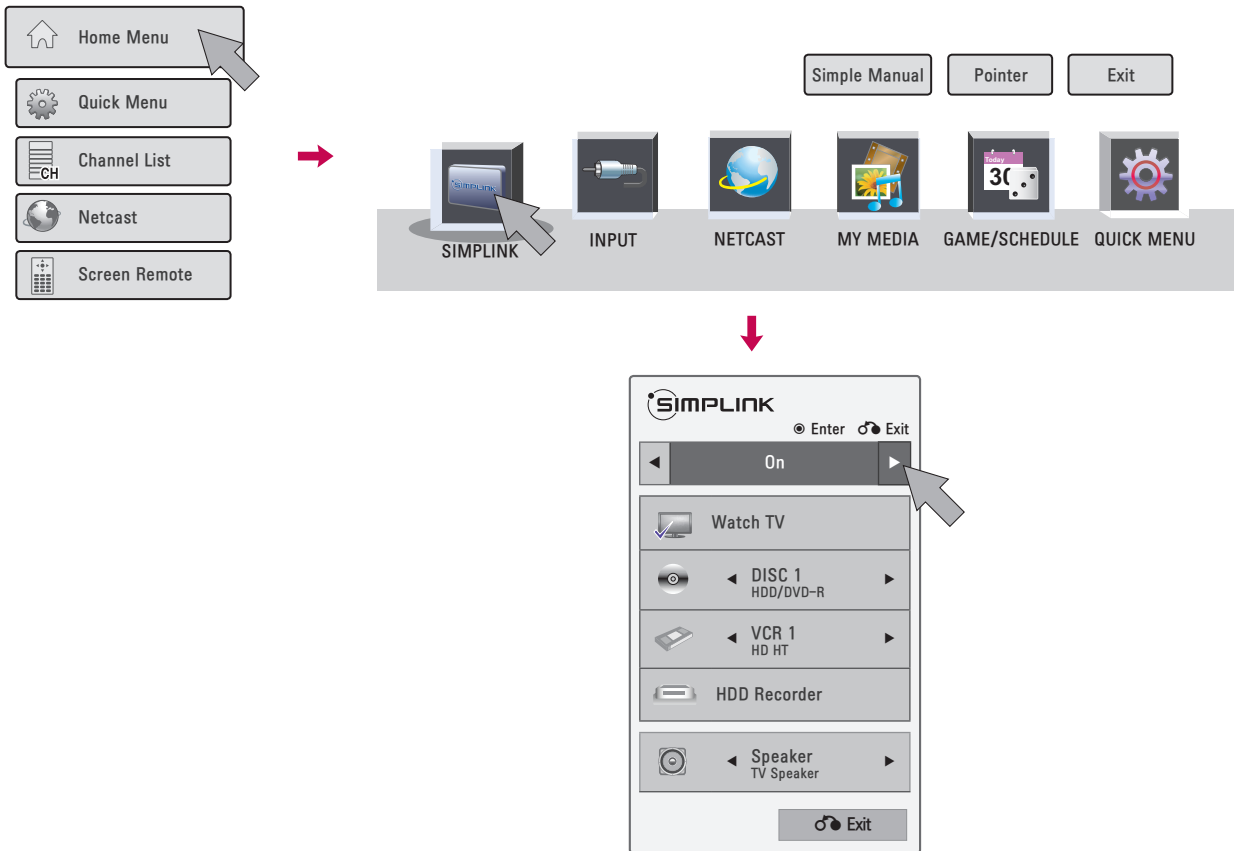
SIMPLINK allows you to control and play other AV devices connected with HDMI cable without additional cables and settings. This TV may work with devices with HDMI-CEC support, but only devices with the SIMPLINK logo are fully supported.

SIMPLINK can be turned on and off in the user menus.



-  Select **Home Menu**.
-  Select **SIMPLINK**.
-  Select **On**.
-  Select the desired device.
-  Control connected AV devices.

- 1 **TV viewing:** Switch to the previous TV channel regardless of the current mode.
- 2 **DISC playback:** Select and play discs. When multiple discs are available, the disc devices are conveniently displayed at the bottom of the screen.
- 3 **VCR playback:** Control the connected VCR.
- 4 **HDD Recordings playback:** Control recordings stored in HDD.
- 5 **Audio Out to Home Theater speaker/ Audio Out to TV:** Select Home Theater speaker or TV speaker for Audio Out.

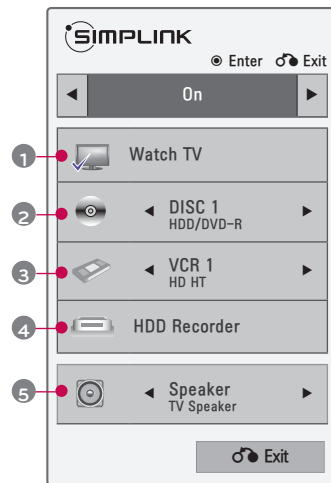

- ▶ When no device is connected (displayed in gray)
- ▶ Selected Device
- ▶ When a device is connected (displayed in bright color)

## SIMPLINK Functions

- **Direct Play:** After connecting AV devices to the TV, you can directly control the devices and play media without additional settings.
- **Select AV device:** Enables you to select one of the AV devices connected to the TV.
- **Disc playback:** Control connected AV devices by pressing the  $\wedge \vee \langle \rangle$ , **ENTER**,  $\blacktriangleright$ ,  $\blacksquare$ , **II**,  $\blacktriangleleft$  and  $\blacktriangleright$  buttons.
- **Power off all devices:** When you power off the TV, all connected devices are turned off.
- **Switch audio-out:** Offers an easy way to switch audio-out.
- **Sync Power on:** When the equipment with Simplink function connected HDMI terminal starts to play, The TV will automatically turn on.

Note: To operate SIMPLINK, an High Speed HDMI cable with \*CEC function should be used. (\*CEC: Consumer Electronics Control).

(A device, which is connected to the TV through a HDMI cable but does not support SIMPLINK, does not provide this function)

### NOTE

- ▶ Connect the HDMI/DVI IN or HDMI IN terminal of the TV to the rear terminal (HDMI terminal) of the SIMPLINK device with the HDMI cable
- ▶ When you switch the Input source with the INPUT button on the remote control, the SIMPLINK device will stop.
- ▶ When you select a device with home theater functionality, the sound output automatically switches to the home theater speakers and the TV speakers are turned off.
- ▶ If a connected SIMPLINK home theater system doesn't play the audio from the TV, connect the DIGITAL AUDIO OUT terminal on the back of the TV to the DIGITAL AUDIO IN terminal on the back of the SIMPLINK device with an OPTICAL cable.

# 3D IMAGING (FOR LED LCD TV, 50/60PX950)

## 3D TECHNOLOGY

This TV can display in 3D via 3D broadcasting or when the TV is connected to a compatible device, such as a Blu-ray 3D Player. You need such a device to watch the TV in 3D. The 3D TV displays two separate pictures formatted for each eye. The viewer needs to wear 3D glasses in order to see these images in 3D format.

## Viewing 3D Imaging

### ⚠ WARNING

- ▶ When viewing 3D imaging, watch the TV from an effective viewing angle and within the appropriate distance. The appropriate angle and distance are provided on the next page of this manual. If you exceed this viewing angle or distance, you may not be able to view the 3D imaging. Furthermore, the 3D imaging may not display if it is viewed while you are lying down (For LED LCD TV).
- ▶ If you watch the 3D imaging too closely or for a long period of time, it may harm your eyesight.
- ▶ Watching the TV or playing video games that incorporate 3D imaging with the 3D glasses for a long period of time can cause drowsiness, headaches or fatigue to you and/or your eyes. If you have a headache, or otherwise feel fatigued or drowsy, stop watching the TV and take a rest.
- ▶ Pregnant woman, seniors, persons with heart problems or persons who experience frequent drowsiness should refrain from watching 3D TV.
- ▶ Some 3D imaging may cause you to duck or dodge the image displayed in the video. Therefore, it is best if you do not watch 3D TV near fragile objects or near any objects that can be knocked over easily.
- ▶ Please prevent children under the age of 5 from watching 3D TV. It may affect their vision development.
- ▶ Warning for photosensitization seizure: Some viewers may experience a seizure or epilepsy when exposed to certain factors, including flashing lights or images in TV or video games. If you or anybody from your family has a history of epilepsy or seizure, please consult with your

doctor before watching 3D TV.

Also certain symptoms can occur in unspecified conditions without any previous history. If you experience any of the following symptoms, immediately stop watching the 3D imaging and consult a doctor: dizziness or lightheadedness, visual transition or altered vision, visual or facial instability, such as eye or muscle twitching, unconscious action, convulsion, loss of conscience, confusion or disorientation, loss of directional sense, cramps, or nausea. Parents should monitor their children, including teenagers, for these symptoms as they may be more sensitive to the effects of watching 3D TV.

Risk of photosensitization seizure can be reduced with the following actions.

- Take frequent breaks from watching 3D TV.
- For those who have vision that is different in each eye, they should watch the TV after taking vision correction measures.
- Watch the TV so that your eyes are on the same level as the 3D screen and refrain from sitting too closely to the TV
- Do not watch the 3D imaging when tired or sick, and avoid watching the 3D imaging for a long period of time.
- Do not wear the 3D glasses for any other purpose than viewing 3D imaging on a 3D TV.
- Some viewers may feel disoriented after watching 3D TV. Therefore, after you watch 3D TV, take a moment to regain awareness of your situation before moving.

### ⓘ NOTE

- ▶ To watch the TV in 3D, you must put on your 3D glasses. For best results, you should wear LG Brand 3D glasses. The 3D imaging may not display properly when using another brand of 3D glasses. Please see the 3D glasses manual for instructions on how to use the 3D glasses.
- ▶ After powering on the TV, a few seconds may be needed for your TV to calibrate.
- ▶ It may take a moment for you to see the 3D imaging if you look away from the TV and then revert your eyes back to the 3D program.
- ▶ The TV may flicker slightly if the 3D imaging is displayed under 3 wavelength fluorescent light (50 Hz - 60 Hz) or magnetic fluorescent lamp (50Hz - 60 Hz). In such instances, it is recommended to turn the lights off.
- ▶ If there is an obstacle between the TV and the 3D glasses, the 3D imaging may not display properly.
- ▶ Do not use the TV in close proximity to other electronic equipments and IR equipments.
- ▶ In Analog TV, 3D Imaging does not work.
- ▶ When watching 2D images, it is recommended to take off the 3D glasses. If you watch 2D images with the 3D glasses on, you may see distorted images.

## When using 3D Glasses

### ! CAUTION

- ▶ Refer to the 3D glasses manual for operating instructions.
- ▶ Do not use the 3D glasses to replace your corrective glasses, sunglasses or protective goggles.
- ▶ Do not store the 3D glasses in hot or cold locations.
- ▶ Do not drop objects onto the 3D glasses. Do not drop or bend the glasses.
- ▶ Since the lenses of the 3D glasses are easily scratched, make sure to clean only with a soft cloth. Shake off any dust before using the cloth since the glasses are easily scratched.

## 3D Imaging viewing range

TV size, viewing angle & other circumstances may change the viewing distance and the angle of view.

Viewing Distance	2 m - 7 m (6.5 ft - 22.9 ft)
Viewing Angle	120° (When the viewing distance is 2 m (6.5 ft))

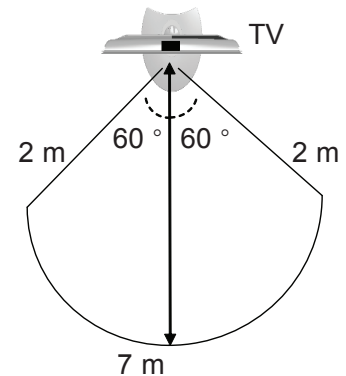



# 3D IMAGING

## WATCHING 3D IMAGING



- 1 Play the video produced in 3D.  
Refer to the following for the supported imaging.

	Signal	Resolution	Horizontal Frequency (kHz)	Vertical Frequency (Hz)	Playable 3D video format
HDMI Input	720p	1280x720	45.00	60	Top & Bottom, Side by Side HDMI (V. 1.4 with HDMI 3D) Frame Packing
	1080i		33.75		Top & Bottom, Side by Side
	1080p	1920x1080	67.50	24	Top & Bottom, Side by Side, Checker Board Single Frame Sequential
			27.00		Top & Bottom, Side by Side, Checker Board HDMI (V. 1.4 with HDMI 3D) Frame Packing
			33.75		30
USB Input	1080p	1920x1080	33.75	30	Top & Bottom, Side by Side Checker Board, MPO (Photo)
Component (For Plasma TV)	720p	1280x720	45.00	60	Top & Bottom, Side by Side
	1080i	1920x1080	33.75	60	
Signal					Playable 3D video format
DTV	720p, 1080i				Top & Bottom, Side by Side

Media contents and a player need to support HDMI (V. 1.4 with HDMI 3D) Frame Packing to play in 3D. Video, which is input as HDMI (V. 1.4 with HDMI 3D) Frame Packing format, is switched into the 3D screen automatically.

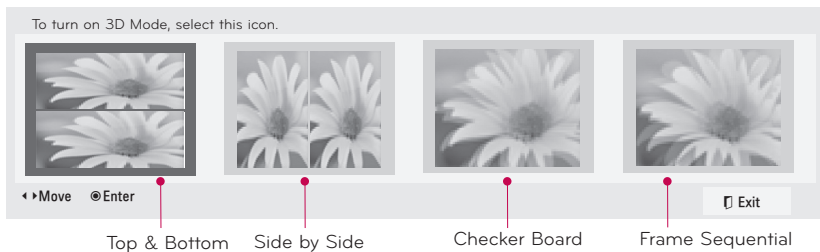
- 2    After selecting the shape as shown in the screen on TV, wear the 3D glasses.



- or    Select **3D video** or **2D video**.  
After selecting the shape as shown in the screen on TV, wear the 3D glasses.

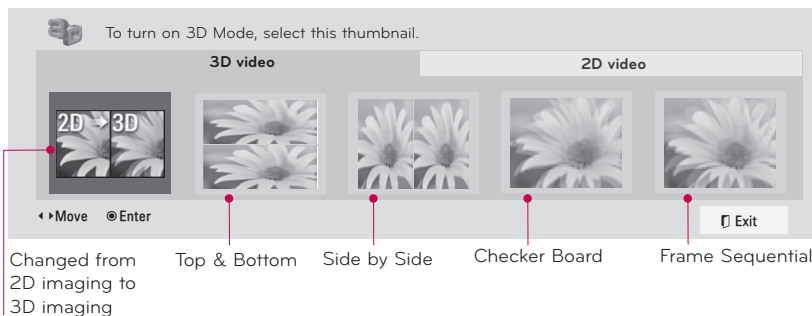



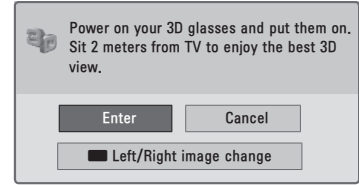
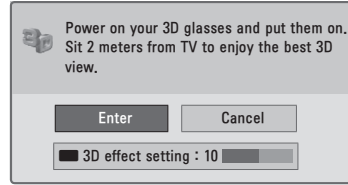

### \* For Plasma TV

- **3D video:** Select it to view the 3D imaging.
- **2D video:** Select it to view the 2D imaging.

**3**   or  Select **Setting Left/Right** or **Left/Right image change**.

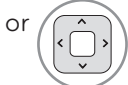

\* In case of this OSD (On Screen Display), you can adjust the **3D effect setting** with using  button.

**4**   or   Select **Left/Right** or **Right/Left**.  
Select the screen with 3D video with better visibility.

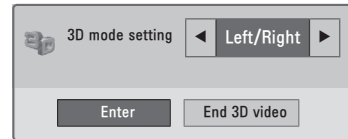
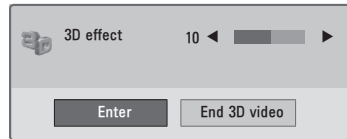
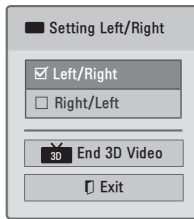

**5**  The 3D imaging mode is changed to the 2D imaging mode.

### NOTE

- ▶ Some menus may not work while watching the TV in 3D.
- ▶ The 3D imaging mode is disabled automatically when switching DTV channels.
- ▶ The screen may not be displayed properly if you view 2D DTV images in 3D imaging mode.
- ▶ 3D effect can be seen when 3D Mode is selected appropriately for the 3D input signal supplied to the TV.
- ▶ For \*.mpo files (3D camera files), the 3D imaging mode is enabled automatically.
- ▶ To enable the 3D imaging mode, you can also press the ENTER button on the Magic Motion remote control.

#### \* For LED LCD TV

- ▶ If you select 3D mode, "Power indicator" is turned off automatically.
- ▶ While watching 3D imaging, you cannot adjust video/audio settings using the menu.
- ▶ You can only choose "Standard → Cinema → Game" with the **AV MODE** button on remote control. **AV Mode** is set as **Standard** while playing in 3D.
- ▶ Energy Saving is disabled while playing in 3D.
- ▶ If you'd like to play the BGM using \*.mpo file(3D camera file), In advance, the contents path for BGM should be set on full-sized photo view screen which isn't \*.mpo file(3D camera file).

### NOTES FOR VIEWING 3D IMAGE WITH 3D BROADCASTING (\* In Analog TV, 3D Imaging does not work.)

When switching the 2D image display to the 3D image display with the **3D** button on the remote control, the overlapped image may be displayed.

- Disable the 3D imaging mode with the 3D button.
- The 3D imaging mode is disabled automatically if you change the channel.

If the screen is divided into left/right or top/bottom when you change the channel

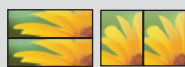

- This channel supports the 3D imaging mode. Select the 3D imaging type displayed on the screen by pressing the 3D button on the remote control.

If your eyes are soaring or the screen looks blurry while viewing 3D images

- Press the **L/R SELECT** button on the remote control and select L/R or R/L, which you find better for viewing 3D images.

# MY MEDIA

## ENTRY MODE

The My Media menu will open automatically when you insert a USB drive. My Media can also be accessed by choosing My Media in the user menu.

After choosing the desired type of media, choose a device to open files from. The options are: USB device, or DLNA.

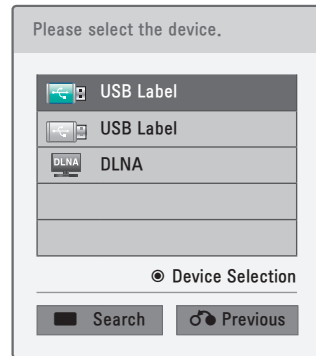
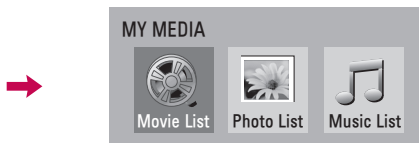
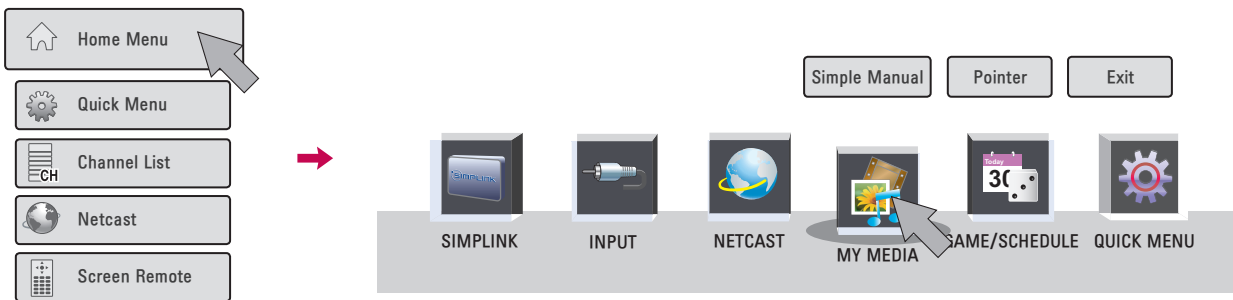

- 1 Select **Home Menu**.
  - 2 Select **MY MEDIA**.
  - 3 Select **Movie List, Photo List** or **Music List**.
  - 4 Select the desired device.
- Search other network device.

■ This TV can view JPG image files, HD DivX files and play MP3 audio files.

- ### When removing the USB device
- Select the **USB Device** menu before removing the USB device.
- 1 Select **Quick Menu**.
  - 2 Select **USB device**.
  - 3 Select **Eject**.



# CONNECTION METHOD

## USB Connection

- 1 Connect the USB device to the **USB IN** jack on the side of TV.

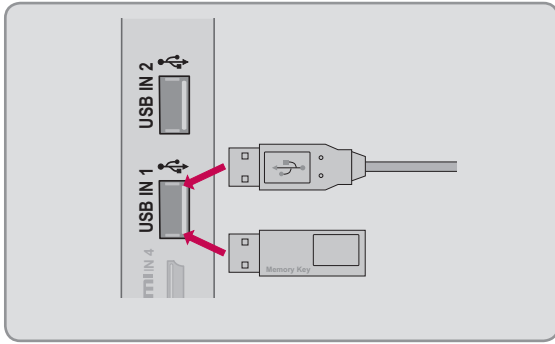

### Precautions when using the USB device

- ▶ Only a USB storage device is recognizable.
- ▶ Connecting a USB storage device through a USB hub is not supported.
- ▶ A USB storage device which uses its own driver may not be recognized.
- ▶ The recognition speed of a USB storage device may depend on each device.
- ▶ Please do not turn off the TV or unplug the USB device when the connected USB storage device is working. When such device is suddenly separated or unplugged, the stored files or the USB storage device may be damaged.
- ▶ Only use a USB storage device which has normal music files, image files, or movie files.
- ▶ Please use only a USB storage device which was formatted as a FAT 32 or NTFS file system provided with the Windows operating system. Others may not be recognized.
- ▶ Some USB storage devices require a power adapter. The power adapter must be connected in order to be seen by the TV.
- ▶ If a device is not recognized by the TV, try a different cable. Excessively long cables are not supported.
- ▶ Some USB storage devices may not be supported or operate properly.
- ▶ Please backup important files because data on USB device could be damaged. Data management is consumer's responsibility and as a result, the manufacturer does not cover data damage.
- ▶ If your USB memory device has multiple partitions, or if you use a USB multi-card reader, you can use up to 4 partitions or USB memory devices.
- ▶ File alignment method of USB storage device is similar to Window XP and file names can be up to 100 English characters.
- ▶ The recommended capacity is 1 TB or less for a USB external hard disk and 32 GB or less for USB memory.
- ▶ If a USB external hard disk with a "Energy Saving" function doesn't work, turn the hard disk off and on again to make it work properly. Refer to the user manual of the USB external hard disk.
- ▶ USB storage devices below USB 2.0 are supported as well. But they may not work properly in the movie list.
- ▶ Maximum of 999 folders or files can be recognized under one folder.
- ▶ If there are too many folders and files in one folder, it may not operate properly.

## DLNA

### About DLNA

This TV can display and play many types of movie, photo and music files from your DLNA server and has been certified by DLNA for photos.

The **Digital Living Network Alliance (DLNA)** is a cross-industry organization of consumer electronics, computing industry and mobile device companies. Digital Living provides consumers with easy sharing of digital media through a wired or wireless network in the home.

The DLNA certification logo makes it easy to find products that comply with the DLNA Interoperability Guidelines. This unit complies with DLNA Interoperability Guidelines v1.5. When a PC running DLNA server software or other DLNA compatible device is connected to this TV, some setting changes of software or other devices may be required. Please refer to the operating instructions for the software or device for more information.

Please refer to pages 99 ~ 121 for additional information on supported file types and other instructions.

#### NOTE

- ▶ The supplied Nero MediaHome 4 Essentials CD-ROM is a customized software edition only for sharing files and folders to this TV.
- ▶ The supplied Nero MediaHome 4 Essentials software does not support following functions: Transcoding, Remote UI, TV control, Internet services and Apple iTunes
- ▶ This manual explains operations with the English version of Nero MediaHome 4 Essentials as examples. Follow the explanation referring to the actual operations of your language version.
- ▶ If there are too many folders and files in one folder, it may not operate properly.
- ▶ For the DLNA option, use the Nero MediaHome programme that is provided with the TV. However, we cannot guarantee that third party program will work perfectly.
- ▶ You can select a channel while viewing the small preview channel list on your TV screen.
- ▶ Check your network settings when the DLNA option does not work properly.
- ▶ If there is an abnormal operation or an error occurs in Nero Media Home, the DLNA option may not work properly. In this case, exit Nero Media Home and restart the programme. You can download the latest version of Nero Media Home by clicking the question mark at the bottom-left of the program.
- ▶ When the network is unstable, the device may be slower or may need to load during playback.
- ▶ When playing a video in DLNA mode, the Multi Audio and Closed Caption features are not supported.
- ▶ When selecting Full Screen in DLNA mode, the ratio of the outputted screen may differ from the original.
- ▶ When more than one TV is connected to a single server in DLNA mode, a file may not play properly, depending on the server performance.
- ▶ If the play time information is not provided by the server, it is displayed as "---:---:--."
- ▶ When using Movie List, DRM/\*:tp/\*:trp files in the DLNA server cannot be played.
- ▶ When using Photo List, \*.MPO files in the DLNA server cannot be played.
- ▶ DLNA operation may not work properly according to the AP manufacturers.

## Installing Nero MediaHome 4 Essentials

Nero MediaHome 4 Essentials is easy to use DLNA server software for Windows.

### Requirement PC system before you install Nero MediaHome 4 Essentials

- Windows® XP (Service Pack 2 or higher), Windows Vista® (no Service Pack required), Windows® XP Media Center Edition 2005 (Service Pack 2 or higher), Windows Server® 2003
- Windows Vista® 64-bit edition (application runs in 32-bit mode)
- Hard drive space: 200 MB hard drive space for a typical installation of Nero MediaHome stand-alone
- 1.2 GHz Intel® Pentium® III or AMD Sempron™ 2200+ processors
- Memory: 256 MB RAM
- Graphics card with at least 32 MB video memory, minimum resolution of 800 x 600 pixels, and 16-bit color settings
- Windows® Internet Explorer® 6.0 or higher
- DirectX® 9.0c revision 30 (August 2006) or higher
- Network environment: 100 Mb Ethernet, WLAN (IEEE 802.11b/g/n)

- 1** Start up your computer, and insert the Nero MediaHome 4 Essentials CD-ROM into your computer's CD-ROM drive.  
An installation wizard will walk you through the quick and uncomplicated installation process.
- 2** Close all Microsoft Windows programs and exit any anti-virus software that may be running.
- 3** Insert the Nero MediaHome 4 Essentials CD-ROM into your computer's CD-ROM drive.
- 4** Click **Nero MediaHome 4 Essentials**. The installation is prepared and the installation wizard appears.
- 5** Click the **Next** button to display the serial number input screen.  
Click **Next** to go to the next step.
- 6** If you accept all conditions, click **I accept the License Conditions** check box and click **Next**.  
Installation is not possible without this agreement.
- 7** Click **Typical** and click **Next**. The installation process is started.
- 8** If you want to take part in the anonymous collection of data, select the check box and click the **Next** button.
- 9** Click the **Exit** button to complete the installation.

## Sharing files and folders

After installing Nero MediaHome, you must add folders you wish to share.

- 1 Double-click the **Nero MediaHome 4 Essentials** icon on the desktop.
- 2 Click **Network** icon on the left and define your network name in the **Network name** field. The Network name you enter will be recognized by your TV.
- 3 Click **Shares** icon on the left.
- 4 Click **Local Folders** tab on the **Shared** screen.
- 5 Click **Add** icon to open the **Browse Folder** window.
- 6 Select the folder containing the files you want to share. The selected folder is added to the list of shared folders.
- 7 Click **Start Server** icon to start the server.

### NOTE

- ▶ If the shared folders or files are not displayed on the TV, click the folder on the **Local Folders** tab and click **Rescan Folder** at the **More** button.
- ▶ Visit [www.nero.com](http://www.nero.com) for more information and software tools.

## Playing back shared contents



You can display and play movie, photo and music content stored on your computer or other DLNA media servers.

1 Start the server on your computer or other device that connected on your home network.

2   Select **MY MEDIA**.

3   Select **Movie List**, **Photo List** or **Music List**.

Select the DLNA.

4   Depending on the media server, this TV may need to get the permission from the server.

If you want to re-scan available media server, press blue color button.

### NOTE

- ▶ To play the file on the media server, the TV and the media server must be connected to the same access point.
- ▶ Because the compatibility and available playback functions on the **MY MEDIA** menu are tested on the bundle DLNA server (Nero MediaHome 4 Essentials) environment, file requirements and playback functions on the **MY MEDIA** may differ depending on media servers.
- ▶ The file requirements on this page are not always compatible. There may have some restrictions by file features and media server's ability.
- ▶ Even the files that are not supported can be displayed in photo thumbnail or music thumbnail.
- ▶ Movie thumbnail is not supported in DLNA Movie.
- ▶ If there is an unplayable music file in the **MY MEDIA** menu, the TV will skip the file and play next file.
- ▶ The file information indicated on the screen may not always correct for music and movie files in **MY MEDIA** menu
  - ▶ This TV only supports movie subtitle files supplied by Nero MediaHome 4.
  - ▶ The subtitle file name and movie file name have to be the same and located at the same folder.
  - ▶ If subtitle files have been added after a directory has been indexed already, the user has to remove and re-add the folder to the list of shares.
- ▶ The playback and operating quality of the **MY MEDIA** function may be affected by your home network condition.
- ▶ The files from removable media such as USB drive, DVD-drive etc. on your media server may not share properly.
- ▶ When playing the Media through DLNA connection, it does not support the DivX file play which is protected by DRM.
- ▶ Up to 200 folders in one folder and 999 including folders and files can be recognized.
- ▶ If there are too many folders and files in one folder, it may not operate properly.

## MOVIE LIST

It displays all of the video files it recognizes.

The On-Screen Display on your model may be slightly different.

### Supported movie file

- Resolution: under 1920 pixel (width) x 1080 pixel (height)
- Frame Rate: under 30 frame/sec (1920x1080), under 60 frame/sec (1280x720)
- Max bitrate of playable video file: 20 Mbps (Mega bit per second)
- Bit rate of audio format: within 32 kbps to 320 kbps (MP3)
- Supported external subtitle format: \*.smi/\*.srt/\*.sub(MicroDVD,Subviewer1.0/2.0)/\*.ass/\*.ssa/\*.txt(TMPlayer)/\*.psb(PowerDivX)
- Supported Internal subtitle format: only XSUB (It is the subtitle format used in DivX6 files)

### Precautions when playing the video files

- ▶ Some user-created subtitles may not work properly.
- ▶ Some special characters are not supported in subtitles.
- ▶ HTML tags are not supported in subtitles.
- ▶ Time information in an external subtitle file should be arranged in ascending order to be played.
- ▶ Changing font and color in subtitles is not supported.
- ▶ Subtitles in languages other than one specified are not supported.
- ▶ Video files with subtitle files of 1 MB or larger may not be played properly.
- ▶ The screen may suffer temporary interruptions (image stoppage, faster playback, etc.) when the audio language is changed.
- ▶ A damaged video file may not be played correctly, or some functions may not be usable.
- ▶ Video files produced with some encoders may not be played correctly.
- ▶ If the video and audio structure of recorded file is not interleaved, the file not playback properly.
- ▶ Video with resolution higher than maximum resolution supported for each frame, cannot be guaranteed for smooth playback.
- ▶ Video files other than the specified types and formats may not work properly.
- ▶ The movie file encoded by the GMC (Global Motion Compensation) and Qpel (Quarterpel Motion Estimation) is not supported.
- ▶ Only 10000 sync blocks are supported within the subtitle file.
- ▶ We do not guarantee smooth playback of profiles encoded level 4.1 or higher in H.264/AVC.
- ▶ DTS Audio codec is not supported.
- ▶ A video file more than 30GB in file size is not supported for playback.
- ▶ Playing a video via a USB connection that doesn't support high speed may not work properly.
- ▶ USB storage devices below USB 2.0 are supported as well. But they may not work properly in the movie list.
- ▶ The video file and its subtitle file must be located in the same folder.  
At this time, a video file name and its subtitle file name must be identical for it to be displayed.
- ▶ When you are watching a movie via the Movie List function, you can adjust the picture with the ENERGY SAVING and AV MODE button on the remote control. User setup for each picture mode is not supported.
- ▶ Trick Mode does not support other functions than ►► if video files do not have index information.
- ▶ When playing video file using network, the Trick mode is limited to 2-times speed.
- ▶ Video file names that contain special characters may not be playable.

# Supported Video Formats

File Extensions	Audio/Video	Codec	Profile/Level Support	Explanation
.asf .wmv	Video	VC-1 Advanced Profile	Advanced Profile@Level 3 (e.g. 720p60, 1080i60, 1080p30)	Only streams compliant to SMPTE 421M VC-1 standard are supported.
		VC-1 Simple and Main Profiles	Simple Profile@Medium Level (e.g. CIF, QVGA) Main Profile@High Level (e.g. 1080p30)	
	Audio	WMA Standard		
		WMA 9 Professional		
.divx .avi	Video	DivX3.11	Advanced Simple Profile (e.g. 720p/1080i)	Global motion compensation or quarterpel motion estimation does not supported. Streams using this syntax are not supported.
		DivX4 DivX5 DivX6 XViD		
	Audio	H.264 / AVC	Main Profile@ Level 4.1 High Profile@ Level 4.1 (e.g. 720p60, 1080i60, 1080p30)	
		MPEG-1 Layer I, II MPEG-1 Layer III (MP3) Dolby Digital		
.mp4 .m4v	Video	H.264 / AVC	Main Profile@ Level 4.1 High Profile@ Level 4.1 (e.g. 720p60, 1080i60, 1080p30)	Global motion compensation or quarterpel motion estimation does not supported. Streams using this syntax are not supported.
		MPEG-4 Part 2	Advanced Simple Profile (e.g. 720p/1080i)	
	Audio	AAC	AAC-LC and HE-AAC	
.mkv	Video	H.264 / AVC	Main Profile@ Level 4.1 High Profile@ Level 4.1 (e.g. 720p60, 1080i60, 1080p30)	Most of the MKV content available is encoded by the open source x264 codec.
		AAC Dolby Digital	AAC-LC and HE-AAC	
	Audio	MPEG-1 Layer I, II MPEG-1 Layer III (MP3) Dolby Digital		
		AAC		
.ts .trp .tp	Video	H.264 / AVC	Main Profile@ Level 4.1 High Profile@ Level 4.1 (e.g. 720p60, 1080i60, 1080p30)	Only streams compliant to SMPTE 421M VC-1 standard are supported.
		MPEG-2	Main Profile@High Level(e.g. 720p60, 1080i60)	
	Audio	VC-1	Simple Profile@Medium Level (e.g. CIF, QVGA) Main Profile@High Level (e.g. 1080p30) Advanced Profile@Level3 (e.g. 720p60, 1080i60, 1080p30)	
		MPEG-1 Layer I, II MPEG-1 Layer III (MP3) Dolby Digital		
	Video	AAC	AAC-LC and HE-AAC	
		MPEG-1		
.vob	Audio	MPEG-2	Main Profile@High Level (e.g. 720p60, 1080i60)	
		Dolby Digital MPEG-1 Layer I, II DVD-LPCM		
.mpg	Video	MPEG-1	Main Profile@High Level (e.g. 720p60, 1080i60)	Only streams compliant configured properly for TS, PS or ES
		Audio	MPEG-1 Layer I, II	

# MY MEDIA

## Screen Components



- 1 Moves to upper level folder
- 2 Current page/Total pages
- 3 Current page/ total pages of contents
- 4 Contents under the folder focused on 1
- 5 Change to a different input.
- 6 Move to **Photo List** or **Music List**.
- 7 Changes the number or thumbnails displayed at a time.
- 8 Allows you to mark certain files.
- 9 Return to TV viewing.

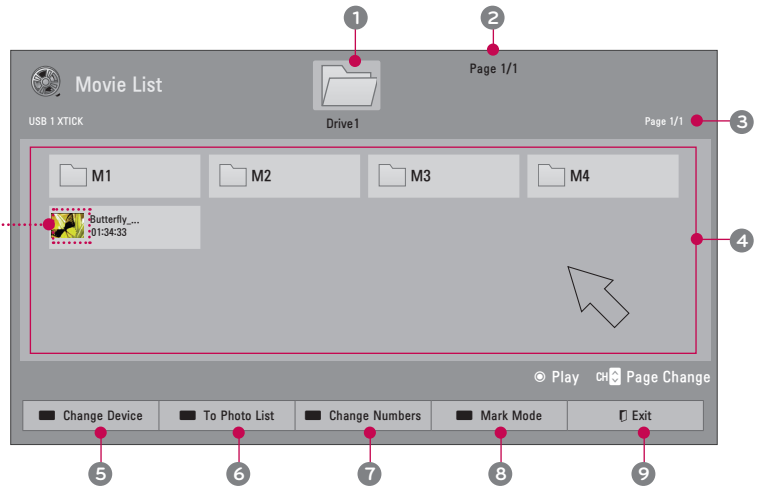

Abnormal files are displayed using this graphic.







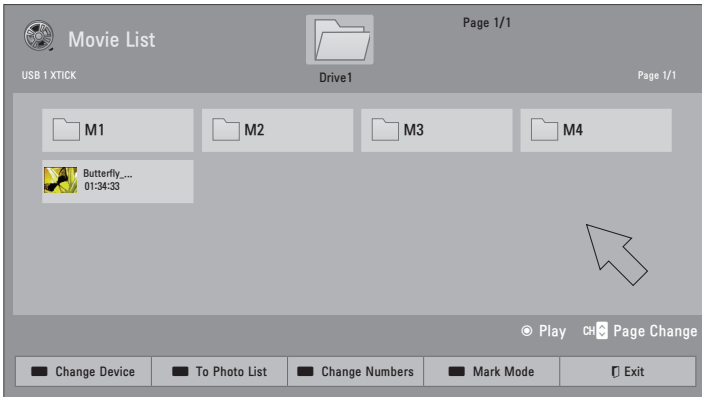

Non-supported files are displayed using this graphic.



## Movie Selection



- 1   Select the target folder or drive.
- 2   Select the desired movie title.
- 3   Play the movie file.

## Mark Mode

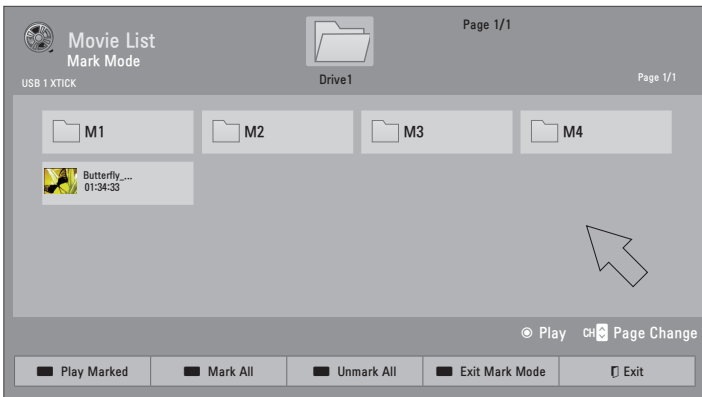

- 1   Select the target folder or drive.
- 2   Select **Mark Mode**.
- 3   Select the desired movie title.
- 4   Select **Play Marked**.  
Play the marked movie file.

It displays the current movie status progress bar on the bottom of the screen.

<b>Play Marked</b>	Play the first selected file. Once a movie finishes playing, the next selected one will be played automatically.
<b>Mark All</b>	Mark all files in the folder.
<b>Unmark All</b>	Deselect all marked files.
<b>Exit Mark Mode</b>	Enter or exit the Mark Mode.

■ When one or more movie files are marked, the marked movies will be played in sequence.

# MY MEDIA

## Playing the Movie

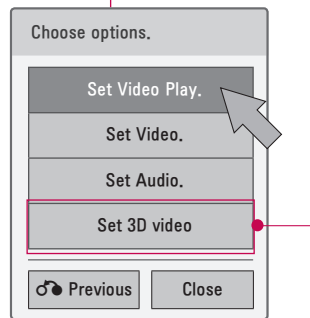

For LED LCD TV,  
50/60PX950

- 1 ■ Stop playback.
  - ▶ Return to normal playback.
  - || Paused playback. If no buttons are pressed on the remote control for 10 minutes after pausing, the TV returns to the playback state.
  - ◀▶ Select the required speed: x2, x4, x8, x16, x32 (backward/forward).
- 2 Increase or decrease the brightness of your screen.
- 3 Hide the menu on screen. To see the menu again, press **ENTER** button.
- 4 Return to the previous menu.



Show the **Option** menu.

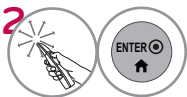





Select the desired menu option.

### NOTE

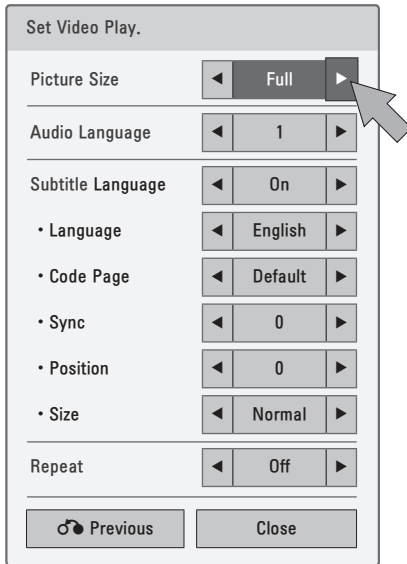
- ▶ When replaying a video file after stopping, you can play from where it stopped automatically.
- ▶ If you select "Yes" when playing the same file after the video file has been stopped, it will restart where it stopped previously.
- ▶ If continuous series files exist within the folder, the next file will automatically be played. But, this excludes cases when the Repeat function of Movie List Option is turned "On" (Refer to page 107) or when set as Marked Play.

## Set Video Play Menu Options



- 1   Select the desired menu option.
- 2   Make appropriate adjustments.

### Code Page

Subtitle Language Group	Supported Language
Latin1	English, Spanish, French
Korean	English, Korean

- **Picture Size:** Selects your desired picture format for videos.
  - **Full Mode:** Files are played in full screen mode regardless of the aspect ratio of video.
  - **Original Mode:** Files are played according to the aspect ratio of video.
- **Audio Language:** Changes the Language Group of the audio for video files. Files with a single audio track cannot be selected.
- **Subtitle Language:** The subtitles can be turned on or off.
- **Language:** Activated for SMI subtitles and can select the language within the subtitle.
- **Code Page:** Subtitle font selection. When set to default, contents are displayed in the language set in "Option - Language - Menu Language."
- **Sync:** When the video is not synchronized with the captions, it can be adjusted by 0.5 second.
- **Position:** Move the location of the subtitles.
- **Size:** Changes the subtitle font size.
- **Repeat:** Turn on/off repeat function of movie playback. When turned on, the file within the folder will be played back repeatedly. When turned off, if the next file name is similar to the previous file, it can be played sequentially.

# MY MEDIA

\* Image shown may differ from your TV.

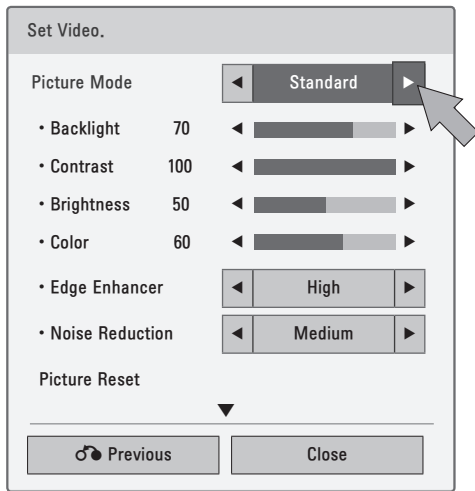

## Set Video Menu Options

For LED LCD TV



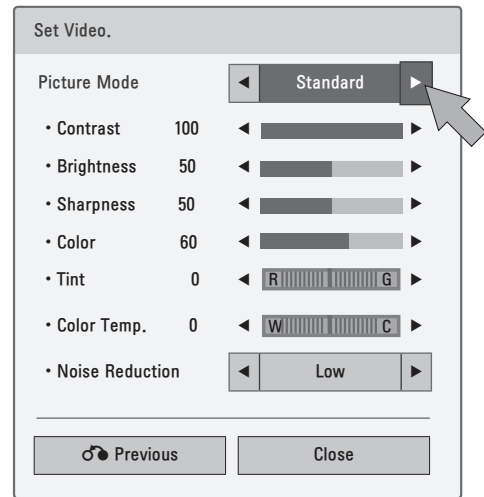

For Plasma TV

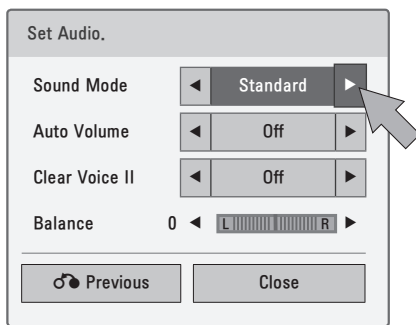

1   Make appropriate adjustments. Then, select **Close**.

## Set Audio Menu Options



1   Make appropriate adjustments. Then, select **Close**.

## Set 3D video Menu Options (For LED LCD TV, 50/60PX950

i.e)

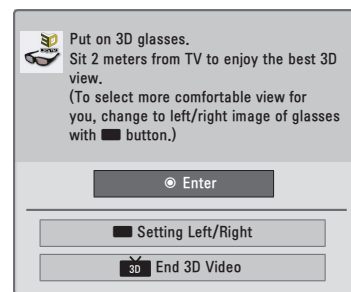

 For more information, see the 3D Imaging section in the Owner's Manual.

# PHOTO LIST

The On-Screen Display on your model may be slightly different.

## Supported photo file: \*.JPG

- Baseline: 64 pixel (width) x 64 pixel (height) to 15360 pixel (width) x 8640 pixel (height)
- Progressive: 64 pixel (width) x 64 pixel (height) to 1920 pixel (width) x 1440 pixel (height)
- You can play JPEG files only.
- Non-supported files are displayed in the form of predefined icon.
- An error message occurs for corrupted files or file formats that cannot be played.
- Corrupted image files may not be displayed properly.
- It may take some time to view high-resolution images in full screen.

For 47/55LX9500, 50/60X950

	File Extensions	Item	Profile
2D	jpeg jpg jpe	supported file format	SOFO: baseline SOF1: Extend Sequential SOF2: Progressive
		photo size	Min: 64 x 64 Max - Normal Type: 15360 (W) x 8640 (H) Progressive Type: 1920 (W) x 1440 (H)
3D	mpo	supported file format	mpo
		photo size	4:3 size: 3648 x 2736 2592 x 1944 2048 x 1536 3:2 size: 3648 x 2432

## Screen Components

**1** Select **Home Menu**.

**2** Select **MY MEDIA**.

**3** Select **Photo List**.

**1** Moves to upper level folder

**2** Current page/Total pages

**3** Current page/total pages of contents

**4** Contents under the folder focused on **1**

**5** Change to a different input.

**6** Move to **Music List** or **Movie List**.

**7** Changes the number or thumbnails displayed at a time.

**8** Allows you to mark certain files.

**9** Return to TV viewing.





Abnormal files are displayed using this graphic.

Non-supported files are displayed using this graphic.

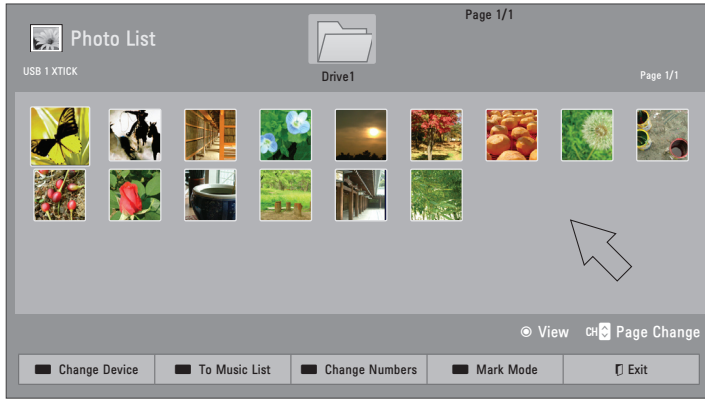
# MY MEDIA







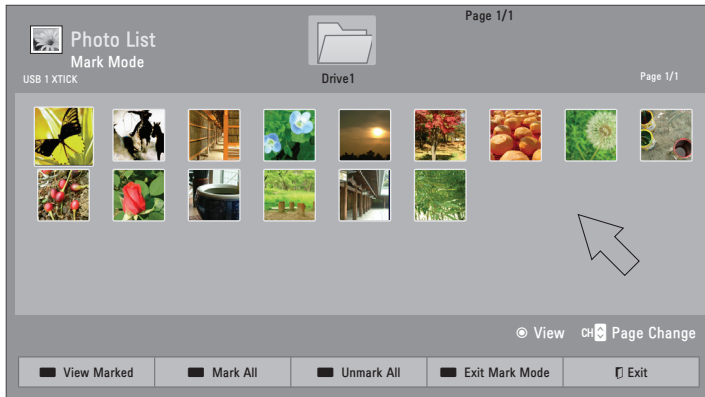

## Photo Selection



- 1   Select the target folder or drive.
- 2   Select the desired photos.
- 3  Photo file is displayed.

## Mark Mode



- 1   Select the target folder or drive.
- 2   Select **Mark Mode**.
- 3   Select the desired photo files.
- 4   Select **View Marked**. View the marked photo files.

<b>View Marked</b>	Display the selected photo.
<b>Mark All</b>	Mark all photos on the screen.
<b>Unmark All</b>	Deselect all marked photos.
<b>Exit Mark Mode</b>	Enter or exit the Mark Mode.



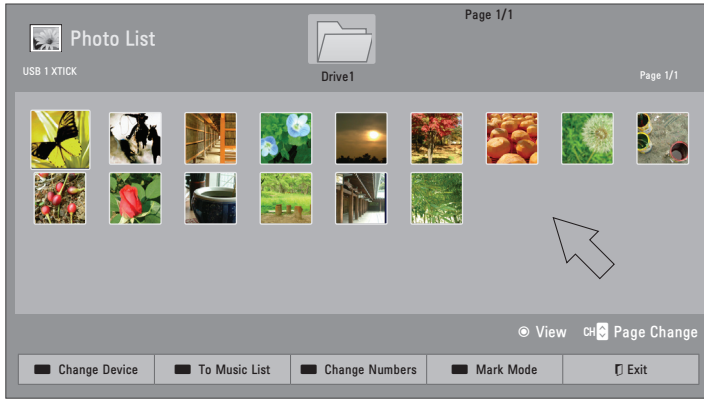

- When one or more photos are marked, you can view individual photos or a slide show of the marked photos. If no photos are marked, you can view all photos individually or all photos in the folder in a slide show.

## Full Screen Menu

More operations are available in full screen mode.



The aspect ratio of a photo may change the size of the photo displayed on the screen in full size.

-  Select the target folder or drive.
-   Select the desired photos.
-  The selected photo is displayed in full size.

# MY MEDIA



Select the **Slideshow**,

**BGM**, **U (Rotate)**, **[Full/Original]**, **e0 (Energy Saving)**, **Option**, or **Hide**.

- ▶ **Slideshow**: Selected photos are displayed during the slide show. If no photo is selected, all photos in the current folder are displayed during slide show.
  - Set the time interval of the slide show in **Option-Set Photo View** menu (Refer to p. 113).
  - You can adjust **Option** by using the **Q.MENU** button on the remote control.
- ▶ **BGM (Background Music)**: Listen to music while viewing photos in full size.
  - Set the BGM device and album in **Option-Set Photo View** menu (Refer to p. 113).
  - You can adjust **Option** by using the **Q.MENU** button on the remote control.
- ▶ **U (Rotate)**: Rotate photos.
  - Rotates the photo 90 °, 180 °, 270 °, 360 ° clockwise.
  - Photos cannot be rotated if its width is greater than the available supported resolution height.
- ▶ **[Full/Original]**: View the photo in full mode or original mode.
- ▶ **e0 (Energy Saving)**: Increase the brightness of your screen by using ENERGY SAVING button.
- ▶ **Option**: Set values for **Slide Speed** and **BGM** (Refer to p.113).
  - You cannot change **BGM** while BGM is playing.
  - You can only select the MP3 folder saved on the device that currently displays the photo.
- ▶ **Hide**: Hide the menu on the full-sized screen.
  - To see the menu again on the full-sized screen, press **ENTER** button to display.
- ▶ **Exit**: Move to the previous menu screen.



## Using the Photo List Function

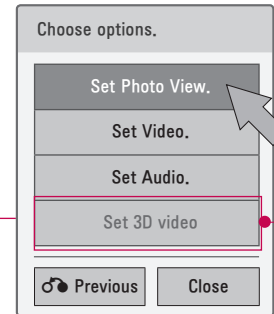

For LED LCD TV,  
50/60PX950

- 1 Show the **Option** menu.
- 2 Select the desired menu option.

### NOTE (For LED LCD TV)

- ▶ You cannot select the **Option** in 3D imaging mode.
- ▶ If you want to listen to BGM (background music) while viewing \*mpo image files, play a \*jpg file and set the BGM folder in "**Option - Set Photo View.**" Then, you can select and listen to BGM when viewing \*mpo files.

## Set Photo View Menu Options

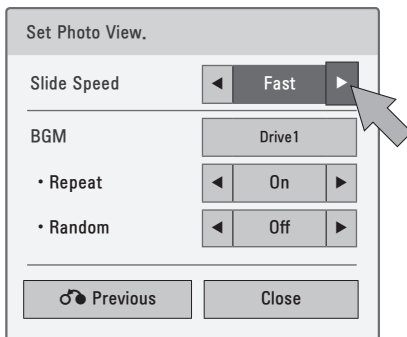

- 1 Select **Slide Speed** or **BGM**.
- 2 Make appropriate adjustments.

\* Image shown may differ from your TV.

## Set Video Menu Options

For LED LCD TV

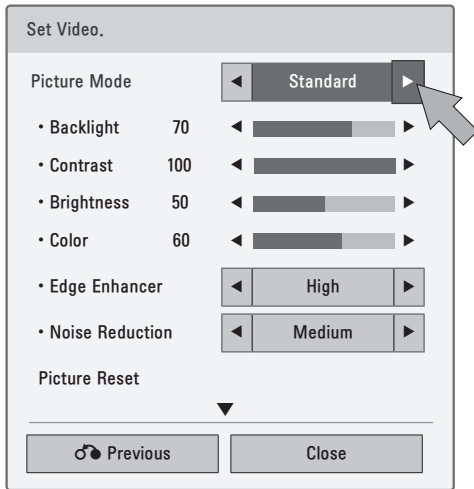

For Plasma TV

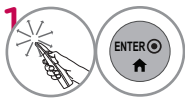
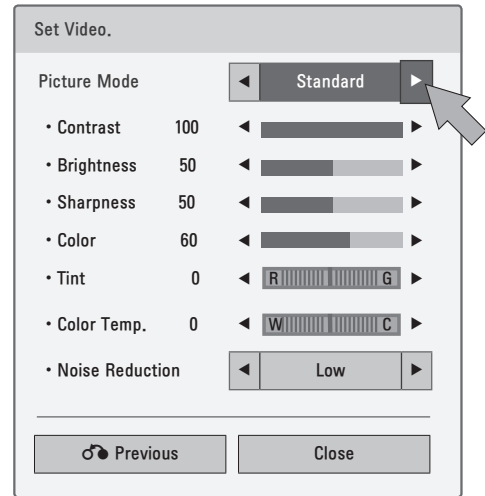

Make appropriate adjustments. Then, select **Close**.

## Set Audio Menu Options

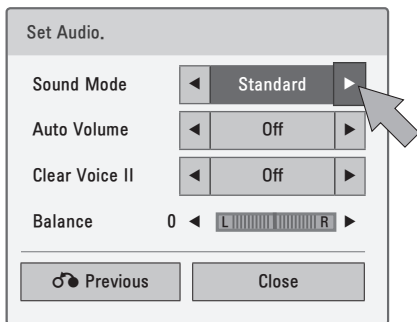

Make appropriate adjustments. Then, select **Close**.

## Set 3D video Menu Options (For LED LCD TV, 50/60PX950

i.e)

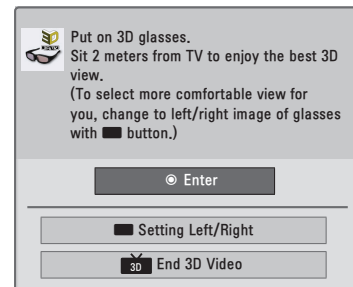

For more information, see the 3D Imaging section in the Owner's Manual.

# MUSIC LIST

This TV cannot play back copy-protected files.  
 The On-Screen Display on your model may be slightly different.

- Supported Music File: \*.MP3  
 Bit rate range: 32 Kbps - 320 Kbps
- Sampling rate MPEG1 Layer3: 32 kHz, 44.1 kHz, 48 kHz
  - Sampling rate MPEG2 Layer3: 16 kHz, 22.05 kHz, 24 kHz

## Screen Components

**1** Select **Home Menu**.

**2** Select **MY MEDIA**.

**3** Select **Music List**.

**1** Preview: If any album jacket for the file (Album Art Image) exists, this picture is displayed.

**2** Moves to upper level folder

**3** Current page/Total pages

**4** Current page/total pages of contents

**5** Contents under the folder focused on **2**

**6** Change to a different input.

**7** Move to **Movie List** or **Photo List**.

**8** Changes the number or thumbnails displayed at a time.

**9** Allows you to mark certain files.

**10** Return to TV viewing.





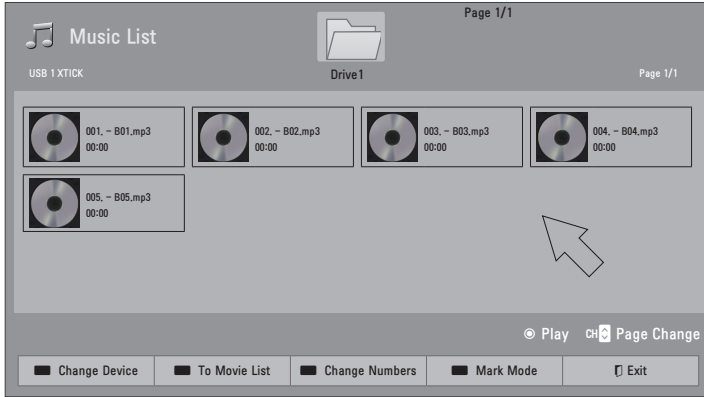

Abnormal files are displayed using this graphic.

Non-supported files are displayed using this graphic.

# MY MEDIA

## Music Selection



- 1   Select the target folder or drive.
- 2   Select the desired music file.
- 3   Music files are played.

MY MEDIA

## Mark Mode

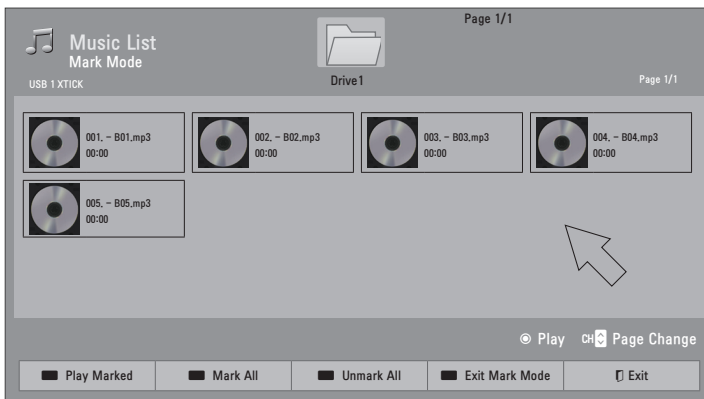

- 1   Select the target folder or drive.
- 2   Select **Mark Mode**.
- 3   Select the desired music file.
- 4   Select **Play Marked**.  
Play the marked music file.

<b>Play Marked</b>	Play the selected songs. Once a song finishes playing, the next selected one will be played automatically.
<b>Mark All</b>	Mark all songs in the folder.
<b>Unmark All</b>	Deselect all marked song.
<b>Exit Mark Mode</b>	Enter or exit the Mark Mode.

## Using the Music List Function

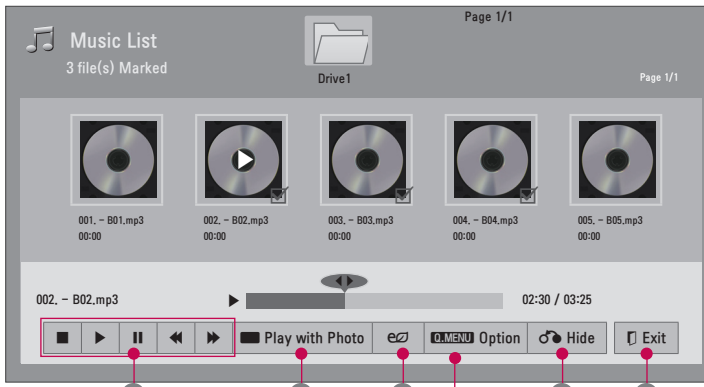

- 1 ■ Stop playback.  
▶ Return to normal playback.  
|| Paused playback.  
◀▶ Select the previous or next song.
- 2 **Play with Photo:** Start playing the selected songs and then move to the Photo List.
- 3 Increase or decrease the brightness of your screen
- 4 Hide the menu on screen.
- 5 Move to the previous menu screen.



1 Show the **Option** menu.



2 Select **Set Audio Play.** or **Set Audio..**

### NOTE

- ▶ You can listen to the music only within the device currently played.

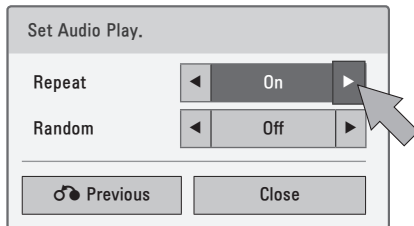

## Set Audio Play Menu Options

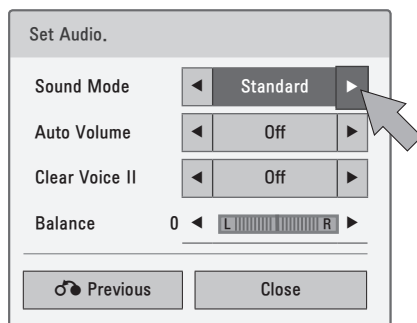

-   Make appropriate adjustments.  
Then, select **Close**.

## Set Audio Menu Options



-   Make appropriate adjustments.  
Then, select **Close**.

- If you don't press any buttons for a while, the play information box will float across the screen. This prevents screen pixel damage due to a fixed image remaining on the screen for an extended period of time.

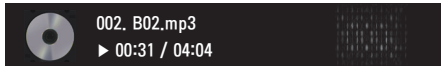

#### ! NOTE

- ▶ A damaged or corrupted music file does not play but displays 00:00 in playtime.
- ▶ Music files with copy-protection will not play.
- ▶ Press **ENTER** or **■** button to stop the screen saver.





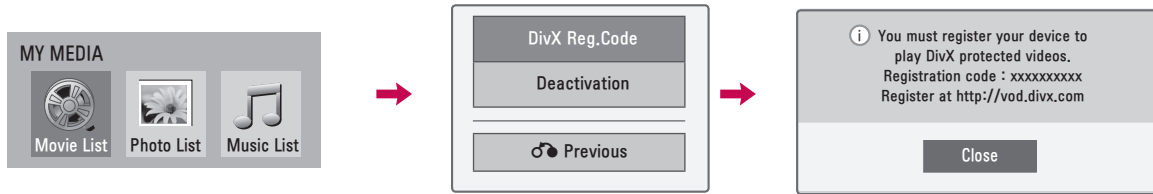

# MY MEDIA

## DIVX REGISTRATION CODE

Using the registration number, movies can be rented or purchased at [www.divx.com/vod](http://www.divx.com/vod).  
Only DivX files matched with the registration code of the purchased TV are playable.



MY MEDIA

- 1   Select **MY MEDIA**.
- 2   Select DivX Option.
- 3  Select **DivX Reg. Code**.
- 4  Display DivX Reg. Code.

### NOTE

- ▶ When loading, some buttons may not work.
- ▶ If you use the DivX registration code of another device, the rented or purchased DivX file cannot be played. Therefore always use the DivX registration code assigned to this product.
- ▶ The video or audio of a file converted based on a standard other than the DivX codec standard may be corrupted or unable to be played.
- ▶ The DRM/\*.tp/\*.trp file in DLNA server is not played when Movie List is in operation.









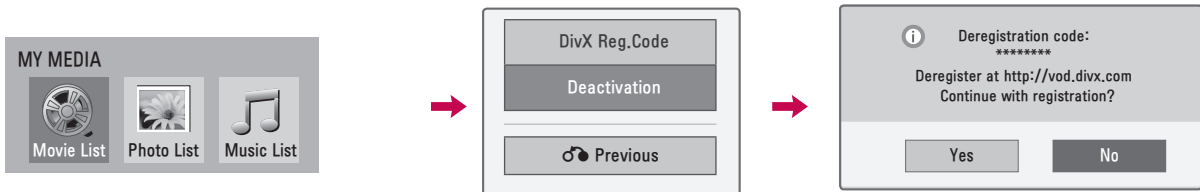

# DEACTIVATION

The purpose of deactivation is to allow deactivation of devices for users who have activated all the available devices through the web server and are blocked from activating more devices. DivX VOD allows the consumer to activate up to 6 devices under one account.

Delete the existing authentication information to receive a new DivX user authentication for TV. Once this function is executed, a DivX user authentication is required again to see DivX DRM files.



-   Select **MY MEDIA**.
-   Select DivX Option.
-  Select **Deactivation**.
-   Select **Yes**.
-  Display **Deactivation**.

# NETWORK

## LEGAL NOTICE

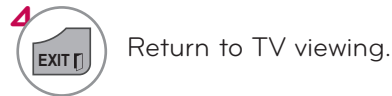
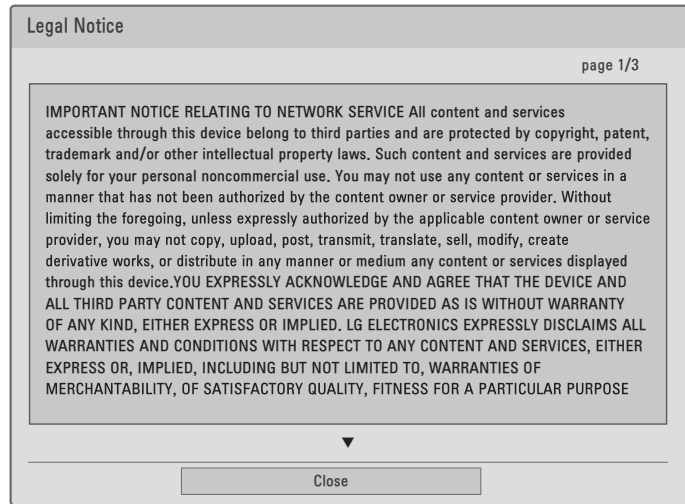
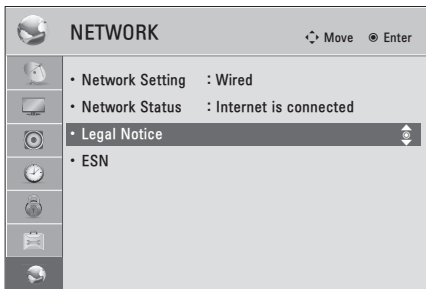

### IMPORTANT NOTICE RELATING TO NETWORK SERVICE

All content and services accessible through this device belong to third parties and are protected by copyright, patent, trademark and/or other intellectual property laws. Such content and services are provided solely for your personal noncommercial use. You may not use any content or services in a manner that has not been authorized by the content owner or service provider. Without limiting the foregoing, unless expressly authorized by the applicable content owner or service provider, you may not copy, upload, post, transmit, translate, sell, modify, create derivative works, or distribute in any manner or medium any content or services displayed through this device.

YOU EXPRESSLY ACKNOWLEDGE AND AGREE THAT THE DEVICE AND ALL THIRD PARTY CONTENT AND SERVICES ARE PROVIDED "AS IS" WITHOUT WARRANTY OF ANY KIND, EITHER EXPRESS OR IMPLIED. LG ELECTRONICS EXPRESSLY DISCLAIMS ALL WARRANTIES AND CONDITIONS WITH RESPECT TO ANY CONTENT AND SERVICES, EITHER EXPRESS OR, IMPLIED, INCLUDING BUT NOT LIMITED TO, WARRANTIES OF MERCHANTABILITY, OF SATISFACTORY QUALITY, FITNESS FOR A PARTICULAR PURPOSE, AND NON-INFRINGEMENT OF THIRD PARTY RIGHTS. LG DOES NOT GUARANTEE THE ACCURACY, VALIDITY, TIMELINESS, LEGALITY, OR COMPLETENESS OF ANY CONTENT OR SERVICE MADE AVAILABLE THROUGH THIS DEVICE AND DOES NOT WARRANT THAT THE DEVICE OR SERVICES WILL MEET YOUR REQUIREMENTS, OR THAT OPERATION OF THE

DEVICE OR SERVICES WILL BE UNINTERRUPTED OR ERROR-FREE. UNDER NO CIRCUMSTANCES, INCLUDING NEGLIGENCE, SHALL LG BE LIABLE, WHETHER IN CONTRACT OR TORT, FOR ANY DIRECT, INDIRECT, INCIDENTAL, SPECIAL OR CONSEQUENTIAL DAMAGES, OR ANY OTHER DAMAGES ARISING OUT OF, ANY INFORMATION CONTAINED IN, OR ANY CONTENT OR SERVICE ACCESSED BY YOU OR ANY THIRD PARTY, EVEN IF ADVISED OF THE POSSIBILITY OF SUCH DAMAGES.

Third party services may be changed, suspended, removed, terminated or interrupted, or access may be disabled at any time, without notice, and LG makes no representation or warranty that any content or service will remain available for any period of time. Content and services are transmitted by third parties by means of networks and transmission facilities over which LG has no control. LG may impose limits on the use of or access to certain services or content, in any case and without notice or liability. LG expressly disclaims any responsibility or liability for any change, interruption, disabling, removal of or suspension of any content or service made available through this device.

LG is neither responsible nor liable for customer service related to the content and services. Any question or request for service relating to the content or services should be made directly to the respective content and service providers.

# NETCAST





## NETCAST MENU

These services are provided by separate Content Provider.  
NETCAST menu source can differ by country.

### What is a NETCAST?

Stream movies, TV shows and video, or get up to the minute news, stock information or weather updates directly to your TV.



- 1    Select **NetCast**.
- 2   Select **NETCAST** menu option.  
Enjoy **Online Service**.

- To view the owner's manual that provided by the Content Provider, visit our website at <http://www.lg.com>.
- You can also select the **NETCAST** using the NETCAST button on the TV remote control.

#### ■ Yahoo! (For USA)

Yahoo! TV Widgets give you the best of the Internet in perfect harmony with the simplicity and reliability of your TV. TV Widgets deliver a Cinematic internet™ experience by converting your favorite web services for viewing on the TV.

#### ■ Netflix (For USA)

You can instantly watch movies (quite a few new releases) & TV episodes from Netflix streamed over the internet to your TV.

To become a Netflix member visit: [www.netflix.com/LG](http://www.netflix.com/LG)

Note that this service is provided by the Content Provider, Netflix. It is dependent on Netflix to provide the data.

#### ■ Vudu (For USA)

In order to make rental/purchase transactions on the Vudu service, a user must create an account on [vudu.com](http://vudu.com).

That account is linked to a specific device, via a process called "activation". It is possible to have multiple devices associated with a single Vudu account.

Note that this service is provided by the Content Provider, Vudu. It is dependent on Vudu to provide the data.

#### ■ YouTube

YouTube is a video sharing website where users can upload, view, and share video clips.

#### ■ Picasa

Picasa is an application from Google that appreciates digital image files.

### ! NOTE

- ▶ The videos list searched from the TV may differ with the list searched from a web browser on PC.
- ▶ The settings of this TV do not affect the YouTube's playback quality.
- ▶ The playback of videos may be paused, stopped or buffering occurring often depending on your broadband speed.
- ▶ For service that requires log in, join the applicable service on the website using the PC and log in through the TV to enjoy various additional functionalities.
- ▶ When you set the city you want with Setup by pressing the red button, the background of NetCast will be set to the weather of the selected city.
- ▶ For Plasma TV: If there is no user action 2 minutes following freezing image or video on screen, the screensaver will activate itself preventing fixed image remaining on screen.

# NETCAST

## YOUTUBE

YouTube is a video sharing website where users can upload, view, and share video clips.

### Screen Components

- 1 YouTube menu
- 2 Videos list

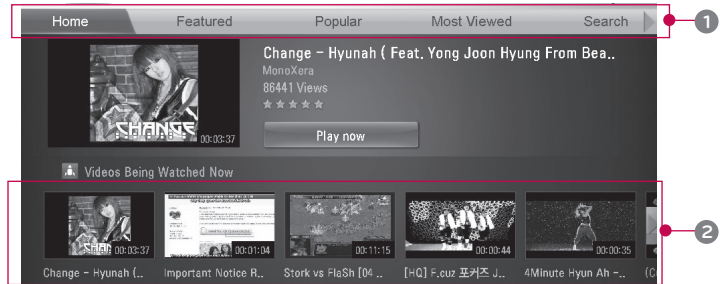

RED

Set the option menu.



Return to Netcast menu.

EXIT

Return to TV viewing.

### NOTE

- ▶ When you press the Q.menu button while the Youtube video is playing in full mode, you can set the video options.

## YouTube menu

**Home:** You can watch the popular video in real time.

**Featured:** The featured videos list will be displayed.

**Popular:** The best rated videos list from YouTube server will be displayed.

**Most Viewed:** The most viewed videos list will be displayed.







**Search:** The keypad/keyboard menu will be displayed.

**History:** The videos list that you previously played will be displayed. Maximum of 20 videos can be stored.

**Favorites:** In sign-in status, this menu will be displayed the videos list that is arranged in the YouTube server with your account (Some videos may not appear on the **Favorites** list, even if the videos are arranged in the server).

**Sign in (Sign Out):** Displays the keypad/keyboard menu to sign in or returns to the sign-out status.

## Using the remote control

	Stops the video and displays related videos list.
	Pause the video while it is playing.
	Play the selected video.
	Skip the playback forward or backward.
	Set the option menu.
	Return to Netcast menu.
	Return to TV viewing.

# NETCAST

## PICASA

Picasa is a photo organizing or sharing website where users can upload, view, and share photos.

### Screen Components

- 1 Picasa menu
- 2 Photo list

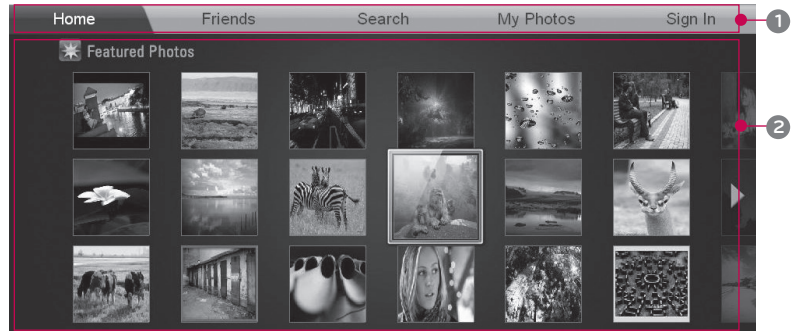

Navigate the desired photos.



The selected photo file is displayed.



Return to Netcast menu.



Return to TV viewing.

## Picasa menu

**Home:** The featured photos list will be displayed.

**Friends:** You can register users with the pictures you want as friends. You can add up to 10 friends.

**Search:** The keypad/keyboard menu will be displayed.

**My Photos:** You can view the pictures uploaded to the Web. This function can only be used when you sign in.







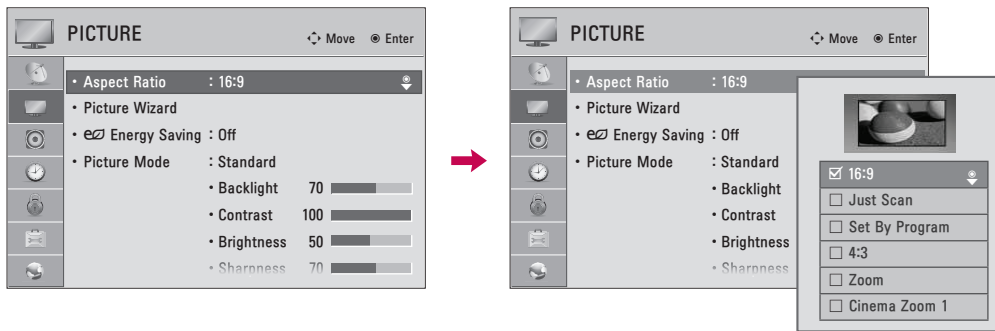

**Sign in (Sign Out):** Displays the keypad/keyboard menu to sign in or returns to the sign-out status.

# PICTURE CONTROL

## PICTURE SIZE (ASPECT RATIO) CONTROL









This feature lets you choose the way an analog picture with a 4:3 aspect ratio is displayed on your TV. You can select a different aspect ratio depending on input source (analog broadcasting, digital broadcasting, aux).



- 1   Select **PICTURE**.
- 2   Select **Aspect Ratio**.
- 3   Select the desired picture format.
- 4  Return to the previous menu.
-  Return to TV viewing.

- You can also adjust **Aspect Ratio** in the **Q.MENU**.
- Press the **RATIO** button repeatedly to select the desired picture format.

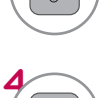
## When adjusting Zoom or Cinema Zoom in Q.MENU

- 1   Select **Aspect Ratio**.
- 2   Select **Zoom** or **Cinema Zoom**.
- 3   Adjust proportion of Zoom or Cinema Zoom. The Cinema Zoom adjustment range is 1-16.
- 4   Move the image on the screen.



## 16:9

Adjust the picture horizontally, in a linear proportion to fill the entire screen.



## Just Scan

Normally the edges of video signals are cropped 1-2%. Just Scan turns off this cropping and shows the complete video.

Notes: If there is noise on the edges of the original signal, it will be visible when Just Scan is activated.

**Just Scan** operates only in DTV/Cable DTV/Component/HDMI-DTV/DVI-DTV (720p/1080i/1080p) input source.

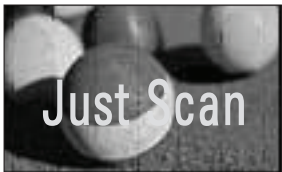

## Set By Program

Selects the proper picture proportion to match the source's image.

(4:3 → 4:3)



(16:9 → 16:9)



## 4:3

Choose 4:3 when you want to view a picture with an original 4:3 aspect ratio.



## Zoom

Choose Zoom when you want to view the picture without any alteration. However, the top and bottom portions of the picture will be cropped.

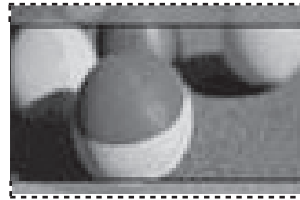

## Cinema Zoom

Choose Cinema Zoom when you want to enlarge the picture in correct proportion.

This enlarges an image with cinemascope aspect ratio (2.35:1) without distortion.

Note: When enlarging or reducing the picture, the image may become distorted.



# PICTURE CONTROL

## PICTURE WIZARD

This feature lets you adjust the picture quality of the original image. Use this to calibrate the screen quality by adjusting the Black and White Level etc. You can calibrate the screen quality by easily following each step. When you adjust the image to **Low**, **Recommended** or **High**, you can see the example of the changes you made.

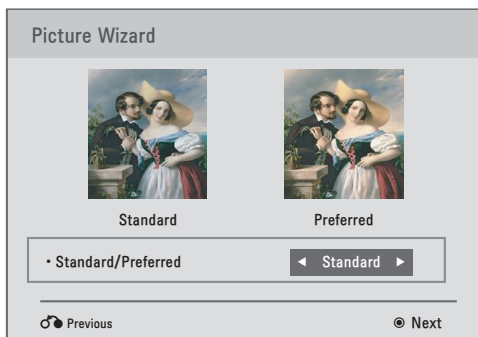
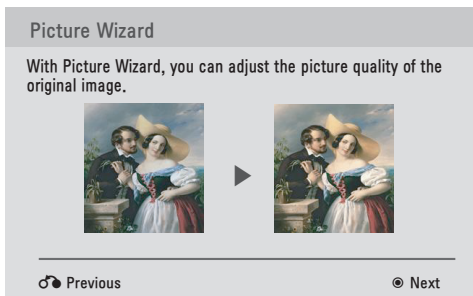
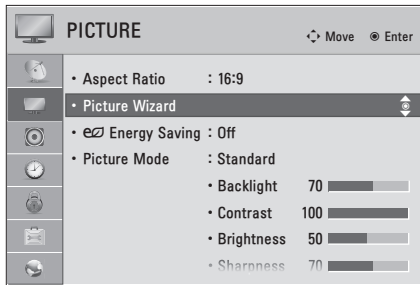

- If you select **Preferred**, OSD (On Screen Display) differ from that shown in this manual.

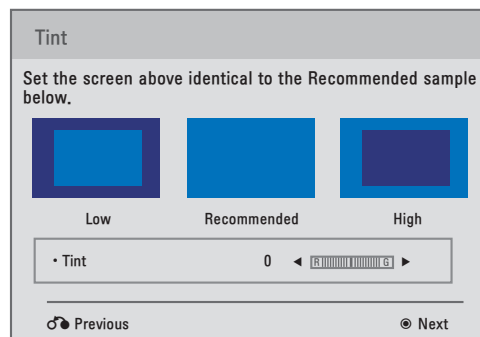
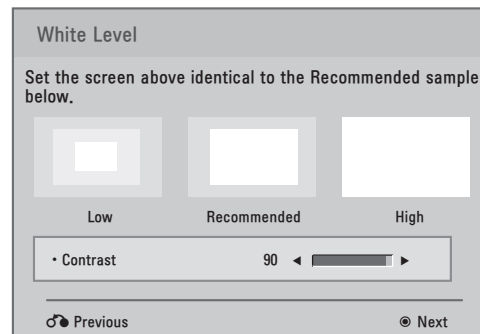
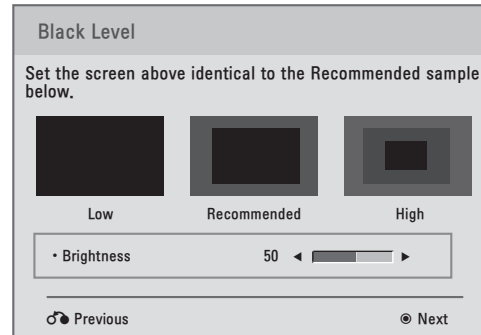

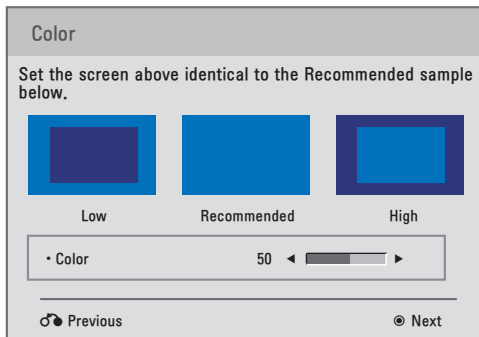

8   Adjust **Color**.

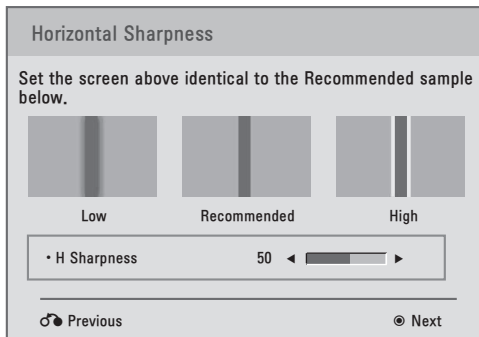

9   Adjust **Horizontal Sharpness**.

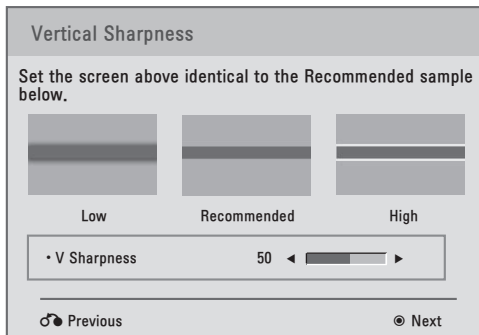

10   Adjust **Vertical Sharpness**.

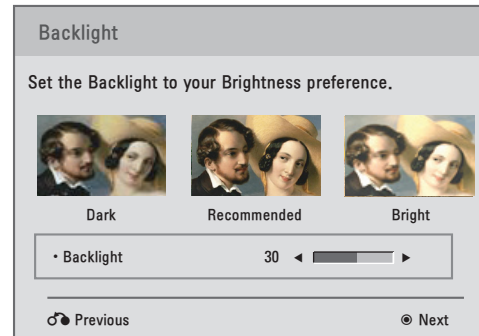

For LED LCD TV

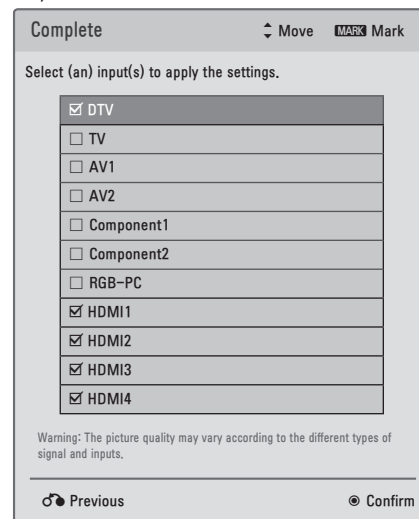

11   Adjust **Backlight**.

i.e)



12   Select input source to apply the settings.

13  Save.

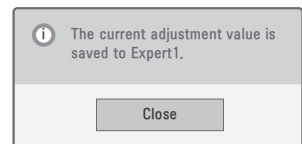

14  Finish the Picture Wizard.

- If you stop the Picture Wizard before the final step, the changes will not be saved to the TV.
- Once the **Picture Wizard** sets the picture quality, **Energy Saving** is changed to **Off** automatically.
- To reset changes made by **Picture Wizard**, operate **Picture Reset** when **Picture Mode** is on **Expert1**.

# PICTURE CONTROL



## e ENERGY SAVING

It reduces the TV's power consumption.

The default factory setting is adjusted to the comfortable level to be viewed at home.

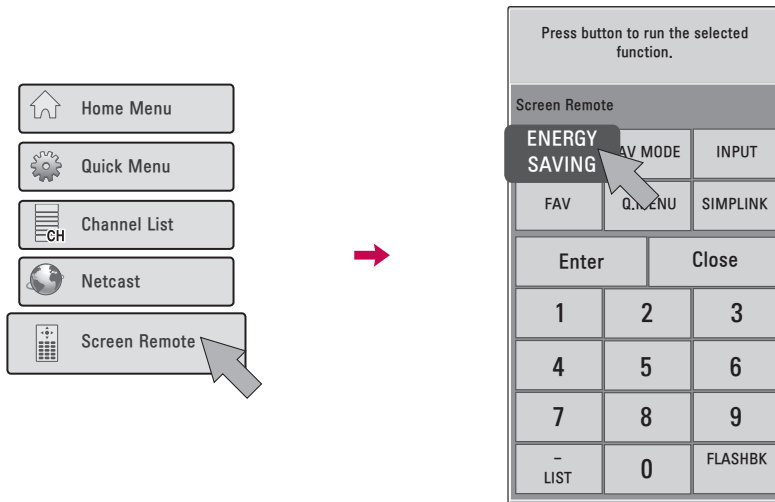
You can increase the brightness of your screen by adjusting the **Energy Saving** level or by adjusting the **Picture Mode**.

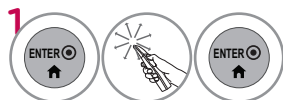

-  Select **Screen Remote**.
-  Select **ENERGY SAVING**.
-  Select **ENERGY SAVING** repeatedly to select your desired menu option.

- When selecting **Screen off**, the screen will turn off after 3 seconds. Pressing any button of the remote controller will turn on the screen again.
- If you adjust "**Energy Saving-Auto, Maximum**", **Backlight** option will not work (For LED LCD TV).
- When selecting "**Energy Saving - Off, Minimum, or Medium**", you can adjust **Backlight** feature (For LED LCD TV).
- If you adjust "Energy Saving-Intelligent Sensor", Sharpness, Color, Color Temperature feature will not work (For Plasma TV).
- When selecting **Auto**, **Backlight** is automatically adjusted through **Intelligent Sensor** according to the surrounding conditions. (For LED LCD TV)
- When selecting **Off**, **Energy Saving** is not used.
- Press the **ENERGY SAVING** button repeatedly to select the appropriate Energy Saving.
- You can also adjust **Energy Saving** in the **PICTURE** menu.
- **Intelligent Sensor**: The most suitable picture is automatically adjusted according to the surrounding conditions (For Plasma TV).

# PRESET PICTURE SETTINGS (PICTURE MODE)

There are factory presets for picture settings available in the user menus. You can use a preset, change each setting manually, or use the Intelligent Sensor.

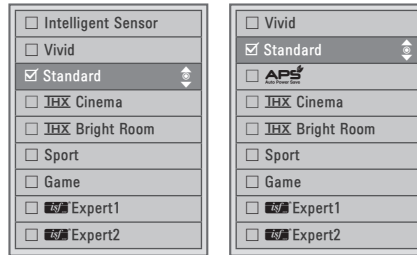
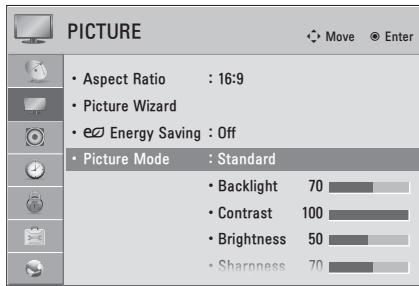

Other models

Plasma TV

- 1 Select **PICTURE**.
- 2 Select **Picture Mode**.
- 3 Select your desired menu option.

- 4 Return to the previous menu.
- Return to TV viewing.

- **Vivid, Standard, Cinema, Sport, and Game** Settings are preset for the optimum picture quality at the factory.
- **Vivid:** This is the mode to maximize the effect of the video in the retail store. Strengthen the contrast, brightness, color and sharpness for vivid picture.
- **Standard:** This is the mode to realize optimum viewing condition for the general user.
- **APS (Auto Power Saving):** This is the mode to maximize reducing the power consumption without hurting the picture quality. This feature is available only on Plasma TV.
- **Cinema:** This mode optimizes video for watching movies.
- **THX Cinema:** This is cinema quality mode to provide you the experience of watching a movie at home. The user will be able enjoy the best level of satisfactory screen quality in any movie without any separate adjustments. **THX Cinema** express the optimal screen quality when it is darkest.

When selecting **THX Cinema**, Aspect ratio changes to Just scan.

- **THX Bright Room:** This is the specification to optimize TV viewing in Bright Room. When selecting **THX Bright Room**, Aspect ratio changes to Just scan.
- **Sport:** This is the video mode to emphasize dynamic video and primary color (e.g, white, uniform, grass, sky blue etc.) by realizing the optimal screen for sports.
- **Game:** This is the mode to realize fast response speed in a fast gaming screen.
- **Expert:** This is the mode to adjust the video in detail for video quality expert and general user.
- You can also adjust **Picture Mode** in the **Q.MENU**.
- When selecting **Intelligent Sensor**, **Energy Saving** is changed to **Auto** automatically (For LED LCD TV).
- When selecting **Intelligent Sensor**, it changes Backlight, contrast, brightness, sharpness, color, tint and color temperature automatically (For LED LCD TV).
- **Intelligent Sensor:** The most suitable picture is automatically adjusted according to the surrounding conditions.

# PICTURE CONTROL

## MANUAL PICTURE ADJUSTMENT - USER MODE

Adjust the picture appearance to suit your preference and viewing situations.











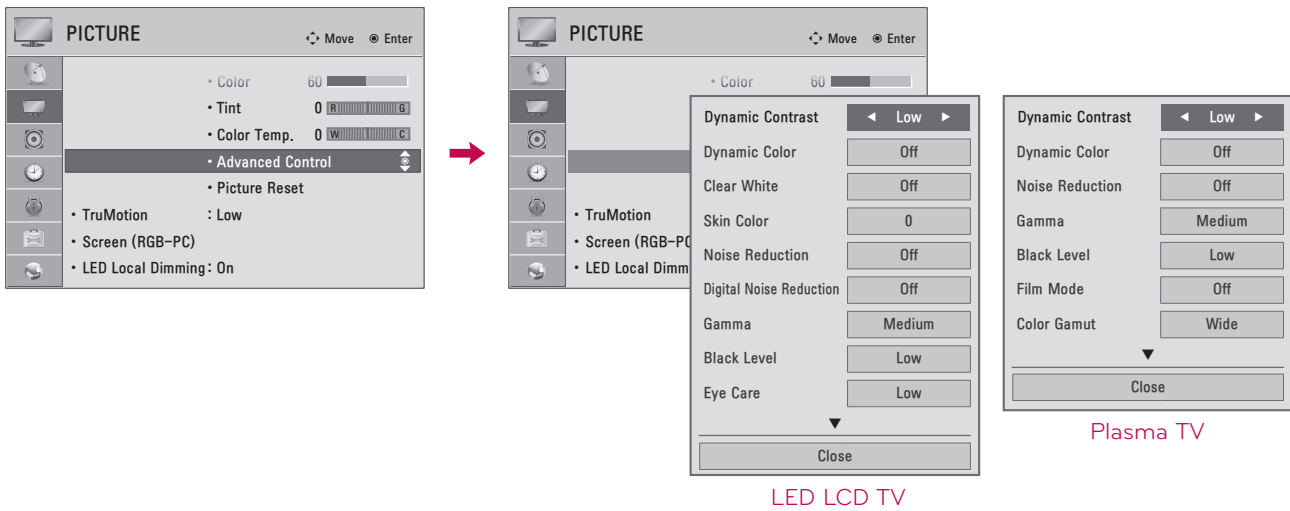

-   Select **PICTURE**.
-   Select **Picture Mode**.
-   Select your desired menu option.
-   Select **Backlight** (For LED LCD TV), **Contrast**, **Brightness**, **Sharpness**, **Color**, **Tint**, **Color Temp.**, or **Advanced Control**.
-   Make appropriate adjustments.
-  Return to the previous menu.
-  Return to TV viewing.

- **Backlight** (For LED LCD TV): This function adjusts the brightness of the backlight behind the LCD screen. Adjusting the backlight is recommended when setting the brightness of the TV. When decreasing the backlight, the brightness of the black becomes darker without any loss in video signal and the power consumption is reduced.
- **Backlight** can only be adjusted in "Energy Saving - Off, Minimum, or Medium".
- **Contrast**: Increase or decrease the gradient of the video signal. You may use Contrast when the bright part of the picture is saturated.
- **Brightness**: Adjusts the base level of the signal in the picture. You may use Brightness when the dark part of the picture is saturated.
- **Sharpness**: Adjusts the level of crispness in the edges between the light and dark areas of the picture. The lower the level, the softer the image.
- **Color**: Adjusts intensity of all colors.
- **Tint**: Adjusts the balance between red and green levels.
- **Color Temp.:** Set to warm to enhance hotter colors such as red, or set to cool to enhance cooler colors such as blue.

# PICTURE IMPROVEMENT TECHNOLOGY (ADVANCED CONTROL)

Advanced Control allows you to adjust some of the advanced features of your LG display. To reset to the factory default after making adjustments to each input source, execute the **Picture Reset** function for each Picture Mode.



- 1   Select **PICTURE**.
- 2   Select **Advanced Control**.
- 3   Select your desired menu option.
- 4  Make appropriate adjustments.
- 5  Return to the previous menu.
-  Return to TV viewing.

# PICTURE CONTROL

## EXPERT PICTURE CONTROL

**Expert1** and **Expert2** provide even more advanced picture settings for users. Typical used by professionals for calibrating the TV.

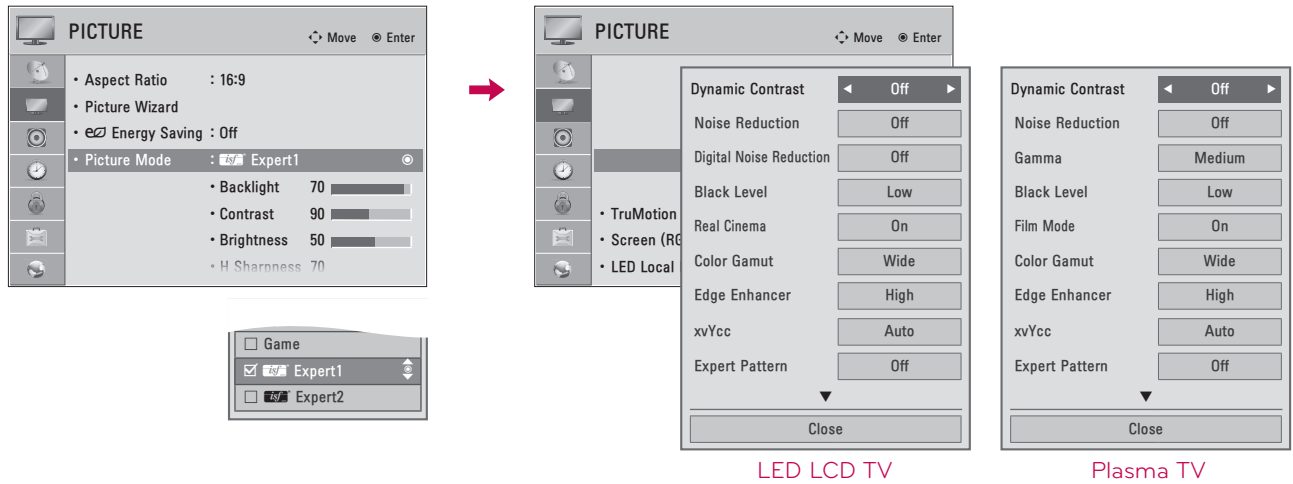



- Select **PICTURE**.
- Select **Picture Mode**.
- Select **Expert1** or **Expert2**.
- Select **Expert Control**.
- Select your desired menu option.
- Make appropriate adjustments.
- Return to the previous menu.
- Return to TV viewing.



\*This feature is not available for all models.

Dynamic Contrast	<ul style="list-style-type: none"> <li>Adjusts the contrast to keep it at the best level according to the brightness of the screen. The picture is improved by making bright parts brighter and dark parts darker.</li> </ul>
Dynamic Color	<ul style="list-style-type: none"> <li>Adjusts screen colors so that they look livelier, richer and clearer. This feature enhances hue, saturation and luminance so that red, blue, and green look more vivid.</li> </ul>
Skin Color	<ul style="list-style-type: none"> <li>It detects the skin area of video and adjusts it to express a natural skin color.</li> </ul>
Noise Reduction	<ul style="list-style-type: none"> <li>Reduces screen noise without compromising video quality.</li> </ul>
Digital Noise Reduction	<ul style="list-style-type: none"> <li>Removes noise caused by compressing video.</li> </ul>
Gamma	<ul style="list-style-type: none"> <li>You can adjust brightness of dark areas and middle gray level areas of the picture.</li> </ul> <p>Low : Make brighter and middle gray level areas of the picture brighter.          Medium : Express original picture levels.          High: Make dark and middle gray level areas of the picture darker.</p>
Black Level	<p>Low: The reflection of the screen gets darker.          High: The reflection of the screen gets brighter.</p> <ul style="list-style-type: none"> <li>Set black level of the screen to proper level.</li> <li>This function is available in the following modes: TV, AV (NTSC-M), HDMI or Component.</li> </ul>
Clear White	<ul style="list-style-type: none"> <li>Make the white area of screen brighter and more white.</li> </ul>
Eye Care	<ul style="list-style-type: none"> <li>Adjust the brightness of the screen to prevent the screen from being too bright. Dims extremely bright pictures.</li> <li>This feature is enabled in "<b>Picture Mode-Standard, Sports, Game</b>".</li> </ul>
Real Cinema or Film Mode	<ul style="list-style-type: none"> <li>Makes video clips recorded in film look more natural by eliminating judder effect.</li> <li>DVD and Blu-ray movies are filmed at 24 frames per second (fps). With LG Real Cinema, every frame is consistently processed 5 times in 1/24 of a second producing 120 fps with TruMotion or 2 times in 1/24 of a second producing 48 fps without TruMotion, thus totally eliminating the judder effect.</li> <li>This function can also work when TruMotion is off.</li> </ul>
Color Gamut	<p>LED LCD TV: <b>Advanced Control</b>          Plasma TV: <b>Advanced Control, Expert Control</b></p> <p>Standard/sRGB: Displays standard set of colors.          Wide: Increase number of colors used.</p> <ul style="list-style-type: none"> <li>Maximize the utilization of colors to increase color quality.</li> </ul> <p>LED LCD TV: <b>Expert Control</b></p> <ul style="list-style-type: none"> <li>Displays color domain of the signal.</li> </ul> <p>Standard: Displays standard set of colors.          Wide: Increase number of colors used.          EBU: Mode to display EBU standard color area.          SMPTE: Mode to display SMPTE standard color area.          BT709: Mode to display BT709 standard color area.</p>







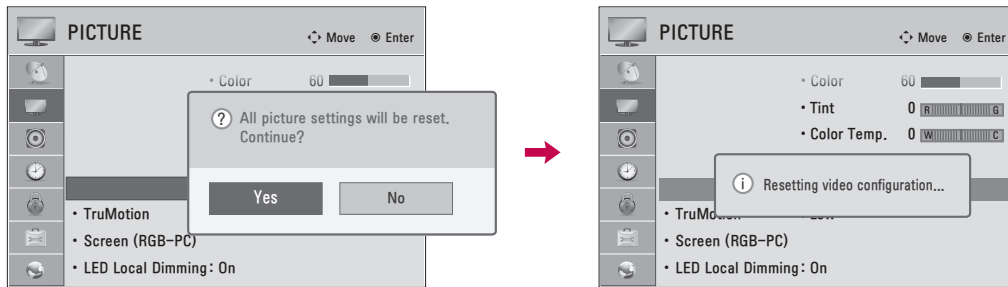

# PICTURE CONTROL

Edge Enhancer	<ul style="list-style-type: none"> <li>Show clearer and distinctive yet natural edges in the video.</li> </ul>
xvYCC	<ul style="list-style-type: none"> <li>This produces richer colors.</li> <li>This feature represents rich color as much as conventional video signal.</li> <li>This function is enabled in "<b>Picture mode - Cinema / THX Cinema / THX Bright Room,  Expert</b>" when a xvYCC signal is inputted through HDMI.</li> </ul>
Color Filter	<ul style="list-style-type: none"> <li>This function filters specific colors in the video. You can use the RGB filter to set color saturation and hue accurately.</li> </ul>
Expert Pattern	<ul style="list-style-type: none"> <li>This is a pattern used for expert adjustment.</li> <li>This function is enabled in "<b>Picture mode -  Expert</b>" when you watch DTV.</li> </ul>
Color Temperature	<ul style="list-style-type: none"> <li>Adjusts the overall color of the screen by changing the white baseline.             <ol style="list-style-type: none"> <li>Gamma : Select 1.9, 2.2, 2.4</li> <li>Method : 2 Points                 <ul style="list-style-type: none"> <li>Pattern: Inner, Outer</li> <li>Red/Green/Blue Contrast, Red/Green/Blue Brightness: The adjustment range is -50 - +50.</li> </ul> </li> <li>Method : 10 Point IRE (<b>LED LCD TV</b>)                 <ul style="list-style-type: none"> <li>Pattern: Inner, Outer</li> <li>IRE (Institute of Radio Engineers) is the unit to display the size of the video signal and can be set among 10, 20, 30 - 100. You can adjust Red, Green or Blue according to each setting.</li> <li>Luminance: This function displays calculated luminance value for 2.2 gamma. You can input luminance value you want at 100 IRE, then the target luminance value for 2.2 gamma is displayed at every 10 steps from 10 IRE to 90 IRE.</li> <li>Red/Green/Blue: The adjustment range is -50 - +50.</li> </ul> </li> <li>Method : 20 Point IRE (<b>Plasma TV</b>)                 <ul style="list-style-type: none"> <li>IRE (Institute of Radio Engineers) is the unit to display the size of the video signal and can be set among 5, 10, 15 - 100. You can adjust Red, Green or Blue according to each setting.</li> <li>Red/Green/Blue: The adjustment range is -50 - +50.</li> </ul> </li> </ol> </li> <li>d. Apply to all inputs</li> </ul>
Color Management System	<ul style="list-style-type: none"> <li>A tool used by the experts to make adjustments by using the test patterns, this does not affect other colors but can be used to selectively adjust the 6 color areas (Red/Green/Blue/Cyan/Mgt/Yellow). Color difference may not be distinctive even when you make the adjustments for the general video.</li> <li>Adjusts Red/Green/Blue/Yellow/Cyan, Magenta.             <ul style="list-style-type: none"> <li>Red/Green/Blue/Yellow/Cyan/Magenta Color: The adjustment range is -30 - +30.</li> <li>Red/Green/Blue/Yellow/Cyan/Magenta Tint: The adjustment range is -30 - +30.</li> <li>This feature is disabled in RGB-PC and HDMI-PC mode.</li> </ul> </li> </ul>

# PICTURE RESET

Settings of the selected picture modes return to the default factory settings.







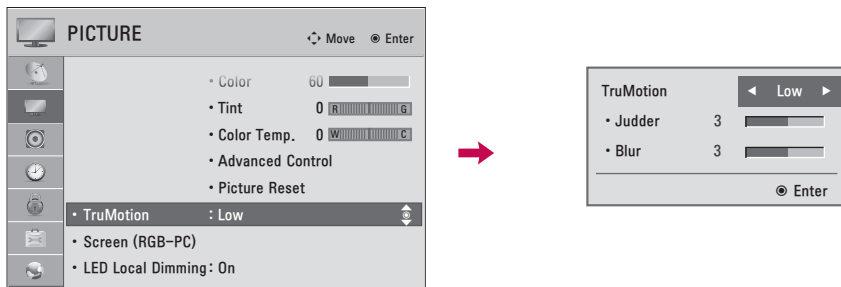

- 1   Select **PICTURE**.
- 2   Select **Picture Reset**.
- 3   Select **Yes**.
- 4  Initialize the adjusted value.
-  Return to TV viewing.

# PICTURE CONTROL



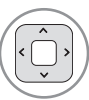

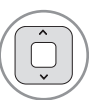
## TRUMOTION - For LED LCD TV

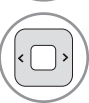
Advance video technology that provides clearer, smoother images, even during fast action scenes creating a more stable structure for a crisper picture.

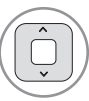

-   Select **PICTURE**.
-   Select **TruMotion**.
-   Select **Low, High, User, or Off**.

### Adjustment for TruMotion (Judder and Blur) with selecting User







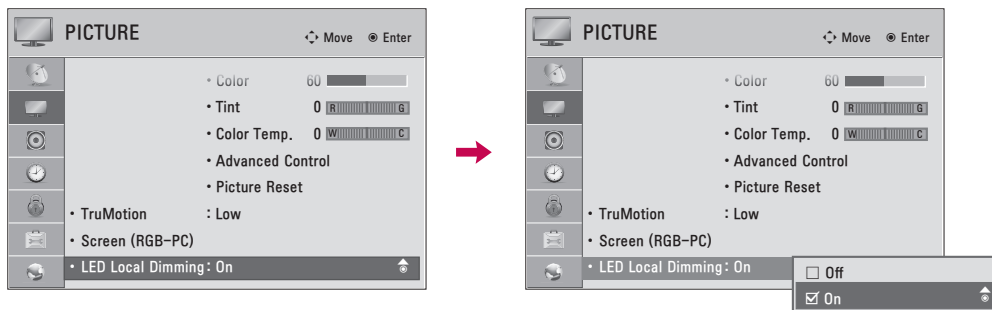

-   Select **Judder** or **Blur**.
-  Make appropriate adjustments.
-  Return to the previous menu.
-  Return to TV viewing.

- **Off**: Turn off **TruMotion** operation.
- **Low**: Provides smooth picture movement. Use this setting for standard use.
- **High**: Provides smoother picture movement.
- **Judder**: Adjusts noise of the screen.
- **Blur**: Adjusts after-image of the screen.
- **TruMotion** works with all inputs except PC mode.
- If you enable "**TruMotion**", noise may appear on the screen. If this occurs, set "**TruMotion**" to "**Off**".
- If you select "**Picture Mode-Game**" set "**TruMotion**" to "**Off**".

## LED LOCAL DIMMING - For LED LCD TV

After analyzing the signal of the input video by areas of the screen, it adjusts the backlight to improve the contrast ratio. This feature is disabled in "Picture Mode-Game".











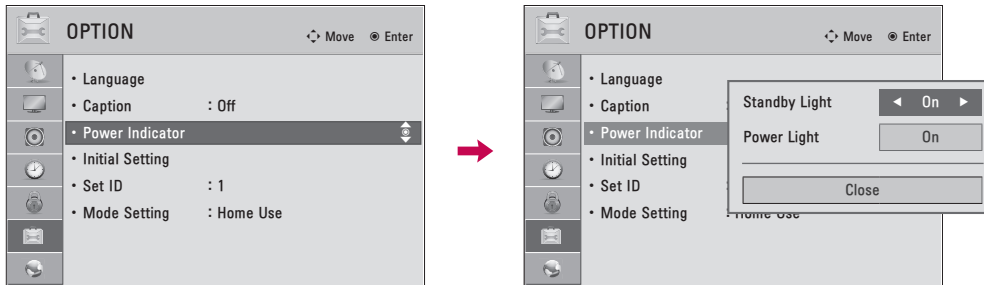

-   Select **PICTURE**.
-   Select **LED Local Dimming**.
-   Select **On** or **Off**.
-  Return to the previous menu.
-  Return to TV viewing.

# PICTURE CONTROL

## POWER INDICATOR - For LED LCD TV

Adjust the power/standby indicator light on the front of the TV.



-   Select **OPTION**.
-   Select **Power Indicator**.
-   Select **Standby Light** or **Power Light**.
-  Select your desired options.
-  Return to the previous menu.
-  Return to TV viewing.

- **Standby Light:** Determines whether to set the indicator light on the front of the TV to **On** or **Off** in standby mode.
- **Power Light:** Determines whether to set the indicator light on the front of the TV to **On** or **Off** when the power turns on.

# IMAGE STICKING MINIMIZATION (ISM) METHOD - For Plasma TV

A frozen still picture displayed on the screen for prolonged periods can result in a ghost image. You can use Orbiter to help prevent image sticking. The other two functions are for removing a ghost image.

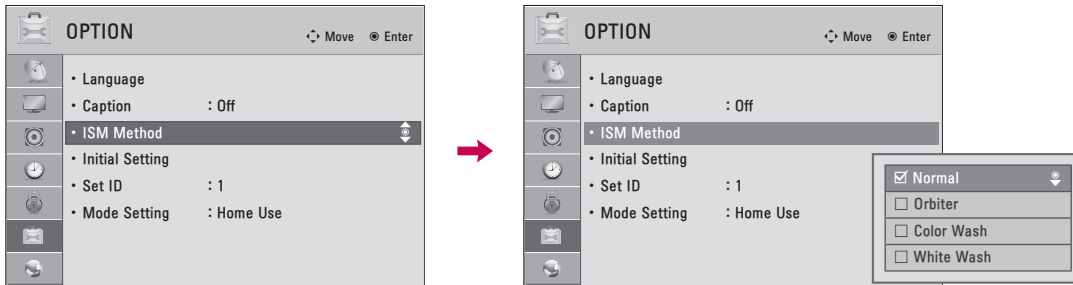

- 1 Select **OPTION**.
- 2 Select **ISM Method**.
- 3 Select **Normal, Orbiter, Color Wash, or White Wash**.
- 4 Return to TV viewing.

- **Normal:** If image sticking is never a problem, ISM is not necessary - set to Normal.
- **Orbiter:** To avoid a ghost image on the screen, the image will move every 2 minutes to help prevent ghost images. However, it is best not to allow any fixed image to remain on the screen.
- **Color Wash:** The color block with the screen moved a little and the white pattern are displayed. It is difficult to see the after image on all colors. Once it has been corrected it will not be visible in any color.
- **White Wash:** White Wash removes ghost images from the screen. Use sparingly. Watch the TV normally for a while before using this feature to see if the ghost image disappears on its own.

**NOTE**

► An excessive ghosted image may be impossible to clear entirely with White Wash. To return to normal viewing, press the any button.







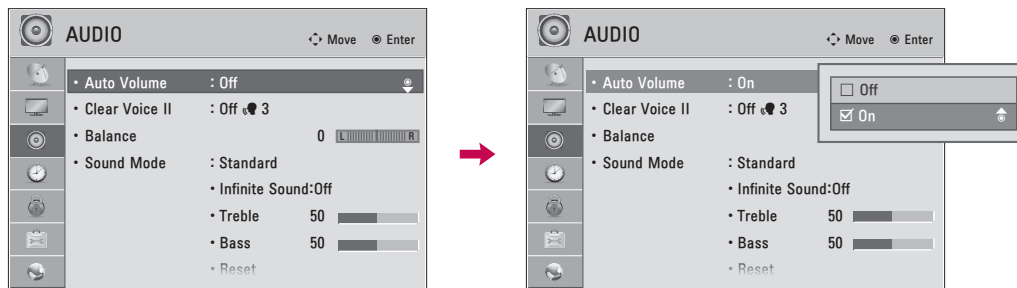

# SOUND & LANGUAGE CONTROL

## AUTO VOLUME

Auto Volume makes sure that the volume level remains consistent whether you are watching a commercial or a regular TV program.

Because each broadcasting station has its own signal conditions, volume adjustment may be needed every time the channel is changed. This feature allows users to enjoy stable volume levels by making automatic adjustments for each program.



-   Select **AUDIO**.
-   Select **Auto Volume**.
-   Select **On** or **Off**.
-  Return to the previous menu.
-  Return to TV viewing.



# CLEAR VOICE II

By differentiating the human sound range from others, it improves the sound quality of voices.

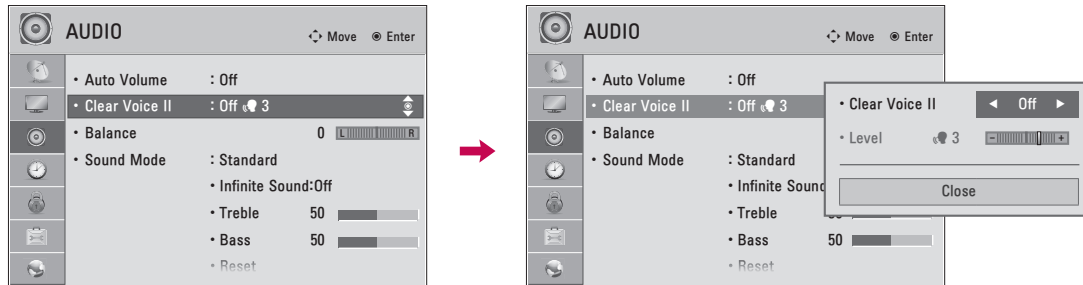



1   Select **AUDIO**.

2   Select **Clear Voice II**.

3   Select **On** or **Off**.

## Adjustment for Clear Voice Level with selecting On

4  Select **Level**.

5   Make appropriate adjustments.

6  Return to the previous menu.

 Return to TV viewing.

# SOUND & LANGUAGE CONTROL

## BALANCE

Adjust the left/right sound of speaker to suit your taste and room situations.

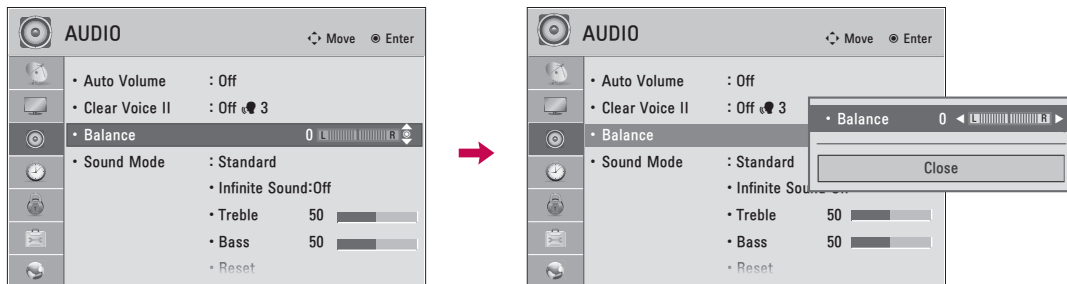







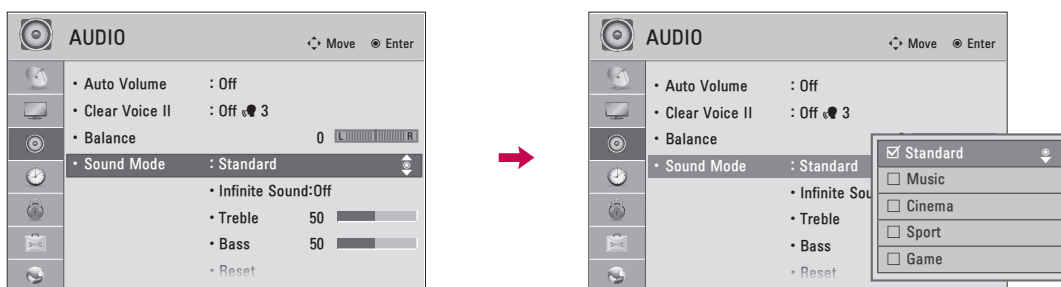

-   Select **AUDIO**.
-   Select **Balance**.
-   Make appropriate adjustments.
-  Return to the previous menu.
-  Return to TV viewing.

## PRESET SOUND SETTINGS (SOUND MODE)

Sound Mode lets you enjoy the best sound without any special adjustment using factory presets.



- 1   Select **AUDIO**.
- 2   Select **Sound Mode**.
- 3   Select **Standard, Music, Cinema, Sport, or Game**.
- 4  Return to the previous menu.
-  Return to TV viewing.









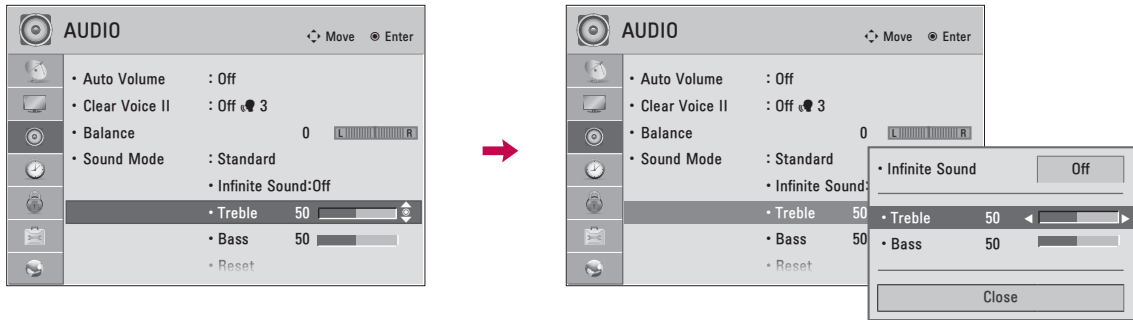



- **Standard, Music, Cinema, Sport, and Game** are preset for optimum sound quality at the factory.
- You can also adjust **Sound Mode** in the **Q.MENU**.
- **Standard**: Offers standard-quality sound.
- **Music**: Optimizes sound for listening to music.
- **Cinema**: Optimizes sound for watching movies.
- **Sport**: Optimizes sound for watching sports events.
- **Game**: Optimizes sound for playing games.

# SOUND & LANGUAGE CONTROL

## SOUND SETTING ADJUSTMENT - USER MODE

Adjust the sound to suit your taste and room situations.









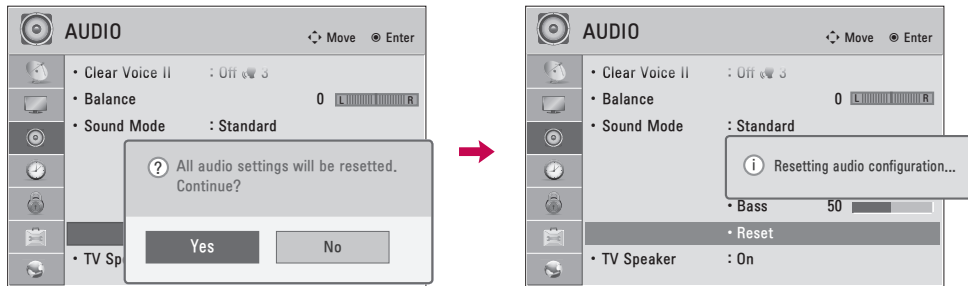

- 1   Select **AUDIO**.
- 2   Select **Sound Mode**.
- 3   Select **Standard, Music, Cinema, Sport, or Game**.
- 4   Select **Infinite Sound, Treble, or Bass**.
- 5   Make appropriate adjustments.
- 6  Return to the previous menu.
-  Return to TV viewing.

- If sound quality or volume is not at the level you want, it is recommended to use a separate home theater system or amp to cope with different user environments.
- If you select "Clear Voice II-On", the **Infinite Sound** feature will not operate.
- **Infinite Sound**: Infinite Sound is a patented LG proprietary sound processing technology that strives immersive 5.1 surround sound with just two front speakers.

# AUDIO RESET

Settings of the selected Sound Mode return to the default factory settings.









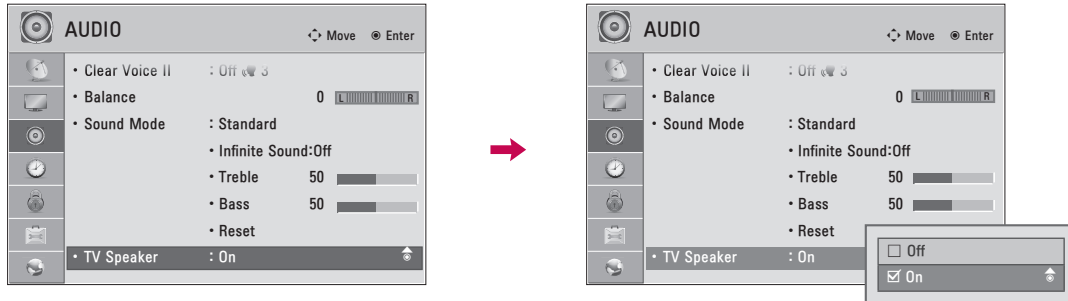

- 1   Select **AUDIO**.
- 2   Select **Reset**.
- 3   Select **Yes**.
- 4  Initialize the adjusted value.
-  Return to TV viewing.

# SOUND & LANGUAGE CONTROL

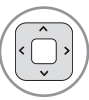
## TV SPEAKERS ON/OFF SETUP

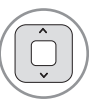
If you wish to use an external Hi-Fi system, turn off the TV's internal speakers.

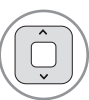

-   Select **AUDIO**.
-   Select **TV Speaker**.
-   Select **On** or **Off**.
-  Return to the previous menu.
-  Return to TV viewing.

## STEREO/SAP BROADCAST SETUP

On analog signals, this TV can receive MTS stereo programs and any SAP (Secondary Audio Program) that accompanies the stereo program if the station transmits an additional sound signal. Mono sound is automatically used if the broadcast is only in Mono.



### Analog TV

- 1 Select **SAP**.
- 2 Select **Mono, Stereo, or SAP**.
- 3 Return to TV viewing.

### Digital TV





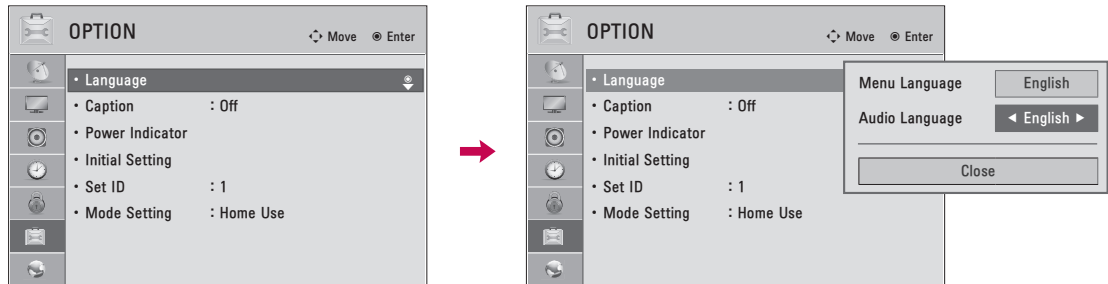

- 1 Select **Multi Audio**.
- 2 Select other languages.
- 3 Return to TV viewing.

# SOUND & LANGUAGE CONTROL

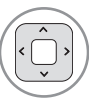
## AUDIO LANGUAGE

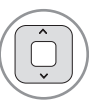
This feature operates only in DTV/Cable DTV mode.

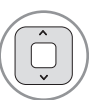
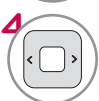









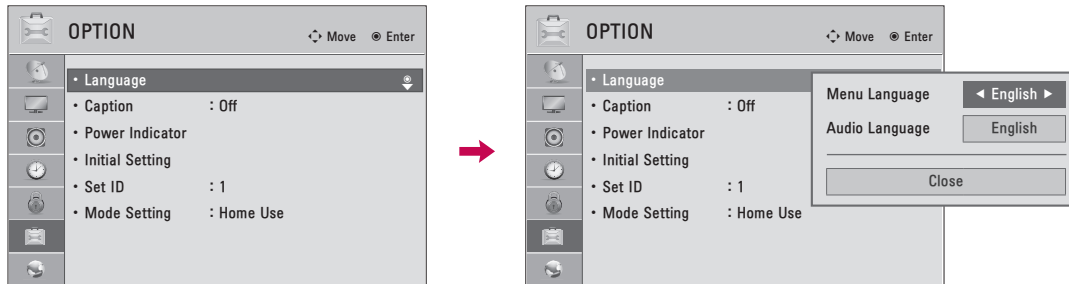

-   Select **OPTION**.
-   Select **Language**.
-   Select **Audio Language**.
-  Select your desired language.
-  Return to the previous menu.
-  Return to TV viewing.



# ON-SCREEN MENUS LANGUAGE SELECTION

The menus can be shown on the screen in the selected language.



-   Select **OPTION**.
-   Select **Language**.
-   Select **Menu Language**.
-  Select your desired language.  
From this point on, the on-screen menus will be shown in the selected language.
-  Return to the previous menu.
-  Return to TV viewing.









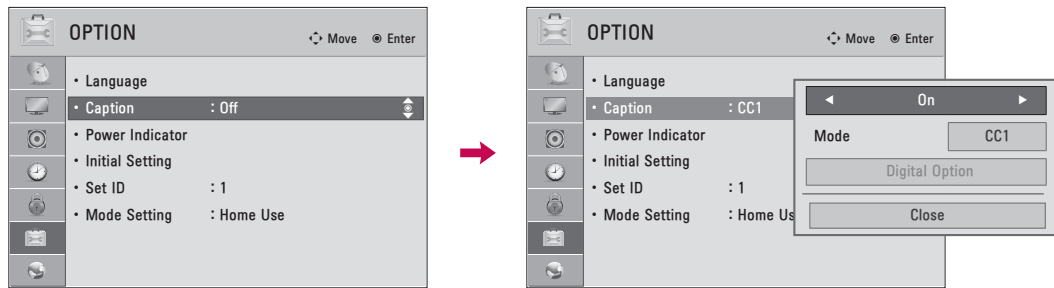

# SOUND & LANGUAGE CONTROL

## CAPTION MODE

### Analog Broadcasting System Captions

Captions are provided to help the hearing impaired watch TV. Select a caption mode for displaying captioning information if provided on a program. Analog caption displays information at any position on the screen and is usually the program's dialog. Caption/Text, if provided by the broadcaster, would be available for both digital and analog channels on the Antenna/Cable. This TV is programmed to memorize the caption/text mode which was last set when you turned the power off. This function is only available when **Caption Mode** is set **On**.



- 1   Select **OPTION**.
- 2   Select **Caption**.
- 3   Select **On**.
- 4   Select **CC1-4** or **Text1-4**.
- 5  Return to the previous menu.
-  Return to TV viewing.

- When selecting **Off**, Sub-menus for Analog, DTV, and Digital Option become disabled.

#### ■ **Caption**

The term for the words that scroll across the bottom of the TV screen; usually the audio portion of the program provided for the hearing impaired.

#### ■ **Text**

The term for the words that appear in a large black frame and almost cover the entire screen; usually messages provided by the broadcaster.







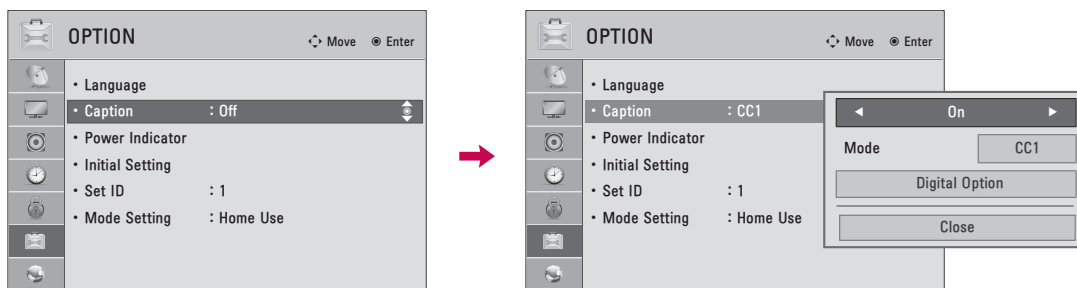

## Digital Broadcasting System Captions

Choose the language you want the DTV/Cable DTV Captions to appear in.

Other Languages can be chosen for digital sources only if they are included on the program.

This function is only available when **Caption Mode** is set **On**.



-   Select **OPTION**.
-   Select **Caption**.
-   Select **On**.
-   Select **CC1-4, Text1-4, or Service1 - 6**.
-  Return to the previous menu.
-  Return to TV viewing.

# SOUND & LANGUAGE CONTROL

## Caption Option

Customize the DTV/Cable DTV captions that appear on your screen.

This function is only available when **Caption Mode** is set **On**.

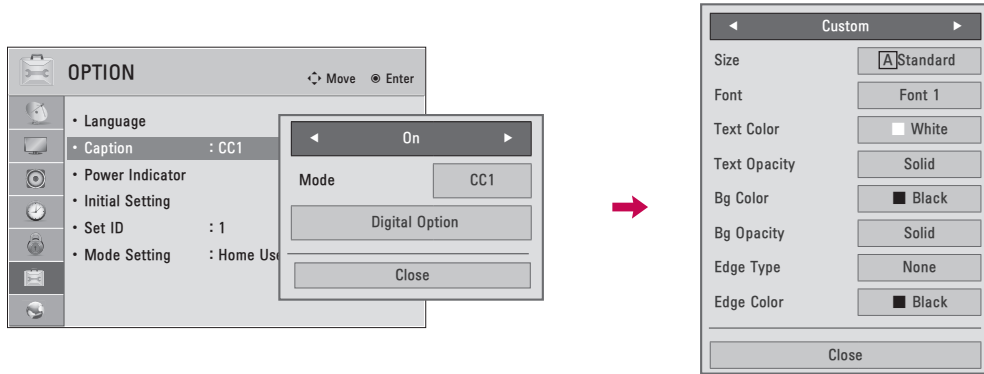



1   Select **OPTION**.

2   Select **Caption**.

3   Select **On**.

4   Select **Digital Option**.

5   Select **Custom**.

6   Customize the **Size**, **Font**, etc., to your preference. A preview icon is provided at the bottom of the screen, use it to see the caption language.

7  Return to the previous menu.

 Return to TV viewing.

- **Size:** Set the word size.
- **Font:** Select a typeface for the text.
- **Text Color:** Choose a color for the text.
- **Text Opacity:** Specify the opacity for the text color.
- **Bg (Background) Color:** Select a background color.
- **Bg (Background) Opacity:** Select the opacity for the background color.
- **Edge Type:** Select an edge type.
- **Edge Color:** Select a color for the edges.

# TIME SETTING

## CLOCK SETTING









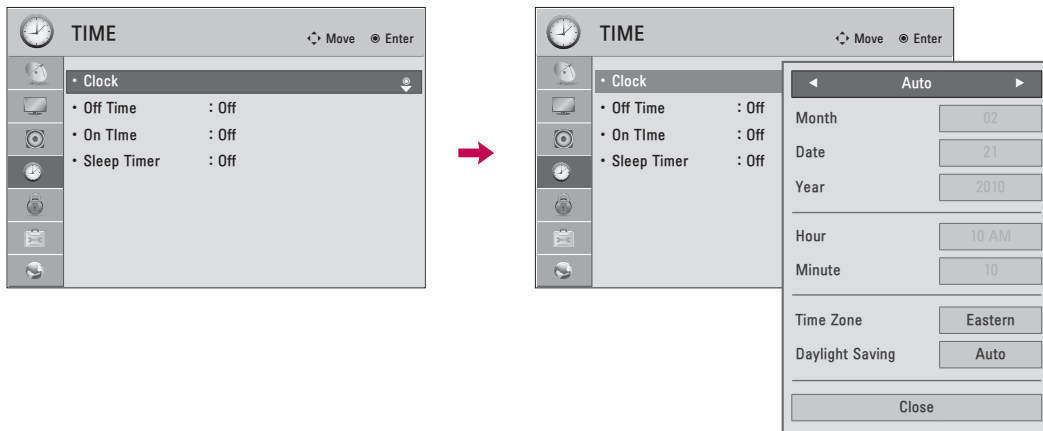



### Auto Clock Setup

The time is set automatically from a digital channel signal.

The digital channel signal includes information for the current time provided by the broadcasting station.

Set the clock manually if the current time is set incorrectly by the auto clock function.











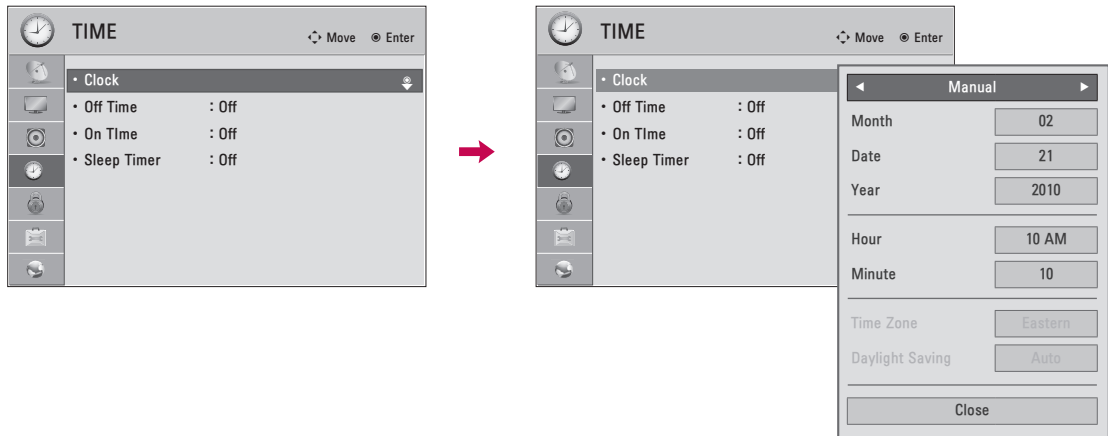

-   Select **TIME**.
-   Select **Clock**.
-   Select **Auto**.
-   Select your viewing area time zone.  
**USA: Eastern, Central, Mountain, Pacific, Alaska, or Hawaii.**  
**Canada, Philippines: Eastern, Central, Mountain, Pacific, New Foundland, or Atlantic.**
-   Select **Auto**, **Off**, or **On** (depending on whether or not your viewing area observes Daylight Saving time).
-  Return to the previous menu.
-  Return to TV viewing.

# TIME SETTING

## Manual Clock Setup

If the current time setting is wrong, reset the clock manually.



-   Select **TIME**.
-   Select **Clock**.
-   Select **Manual**.
-  Select the Year, Month, Date, Hour, or Minute option.
-  Set the Year, Month, Date, Hour, or Minute option.
-  Return to the previous menu.
-  Return to TV viewing.

# AUTO ON/OFF TIME SETTING

This function operates only if the current time has been set.

The **Off Time** function overrides the **On Time** function if they are both set to the same time.

The TV must be in standby mode for the **On Time** to work.

If you do not press any button within 2 hours after the TV turns on with the **On Time** function, the TV will automatically revert to standby mode.

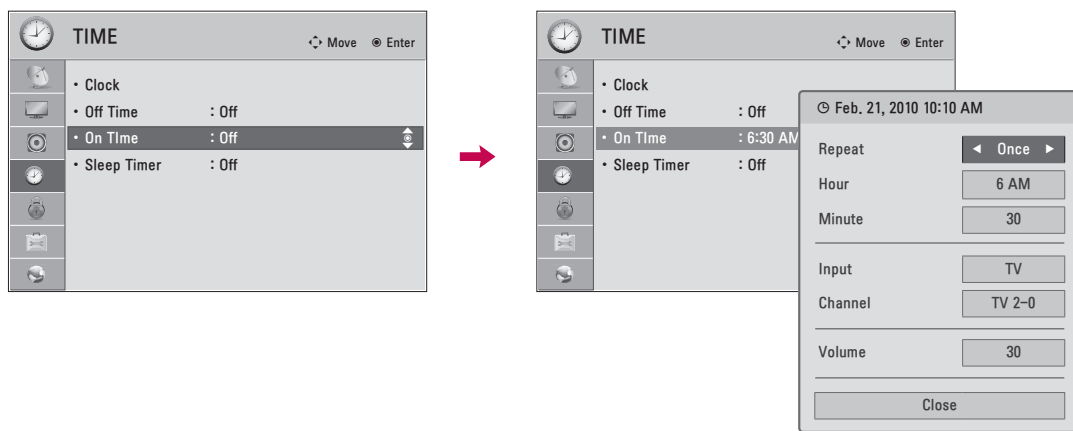

- 1 Select **TIME**.
- 2 Select **Off Time** or **On Time**.
- 3 Select **Repeat**.
- 4 Select **Off**, **Once**, **Daily**, **Mon.~Fri.**, **Mon.~Sat.**, **Sat.~ Sun.**, or **Sun.**.
- 5 Select and set Hour or Minute.
- 6 Return to the previous menu.
- Return to TV viewing.

- To cancel **On/Off Time** function, select **Off**.
- Only for **On Time** function

- 1 Select **Input**.
- 2 Select the desired input source.
- 3 When Selecting **TV**: set the channel at turn-on.
- 4 Adjust to sound level at turn-on.







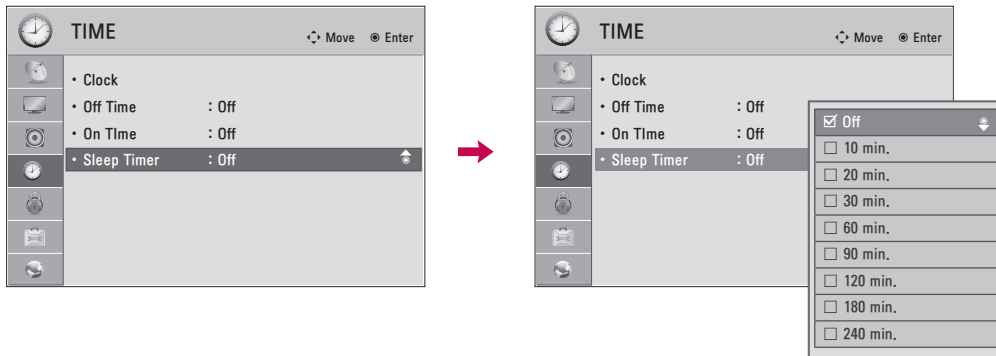

# TIME SETTING

## SLEEP TIMER SETTING

The Sleep Timer turns the TV off at the preset time.

Note that this setting is cleared when the TV is turned off.



- 1   Select **TIME**.
- 2   Select **Sleep Timer**.
- 3   Make appropriate adjustments.
- 4  Return to the previous menu.
-  Return to TV viewing.

- To cancel the **Sleep Timer**, select **Off**.
- You can also adjust **Sleep Timer** in the **Q.MENU**.



# PARENTAL CONTROL / RATINGS

Parental Control can be used to block specific channels, ratings and other viewing sources.

The Parental Control Function (V-Chip) is used to block program viewing based on the ratings sent by the broadcasting station. The default setting is to allow all programs to be viewed. Viewing can be blocked by choosing the type of the program and the categories. It is also possible to block all program viewing for a time period. To use this function, the following must be done :

1. Set ratings and categories to be blocked.
2. Specify a password
3. Enable the lock

## V-Chip rating and categories

Rating guidelines are provided by broadcasting stations. Most television programs and television movies can be blocked by TV Rating and/or Individual Categories. Movies that have been shown at the theaters or direct-to-video movies use the Movie Rating System (MPAA) only.

## Ratings for Television programs including made-for-TV movies:

- TV-G (General audience)
- TV-PG (Parental guidance suggested)
- TV-14 (Parents strongly cautioned)
- TV-MA (Mature audience only)
- TV-Y (All children)
- TV-Y7 (Children 7 years older)

# SET PASSWORD & LOCK SYSTEM

## Setting up Your Password

Set up blocking schemes to block specific channels, ratings, and external viewing sources.



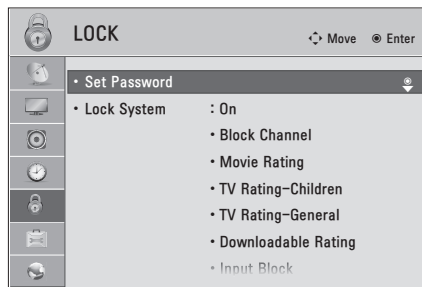

A password is required to gain access to this menu.

For USA

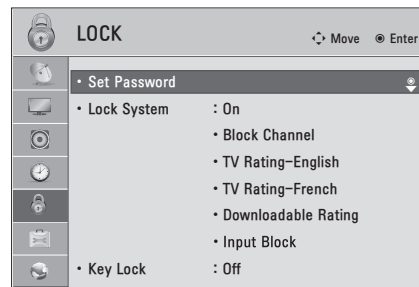

For Canada, Philippines



1.    Select **LOCK**.
2.  Input the password.



- Enter the password as requested.
- The TV is set up with the initial password "0-0-0-0".
- If you forget your password, press "0-3-2-5" on the remote control.

# PARENTAL CONTROL / RATINGS

## Set Password

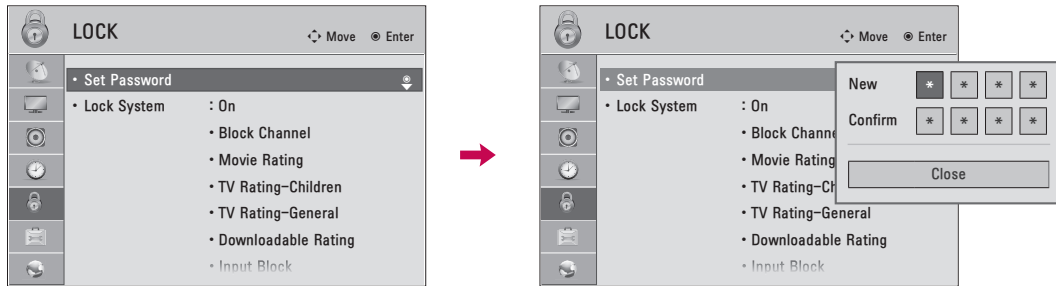

Change the password by inputting a new password twice.





1    Select **LOCK**.

2  Input the password.

3  Select **Set Password**.

4   Choose any 4 digits for your new password.  
As soon as the 4 digits are entered, re-enter the same 4 digits on the **Confirm**.



5  Return to the previous menu.

 Return to TV viewing.

## Lock System

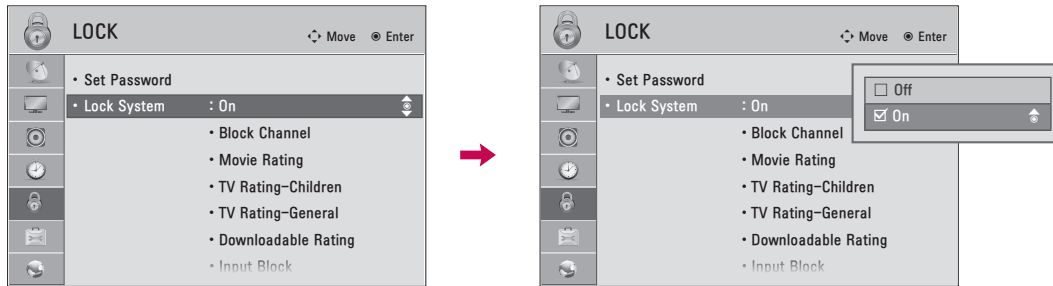
Enables or disables the blocking scheme you set up previously.





1    Select **LOCK**.

2  Input the password.

3  Select **Lock System**.

4   Select **On** or **Off**.

5  Return to the previous menu.

 Return to TV viewing.







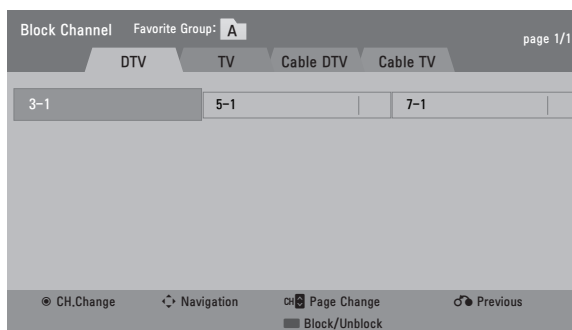
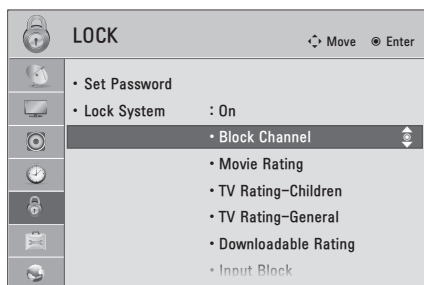

■ When you select **On**, the Lock System is enable.

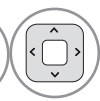
# PARENTAL CONTROL / RATINGS

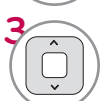
## CHANNEL BLOCKING

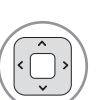
Blocks any channels that you do not want to watch or that you do not want your children to watch.



-    Select **LOCK**.
-  Input the password.
-  Select **Block Channel**.
-   Select a channel to block or unblock.
-  Block or unblock a channel.
-  Return to the previous menu.
-  Return to TV viewing.

■ If a channel is locked, enter the password to unlock it temporarily.

# MOVIE & TV RATING

## Movie Rating (MPAA)- For USA

Blocks movies according to the movie ratings limits specified, so children cannot view certain movies. You can set the ratings limit by blocking out all the movies with the ratings above a specified level. Keep in mind that the movie ratings limit only applies to movies shown on TV, not TV programs, such as soap operas.

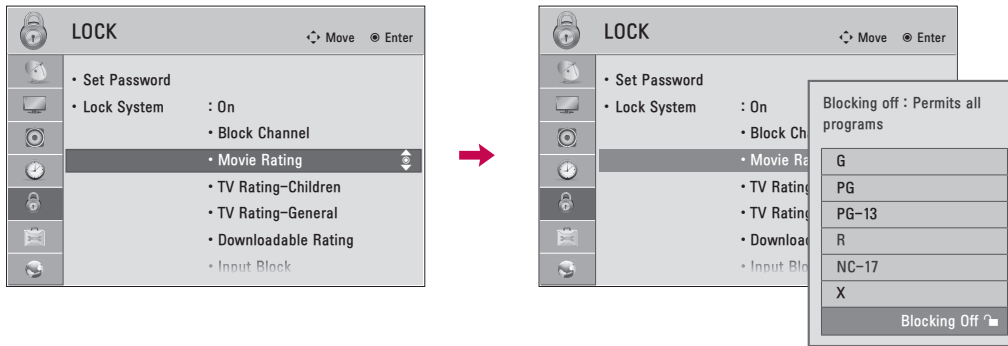

- 1 Select **LOCK**.
- 2 Input the password.
- 3 Select **Movie Rating**.
- 4 Select **G, PG, PG-13, R, NC-17, X, or Blocking Off**.
- 5 Return to the previous menu.
- Return to TV viewing.



- If **Movie Rating, TV Rating-Children** or **TV Rating-General** is locked, enter the password to unlock it temporarily.
- **G** (General audience)
- **PG** (Parental guidance suggested)
- **PG-13** (Parents strongly cautioned)
- **R** (Restricted)
- **NC-17** (No one 17 and under admitted)
- **X** (Adult only)
- **Blocking Off** (Permits all programs)
- If you set PG-13: G and PG movies will be available, PG-13, R, NC-17 and X will be blocked.

# PARENTAL CONTROL / RATINGS

## TV Rating Children - For USA

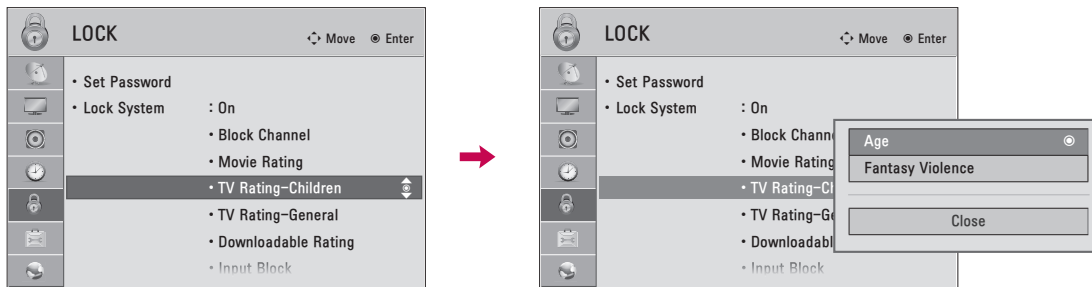
Prevents children from watching certain children's TV programs, according to the ratings limit set. The children rating does not apply to other TV programs. Unless you block certain TV programs intended for mature audiences in the TV Rating - sub menu, your children can view those programs.



1    Select **LOCK**.

2  Input the password.

3  Select **TV Rating-Children**.

4   Select **Age** or **Fantasy Violence**.

5   Select block options.

6  Return to the previous menu.









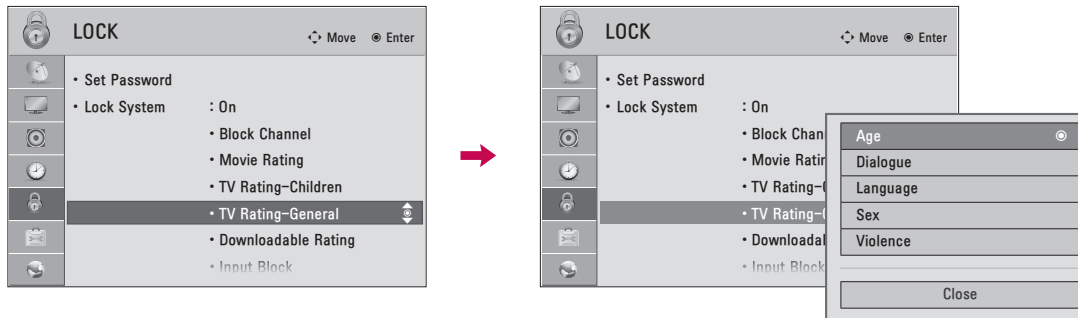

 Return to TV viewing.

- **Age** (applies to TV-Y, TV-Y7)
- **Fantasy Violence** (applies to TV-Y7)

## TV Rating General - For USA

Based on the ratings, blocks certain TV programs that you and your family do not want to view.



- 1    Select **LOCK**.
- 2  Input the password.
- 3  Select **TV Rating-General**.
- 4   Select **Age, Dialogue, Language, Sex** or **Violence**.
- 5   Select block options.
- 6  Return to the previous menu.
-  Return to TV viewing.

- **Age** (applies to TV-G,TV-PG,TV-14,TV-MA).
- **Dialogue**-sexual dialogue (applies to TV-PG,TV-14).
- **Language**-adult language (applies to TV-PG, TV-14, TV-MA).
- **Sex**-sexual situations (applies to TV-PG, TV-14, TV-MA).
- **Violence** (applies to TV-PG, TV-14, TV-MA).

# PARENTAL CONTROL / RATINGS

## TV Rating English - For CANADA, PHILIPPINES

Selecting Canadian English rating system.

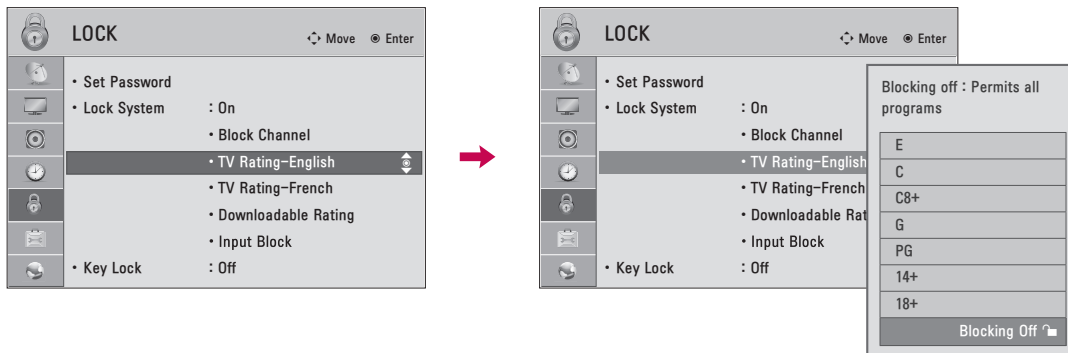

1. Select **LOCK**.
2. Input the password.
3. Select **TV Rating-English**.
4. Select **E, C, C8+, G, PG, 14+, 18+, or Blocking Off**.
5. Return to the previous menu.
- Return to TV viewing.

- If TV Rating-English or TV Rating-French is locked, enter the password to unlock it temporarily.
- **E** (Exempt)
- **C** (Children)
- **C8+** (Children eight years and older)
- **G** (General programming, suitable for all audiences)
- **PG** (Parental Guidance)
- **14+** (Viewers 14 years and older)
- **18+** (Adult programming)
- **Blocking Off** (Permits all programs)



## TV Rating French - For CANADA, PHILIPPINES

Selecting Canadian French rating system.

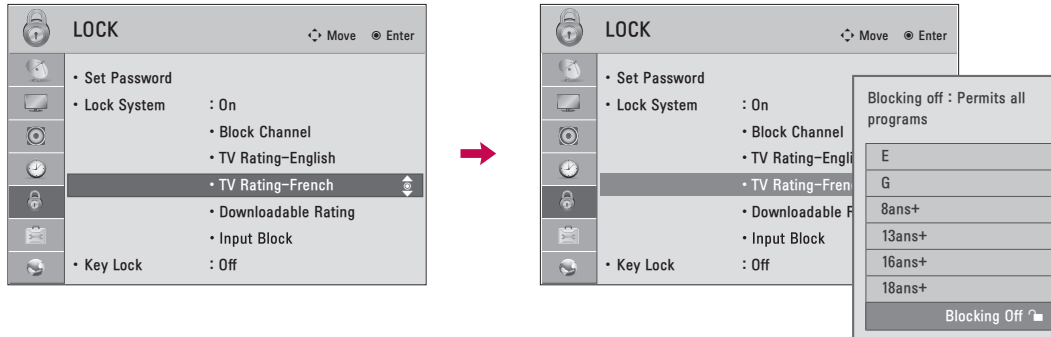

**1** Select **LOCK**.

**2** Input the password.

**3** Select **TV Rating-French**.

**4** Select **E, G, 8ans+, 13ans+, 16ans+, 18ans+,** or **Blocking Off**.

**5** Return to the previous menu.

Return to TV viewing.

- **E** (Exempt)
- **G** (General)
- **8ans+** (General-Not convenient for little children)
- **13ans+** (Not convenient for children of 13 years and younger)
- **16ans+** (Not convenient for children of 16 years and younger)
- **18ans+** (This programs is only for adults)
- **Blocking Off** (Permits all programs)

# PARENTAL CONTROL / RATINGS











## DOWNLOADABLE RATING

This function is available only for digital channels.

This function operates only when TV has received Region5 Rating data.



■ Based on rating table, your TV's OSD (On Screen Display) may differ slightly from what is shown in this manual.

-    Select **LOCK**.
-  Input the password.
-  Select **Downloadable Rating**.
-   Select desired **Downloadable Rating** option.
-   Select desired option and block it.
-  Return to the previous menu.
-  Return to TV viewing.

■ If a Downloadable rating is locked, enter the password to unlock it temporarily.

# EXTERNAL INPUT BLOCKING

Enables you to block an input.

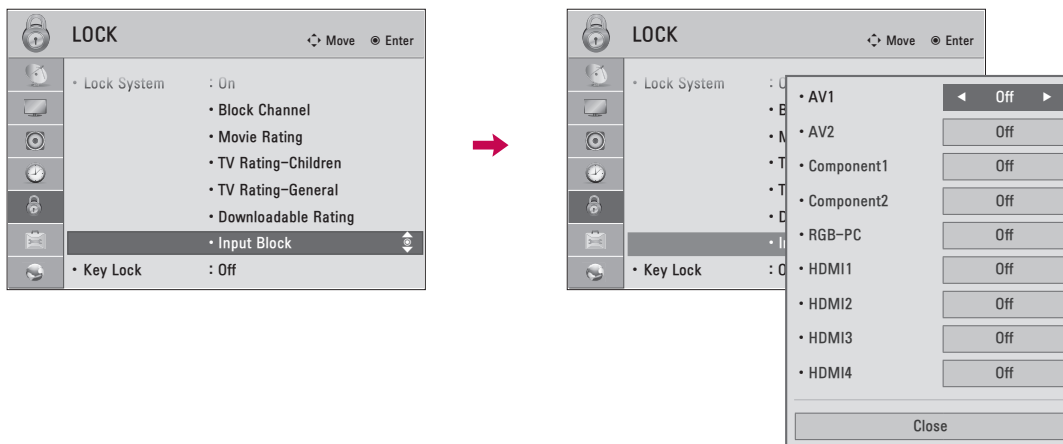

1 Select **LOCK**.

2 Input the password.

3 Select **Input Block**.

4 Select input source.

5 Select **On** or **Off**.

6 Return to the previous menu.

Return to TV viewing.



# PARENTAL CONTROL / RATINGS

## KEY LOCK

This feature can be used to prevent unauthorized viewing by locking out the front panel controls, so that it can only be used with the remote control.

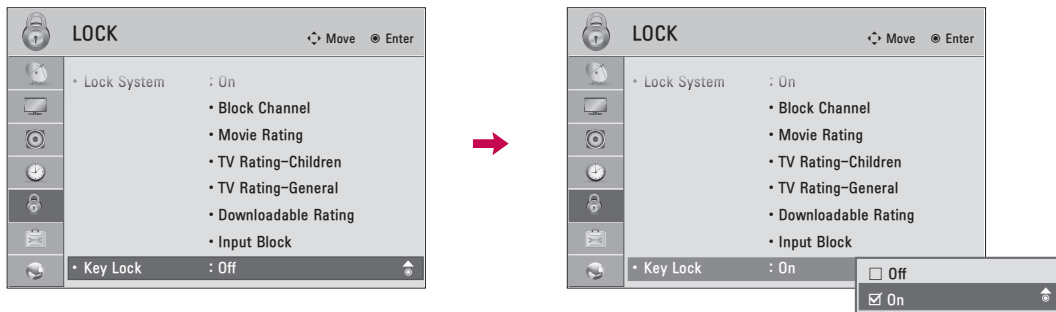
This TV is programmed to remember which option it was last set to even if you turn the TV off.





1    Select **LOCK**.









2  Input the password.

3  Select **Key Lock**.

4   Select **On** or **Off**.

5  Return to the previous menu.

 Return to TV viewing.

- In Key Lock 'On', if the TV is turned off, press the  / I, **INPUT, CH** (  or  ) button on the TV or **POWER, INPUT, CH** ( ) or **NUMBER** buttons on the remote control.
- With the **Key Lock On**, the display ' **Key Lock**' appears on the screen if any button on the front panel is pressed while viewing the TV.

# APPENDIX

## TROUBLESHOOTING

Abnormal Operation	
The remote control doesn't work	<ul style="list-style-type: none"> <li>■ Check to see if there is any object between the product and the remote control causing obstruction. Ensure you are pointing the remote control directly at the TV.</li> <li>■ Ensure that the batteries are installed with correct polarity (+ to +, - to -).</li> <li>■ Ensure that the correct remote operating mode is set: TV, VCR etc.</li> <li>■ Install new batteries. <span style="float: right;">*This feature is not available for all models.</span></li> </ul>
TV turns off suddenly	<ul style="list-style-type: none"> <li>■ Is the sleep timer set?</li> <li>■ Check the power control settings. Power interrupted.</li> <li>■ If there is no signal, the TV turns off automatically in 15 minutes.</li> </ul>

Video Problems	
No picture & No sound	<ul style="list-style-type: none"> <li>■ Check whether the product is turned on.</li> <li>■ Try another channel. The problem may be with the broadcast.</li> <li>■ Is the power cord inserted into wall power outlet?</li> <li>■ Check your antenna direction and/or location.</li> <li>■ Test the wall power outlet, plug another product's power cord into the outlet where the product's power cord was plugged in.</li> </ul>
Picture appears slowly after switching on	<ul style="list-style-type: none"> <li>■ This is normal, the image is muted during the product startup process. Please contact your service center, if the picture has not appeared after five minutes.</li> </ul>
No or poor color or poor picture	<ul style="list-style-type: none"> <li>■ Adjust Color in menu option.</li> <li>■ Keep a sufficient distance between the product and the VCR.</li> <li>■ Try another channel. The problem may be with the broadcast.</li> <li>■ Are the video cables installed properly?</li> <li>■ Activate any function to restore the brightness of the picture.</li> </ul>
Horizontal/vertical bars or picture shaking	<ul style="list-style-type: none"> <li>■ Check for local interference such as an electrical appliance or power tool.</li> </ul>
Poor reception on some channels	<ul style="list-style-type: none"> <li>■ Station or cable product experiencing problems, tune to another station.</li> <li>■ Station signal is weak, reorient antenna to receive weaker station.</li> <li>■ Check for sources of possible interference.</li> </ul>
Lines or streaks in pictures	<ul style="list-style-type: none"> <li>■ Check antenna (Change the direction of the antenna).</li> </ul>
No picture when connecting HDMI	<ul style="list-style-type: none"> <li>■ If an HDMI cable doesn't support High Speed HDMI, it can cause flickers or no screen display. In this case use the latest cables that support High Speed HDMI.</li> </ul>

# APPENDIX

Audio Problems	
No output from one of the speakers	<ul style="list-style-type: none"> <li>Adjust Balance in menu option.</li> </ul>
Unusual sound from inside the product	<ul style="list-style-type: none"> <li>A change in ambient humidity or temperature may result in an unusual noise when the product is turned on or off and does not indicate a fault with the product.</li> </ul>
No sound when connecting HDMI/USB	<ul style="list-style-type: none"> <li>Check High Speed HDMI cable.</li> <li>Check USB cable over version 2.0.</li> <li>Use normal MP3 file. <small>*This feature is not available for all models.</small></li> </ul>

PC Mode Problems	
The signal is out of range	<ul style="list-style-type: none"> <li>Adjust resolution, horizontal frequency, or vertical frequency on the PC.</li> <li>Check the input source.</li> </ul>
Vertical bar or stripe on background & Horizontal Noise & Incorrect position	<ul style="list-style-type: none"> <li>Activate the Auto configure feature or adjust size, phase, or H/V position. (Option)</li> </ul>
Screen color is unstable or single color	<ul style="list-style-type: none"> <li>Check the signal cable.</li> <li>Reinstall the PC video card.</li> </ul>
When connecting the HDMI cable to the PC, there is no audio.	<ul style="list-style-type: none"> <li>Check the manual for the video card in the PC to see if it supports HDMI audio and how to set it up properly.</li> </ul>

## Movie List Problems

The file does not appear on the Movie List.	<ul style="list-style-type: none"><li>■ Check whether the file extension is supported.</li></ul>
Message is displayed saying "This file is invalid" or the audio is working normally but the video is not working normally.	<ul style="list-style-type: none"><li>■ Check whether the file is playing normally on a PC. (Check whether the file is damaged.)</li><li>■ Check whether the resolution is supported.</li><li>■ Check whether the video/audio codec is supported.</li><li>■ Check whether the frame rate is supported.</li></ul>
Message is displayed saying "Unsupported Audio" or the video is working normally but the audio is not working normally.	<ul style="list-style-type: none"><li>■ Check whether the file is playing normally on a PC. (Check whether the file is damaged.)</li><li>■ Check whether the audio codec is supported.</li><li>■ Check whether the bit rate is supported.</li><li>■ Check whether the sample rate is supported.</li></ul>
Subtitle is not working.	<ul style="list-style-type: none"><li>■ Check whether the file is playing normally on a PC. (Check whether the file is damaged.)</li><li>■ Check whether the video file and subtitle file name are the same.</li><li>■ Check whether the video file and subtitle file are located in the same folder.</li><li>■ Check whether the subtitle file is supported.</li><li>■ Check whether the language is supported. (When you open the subtitle file on a PC, you can check the language of the subtitle file.)</li></ul>

# APPENDIX

## MAINTENANCE

Early malfunctions can be prevented. Careful and regular cleaning can extend the amount of time you can enjoy your new TV.

Caution: Be sure to turn the power off and unplug the power cord before you begin any cleaning.

### Cleaning the Screen

- 1 Here's a great way to keep the dust off your screen for a while. Wet a soft cloth in a mixture of lukewarm water and a little fabric softener or dish washing detergent. Wring the cloth until it's almost dry, and then use it to wipe the screen.
- 2 Make sure the excess water is off the screen, and then let it air-dry before you turn on your TV.

### Cleaning the Cabinet

- To remove dirt or dust, wipe the cabinet with a soft, dry, lint-free cloth.
- Please be sure not to use a wet cloth.

### Extended Absence

#### CAUTION

- ▶ If you expect to leave your TV dormant for a long time (such as a vacation), it's a good idea to unplug the power cord to protect against possible damage from lightning or power surges.



## PRODUCT SPECIFICATIONS

MODELS		47LX9500 (47LX9500-UA)	55LX9500 (55LX9500-UA)
Dimensions (Width x Height x Depth)	With stand	1085.9 mm x 710.6 mm x 255.0 mm (42.7 inch x 27.9 inch x 10.0 inch)	1255.8 mm x 805.0 mm x 255.0 mm (49.4 inch x 31.6 inch x 10.0 inch)
	Without stand	1085.9 mm x 654.2 mm x 31.6 mm (42.7 inch x 25.7 inch x 1.2 inch)	1255.8 mm x 749.6 mm x 31.6 mm (49.4 inch x 29.5 inch x 1.2 inch)
Weight	With stand	26.7 kg (58.8 lbs)	32.7 kg (72.0 lbs)
	Without stand	22.1 kg (48.7 lbs)	28.1 kg (61.9 lbs)

Power requirement	AC 100 - 240 V~ 50/60 Hz	
Television System	NTSC-M, ATSC, 64 & 256 QAM	
Program Coverage	VHF 2-13, UHF 14-69, CATV 1-135, DTV 2-69, CADTV 1-135	
External Antenna Impedance	75 Ω	
Environment condition	Operating Temperature	0 °C to 40 °C (32 °F to 104 °F)
	Operating Humidity	Less than 80 %
	Storage Temperature	-20 °C to 60 °C (-4 °F to 140 °F)
	Storage Humidity	Less than 85 %

- The specifications shown above may be changed without prior notice for quality improvement.

# APPENDIX

MODELS		47LEX8 (47LEX8-UA)	55LEX8 (55LEX8-UA)
Dimensions (Width x Height x Depth)	With stand	1126.6 mm x 757.9 mm x 284.4 mm (44.3 inch x 29.8 inch x 11.1 inch)	1306.0 mm x 867.0 mm x 345.0 mm (51.4 inch x 34.1 inch x 13.5 inch)
	Without stand	1126.6 mm x 692.0 mm x 29.3 mm (44.3 inch x 27.2 inch x 1.1 inch)	1306.0 mm x 797.0 mm x 30.7 mm (51.4 inch x 31.3 inch x 1.2 inch)
Weight	With stand	22.9 kg (50.4 lbs)	34.5 kg (76.0 lbs)
	Without stand	19.6 kg (43.2 lbs)	28.8 kg (63.4 lbs)

MODELS		60LEX9 (60LEX9-UA)	72LEX9 (72LEX9-UA)
Dimensions (Width x Height x Depth)	With stand	1126.6 mm x 757.9 mm x 284.4 mm (44.3 inch x 29.8 inch x 11.1 inch)	1306.0 mm x 867.0 mm x 345.0 mm (51.4 inch x 34.1 inch x 13.5 inch)
	Without stand	1126.6 mm x 692.0 mm x 29.3 mm (44.3 inch x 27.2 inch x 1.1 inch)	1306.0 mm x 797.0 mm x 30.7 mm (51.4 inch x 31.3 inch x 1.2 inch)
Weight	With stand	22.9 kg (50.4 lbs)	34.5 kg (76.0 lbs)
	Without stand	19.6 kg (43.2 lbs)	28.8 kg (63.4 lbs)

Power requirement	AC 120 V ~ 50 / 60 Hz		
Television System	NTSC-M, ATSC, 64 & 256 QAM		
Program Coverage	VHF 2-13, UHF 14-69, CATV 1-135, DTV 2-69, CADTV 1-135		
External Antenna Impedance	75 Ω		
Environment condition	Operating Temperature	0 °C to 40 °C (32 °F to 104 °F)	
	Operating Humidity	Less than 80 %	
	Storage Temperature	-20 °C to 60 °C (-4 °F to 140 °F)	
	Storage Humidity	Less than 85 %	

- The specifications shown above may be changed without prior notice for quality improvement.

MODELS		<b>50PK950</b> (50PK950-UA, 50PK950-UF) <b>50PX950</b> (50PX950-UA, 50PX950-UF)	<b>60PK950</b> (60PK950-UA, 60PK950-UF) <b>60PX950</b> (60PX950-UA, 60PX950-UF)
Dimensions (Width x Height x Depth)	With stand	1190.0 mm x 804.5 mm x 294.5 mm (46.8 inch x 31.6 inch x 11.5 inch)	1408.8 mm x 937.9 mm x 384.0 mm (55.4 inch x 36.9 inch x 15.1 inch)
	Without stand	1190.0 mm x 737.0 mm x 52.4 mm (46.1 inch x 29.0 inch x 2.0 inch)	1408.8 mm x 860.7 mm x 52.4 mm (55.4 inch x 33.8 inch x 2.0 inch)
Weight	With stand	34.8 kg (76.7 lbs)	50.9 kg (112.2 lbs)
	Without stand	30.2 kg (66.5 lbs)	43.3 kg (95.4 lbs)

Power requirement	AC 100-240 V ~ 50 / 60 Hz	
Television System	NTSC-M, ATSC, 64 & 256 QAM	
Program Coverage	VHF 2-13, UHF 14-69, CATV 1-135, DTV 2-69, CADTV 1-135	
External Antenna Impedance	75 Ω	
Environment condition	Operating Temperature	0 °C to 40 °C (32 °F to 104 °F)
	Operating Humidity	Less than 80 %
	Storage Temperature	-20 °C to 60 °C (-4 °F to 140 °F)
	Storage Humidity	Less than 85 %

- The specifications shown above may be changed without prior notice for quality improvement.

# APPENDIX

## IR CODES

\*This feature is not available for all models.

### 1. How to Connect

- Connect your wired remote control to the Remote Control port on the TV.

### 2. Remote Control IR Codes

#### ■ Output waveform

Single pulse, modulated with 37.917 KHz signal at 455 KHz

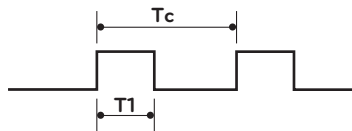

Carrier frequency  
 $FCAR = 1/TC = fOSC/12$   
 Duty ratio =  $T1/TC = 1/3$

#### ■ Configuration of frame

1st frame

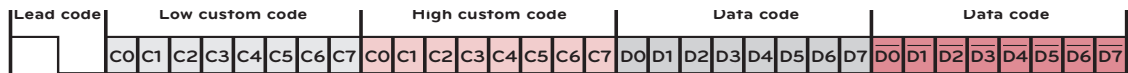

Repeat frame

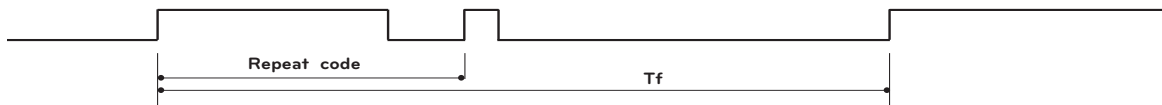

#### ■ Lead code

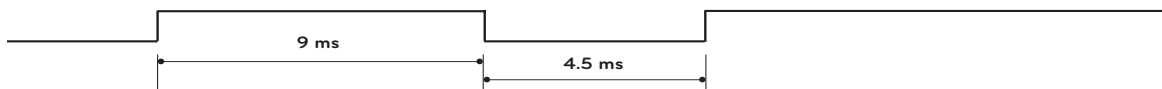

#### ■ Repeat code



#### ■ Bit description: Tf

Bit "0"

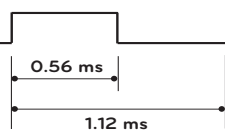

Bit "1"

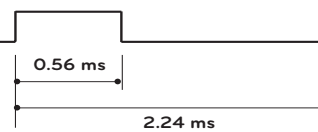

#### ■ Frame interval: Tf

The waveform is transmitted as long as a key is depressed.

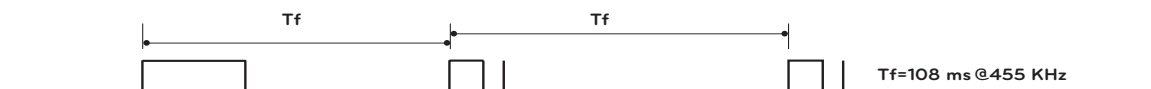

Code (Hexa)	Function	Note	Code (Hexa)	Function	Note
00	CH ^	Remote Control Button	B0	▶	Remote Control Button
01	CH v	Remote Control Button	B1	■	Remote Control Button
02	VOL +	Remote Control Button	BA		Remote Control Button
03	VOL -	Remote Control Button	D6	TV	Discrete IR Code (TV Input Selection)
06	›	Remote Control Button			
07	‹	Remote Control Button	C4	POWER ON	Discrete IR Code (Only Power On)
08	⏻	Remote Control Button (Power On/Off)	C5	POWER OFF	Discrete IR Code (Only Power Off)
09	MUTE/DELETE	Remote Control Button			
0B	INPUT	Remote Control Button	5A	AV1	Discrete IR Code (AV1 Input Selection)
0F	TV	Remote Control Button			
10-19	Number 0-9	Remote Control Button	D0	AV2	Discrete IR Code (AV2 Input Selection)
1A	FLASHBK	Remote Control Button			
1E	FAV/MARK	Remote Control Button	BF	COMPONENT1	Discrete IR Code (Component1 Input Selection)
28	BACK	Remote Control Button			
30	AV MODE	Remote Control Button	D4	COMPONENT2	Discrete IR Code (Component2 Input Selection)
40	^	Remote Control Button			
41	v	Remote Control Button	D5	RGB-PC	Discrete IR Code (RGB-PC Input Selection)
43	MENU	Remote Control Button			
44	ENTER	Remote Control Button	CE	HDMI1	Discrete IR Code (HDMI1 Input Selection)
45	Q.MENU	Remote Control Button			
4C	- (Dash)/LIST	Remote Control Button	CC	HDMI2	Discrete IR Code (HDMI2 Input Selection)
5B	EXIT	Remote Control Button			
58	WIDGETS	Remote Control Button	E9	HDMI3	Discrete IR Code (HDMI3 Input Selection)
59	NETCAST	Remote Control Button			
61	BLUE/(L/R SELECT)	Remote Control Button	DA	HDMI4	Discrete IR Code (HDMI4 Input Selection)
63	YELLOW	Remote Control Button			
71	GREEN	Remote Control Button	76	Ratio 4:3	Discrete IR Code (Only 4:3 Mode)
72	RED	Remote Control Button			
79	RATIO	Remote Control Button	77	Ratio 16:9	Discrete IR Code (Only 16:9 Mode)
7E	SIMPLINK	Remote Control Button			
8E	▶▶	Remote Control Button	AF	Ratio Zoom	Discrete IR Code (Only Zoom Mode)
8F	◀◀	Remote Control Button			
95	ENERGY SAVING	Remote Control Button	DC	3D	Remote Control Button
AA	INFO	Remote Control Button			

■ Use this feature depending on your models.

# APPENDIX

## EXTERNAL CONTROL THROUGH RS-232C

The RS-232C port allows you connect the RS-232C input jack to an external control device (such as a computer or an A/V control system) to control the TV's functions externally.

- Note: RS-232C on this unit is intended to be used with third party RS-232C control hardware and software.

The instructions below are provided to help with programming software or to test functionality using telenet software.

### RS-232C Setup

i.e)

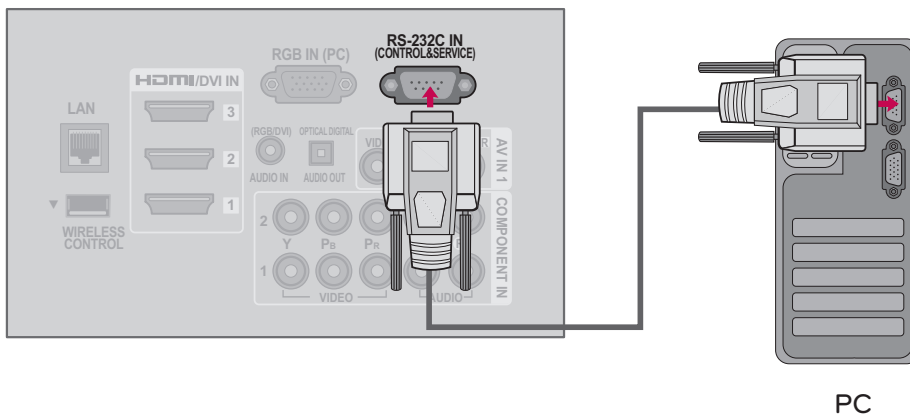

### Type of Connector; D-Sub 9-Pin Male

### Communication Parameters

No.	Pin Name
1	No connection
2	RXD (Receive data)
3	TXD (Transmit data)
4	DTR (DTE side ready)
5	GND
6	DSR (DCE side ready)
7	RTS (Ready to send)
8	CTS (Clear to send)
9	No Connection

- Baud rate : 9600 bps (UART)
- Data length : 8 bits
- Parity : None
- Stop bit : 1 bit
- Communication code : ASCII code
- Use a crossed (reverse) cable.

#### ! NOTE

- ▶ This product has command echo back in the RS-232C Command.

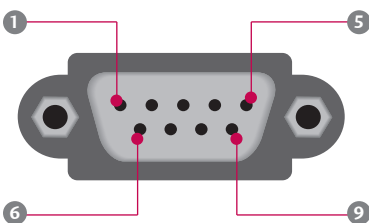

## RS-232C Configurations

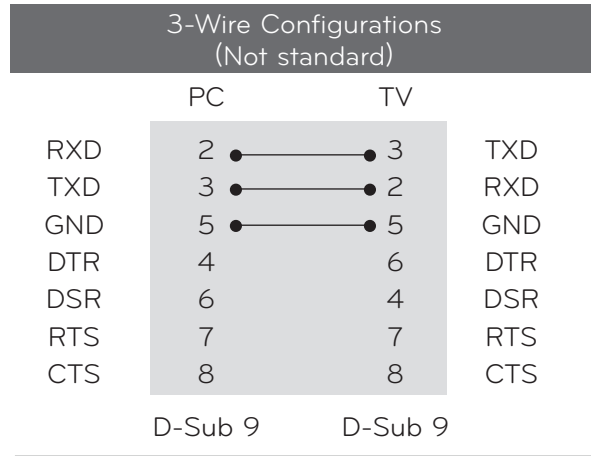
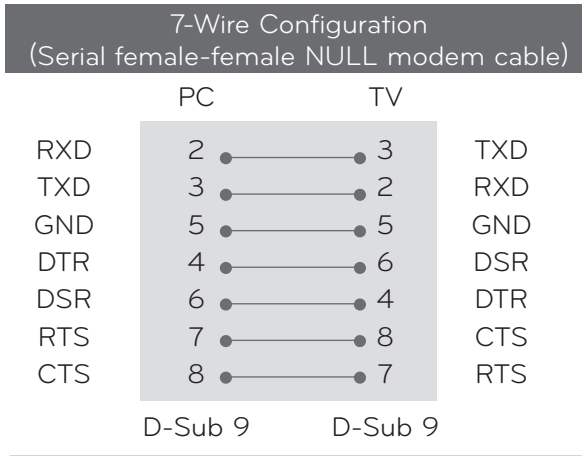

## Set ID

Use this function to specify a TV ID number.  
Refer to 'Real Data Mapping'.

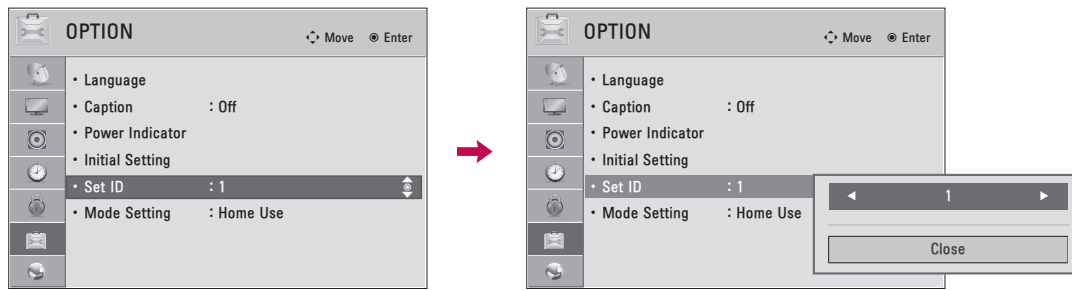

- 1 Select **OPTION**.
- 2 Select **Set ID**.
- 3 Choose the desired TV ID number.  
The adjustment range of Set ID is 1~99.
- 4 Return to the previous menu.
- Return to TV viewing.

### ■ Real data mapping

0	Step 0
⋮	
A	Step 10 (Set ID 10)
⋮	
F	Step 15 (Set ID 15)
10	Step 16 (Set ID 16)
⋮	
63	Step 99 (Set ID 99)
64	Step 100

# APPENDIX

## Command Reference List

	COMMAND1	COMMAND2	DATA (Hexadecimal)
01. Power	k	a	00 - 01
02. Input Select	x	b	▶ P185
03. Aspect Ratio	k	c	▶ P185
04. Screen Mute	k	d	00 - 01
05. Volume Mute	k	e	00 - 01
06. Volume Control	k	f	00 - 64
07. Contrast	k	g	00 - 64
08. Brightness	k	h	00 - 64
09. Color	k	i	00 - 64
10. Tint	k	j	00 - 64
11. Sharpness	k	k	00 - 64
12. OSD Select	k	l	00 - 01
13. Remote Control Lock Mode	k	m	00 - 01
14. Treble	k	r	00 - 64
15. Bass	k	s	00 - 64
16. Balance	k	t	00 - 64
17. Color Temperature	x	u	00 - 64
18. ISM Method	j	p	▶ P186
19. Energy Saving	j	q	▶ P186
20. Auto Configuration	j	u	▶ P186
22. Channel Add/Del	m	b	00 - 01
23. Key	m	c	▶ P187
24. Backlight	m	g	00 - 64

For LED LCD TV

For Plasma TV

	COMMAND1	COMMAND2	DATA00 (Hexadecimal)	DATA01 (Hexadecimal)
21. Channel Tuning	m	a	physical program high	major program low
			DATA02 (Hexadecimal)	DATA03 (Hexadecimal)
	major low	minor high	minor low	attribute

## Transmission / Receiving Protocol

### Transmission

[Command1][Command2][ ][Set ID][ ][Data][Cr]

[Command 1] : First command to control the set. (j, k, m or x)

[Command 2] : Second command to control the set.

[Set ID] : You can adjust the set ID to choose desired TV ID number in Setup menu. Adjustment range is 1-99. When selecting Set ID '0', every connected the TV is controlled. Set ID is indicated as decimal (1-99) on menu and as Hexa decimal (0x0 - 0x63) on transmission /receiving protocol.

[DATA] : To transmit the command data.

Transmit the 'FF' data to read status of command.

[Cr] : Carriage Return

ASCII code '0x0D'

[ ] : ASCII code 'space (0x20)'

\* In this model, TV will not send the status during the standby mode.

### OK Acknowledgement

[Command2][ ][Set ID][ ][OK][Data][x]

The TV transmits ACK (acknowledgement) based on this format when receiving normal data. At this time, if the data is data read mode, it indicates present status data. If the data is data write mode, it returns the data of the PC computer.

\* In this model, TV will not send the status during the standby mode.

\* Data Format

[Command 2] : Use as command.

[Set ID] : Use the small character, if set ID is 10, it will send the '0', 'a'.

[DATA] : Use the small character, if data is 0 x ab, it will send the 'a', 'b'.

[OK] : Use the large character.

### Error Acknowledgement

[Command2][ ][Set ID][ ][NG][Data][x]

The TV transmits ACK (acknowledgement) based on this format when receiving abnormal data from non-viable functions or communication errors.

Data1: Illegal Code

Data2: Not supported function

Data3: Wait more time

\* In this model, TV will not send the status during the standby mode.

\* Data Format

[Command 2] : Use as command.

[Set ID] : Use the small character, if set ID is 10, it will send the '0', 'a'.

[DATA] : Use the small character, if data is 0 x ab, it will send the 'a', 'b'.

[NG] : Use the large character



**01. Power (Command: k a)**

To control Power On/Off of the TV.

Transmission [k][a][ ][Set ID][ ][Data][Cr]

Data 00: Power Off      Data 01: Power On

Acknowledgement [a][ ][Set ID][ ][OK/NG][Data][x]

\* In a like manner, if other functions transmit 'FF' data based on this format, Acknowledgement data feedback presents status about each function.

\* Note: In this model, TV will send the Acknowledge after power on processing completion.

There might be a time delay between command and acknowledge.

**02. Input Select (Command: x b)**

To select input source for TV.

Transmission [x][b][ ][Set ID][ ][Data][Cr]

Data 00: DTV (Antenna)    Data 01: DTV (Cable)

Data 10: Analog (Antenna)    Data 11: Analog (Cable)

Data 20: AV1                  Data 21: AV 2

Data 40: Component1    Data 41: Component 2

Data 42: Component 3    Data 60: RGB-PC

Data 90: HDMI1            Data 91: HDMI2

Data 92: HDMI3            Data 93: HDMI4

Acknowledgement [b][ ][Set ID][ ][OK/NG][Data][x]

\* Use the feature depending on your model.

**03. Aspect Ratio (Command: k c)**

To adjust the screen format.

Transmission [k][c][ ][Set ID][ ][Data][Cr]

Data 01: 4:3                  Data 09: Just scan

Data 02: 16:9                Data 10: Cinema Zoom1

Data 04: Zoom                :

Data 06: Set by program    Data 1F: Cinema Zoom16

Acknowledgement [c][ ][Set ID][ ][OK/NG][Data][x]

**04. Screen Mute (Command: k d)**

To select screen mute on/off.

Transmission [k][d][ ][Set ID][ ][Data][Cr]

Data 00: Screen mute off (Picture on), Video-out Mute off

Data 01: Screen mute on (Picture off)

Data 10: Video-out Mute on

Acknowledgement [d][ ][Set ID][ ][OK/NG][Data][x]

\* In case of Video-out Mute on only, TV will display On Screen Display (OSD). But, in case of screen mute on, TV will not display On Screen Display (OSD).

**05. Volume Mute (Command: k e)**

To control volume mute on/off.

You can also adjust mute using the MUTE button on remote control.

Transmission [k][e][ ][Set ID][ ][Data][Cr]

Data 00: Volume mute on (Volume off)

Data 01: Volume mute off (Volume on)

Acknowledgement [e][ ][Set ID][ ][OK/NG][Data][x]

**06. Volume Control (Command: k f)**

To adjust volume.

You can also adjust volume with the volume buttons on remote control.

Transmission [k][f][ ][Set ID][ ][Data][Cr]

Data Min: 00 - Max: 64 (\*transmit by Hexadecimal code)

\*Refer to 'Real data mapping'.

Acknowledgement [f][ ][Set ID][ ][OK/NG][Data][x]

**07. Contrast (Command: k g)**

To adjust screen contrast.

You can also adjust contrast in the PICTURE menu.

Transmission [k][g][ ][Set ID][ ][Data][Cr]

Data Min: 00 - Max: 64 (\*transmit by Hexadecimal code)

\*Refer to 'Real data mapping'.

Acknowledgement [g][ ][Set ID][ ][OK/NG][Data][x]

**08. Brightness (Command: k h)**

To adjust screen brightness.

You can also adjust brightness in the PICTURE menu.

Transmission [k][h][ ][Set ID][ ][Data][Cr]

Data Min: 00 - Max: 64 (\*transmit by Hexadecimal code)

\*Refer to 'Real data mapping'.

Acknowledgement [h][ ][Set ID][ ][OK/NG][Data][x]

**09. Color (Command: k i)**

To adjust screen color.

You can also adjust color in the PICTURE menu.

Transmission [k][i][ ][Set ID][ ][Data][Cr]

Data Min: 00 - Max: 64 (\*transmit by Hexadecimal code)

\*Refer to 'Real data mapping'.

Acknowledgement [i][ ][Set ID][ ][OK/NG][Data][x]

**10. Tint (Command: k j)**

To adjust screen tint.

You can also adjust tint in the PICTURE menu.

Transmission [k][j][ ][Set ID][ ][Data][Cr]

Data Red: 00 - Green: 64 (\*transmit by Hexadecimal code)

\*Refer to 'Real data mapping'.

Acknowledgement [ j ][ ][Set ID][ ][OK/NG][Data][x]

# APPENDIX

## 11. Sharpness (Command: k k)

To adjust screen sharpness.

You can also adjust sharpness in the Picture menu.

Transmission [k][k][ ][Set ID][ ][Data][Cr]

Data Min: 00 - Max: 64 (\*transmit by Hexadecimal code)

\*Refer to 'Real data mapping'.

Acknowledgement [k][ ][Set ID][ ][OK/NG][Data][x]

## 12. OSD Select (Command: k l)

To select OSD (On Screen Display) on/off.

Transmission [k][l][ ][Set ID][ ][Data][Cr]

Data 00: OSD off      Data 01: OSD on

Acknowledgement [l][ ][Set ID][ ][OK/NG][Data][x]

## 13. Remote Control Lock Mode (Command: k m)

To lock the remote control and the front panel controls on the set.

Transmission [k][m][ ][Set ID][ ][Data][Cr]

Data 00: Lock off      Data 01: Lock on

Acknowledgement [m][ ][Set ID][ ][OK/NG][Data][x]

If you're not using the remote control and front panel controls on the TV, use this mode. When main power is on/off, remote control lock is released.

If Key Lock is on in the standby mode, TV will not turn on by POWER button of remote control and on the TV.

## 14. Treble (Command: k r)

To adjust treble.

You can also adjust treble in the Audio menu.

Transmission [k][r][ ][Set ID][ ][Data][Cr]

Data Min: 00 - Max: 64 (\*transmit by Hexadecimal code)

\*Refer to 'Real data mapping'.

Acknowledgement [r][ ][Set ID][ ][OK/NG][Data][x]

## 15. Bass (Command: k s)

To adjust bass.

You can also adjust bass in the Audio menu.

Transmission [k][s][ ][Set ID][ ][Data][Cr]

Data Min: 00 - Max: 64 (\*transmit by Hexadecimal code)

\*Refer to 'Real data mapping'.

Acknowledgement [s][ ][Set ID][ ][OK/NG][Data][x]

## 16. Balance (Command: k t)

To adjust balance.

You can also adjust balance in the Audio menu.

Transmission [k][t][ ][Set ID][ ][Data][Cr]

Data Min: 00 - Max: 64 (\*transmit by Hexadecimal code)

\*Refer to 'Real data mapping'.

Acknowledgement [t][ ][Set ID][ ][OK/NG][Data][x]

## 17. Color Temperature (Command: x u)

To adjust color temperature.

You can also adjust color temperature in the Picture menu.

Transmission [x][u][ ][Set ID][ ][Data][Cr]

Data Warm: 00 - Cool: 64 (\*transmit by Hexadecimal code)

\*Refer to 'Real data mapping'.

Acknowledgement [u][ ][Set ID][ ][OK/NG][Data][x]

## 18. ISM Method (Command: j p) (For Plasma TV)

To avoid having a fixed image remain on screen.

Transmission [ j ][p][ ][Set ID][ ][Data][Cr]

Data 02: Orbiter      04: White Wash

Data 08: Normal      20: Color Wash

Acknowledgement [p][ ][Set ID][ ][OK/NG][Data][x]

## 19. Energy Saving (Command: j q)

To control the energy saving function.

Transmission [ j ][q][ ][Set ID][ ][Data][Cr]

Data 00: Off      Data 01: Minimum

Data 02: Medium      Data 03: Maximum

Data 04: Auto/Intelligent Sensor (depending on model)

Data 05: Screen off

Acknowledgement [q][ ][Set ID][ ][OK/NG][Data][x]

## 20. Auto Configuration (Command: j u)

To adjust picture position and minimize image shaking automatically. Auto configuration only works in RGB-PC mode.

Transmission [ j ][u][ ][Set ID][ ][Data][Cr]

Data 01: To set

Acknowledgement [u][ ][Set ID][ ][OK/NG][Data][x]

## 21. Channel Tuning (Command: m a)

To tune channel to following physical/major/minor number.

Transmission [m][a][ ][Set ID][ ][Data00][ ][Data01]

[ ][Data02][ ][Data03][ ][Data04][ ][Data05][Cr]

Digital channels have a Physical, Major, and Minor channel number. The Physical number is the actual digital channel number, the Major is the number that the channel should be mapped to, and the Minor is the sub-channel. Since the ATSC tuner automatically maps the channel to the Major number, the Physical number is not required when sending a command.

Data 00: Physical Channel Number

NTSC air: 02 - 45, NTSC cable: 01, 0E - 7D

ATSC air: 01 - 45, ATSC cable: 01 - 87

Data 01 & 02: Major Channel Number

Data 01: High byte      Data 02: Low byte

Two bytes are available for the Major and Minor, normally only the second byte is used.

Data 03 & 04: Minor Channel Number

Not needed for NTSC.

Data5:	7 Main/Sub Picture	6 Two/One Part Channel	5 Using Physical Channel	4 Reserved	3	2	1	0	Step
	0 Main	0 Two	0 Use	x	0	0	0	0	NTSC Air
	1 Sub	1 One	1 No Use	x	0	0	0	1	NTSC Cable
				x	0	0	1	0	ATSC Air
				x	0	0	1	1	ATSC Cable_std
				x	0	1	0	0	ATSC Cable_hrc
				x	0	1	0	1	ATSC Cable_irc
				x	0	1	1	0	ATSC cable_auto
				x	0	1	1	1	Reserved
				x	x	x	x	x	...
				x	1	1	1	1	Reserved

The table above lists the binary code which must be converted to Hexadecimal before sending. For example: The binary code to tune the sub source to an NTSC cable channel is "1000 0001", which translates to "81" in Hex.

- \* 7th bit : For which source do you want to change the channel.
- \* 6th bit: Use a two part or one part channel. Most cases just use 0 since it's ignored when using NTSC.
- \* 5th bit: Use 0 with NTSC since it can only use the physical channel number. Normally use 1 for ATSC since most times it doesn't matter what the physical number is.
- \* 4th bit: Set to 0.
- \* 3-0 bits: Choose signal type.

\*Tune Command Examples:

1. Tune to the analog (NTSC) cable channel 35.

Data 00 = Physical of 35 = 23  
 Data 01 & 02 = No Major = 00 00  
 Data 03 & 04 = No Minor = 00 00  
 Data 05 = 0000 0001 in binary = 01  
 Total = ma 00 23 00 00 00 00 01

2. Tune to the digital local channel 30-3.

Data 00 = Don't know Physical = 00  
 Data 01 & 02 = Major is 30 = 00 1E  
 Data 03 & 04 = Minor is 3 = 00 03  
 Data 05 = 0010 0010 in binary = 22  
 Total = ma 00 00 00 1E 00 03 22

Acknowledgement[a][ ][Set ID][ ][OK][Data00]  
 [Data01] [Data02][Data03][Data04][x][a][ ][Set ID][ ]  
 [NG][Data00][x]

## 22. Channel Add/Del (Command: m b)

To add and delete the channels.

Transmission [m][b][ ][Set ID][ ][Data][Cr]

Data 00: Channel Delete Data 01: Channel Add

Acknowledgement [b][ ][Set ID][ ][OK/NG][Data][x]

## 23. Key (Command: m c)

To send IR remote control code.

Transmission [m][c][ ][Set ID][ ][Data][Cr]

See page 181.

Acknowledgement [c][ ][Set ID][ ][OK/NG][Data][x]

## 24. Backlight (Command: m g) (For LED LCD TV)

To adjust screen backlight.

Transmission [m][g][ ][Set ID][ ][Data][Cr]

Data Min:00 ~ Max:64 (\*transmit by Hexadecimal code)

\*Refer to 'Real data mapping'.

Acknowledgement [g][ ][Set ID][ ][OK/NG][Data][x]

# APPENDIX

## OPEN SOURCE SOFTWARE NOTICE

The following GPL executables and LGPL, MPL libraries used in this product are subject to the GPL2.0/LGPL2.1/MPL1.1 License Agreements:

### GPL EXECUTABLES:

Linux kernel 2.6, busybox, e2fsprogs, jfsutils, lzo, msdl-1.1, mtd-utils, ntpclient, procps

### LGPL LIBRARIES:

Atk, cairo, directFB, ffmpeg, glib, GnuTLS, gtk+, iconv, libintl, libcrypto, libgpg-error, libsoup, libusb, pango, uClibc, webkit

### MPL LIBRARIES:

Nanox, spidermonkey

LG Electronics offers to provide source code to you on CD-ROM for a charge covering the cost of performing such distribution, such as the cost of media, shipping and handling upon e-mail request to LG Electronics : [opensource@lge.com](mailto:opensource@lge.com)

This offer is valid for a period of three (3) years from the date of the distribution of this product by LG Electronics

You can obtain a copy of the GPL, LGPL, MPL licenses on the CD-ROM provided with this product.

Also you can obtain the translation of GPL, LGPL licenses from

<http://www.gnu.org/licenses/old-licenses/gpl-2.0-translations.html>,

<http://www.gnu.org/licenses/old-licenses/lgpl-2.1-translations.html>.

This product includes other open source software.

- ▶ boost C++: software developed by <http://www.boost.org> distributed under the Boost Software License, Version 1.0
- ▶ c-ares : copyright © 1998 by the Massachusetts Institute of Technology
- ▶ expat:
  - copyright © 1998, 1999, 2000 Thai Open Source Software Center Ltd and Clark Cooper
  - copyright © 2001-2007 Expat maintainers.
- ▶ fontconfig: copyright © 2001, 2003 Keith Packard
- ▶ freetype: copyright © 2003 The FreeType Project ([www.freetype.org](http://www.freetype.org)).
- ▶ ICU: copyright © 1995-2008 International Business Machines Corporation and others.
- ▶ libcurl: copyright © 1996 - 2008, Daniel Stenberg.
- ▶ libjpeg: This software is based in part on the work of the Independent JPEG Group copyright © 1991 - 1998, Thomas G. Lane.
- ▶ libmng: copyright © 2000-2007 Gerard Juyn, Glenn Randers-Pehrson
- ▶ libpng: copyright © 1998-2008 Glenn Randers-Pehrson
- ▶ libupnp: copyright © 2000-2003 Intel Corporation
- ▶ libxml2 : copyright © 1998-2003 Daniel Veillard
- ▶ libxslt: copyright © 2001-2002 Daniel Veillard
- ▶ lua interpreter: copyright © 1994-2008 Lua.org, PUC-Rio
- ▶ md5: copyright © 1991-2, RSA Data Security, Inc

- ▶ openssl:
  - cryptographic software written by Eric Young.
  - software written by Tim Hudson.
  - software developed by the OpenSSL Project for use in the OpenSSL Toolkit. (<http://www.openssl.org>)
- ▶ pixman:
  - copyright © 1987, 1988, 1989, 1998 The Open Group
  - copyright © 1987, 1988, 1989 Digital Equipment Corporation
  - copyright © 1999, 2004, 2008 Keith Packard
  - copyright © 2000 SuSE, Inc.
  - copyright © 2000 Keith Packard, member of The XFree86 Project, Inc.
  - copyright © 2004, 2005, 2007, 2008 Red Hat, Inc.
  - copyright © 2004 Nicholas Miell
  - copyright © 2005 Lars Knoll & Zack Rusin, Trolltech
  - copyright © 2005 Trolltech AS
  - copyright © 2007 Luca Barbato
  - copyright © 2008 Aaron Plattner, NVIDIA Corporation
  - copyright © 2008 Rodrigo Kumpera
  - copyright © 2008 André Tupinambá
  - copyright © 2008 Mozilla Corporation
  - copyright © 2008 Frederic Plourde
- ▶ portmap: copyright © 1983,1991 The Regents of the University of California.
- ▶ tiff: copyright © 1987, 1993, 1994 The Regents of the University of California.
- ▶ tinyxml: copyright © 2000-2006 Lee Thomason
- ▶ xyssl:
  - Copyright © 2006-2008 Christophe Devine
  - Copyright © 2009 Paul Bakker
- ▶ zlib: copyright © 1995-2005 Jean-loup Gailly and Mark Adler

All rights reserved.

Permission is hereby granted, free of charge, to any person obtaining a copy of this software and associated documentation files (the "Software"), to deal in the Software without restriction, including without limitation the rights to use, copy, modify, merge, publish, distribute, sublicense, and/or sell copies of the Software, and to permit persons to whom the Software is furnished to do so, subject to the following conditions:

THE SOFTWARE IS PROVIDED "AS IS", WITHOUT WARRANTY OF ANY KIND, EXPRESS OR IMPLIED, INCLUDING BUT NOT LIMITED TO THE WARRANTIES OF MERCHANTABILITY, FITNESS FOR A PARTICULAR PURPOSE AND NONINFRINGEMENT. IN NO EVENT SHALL THE AUTHORS OR COPYRIGHT HOLDERS BE LIABLE FOR ANY CLAIM, DAMAGES OR OTHER LIABILITY, WHETHER IN AN ACTION OF CONTRACT, TORT OR OTHERWISE, ARISING FROM, OUT OF OR IN CONNECTION WITH THE SOFTWARE OR THE USE OR OTHER DEALINGS IN THE SOFTWARE.

APPENDIX

NOTE

NOTE