

OWNER'S MANUAL

LED LCD TV / LCD TV PLASMA TV

Please read this manual carefully before operating your set and retain it for future reference.

LED LCD TV MODELS

32LE5500	32LE7500
42LE5500	42LE7500
47LE5500	47LE7500
55LE5500	55LE7500
42LE8500	42LX6500
47LE8500	47LX6500

LCD TV MODELS

32LD650
42LD650
47LD650
55LD650

PLASMA TV MODELS

50PK950R
60PK950R

WARNING / CAUTION



WARNING / CAUTION
RISK OF ELECTRIC SHOCK
DO NOT OPEN



TO REDUCE THE RISK OF ELECTRIC SHOCK DO NOT REMOVE COVER (OR BACK). NO USER SERVICEABLE PARTS INSIDE. REFER TO QUALIFIED SERVICE PERSONNEL.



The lightning flash with arrowhead symbol, within an equilateral triangle, is intended to alert the user to the presence of uninsulated "dangerous voltage" within the product's enclosure that may be of sufficient magnitude to constitute a risk of electric shock to persons.



The exclamation point within an equilateral triangle is intended to alert the user to the presence of important operating and maintenance (servicing) instructions in the literature accompanying the appliance.

WARNING/CAUTION

TO REDUCE THE RISK OF FIRE AND ELECTRIC SHOCK. DO NOT EXPOSE THIS PRODUCT TO RAIN OR MOISTURE.

SAFETY INSTRUCTIONS

IMPORTANT SAFETY INSTRUCTIONS

Read these instructions.

Keep these instructions.

Heed all warnings.

Follow all instructions.



- 1** Do not use this apparatus near water.



- 2** Clean only with dry cloth.



- 3** Do not block any ventilation openings. Install in accordance with the manufacturer's instructions.



- 4** Do not install near any heat sources such as radiators, heat registers, stoves, or other apparatus (including amplifiers) that produce heat.



- 5** Protect the power cord from being walked on or pinched particularly at plugs, convenience receptacles, and the point where they exit from the apparatus.



- 6** Only use attachments/accessories specified by the manufacturer.



- 7** Use only with the cart, stand, tripod, bracket, or table specified by the manufacturer, or sold with the apparatus. When a cart is used, use caution when moving the cart/apparatus combination to avoid injury from tip-over.



S3125A

- 8** Unplug this apparatus during lightning storms or when unused for long periods of time.



- 9** Refer all servicing to qualified service personnel. Servicing is required when the apparatus has been damaged in any way, such as power-supply cord or plug is damaged, liquid has been spilled or objects have fallen into the apparatus, the apparatus has been exposed to rain or moisture, does not operate normally, or has been dropped.



- 10** Never touch this apparatus or antenna during a thunder or lightning storm.

- 11** When mounting a TV on the wall, make sure not to install the TV by the hanging power and signal cables on the back of the TV.

- 12** Do not allow an impact shock or any objects to fall into the product, and do not drop onto the screen with something.

- 13** CAUTION concerning the Power Cord:

It is recommended that appliances be placed upon a dedicated circuit; that is, a single outlet circuit which powers only that appliance and has no additional outlets or branch circuits. Check the specification page of this owner's manual to be certain.

Do not connect too many appliances to the same AC power outlet as this could result in fire or electric shock.

Do not overload wall outlets. Overloaded wall outlets, loose or damaged wall outlets, extension cords, frayed power cords, or damaged or cracked wire insulation are dangerous. Any of these conditions could result in electric shock or fire. Periodically examine the cord of your appliance, and if its appearance indicates damage or deterioration, unplug it, discontinue use of the appliance, and have the cord replaced with an exact replacement part by an authorized servicer. Protect the power cord from physical or mechanical abuse, such as being twisted, kinked, pinched, closed in a door, or walked upon. Pay particular attention to plugs, wall outlets, and the point where the cord exits the appliance.

Do not make the TV with the power cord plugged in. Do not use a damaged or loose power cord. Be sure to grasp the plug when unplugging the power cord. Do not pull on the power cord to unplug the TV.



SAFETY INSTRUCTIONS

- 14** **WARNING** - To reduce the risk of fire or electrical shock, do not expose this product to rain, moisture or other liquids. Do not touch the TV with wet hands. Do not install this product near flammable objects such as gasoline or candles or expose the TV to direct air conditioning.



- 15** Do not expose to dripping or splashing and do not place objects filled with liquids, such as vases, cups, etc. on or over the apparatus (e.g. on shelves above the unit).



16 GROUNDING

Ensure that you connect the earth ground wire to prevent possible electric shock (i.e. a TV with a three-prong grounded AC plug must be connected to a three-prong grounded AC outlet). If grounding methods are not possible, have a qualified electrician install a separate circuit breaker.

Do not try to ground the unit by connecting it to telephone wires, lightning rods, or gas pipes.

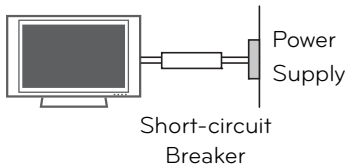

17 DISCONNECTING DEVICE FROM MAINS

Mains plug is the disconnecting device. The plug must remain readily operable.

- 18** As long as this unit is connected to the AC wall outlet, it is not disconnected from the AC power source even if you turn off this unit by SWITCH.

19 Cleaning

When cleaning, unplug the power cord and scrub gently with a soft cloth to prevent scratching. Do not spray water or other liquids directly on the TV as electric shock may occur. Do not clean with chemicals such as alcohol, thinners or benzene.

20 Moving

Make sure the product is turned off, unplugged and all cables have been removed. It may take 2 or more people to carry larger TVs. Do not press against or put stress on the front panel of the TV.

21 Ventilation

Install your TV where there is proper ventilation. Do not install in a confined space such as a bookcase. Do not cover the product with cloth or other materials (e.g.) plastic while plugged in. Do not install in excessively dusty places.

- 22** Take care not to touch the ventilation openings. When watching the TV for a long period, the ventilation openings may become hot.

- 23** If you smell smoke or other odors coming from the TV, unplug the power cord and contact and authorized service center.

- 24** Do not press strongly upon the panel with hand or sharp object such as nail, pencil or pen, or make a scratch on it.



- 25** Keep the product away from direct sunlight.

26 Dot Defect

The Plasma or LCD panel is a high technology product with resolution of two million to six million pixels. In a very few cases, you could see fine dots on the screen while you're viewing the TV. Those dots are deactivated pixels and do not affect the performance and reliability of the TV.

27 Generated Sound

"Cracking" noise: A cracking noise that occurs when watching or turning off the TV is generated by plastic thermal contraction due to temperature and humidity. This noise is common for products where thermal deformation is required.

Electrical circuit humming/panel buzzing: A low level noise is generated from a high-speed switching circuit, which supplies a large amount of current to operate a product. It varies depending on the product.

This generated sound does not affect the performance and reliability of the product.

28 For LED LCD TV/LCD TV

If the TV feels cold to the touch, there may be a small "flicker" when it is turned on. This is normal, there is nothing wrong with TV.

Some minute dot defects may be visible on the screen, appearing as tiny red, green, or blue spots. However, they have no adverse effect on the monitor's performance.

Avoid touching the LCD screen or holding your finger(s) against it for long periods of time. Doing so may produce some temporary distortion effects on the screen.

29 Viewing 3D Imaging (For 3D TV)

- ▶ When viewing 3D imaging, watch the TV from an effective viewing angle and within the appropriate distance. If you exceed this viewing angle or distance, you may not be able to view the 3D imaging. Furthermore, the 3D imaging may not display if it is viewed while you are lying down.
- ▶ If you watch the 3D imaging too closely or for a long period of time, it may harm your eyesight.
- ▶ Watching the TV or playing video games that incorporate 3D imaging with the 3D glasses for a long period of time can cause drowsiness, headaches or fatigue to you and/or your eyes. If you have a headache, or otherwise feel fatigued or drowsy, stop watching the TV and take a rest.
- ▶ Pregnant woman, seniors, persons with heart problems or persons who experience frequent drowsiness should refrain from watching 3D TV.
- ▶ Some 3D imaging may cause you to duck or dodge the image displayed in the video. Therefore, it is best if you do not watch 3D TV near fragile objects or near any objects that can be knocked over easily.
- ▶ Please prevent children under the age of 5 from watching 3D TV. It may affect their vision development.
- ▶ Warning for photosensitization seizure: Some viewers may experience a seizure or epilepsy when exposed to certain factors, including flashing lights or images in TV or video games. If you or anybody from your family has a history of epilepsy or seizure, please consult with your doctor before watching 3D TV.

Also certain symptoms can occur in unspecified conditions without any previous history. If you experience any of the following symptoms, immediately stop watching the 3D imaging and consult a doctor: dizziness or lightheadedness, visual transition or altered vision, visual or facial instability, such as eye or muscle twitching, unconscious action, convulsion, loss of conscience, confusion or disorientation, loss of directional sense, cramps, or nausea. Parents should monitor their children, including teenagers, for these symptoms as they may be more sensitive to the effects of watching 3D TV.

Risk of photosensitization seizure can be reduced with the following actions.

- Take frequent breaks from watching 3D TV.
- For those who have vision that is different in each eye, they should watch the TV after taking vision correction measures.
- Watch the TV so that your eyes are on the same level as the 3D screen and refrain from sitting too closely to the TV
- Do not watch the 3D imaging when tired or sick, and avoid watching the 3D imaging for a long period of time.
- Do not wear the 3D glasses for any other purpose than viewing 3D imaging on a 3D TV.
- Some viewers may feel disoriented after watching 3D TV. Therefore, after you watch 3D TV, take a moment to regain awareness of your situation before moving.

ON DISPOSAL (Only Hg lamp used LCD TV)

The fluorescent lamp used in this product contains a small amount of mercury. Do not dispose of this product with general household waste. Disposal of this product must be carried out in accordance to the regulations of your local authority.

CONTENTS

WARNING / CAUTION	2
SAFETY INSTRUCTIONS	3
FEATURE OF THIS TV	8

PREPARATION

Accessories	9
Optional Extras	10
Front Panel Information	11
Back Panel Information	13
Stand Instructions	16
VESA Wall Mounting	20
Cable Management	21
Desktop Pedestal Installation	23
Swivel Stand	23
Attaching the TV to a desk	24
Kensington Security System	24
Securing the TV to the wall to prevent falling when the TV is used on a stand	25
Antenna or Cable Connection	26

EXTERNAL EQUIPMENT SETUP

HD Receiver Setup	27
DVD SETUP	30
VCR SETUP	33
Other A/V Source Setup	35
USB Connection	36
Headphone Setup	36
Audio Out Connection	37
External Equipment Wireless Connection (Optional Extra)	38
PC Setup	39
Network Setup	44

WATCHING TV / CHANNEL CONTROL

Remote Control Functions	52
Turning on the TV	56

Channel Selection	56
Volume Adjustment	56
Initial Setting	57
On-Screen Menus Selection	58
Quick Menu	61
Customer Support	
-Software Update	62
-Picture Test/Sound Test	63
-Diagnostics	63
-Product/Service Info.	64
-Network Test	64
Simple Manual	65
Channel Setup	
-Auto Scan (Auto Tuning)	66
-Add/Delete Channel (Manual Tuning)	67
-Channel Editing	68
Favorite Channel Setup	69
Favorite Channel List	69
Channel List	70
Input List	71
Input Label	71
Mode Setting	72
Demo Mode	72
Reset to Factory Default(Initial Setting)	73
System Color	73
AV Mode	74
Game	74
Simplink	75
EPG	76

BLUETOOTH

Bluetooth?	80
Setting the Bluetooth	81
Connecting the Bluetooth Headset	82
Remove the Bluetooth Device	84
My Bluetooth Information	85
Viewing the Photos with Bluetooth Device	86
Listening the Musics with Bluetooth Device	86

3D IMAGING

3D Technology	87
Watching 3D Imaging	88

MY MEDIA

Entry Mode	90
Connection Method	91
Movie List	96
Photo List	103
Music List	109
DivX Registration Code.....	114
Deactivation	115

NETWORK

Legal Notice	116
--------------------	-----

NETCAST

Netcast Menu.....	118
Weather Information	119
Photo Album.....	120
Video Online.....	121
EMOL	123
BAZUCA.....	124
TERRATV.....	125

PICTURE CONTROL

Picture Size (Aspect Ratio) Control.....	126
Picture Wizard.....	128
 Energy Saving	130
Preset Picture Settings (Picture Mode).....	131
Manual Picture Adjustment - User Mode	132
Picture Improvement Technology (Advanced Control)	133
Expert Picture Control	134
Picture Reset.....	137
TruMotion	138
LED Local Dimming.....	139
Power Indicator	139
Image Sticking Minimization (ISM) Method.....	140

SOUND & LANGUAGE CONTROL

Auto Volume.....	141
Clear Voice II	142
Balance	143
Preset Sound Settings (Sound Mode)	144
Sound Setting Adjustment - User Mode.....	145
Audio Reset.....	146
TV Speakers On/Off Setup	146
Digital Audio Out	147
Stereo/SAP Broadcast Setup	148
DTV Audio Setting	148
ON-Screen Menus Language Selection...	149
Caption Mode	149
Language Selection	150

TIME SETTING

Clock Setting.....	151
On/Off Time Setting.....	152
Sleep Timer Setting	153

PARENTAL CONTROL

Set Password & Lock System	
-Setting up Your Password	154
-Set Password	155
-Lock System.....	156
Channel Blocking.....	157
External Input Blocking	158
Key Lock	159

APPENDIX

Troubleshooting.....	160
Maintenance	163
Product Specifications	164
IR Codes.....	167
External Control Through RS-232C	168
Open Source Software Notice	175

FEATURE OF THIS TV

- Some of these features are not available on all models.



Manufactured under license from Dolby Laboratories. "Dolby" and the double-D symbol are trademarks of Dolby Laboratories.



Listen to TV with wireless headset, or enjoy viewing your mobile phone photos on your TV.
(This is not available for all models.)



HDMI, the HDMI logo and High-Definition Multimedia Interface are trademarks or registered trademarks of HDMI Licensing LLC."



ABOUT DIVX VIDEO: DivX® is a digital video format created by DivX, Inc. This is an official DivX Certified device that plays DivX video. Visit www.divx.com for more information and software tools to convert your files into DivX video.

ABOUT DIVX VIDEO-ON-DEMAND: This DivX Certified® device must be registered in order to play DivX Video-on-Demand (VOD) content. To generate the registration code, locate the DivX VOD section in the device setup menu. Go to vod.divx.com with this code to complete the registration process and learn more about DivX VOD.

"DivX Certified® to play DivX® video up to HD 1080p, including premium content."

"DivX®, DivX Certified® and associated logos are trademarks of DivX, Inc. and are used under license."

"Pat. 7,295,673; 7,460,668; 7,515,710; 7,519,274"



IMPORTANT INFORMATION TO PREVENT "IMAGE BURN / BURN-IN" ON YOUR TV SCREEN

- When a fixed image (e.g. logos, screen menus, video game, and computer display) is displayed on the TV for an extended period, it can become permanently imprinted on the screen. This phenomenon is known as "image burn" or "burn-in." Image burn is not covered under the manufacturer's warranty.
- In order to prevent image burn, avoid displaying a fixed image on your TV screen for a prolonged period (2 or more hours for LCD, 1 or more hours for Plasma).
- Image burn can also occur on the letter-boxed areas of your TV if you use the 4:3 aspect ratio setting for an extended period.

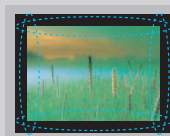
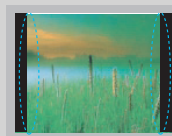

PREPARATION

ACCESSORIES

Ensure that the following accessories are included with your TV. If an accessory is missing, please contact the dealer where you purchased the TV.

The accessories included may differ from the images below.



Owner's Manual



Nero MediaHome 4
Essentials CD

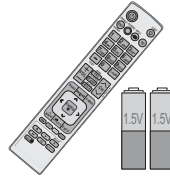

Remote Control,
Batteries (AAA)
(Some models)



RF Adapter
(Some models)

You must connect it to the antenna wire after fixing in Antenna Input. This adapter is only supplied in **Argentina**.

Not included with all models

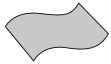

Polishing Cloth

- * Wipe spots on the exterior only with the polishing cloth.
- * Do not wipe roughly when removing stain. Excessive pressure may cause scratch or discoloration.

Option Extras

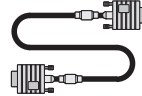

D-sub 15 pin Cable

When using the VGA (D-sub 15 pin cable) PC connection, the user must use shielded signal interface cables with ferrite cores to maintain standards compliance.

32/42/47/55LE5500, 32/42/47/55LE7500, 42/47LE8500, 42/47LX6500

(Other models)



x 8
(M4 x 16)

(For 55LE5500, 55LE7500)



x 4
(M4 x 24)



x 4
(M4 x 16)

(42/47LE8500)



x 8
(M4 x 20)



Cable Holder
(Refer to p.22)

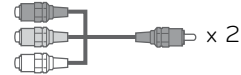

Component gender cable,
AV gender cable

Screws for stand assembly
(Refer to P.18)

(For 32LE5500, 32LE7500)



Screw for
stand fixing
(Refer to
P.24)



3D Glasses

(For 32/42/47/55LE7500)



Cleansing Cloths
(mitt)



Water

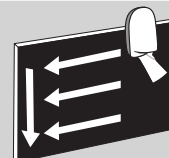

- * Wipe spots on the exterior only with the cleansing cloths.
- * Do not wipe roughly when removing stains. Excessive pressure may cause scratches or discoloration.
- * For cleaning front frame, please slowly wipe in one direction after spraying water 1-2 times on cleansing cloths. Please remove excessive moisture after cleaning. Excessive moisture may cause water stains on the frame.

32/42/47/55LD650



Screws for stand assembly
(Refer to P.16)

(For 32/42LD650)



Screw for stand fixing
(Refer to P.24)



Protection Cover
(Refer to P.16)





Power Cord

PREPARATION

Plasma TV

(For 50PK950R)

 x 4  x 4

(M4 x 14) (M4 x 28)
Screws for stand assembly
(Refer to P.17)

 x 2

Cable Holder
(Refer to P.22)

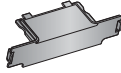

Power Cord

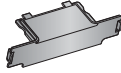

Protection Cover
(Refer to P.17)

(For 50/60PK950R)



Remote Control,
Batteries (AAA)
(Some models)



Cable
Management Clip

OPTIONAL EXTRAS

Optional extras can be changed or modified for quality improvement without any notification.
Contact your dealer for buying these items.

This device only works with compatible LG LED LCD TV, LCD TV or PLASMA TV.



Wireless Media Box
(AN-WL100W)



Wireless LAN for Broadband/
DLNA Adaptor
(AN-WF100)

FRONT PANEL INFORMATION

■ Image shown may differ from your TV.
32/42/47/55LD650

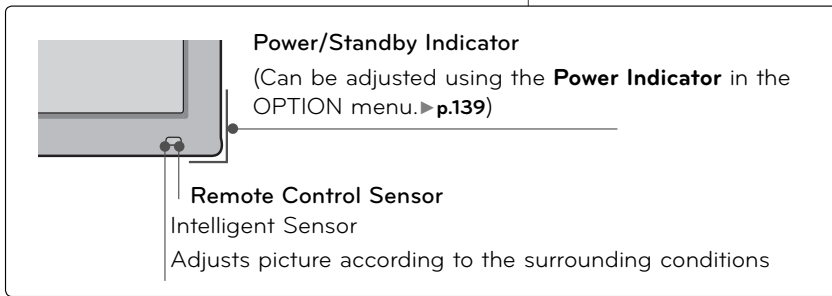
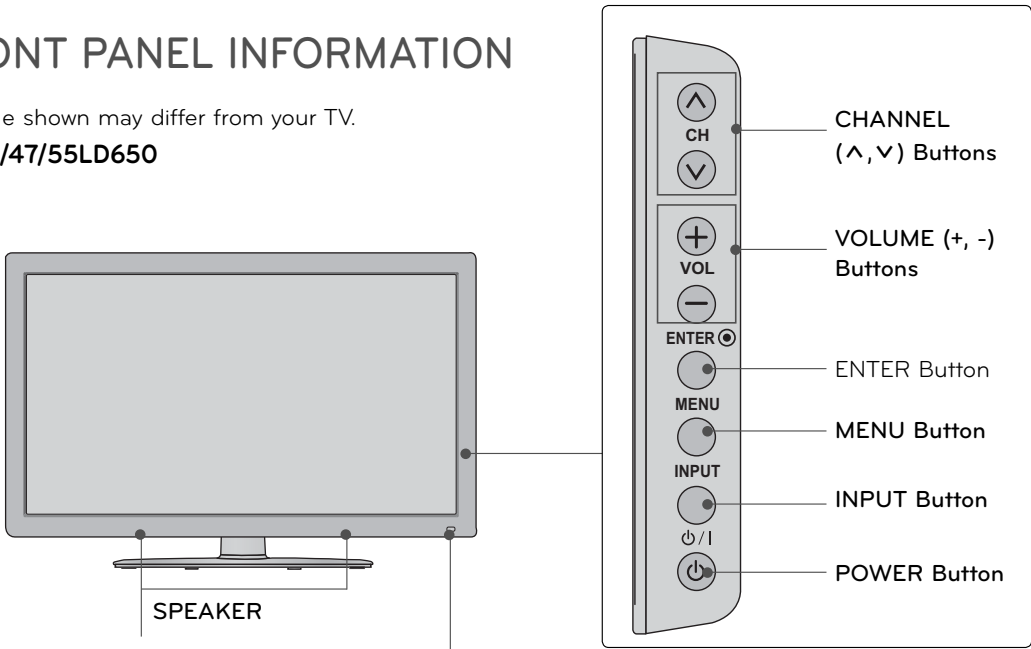

42/47LE8500

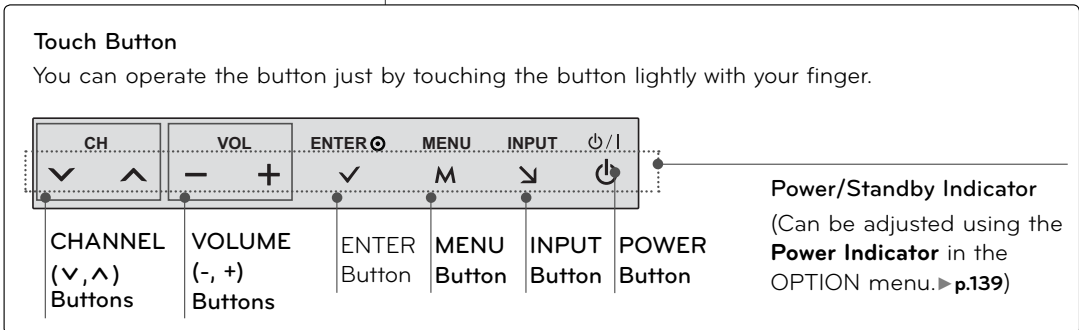
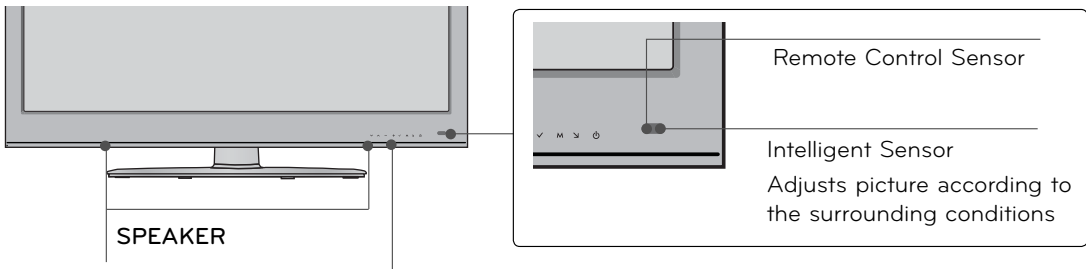

PREPARATION

32/42/47/55LE5500, 32/42/47/55LE7500, 42/47LX6500

PREPARATION

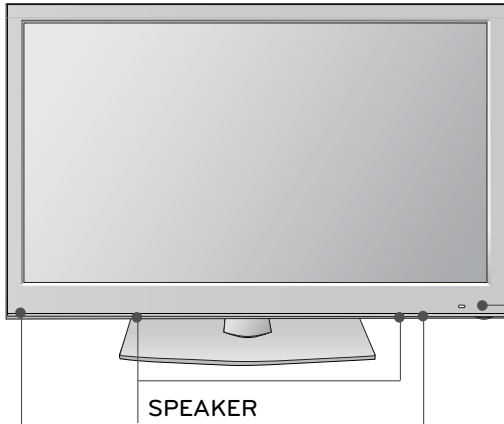

Remote Control Sensor

Intelligent Sensor
Adjusts picture according to the surrounding conditions

Power/Standby Indicator
(Can be adjusted using the **Power Indicator** in the OPTION menu. ▶ p.139)

Emitter

(For 42/47LX6500)

It is the part equipped with the emitter exchanging signal with 3D glasses.

Please be careful not to block the screen with objects or people while watching a 3D Video.

Touch Button

Light the button by touching first. At this time, you can use the desired button.

CH ∇ ▲	VOL - +	ENTER ◉ ✓	MENU M	INPUT ∇	⏻/I ⏻
CHANNEL (∇, ▲) Buttons	VOLUME (-, +) Buttons	ENTER Button	MENU Button	INPUT Button	POWER Button

50/60PK950R

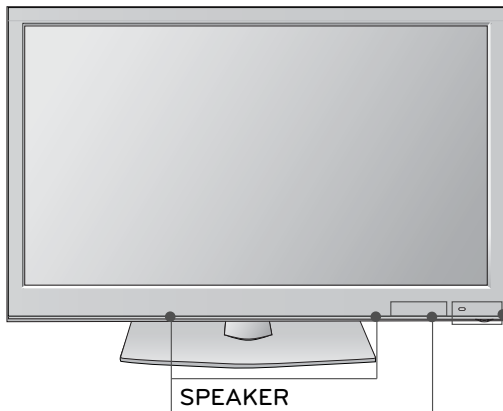

Intelligent Sensor
Adjusts picture according to the surrounding conditions

Remote Control Sensor

Power/Standby Indicator
Illuminates red in standby mode.
The lighting is off while the TV remains on.

Touch Button

You can operate the button just by touching the button lightly with your finger.

⏻/I	INPUT	MENU	ENTER ◉ ✓	- VOL +	∇ CH ▲
POWER Button	INPUT Button	MENU Button	ENTER Button	VOLUME (+, -) Buttons	CHANNEL (∇, ▲) Buttons

BACK PANEL INFORMATION

■ Image shown may differ from your TV.

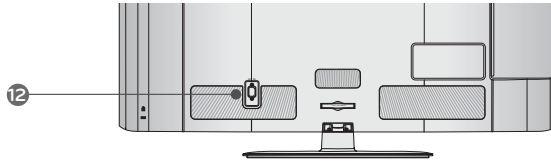

32/42/47/55LD650-MA

32/42/47/55LD650-DA

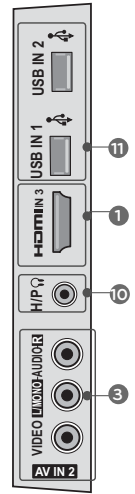
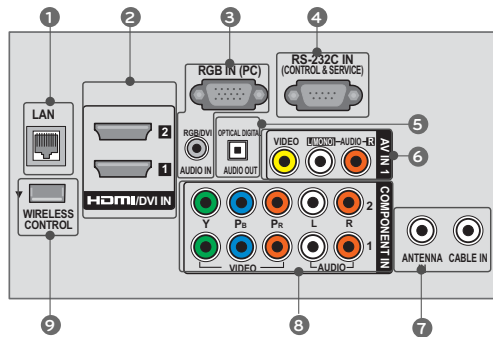
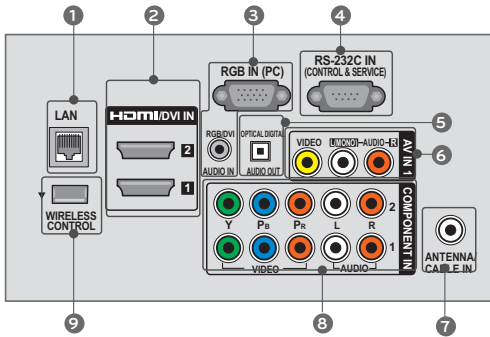

50/60PK950R

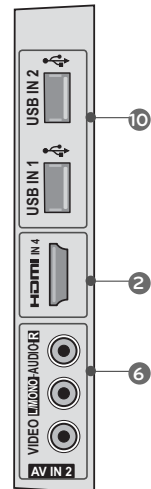
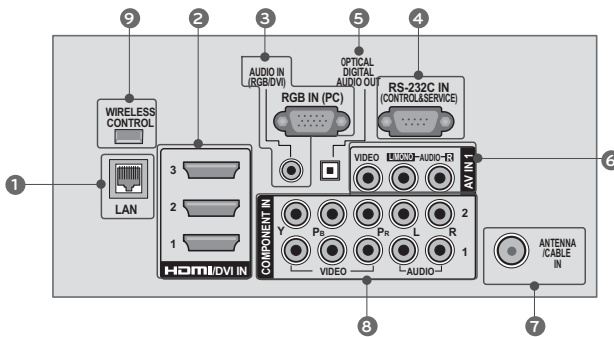
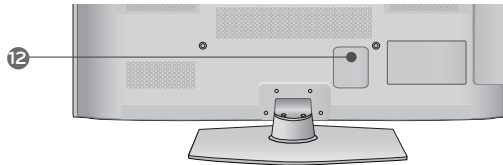

PREPARATION

32/42/47/55LE5500-MA, 32/42/47/55LE7500-MA, 42/47LE8500-MA

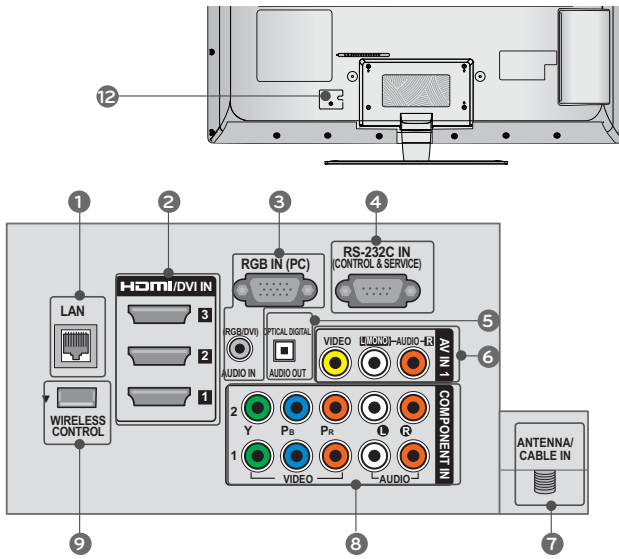

32/42/47/55LE5500-DA, 42/47LX6500, 42/47LE8500-DA

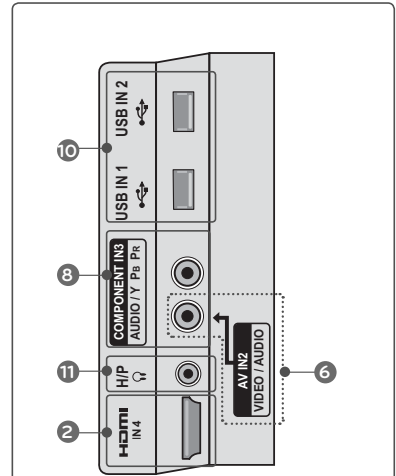
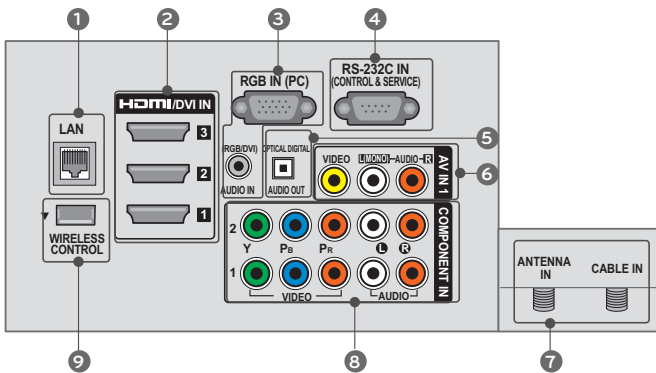

⚠ CAUTION

For HDMI IN 4 and USB IN 1/2

▶ For an optimal connection, HDMI cables and USB devices should have bezels less than 0.39 inches (10 mm) thick.

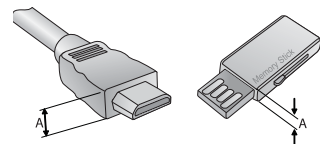

*A ≤ 0.39 inches (10 mm)

1 LAN

Network connection for Netcast services.
Also used for photo and music files on local network.

2 HDMI/DVI IN, HDMI IN

Digital Connection.
Supports HD video and Digital audio. Doesn't support 480i.
Accepts DVI video using an adapter or HDMI to DVI cable (not included).

3 RGB IN (PC)

Analog PC Connection. Uses a D-sub 15 pin cable (VGA cable).
AUDIO IN (RGB/DVI)
1/8" (0.32 cm) headphone jack for analog PC audio input.

4 RS-232C IN (CONTROL & SERVICE) PORT

Used by third party devices.
This port is used for service or Hotel mode.

5 OPTICAL DIGITAL AUDIO OUT

Digital optical audio output for use with amps and home theater systems.
Note: In standby mode, this port doesn't work.

6 AV (Audio/Video) IN

Analog composite connection. Supports standard definition video only (480i).

7 ANTENNA/CABLE IN

Connect over-the air signals to this jack.
Connect cable signals to this jack.

8 COMPONENT IN

Analog Connection.
Supports HD.
Uses a red, green, and blue cable for video & red and white for audio.

9 WIRELESS CONTROL

Connect the Wireless Dongle to the TV to control the external input devices connected to Media Box wirelessly.

10 USB INPUT

Used for viewing photos, movies and listening to MP3s.

11 HEADPHONE INPUT

0.32 cm (1/8 inch) headphone jack
Impedance 16 Ω , Maximum audio out 15 mW

12 Power Cord Socket

For operation with AC power.
Caution: Never attempt to operate the TV on DC power.

PREPARATION

STAND INSTRUCTIONS (For 32/42/47/55LD650)

■ Image shown may differ from your TV.

INSTALLATION

- 1 Carefully place the TV screen side down on a cushioned surface to protect the screen from damage.

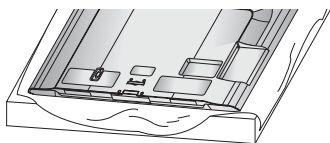

- 2 Assemble the parts of the **STAND BODY** with the **STAND BASE** of the TV.

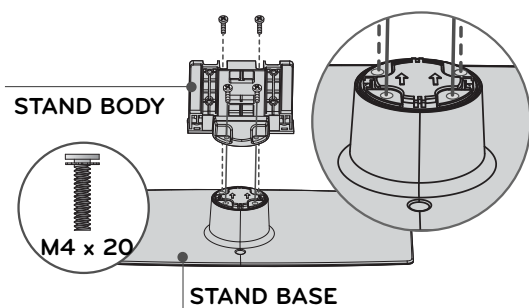

- 3 Assemble the TV as shown.

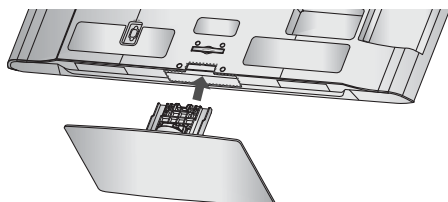

- 4 Fix the 4 screws securely using the holes in the back of the TV.

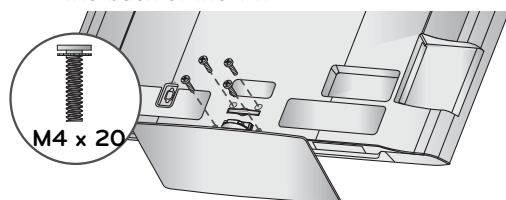

NOTE

- ▶ When assembling the desk type stand, make sure the screws are fully tightened (If not tightened fully, the TV can tilt forward after the product installation). Do not over tighten.

DETACHMENT

- 1 Carefully place the TV screen side down on a cushioned surface to protect the screen from damage.

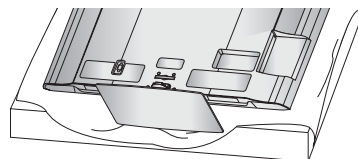

- 2 Remove the screws that hold the stand on.

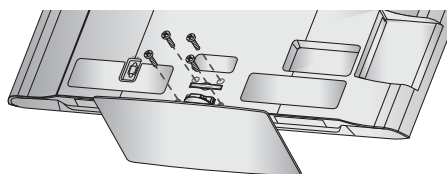

- 3 Detach the stand from TV.

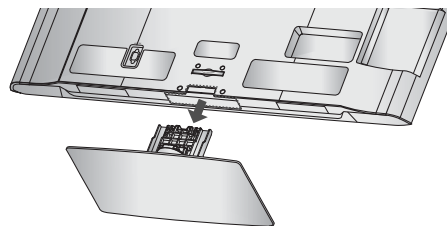

PROTECTION COVER

After removing the stand, install the included **PROTECTION COVER** over the hole for the stand.

Press the **PROTECTION COVER** into the TV until you hear it click.

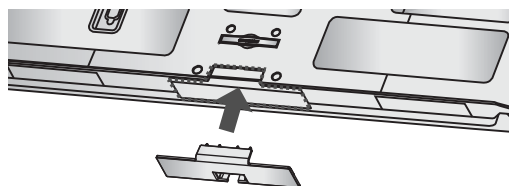

(For 50/60PK950R)

■ Image shown may differ from your TV.

INSTALLATION (For 50PK950R)

- 1 Carefully place the TV screen side down on a cushioned surface to protect the screen from damage.

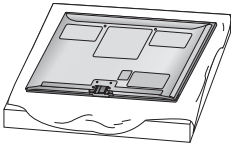

- 2 Assemble the parts of the **STAND BODY** with the **STAND BASE** of the TV.

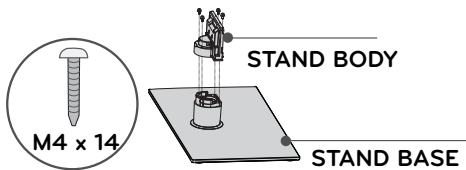

- 3 Assemble the parts of the **CABLE MANAGEMENT CLIP** with the **STAND BODY**.

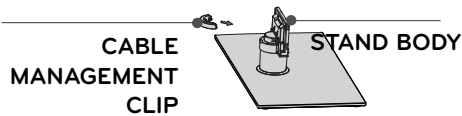

- 4 Assemble the TV as shown.

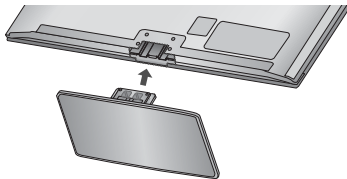

- 5 Fix the 4 screws securely using the holes in the back of the TV.

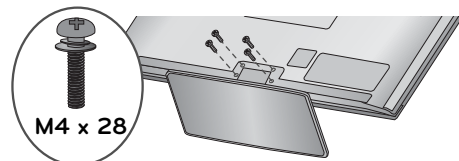

DETACHMENT

- 1 Carefully place the TV screen side down on a cushioned surface to protect the screen from damage.

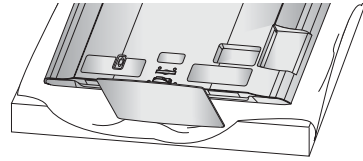

- 2 Remove the screws that hold the stand on.

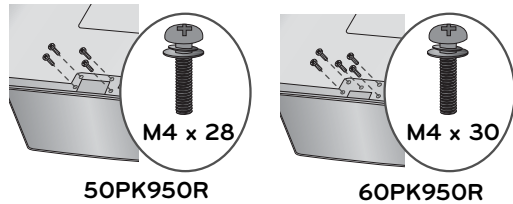

- 3 Detach the stand from TV.

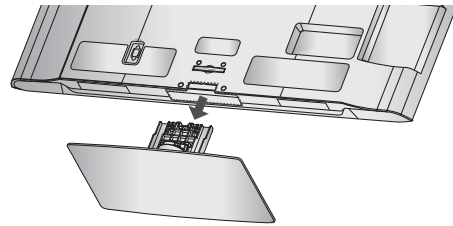

PROTECTION COVER

After removing the stand, install the included **PROTECTION COVER** over the hole for the stand.

Press the **PROTECTION COVER** into the TV until you hear it click.

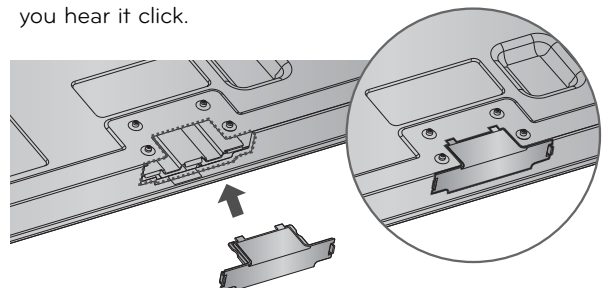

PREPARATION

(For 32/42/47/55LE5500, 32/42/47/55LE7500, 42/47LE8500, 42/47LX6500)

■ Image shown may differ from your TV.

INSTALLATION

- 1 Carefully place the TV screen side down on a cushioned surface to protect the screen from damage.

- 2 Assemble the parts of the **STAND BODY** with the **STAND BASE** of the TV.

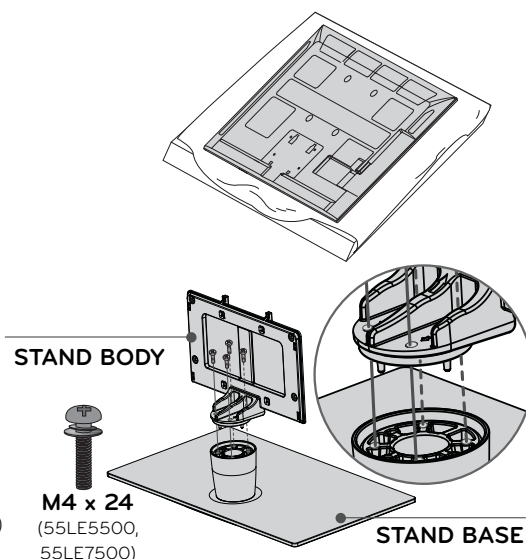
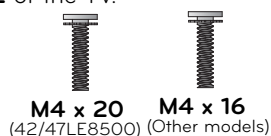

- 3 Assemble the TV as shown.

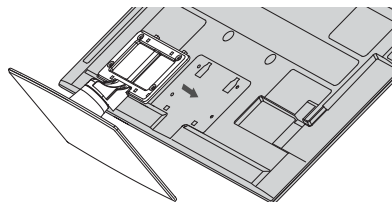

- 4 Assemble the part of the **STAND REAR COVER** with the TV.

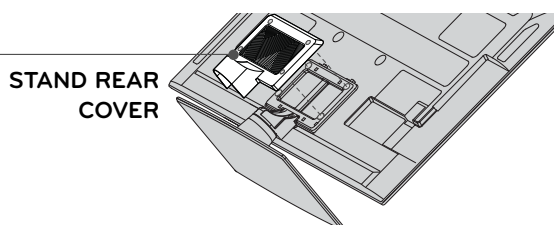

- 5 Fix the 4 screws securely using the holes in the back of the TV.

NOTE

- ▶ When assembling the desk type stand, make sure the screws are fully tightened (If not tightened fully, the TV can tilt forward after the product installation). Do not over tighten.

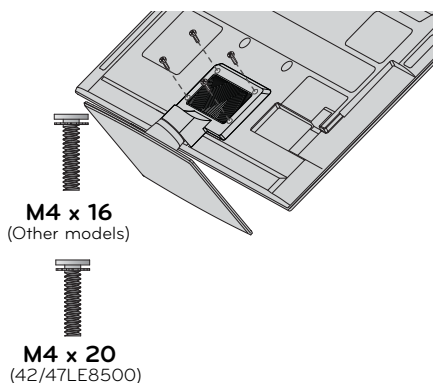

DETACHMENT

- 1 Carefully place the TV screen side down on a cushioned surface to protect the screen from damage.

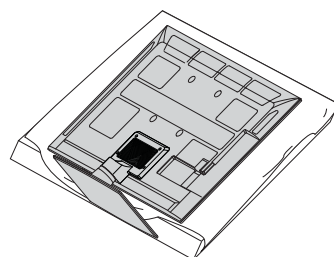

- 2 Remove the screws that hold the stand on.

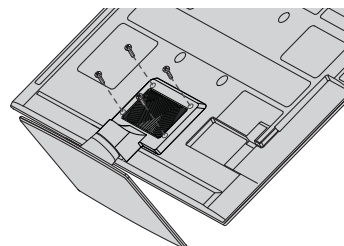

- 3 Detach the **STAND REAR COVER** from TV.

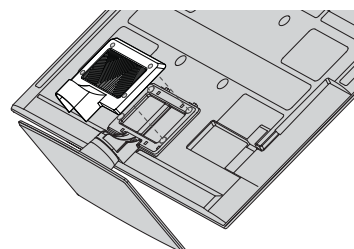

- 4 Detach the stand from TV.

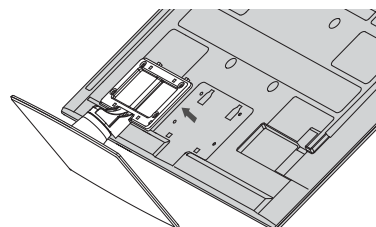

PREPARATION

VESA WALL MOUNTING

Install your wall mount on a solid wall perpendicular to the floor. When attaching to other building materials, please contact your nearest installer.

If installed on a ceiling or slanted wall, it may fall and result in severe personal injury.

We recommend that you use an LG brand wall mount when mounting the TV to a wall.

LG recommends that wall mounting be performed by a qualified professional installer.

PREPARATION

Model	VESA (A * B) 	Standar Screw	Quantity	Wall Mounting Bracket (sold separately)
32LD650, 32LE5500, 32LE7500	200 * 100	M4	4	LSW100B, LSW100BG
42/47LD650, 42/47LE5500, 42/47LX6500, 42/47LE7500, 42/47LE8500	200 * 200	M6	4	LSW200B, LSW200BG
55LD650, 55LE7500, 55LE5500	400 * 400	M6	4	LSW400B, LSW400BG, DSW400BG
50PK950R	400 * 400	M6	4	PSW400B, PSW400BG
60PK950R	600 * 400	M8	4	PSW600B, PSW600BG

NOTE

- ▶ Screw length needed depends on the wall mount used. For further information, refer to the instructions included with the mount.
- ▶ Standard dimensions for wall mount kits are shown in the table.
- ▶ When purchasing our wall mount kit, a detailed installation manual and all parts necessary for assembly are provided.
- ▶ Do not use screws longer than the standard dimension, as they may cause damage to the inside to the TV.
- ▶ For wall mounts that do not comply with the VESA standard screw specifications, the length of the screws may differ depending on their specifications.
- ▶ Do not use screws that do not comply with the VESA standard screw specifications. Do not use fasten the screws too strongly, this may damage the TV or cause the TV to a fall, leading to personal injury. LG is not liable for these kinds of accidents.
- ▶ LG is not liable for TV damage or personal injury when a non-VESA or non specified wall mount is used or the consumer fails to follow the TV installation instructions.

CAUTION

- ▶ Do not install your wall mount kit while your TV is turned on. It may result in personal injury due to electric shock.

CABLE MANAGEMENT

- Image shown may differ from your TV.

32/42/47/55LD650

- 1 Connect the cables as necessary.
To connect additional equipment, see the **EXTERNAL EQUIPMENT SETUP** section.

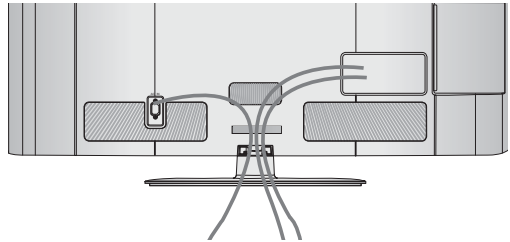

- 2 Open the **CABLE MANAGEMENT CLIP** as shown.

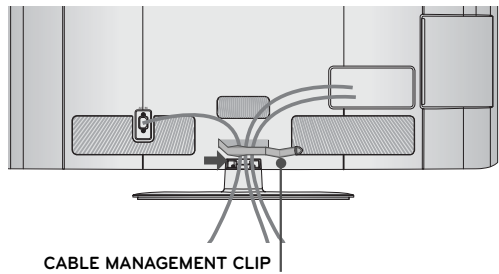

- 3 Put the cables inside the **CABLE MANAGEMENT CLIP** and snap it closed.

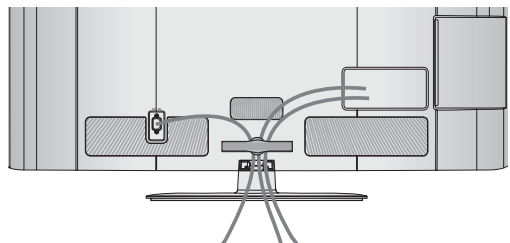

PREPARATION

32/42/47/55LE5500, 32/42/47/55LE7500, 42/47LE8500, 42/47LX6500

- 1 Secure the power cord with the **CABLE HOLDER** on the TV back cover. It will help prevent the power cable from being removed by accident.

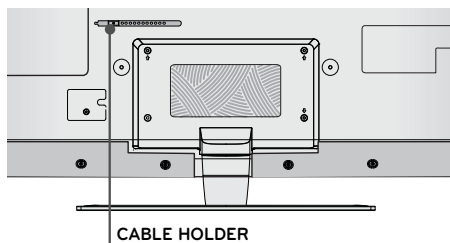

- 2 After connecting the cables as necessary, install the **CABLE HOLDER** as shown and bundle the cables.

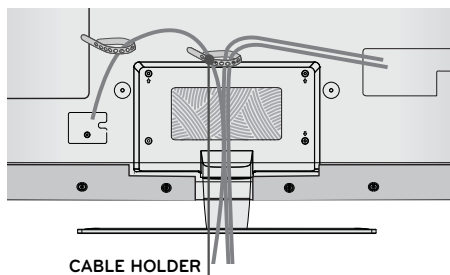

Plasma TV

- 1 After connecting the cables as necessary, install the **CABLE HOLDER** as shown and bundle the cables.

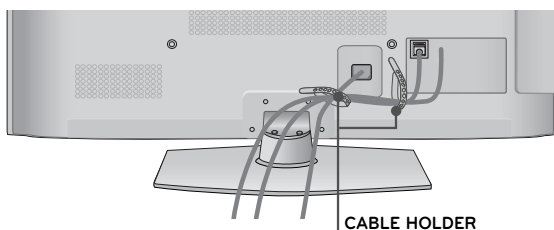

(For 50/60PK950R)

- 1 Connect the cables as necessary. To connect additional equipment, see the **EXTERNAL EQUIPMENT SETUP** section.

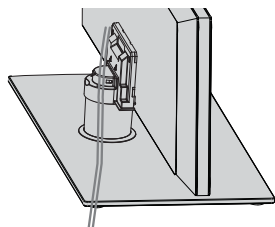

- 2 Install the **CABLE MANAGEMENT CLIP** into the TV until clicking sound.

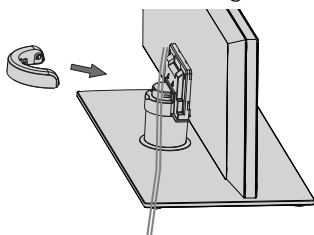

HOW TO REMOVE THE CABLE MANAGEMENT CLIP

- Hold the **CABLE MANAGEMENT CLIP** with both hands and pull it backward as shown.

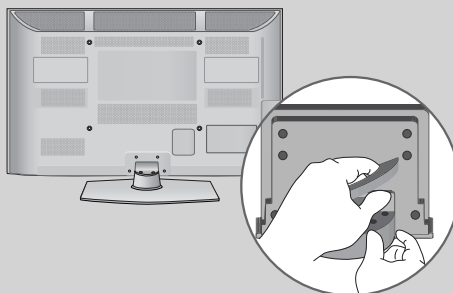

DESKTOP PEDESTAL INSTALLATION

- Image shown may differ from your TV.

For proper ventilation, allow a clearance of 4 inches on all four sides from the wall.

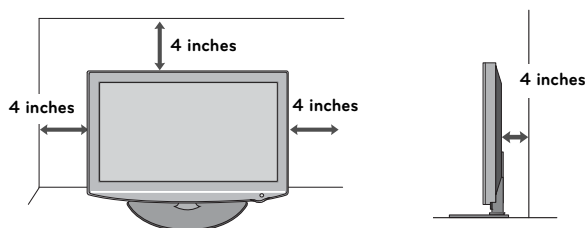

⚠ CAUTION

- ▶ Ensure adequate ventilation by following the clearance recommendations.
- ▶ Do not mount near or above any type of heat source.

SWIVEL STAND

After installing the TV, you can adjust the TV set manually to the left or right direction by 20 degrees to suit your viewing position.

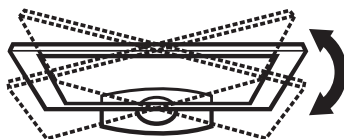

PREPARATION

ATTACHING THE TV TO A DESK

(For 32/42LD650, 32LE5500, 32LE7500)

The TV must be attached to a desk so it cannot be pulled in a forward/backward direction, potentially causing injury or damaging the product.

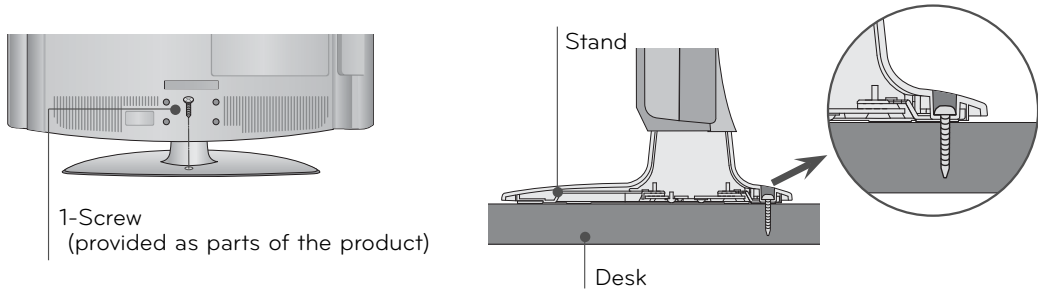

⚠ WARNING

- ▶ To prevent TV from falling over, the TV should be securely attached to the floor/wall per installation instructions. Tipping, shaking, or rocking the machine may cause injury.

KENSINGTON SECURITY SYSTEM

- This feature is not available for all models.

- The TV is equipped with a Kensington Security System connector on the back panel. Connect the Kensington Security System cable as shown below.
- For the detailed installation and use of the Kensington Security System, refer to the user's guide provided with the Kensington Security System.

For further information, contact <http://www.kensington.com>, the internet homepage of the Kensington company. Kensington sells security systems for expensive electronic equipment such as notebook PCs and LCD projectors.

NOTE: The Kensington Security System is an optional accessory.

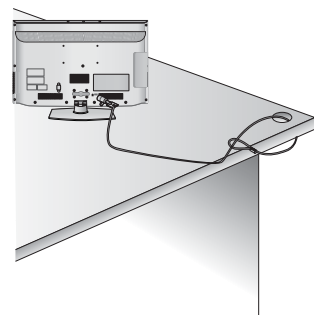

SECURING THE TV TO THE WALL TO PREVENT FALLING WHEN THE TV IS USED ON A STAND

- You should purchase necessary components to prevent the TV from tipping over (when not using a wall mount).
- Image shown may differ from your TV.
We recommend that you set up the TV close to a wall so it cannot fall over if pushed backwards. Additionally, we recommend that the TV be attached to a wall so it cannot be pulled in a forward direction, potentially causing injury or damaging the product.
Caution: Please make sure that children don't climb on or hang from the TV.

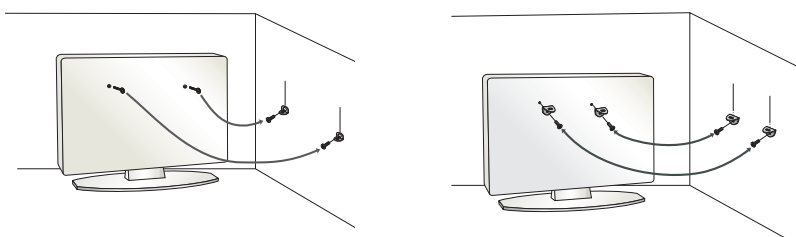

- Insert the eye-bolts (or TV brackets and bolts) to tighten the product to the wall as shown in the picture.
 - * If your product has the bolts in the eye-bolts position before inserting the eye-bolts, loosen the bolts.
 - * Insert the eye-bolts or TV brackets/bolts and tighten them securely in the upper holes.
- Secure the wall brackets with the bolts (sold separately) to the wall. Match the height of the bracket that is mounted on the wall to the holes in the product.
- Ensure the eye-bolts or brackets are tightened securely.

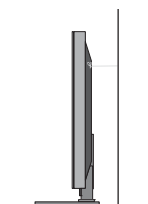

- Use a sturdy rope (sold separately) to tie the product. It is safer to tie the rope so it becomes horizontal between the wall and the product.

NOTE

- ▶ Use a platform or cabinet strong enough and large enough to support the size and weight of the TV.
- ▶ To use the TV safely make sure that the height of the bracket on the wall and the one on the TV are the same.

PREPARATION

- To prevent damage do not connect to the power outlet until all connections are made between the devices.
- Image shown may differ from your TV.

ANTENNA OR CABLE CONNECTION

1. Antenna (Analog)

Wall Antenna Socket or Outdoor Antenna without a Cable Box Connections.

For optimum picture quality, adjust antenna direction if needed.

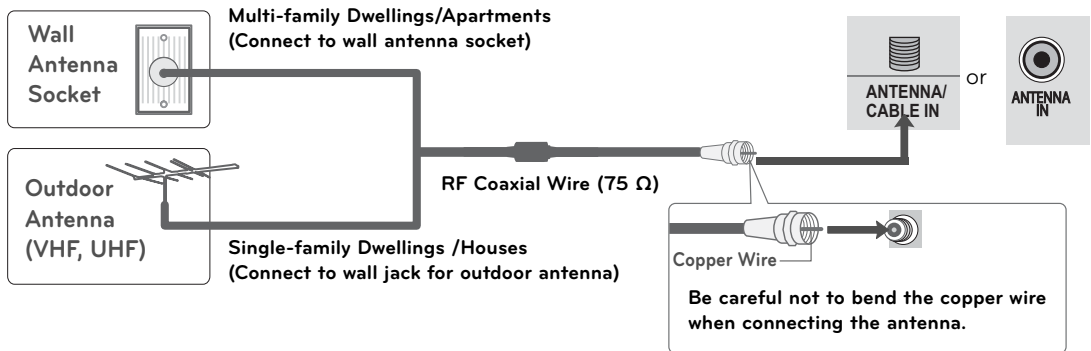

2. Cable

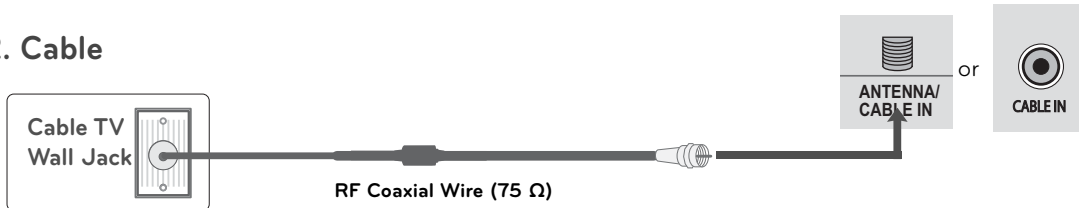

- To improve the picture quality in a poor signal area, please purchase a signal amplifier and install properly.
- If the antenna needs to be split for two TV's, install a 2-Way Signal Splitter.
- If the antenna is not installed properly, contact your dealer for assistance.

EXTERNAL EQUIPMENT SETUP

- To prevent the equipment damage, never plug in any power cords until you have finished connecting all equipment.
- Image shown may differ from your TV.

HD RECEIVER SETUP

This TV can receive digital over-the-air/digital cable signals with an external digital set-top box. However, if you do receive digital signals from a digital set-top box or other digital external device.

Component Connection

1. How to connect

- 1 Connect the video outputs (Y, PB, PR) of the digital set-top box to the **COMPONENT IN VIDEO 1, 2, or 3*** jacks on the TV. Match the jack colors (Y = green, PB = blue, and PR = red).
- 2 Connect the audio output of the digital set-top box to the **COMPONENT IN AUDIO 1, 2, or 3*** jacks on the TV.

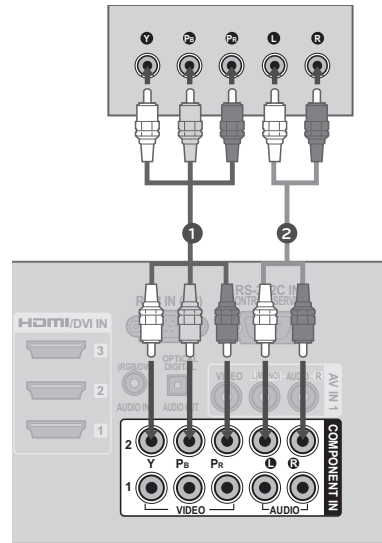

2. How to use

- Turn on the digital set-top box.
(Refer to the owner's manual for the digital set-top box operation.)
- Select the **Component1, Component2, or Component3*** input source on the TV using the **INPUT** button on the remote control.

* Component3: For LED LCD TV

Y, CB/PB, CR/PR

Resolution	Horizontal Frequency(kHz)	Vertical Frequency(Hz)
720x480i	15.73	59.94
	15.75	60.00
720x480p	31.47	59.94
	31.50	60.00
720x576i	15.625	50.00
720x576p	31.25	50.00
1280x720p	44.96	59.94
	37.50	50.00
	45.00	60.00
1920x1080i	33.72	59.94
	28.125	50.00
	33.75	60.00
1920x1080p	56.25	50.00
	67.432	59.94
	67.50	60.00

EXTERNAL EQUIPMENT SETUP

For LED LCD TV

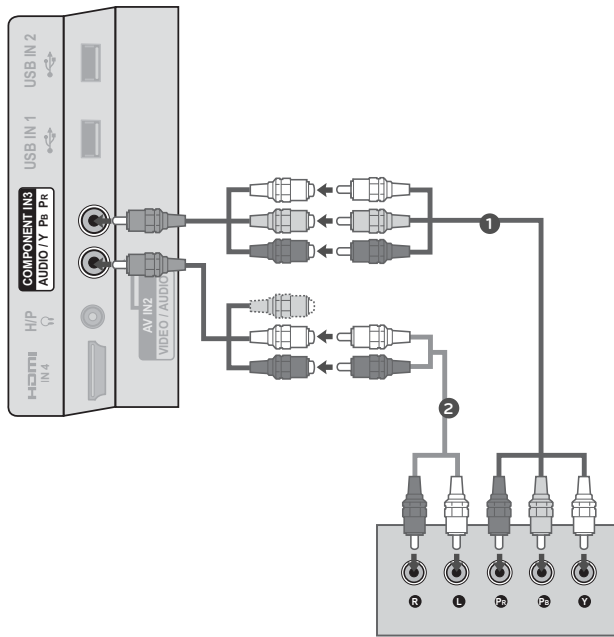

DVI to HDMI Connection

1. How to connect

- 1 Connect the DVI output of the digital set-top box to the **HDMI/DVI IN 1, 2, or 3*** jack on the TV.
- 2 Connect the digital set-top box audio output to the **AUDIO IN (RGB/DVI)** jack on the TV.

2. How to use

- Turn on the digital set-top box.
(Refer to the owner's manual for the digital set-top box.)
- Select the **HDMI1, HDMI2, or HDMI3*** input source on the TV using the **INPUT** button on the remote control.

* **HDMI3:** For 32/42/47/55LE5500, 32/42/47/55LE7500, 50/60PK950R, 42/47LE8500, 42/47LX6500

NOTE

- ▶ A DVI to HDMI cable or adapter is required for this connection. DVI doesn't support audio, so a separate audio connection is necessary.

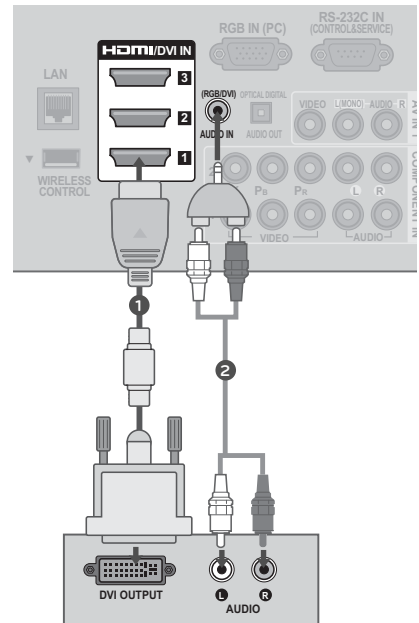

HDMI Connection

1. How to connect

- 1 Connect the digital set-top box to **HDMI/DVI IN 1, 2, 3** or **4*** jack on the TV.
- 2 No separate audio connection is necessary. HDMI supports both audio and video.

2. How to use

- Turn on the digital set-top box.
(Refer to the owner's manual for the digital set-top box.)
- Select the **HDMI1**, **HDMI2**, **HDMI3**, or **HDMI4*** input source on the TV using the **INPUT** button on the remote control.

* **HDMI4**: For 32/42/47/55LE5500, 32/42/47/55LE7500, 50/60PK950R, 42/47LE8500, 42/47LX6500

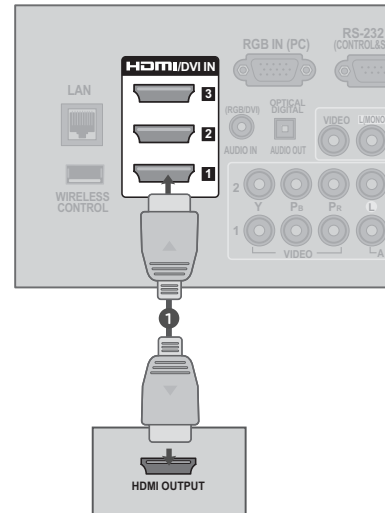

NOTE

- ▶ If an HDMI cable doesn't support High Speed HDMI, it can cause flickers or no screen display. In this case use the latest cables that support High Speed HDMI.
- ▶ HDMI Audio Supported Format: Dolby Digital, PCM

HDMI-DTV

Resolution	Horizontal Frequency(kHz)	Vertical Frequency(Hz)
720x480p	31.47	59.94
	31.50	60.00
720x576p	31.25	50.00
	44.96	59.94
1280x720p	37.5	50.00
	45.00	60.00
1920x1080i	33.72	59.94
	28.125	50.00
1920x1080p	33.75	60.00
	27.00	24.00
	33.75	30.00
	56.25	50.00
	67.432	59.94
	67.50	60.00

EXTERNAL EQUIPMENT SETUP

DVD SETUP

Component Connection

1. How to connect

- 1 Connect the video outputs (Y, PB, PR) of the DVD to the **COMPONENT IN VIDEO 1, 2, or 3*** jacks on the TV. Match the jack colors (Y = green, PB = blue, and PR = red).
- 2 Connect the audio outputs of the DVD to the **COMPONENT IN AUDIO 1, 2, or 3*** jacks on the TV.

2. How to use

- Turn on the DVD player, insert a DVD.
- Select the **Component1**, **Component2**, or **Component3*** input source on the TV using the **INPUT** button on the remote control.
- Refer to the DVD player's manual for operating instructions.

* *Component3: For LED LCD TV*

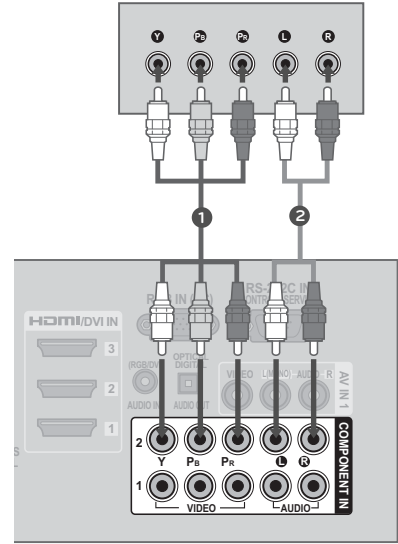

Component Input ports

To get better picture quality, connect a DVD player to the component input ports as shown below.

Component ports on the TV	Y	P _B	P _R
Video output ports on DVD player	Y	P _B	P _R
	Y	B-Y	R-Y
	Y	C _b	C _r
	Y	P _b	P _r

For LED LCD TV

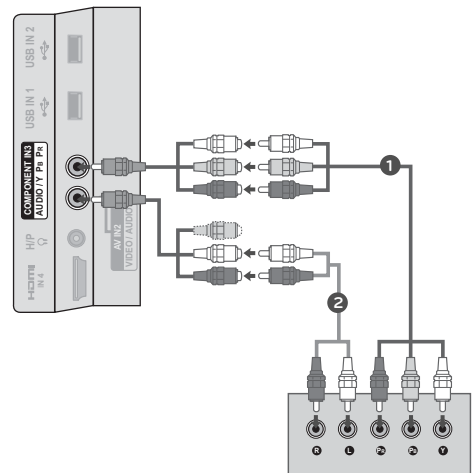

Composite (RCA) Connection

1. How to connect

- 1 Connect the **AUDIO/VIDEO** jacks between TV and DVD. Match the jack colors (Video = yellow, Audio Left = white, and Audio Right = red)

2. How to use

- Turn on the DVD player, insert a DVD.
- Select the **AV1** or **AV2** input source on the TV using the **INPUT** button on the remote control.
- Refer to the DVD player's manual for operating instructions.

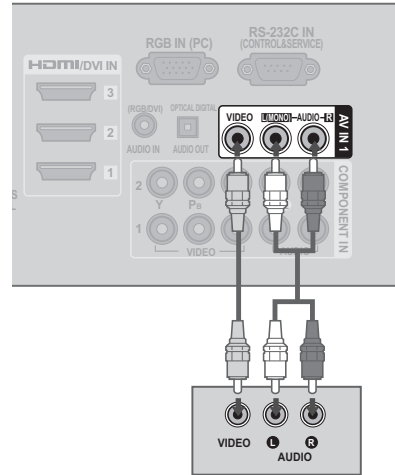

For LED LCD TV

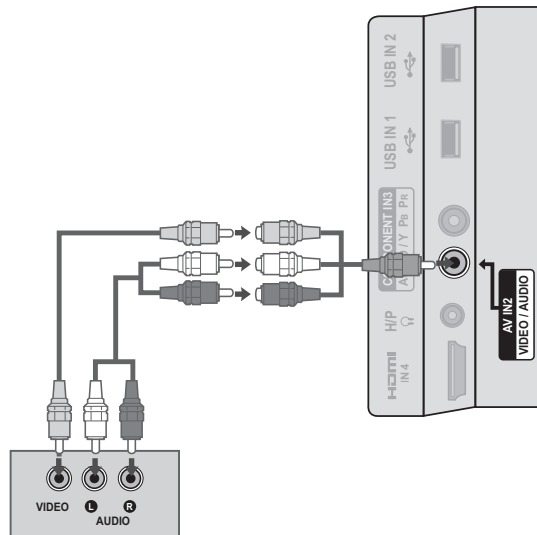

EXTERNAL EQUIPMENT SETUP

HDMI Connection

1. How to connect

- 1 Connect the HDMI output of the DVD to the **HDMI/DVI IN 1, 2, 3** or **4*** jack on the TV.
- 2 No separate audio connection is necessary. HDMI supports both audio and video.

2. How to use

- Select the **HDMI1, HDMI2, HDMI3,** or **HDMI4*** input source on the TV using the **INPUT** button on the remote control.
- Refer to the DVD player's manual for operating instructions.

* **HDMI4:** For 32/42/47/55LE5500, 32/42/47/55LE7500, 50/60PK950R, 42/47LE8500, 42/47LX6500

! NOTE

- ▶ If an HDMI cable doesn't support High Speed HDMI, it can cause flickers or no screen display. In this case use the latest cables that support High Speed HDMI.
- ▶ HDMI Audio Supported Format: Dolby Digital, PCM

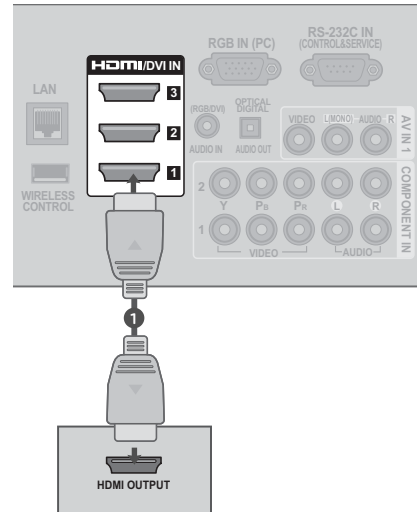

VCR SETUP

Antenna Connection

1. How to connect

- 1 Connect the RF antenna out socket of the VCR to the **ANTENNA/CABLE IN** socket on the TV.
- 2 Connect the antenna cable to the RF antenna in socket of the VCR.

2. How to use

- Set VCR output switch to 3 or 4 and then tune TV to the same channel number.
- Insert a video tape into the VCR and press PLAY on the VCR (Refer to the VCR owner's manual).

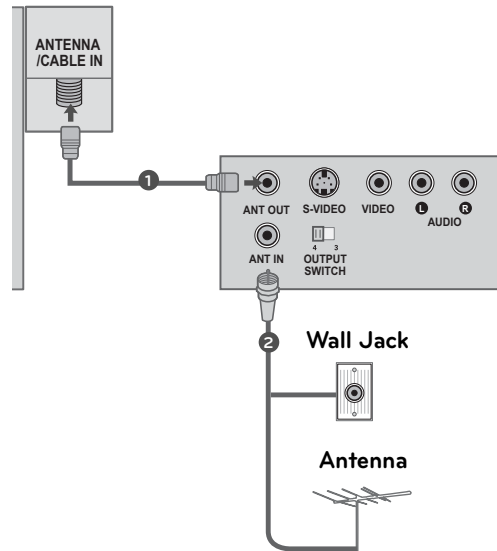

EXTERNAL EQUIPMENT SETUP

Composite (RCA) Connection

1. How to connect

- 1 Connect the **AUDIO/VIDEO** jacks between TV and VCR. Match the jack colors (Video = yellow, Audio Left = white, and Audio Right = red)

2. How to use

- Insert a video tape into the VCR and press PLAY on the VCR. (Refer to the VCR owner's manual.)
- Select the **AV1** input source on the TV using the **INPUT** button on the remote control.
- If connected to **AV IN 2**, select **AV2** input source on the TV.

NOTE

- ▶ If you have a mono VCR, connect the audio cable from the VCR to the **AUDIO L/MONO** jack of the TV.

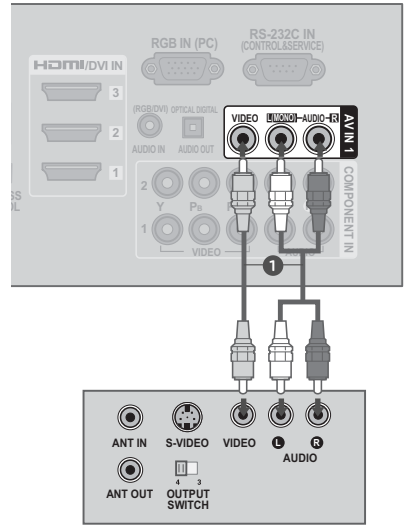

For LED LCD TV

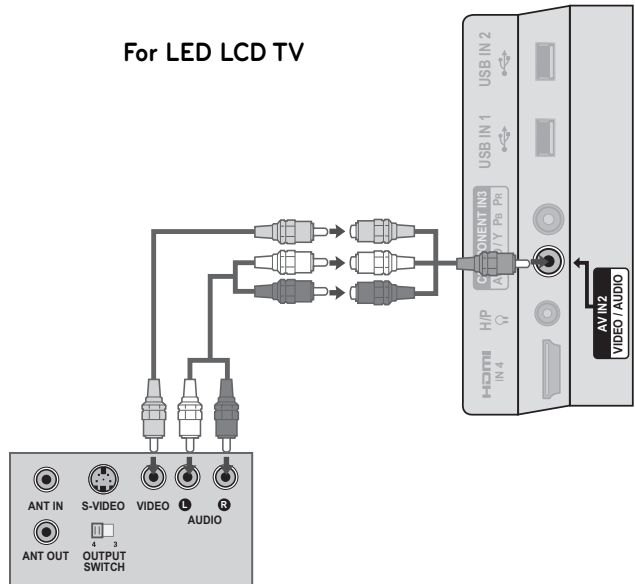

OTHER A/V SOURCE SETUP

1. How to connect

- 1 Connect the **AUDIO/VIDEO** jacks between TV and external equipment. Match the jack colors. (Video = yellow, Audio Left = white, and Audio Right = red)

2. How to use

- Select the **AV1** input source on the TV using the **INPUT** button on the remote control.
- If connected to **AV IN 2** input, select the **AV2** input source on the TV.
- Operate the corresponding external equipment.

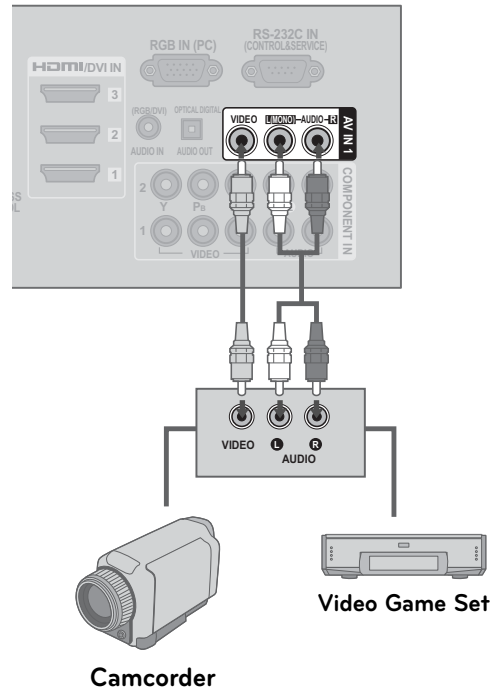

EXTERNAL EQUIPMENT SETUP

USB CONNECTION

1. How to connect

- 1 Connect the USB device to the **USB IN 1** or **2** jack on the side of TV.

2. How to use

- After connecting the **USB IN** jack, you use the USB function. (▶ p.91)

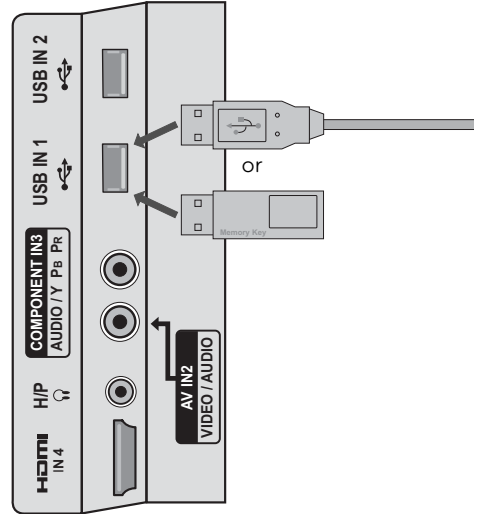

HEADPHONE SETUP (EXCEPT 50/60PK950R)

You can listen to the sound through the headphone.

1. How to connect

- 1 Plug the headphone into the headphone socket.
- 2 To adjust the headphone volume, press the **VOL +/-** button. If you press the **MUTE** button, the sound from the headphone is switched off.

! NOTE

- ▶ AUDIO menu options are disabled when connecting a headphone.
- ▶ When changing AV MODE with a headphone connected, the change is applied to video but not to audio.
- ▶ Optical Digital Audio Out is not available when connecting a headphone.

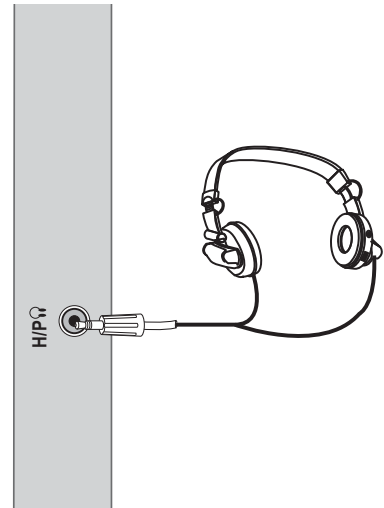

AUDIO OUT CONNECTION

Send the TV's audio to external audio equipment via the Audio Output port.

1. How to connect

- 1 Connect one end of the optical cable to the TV port of **OPTICAL DIGITAL AUDIO OUT**.
- 2 Connect the other end of the optical cable to the digital audio input on the audio equipment.
- 3 Set the "TV Speaker option - Off" in the AUDIO menu. (▶ p.146). See the external audio equipment instruction manual for operation.

NOTE

- ▶ When connecting with external audio equipment, such as amplifiers or speakers, you can turn the TV speakers off in the menu. (▶ p.146)

CAUTION

- ▶ Do not look into the optical output port. Looking at the laser beam may damage your vision.
- ▶ Audio with ACP (Audio Copy Protection) function may block digital audio output.

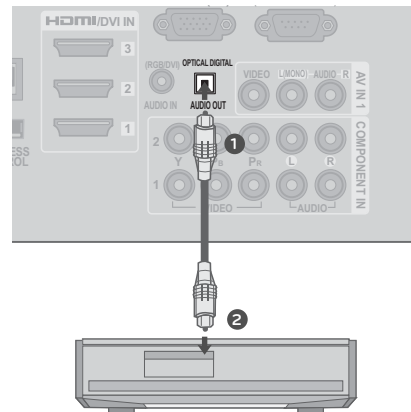

EXTERNAL EQUIPMENT SETUP

EXTERNAL EQUIPMENT WIRELESS CONNECTION (OPTIONAL EXTRA)

LG TVs with a Wireless Control port support the LG Wireless Media Box, which is sold separately. When you connect the wireless ready dongle (included with the media box) to the TV, external devices can be connected to the LG Wireless Media Box and video and audio will be sent to the TV wirelessly.

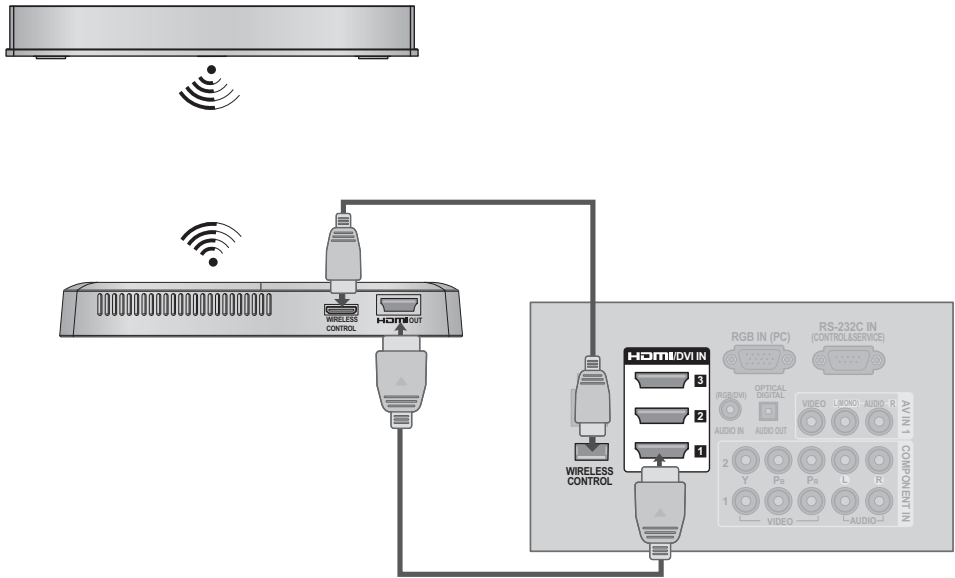

1. How to connect

- 1 Connect the **WIRELESS CONTROL** jack of the Wireless Dongle to the **WIRELESS CONTROL** jack on the TV.
- 2 Connect **HDMI OUT** jack of the Wireless Dongle to the **HDMI IN** jack on the TV.

2. How to use

- Select the desired input source on the TV using the **INPUT** button on the remote control.
- Refer to the Wireless Media Box manual for operating instructions.

! NOTE

- ▶ When using the external device connected to the Wireless Media Box, some functions of the TV menu may not work.

PC SETUP

This TV provides Plug and Play capability, meaning that the PC adjusts automatically to the TV's settings.

VGA (D-Sub 15 Pin) Connection

1. How to connect

- 1 Connect the VGA output of the PC to the **RGB IN (PC)** jack on the TV.
- 2 Connect PC audio output to the **AUDIO IN (RGB/DVI)** jack on the TV.

2. How to use

- Turn on the PC and the TV.
- Select the **RGB-PC** input source on the TV using the **INPUT** button on the remote control.

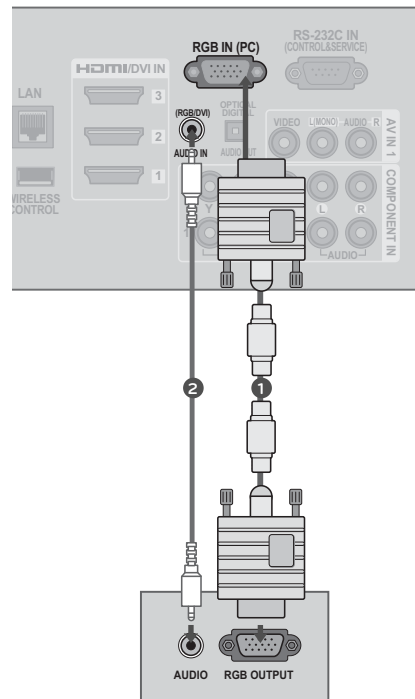

EXTERNAL EQUIPMENT SETUP

DVI to HDMI Connection

1. How to connect

- 1 Connect the DVI output of the PC to the **HDMI/DVI IN 1, 2, or 3*** jack on the TV.
- 2 Connect the PC audio output to the **AUDIO IN (RGB/DVI)** jack on the TV.

2. How to use

- Turn on the PC and the TV.
- Select the **HDMI1, HDMI2, or HDMI3*** input source on the TV using the **INPUT** button on the remote control.

* **HDMI3:** For 32/42/47/55LE5500, 32/42/47/55LE7500, 50/60PK950R, 42/47LE8500, 42/47LX6500

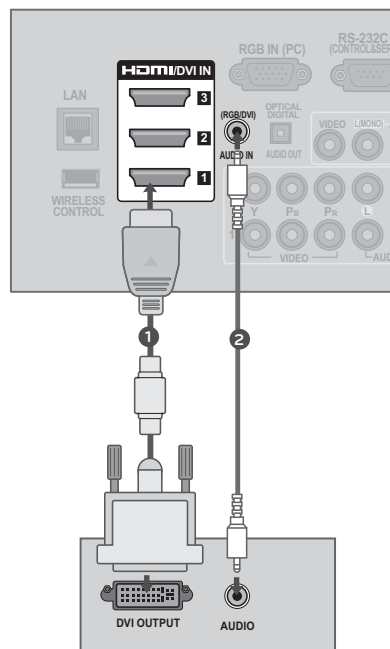

NOTE

- ▶ To get the the best picture quality, adjust the PC graphics card to **1920x1080**.
- ▶ Depending on the graphics card, DOS mode may not work if a HDMI to DVI Cable is in use.
- ▶ In PC mode, there may be noise associated with the resolution, vertical pattern, contrast or brightness. If noise is present, change the PC output to another resolution, change the refresh rate to another rate or adjust the brightness and contrast on the PICTURE menu until the picture is clear.
- ▶ Avoid keeping a fixed image on the screen for a long period of time. The fixed image may become permanently imprinted on the screen.
- ▶ The synchronization input form for Horizontal and Vertical frequencies is separate.
- ▶ Depending on the graphics card, some resolution settings may not allow the image to be positioned on the screen properly.
- ▶ When selecting HDMI-PC, set the "Input Label - PC" in the OPTION menu.

Supported Display Specifications (RGB-PC, HDMI-PC)

Resolution	Horizontal Frequency(kHz)	Vertical Frequency(Hz)
640x350 (RGB-PC)	31.468	70.09
720x400 (RGB-PC)	31.469	70.08
640x480	31.469	59.94
800x600	37.879	60.317
1024x768	48.363	60.004
1280x768	47.776	59.87
1360x768	47.72	59.799
1280x1024 (RGB-PC)	63.668	59.895
1280x1024 (HDMI-PC)	63.595	60.00
1920x1080 (RGB-PC)	66.587	59.934
1920x1080 (HDMI-PC)	66.647	59.988

EXTERNAL EQUIPMENT SETUP

Screen Setup for PC mode

Selecting Resolution

You can choose the resolution in RGB-PC mode.

The Position, Phase, and Size can also be adjusted.

You can choose this option only when the PC resolution is set to 1024X768, 1280X768 or 1360X768.

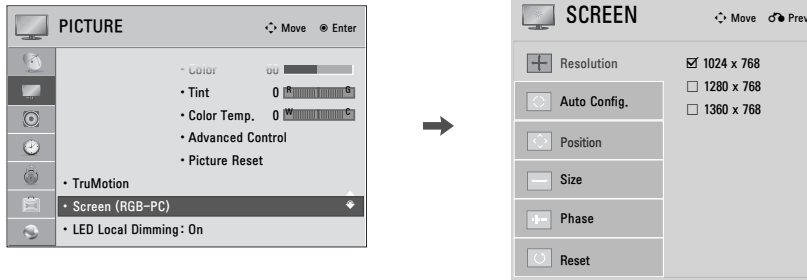

1 Select **PICTURE**.

2 Select **Screen (RGB-PC)**.

3 Select **Resolution**.

4 Select the desired resolution.

5

Auto Configure

Automatically adjusts picture position and minimizes image instability. After adjustment, if the image is still not correct, try using the manual settings or a different resolution or refresh rate on the PC.

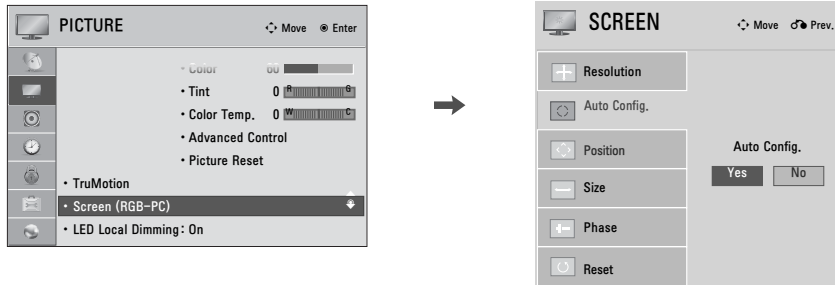

1 Select **PICTURE**.

2 Select **Screen (RGB-PC)**.

3 Select **Auto Config..**

4 Select **Yes**.

5 Start Auto Configuration.

- If the position of the image is still not correct, try Auto adjustment again.
- If picture needs to be adjusted again after Auto adjustment in RGB-PC, you can adjust the **Position, Size or Phase**.

Adjustment for screen Position, Size, and Phase

If the picture is not clear after auto adjustment or if text is shaking, adjust the picture phase manually. This feature operates only in RGB-PC mode.



- 1 Select **PICTURE**.
- 2 Select **Screen (RGB-PC)**.
- 3 Select **Position, Size, or Phase**.
- 4 Make appropriate adjustments.
- 5

- **Position:** This function is to adjust picture to left/right and up/down as you prefer.
- **Size:** This function is to minimize any vertical bars or stripes visible on the screen background. And the horizontal screen size will also change.
- **Phase:** This function allows you to remove any horizontal noise and clear or sharpen the image of characters.

Screen Reset (Reset to original initial values)

Returns **Position, Size, and Phase** to the default initial settings.

This feature operates only in RGB-PC mode.

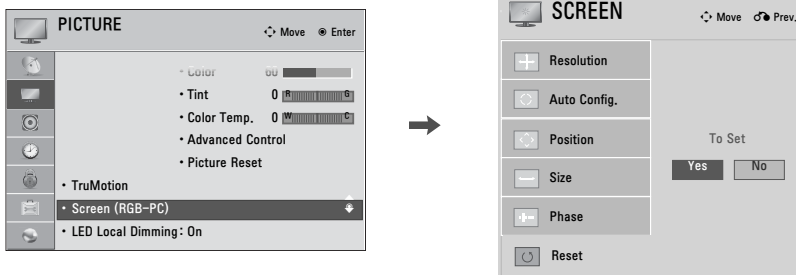

- 1 Select **PICTURE**.
- 2 Select **Screen (RGB-PC)**.
- 3 Select **Reset**.
- 4 Select **Yes**.
- 5 Start **Reset**.

EXTERNAL EQUIPMENT SETUP

NETWORK SETUP

Wired Network Connection

This TV can be connected to a local area network (LAN) via the LAN port. After making the physical connection, the TV needs to be set up for network communication.

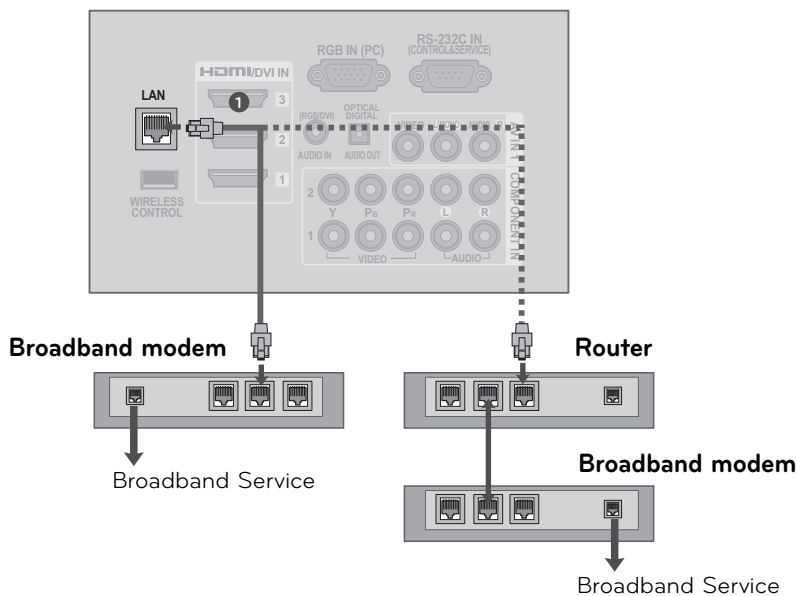

1. How to connect

- 1 Connect the LAN port of the Modem or Router to the **LAN** port on the TV.

2. How to use

- Select "**Network Setting**" in the NETWORK menu.
- After connecting the **LAN** port, use the NETCAST menu.

⚠ CAUTION

- ▶ Do not connect a modular phone cable to the LAN port.
- ▶ Since there are various connection methods, please follow the specifications of your telecommunication carrier or internet service provider.

Wired Network Setup

If wired and wireless networks are both available, wired is the preferred method.

After making a physical connection, a small number of home networks may require the TV network settings to be adjusted.

For detail information, contact your internet provider or router manual.

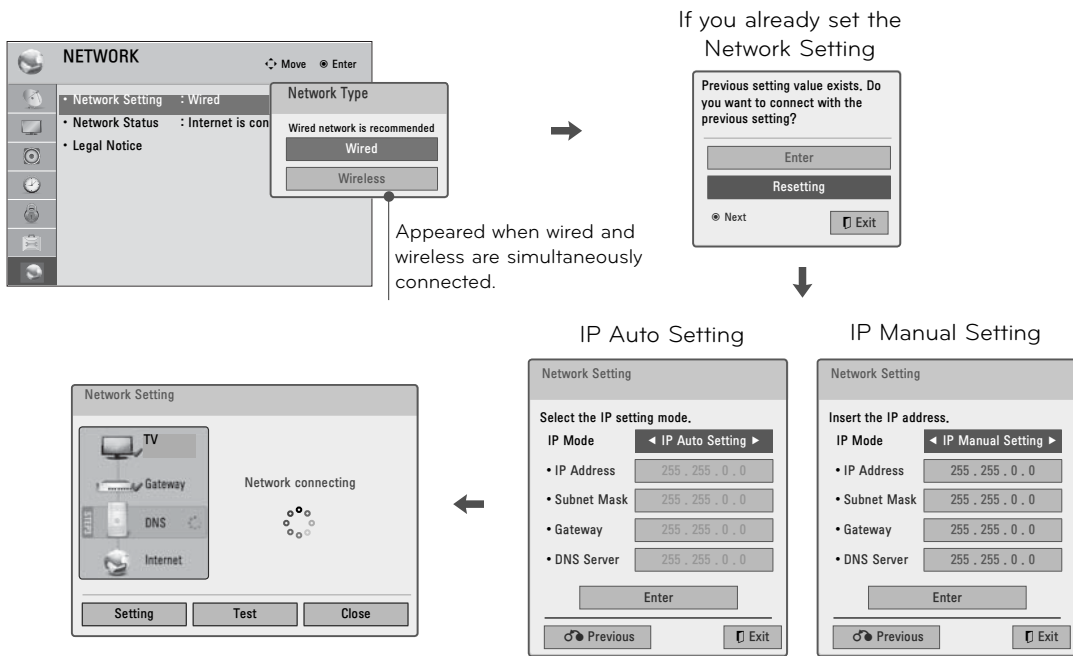

1 Select **NETWORK**.

2 Select **Network Setting**.

3 Select **Wired**.

4 If you already set Network Setting:
Select **Resetting**. The new connection settings resets the current network settings.

5 Select **IP Auto Setting** or **IP Manual Setting**.

When Selecting **IP Manual Setting**:
IP addresses will need to be input manually.

6 Select **Enter**.

- This feature requires an always-on broadband internet connection.
- You do not need to connect to a PC to use this function.
- If **Network Setting** is not working, check your network conditions. Check the LAN cable and make sure your router has DHCP turned on if you wish to use the Auto Setting.
- If the **Network Setting** is not completed, network may not operate normally.
- **IP Auto Setting**: Select it if there is a DHCP server on the local area network (LAN) via wired connection, the TV will automatically be allocated an IP address. If you're using a broadband router or broadband modem that has a DHCP (Dynamic Host Configuration Protocol) server function. The IP address will automatically be determined.
- **IP Manual Setting**: Select it if there is no DHCP server on the network and you want to set the IP address manually.

EXTERNAL EQUIPMENT SETUP

! NOTE

- ▶ Use a standard LAN cable with this TV. Cat5 or better with a RJ45 connector.
- ▶ Many network connection problems during set up can often be fixed by re-setting the router or modem. After connecting the player to the home network, quickly power off and/or disconnect the power cable of the home network router or cable modem. Then power on and/or connect the power cable again.
- ▶ Depending on the internet service provider (ISP), the number of devices that can receive internet service may be limited by the applicable terms of service. For details, contact your ISP.
- ▶ LG is not responsible for any malfunction of the TV and/or the internet connection feature due to communication errors/malfunctions associated with your broadband internet connection, or other connected equipment.
- ▶ LG is not responsible for problems within your internet connection.
- ▶ Some content available through the network connection may not be compatible with the TV. If you have questions about such content, please contact the producer of the content.
- ▶ You may experience undesired results if the network connection speed does not meet the requirements of the content being accessed.
- ▶ Some internet connection operations may not be possible due to certain restrictions set by the Internet service provider (ISP) supplying your broadband Internet connection.
- ▶ Any fees charged by an ISP including, without limitation, connection charges are your responsibility.
- ▶ A 10 Base-T or 100 Base-TX LAN port is required for connection to this TV. If your internet service does not allow for such a connection, you will not be able to connect the TV.
- ▶ A DSL modem is required to use DSL service and a cable modem is required to use cable modem service. Depending on the access method of and subscriber agreement with your ISP, you may not be able to use the internet connection feature contained in this TV or you may be limited to the number of devices you can connect at the same time. (If your ISP limits subscription to one device, this TV may not be allowed to connect when a PC is already connected.)
- ▶ The use of a "Router" may not be allowed or its usage may be limited depending on the policies and restrictions of your ISP. For details, contact your ISP directly.
- ▶ The wireless network operates at 2.4 GHz radio frequencies that are also used by other household devices such as cordless telephone, Bluetooth® devices, microwave oven, and can be affected by interference from them. It can be interrupted by the device using 5Ghz radio frequencies. It is same device with LG wireless media box, cordless telephone, other Wi-Fi device.
- ▶ It may decrease the service speed using Wireless network by surrounding wireless condition.
- ▶ Turn off all unused network equipment in your local home network. Some devices may generate network traffic.
- ▶ In some instances, placing the access point or wireless router higher up away from the floor may improve the reception.
- ▶ The reception quality over wireless depends on many factors such as type of the access point, distance between the TV and access point, and the location of the TV.
- ▶ When connecting internet through the wired/wireless sharing machine, it may interrupt the connection because of the use limitation and confirmation of service company.
- ▶ To connect wireless AP, an AP that supports the wireless connection is necessary, and the wireless connection function of the AP needs to be activated. Please enquire to the AP supplier for the possibility of AP wireless connections.
- ▶ Please verify the security settings of AP SSID for wireless AP connection, and enquire to the AP supplier for the AP SSID security settings.
- ▶ The TV can become slower or malfunction with wrong settings of network equipments (wired/wireless router, hub, etc). Please install correctly by referring to the manual of the equipment, and set the network.

Wireless Network

The LG Wireless LAN for Broadband/DLNA Adaptor, which is sold separately, allows the TV to connect to a wireless lan network.

The network configuration and connection method may vary depending on the equipment in use and the network environment. Refer to the setup instructions supplied with your access point or wireless router for detailed connection steps and network settings.

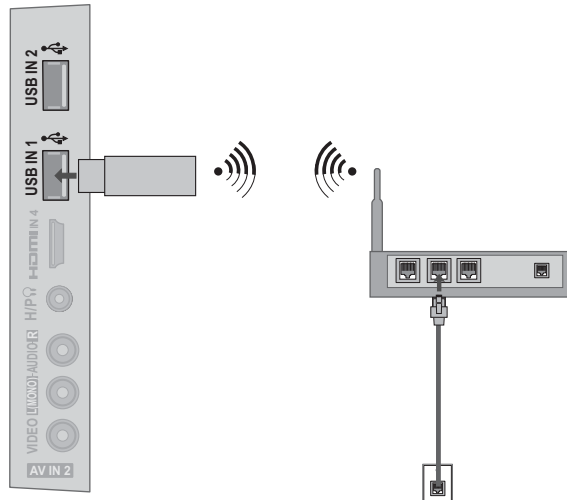

1. How to connect

- 1 Connect the "LG Wireless LAN for Broadband/DLNA Adaptor (sold separately)" to the **USB IN 1** or **2** port on the TV.

2. How to use

- Select "**Network Setting**" in the NETWORK menu.
- After connecting, you can use the NETCAST menu.

NOTE

- ▶ For enjoying pictures, music, or video stored in the PC using the router, the use of wired port in the router is recommended.
- ▶ When the wireless port of the router is used, there may be restrictions for some functions.

EXTERNAL EQUIPMENT SETUP

Wireless Network Setup

Setting up the AP (Access Point) or the wireless router is required before connecting the TV to the network.

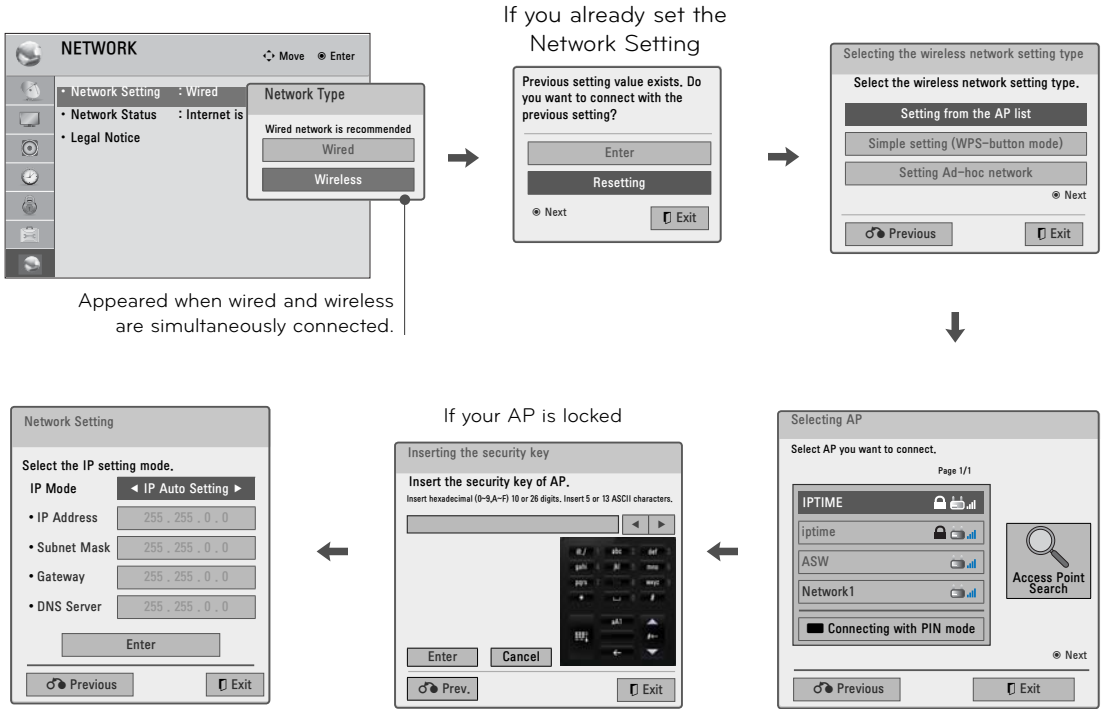

- Select **NETWORK**.
- Select **Network Setting**.
- Select **Wireless**.
- If you already set Network Setting: Select **Resetting**.
The new connection settings resets the current network settings.
- Select **Setting from the AP list**.

- Scan the all available AP (Access Point) or wireless routers within range and display them as a list.
- Select an AP (Access Point) or wireless router on the list.
(If your AP is locked, insert the security key of AP).
- Input the security key of AP.
- Repeat step 4-5 on P.45

When a security code is already set

PIN (Personal Identification Number)

If you want to connect the AP (Access Point) or router with PIN, use this feature.

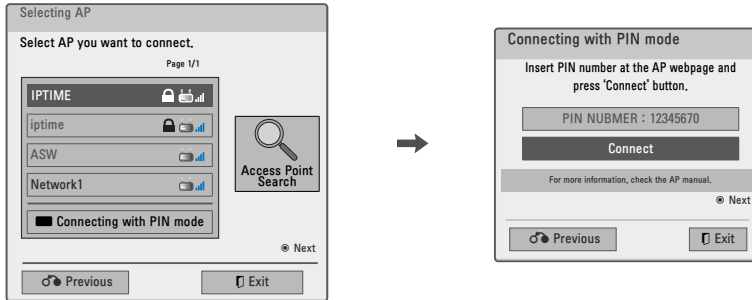

1 Repeat step 1-6 on P.48.

2  Connect the access point with **PIN** mode.

3 You can see the Network ID and Security Key on your TV screen.
Enter the PIN number to your device.

4  Select **Connect**.

5 Repeat step 4-5 on P.45.

■ PIN number is the unique 8 digit number of the dongle.

Simple setting (WPS-button mode)

If your access point or wireless router that supports PIN or WPS (Wi-Fi Protected Setup), it's available to use your access point or wireless router within 120 counts. You do not need to know the access point name (SSID: Service Set Identifier) and security code of your access point or wireless router.

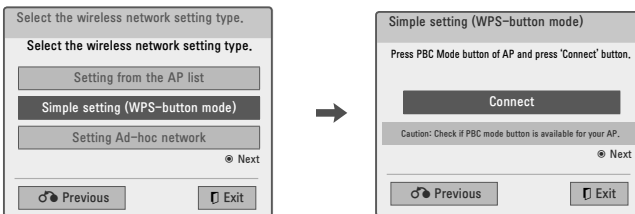

1 Repeat step 1-4 on P.48.

2   Select **Simple setting (WPS-button mode)**.

3  Select **Connect**.

4 Repeat step 4-5 on P.45.

EXTERNAL EQUIPMENT SETUP

AD-hoc Mode

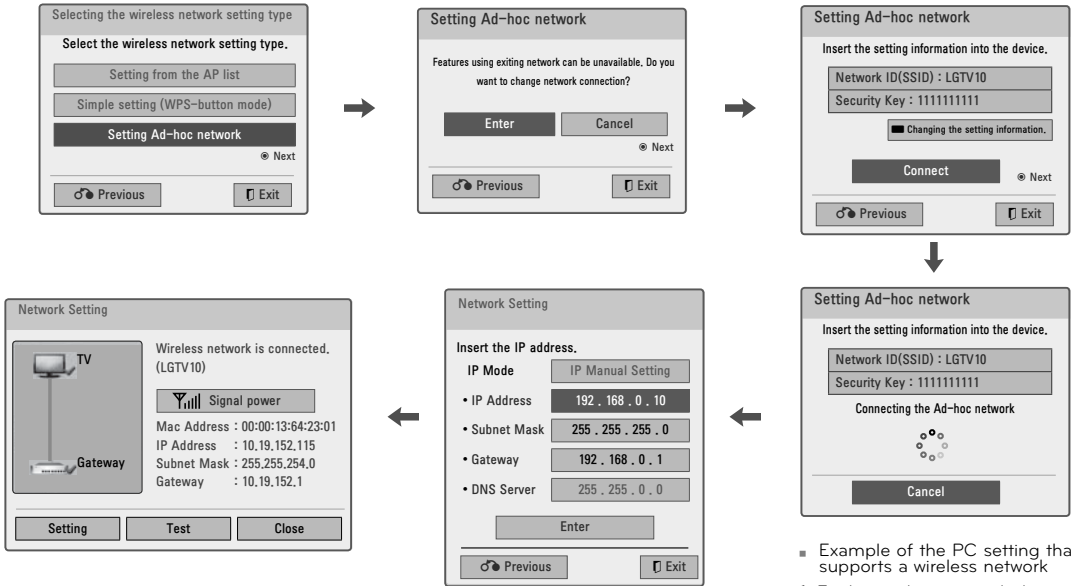

This is the method of communicating directly with the machine to communicate without AP.
This is the same as connecting two PCs with a cross cable.



- PC Setting
Internet Protocol(TCP/IP) of PC needs to be set manually.
IP address, Subnet Mask, and default Gateway can be set with your own discretion.
i.e) IP address: 192.168.0.1 / Subnet Mask: 255.255.255.0 / default Gateway: 192.168.0.10
- TV Setting
Verify IP address and gateway of PC.
Input Gateway address of PC to IP Address, and IP Address of PC to Gateway, and select **Enter**.
i.e) IP address: 192.168.0.10 / Subnet Mask: 255.255.255.0 / default Gateway: 192.168.0.1

- Example of the PC setting that supports a wireless network
1. Find a wireless network device in your PC.
 2. Select LGTV10 that appears in the list. (Select the same name as the network ID that appears on your TV screen.)
 3. Type 1111111111 in the Inserting the security key dialog. (Type the security key that appears on your TV screen.)



1 Repeat step 1-3 on P.48.

2   Select **Setting AD-hoc network**.

3    Select **Enter**.





4  Select **Connect** to connect Ad-hoc network.
You can see the Network ID and Security Key on your TV screen.
Enter this Network ID and Security Key to your device.
If a network may not operate, change the setting information using the RED button.

5   Insert the IP address.

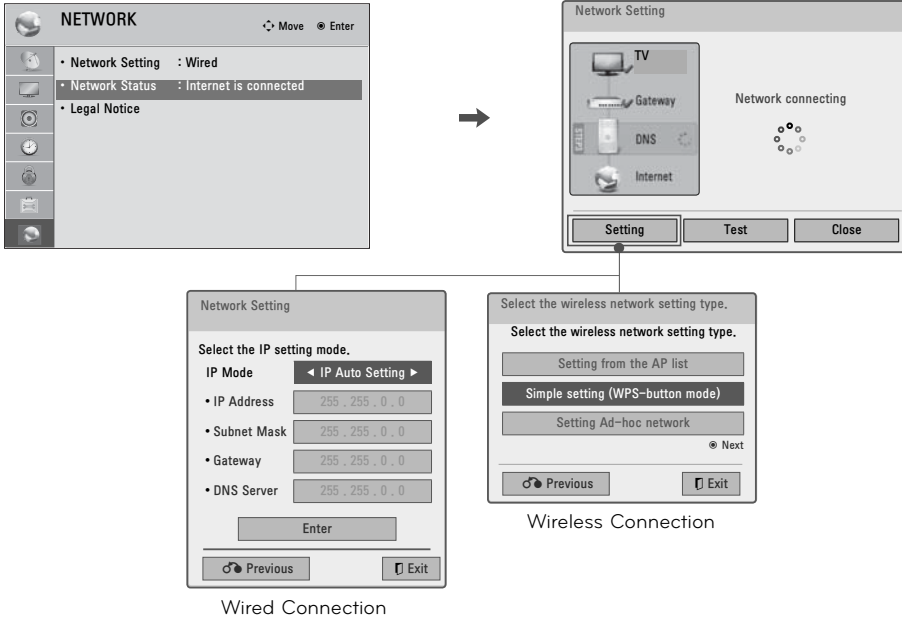
6   Network setting is completed. Select **Close**.

Network Status



- 1   Select **NETWORK**.
- 2   Select **Network Status**.
- 3  Check the nework status.

- **Setting:** Return to the network setting menu or wireless network setting type menu.
- **Test:** Test the current network status after setting the network.
- **Close:** Return to the previous menu.

WATCHING TV / CHANNEL CONTROL

REMOTE CONTROL FUNCTIONS

When using the remote control, aim it at the remote control sensor on the TV.

POWER	Turns the TV on from standby or off to standby.
ENERGY SAVING	Adjusts the Energy Saving setting. ▶ p.130
AV MODE	Toggles through preset Video and Audio modes. ▶ p.74
INPUT	Rotates through inputs. Also switches the TV on from standby. ▶ p.71
TV	Returns to the last TV channel.
TV/RAD	Selects Radio, TV, CATV and DTV channel.
LIGHT (FOR PLASMA TV)	Illuminates the remote control buttons.
NUMBER button	
LIST	Displays the channel table. ▶ p.70
Q.VIEW	Tunes to the last channel viewed.
VOLUME UP/DOWN	Adjusts the volume.
FAV	Set up desired favorite channels list ▶ p.69
MARK	Select the input to apply the Picture Wizard settings. ▶ p.129 Use to mark or unmark a photo/music/movie. ▶ p.99, 104, 110
CHAR/NUM	Shifts the Character or Number for internet service.
RATIO	Changes the aspect ratio.
DELETE	Deletes the character or number on the screen.
MUTE	Switches the sound on or off. ▶ p.56
CHANNEL UP/DOWN	Changes the channel.
PAGE UP/DOWN	Moves from one full set of screen information to the next one.



MENU	Displays the main menu or clears all on-screen displays and return to TV viewing.
NETCAST	Select the desired NETCAST menu source.
Q.MENU	Opens the list of Quick Menu options. ▶ p.61
THUMBSTICK (Up/Down/Left Right/ENTER)	Navigates the on-screen menus and adjusts the system settings to your preference.
BACK	Allows the user to move return one step in an interactive application or other user interaction function.
EXIT	Clears all on-screen displays and return to TV viewing.
SIMPLINK	See a list of AV devices connected to TV. When you toggle this button, the SIMPLINK menu appears at the screen. ▶ p.75
GUIDE	Show Channel schedule.

COLOR BUTTON	Access special functions in some menus.
USB, SMPLINK Control buttons	•Controls MY MEDIA menu (Photo List, Music List, Movie List) •Controls the SIMPLINK compatible devices.
SUBTITLE	Recalls your preferred subtitle in digital mode.
INFO	Displays programe information at the bottom of the screen.
FREEZE (FOR PLASMATV)	Pause the present picture at the screen. (It doesn't work at USB Mode and Simplink.) The TV returns to normal viewing automatically if no signal is received or no operation is performed for 5 minutes. If you keep the screen in Freeze condition, the residual image can exist.

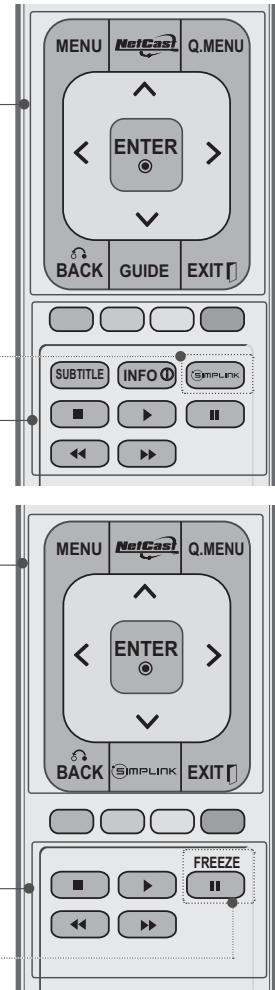

WATCHING TV / CHANNEL CONTROL

POWER	Turns the TV on from standby or off to standby.
ENERGY SAVING	Adjusts the Energy Saving setting. ▶p.130
AV MODE	Toggles through preset Video and Audio modes. ▶p.74
INPUT	Rotates through inputs. Also switches the TV on from standby. ▶p.71
TV/RAD	Selects Radio, TV, CATV and DTV channel.
NUMBER button	
LIST	Displays the channel table. ▶p.70
Q.VIEW	Tunes to the last channel viewed.
VOLUME UP/DOWN	Adjusts the volume.
FAV	Set up desired favorite channels list ▶p.69
3D	Used for viewing the 3D video. ▶p.87
CHAR/NUM	Shifts the Character or Number for internet service.
DELETE	Deletes the character or number on the screen.
MUTE	Switches the sound on or off. ▶p.56
CHANNEL UP/DOWN	Changes the channel.
PAGE UP/DOWN	Moves from one full set of screen information to the next one.
MENU	Displays the main menu or clears all on-screen displays and return to TV viewing.
NETCAST	Select the desired NETCAST menu source.
Q.MENU	Opens the list of Quick Menu options. ▶p.61
THUMBSTICK (Up/Down/Left Right/ENTER)	Navigates the on-screen menus and adjusts the system settings to your preference.
BACK	Allows the user to move return one step in an interactive application or other user interaction function.
EXIT	Clears all on-screen displays and return to TV viewing.
GUIDE	Show Channel schedule.

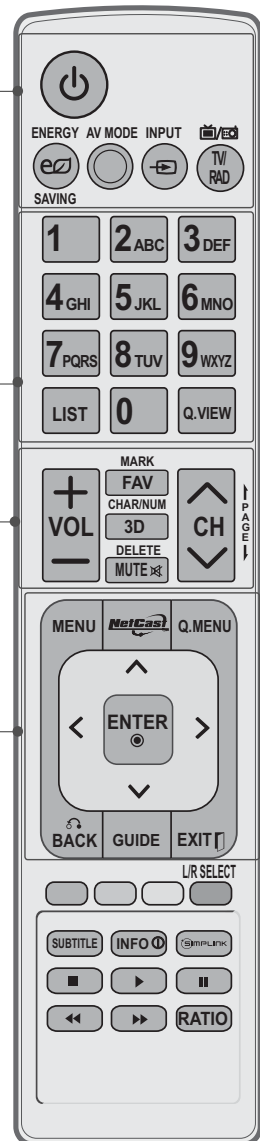

COLOR BUTTON	Access special functions in some menus.
USB, SEMPLINK Control buttons	<ul style="list-style-type: none"> •Controls MY MEDIA menu (Photo List, Music List, Movie List) •Controls the SIMPLINK compatible devices.
SUBTITLE	Recalls your preferred subtitle in digital mode.
INFO	Displays programe information at the bottom of the screen.
RATIO	Changes the aspect ratio.
SIMPLINK	See a list of AV devices connected to TV. When you toggle this button, the SIMPLINK menu appears at the screen. ▶ p.75
L/R SELECT	Used for viewing the 3D video. ▶ p.89

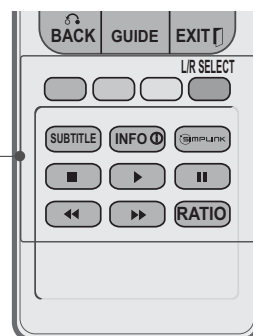

Simple Remote Control (For 50/60PK950R)

POWER	Turns the TV on from standby or off to standby.
TV/INPUT	Rotates through inputs. Also switches the TV on from standby.
VOLUME UP/DOWN	Adjusts the volume.
MUTE	Switches the sound on or off.
CHANNEL UP/DOWN	Changes the channel.
NUMBER button	
Q.VIEW	Tunes to the last channel viewed.



Installing Batteries



- Open the battery compartment cover on the back side and install the batteries matching correct polarity.
- Install two 1.5V AAA batteries. Don't mix old or used batteries with new ones.
- Close cover.

WATCHING TV / CHANNEL CONTROL

TURNING ON THE TV

- 1 First, connect power cord correctly.
At this moment, the TV switches to standby mode.
 - In standby mode to turn TV on, press the  / I, **INPUT, CH (▲ or ▼)** button on the TV or press the **POWER, INPUT, CH (▲ or ▼), Number (0-9)** button on the remote control.
- 2 Select the viewing source by using the **INPUT** button on the remote control.
- 3 When finished using the TV, press the **POWER** button on the remote control. The TV reverts to standby mode.

NOTE

- ▶ If you intend to be away on vacation, disconnect the power plug from the wall power outlet.
- ▶ If you do not complete the **Initial setting**, it will appear whenever the TV is switched on until the **Initial setting** procedure is completed.

CHANNEL SELECTION

- 1 Press the **CH (▲ or ▼)** or **NUMBER** buttons to select a channel number.

VOLUME ADJUSTMENT

Adjust the volume to suit your personal preference.

- 1 Press the **VOL (+ or -)** button to adjust the volume.
- 2 If you want to switch the sound off, press the **MUTE** button.
- 3 You can cancel the Mute function by pressing the **MUTE** or **VOL (+ or -)** button.

INITIAL SETTING

This Function guides the user to easily set the essential items for viewing the TV for the first time when purchasing the TV. It will be displayed on the screen when turning the TV on for the first time. It can also be activated from the user menus.

- Default selection is "**Home Use**". We recommend setting the TV to "**Home Use**" mode for the best picture in your home environment.
- "**Store Demo**" Mode is only intended for use in retail environments. Customers can adjust the "**Picture menu - Picture mode**" manually while inspecting the TV, but the TV will automatically return to preset in-store mode after 5 minutes.
- "**Store Demo**" Mode is an optimal setting for displaying at stores. "Store Demo" mode initializes the TV to set the image quality:

Step1. Selecting Language

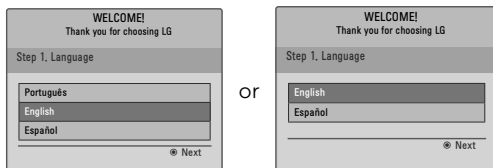

1 Select Menu Language.



Step2. Mode setting

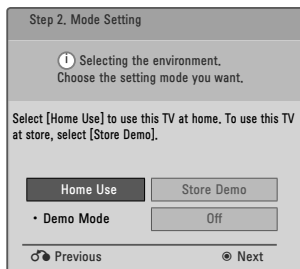

1 Select **Home Use**.



Step3. Power Indicator (For LED LCD TV)

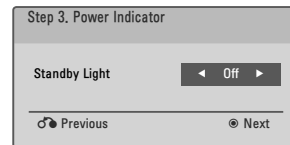

1 Select **On** or **Off**.



- This function is disable in "Step2. Mode Setting - Store Demo".

Step4. Auto Tuning

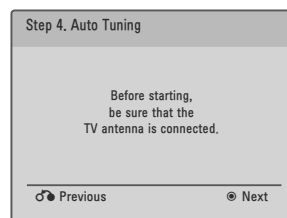

1 Check your antenna connection and start **Auto Tuning**.

WATCHING TV / CHANNEL CONTROL

ON-SCREEN MENU SELECTION

Your TV's OSD (On Screen Display) may differ slightly from that shown in this manual.

1   Display each menu.

2   Select a menu item.

3  Accept the current selection.

4  Return to TV viewing.

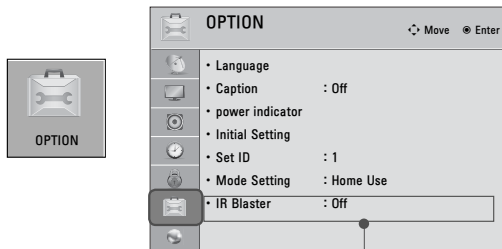
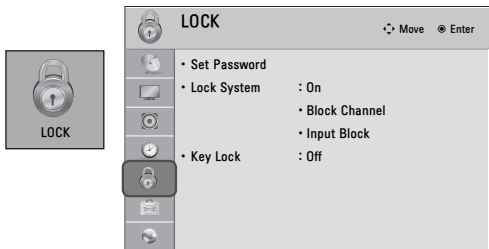
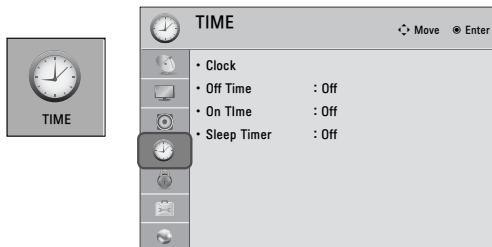
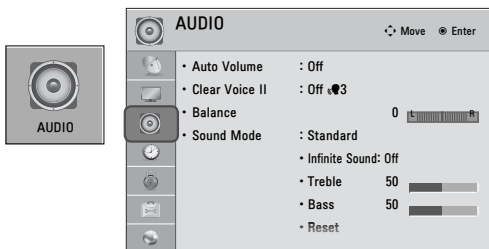

■ For further information, refer to the optional **"Wireless Media Box"** manual for operating instructions.

NOTE

- ▶ **ISM Method:** For **Plasma TV**.
- ▶ **Backlight, TruMotion, LED Local Dimming, Power Indicator:** For **LED LCD TV/LCD TV**.

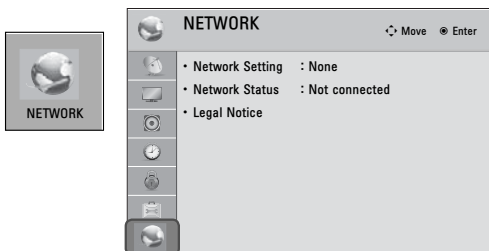
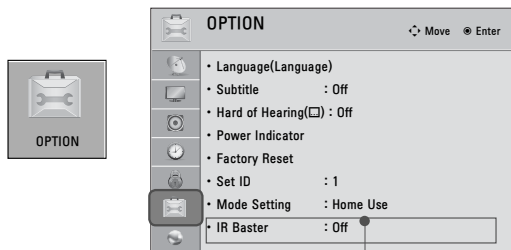
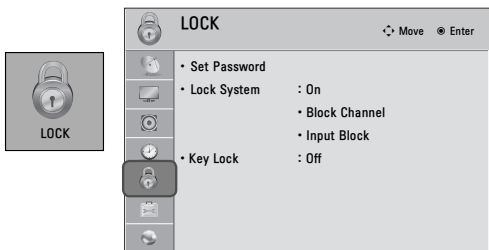
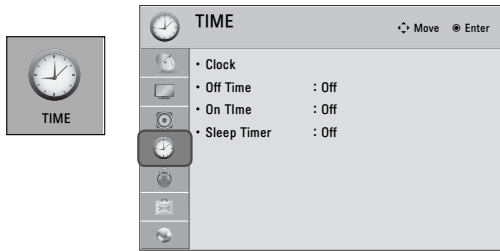
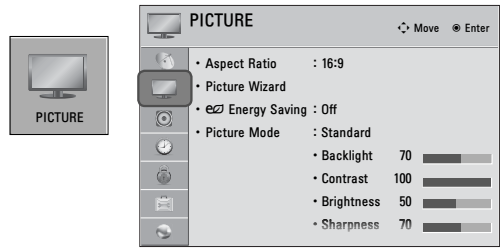

■ For further information, refer to the optional **"Wireless Media Box"** manual for operating instructions.

WATCHING TV / CHANNEL CONTROL

WATCHING TV / CHANNEL CONTROL

i.e)

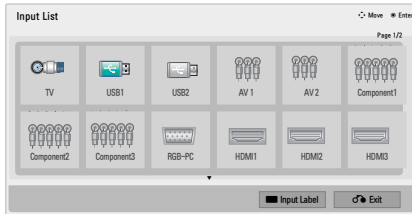
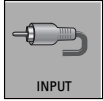

OR

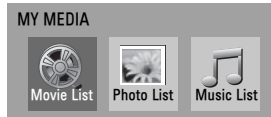
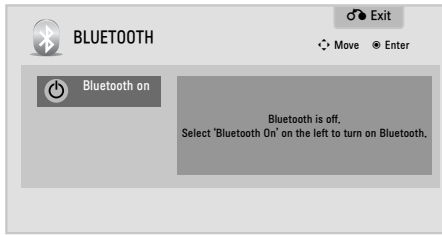







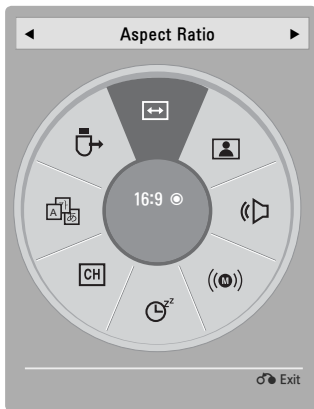

QUICK MENU

Your TV's OSD (On Screen Display) may differ slightly from what is shown in this manual.



Q.Menu (Quick Menu) is a menu of features which users might use frequently.



For 32/42/47/55LE5500-DA, 42/47LE8500-DA,
32/42/47/55LD650-DA, 42/47LX6500-DD

-  **Aspect Ratio:** Selects your desired picture format.
-  **Clear Voice II:** By differentiating the human sound range from others, it helps users listen to human voices better.
-  **Picture Mode:** Selects the desired preset picture setting.
-  **Sound Mode:** Selects the desired preset sound setting.
-  **SAP:** Selects MTS sound.
- (Audio Language:** For 32/42/47/55LE5500-DA, 42/47LE8500-DA, 32/42/47/55LD650-DA, 42/47LX6500-DD)
-  **Sleep Timer:** Select the amount of time before your TV turns off automatically.
-  **Del/Add:** Select channel you want to add or delete.
-  **Caption:** Select on or off.
-  **USB Device:** Select "Eject" in order to eject a USB device.

1   Display each menu.

2   Make appropriate adjustments.

3  Return to TV viewing.

CUSTOMER SUPPORT





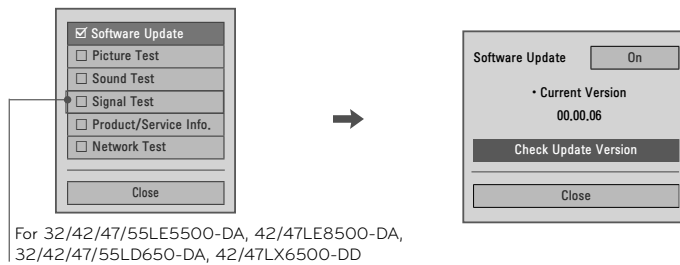

Software Update

You can update the TV with the latest software to enhance the product operation and/or add new features.

You can update the software by connecting the TV directly to the software update server.

The Software Update function may not work properly depending on your internet environment. In this case, you can obtain the latest software from the authorized LG Electronics Service Center then update your TV.



- 1   Select **Customer Support**.
- 2   Select **Software Update**.
- 3   Select **Check Update Version** to check the newest version.

When selecting "**Software Update-On**"

- If the TV is connected to the internet and it finds a software update on the LG server, the update popup menu will appear automatically.
- If the updated digital software information is transmitted, the update popup menu will appear automatically.

- The software downloading time will vary depending on the software size and network conditions.
- During the software update procedure, do not turn off the TV or disconnect AC power, or disconnect the LAN cable.
- After software update, you can confirm the update software version at software Update menu.
- When update is completed, the TV will restart automatically in 5 seconds.
- The TV functions may be improved or changed by software update.
- The available time or functionality of NetCast menu may depend on your ISP network conditions.
- When an update is completed, some CHANNEL, PICTURE, and AUDIO menu settings may need resetting.
- This TV cannot be updated to previous software version.
- Use the "Check Update Version" button to update the latest software on the Network server manually.
- When there is a new software update when you open NetCast, you will not be able to use NetCast without updating the software.
- You cannot open NetCast while the software is being updated.

Picture Test / Sound Test

This function is a customer support function that can execute picture and sound tests.

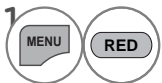
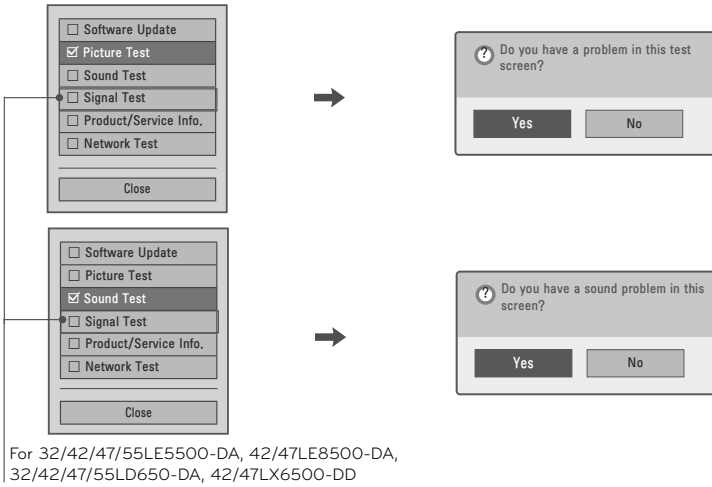

Select **Customer Support**.



Return to the previous menu.

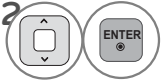

Select **Picture Test** or **Sound Test**.



Return to TV viewing.



Select **Yes**.

Diagnostics

(For 32/42/47/55LE5500-DA, 42/47LE8500-DA, 32/42/47/55LD650-DA, 42/47LX6500-DD)

This function enables you to view information on the Manufacturer, Model/Type, Serial Number and Software Version.

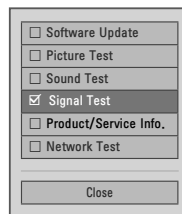

Select **Customer Support** menu.



Display Manufacturer, Model/Type, Serial Number and Software Version.



Select **Signal Test**.





Return to the previous menu.

WATCHING TV / CHANNEL CONTROL

Product/Service Info.

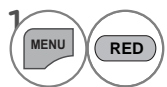
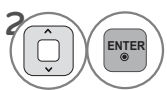

This function shows support and product information.
Customer Service Center can differ by country.

-  Select **Customer Support**.
-  Select **Product/Service Info..**
You can check the various product/Service information based on your model.
-  Return to the previous menu.
-  Return to TV viewing.

Network Test

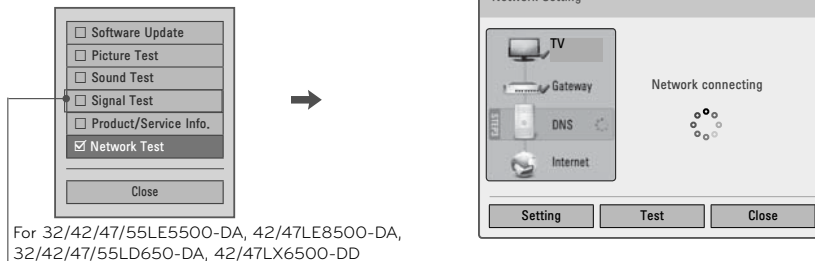

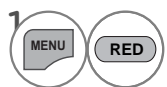
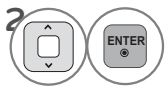

Check the network status.

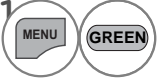

-  Select **Customer Support**.
-  Select **Network Test**.
-  Check the network status.

SIMPLE MANUAL

You can easily and effectively access the TV information by viewing a simple manual on the TV. During the Simple Manual operation, audio will be muted.

-  Select **Simple Manual**.
-  Select the part of the manual you want to see.
-  Go to the **Index** page.
-  Play the **Simple Manual** automatically or manually.
-  Return to TV viewing.

WATCHING TV / CHANNEL CONTROL

CHANNEL SETUP







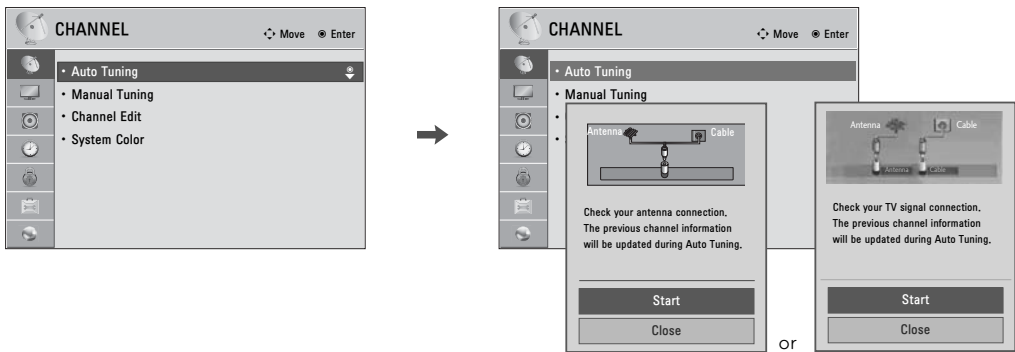

Auto Scan (Auto Tuning)

Automatically finds all channels available through antenna or cable inputs, and stores them in memory on the channel list.

Run this function if you change your residence or move the TV.

Auto Tuning memorizes only the channels available at the time.



-   Select **CHANNEL** or **SETUP**.
-   Select **Auto Tuning**.
-   Select **Start**.
-  Run **Auto tuning**.
-  Return to the previous menu.
-  Return to TV viewing.

■ The TV will ask for a password if parental control has been activated (LOCK Menu). Use the password you set up in the LOCK Menu to allow a channel search.

Add/Delete Channel (Manual Tuning)

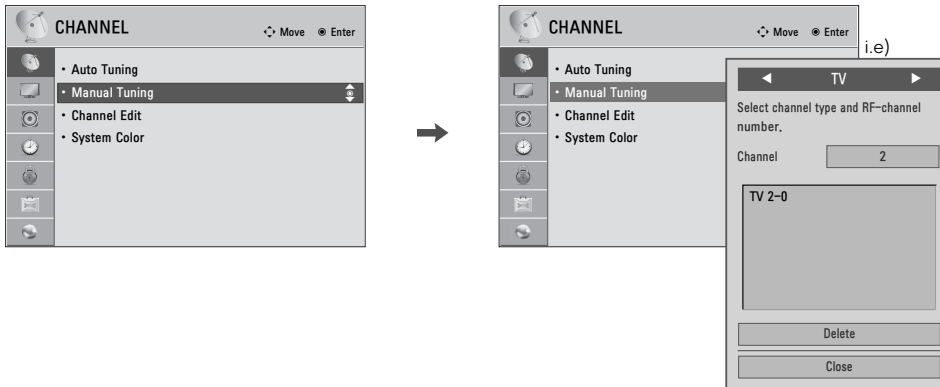

- 1   Select **CHANNEL** or **SETUP**.
- 2   Select **Manual Tuning**.
- 3   Select **TV**, or **Cable TV**. (DTV : Select **DTV**, **TV**, or **Cable TV**.)
- 4   Select channel you want to add or delete.
- 5   Select **Add** or **Delete**. (DTV : Select **Add**, **Update** or **Cancel**.)
- 6  Return to the previous menu.
-  Return to TV viewing.

- The TV will ask for a password if parental control has been activated (LOCK Menu). Use the password you set up in the LOCK Menu to allow a channel search.

WATCHING TV / CHANNEL CONTROL

Channel Editing

The channels in the Channel Edit List are displayed in black and the channels deleted from the Channel Edit List are displayed in blue.



When a channel number is deleted, it means that you will be unable to select it using **CH/V** button during TV viewing.

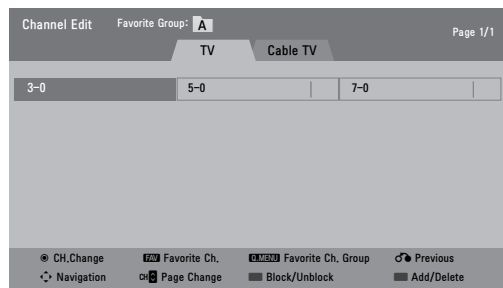
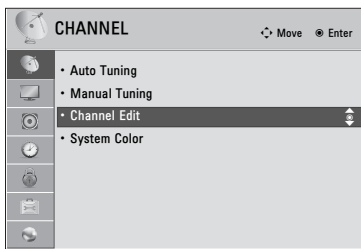



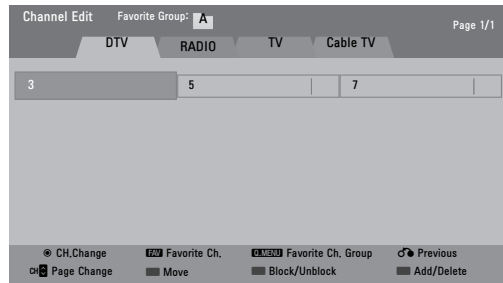

If you wish to select the deleted channel, directly enter the channel number with the **NUMBER** buttons or select it in the Channel Edit menu.



or



- 1   Select **CHANNEL** or **SETUP**.
- 2   Select **Channel Edit**.
- 3   Select a channel.

- 4  Add or delete a channel.
 Block or unblock the channel.
You can register as block/unblock channel even though you select "Lock system-Off" in the LOCK menu.
-  Switch to the chosen channel number.
-  Move the pages when the channel list is too long.
- 5  Return to the previous menu.
-  Return to TV viewing.





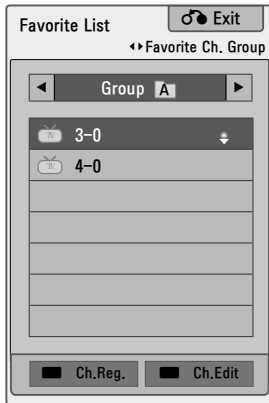

■ Keep pressing the **▲** button and use the **<** or **>** buttons to move between TV and Cable TV.

FAVORITE CHANNEL SETUP

Favorite Channels are a convenient feature that lets you quickly select channels of your choice without waiting for the TV to select all the in-between channels.

i.e)



- 1  or  Select your desired channel.
- 2   Select your desired favorite channel group from A to D.
- 3  Register or cancel the current channel in favorite channel list.
-  Go to the "CHANNEL or SETUP menu - Channel Edit".
- 4  Return to TV viewing.

■ You can also setup **Favorite List** in the **CHANNEL** menu - **Channel Edit**.

FAVORITE CHANNEL LIST



i.e)





Displaying the favorite channel list

- 1  Display the Favorite channel list.

Selecting a channel in the favorite channel list

- 1  Select a channel.
- 2  Switch to the chosen channel number.

Paging through a favorite channel list

- 1  Turn the pages.
- 2  Return to TV viewing.

WATCHING TV / CHANNEL CONTROL

CHANNEL LIST

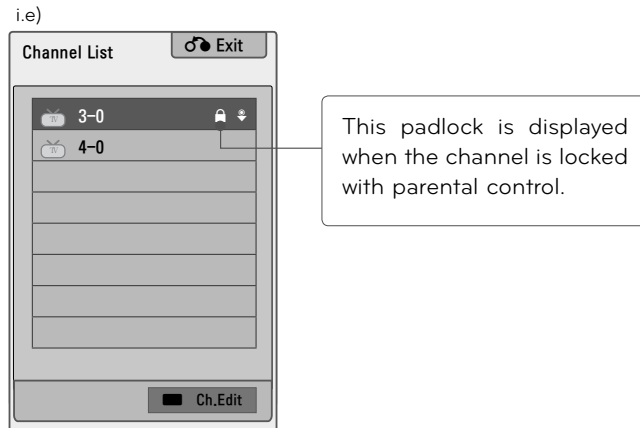

You can check which channels are stored in the memory by displaying the channel list.





Displaying Channel List

- 1  Display the **Channel List**.
- 2  Tune to the "**CHANNEL** or **SETUP** menu - **Channel Edit**".

Selecting a channel in the channel list

- 1  Select a channel.
- 2  Switch to the chosen channel number.

Paging through a channel list

- 1  Turn the pages.
- 2  Return to TV viewing.

INPUT LIST

Only these input signals which are connected to a TV can be activated and selected.

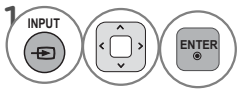

Select the desired input source.

- You can also select the desired input source in the **INPUT** menu.

- When new external device is connected, this popup menu is displayed automatically. If selecting **Yes**, you can select input source that you want to appreciate.
- But, when selecting "**SIMPLINK - On**", popup menu for HDMI input will not be displayed.

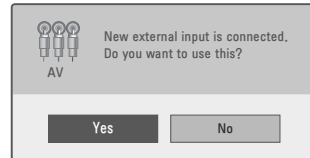

- **TV**: Select it to watch over-the-air and cable.
- **USB**: Select it to use movie, photo, or music files.
- **AV**: Select them to watch a VCR or other external equipment.
- **Component**: Select them to watch DVD or a Digital set-top box.
- **RGB-PC**: Select it to view PC input.
- **HDMI**: Select them to watch high definition devices.

INPUT LABEL

This indicates which device is connected to which input port.

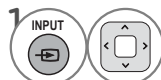
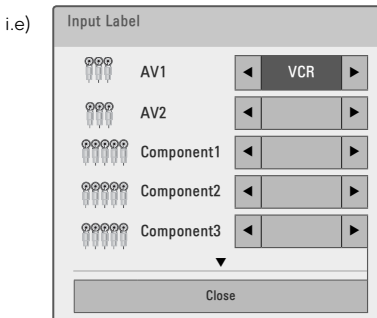

Select the desired input source.



Select the label.



Return to the previous menu.



Return to TV viewing.

WATCHING TV / CHANNEL CONTROL

MODE SETTING

Default selection is "Home Use". We recommend setting the TV to "Home Use" mode for the best picture in your home environment.

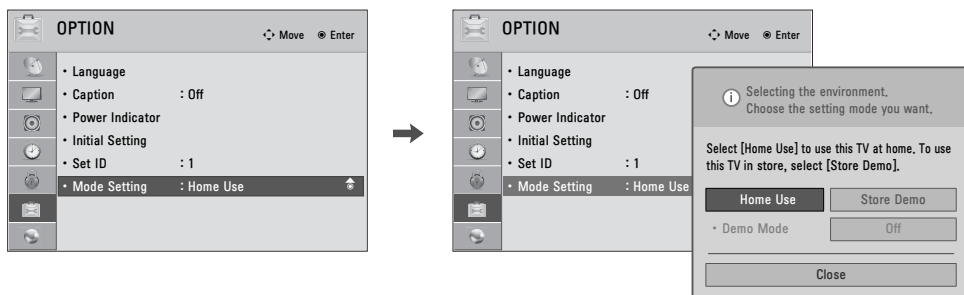

- 1 Select **OPTION**.
 - 2 Select **Mode Setting**.
 - 3 Select **Home Use**.
 - 4 Return to the previous menu.
- Return to TV viewing.

- "Store Demo" Mode is only intended for use in retail environments. Customers can adjust the "Picture menu - Picture mode" manually while inspecting the TV, but the TV will automatically return to preset in-store mode after 5 minutes.
- "Store Demo" Mode is an optimal setting for displaying at stores. "Store Demo" mode initializes the TV to set the image quality:

DEMO MODE

Displays a slide show to explain the various feature of this TV.

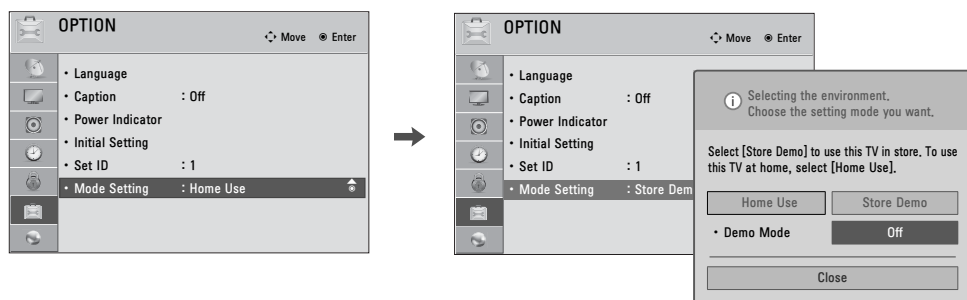

- 1 Select **OPTION**.
- 2 Select **Mode Setting**.
- 3 Select **Store Demo**.

- 4 Select **On**.
- 5 Return to TV viewing.
After a while, **Demo Mode** starts.
If you want to stop the demo, press any button (Except VOL +, - and MUTE button).

RESET TO FACTORY DEFAULT (INITIAL SETTING)

This function resets the TV to factory default and erases all stored channels.

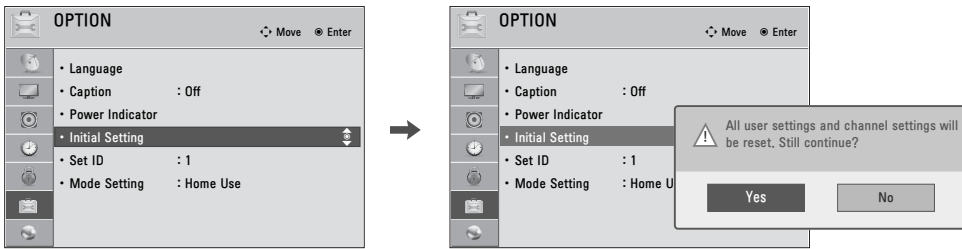

- 1 Select **OPTION**.
- 2 Select **Initial Setting** or **Factory Reset**.
- 3 Select **Yes**.
- 4 TV turns off automatically and start factory reset.

- When selecting "Lock System - On" in the LOCK menu, the message to enter the password appears.
- If you forget your password, press "0-3-2-5" on the remote control.

SYSTEM COLOR (Except 32/42/47/55LE5500-DA, 42/47LE8500-DA, 32/42/47/55LD650-DA, 42/47LX6500-DD)

This function set color suited the each signal.

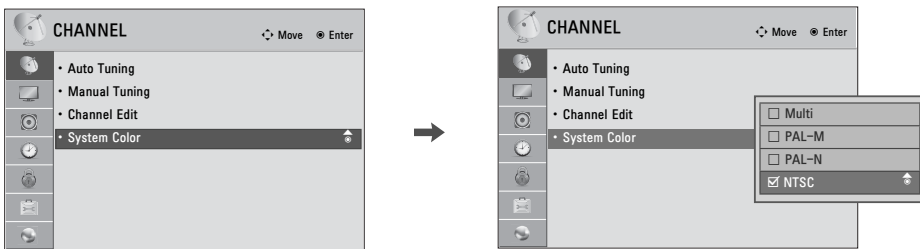

- 1 Select **CHANNEL**.
- 2 Select **System Color**.
- 3 Select **Multi**, **PAL-M**, **PAL-N**, or **NTSC**.
- 4 Return to the previous menu.
- Return to TV viewing.

WATCHING TV / CHANNEL CONTROL

AV MODE

AV Mode toggles through preset Video and Audio settings.

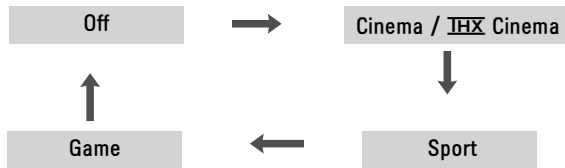

- If you select "**Cinema / THX Cinema**" in AV mode, **Cinema / THX Cinema** will be selected both for "PICTURE menu - Picture Mode" and "AUDIO menu - Sound Mode" respectively.
- If you select "**Off**" in AV mode, the "**Picture Mode**" and "**Sound Mode**" return to previous selected value.
- **Off**: Disables the AV MODE.
- **Cinema / THX Cinema**: Optimizes video and audio for watching movies.
- **Sport**: Optimizes video and audio for watching sports events.
- **Game**: Optimizes video and audio for playing games.
- When playing a video game using PlayStation or Xbox, it is recommended to use the **Game** mode.
- When in **Game** mode, functions related to picture quality will be optimized for playing games.

1  Press the **AV MODE** button repeatedly to select the desired source.





GAME

Allows you to enjoy the various games.



1   Select **GAME**.

2   Select the desired game.

3  Enter the selected game mode.

4  Return to TV viewing.

SIMPLINK

SIMPLINK allows you to control and play other AV devices connected with HDMI cable without additional cables and settings. This TV may work with devices with HDMI-CEC support, but only devices with the SIMPLINK logo are fully supported.

SIMPLINK can be turned on and off in the user menus.



- 1 Display **SIMPLINK** menu.
- 2 Select **On**.
- 3 Select the desired device.
- 4 Control connected AV devices.

- 1 **TV viewing:** Switch to the previous TV channel regardless of the current mode.
- 2 **DISC playback:** Select and play discs. When multiple discs are available, the device type of discs are conveniently displayed at the bottom of the screen.
- 3 **VCR playback:** Control the connected VCR.
- 4 **HDD Recordings playback:** Control recordings stored in HDD.
- 5 **Audio Out to Home Theater speaker/ Audio Out to TV:** Select Home Theater speaker or TV speaker for Audio Out.

- ▶ When no device is connected (displayed in gray)
- ▶ Selected Device
- ▶ When a device is connected (display checked)

SIMPLINK Functions

- **Direct Play:** After connecting AV devices to the TV, you can directly control the devices and play media without additional settings.
 - **Select AV device:** Enables you to select one of the AV devices connected to the TV.
 - **Disc playback:** Control connected AV devices by pressing the **^** **v** **<** **>**, **ENTER**, **▶**, **■**, **||**, **◀** and **▶▶** buttons.
 - **Power off all devices:** When you power off the TV, all connected devices are turned off.
 - **Switch audio-out:** Offers an easy way to switch audio-out.
 - **Sync Power on:** When the equipment with Simplink function connected HDMI terminal starts to play, The TV will automatically turn on.
- Note: To operate SIMPLINK, an High Speed HDMI cable *CEC function should be used. (*CEC: Consumer Electronics Control).
(A device, which is connected to the TV through a HDMI cable but does not support SIMPLINK, does not provide this function)

NOTE

- ▶ Connect the HDMI/DVI IN or HDMI IN terminal of the TV to the rear terminal (HDMI terminal) of the SIMPLINK device with the HDMI cable
- ▶ When you switch the Input source with the INPUT button on the remote control, the SIMPLINK device will stop.
- ▶ When you select a device with home theater functionality, the sound output automatically switches to the home theater speakers and the TV speakers are turned off.
- ▶ If a connected SIMPLINK home theater system doesn't play the audio from the TV, connect the DIGITAL AUDIO OUT terminal on the back of the TV to the DIGITAL AUDIO IN terminal on the back of the SIMPLINK device with an OPTICAL cable.

WATCHING TV / CHANNEL CONTROL

EPG (ELECTRONIC PROGRAMME GUIDE) (IN DIGITAL MODE) (For 32/42/47/55LE5500-DA, 42/47LE8500-DA, 32/42/47/55LD650-DA, 42/47LX6500-DD)

This system has an Electronic Programme Guide (EPG) to help your navigation through all the possible viewing options.

The EPG supplies information such as programme listings, start and end times for all available services. In addition, detailed information about the programme is often available in the EPG (the availability and amount of these programme details will vary, depending on the particular broadcaster).

This function can be used only when the EPG information is broadcast by broadcasting companies.

The EPG displays the programme details for next 8 days.

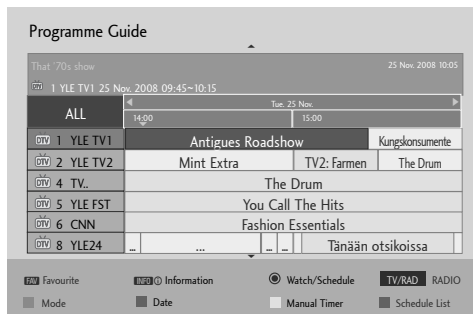

Display the **Programme Guide**.



Select the desired programme.

NOW/NEXT Guide Mode

You can view a programme being broadcasted and one scheduled to follow.



Change EPG mode.



Enter Manual Timer mode.



Enter Schedule List mode.



When 'Now' is selected, it is moved to selected programme and EPG disappears

When 'Next' is selected, a reservation pop-up window appears.



Select NOW or NEXT Programme.



Select the Broadcast Programme.



Page Up/Down.

Programme Guide

That '70s show 25 Nov. 2008 10:05







1 YLE TV1 25 Nov. 2008 09:45#10:15

ALL	NOW	NEXT
1 YLE TV1	That '70s show	Keno
2 YLE TV2	Your World Today	World Business
4 TV.	Legenen om Den....	Fantomen
5 YLE FST	Naturtimmen	Kritiskt
6 CNN	Lyssna	ABC
8 YLE24	Glamour	Tänään otsikoissa

Favourite Information Watch/Schedule TV/RAD RADIO
Mode Manual Timer Schedule List



WATCHING TV / CHANNEL CONTROL

8 Day Guide Mode

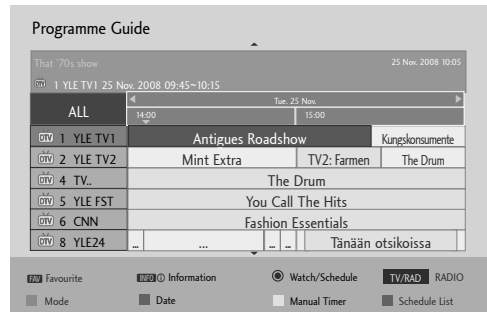
-  Change EPG mode.
-  Enter Date setting mode.
-  Enter Manual Timer mode.
-  Enter Schedule List mode.
- When 'Currently broadcasting programme' is selected, it is moved to selected programme and EPG disappears. When 'Future broadcasting programme' is selected, a reservation pop-up window appears.
-  Select Programme.
-  Select the Broadcast Programme.



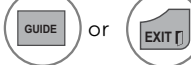

Date Change Mode

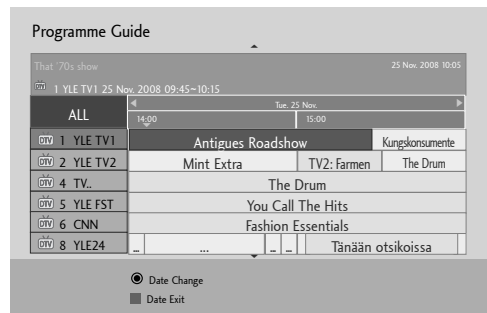
-  Switch off Date setting mode.
-  Change to the selected date.
-  Select a date.
-  Switch off EPG.





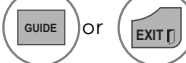

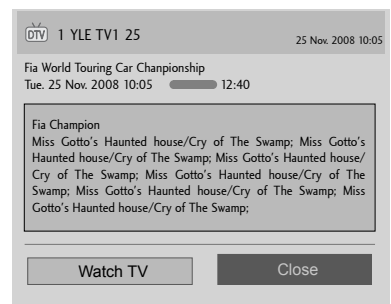
Detailed Information Box

-  Detail information on or off.
-  Text Up/Down.
-  Select Watch TV or Close.
-  Switch off EPG.



Remind Setting Mode



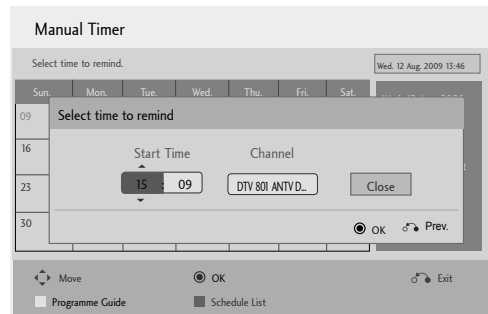

sets a start time on the channel for the reminder.

-  Change to Manual Timer mode.
-  Select your desired Option.
-  Select Remind function setting.
-  Select Start Time or Channel.
-  Save Timer Remind.
-  Switch off **EPG**.



Schedule List Mode

If you've created a schedule list, a scheduled programme is displayed at the scheduled time even when you are watching a different programme at the time.

-  Change to Guide mode.
-  Select your desired Option (Modify/Delete/Delete All).
-  Select **Schedule List**.
-  Page Up/Down.
-  Switch off **EPG**.

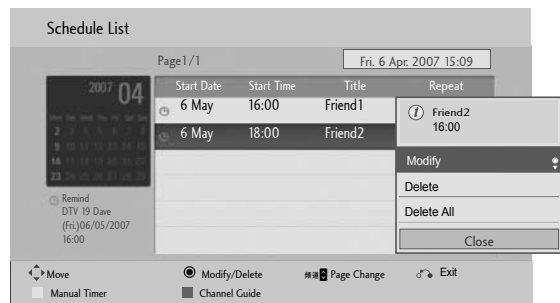

BLUETOOTH

(FOR 32/42/47/55LE5500, 32/42/47/55LE7500, 50/60PK950R,
42/47LE8500, 42/47LX6500)

BLUETOOTH?

Bluetooth is a short distance networking technology using 2.4 GHz frequency to connect various types of information devices such as computers, cell phones and PDAs, as well as digital appliances through wireless connection, without having to connect any cable, to enable data exchange.

With the Bluetooth communication function, you can connect the Bluetooth enabled wireless headset or receive images(only JPEG), listen to music from the Bluetooth enabled cell phone using this TV.

- Communication Spec.: Bluetooth Specification Version 2.0 + EDR (Enhanced Data Rate)
- Output: Bluetooth Specification Power Class 2
- Maximum Communication Range: Line of open sight approx. 10 m (30 ft)
- Frequency Band: 2.4 GHz band (2.4 GHz to 2.4835 GHz)
- Bluetooth Module: RBFS-B721A(LG Electronics)
- Compatible Bluetooth Profile : GAVDP(Generic Audio/Video Distribution Profile), A2DP(Advanced Audio Distribution Profile), OPP(Object Push Profile), BIP(Basic Imaging Profile), FTP(File Transfer Profile)

Precautions when using the Bluetooth





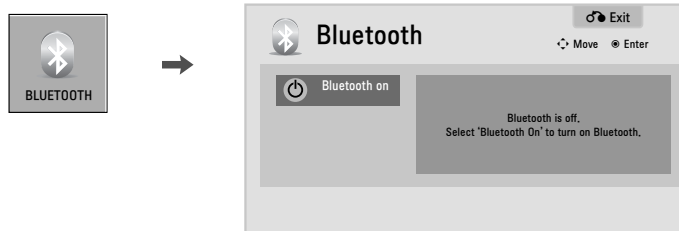

- ▶ Use within 7 m (-45° - 45°) range. If you use the device out of the range or within the range with obstacles, it can result in communication error.
- ▶ Communication error can occur depending on the surrounding devices.
- ▶ Products using the same frequency of 2.4 GHz (Wireless LAN, microwave oven etc.), can cause communication error by using the same frequency bandwidth.
- ▶ The device search time differs depending on the number of Bluetooth devices and the operating situation.
- ▶ The probability of search increases with less number of devices.
- ▶ Electromagnetic wave can be interfered with applicable wireless devices.
- ▶ Because applicable wireless devices have the possibility of electromagnetic wave interference, they cannot provide services related to human life.
- ▶ You can only connect one Bluetooth device at a time.
- ▶ You cannot receive photos(only JPEG) or listen to music from other Bluetooth devices while using the Bluetooth headset.
- ▶ For details of Bluetooth, refer to the user manual of the Bluetooth device.
- ▶ Operation is subject to the following two conditions : (1) This device may not cause harmful interference, and (2) this device must accept any interference received, including interference that may cause undesired operation of the device.
- ▶ Bluetooth can be used about 30 seconds after the power is turned on.
- ▶ Depending on the transmission processing method and performance of the headset used, the audio can be instantly disconnected.

QDID(Qualified Design Identity): B015199

SETTING THE BLUETOOTH

If you want to listen to the broadcasted sound using the Bluetooth headset or receive the jpeg images from an external device and view them on the TV, listen to music from cell phone(Bluetooth device), you can use the wireless communication without having to connect any cables.



- 1    Select **BLUETOOTH**.
- 2  Start **Bluetooth On**.
- 3  Return to the previous menu.
-  Return to TV viewing.

- You can use the BLUETOOTH menu by selecting "**Bluetooth on**".
If you do not want to use the Bluetooth function, select "**Bluetooth off**".
- If it is connected to the external Bluetooth device, you can select "**Bluetooth off**" after disconnecting the device.

BLUETOOTH

CONNECTING THE BLUETOOTH HEADSET

When you select the Bluetooth headset, you can listen to the TV audio in the Bluetooth headset through wireless communication.

You must pair it with any new Bluetooth device before the first use. For details, refer to the user manual of the applicable device.

A maximum of 12 devices can be paired.

When the unit is searching for the Bluetooth headset, other buttons except for the "Stop" (ENTER button) do not work.









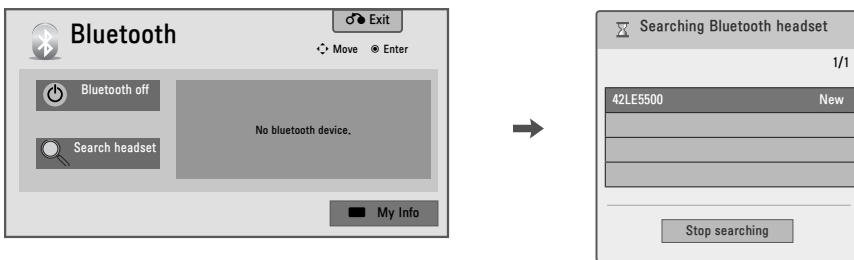

Connecting a new Bluetooth headset

You can only search for the new Bluetooth headset only in the Disconnected condition.

When you run the search, it will show you the list of all Bluetooth headsets responding.

After new Bluetooth device is searched, the PIN number is validated to connect the device. For details, refer to the user manual of the applicable device.



-    Select **BLUETOOTH**.
-   Select **Search headset**.
-   Select the desired Bluetooth headset.
-  Select the desired Bluetooth headset PIN number. Refer to the user manual of the applicable device for the PIN number.
-  Connect the Bluetooth headset.
-  Return to the previous menu.
-  Return to TV viewing.

Connecting to Bluetooth headset already registered

Bluetooth headsets are listed in the order most recently used with the headset currently in use listed at the top. When connecting the Bluetooth device already registered, you can select and connect directly without any PIN validation.

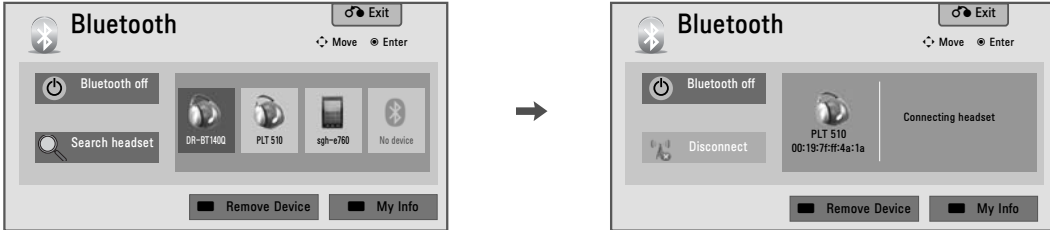

- 1 Select **BLUETOOTH**.
- 2 Select the Bluetooth headset.
- 3 Connect the Bluetooth headset.
- 4 Return to the previous menu.
- Return to TV viewing.

- After connecting/using the Bluetooth headset, the headset setting will be the **Disconnected** condition automatically when you turn off the power of the TV and then turn on.
- After connecting the Bluetooth headset, the TV speaker is switched to Mute condition and the sound will only be generated from the headset.

Disconnecting the Bluetooth headset during use

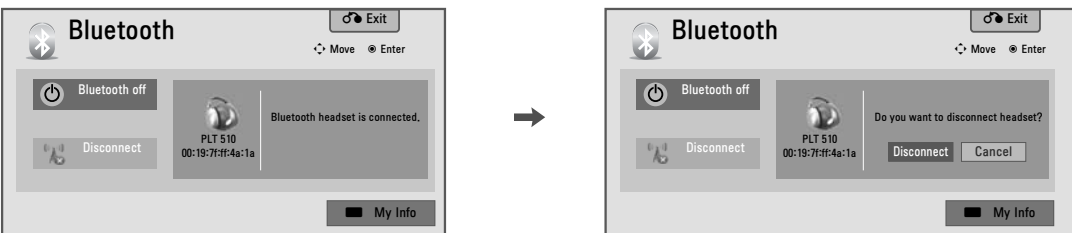

- 1 Select **BLUETOOTH**.
- 2 Select **Disconnect**.
- 3 Select **Disconnect**.
- 4 Disconnect the Bluetooth headset.
- 5 Return to the previous menu.
- Return to TV viewing.

BLUETOOTH

When requesting to connect to TV from the Bluetooth headset

When the Bluetooth menu is "On" and there is a connection request from the headset, this message is displayed.

Not all headsets support this feature. (Refer to the user manual of the applicable Bluetooth headset.)

Some headset types may make an attempt at connection when they are turned off/on even though they are not included in the Registered Device list.

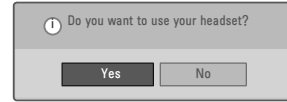

NOTE

- ▶ LG recommends the following headset models. : Plantronics VOYAGER-855 / SONY HBH-DS970, HBH-DS980 / Motorola S605
There might be an audio delay, depending on the buffer memory size of the headset.
- ▶ The stereo headsets officially certified to be Bluetooth compatible can be searched and connected.
- ▶ The stereo headsets that support A2DP functionality can be connected.
- ▶ If the surrounding environment of the TV is as follows, the device may not be searched or connected properly.
 - If there is strong electromagnetic interference.
 - If there are many Bluetooth devices.
 - If the headset is turned off, not in place or has an error.
 - Because products such as microwave oven, wireless LAN, plasma light, gas range etc., use the same frequency range, it can cause communication errors.
- ▶ Only one Bluetooth device can be connected at a time.
- ▶ Connection that is lost due to the TV being turned off etc. will not be automatically recovered. Try connecting the applicable device again.
- ▶ Some operations can be slower while operating the headset.
- ▶ Even if you choose simplink Home Theater after using the headset during Simplink operation, the unit will not automatically switch to Home Theater speakers.
- ▶ When the headset connection continuously fails, pair the device one more time.
- ▶ When a Bluetooth headset is in use, the Volume +/- and Mute keys do not work, and the Audio menu returns to the default value and is disabled.
- ▶ With Bluetooth set to On, if any registered devices are turned on, the TV will switch to Bluetooth mode automatically even though you are watching in another input mode. In this case, set Bluetooth to Off.

REMOVE THE BLUETOOTH DEVICE

When 12 devices are registered, you cannot register any more devices, and the external device will no longer be able to pair up with the TV. In this case, you should delete one (disconnect first if a device is connected to the TV) and then you can register another device.

"Remove device" will be available when selecting the device that is not connected to the TV.

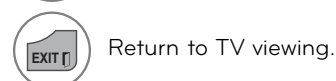
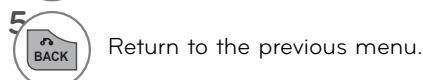
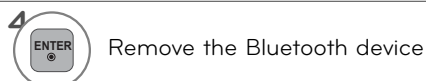
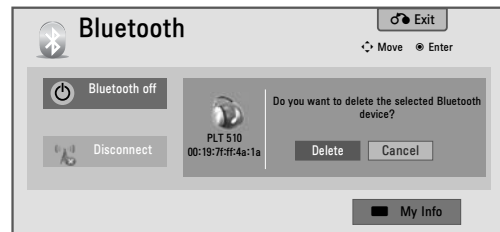

MY BLUETOOTH INFORMATION

This function provides the My Bluetooth Information to the user.

"Edit" will be available when TV is not connected with any device.

You can edit the Setup TV PIN or Setup TV name.

You can check the TV address.

To accept connection from an external Bluetooth device or to connect to an external Bluetooth device, the PIN needs to be entered.

For details on how to set the PIN of the external Bluetooth device, refer to the user manual of the applicable device.

The TV PIN is composed of numbers of up to 16 digits.

The TV PIN must have more than 1 digit.

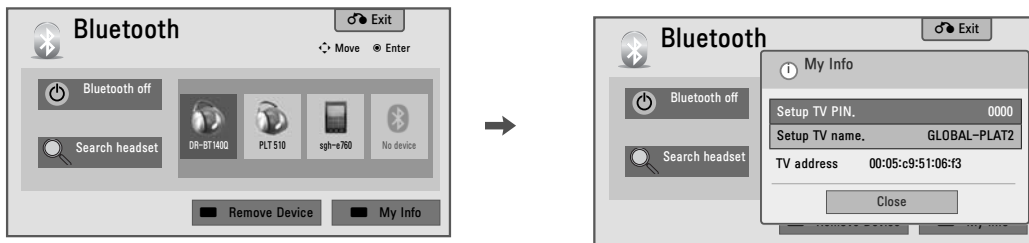

- 1 Select **BLUETOOTH**.
- 2 Select **My Info**.
- 3 Select **Setup TV PIN** or **Setup TV name**.
- 4 You can use an the alphabet A to Z, the number 0 to 9 and blank.
- 5 Save.
- 6 Return to the previous menu.
- Return to TV viewing.

■ Press the < button to delete digits one by one.

BLUETOOTH

VIEWING THE PHOTOS WITH BLUETOOTH DEVICE

You can view the photos(*.JPG) that were received from an external Bluetooth device to the TV.

To see the detailed informations about connecting the external Bluetooth device, refer to the user manual of the applicable device.

The On Screen Display on your model may be slightly different.

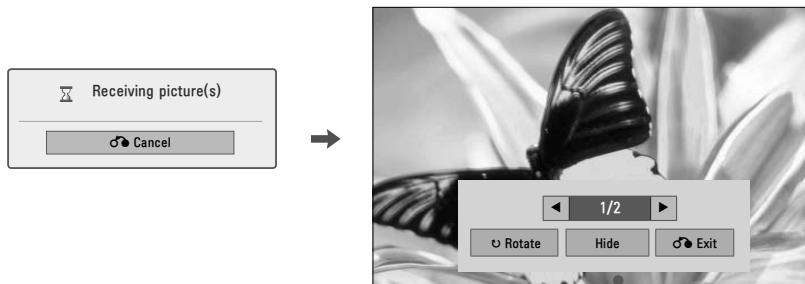

- ▶ **⌂ (Rotate)** : Rotate photos.
 - Every time you press **ENTER** button on **⌂ (Rotate)**, rotates the photo 90° clockwise.
- ▶ **Hide** : Hide the menu on the full-sized screen.
 - To see the menu again on the full-sized screen, press **ENTER** button to display.
- ▶ **Exit** : Move to the previous menu screen.



NOTE

- ▶ Supported maximum photo size is up to 10MB.
- ▶ You cannot receive the photos while using the Bluetooth headset or listening to the musics from Bluetooth device.
- ▶ On receiving the photos, press the **BACK** button to stop. At this time, all photos received will be deleted.
- ▶ Some Bluetooth devices may not support sending the photos.

LISTENING THE MUSICS WITH BLUETOOTH DEVICE

You can listen to the musics (A2DP) that were received from an external Bluetooth device to the TV.

To see the detailed informations about connecting the external Bluetooth device, refer to the user manual of the applicable device.

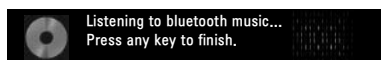

- Press the **VOL +** or **-** button to adjust the volume.
- If you wish to switch the sound off, press the **MUTE** button.
- Press the **BACK** button to return to normal TV viewing.

NOTE

- ▶ You cannot listen to the musics while using the Bluetooth headset or receiving the photos.
- ▶ Some Bluetooth devices may not support listening the music via TV speaker system.
- ▶ With some Bluetooth device, the sound can be slow or discontinued from time to time.

3D IMAGING (FOR 42/47LX6500)

3D TECHNOLOGY

This TV can display in 3D via 3D broadcasting or when the TV is connected to a compatible device, such as a Blu-ray 3D Player. You need such a device to watch the TV in 3D. The 3D TV displays two separate pictures formatted for each eye. The viewer needs to wear 3D glasses in order to see these images in 3D format.

Viewing 3D Imaging

⚠ WARNING

- ▶ When viewing 3D imaging, watch the TV from an effective viewing angle and within the appropriate distance. If you exceed this viewing angle or distance, you may not be able to view the 3D imaging. Furthermore, the 3D imaging may not display if it is viewed while you are lying down.
- ▶ If you watch the 3D imaging too closely or for a long period of time, it may harm your eyesight.
- ▶ Watching the TV or playing video games that incorporate 3D imaging with the 3D glasses for a long period of time can cause drowsiness, headaches or fatigue to you and/or your eyes. If you have a headache, or otherwise feel fatigued or drowsy, stop watching the TV and take a rest.
- ▶ Pregnant woman, seniors, persons with heart problems or persons who experience frequent drowsiness should refrain from watching 3D TV.
- ▶ Some 3D imaging may cause you to duck or dodge the image displayed in the video. Therefore, it is best if you do not watch 3D TV near fragile objects or near any objects that can be knocked over easily.
- ▶ Please prevent children under the age of 5 from watching 3D TV. It may affect their vision development.
- ▶ Warning for photosensitization seizure:
Some viewers may experience a seizure or epilepsy when exposed to certain factors, including flashing lights or images in TV or video games. If you or anybody from your family has a history of epilepsy or seizure, please consult with your doctor before watching 3D TV.

Also certain symptoms can occur in unspecified conditions without any previous history. If you experience any of the following symptoms, immediately stop watching the 3D imaging and consult a doctor: dizziness or lightheadedness, visual transition or altered vision, visual or facial instability, such as eye or muscle twitching, unconscious action, convulsion, loss of conscience, confusion or disorientation, loss of directional sense, cramps, or nausea. Parents should monitor their children, including teenagers, for these symptoms as they may be more sensitive to the effects of watching 3D TV.

Risk of photosensitization seizure can be reduced with the following actions.

- Take frequent breaks from watching 3D TV.
- For those who have vision that is different in each eye, they should watch the TV after taking vision correction measures.
- Watch the TV so that your eyes are on the same level as the 3D screen and refrain from sitting too closely to the TV
- Do not watch the 3D imaging when tired or sick, and avoid watching the 3D imaging for a long period of time.
- Do not wear the 3D glasses for any other purpose than viewing 3D imaging on a 3D TV.
- Some viewers may feel disoriented after watching 3D TV. Therefore, after you watch 3D TV, take a moment to regain awareness of your situation before moving.

ⓘ NOTE

- ▶ To watch the TV in 3D, you must put on your 3D glasses. For best results, you should wear LG Brand 3D glasses. The 3D imaging may not display properly when using another brand of 3D glasses. Please see the 3D glasses manual for instructions on how to use the 3D glasses.
- ▶ After powering on the TV, a few seconds may be needed for your TV to calibrate.
- ▶ It may take a moment for you to see the 3D imaging if you look away from the TV and then revert your eyes back to the 3D program.
- ▶ The TV may flicker slightly if the 3D imaging is

displayed under 3 wavelength lamp fluorescent light (50 Hz - 60 Hz) or magnetic fluorescent lamp (50Hz - 60 Hz). In such instances, it is recommended to turn the lights off.

- ▶ If there is an obstacle between the TV and the 3D glasses, the 3D imaging may not display properly.
- ▶ Do not use the TV in close proximity to other electronic equipments and IR equipments.
- ▶ In Analog TV, 3D Imaging does not work.

3D VIDEO

When using 3D Glasses

! CAUTION

- ▶ 3D glasses are sold separately. Refer to the 3D glasses manual for operating instructions.
- ▶ Do not use the 3D glasses to replace your corrective glasses, sunglasses or protective goggles.
- ▶ Do not store the 3D glasses in hot or cold locations.
- ▶ Do not drop objects onto the 3D glasses. Do not drop or bend the glasses.
- ▶ Since the lenses of the 3D glasses are easily scratched, make sure to clean only with a soft cloth. Shake off any dust before using the cloth since the glasses are easily scratched.

3D Imaging viewing range

TV size, viewing angle & other circumstances may change the viewing distance and the angle of view.

Viewing Distance	2 m - 7 m (6.5 ft - 22.9 ft)
Viewing Angle	120° (When the viewing distance is 2 m (6.5 ft))

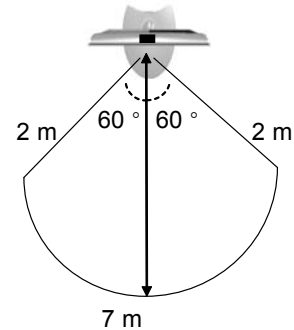

3D VIDEO

WATCHING 3D IMAGING



- 1 Play the video produced in 3D.
Refer to the following for the supported imaging.

	Signal	Resolution	Horizontal Frequency (kHz)	Vertical Frequency (Hz)	Playable 3D video format
HDMI Input	720p	1280x720	45	60	Top & Bottom, Side by Side
			89.9/90	59.94/60	HDMI (V. 1.4 with 3D) Frame Packing
			37.5	50	Top & Bottom, Side by Side
			75		HDMI (V. 1.4 with 3D) Frame Packing
	1080i	1920X1080	33.75	60	Top & Bottom, Side by Side
			28.125	50	
	1080p	1920X1080	67.50	60	Top & Bottom, Side by Side, Checker Board, Single Frame Sequential
			56.250	50	Top & Bottom, Side by Side
			27	24	Top & Bottom, Side by Side, Checker Board
			53.95/54	23.98/24	HDMI (V. 1.4 with 3D) Frame Packing
USB Input	1080p	1920X1080	33.75	30	Top & Bottom, Side by Side, Checker Board
			33.75	30	Top & Bottom, Side by Side, Checker Board, MPO(Photo)
	Signal				Playable 3D video format
DTV	720p, 1080i				Top & Bottom, Side by Side

For 3D video feed that is input in the HDMI (V. 1.4 with 3D) Frame Packing format, it is automatically switched to 3D.

Media contents and a player need to support HDMI (V. 1.4 with 3D) Frame Packing to play Frame Packing format stereoscopic.

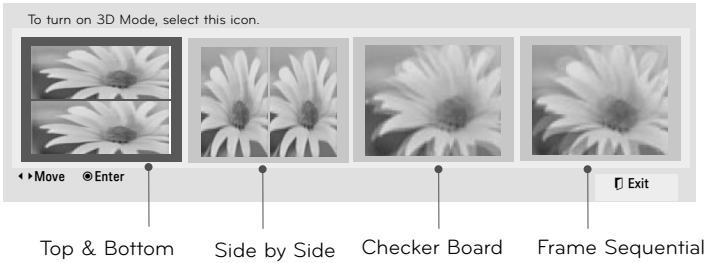

Video, which is input as HDMI (V. 1.4 with 3D) Frame Packing format, is switched into the stereoscopic screen automatically.

- 2    After selecting the shape as shown in the screen on TV, wear the 3D glasses.

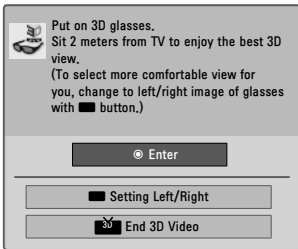

- 3   or  Select **Setting Left/Right**.



- 4   Select **Left/Right** or **Right/Left**.
Select the screen with 3D video with better visibility.

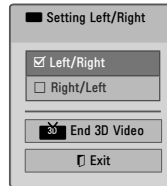

- 5  The 3D imaging mode is changed to the 2D imaging mode.

NOTE

- ▶ If you select 3D mode, "Power indicator" is turned off automatically.
- ▶ While watching 3D imaging, you cannot adjust video/audio settings using the menu.
- ▶ Some menus may not work while watching the TV in 3D.
- ▶ You can only choose "Standard → Cinema → Game" with the **AV MODE** button on remote control. **AV Mode** is set as **Standard** while playing in 3D.
- ▶ The 3D imaging mode is disabled automatically when switching DTV channels.
- ▶ The screen may not be displayed properly if you view 2D DTV images in 3D imaging mode.
- ▶ 3D effect can be seen when 3D Mode is selected appropriately for the 3D input signal supplied to the TV.
- ▶ For *.mpo files (3D camera files), the 3D imaging mode is enabled automatically.
- ▶ Energy Saving is disabled while playing in 3D.

NOTES FOR VIEWING 3D IMAGE WITH 3D BROADCASTING (* In Analog TV, 3D Imaging does not work.)

When switching the 2D image display to the 3D image display with the **3D** button on the remote control, the overlapped image may be displayed.

- Disable the 3D imaging mode with the 3D button.
- The 3D imaging mode is disabled automatically if you change the channel.

If the screen is divided into left/right or top/bottom when you change the channel



- This channel supports the 3D imaging mode. Select the 3D imaging type displayed on the screen by pressing the 3D button on the remote control.

If your eyes are soaring or the screen looks blurry while viewing 3D images

- Press the **L/R SELECT** button on the remote control and select L/R or R/L, which you find better for viewing 3D images.







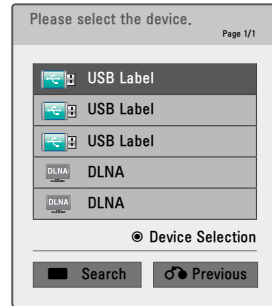
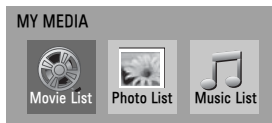

MY MEDIA

ENTRY MODE

When the Pop Up menu does not appear, you can select Movie List, Photo List or Music List in the USB menu.

Setup a USB device or DLNA with the TV to use MY MEDIA





-   Select **MY MEDIA**.
-   Select **Movie List**, **Photo List** or **Music List**.
-   Select the desired device.
-  Return to the previous menu.
-  Search other network device.

■ This TV can view JPG image files and HD DivX files and play MP3 audio files.

When removing the USB device

Select the **USB Device** menu before removing the USB device.

-   Select **USB Device**.
-  Select **Eject**.

CONNECTION METHOD

USB Connection

- 1 Connect the USB device to the **USB IN** jack on the TV.

i.e)

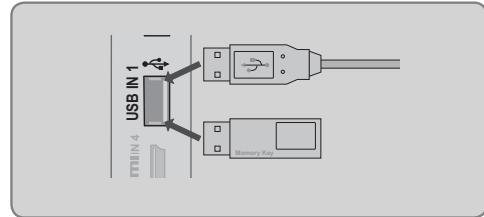

Precautions when using the USB device

- ▶ Only a USB storage device is recognizable.
- ▶ Connecting a USB storage device through a USB hub is not supported.
- ▶ A USB storage device which uses its own driver may not be recognized.
- ▶ The recognition speed of a USB storage device may depend on each device.
- ▶ Please do not turn off the TV or unplug the USB device when the connected USB storage device is working. When such device is suddenly separated or unplugged, the stored files or the USB storage device may be damaged.
- ▶ Only use a USB storage device which has normal music files, image files, or movie files.
- ▶ Please use only a USB storage device which was formatted as a FAT 32 or NTFS file system provided with the Windows operating system. Others may not be recognized.
- ▶ Some USB storage devices require a power adapter. The power adapter must be connected in order to be seen by the TV.
- ▶ If a device is not recognized by the TV, try a different cable. Excessively long cables are not supported.
- ▶ Some USB storage devices may not be supported or operate properly.
- ▶ Please backup important files because data on USB device could be damaged. Data management is consumer's responsibility and as a result, the manufacturer does not cover data damage.
- ▶ If your USB memory device has multiple partitions, or if you use a USB multi-card reader, you can use up to 4 partitions or USB memory devices.
- ▶ File alignment method of USB storage device is similar to Window XP and file names can be up to 100 English characters.
- ▶ The recommended capacity is 1 TB or less for a USB external hard disk and 32 GB or less for USB memory.
- ▶ If a USB external hard disk with a "Energy Saving" function doesn't work, turn the hard disk off and on again to make it work properly. Refer to the user manual of the USB external hard disk.
- ▶ USB storage devices below USB 2.0 are supported as well. But they may not work properly in the movie list.
- ▶ Maximum of 999 folders or files can be recognized under one folder.
- ▶ If there are too many folders and files in one folder, it may not operate properly.

DLNA

About DLNA

This TV can display and play many types of movie, photo and music files from your DLNA server and has been certified by DLNA for photos.

The Digital Living Network Alliance (DLNA) is a cross-industry organization of consumer electronics, computing industry and mobile device companies. Digital Living provides consumers with easy sharing of digital media through a wired or wireless network in the home.

The DLNA certification logo makes it easy to find products that comply with the DLNA Interoperability Guidelines. This unit complies with DLNA Interoperability Guidelines v1.5. When a PC running DLNA server software or other DLNA compatible device is connected to this TV, some setting changes of software or other devices may be required.

Please refer to pages 93~115 for additional information on supported file types and other instructions.

NOTE

- ▶ The supplied Nero MediaHome 4 Essentials CD-ROM is a customized software edition only for sharing files and folders to this TV.
- ▶ The supplied Nero MediaHome 4 Essentials software does not support following functions: Transcoding, Remote UI, TV control, Internet services and Apple iTunes
- ▶ This manual explains operations with the English version of Nero MediaHome 4 Essentials as examples. Follow the explanation referring to the actual operations of your language version.
- ▶ If there are too many folders and files in one folder, it may not operate properly.
- ▶ For the DLNA option, use the Nero MediaHome programme that is provided with the TV. However, we cannot guarantee that third party program will work perfectly.
- ▶ You can select a channel while viewing the small preview channel list on your TV screen.
- ▶ Check your network settings when the DLNA option does not work properly.
- ▶ If there is an abnormal operation or an error occurs in Nero Media Home, the DLNA option may not work properly. In this case, exit Nero Media Home and restart the programme. You can download the latest version of Nero Media Home by clicking the question mark at the bottom-left of the program.
- ▶ When the network is unstable, the device may be slower or may need to load during playback.
- ▶ When playing a video in DLNA mode, the Multi Audio and Closed Caption features are not supported.
- ▶ When selecting Full Screen in DLNA mode, the ratio of the outputted screen may differ from the original.
- ▶ When more than one TV is connected to a single server in DLNA mode, a file may not play properly, depending on the server performance.
- ▶ If the play time information is not provided by the server, it is displayed as "---:--:--."
- ▶ When using Movie List, DRM/*:tp/*:trp files in the DLNA server cannot be played.
- ▶ DLNA operation may not work properly according to the AP manufacturers.

Installing Nero MediaHome 4 Essentials

Nero MediaHome 4 Essentials is easy to use DLNA server software for Windows. If you are already using DLNA server software on your PC, Nero MediaHome is not required. Nero MediaHome is not required for Windows 7 since it has a built-in DLNA server.

Requirement PC system before you install Nero MediaHome 4 Essentials

- Windows® XP (Service Pack 2 or higher), Windows Vista® (no Service Pack required), Windows® XP Media Center Edition 2005 (Service Pack 2 or higher), Windows Server® 2003
- Windows Vista® 64-bit edition (application runs in 32-bit mode)
- Hard drive space: 200 MB hard drive space for a typical installation of Nero MediaHome stand-alone
- 1.2 GHz Intel® Pentium® III or AMD Sempron™ 2200+ processors
- Memory: 256 MB RAM
- Graphics card with at least 32 MB video memory, minimum resolution of 800 x 600 pixels, and 16-bit color settings
- Windows® Internet Explorer® 6.0 or higher
- DirectX® 9.0c revision 30 (August 2006) or higher
- Network environment: 100 Mb Ethernet, WLAN (IEEE 802.11b/g/n)

- 1 Start up your computer, and insert the Nero MediaHome 4 Essentials CD-ROM into your computer's CD-ROM drive.
An installation wizard will walk you through the quick and uncomplicated installation process.
- 2 Close all Microsoft Windows programs and exit any anti-virus software that may be running.
- 3 Insert the Nero MediaHome 4 Essentials CD-ROM into your computer's CD-ROM drive.
- 4 Click **Nero MediaHome 4 Essentials**. The installation is prepared and the installation wizard appears.
- 5 Click the **Next** button to display the serial number input screen.
Click **Next** to go to the next step.
- 6 If you accept all conditions, click **I accept the License Conditions** check box and click **Next**. Installation is not possible without this agreement.
- 7 Click **Typical** and click **Next**. The installation process is started.
- 8 If you want to take part in the anonymous collection of data, select the check box and click the **Next** button.
- 9 Click the **Exit** button to complete the installation.

Sharing files and folders

After installing Nero MediaHome, you must add folders you wish to share.

- 1 Double-click the **Nero MediaHome 4 Essentials** icon on the desktop.
- 2 Click **Network** icon on the left and define your network name in the **Network name** field. The Network name you enter will be recognized by your TV.
- 3 Click **Shares** icon on the left.
- 4 Click **Local Folders** tab on the **Shared** screen.
- 5 Click **Add** icon to open the **Browse Folder** window.
- 6 Select the folder containing the files you want to share. The selected folder is added to the list of shared folders.
- 7 Click **Start Server** icon to start the server.

NOTE

- ▶ If the shared folders or files are not displayed on the TV, click the folder on the **Local Folders** tab and click **Rescan Folder** at the **More** button.
- ▶ Visit www.nero.com for more information and software tools.



Playing back shared contents

You can display and play movie, photo and music content stored on your computer or other DLNA media servers.

1 Start the server on your computer or other device that connected on your home network.

2   Select **MY MEDIA**.

3   Select **Movie List**, **Photo List** or **Music List**.

4   Select the DLNA.
Depending on the media server, this TV may need to get the permission from the server.
If you want to re-scan available media server, press blue color button.

NOTE

- ▶ To play the file on the media server, the TV and the media server must be connected to the same access point.
- ▶ Because the compatibility and available playback functions on the **MY MEDIA** menu are tested on the bundle DLNA server (Nero MediaHome 4 Essentials) environment, file requirements and playback functions on the **MY MEDIA** may differ depending on media servers.
- ▶ The file requirements on this page are not always compatible. There may have some restrictions by file features and media server's ability.
- ▶ Even the files that are not supported can be displayed in photo thumbnail or music thumbnail.
- ▶ Movie thumbnail is not supported in DLNA Movie.
- ▶ If there is an unplayable music file in the **MY MEDIA** menu, the TV will skip the file and play next file.
- ▶ The file information indicated on the screen may not always correct for music and movie files in **MY MEDIA** menu
- ▶ This TV only supports movie subtitle files supplied by Nero MediaHome 4.
- ▶ The subtitle file name and movie file name have to be the same and located at the same folder.
- ▶ If subtitle files have been added after a directory has been indexed already, the user has to remove and re-add the folder to the list of shares.
- ▶ The playback and operating quality of the **MY MEDIA** function may be affected by your home network condition.
- ▶ The files from removable media such as USB drive, DVD-drive etc. on your media server may not share properly.
- ▶ When playing the Media through DLNA connection, it does not support the DivX file play which is protected by DRM.
- ▶ Up to 200 folders in one folder and 1000 including folders and files can be recognized.
- ▶ If there are too many folders and files in one folder, it may not operate properly.

MY MEDIA

MOVIE LIST

It displays all of the video files it recognizes.

The On-Screen Display on your model may be slightly different.

Supported movie file

- Resolution: under 1920 pixel (width) x 1080 pixel (height)
- Frame Rate: under 30 frame/sec (1920x1080), under 60 frame/sec (1280x720)
- Max bitrate of playable video file: 20 Mbps (Mega bit per second)
- Bit rate of audio format: within 32 kbps to 320 kbps (MP3)
- Supported external subtitle format: *.smi/*.srt/*.sub (MicroDVD,Subviewer1.0/2.0)/*.ass/*.ssa/*.txt (TMPPlayer)/*.psb (PowerDivX)
- Supported Internal subtitle format: only XSUB (It is the subtitle format used in DivX6 files)

Precautions when playing the video files

- ▶ Some user-created subtitles may not work properly.
- ▶ Some special characters are not supported in subtitles.
- ▶ HTML tags are not supported in subtitles.
- ▶ Time information in an external subtitle file should be arranged in ascending order to be played.
- ▶ Changing font and color in subtitles is not supported.
- ▶ Subtitles in languages other than one specified are not supported.
- ▶ Video files with subtitle files of 1 MB or larger may not be played properly.
- ▶ The screen may suffer temporary interruptions (image stoppage, faster playback, etc.) when the audio language is changed.
- ▶ A damaged video file may not be played correctly, or some functions may not be usable.
- ▶ Video files produced with some encoders may not be played correctly.
- ▶ If the video and audio structure of recorded file is not interleaved, the file not playback properly.
- ▶ Video with resolution higher than maximum resolution supported for each frame, cannot be guaranteed for smooth playback.
- ▶ Video files other than the specified types and formats may not work properly.
- ▶ The movie file encoded by the GMC (Global Motion Compensation) and Qpel (Quarterpel Motion Estimation) is not supported.
- ▶ Only 10000 sync blocks are supported within the subtitle file.
- ▶ We do not guarantee smooth playback of profiles encoded level 4.1 or higher in H.264/AVC.
- ▶ DTS Audio codec is not supported.
- ▶ A video file more than 30GB in file size is not supported for playback.
- ▶ Playing a video via a USB connection that doesn't support high speed may not work properly.
- ▶ USB storage devices below USB 2.0 are supported as well. But they may not work properly in the movie list.
- ▶ The video file and its subtitle file must be located in the same folder.
At this time, a video file name and its subtitle file name must be identical for it to be displayed.
- ▶ When you are watching a movie via the Movie List function, you can adjust the picture with the ENERGY SAVING and AV MODE button on the remote control. User setup for each picture mode is not supported.
- ▶ Trick Mode does not support other functions than ▶▶ if video files do not have index information.
- ▶ When playing video file using network, the Trick mode is limited to 2-times speed.
- ▶ Video file names that contain special characters may not be playable.

Supported Video Formats

File Extensions	Audio/Video	Codec	Profile/Level Support	Explanation
.asf .wmv	Video	VC-1 Advanced Profile	Advanced Profile@Level 3 (e.g. 720p60, 1080i60, 1080p30)	Only streams compliant to SMPTE 421M VC-1 standard are supported.
		VC-1 Simple and Main Profiles	Simple Profile@Medium Level (e.g. CIF, QVGA) Main Profile@High Level (e.g. 1080p30)	
	Audio	WMA Standard		
		WMA 9 Professional		
.divx .avi	Video	DivX3.11	Advanced Simple Profile (e.g. 720p/1080i)	Global motion compensation or quarterpel motion estimation does not supported. Streams using this syntax are not supported.
		DivX4 DivX5 DivX6 XViD		
	Audio	H.264 / AVC	Main Profile@ Level 4.1 High Profile@ Level 4.1 (e.g. 720p60, 1080i60, 1080p30)	
		MPEG-1 Layer I, II MPEG-1 Layer III (MP3) Dolby Digital		
.mp4 .m4v	Video	H.264 / AVC	Main Profile@ Level 4.1 High Profile@ Level 4.1 (e.g. 720p60, 1080i60, 1080p30)	Global motion compensation or quarterpel motion estimation does not supported. Streams using this syntax are not supported.
		MPEG-4 Part 2	Advanced Simple Profile (e.g. 720p/1080i)	
	Audio	AAC	AAC-LC and HE-AAC	
		MPEG-1 Layer I, II MPEG-1 Layer III (MP3) Dolby Digital		
.mkv	Video	H.264 / AVC	Main Profile@ Level 4.1 High Profile@ Level 4.1 (e.g. 720p60, 1080i60, 1080p30)	Most of the MKV content available is encoded by the open source x264 codec.
		MPEG-2	Main Profile@High Level(e.g. 720p60, 1080i60)	
	Audio	AAC	AAC-LC and HE-AAC	
		Dolby Digital		
.ts .trp .tp	Video	H.264 / AVC	Main Profile@ Level 4.1 High Profile@ Level 4.1 (e.g. 720p60, 1080i60, 1080p30)	Only streams compliant to SMPTE 421M VC-1 standard are supported.
		MPEG-2	Main Profile@High Level(e.g. 720p60, 1080i60)	
	Audio	VC-1	Simple Profile@Medium Level (e.g. CIF, QVGA) Main Profile@High Level (e.g. 1080p30) Advanced Profile@Level3 (e.g. 720p60, 1080i60, 1080p30)	
		MPEG-1 Layer I, II MPEG-1 Layer III (MP3) Dolby Digital		
	Audio	AAC	AAC-LC and HE-AAC	
		MPEG-1		
.vob	Video	MPEG-2	Main Profile@High Level (e.g. 720p60, 1080i60)	
		Dolby Digital MPEG-1 Layer I, II DVD-LPCM		
.mpg	Video	MPEG-1	Main Profile@High Level (e.g. 720p60, 1080i60)	Only streams compliant configured properly for TS, PS or ES
		MPEG-1 Layer I, II		

MY MEDIA

Screen Components





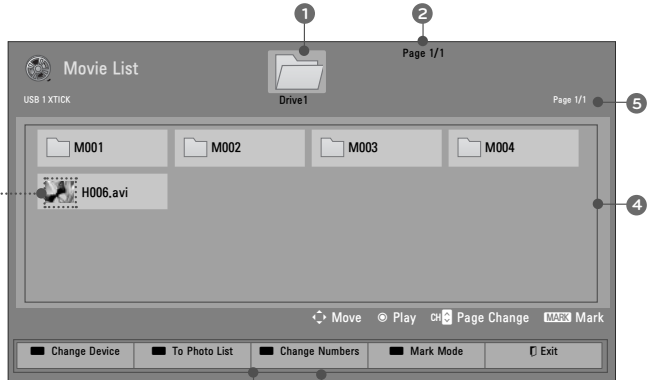

- 1 Moves to upper level folder
- 2 Current page/Total pages
- 3 Corresponding buttons on the remote control
- 4 Contents under the folder focused on 1
- 5 Current page/ total pages of contents



Abnormal files are displayed using this graphic.





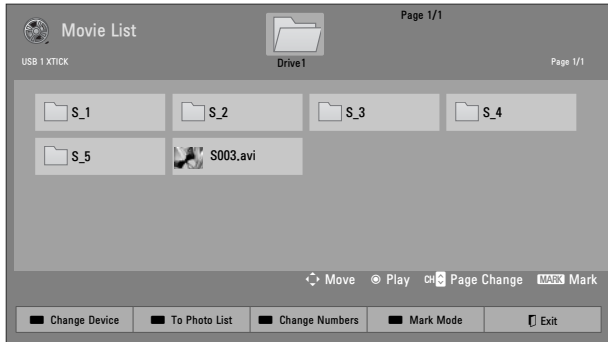

Non-supported files are displayed using this graphic.

	Change device.
	Move to Photo List or Music List .
	Change Numbers: Changes the number of thumbnails displayed at a time.
	Allows you to mark certain files.
	Return to TV viewing.

Movie Selection





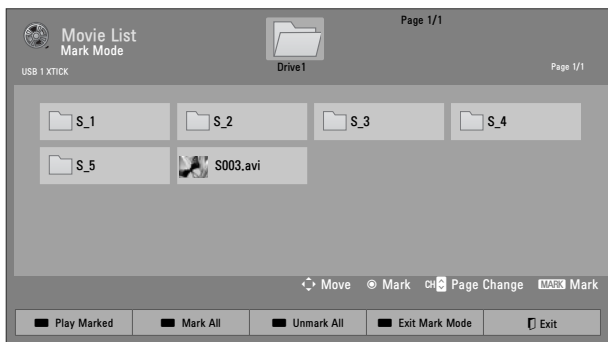

- 1  Select the target folder or drive.
- 2   Select the desired movie title.
- 3  Play the movie file.

■ Use the CH (^ v) button to navigate in the movie page.

Mark Mode



- 1  Select the target folder or drive.
- 2   Select the desired movie title.
- 3  Mark your desired movie file.
- 4  Play the marked movie file. It displays the current movie status progress bar on the bottom of the screen.

RED

Play Marked: Play the first selected file. Once a movie finishes playing, the next selected one will be played automatically.

GREEN

Mark All: Mark all files in the folder.

YELLOW

Unmark All: Deselect all marked files.

BLUE

Enter or exit the Mark Mode.

■ When one or more movie files are marked, the marked movies will be played in sequence.

MY MEDIA

Using the Movie List Function

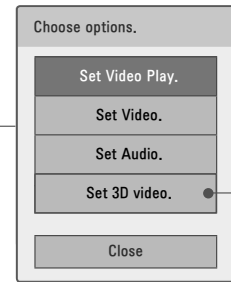

For 42/47LX6500



Show the **Option** menu.



Select **Set Video Play**, **Set Video**, **Set Audio** or **Set 3D video**.



NOTE

- ▶ When replaying a video file after stopping, you can play from where it stopped automatically.
- ▶ If you select "Yes" when playing the same file after the video file has been stopped, it will restart where it stopped previously.
- ▶ If continuous series files exist within the folder, the next file will automatically be played. But, this excludes cases when the Repeat function of Movie List Option is turned "On" or when set as Marked Play.

Using the remote control

	Return to TV viewing.
	Select the required speed: x2, x4, x8, x16, x32 (backward/forward).
	Pauses the media player. If no buttons are pressed on the remote control for 10 minutes after pausing, the TV returns to the playback state.
	Displays slow motion.
	Move to a specific frame forward or backward while playing a video. A cursor indicating the position can be viewed on the screen. It may not work properly for some movie files.
	Return to normal playback.
	Hide the menu on screen. To see the menu again, press ENTER button.
	Press the ENERGY SAVING button repeatedly to increase the brightness of your screen (Refer to p. 130).
	Press the AV MODE button repeatedly to select the desired source (Refer to p. 74).

Set Video Play Menu Options



1 Select **Picture Size**, **Audio Language**, **Subtitle Language**, or **Repeat**.



2 Make appropriate adjustments.

Code Page

Subtitle Language Group	Supported Language
Latin1	English, Spanish, Portuguese

- **Picture Size:** Selects your desired picture format for videos.

- **Full Mode:** Files are played in full screen mode regardless of the aspect ratio of video.

- **Original Mode:** Files are played according to the aspect ratio of video.

- **Audio Language:** Changes the Language Group of the audio for video files. Files with a single audio track cannot be selected.

- **Subtitle Language:** The subtitles can be turned on or off.

- **Language:** Activated for SMI subtitles and can select the language within the subtitle.

- **Code Page:** Subtitle font selection. When set to default, Contents are displayed in the language set in "Option - Language - Menu Language."

- **Sync:** When the video is not synchronized with the captions, it can be adjusted by 0.5 second.

- **Position:** Move the location of the subtitles.

- **Size:** Changes the subtitle font size.

- **Repeat:** Turn on/off repeat function of movie playback. When turned on, the file within the folder will be played back repeatedly.

MY MEDIA

* Image shown may differ from your TV.

Set Video Menu Options

For LED LCD TV/LCD TV

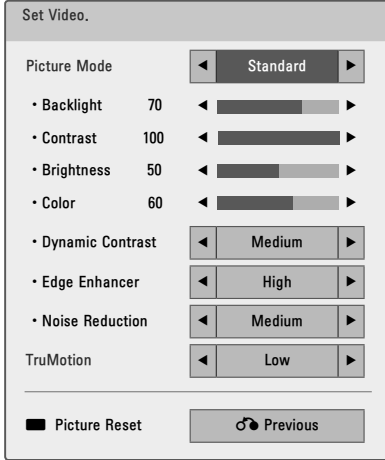

For Plasma TV

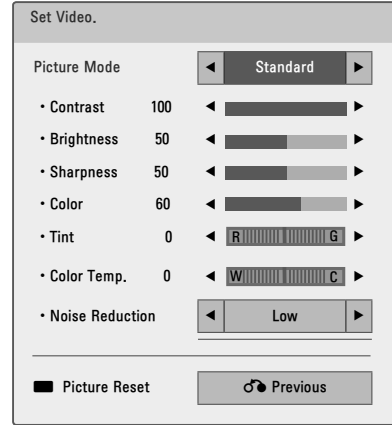

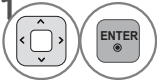
- 

Make appropriate adjustments. Then, select **Previous**.
- 

Reset picture settings to default.

MY MEDIA

Set Audio Menu Options

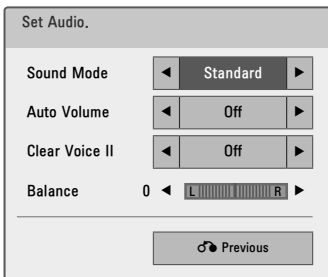

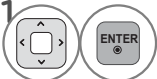
- 

Make appropriate adjustments. Then, select **Previous**.

Set 3D video Menu Options

(For 42/47LX6500)

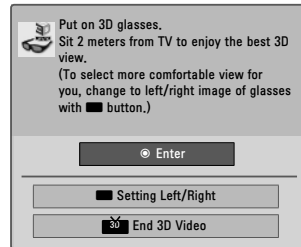

For more information, see the 3D Imaging section in the Owner's Manual.

PHOTO LIST

The On-Screen Display on your model may be slightly different.

Supported photo file: *.JPG

- Baseline: 64 pixel (width) x 64 pixel (height) to 15360 pixel (width) x 8640 pixel (height)
- Progressive: 64 pixel (width) x 64 pixel (height) to 1920 pixel (width) x 1440 pixel (height)
- You can play JPEG files only.
- Non-supported files are displayed in the form of predefined icon.

An error message occurs for corrupted files or file formats that cannot be played.

Corrupted image files may not be displayed properly.

It may take some time to view high-resolution images in full screen.

For 42/47LX6500

	File Extensions	Item	Profile
2D	jpeg jpg jpe	supported file format	SOF0: baseline SOF1: Extend Sequential SOF2: Progressive
		photo size	Min: 64 x 64 Max - Normal Type: 15360 (W) x 8640 (H) Progressive Type: 1920 (W) x 1440 (H)
3D	mpo	supported file format	mpo
		photo size	4:3 size: 3648 x 2736 2592 x 1944 2048 x 1536 3:2 size: 3648 x 2432

Screen Components

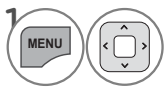

Select **MY MEDIA**.

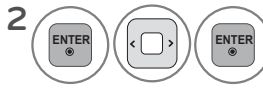

Select **Photo List**.

- 1 Moves to upper level folder
- 2 Current page/Total pages
- 3 Corresponding buttons on the remote control
- 4 Contents under the folder focused on 1
- 5 Current page/total pages of contents

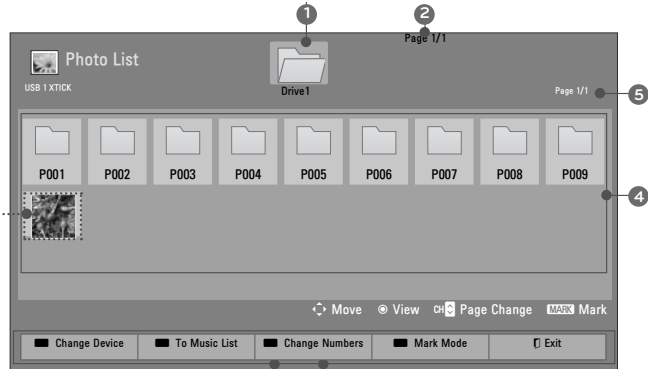

Abnormal files are displayed using this graphic.





Non-supported files are displayed using this graphic.

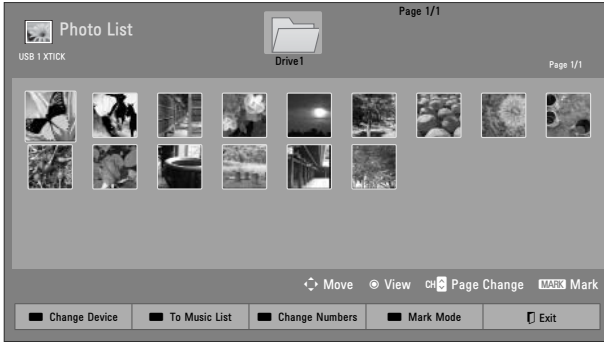

RED	Change device.
GREEN	Move to Music List or Movie List .
YELLOW	Change Numbers: Changes the number or thumbnails displayed at a time.
BLUE	Allows you to mark certain files.
EXIT	Return to TV viewing.

MY MEDIA

Photo Selection



1  Select the target folder or drive.

2   Select the desired photos.

3  Photo file is displayed.

- Use the CH ($\wedge \vee$) button to navigate in the photo page.

Mark Mode

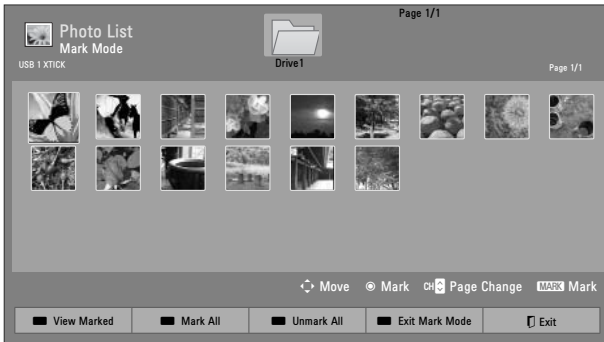

1  Select the target folder or drive.

2   Select the desired photo files.

3  Mark your desired photo files.

4  View the marked photo files.

 **View Marked:** Display the selected photo.

 **Mark All:** Mark all photos on the screen.

 **Unmark All:** Deselect all marked photos.

 Enter or exit the Mark Mode.



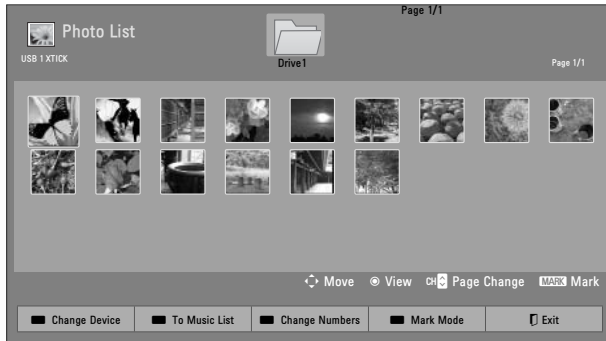

- When one or more photos are marked, you can view individual photos or a slide show of the marked photos. If no photos are marked, you can view all photos individually or all photos in the folder in a slide show.

How to View Photos

Detailed operations are available on full-sized photo view screen.



The aspect ratio of a photo may change the size of the photo displayed on the screen in full size.

-  Select the target folder or drive.
-   Select the desired photos.
-  The selected photo is displayed in full size.

- Use the CH (▲ ▼) button to navigate in the photo page.

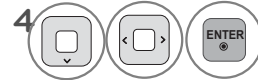

Select the **Slideshow**, **BGM**, **⤵ (Rotate)**, **🖼️/📄 (Energy Saving)**, **Option**, **Hide** or **Exit**.

- Use <> button to select the previous or next photo.

- ▶ **Slideshow**: Selected photos are displayed during the slide show. If no photo is selected, all photos in the current folder are displayed during slide show.
 - Set the time interval of the slide show in **Option-Set Photo View** menu (Refer to p. 107).
 - You can adjust **Option** by using the **Q.MENU** button on the remote control.
- ▶ **BGM** (Background Music): Listen to music while viewing photos in full size.
 - Set the BGM device and album in in **Option-Set Photo View** menu (Refer to p. 107).
 - You can adjust **Option** by using the **Q.MENU** button on the remote control.
- ▶ **⤵ (Rotate)** : Rotate photos.
 - Rotates the photo 90°, 180°, 270°, 360° clockwise.
 - Photos cannot be rotated if its width is greater than the available supported resolution height.
- ▶ **🖼️/📄**: View the photo in full mode or original mode.
- ▶ **🔋 (Energy Saving)**: Increase the brightness of your screen by using ENERGY SAVING button.
- ▶ **Option** : Set values for **Slide Speed** and **BGM** (Refer to p.107).
 - You cannot change **BGM** while BGM is playing.
 - You can only select the MP3 folder saved on the device that currently displays the photo.
- ▶ **Hide** : Hide the menu on the full-sized screen.
 - To see the menu again on the full-sized screen, press **ENTER** button to display.
- ▶ **Exit** : Move to the previous menu screen.

Using the Photo List Function

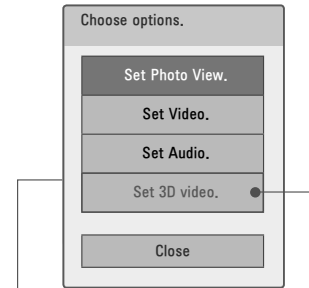

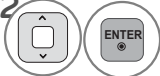

For 42/47LX6500

- 1  Show the **Option** menu.
- 2  Select **Set Photo View**, **Set Video**, **Set Audio** or **Set 3D video**.

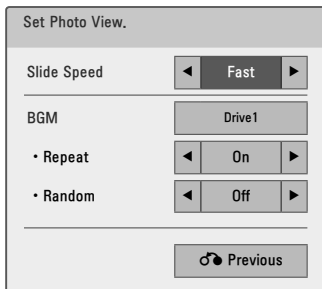
Set Photo View Menu Options



- 1  Select **Slide Speed** or **BGM**.
- 2  Make appropriate adjustments.

MY MEDIA

* Image shown may differ from your TV.

Set Video Menu Options

For LED LCD TV/LCD TV

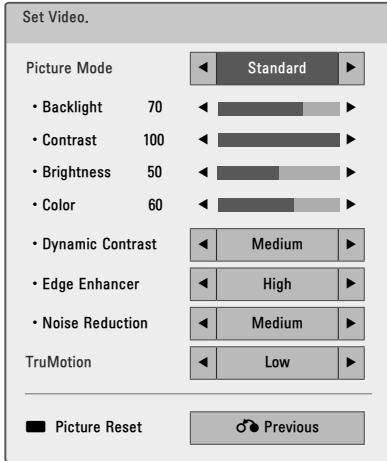

For Plasma TV

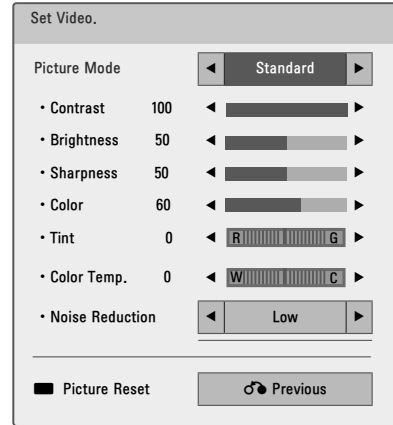

1 Make appropriate adjustments. Then, select **Previous**.

Reset picture settings to default.

Set Audio Menu Options

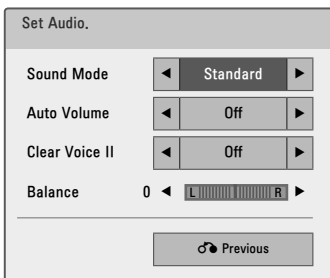

1 Make appropriate adjustments. Then, select **Previous**.

Set 3D video Menu Options

(For 42/47LX6500)

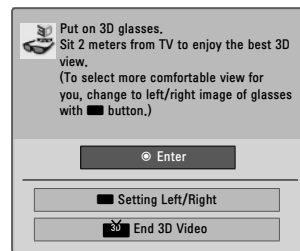

For more information, see the 3D Imaging section in the Owner's Manual.

MUSIC LIST

Purchased music files(*.MP3) may contain copyright restrictions. Playback of these files may not be supported by this TV.

The On Screen Display below may be different from your TV. Images are an example to assist with the TV operation.

Supported Music File: *.MP3

Bit rate range: 32 Kbps - 320 Kbps

- Sampling rate MPEG1 Layer3 : 32 kHz, 44.1 kHz, 48 kHz
- Sampling rate MPEG2 Layer3 : 16 kHz, 22.05 kHz, 24 kHz

Screen Components



- 1 Preview: If any album jacket for the file (Album Art Image) exists, this picture is displayed.
- 2 Moves to upper level folder
- 3 Current page/Total pages
- 4 Corresponding buttons on the remote control
- 5 Contents under the folder focused on 2
- 6 Current page/total pages of contents

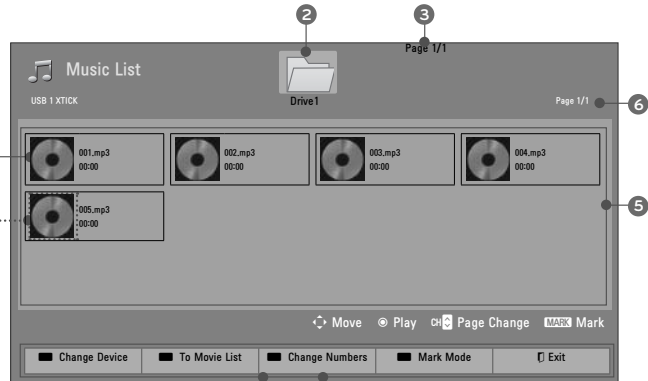

Abnormal files are displayed using this graphic.







Non-supported files are displayed using this graphic.

	Change device.
	Move to Movie List or Photo List .
	Change Numbers: Changes the number or thumbnails displayed at a time.
	Allows you to mark certain files.
	Return to TV viewing.
	Press the ENERGY SAVING button repeatedly to increase the brightness of your screen (Refer to p.130). (For LED LCD TV/LCD TV: It's available " ENERGY SAVING - Off, Screen Off " only.)

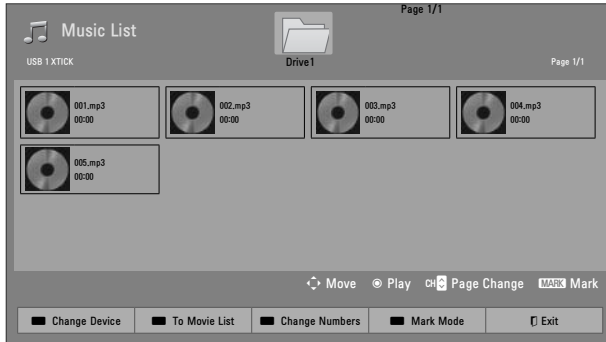
MY MEDIA

Music Selection





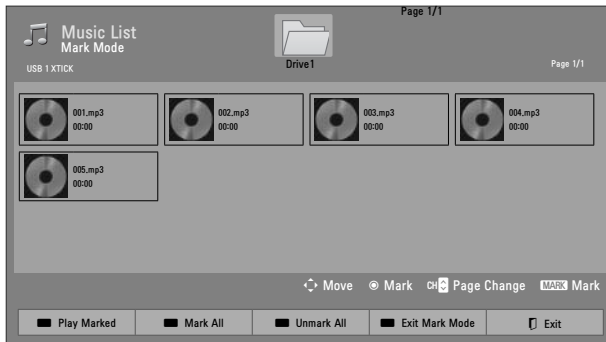

- 1  Select the target folder or drive.
- 2   Select the desired music file.
- 3  Music files are played.

■ Use the CH (\wedge \vee) button to navigate in the music page.

Mark Mode



- 1  Select the target folder or drive.
- 2   Select the desired music file.
- 3  Mark your desired music file.
- 4  Play the marked music file.

■ When one or more music files are marked, the marked music files will be played in sequence.

RED

Play Marked: Play the selected songs. Once a song finishes playing, the next selected one will be played automatically.

GREEN

Mark All: Mark all songs in the folder.

YELLOW

Unmark All: Deselect all marked song.

BLUE

Enter or exit the Mark Mode.

Using the Music List Function

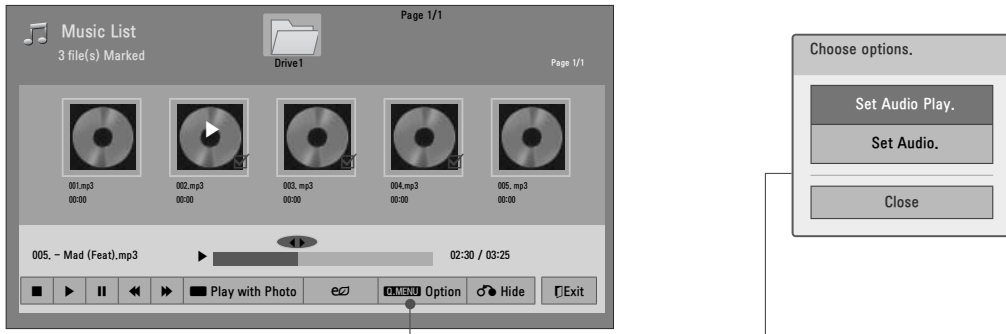

1 Show the **Option** menu.

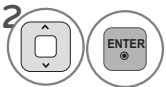

2 Select **Set Audio Play** or **Set Audio**.

NOTE

▶ You can listen to the music only within the device currently played.

Using the remote control

	Stop the song.
	Return to normal playback.
	Paused the song.
	Select the previous or next song.
	Play with Photo: Start playing the selected songs and then move to the Photo List.
	Press the ENERGY SAVING button repeatedly to increase the brightness of your screen (Refer to p. 130). (For LED LCD TV/LCD TV: It's available " ENERGY SAVING - Off, Screen Off " only.)
	A cursor indicating the position can be played.
	Move to the previous menu screen.

Set Audio Play Menu Options



1 Select **Repeat** or **Random**.



2 Make appropriate adjustments.

Set Audio Menu Options

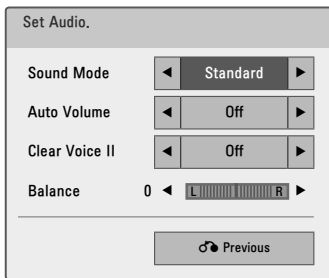

1 Select **Sound Mode**, **Auto Volume**, **Clear Voice II** or **Balance**.



2 Make appropriate adjustments.

- If you don't press any buttons for a while, the play information box will float across the screen. This prevents screen pixel damage due to a fixed image remaining on the screen for an extended period of time.

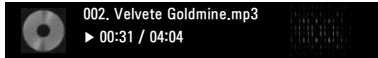

! NOTE





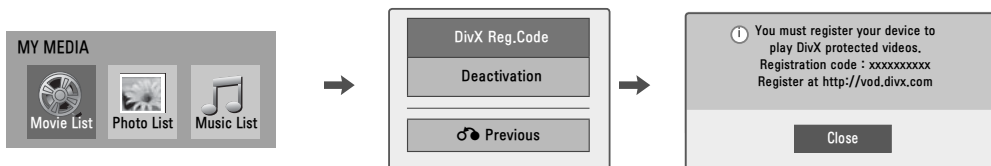

- ▶ A damaged or corrupted music does not play but displays 00:00 in playtime.
- ▶ Music files with copy-protection will not play.
- ▶ Press ENTER or  button to stop the screen saver.

MY MEDIA

DIVX REGISTRATION CODE

Using the registration number, movies can be rented or purchased at www.divx.com/vod.
Only DivX files matched with the registration code of the purchased TV are playable.



- 1   Select **MY MEDIA**.
- 2   Select DivX Option.
- 3  Select **DivX Reg. Code**.
- 4  Display Divx Reg. Code.

NOTE







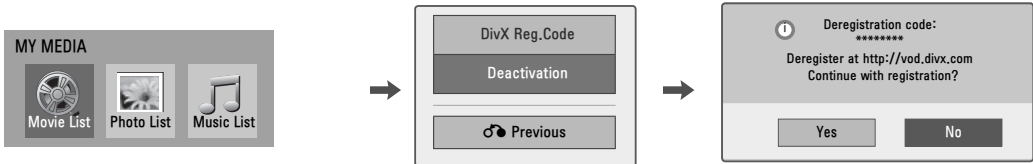

- ▶ When loading, some buttons may not work.
- ▶ If you use the DivX registration code of another device, the rented or purchased DivX file cannot be played. Therefore always use the DivX registration code assigned to this product.
- ▶ The video or audio of a file converted based on a standard other than the DivX codec standard may be corrupted or unable to be played.
- ▶ The DRM/*.tp/*.trp file in DLNA server is not played when Movie List is in operation.

DEACTIVATION

The purpose of deactivation is to allow deactivation of devices for users who have activated all the available devices through the web server and are blocked from activating more devices. DivX VOD allows the consumer to activate up to 6 devices under one account.

Delete the existing authentication information to receive a new DivX user authentication for TV. Once this function is executed, a DivX user authentication is required again to see DivX DRM files.







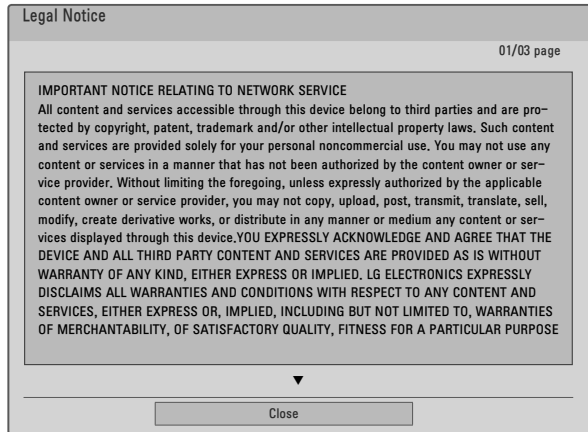
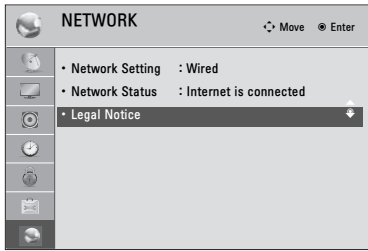

- 1   Select **MY MEDIA**.
- 2   Select DivX Option.
- 3  Select **Deactivation**.
- 4   Select **Yes**.
- 5  Display **Deactivation**.

NETWORK

LEGAL NOTICE



-   Select **NETWORK**.
-   Select **Legal Notice**.
-   Check Legal notice.
-  Return to TV viewing.

IMPORTANT NOTICE RELATING TO NETWORK SERVICE

All content and services accessible through this device belong to third parties and are protected by copyright, patent, trademark and/or other intellectual property laws. Such content and services are provided solely for your personal noncommercial use. You may not use any content or services in a manner that has not been authorized by the content owner or service provider. Without limiting the foregoing, unless expressly authorized by the applicable content owner or service provider, you may not copy, upload, post, transmit, translate, sell, modify, create derivative works, or distribute in any manner or medium any content or services displayed through this device.

YOU EXPRESSLY ACKNOWLEDGE AND AGREE THAT THE DEVICE AND ALL THIRD PARTY CONTENT AND SERVICES ARE PROVIDED "AS IS" WITHOUT WARRANTY OF ANY KIND, EITHER EXPRESS OR IMPLIED. LG ELECTRONICS EXPRESSLY DISCLAIMS ALL WARRANTIES AND CONDITIONS WITH RESPECT TO ANY CONTENT AND SERVICES, EITHER EXPRESS OR IMPLIED, INCLUDING BUT NOT LIMITED TO, WARRANTIES OF MERCHANTABILITY, OF SATISFACTORY QUALITY, FITNESS FOR A PARTICULAR PURPOSE, AND NON-INFRINGEMENT OF THIRD PARTY RIGHTS. LG DOES NOT GUARANTEE THE ACCURACY, VALIDITY, TIMELINESS, LEGALITY, OR COMPLETENESS OF ANY CONTENT OR SERVICE MADE AVAILABLE THROUGH THIS DEVICE AND DOES NOT WARRANT THAT THE DEVICE OR SERVICES WILL MEET YOUR REQUIREMENTS, OR THAT OPERATION OF THE

DEVICE OR SERVICES WILL BE UNINTERRUPTED OR ERROR-FREE. UNDER NO CIRCUMSTANCES, INCLUDING NEGLIGENCE, SHALL LG BE LIABLE, WHETHER IN CONTRACT OR TORT, FOR ANY DIRECT, INDIRECT, INCIDENTAL, SPECIAL OR CONSEQUENTIAL DAMAGES, OR ANY OTHER DAMAGES ARISING OUT OF, ANY INFORMATION CONTAINED IN, OR ANY CONTENT OR SERVICE ACCESSED BY YOU OR ANY THIRD PARTY, EVEN IF ADVISED OF THE POSSIBILITY OF SUCH DAMAGES.

Third party services may be changed, suspended, removed, terminated or interrupted, or access may be disabled at any time, without notice, and LG makes no representation or warranty that any content or service will remain available for any period of time. Content and services are transmitted by third parties by means of networks and transmission facilities over which LG has no control. LG may impose limits on the use of or access to certain services or content, in any case and without notice or liability. LG expressly disclaims any responsibility or liability for any change, interruption, disabling, removal or suspension of any content or service made available through this device.

LG is neither responsible nor liable for customer service related to the content and services. Any question or request for service relating to the content or services should be made directly to the respective content and service providers.

NETCAST

NETCAST MENU



These services are provided by separate Content Provider.

Please visit the content providers web site for specific information on their services. (But, some content manual maybe not provide depending on Content Provider).

NETCAST menu source can differ by country.

i.e)



- 1   Select **NETCAST** menu option.
- 2  Enjoy Online Service.

- To select Weather of area, press the RED button.

NOTE

- ▶ The videos list searched from the TV may different with the list searched from a web browser on PC.
- ▶ The settings of this TV do not affect the video playback quality.
- ▶ To view the owner's manual that provided by the Content Provider, visit our website at <http://www.lg.com>.
- ▶ For service that requires log in, join the applicable service on the website using the PC and log in through the TV to enjoy various additional functionalities.
- ▶ When you set the city you want with Setup by pressing the red button, the background of NetCast will be set to the weather of the selected city.
- ▶ For Plasma TV: If there is no user action 2 minutes following freezing image or video on screen, the screensaver will activate itself preventing fixed image remaining on screen.

WEATHER INFORMATION

Weather information is the program to view the weather of the city the user wants.

Screen Components

- 1 Weather info menu
- 2 Weather list by city



	Change between Celsius and Fahrenheit.
	Move the focus to the menu you want.
	Select the focused menu.
	Return to Netcast menu.
	Return to TV viewing.

Service menu

Home: The weather of selected city is displayed.

Favorite City: Frequently checked cities can be registered to check the weather.

NOTE

- ▶ By default, New York, London and Paris are registered and the user can add/delete cities from Favorite City.
- ▶ LG is not responsible for the accuracy of the weather forecast.
- ▶ Applicable weather information can differ from the actual weather.

NETCAST

PHOTO ALBUM

Users can use or view the photos.

Screen Components

- 1 Photo Album menu
- 2 Photo list



	Navigate the desired photos.
	The selected photo file is displayed.
	Return to Netcast menu.
	Return to TV viewing.

Photo Album menu

Home: The featured photos list will be displayed.

Friends: You can register users with the pictures you want as friends. You can add up to 10 friends.

Search: The keypad/keyboard menu will be displayed.

My Photos: You can view the pictures uploaded to the Web. This function can only be used when you sign in.

Sign in (Sign Out): Displays the keypad/keyboard menu to sign in or returns to the sign-out status.

VIDEO ONLINE

This is a video sharing website where users can upload, view, and share video clips.

Screen Components

- 1 Video menu
- 2 Videos list

	Set the option menu.
	Return to Netcast menu.
	Return to TV viewing.

NOTE

- ▶ When you press the Q.menu button while the video is playing in full mode, you can set the video options.
- ▶ The playback of videos may be paused, stopped or buffering occurring often depending on your broadband speed.

We recommend a minimum connection speed of 1.5 Mbps. For the best playback condition, a connection speed of 4.0 Mbps is required. Sometimes your broadband speed varies based on your ISP's network conditions. Contact your ISP if you have problems maintaining a fast connection that is reliable, or if you want to increase your connection speed. Many ISPs offer a variety of broadband speed options.

Watching video menu

Home: You can watch the popular video in real time.

Featured: The featured videos list will be displayed.

Popular: The best rated videos list from Watching video server will be displayed.

Most Viewed: The most viewed videos list will be displayed.







Search: The keypad/keyboard menu will be displayed.

History: The videos list that you previously played will be displayed. Maximum of 20 videos can be stored.

Favorites: In sign-in status, this menu will be displayed the videos list that is arranged in the Watching video server with your account (Some videos may not appear on the **Favorites** list, even if the videos are arranged in the server).

Sign in (Sign Out): Displays the keypad/keyboard menu to sign in or returns to the sign-out status.

Using the remote control

	Stops the video and displays related videos list.
	Pause the video while it is playing.
	Play the selected video.
	Skip the playback forward or backward.
	Set the option menu.
	Return to Netcast menu.
	Return to TV viewing.

EMOL

You can use a various emol contents.

Screen Components

1 emol menu
2 Title article display



Martes, 23 de Febrero de 2010

Nacional
Economía
Deportes
Magazine
Tecnología
Mundo

Indicadores

US\$ Obs. 529.19
Euro 715.12

Ayer 20898.02
Hoy 20901.74
Mañana 20905.46

MUNDO gráfico

El Mercurio en fotos
29/02/2010

Paul Anka deleitó a la Quinta

"Coco" Legrand sacó risas a la Quinta

Paul Anka las hizo todas en el escenario y logró salvar la primera noche del Festival de Viña 2010

Desde una aparición entre el público hasta el esperado homenaje a Michael Jackson marcaron el paso del canadiense por el Festival, de donde obviamente se fue con todos los trofeos posibles.

Revisión de compromisos presidenciales marca 2º consejo de gabinete del año

Esta madrugada falleció uno de los trillizos nacidos a fines de enero

ONU denuncia sus compromisos post

< > < > < > < >
Navigate the desired article.

ENTER
The selected article is displayed.

NetCast
Return to Netcast menu.

EXIT
Return to TV viewing.

■ If you want to more information, visit www.emol.com

NETCAST

BAZUCA

You can watch movies from bazuca streamed over the internet to your TV.

Screen Components

- 1 bazuca menu
- 2 Movie poster



Navigate the desired video.



The selected video is displayed.



Return to Netcast menu.



Return to TV viewing.

TERRA TV



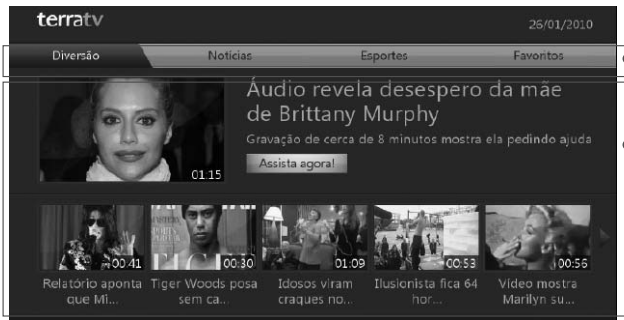

You can use a various terratv contents.

Screen Components

1 terratv menu
2 Videos list



The screenshot shows the terratv interface. At the top, there is a navigation bar with the 'terratv' logo on the left and the date '26/01/2010' on the right. Below the logo, there are four menu items: 'Diversão', 'Noticias', 'Esportes', and 'Favoritos'. The main content area features a large video player with a portrait of a woman and the title 'Audio revela desespero da mãe de Brittany Murphy'. Below the main video, there is a horizontal list of smaller video thumbnails with their respective durations and titles.

	Navigate the desired video.
	The selected video is displayed.
	Return to Netcast menu.
	Return to TV viewing.

- If you want to more information, visit <http://terratv.terra.com>.

PICTURE CONTROL

PICTURE SIZE (ASPECT RATIO) CONTROL

This feature lets you choose the way an analog picture with a 4:3 aspect ratio is displayed on your TV. You can select a different aspect ratio depending on input source (analog broadcasting, digital broadcasting, aux).

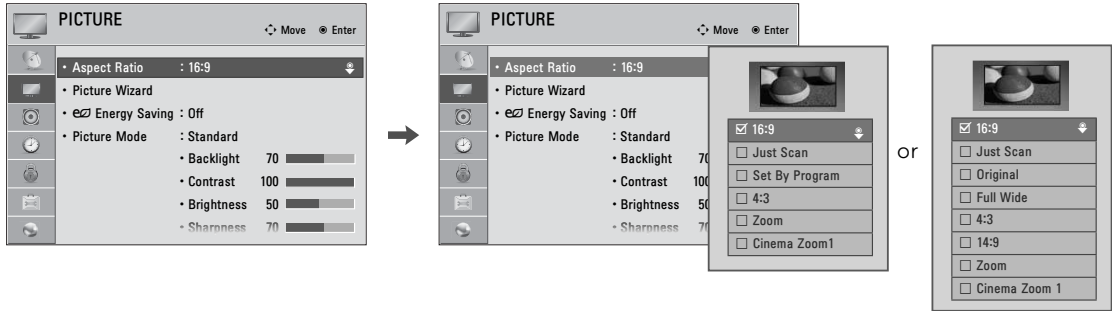

- 1 Select **PICTURE**.
- 2 Select **Aspect Ratio**.
- 3 Select the desired picture format.
- 4 Return to the previous menu.
- Return to TV viewing.

- You can also adjust **Aspect Ratio** in the **Q.MENU**.
- Press the **RATIO** button repeatedly to select the desired picture format.

When adjusting Zoom or Cinema Zoom in Q.MENU

- 1 Select **Aspect Ratio**.
- 2 Select **Zoom** or **Cinema Zoom**.
- 3 Adjust proportion of Zoom or Cinema Zoom. The Cinema Zoom adjustment range is 1-16.
- 4 Move the image on the screen.

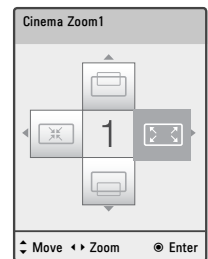
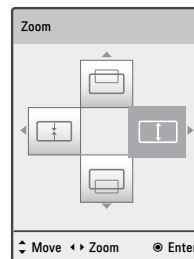

16:9

Adjust the picture horizontally, in a linear proportion to fill the entire screen.



Just Scan

Normally the edges of video signals are cropped 1-2%. Just Scan turns off this cropping and shows the complete video.

Notes: If there is noise on the edges of the original signal, it will be visible when Just Scan is activated.



Original

When your TV receives a wide screen signal it will automatically change to the picture format broadcast.



Full Wide

When TV receives the wide screen signal, it will lead you to adjust the picture horizontally or vertically, in a linear proportion, to fill the entire screen fully. 4:3 and 14:9 video is supported in full screen without any video distortion through DTV input



Set By Program

Selects the proper picture proportion to match the source's image.

(4:3 → 4:3)

(16:9 → 16:9)



14:9

You can view a picture format of 14:9 or a general TV programme in the 14:9 mode. The 14:9 screen is viewed in the same way as in 4:3, but is moved to the up and down.

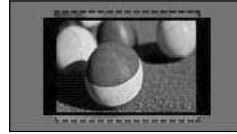

4:3

Choose 4:3 when you want to view a picture with an original 4:3 aspect ratio.



Zoom

Choose Zoom when you want to view the picture without any alteration. However, the top and bottom portions of the picture will be cropped.



Cinema Zoom 1

Choose Cinema Zoom when you want to enlarge the picture in correct proportion.

This enlarges an image with cinemascope aspect ratio (2.35:1) without distortion.

Note: When enlarging or reducing the picture, the image may become distorted.



PICTURE CONTROL

PICTURE WIZARD

This feature lets you adjust the picture quality of the original image.

Use this to calibrate the screen quality by adjusting the Black and White Level etc. You can calibrate the screen quality by easily following each step.

When you adjust the image to **Low**, **Recommended** or **High**, you can see the example of the changes you made.

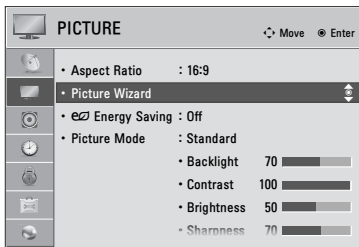

- If you select **Preferred**, OSD (On Screen Display) differ from that shown in this manual.

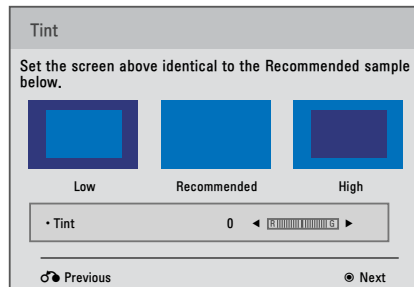
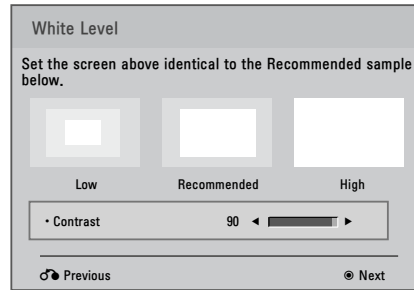
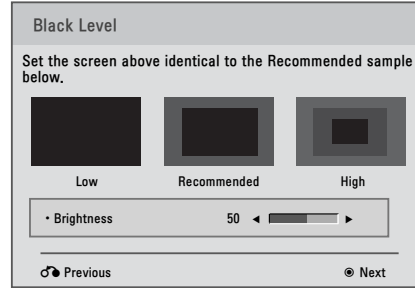

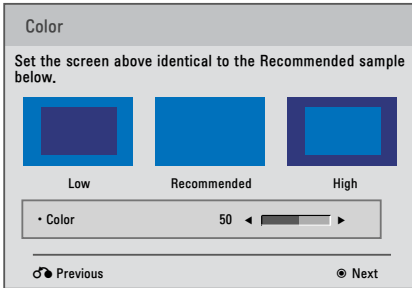

8   Adjust **Color**.

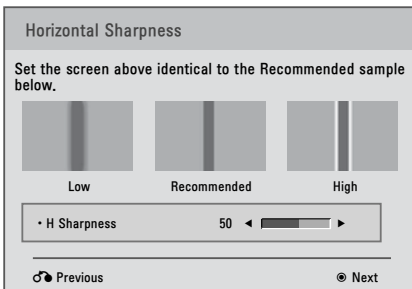

9   Adjust **Horizontal Sharpness**.

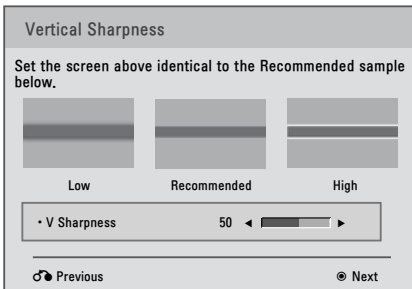

10   Adjust **Vertical Sharpness**.

For LED LCD TV/LCD TV



11   Adjust **Backlight**.

i.e)

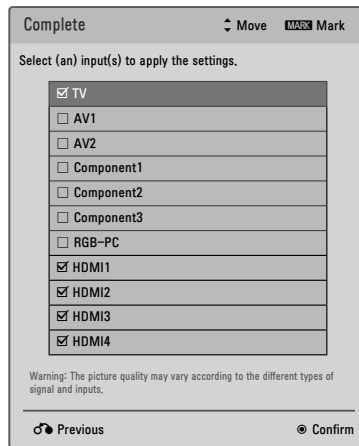

12   Select input source to apply the settings.

13  Save.

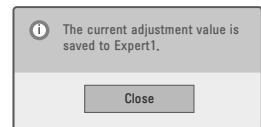

14  Finish the Picture Wizard.

- If you stop the setting before the final step, the changes will not be saved to the TV.
- Once the **Picture Wizard** sets the picture quality, **Energy Saving** is changed to **Off** automatically.
- To reset changes made by **Picture Wizard**, operate **Picture Reset** when **Picture Mode** is on **Expert1**.

PICTURE CONTROL

e ENERGY SAVING

It reduces the TV's power consumption.

You can increase the brightness of your screen by adjusting the **Energy Saving** level or by adjusting the **Picture Mode**.

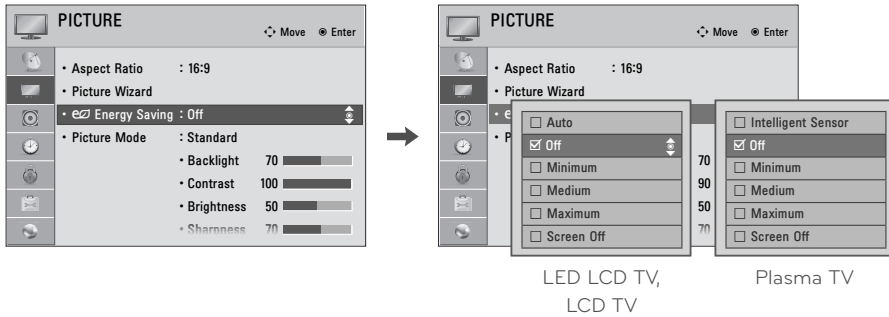

- 1 Select **PICTURE**.
- 2 Select **e Energy Saving**.
- 3 Select your desired menu option.
- 4 Return to the previous menu.
- Return to TV viewing.

- When selecting **Screen off**, the screen will turn off after 3 seconds. Pressing any button of the remote controller will turn on the screen again.
- If you adjust "**Energy Saving-Auto, Maximum**", **Backlight** option will not work (For LED LCD TV/LCD TV).
- When selecting "**Energy Saving - Off, Minimum, or Medium**", you can adjust **Backlight** feature
- When selecting **Auto, Backlight** is automatically adjusted through **Intelligent Sensor** according to the surrounding conditions (For LED LCD TV/LCD TV).
- When selecting **Off, Energy Saving** is not used.
- Press the **ENERGY SAVING** button repeatedly to select the appropriate Energy Saving.

PRESET PICTURE SETTINGS (PICTURE MODE)

There are factory presets for picture settings available in the user menus. You can use a preset, change each setting manually, or use the Intelligent Sensor.

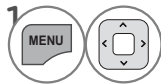
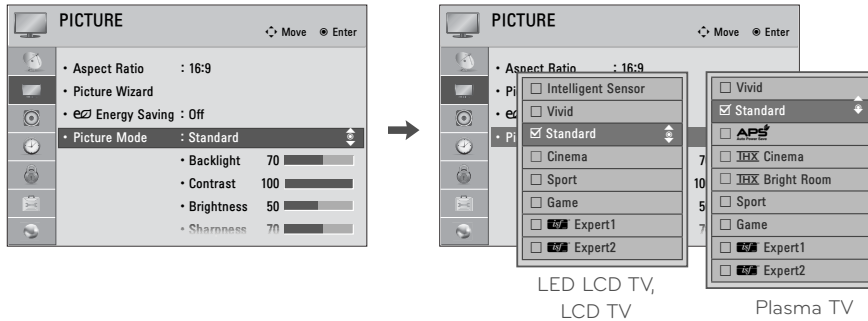

1 Select **PICTURE**.

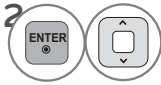

2 Select **Picture Mode**.



3 Select your desired options.



4 Return to the previous menu.



Return to TV viewing.

- **Vivid, Standard, Cinema, Sport, and Game** Settings are preset for the optimum picture quality at the factory.
- **Vivid**: This is the mode to maximize the effect of the video in the retail store. Strengthen the contrast, brightness, color and sharpness for vivid picture.
- **Standard**: This is the mode to realize optimum viewing condition for the general user.
- **APS (Auto Power Saving)**: This is the mode to maximize reducing the power consumption without hurting the picture quality. This feature is available only on Plasma TV.
- **Cinema**: This mode optimizes video for watching movies.
- **THX Cinema**: This is cinema quality mode to provide you the experience of watching a movie at home.
When selecting **THX Cinema**, Aspect ratio changes to Just scan.
- **THX Bright Room**: This is the specification to optimize TV viewing in Bright Room.
When selecting **THX Bright Room**, Aspect ratio changes to Just scan.

- **Sport**: This is the video mode to emphasize dynamic video and primary color (e.g, white, uniform, grass, sky blue etc.) by realizing the optimal screen for sports.
- **Game**: This is the mode to realize fast response speed in a fast gaming screen.
- **Expert**: This is the mode to adjust the video in detail for video quality expert and general user.
- You can also adjust **Picture Mode** in the **Q.MENU**.
- When selecting **Intelligent Sensor**, **Energy Saving** is changed to **Auto** automatically (For LED LCD TV/LCD TV).
- When selecting **Intelligent Sensor**, it changes Backlight, contrast, brightness, sharpness, color and tint automatically (For LED LCD TV/LCD TV).
- **Intelligent Sensor**: The most suitable picture is automatically adjusted according to the surrounding conditions.









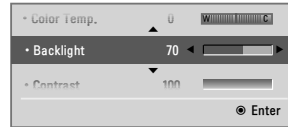
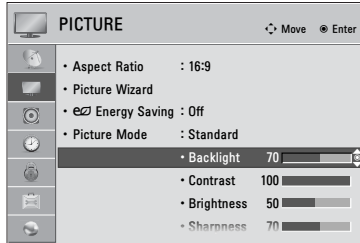



- When selecting **Intelligent Sensor**, **Energy Saving** is changed to **Auto** automatically.
- When selecting **Intelligent Sensor**, it is changed Backlight, contrast, brightness, sharpness, color, color Temp. and tint automatically.
- **Intelligent Sensor**: The most suitable picture is automatically adjusted according to the surrounding conditions.

PICTURE CONTROL

MANUAL PICTURE ADJUSTMENT - USER MODE

Adjust the picture appearance to suit your preference and viewing situations.











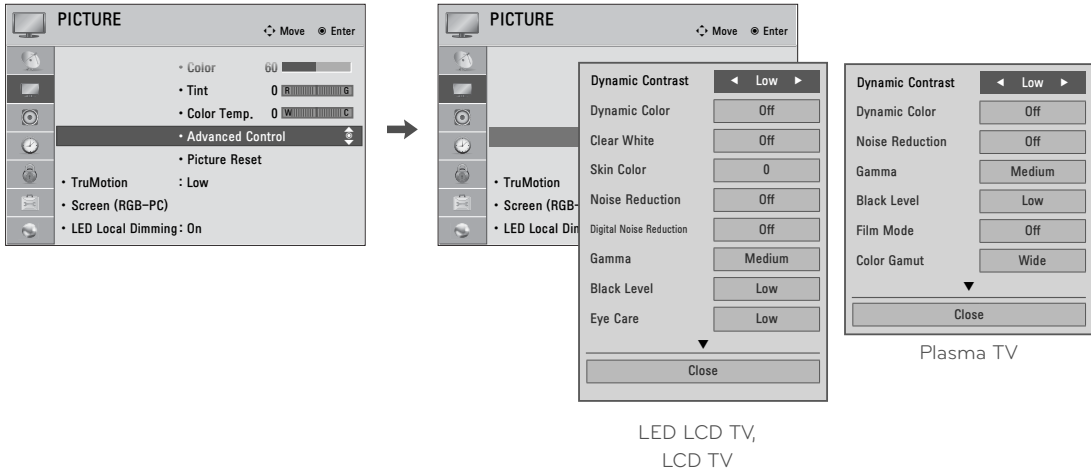

- 1   Select **PICTURE**.
- 2   Select **Picture Mode**.
- 3   Select your desired options.
- 4   Select **Backlight, Contrast, Brightness, Sharpness, Color, Tint, Color Temp., or Advanced Control**.
- 5   Make appropriate adjustments.
- 6  Return to the previous menu.
-  Return to TV viewing.

- **Backlight** (For LED LCD TV/LCD TV): This function adjusts the brightness of LCD panel, to control the brightness of the screen. Adjusting the backlight is recommended when setting the brightness of the set. When decreasing the backlight, the brightness of the black becomes darker without any loss in video signal and the power consumption is reduced.
- **Backlight** can only be adjusted in "**Energy Saving - Off, Minimum, or Medium**".
- **Contrast**: Increase or decrease the gradient of the video signal. You may use Contrast when the bright part of the picture is saturated.
- **Brightness**: Adjusts the base level of the signal in the picture. You may use Brightness when the dark part of the picture is saturated.
- **Sharpness**: Adjusts the level of crispness in the edges between the light and dark areas of the picture. The lower the level, the softer the image.
- **Color**: Adjusts intensity of all colors.
- **Tint**: Adjusts the balance between red and green levels.
- **Color Temp.**: Set to warm to enhance hotter colors such as red, or set to cool to enhance cooler colors such as blue.

PICTURE IMPROVEMENT TECHNOLOGY (ADVANCED CONTROL)

Advanced Control allows you to adjust some of the advanced features of your LG display. To reset to the factory default after making adjustments to each input source, execute the **Picture Reset** function for each Picture Mode.











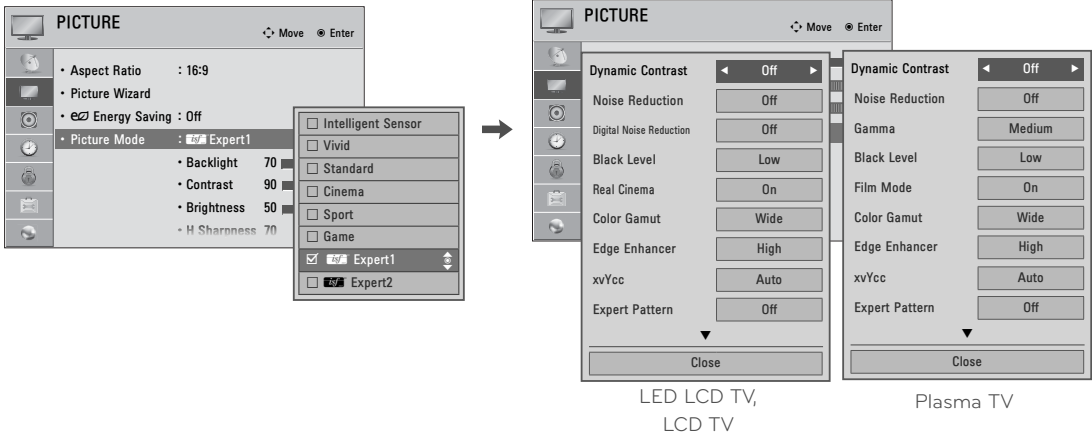





- 1   Select **PICTURE**.
- 2   Select **Advanced Control**.
- 3   Select your desired options.
- 4  Make appropriate adjustments.
- 5  Return to the previous menu.
-  Return to TV viewing.

PICTURE CONTROL

EXPERT PICTURE CONTROL

isf Expert1 and **isf** Expert2 provide even more advanced picture settings for users. Typical used by professionals for calibrating the TV.



-   Select **PICTURE**.
-   Select **Picture Mode**.
-   Select **isf** Expert1 or **isf** Expert2.
-   Select **Expert Control**.
-   Select your desired menu option.
-  Make appropriate adjustments.
-  Return to the previous menu.
-  Return to TV viewing.

*This feature is not available for all models.

Dynamic Contrast	<ul style="list-style-type: none"> Adjusts the contrast to keep it at the best level according to the brightness of the screen. The picture is improved by making bright parts brighter and dark parts darker.
Dynamic Color	<ul style="list-style-type: none"> Adjusts screen colors so that they look livelier, richer and clearer. This feature enhances hue, saturation and luminance so that red, blue, green and white look more vivid.
Clear White	<ul style="list-style-type: none"> Make the white area of screen brighter and more white.
Skin Color	<ul style="list-style-type: none"> It detects the skin area of video and adjusts it to express a natural skin color.
Noise Reduction	<ul style="list-style-type: none"> Reduces screen noise without compromising video quality.
Digital Noise Reduction	<ul style="list-style-type: none"> Removes noise caused by compressing video.
Gamma	<ul style="list-style-type: none"> You can adjust brightness of dark areas and middle gray level areas of the picture. <p>Low : Make brighter and middle gray level areas of the picture brighter. Medium : Express original picture levels. High: Make dark and middle gray level areas of the picture darker.</p>
Black Level	<p>Low: The reflection of the screen gets darker. High: The reflection of the screen gets brighter.</p> <ul style="list-style-type: none"> Set black level of the screen to proper level. This function is available in the following modes: AV (NTSC-M), HDMI or Component.
Eye Care	<ul style="list-style-type: none"> Adjust the brightness of the screen to prevent the screen from being too bright. Dims extremely bright pictures. This feature is enabled in "Picture Mode-Standard, Sports, Game".
Real Cinema	<ul style="list-style-type: none"> Makes video clips recorded in film look more natural by eliminating judder effect. DVD and Blu-ray movies are filmed at 24 frames per second (fps). With LG Real Cinema, every frame is consistently processed 5 times in 1/24 of a second producing 120 fps with TruMotion or 2 times in 1/24 of a second producing 48 fps without TruMotion, thus totally eliminating the judder effect. This function can also work when TruMotion is off.
Color Gamut	<p>LED LCD TV/LCD TV: Advanced Control Plasma TV: Advanced Control, Expert Control</p> <p>Standard: Displays standard set of colors. Wide: Increase number of colors used.</p> <ul style="list-style-type: none"> Maximize the utilization of color to increase color quality. <p>LED LCD TV/LCD TV: Expert Control</p> <ul style="list-style-type: none"> Displays color domain of the signal. <p>Standard: Displays standard set of colors. Wide: Increase number of colors used. EBU: Mode to display EBU standard color area. SMPTE: Mode to display SMPTE standard color area. BT709: Mode to display BT709 standard color area.</p>







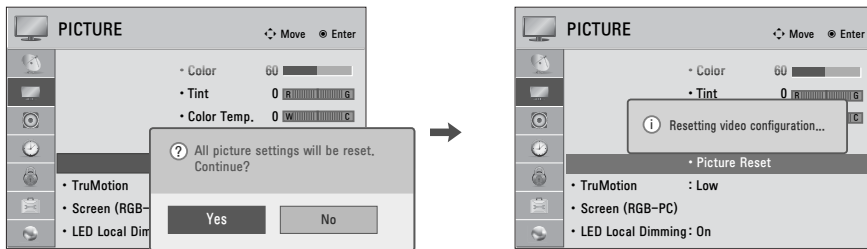

PICTURE CONTROL

Edge Enhancer	<ul style="list-style-type: none"> ■ Show clearer and distinctive yet natural edges in the video. ■ This function is enabled in "Picture mode - Expert".
xvYCC	<ul style="list-style-type: none"> ■ This is the function to express richer color. ■ This feature represents rich color as much as conventional video signal. ■ This function is enabled in "Picture mode - Cinema / THX Cinema / THX Bright Room, ISF Expert" when a xvYCC signal is inputted through HDMI.
Color Filter	<ul style="list-style-type: none"> ■ This is the function to filter the specific colors of the video. You can use the RGB filter to set color saturation and hue accurately. ■ This function is enabled in "Picture mode - Expert".
Expert Pattern	<ul style="list-style-type: none"> ■ This is a pattern used for expert adjustment. ■ This function is enabled in "Picture mode - Expert" when you watch DTV. (For 32/42/47/55LE5500-DA, 42/47LE8500-DA, 32/42/47/55LD650-DA, 42/47LX6500-DD)
Color Temperature	<ul style="list-style-type: none"> ■ Adjusts the overall color of the screen by changing the white baseline. <ol style="list-style-type: none"> a. Gamma : Select 1.9, 2.2, 2.4 b. Method : 2 Points <ul style="list-style-type: none"> - Pattern: Inner, Outer - Red/Green/Blue Contrast, Red/Green/Blue Brightness: The adjustment range is -50 - +50. c. Method : 10 Point IRE (LED LCD TV, LCD TV) <ul style="list-style-type: none"> - Pattern: Inner, Outer - IRE (Institute of Radio Engineers) is the unit to display the size of the video signal and can be set among 10, 20, 30 - 100. You can adjust Red, Green or Blue according to each setting. - Luminance: This function displays calculated luminance value for 2.2 gamma. You can input luminance value you want at 100 IRE, then the target luminance value for 2.2 gamma is displayed at every 10 steps from 10 IRE to 90 IRE. - Red/Green/Blue: The adjustment range is -50 - +50. c-2. Method : 20 Point IRE (Plasma TV) <ul style="list-style-type: none"> - IRE (Institute of Radio Engineers) is the unit to display the size of the video signal and can be set among 0, 5, 10, 15 - 100. You can adjust Red, Green or Blue according to each setting. - Red/Green/Blue: The adjustment range is -50 - +50. d. Apply to all inputs
Color Management System	<ul style="list-style-type: none"> ■ A tool used by the experts to make adjustments by using the test patterns, this does not affect other colors but can be used to selectively adjust the 6 color areas (Red/Green/Blue/Cyan/Mgt/Yellow). Color difference may not be distinctive even when you make the adjustments for the general video. Adjusts Red/Green/Blue/Yellow/Cyan, Magenta. <ul style="list-style-type: none"> - Red/Green/Blue/Yellow/Cyan/Magenta Color: The adjustment range is -30 - +30. - Red/Green/Blue/Yellow/Cyan/Magenta Tint: The adjustment range is -30 - +30. - This feature is disabled in RGB-PC and HDMI-PC mode.

PICTURE RESET

Settings of the selected picture modes return to the default factory settings.









- 1   Select **PICTURE**.
- 2   Select **Picture Reset**.
- 3   Select **Yes**.
- 4  Initialize the adjusted value.
-  Return to TV viewing.

PICTURE CONTROL





TRUMOTION- For LED LCD TV, LCD TV

Advance panel provides clearer, smoother images, even during fast action scenes creating a more stable structure for a crisper picture.



- 1   Select **PICTURE**.
- 2   Select **TruMotion**.
- 3   Select **Low, High, User, or Off**.

Adjustment for TruMotion (Judder and Blur) with selecting User

- 4   Select **Judder** or **Blur**.
- 5  Make appropriate adjustments.
- 6  Return to the previous menu.
-  Return to TV viewing.

- **Off**: Turn off **TruMotion** operation.
- **Low**: Provides smooth picture movement. Use this setting for standard use.
- **High**: Provides smoother picture movement.
- **Judder**: Adjusts noise of the screen.
- **Blur**: Adjusts after-image of the screen.
- **TruMotion** works with all inputs except PC mode.
- If you enable "**TruMotion**", noise may appear on the screen. If this occurs, set "**TruMotion**" to "**Off**".
- If you select "**Picture Mode-Game**" set "**TruMotion**" to "**Off**".

LED LOCAL DIMMING

- For 42/47/55LE5500, 42/47/55LE7500, 42/47LE8500, 42/47LX6500

After analyzing the signal of the input video by areas of the screen, it adjusts the backlight to improve the contrast ratio. This feature is disabled in "Picture Mode-Game".

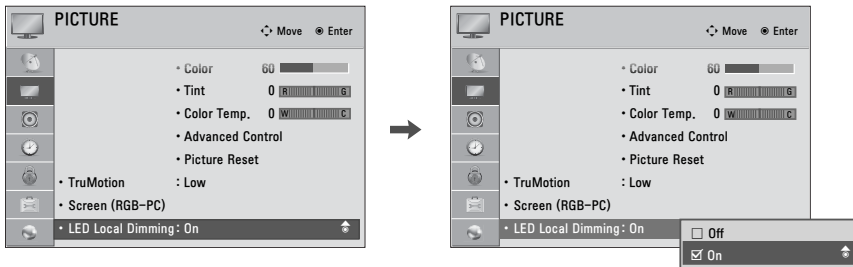

- 1 Select **PICTURE**.
- 2 Select **LED Local Dimming**.
- 3 Select **On** or **Off**.
- 4 Return to the previous menu.
- Return to TV viewing.

POWER INDICATOR - For LED LCD TV, LCD TV

Adjust the power/standby indicator light on the front of the TV.

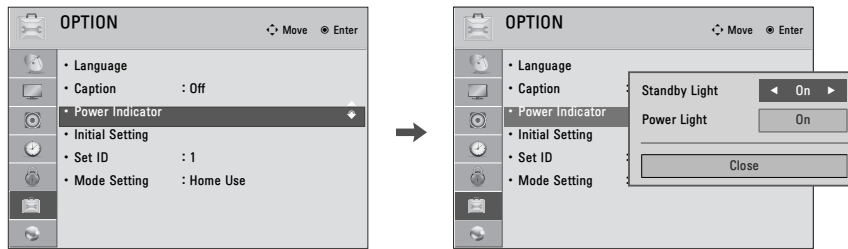

- 1 Select **OPTION**.
- 2 Select **Power Indicator**.
- 3 Select **Standby Light** or **Power Light**.
- 4 Select your desired options.
- 5 Return to the previous menu.
- Return to TV viewing.





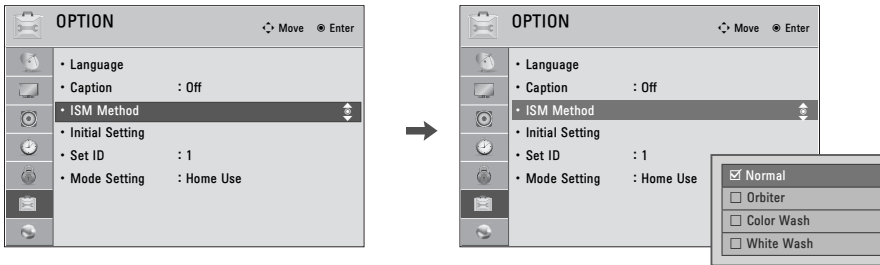

- **Standby Light:** Determines whether to set the indicator light on the front of the TV to **On** or **Off** in standby mode.
- **Power Light:** Determines whether to set the indicator light on the front of the TV to **On** or **Off** when the power turns on.

PICTURE CONTROL

IMAGE STICKING MINIMIZATION (ISM) METHOD - For Plasma TV

A frozen still picture displayed on the screen for prolonged periods can result in a ghost image. You can use Orbiter to help prevent image sticking. The other two functions are for removing a ghost image.



-   Select **OPTION**.
-   Select **ISM Method**.
-   Select **Normal, Orbiter, Color Wash,** or **White Wash**.
-  Return to TV viewing.

- **Normal:** If image sticking is never a problem, ISM is not necessary - set to Normal.
- **Orbiter:** To avoid a ghost image on the screen, the image will move every 2 minutes to help prevent ghost images. However, it is best not to allow any fixed image to remain on the screen.
- **Color Wash:** The color block with the screen moved a little and the white pattern are alternately displayed. It is difficult to see the after image on all colors.
Once it has been corrected it will not be visible in any color.
- **White Wash:** White Wash removes ghost images from the screen. Use sparingly. Watch the TV normally for a while before using this feature to see if the ghost image disappears on its own.

NOTE

- ▶ An excessive ghosted image may be impossible to clear entirely with White Wash. To return to normal viewing, press the any button.

SOUND & LANGUAGE CONTROL

AUTO VOLUME

Auto Volume makes sure that the volume level remains consistent whether you are watching a commercial or a regular TV program.

Because each broadcasting station has its own signal conditions, volume adjustment may be needed every time the channel is changed. This feature allows users to enjoy stable volume levels by making automatic adjustments for each program.

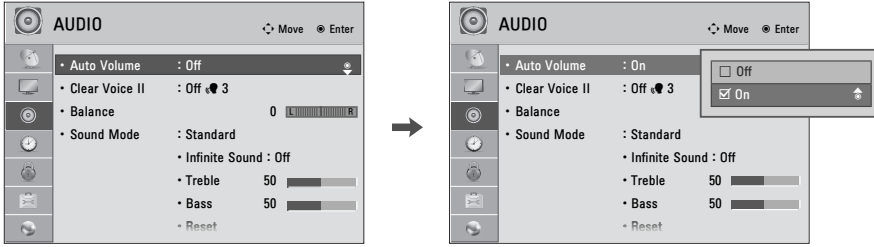

-   Select **AUDIO**.
-   Select **Auto Volume**.
-   Select **On** or **Off**.
-  Return to the previous menu.
-  Return to TV viewing.

SOUND & LANGUAGE CONTROL



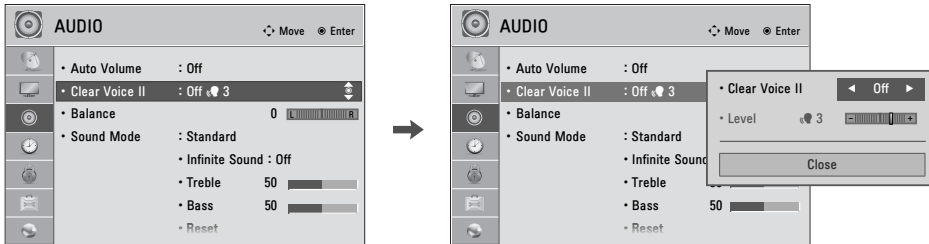

CLEAR VOICE II

By differentiating the human sound range from others, it improves the sound quality of voices.



- 1   Select **AUDIO**.
- 2   Select **Clear Voice II**.
- 3   Select **On** or **Off**.







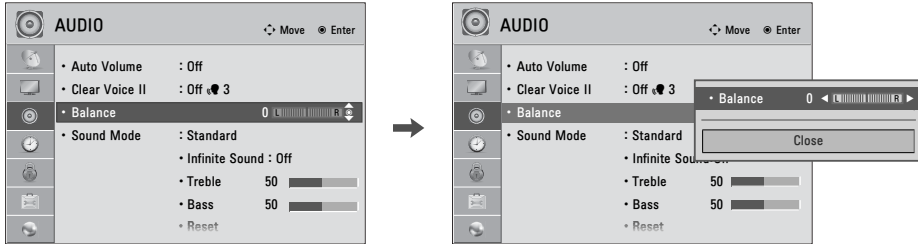

Adjustment for Clear Voice Level with selecting **On**

- 4  Select **Level**.
- 5   Make appropriate adjustments.
- 6  Return to the previous menu.
-  Return to TV viewing.

BALANCE

Adjust the left/right sound of speaker to suit your taste and room situations.









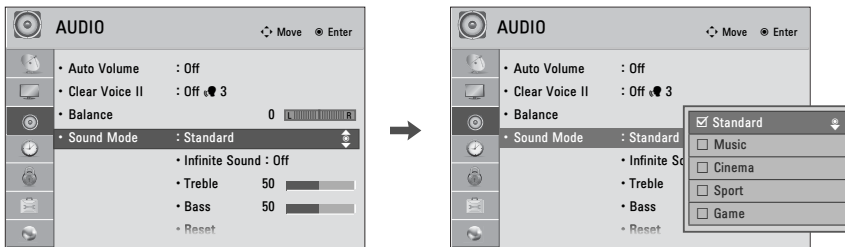

-   Select **AUDIO**.
-   Select **Balance**.
-   Make appropriate adjustments.
-  Return to the previous menu.
-  Return to TV viewing.

SOUND & LANGUAGE CONTROL

PRESET SOUND SETTINGS (SOUND MODE)

Sound Mode lets you enjoy the best sound without any special adjustment using factory presets.











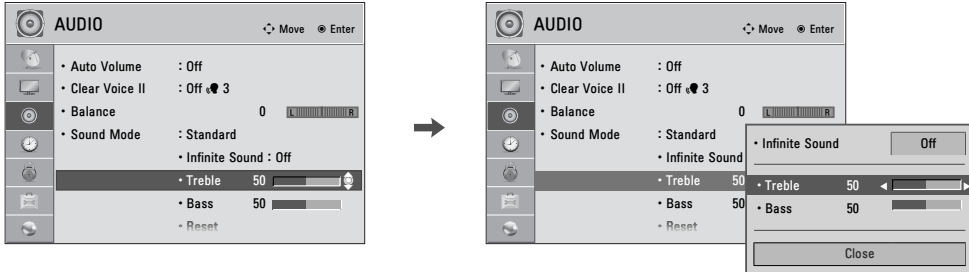



-   Select **AUDIO**.
-   Select **Sound Mode**.
-   Select **Standard, Music, Cinema, Sport, or Game**.
-  Return to the previous menu.
-  Return to TV viewing.

- **Standard, Music, Cinema, Sport, and Game** are preset for optimum sound quality at the factory.
- You can also adjust **Sound Mode** in the **Q.MENU**.
- **Standard**: Offers standard-quality sound.
- **Music**: Optimizes sound for listening to music.
- **Cinema**: Optimizes sound for watching movies.
- **Sport**: Optimizes sound for watching sports events.
- **Game**: Optimizes sound for playing games.

SOUND SETTING ADJUSTMENT - USER MODE

Adjust the sound to suit your taste and room situations.



-   Select **AUDIO**.
-   Select **Sound Mode**.
-   Select **Standard, Music, Cinema, Sport, or Game**.
-   Select **Infinite Sound, Treble, or Bass**.
-   Make appropriate adjustments.
-  Return to the previous menu.
-  Return to TV viewing.

- If sound quality or volume is not at the level you want, it is recommended to use a separate home theater system or amp to cope with different user environments.
- If you select "**Clear Voice II-On**", the **Infinite Sound** feature will not operate.
- **Infinite Sound**: Infinite Sound is a patented LG technology that solves the problem of playing 5.1 multi-channel content over two speakers.

SOUND & LANGUAGE CONTROL

AUDIO RESET

Settings of the selected Sound Mode return to the default factory settings.

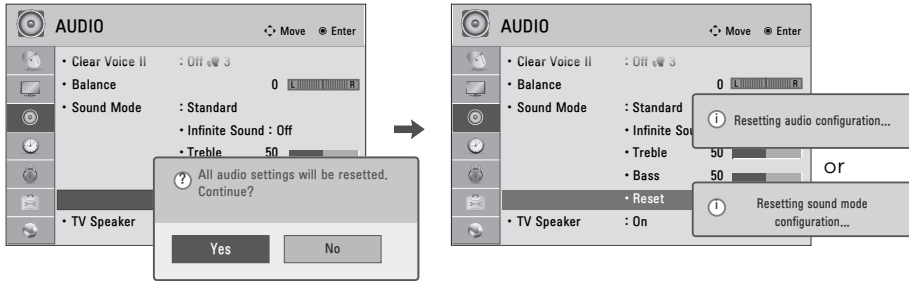

- 1 Select **AUDIO**.
- 2 Select **Reset**.
- 3 Select **Yes**.

- 4 Initialize the adjusted value.
- 5 Return to TV viewing.

TV SPEAKERS ON/OFF SETUP

If you wish to use an external Hi-Fi system, turn off the TV's internal speakers.

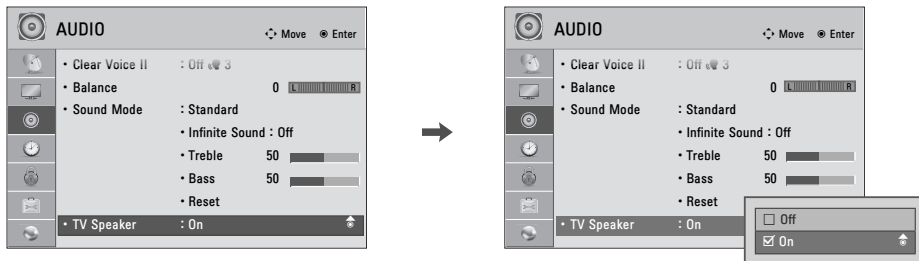

- 1 Select **AUDIO**.
- 2 Select **TV Speaker**.
- 3 Select **On** or **Off**.

- 4 Return to the previous menu.
- Return to TV viewing.

DIGITAL AUDIO OUT (For 32/42/47/55LE5500-DA, 42/47LE8500-DA, 32/42/47/55LD650-DA, 42/47LX6500-DD)

This function is setting the Dolby digital/PCM to connect the audio outputs.

If you select "Digital Audio Out - Auto" when Dolby digital is available, SPDIF (Sony Philips Digital InterFace) output will be Dolby Digital.

If you select "Digital Audio Out - Auto" when Dolby digital is not available, SPDIF output will be PCM (Pulsecode modulation).

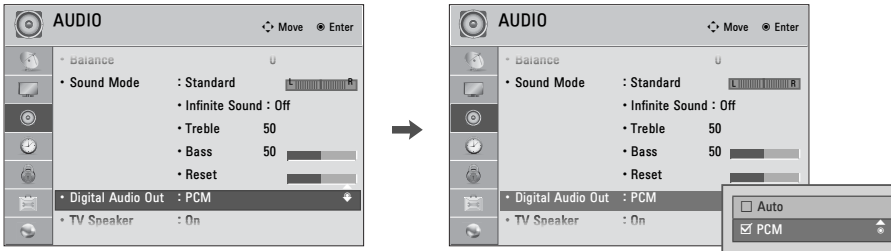

- 1 Select **AUDIO**.
- 2 Select **Digital Audio Out**.
- 3 Select **Auto** or **PCM**.
- 4 Return to the previous menu.
- Return to TV viewing.

Item	Audio Input	Digital Audio output
Auto (Speaker On)	MPEG	PCM
	DD	DD
	DD+	DD
	HE-AAC	PCM
Auto (Speaker Off)	MPEG	PCM
	DD	DD
	DD+	DD
	HE-AAC	DD
PCM	All	PCM

To set "SPDIF OUT - Dolby Digital" in DTV input signal, select "Digital Audio Out - Auto" and "TV Speaker - Off".

SOUND & LANGUAGE CONTROL

STEREO/SAP BROADCAST SETUP

On analog signals, this TV can receive MTS stereo programs and any SAP (Secondary Audio Program) that accompanies the stereo program if the station transmits an additional sound signal. Mono sound is automatically used if the broadcast is only in Mono.

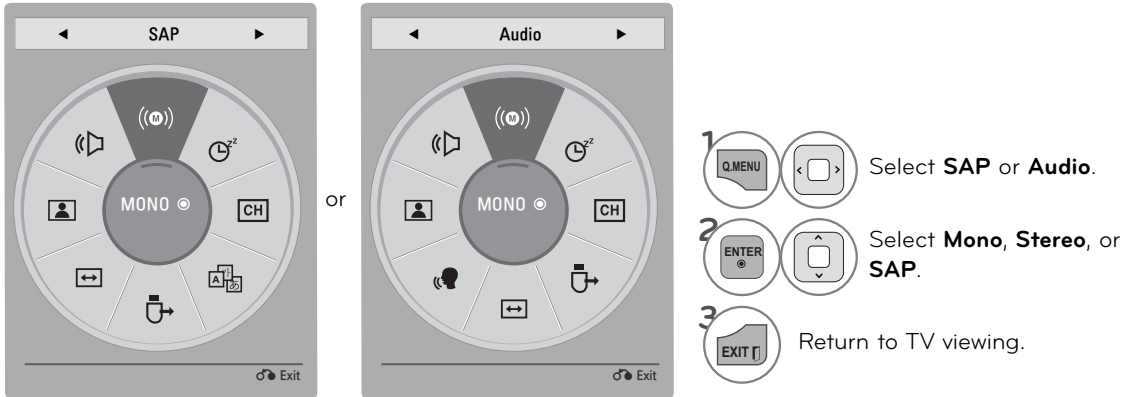

DTV AUDIO SETTING (For 32/42/47/55LE5500-DA, 42/47LE8500-DA, 32/42/47/55LD650-DA, 42/47LX6500-DD)

When different audio types exist in an input signal, this function allows you to select the audio type you want.

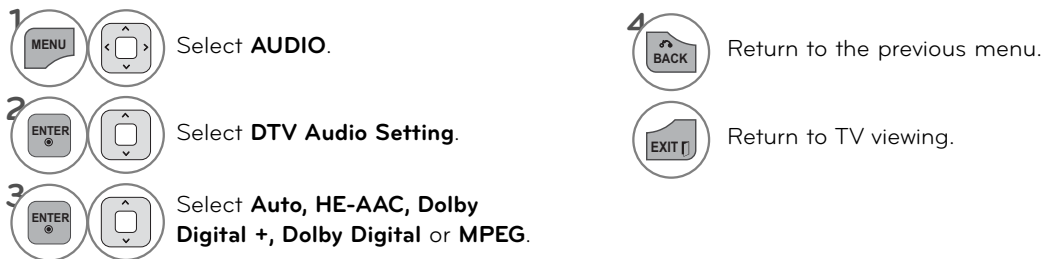
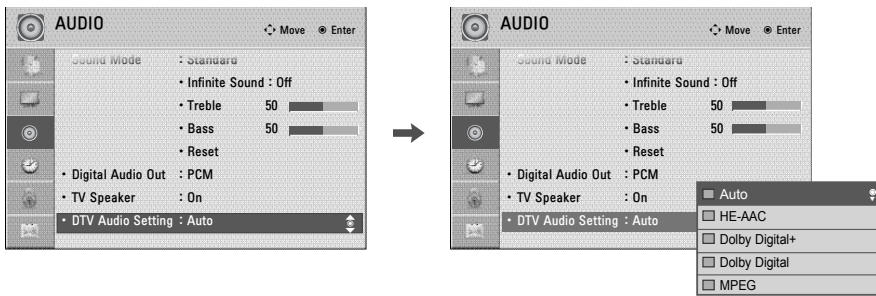

- **Auto**: Automatically outputs in the order **HE-AAC > Dolby Digital+ > Dolby Digital > MPEG**.
- **HE-AAC, Dolby Digital+, Dolby Digital, MPEG**: Allows users to select the audio type they want.
 ex) If **MPEG** is selected, **MPEG** is always outputted.
 If **MPEG** is not supported, **Dolby Digital** are selected in that order.

ON-SCREEN MENUS LANGUAGE SELECTION

The menus can be shown on the screen in the selected language.

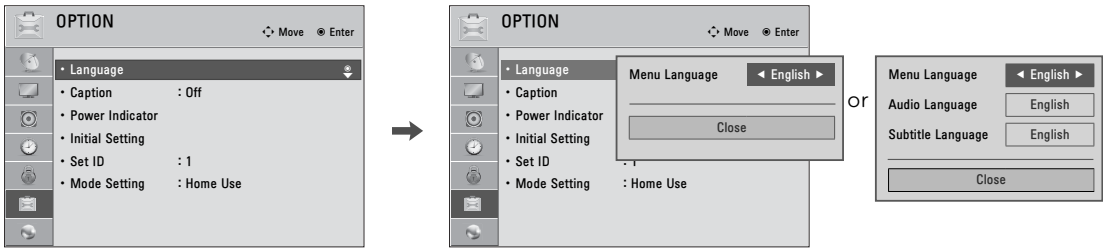

- 1 Select **OPTION**.
- 2 Select **Language**.
- 3 Select **Menu Language**.
- 4 Select your desired language.
From this point on, the on-screen menus will be shown in the selected language.
- 5 Return to the previous menu.
- Return to TV viewing.

CAPTION MODE/ SUBTITLE MODE

Captions are provided to help the hearing impaired watch TV. Select a caption mode for displaying captioning information if provided on a program. Analog caption displays information at any position on the screen and is usually the program's dialog. Caption/Text, if provided by the broadcaster, would be available for both digital and analog channels on the Antenna/Cable. This TV is programmed to memorize the caption/text mode which was last set when you turned the power off. This function is only available when **Caption Mode** is set **On**.

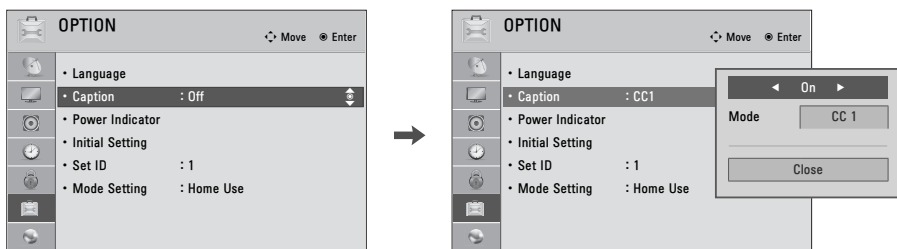

- 1 Select **OPTION**.
- 2 Select **Caption** or **Subtitle**.
- 3 Select **On**.
- 4 Select **Mode**.
- 5 Select **CC1-2** or **Text1-2**.
- 6 Return to the previous menu.
- Return to TV viewing.

SOUND & LANGUAGE CONTROL

LANGUAGE SELECTION (For 32/42/47/55LE5500-DA, 42/47LE8500-DA, 32/42/47/55LD650-DA, 42/47LX6500-DD)

The Audio function allows selection of a preferred language.





If audio data in a selected language is not broadcast, the default language audio will be played.

Use the Subtitle function when two or more subtitle languages are broadcast. If subtitle data in a selected language is not broadcast, the default language subtitle will be displayed.





When the languages you selected as the primary for Audio Language and Subtitle Language are not supported, you can select language in secondary category.

Audio Language Selection

When two or more audio languages are broadcast, you can select the audio language.



- 1   Select **Audio**.
- 2   Select other languages.
- 3  Return to TV viewing.

Audio Language OSD Information

N.A	Not Available
	MPEG Audio
	Dolby Digital Audio
<input checked="" type="checkbox"/>	Audio for "Visual Impaired"
	Audio for "Hearing Impaired"
	Dolby Digital Plus Audio
	AAC Audio

Subtitle Language Selection

When two or more subtitle languages are broadcast, you can select the subtitle language.









- 1    Select a desired subtitle language.

Subtitle Language OSD Information

N.A	Not Available
	Subtitle for "Hard of Hearing"

- The audio/subtitles can be displayed in a simpler form with 1 to 3 characters broadcast by the service provider.
- When you select supplementary Audio (Audio for "Visual/Hearing Impaired") the TV may output a part of the Main audio.
- You can also adjust Language in the **OPTION MENU**.

Hard of Hearing







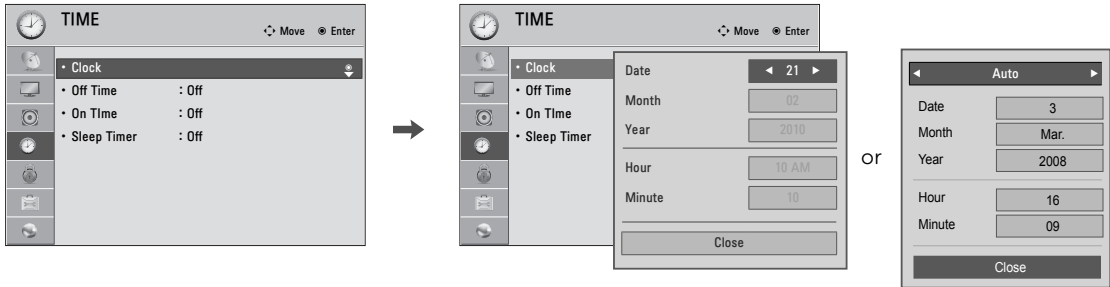

- 1   Select **OPTION**.
- 2   Select Hard of Hearing()
- 3   Select **On** or **Off**.
- 4  Return to the previous menu.

TIME SETTING

CLOCK SETTING

You must set the time correctly before using on/off timer function.



-   Select **TIME**.
-   Select **Clock**.
-   Select **Auto** or **Manual**.
-  Select the Date, Month, Year, Hour, or Minutes option.
-  Return to the previous menu.
-  Return to TV viewing.

TIME SETTING

ON/OFF TIME SETTING

This function operates only if the current time has been set.

The **Off Time** function overrides the **On Time** function if they are both set to the same time.

The TV must be in standby mode for the **On Time** to work.

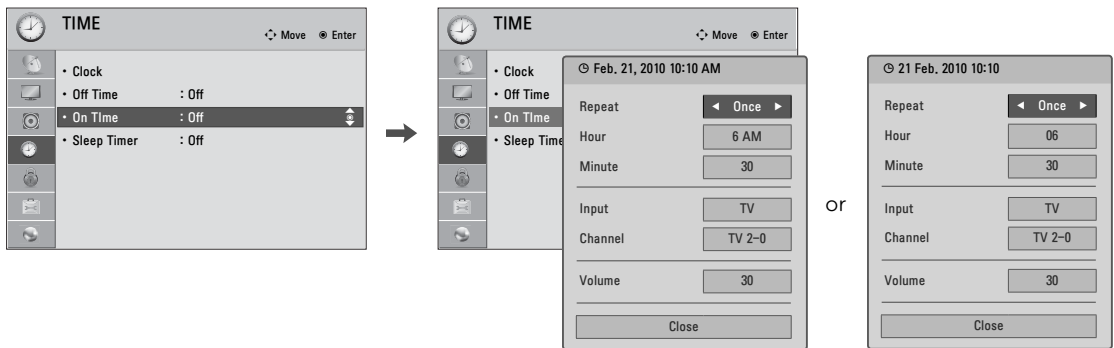

- 1 Select **TIME**.
- 2 Select **Off Time** or **On Time**.
- 3 Select **Repeat**.
- 4 Select **Off, Once, Daily, Mon.-Fri., Mon.-Sat., Sat.-Sun., or Sun..**
- 5 Select and set Hour or Minute.
- 6 Return to the previous menu.
- Return to TV viewing.







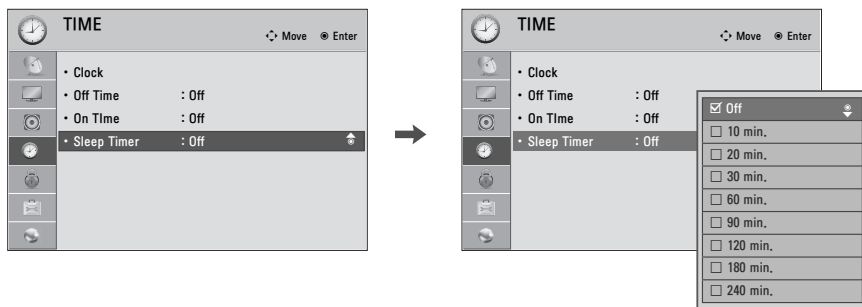

- To cancel **On/Off Time** function, select **Off**.
- Only for **On Time** function
 - 1 Select **Input**.
 - 2 Select the desired input source.
 - 3 When Selecting **TV**: set the channel at turn-on.
 - 4 Adjust to sound level at turn-on.

SLEEP TIMER SETTING

The Sleep Timer turns the TV off at the preset time.

Note that this setting is cleared when the TV is turned off.



-   Select **TIME**.
-   Select **Sleep Timer**.
-   Make appropriate adjustments.
-  Return to the previous menu.
-  Return to TV viewing.

- To cancel the **Sleep Timer**, select **Off**.
- You can also adjust **Sleep Timer** in the **Q.MENU**.

PARENTAL CONTROL





Parental Control can be used to block specific channels and other viewing sources.

SET PASSWORD & LOCK SYSTEM

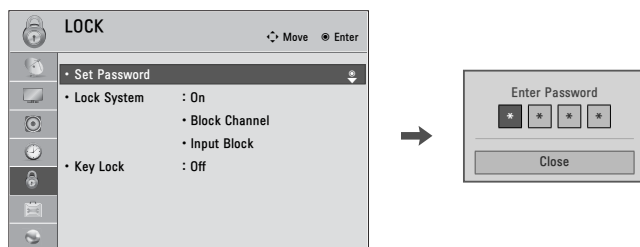
Setting up Your Password

Set up blocking schemes to block specific channels and external viewing sources. A password is required to gain access to this menu.



- 1    Select **LOCK**.
- 2  Input the password.

- Enter the password as requested.
- The TV is set up with the initial password "0-0-0-0".
- If you forget your password, press "0-3-2-5" on the remote control.

Set Password

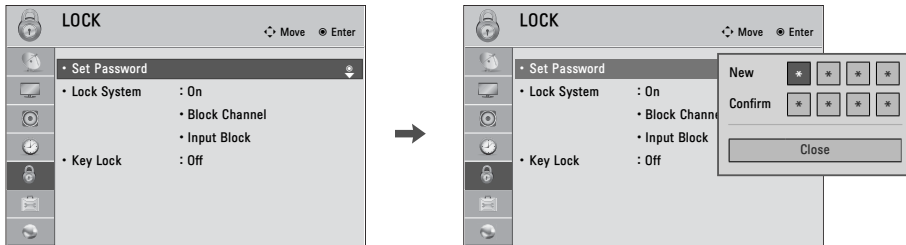

Change the password by inputting a new password twice.





1    Select **LOCK**.

2  Input the password.

3  Select **Set Password**.

4   Choose any 4 digits for your new password.
As soon as the 4 digits are entered, re-enter the same 4 digits on the **Confirm**.

5  Return to the previous menu.

 Return to TV viewing.

PARENTAL CONTROL

Lock System

Enables or disables the blocking scheme you set up previously.

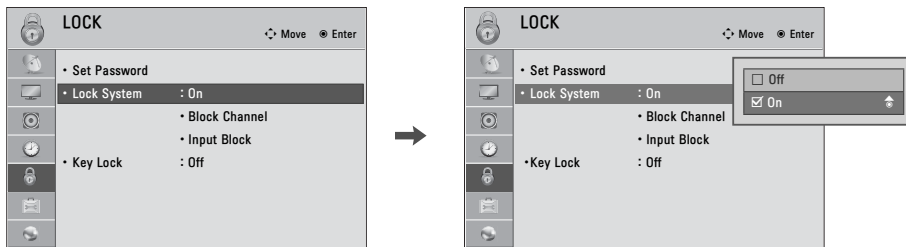



1    Select **LOCK**.

2  Input the password.

3  Select **Lock System**.

4   Select **On** or **Off**.

5  Return to the previous menu.

 Return to TV viewing.

■ When you select **On**, the Lock System is enable.

CHANNEL BLOCKING

Blocks any channels that you do not want to watch or that you do not want your children to watch.

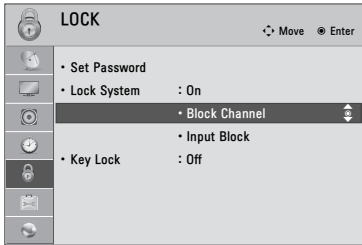

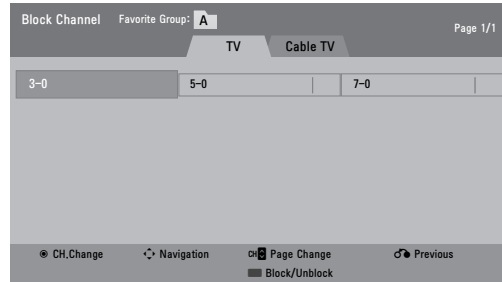

ie.)





1    Select **LOCK**.

2  Input the password.

3  Select **Block Channel**.

4   Select a channel to block or unblock.

5  Block or unblock a channel.

6  Return to the previous menu.

 Return to TV viewing.









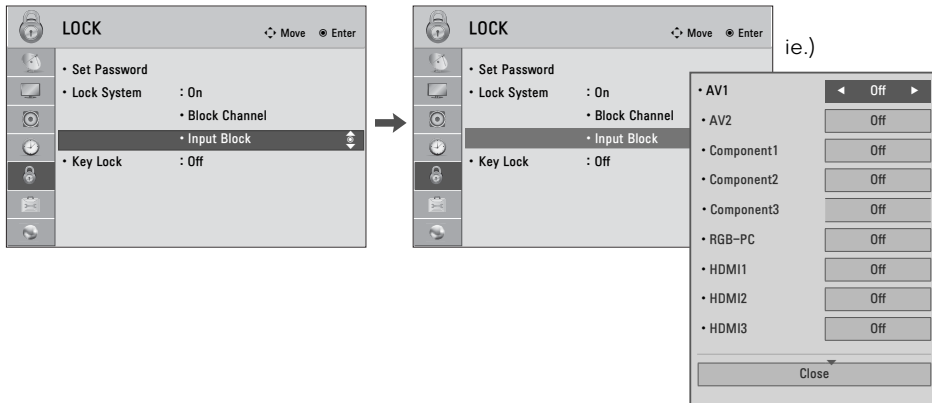

■ If a channel is locked, enter the password to unlock it temporarily.

PARENTAL CONTROL

EXTERNAL INPUT BLOCKING

Enables you to block an input.





-    Select **LOCK**.
-  Input the password.
-  Select **Input Block**.
-   Select input source.
-  Select **On** or **Off**.
-  Return to the previous menu.
-  Return to TV viewing.

KEY LOCK

This feature can be used to prevent unauthorized viewing by locking out the front panel controls, so that it can only be used with the remote control.

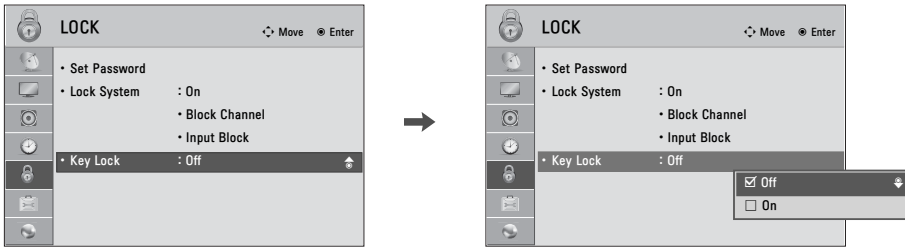
This TV is programmed to remember which option it was last set to even if you turn the TV off.





1    Select **LOCK**.









2  Input the password.

3  Select **Key Lock**.

4   Select **On** or **Off**.

5  Return to the previous menu.

 Return to TV viewing.

- In Key Lock '**On**', if the TV is turned off, press the  / I, INPUT, CH (  or  ) button on the TV or POWER, INPUT, CH ( ) or NUMBER buttons on the remote control.
- With the **Key Lock On**, the display ' **Key Lock**' appears on the screen if any button on the front panel is pressed while viewing the TV.

APPENDIX

TROUBLESHOOTING

Abnormal Operation	
The remote control doesn't work	<ul style="list-style-type: none"> ■ Check to see if there is any object between the product and the remote control causing obstruction. Ensure you are pointing the remote control directly at the TV. ■ Ensure that the batteries are installed with correct polarity (+ to +, - to -). ■ Ensure that the correct remote operating mode is set: TV, VCR etc. ■ Install new batteries. *This feature is not available for all models.
Power is suddenly turned off	<ul style="list-style-type: none"> ■ Is the sleep timer set? ■ Check the power control settings. Power interrupted. ■ If there is no signal, the TV turns off automatically in 15 minutes.

Video Problems	
No picture & No sound	<ul style="list-style-type: none"> ■ Check whether the product is turned on. ■ Try another channel. The problem may be with the broadcast. ■ Is the power cord inserted into wall power outlet? ■ Check your antenna direction and/or location. ■ Test the wall power outlet, plug another product's power cord into the outlet where the product's power cord was plugged in.
Picture appears slowly after switching on	<ul style="list-style-type: none"> ■ This is normal, the image is muted during the product startup process. Please contact your service center, if the picture has not appeared after five minutes.
No or poor color or poor picture	<ul style="list-style-type: none"> ■ Adjust Color in menu option. ■ Keep a sufficient distance between the product and the VCR. ■ Try another channel. The problem may be with the broadcast. ■ Are the video cables installed properly? ■ Activate any function to restore the brightness of the picture.
Horizontal/vertical bars or picture shaking	<ul style="list-style-type: none"> ■ Check for local interference such as an electrical appliance or power tool.
Poor reception on some channels	<ul style="list-style-type: none"> ■ Station or cable product experiencing problems, tune to another station. ■ Station signal is weak, reorient antenna to receive weaker station. ■ Check for sources of possible interference.
Lines or streaks in pictures	<ul style="list-style-type: none"> ■ Check antenna (Change the direction of the antenna).
No picture when connecting HDMI	<ul style="list-style-type: none"> ■ If the HDMI cables don't support High Speed HDMI, it can cause flickers or no screen display. In this case use the latest cables that support High Speed HDMI

Audio Problems	
Picture OK & No sound	<ul style="list-style-type: none"> ■ Check to see if there is any object between the product and the remote control causing obstruction. Ensure you are pointing the remote control directly at the TV. ■ Ensure that the batteries are installed with correct polarity (+ to +, - to -). ■ Ensure that the correct remote operating mode is set: TV, VCR etc. ■ Install new batteries.
No output from one of the speakers	<ul style="list-style-type: none"> ■ Adjust Balance in menu option.
Unusual sound from inside the product	<ul style="list-style-type: none"> ■ A change in ambient humidity or temperature may result in an unusual noise when the product is turned on or off and does not indicate a fault with the product.
No sound when connecting HDMI/USB	<ul style="list-style-type: none"> ■ Check High Speed HDMI cable. ■ Check USB cable over version 2.0. ■ Use normal MP3 file. <p style="text-align: right;">*This feature is not available for all models.</p>

PC Mode Problems	
The signal is out of range	<ul style="list-style-type: none"> ■ Adjust resolution, horizontal frequency, or vertical frequency on the PC. ■ Check the input source.
Vertical bar or stripe on background & Horizontal Noise & Incorrect position	<ul style="list-style-type: none"> ■ Activate the Auto configure feature or adjust size, phase, or H/V position. (Option)
Screen color is unstable or single color	<ul style="list-style-type: none"> ■ Check the signal cable. ■ Reinstall the PC video card.
When connecting the HDMI cable to the PC, there is no audio.	<ul style="list-style-type: none"> ■ Check the manual for the video card in the PC to see if it supports HDMI audio and how to set it up properly.

APPENDIX

Movie List Problems	
The file does not appear on the Movie List.	<ul style="list-style-type: none">■ Check whether the extension is supported.
Message is displayed saying "This file is invalid" or the audio is working normally but the video is not working normally.	<ul style="list-style-type: none">■ Check whether the file is playing normally on a PC. (Check whether the file is damaged.)■ Check whether the resolution is supported.■ Check whether the video/audio codec is supported.■ Check whether the frame rate is supported.
Message is displayed saying "Unsupported Audio" or the video is working normally but the audio is not working normally.	<ul style="list-style-type: none">■ Check whether the file is playing normally on a PC. (Check whether the file is damaged.)■ Check whether the audio codec is supported.■ Check whether the bit rate is supported.■ Check whether the sample rate is supported.
Subtitle is not working.	<ul style="list-style-type: none">■ Check whether the file is playing normally on a PC. (Check whether the file is damaged.)■ Check whether the video file and subtitle file name are the same.■ Check whether the video file and subtitle file are located in the same folder.■ Check whether the subtitle file is supported.■ Check whether the language is supported. (When you open the subtitle file in Memo Pad, you can check the language of the subtitle file.)

MAINTENANCE

Early malfunctions can be prevented. Careful and regular cleaning can extend the amount of time you can enjoy your new TV.

Caution: Be sure to turn the power off and unplug the power cord before you begin any cleaning.

Cleaning the Screen

- 1 Here's a great way to keep the dust off your screen for a while. Wet a soft cloth in a mixture of lukewarm water and a little fabric softener or dish washing detergent. Wring the cloth until it's almost dry, and then use it to wipe the screen.
- 2 Make sure the excess water is off the screen, and then let it air-dry before you turn on your TV.

Cleaning the Cabinet

- To remove dirt or dust, wipe the cabinet with a soft, dry, lint-free cloth.
- Please be sure not to use a wet cloth.

Extended Absence

CAUTION

- ▶ If you expect to leave your TV dormant for a long time (such as a vacation), it's a good idea to unplug the power cord to protect against possible damage from lightning or power surges.

APPENDIX

PRODUCT SPECIFICATIONS

MODELS		32LD650 (32LD650-MA, 32LD650-DA)	42LD650 (42LD650-MA, 42LD650-DA)
Dimensions (Width x Height x Depth)	With stand	797.0 mm x 555.0 mm x 207.0 mm (31.3 inch x 21.8 inch x 8.1 inch)	1024.0 mm x 685.0 mm x 261.0 mm (40.3 inch x 26.9 inch x 10.2 inch)
	Without stand	797.0 mm x 495.0 mm x 73.8 mm (31.3 inch x 19.4 inch x 2.9 inch)	1024.0 mm x 621.0 mm x 76.8 mm (40.3 inch x 24.4 inch x 3.0 inch)
Weight	With stand	8.7 kg (19.1 lb)	15.5 kg (34.1 lb)
	Without stand	7.6 kg (16.7 lb)	13.9 kg (30.6 lb)
Current Value		1.5 A	2.1 A

MODELS		47LD650 (47LD650-MA, 47LD650-DA)	55LD650 (55LD650-MA, 55LD650-DA)
Dimensions (Width x Height x Depth)	With stand	1137.0 mm x 758.0 mm x 270.0 mm (44.7 inch x 29.8 inch x 10.6 inch)	1329.0 mm x 872.0 mm x 330.0 mm (52.3 inch x 34.3 inch x 12.9 inch)
	Without stand	1137.0 mm x 685.0 mm x 76.8 mm (44.7 inch x 26.9 inch x 3.0 inch)	1329.0 mm x 796.0 mm x 96.5 mm (52.3 inch x 31.3 inch x 3.7 inch)
Weight	With stand	20.3 kg (44.7 lb)	33.0 kg (72.7 lb)
	Without stand	18.3 kg (40.3 lb)	29.8 kg (65.6 lb)
Current Value		2.5 A	3.4 A

MODELS		32LE5500 (32LE5500-MA, 32LE5500-DA)	42LE5500 (42LE5500-MA, 42LE5500-DA, 42LE5500-MD)
Dimensions (Width x Height x Depth)	With stand	784.6 mm x 558.1 mm x 221.0 mm (30.8 inches x 21.9 inches x 8.7 inches)	1016.0 mm x 692.0 mm x 270.0 mm (40.0 inch x 27.2 inch x 10.6 inch)
	Without stand	784.6 mm x 499.5 mm x 39.9 mm (30.8 inches x 19.6 inches x 1.5 inches)	1016.0 mm x 630.0 mm x 29.3 mm (40.0 inch x 24.8 inch x 1.1 inch)
Weight	With stand	12.6 kg (27.7 lbs)	19.5 kg (42.9 lb)
	Without stand	10.5 kg (23.1 lbs)	16.7 kg (36.8 lb)
Current Value		1.3 A	1.5 A

MODELS		47LE5500 (47LE5500-MA, 47LE5500-DA)	55LE5500 (55LE5500-MA, 55LE5500-DA)
Dimensions (Width x Height x Depth)	With stand	1126.6 mm x 757.9 mm x 284.4 mm (44.3 inch x 29.8 inch x 11.1 inch)	1306.0 mm x 867.0 mm x 328.0 mm (51.4 inches x 34.1 inches x 12.9 inches)
	Without stand	1126.6 mm x 692.0 mm x 29.3 mm (44.3 inch x 27.2 inch x 1.1 inch)	1306.0 mm x 797.0 mm x 29.3 mm (51.4 inches x 31.3 inches x 1.1 inches)
Weight	With stand	22.9 kg (50.4 lb)	34.5 kg (76.0 lbs)
	Without stand	19.6 kg (43.2 lb)	28.8 kg (63.4 lbs)
Current Value		1.7 A	2.0 A

MODELS		50PK950R (50PK950R-MA)	60PK950R (60PK950R-MA)
Dimensions (Width x Height x Depth)	With stand	1190.0 mm x 804.5 mm x 294.5 mm (46.8 inch x 31.6 inch x 11.5 inch)	1408.8 mm x 937.9 mm x 384.0 mm (55.4 inch x 36.9 inch x 15.1 inch)
	Without stand	1190.0 mm x 737.0 mm x 52.4 mm (46.1 inch x 29.0 inch x 2.0 inch)	1408.8 mm x 860.7 mm x 52.4 mm (55.4 inch x 33.8 inch x 2.0 inch)
Weight	With stand	34.8 kg (76.7 lbs)	50.9 kg (112.2 lbs)
	Without stand	30.2 kg (66.5 lbs)	43.3 kg (95.4 lbs)
Current Value		3.9 A	4.5 A

■ The specifications shown above may be changed without prior notice for quality improvement.

MODELS		32LE7500 (32LE7500-MA)	42LE7500 (42LE7500-MA)
Dimensions (Width x Height x Depth)	With stand	786.4 mm x 557.6 mm x 221.0 mm (30.9 inch x 21.9 inch x 8.7 inch)	1018.2 mm x 693.5 mm x 269.8 mm (40.0 inch x 27.3 inch x 10.6 inch)
	Without stand	786.4 mm x 500.4 mm x 39.9 mm (30.9 inch x 19.7 inch x 1.5 inch)	1018.2 mm x 630.7 mm x 29.3 mm (40.0 inch x 24.8 inch x 1.1 inch)
Weight	With stand	13.9 kg (30.6 lb)	21.9 kg (48.2 lb)
	Without stand	11.7 kg (25.7 lb)	19.1 kg (42.1 lb)
Current Value		1.3 A	1.5 A

MODELS		47LE7500 (47LE7500-MA)	55LE7500 (55LE7500-MA)
Dimensions (Width x Height x Depth)	With stand	1128.6 mm x 758.9 mm x 284.4 mm (44.4 inch x 29.8 inch x 11.1 inch)	1306.0 mm x 869.0 mm x 328.0 mm (51.4 inch x 34.2 inch x 12.9 inch)
	Without stand	1128.6 mm x 693.3 mm x 29.8 mm (44.4 inch x 27.2 inch x 1.1 inch)	1306.0 mm x 797.4 mm x 31.2 mm (51.4 inch x 31.3 inch x 1.2 inch)
Weight	With stand	26.2 kg (57.7 lb)	39.1 kg (86.2 lb)
	Without stand	23.0 kg (50.7 lb)	33.5 kg (73.8 lb)
Current Value		1.7 A	2.0 A

MODELS		42LE8500 (42LE8500-MA, 42LE8500-DA)	47LE8500 (47LE8500-MA, 47LE8500-DA)
Dimensions (Width x Height x Depth)	With stand	1013.3 mm x 705.8 mm x 235.5 mm (39.8 inch x 27.7 inch x 9.2 inch)	1122.6 mm x 769.3 mm x 275.0 mm (44.1 inch x 30.2 inch x 10.8 inch)
	Without stand	1013.3 mm x 645.8 mm x 34.5 mm (39.8 inch x 25.4 inch x 1.3 inch)	1122.6 mm x 707.3 mm x 34.5 mm (44.1 inch x 27.8 inch x 1.3 inch)
Weight	With stand	27.2 kg (59.9 lbs)	31.6 kg (69.6 lbs)
	Without stand	23.1 kg (50.9 lbs)	26.9 kg (59.3 lbs)
Current Value		1.6 A	1.7 A

MODELS		42LX6500 (42LX6500-DD)	47LX6500 (47LX6500-DD)
Dimensions (Width x Height x Depth)	With stand	1016.0 mm x 692.0 mm x 270.0 mm (40.0 inch x 27.2 inch x 10.6 inch)	1126.6 mm x 757.9 mm x 284.4 mm (44.3 inch x 29.8 inch x 11.1 inch)
	Without stand	1016.0 mm x 630.0 mm x 29.3 mm (40.0 inch x 24.8 inch x 1.1 inch)	1126.6 mm x 692.0 mm x 29.3 mm (44.3 inch x 27.2 inch x 1.1 inch)
Weight	With stand	19.5 kg (42.9 lbs)	22.9 kg (50.4 lbs)
	Without stand	16.7 kg (36.8 lbs)	19.6 kg (43.2 lbs)
Current Value		1.6 A	1.8 A

■ The specifications shown above may be changed without prior notice for quality improvement.

APPENDIX

For 32/42/47/55LD650-MA, 32/42/47/55LE5500-MA, 32/42/47/55LE7500-MA,
50/60PK950R-MA, 42/47LE8500-MA

Power requirement		AC 100-240V ~ 50/60Hz
Television System		NTSC, PAL-M/N
Program Coverage		VHF 2-13, UHF 14-69, CATV 1-135
External Antenna Impedance		75 Ω
Environment condition	Operating Temperature	32 ~ 104°F (0 ~ 40°C)
	Operating Humidity	Less than 80%
	Storage Temperature	-4 ~ 140°F (-20 ~ 60°C)
	Storage Humidity	Less than 85%





For 32/42/47/55LE5500-DA, 32/42/47/55LD650-DA, 42/47LE8500-DA, 42/47LX6500-DD

Power requirement		AC 100-240V ~ 50/60Hz
Television System		Analog : NTSC-M, DTV : DVB-T
Program Coverage		VHF 2-13, UHF 14-69, CATV 1, 14-125, DTV 14-69
External Antenna Impedance		75 Ω
Environment condition	Operating Temperature	32 ~ 104°F (0 ~ 40°C)
	Operating Humidity	Less than 80%
	Storage Temperature	-4 ~ 140°F (-20 ~ 60°C)
	Storage Humidity	Less than 85%

- The specifications shown above may be changed without prior notice for quality improvement.

IR CODES

*This feature is not available for all models.

Code (Hexa)	Function	Note	Code (Hexa)	Function	Note
08		Remote control Button (Power On/Off)	7E	SIMPLINK	Remote control Button
45	Q.MENU	Remote control Button	30	AV MODE	Remote control Button
43	MENU	Remote control Button	59	NETCAST	Remote control Button
0B	INPUT	Remote control Button	0F	TV	Remote control Button
10-19	Number Key 0-9	Remote control Button	5B	EXIT	Remote control Button
53	LIST	Remote control Button	72	RED	Remote control Button
1A	Q.VIEW	Remote control Button	71	GREEN	Remote control Button
09	MUTE/DELETE	Remote control Button	63	YELLOW	Remote control Button
02	VOL +	Remote control Button	61	BLUE, L/R SELECT	Remote control Button
03	VOL -	Remote control Button	95	ENERGY SAVING	Remote control Button
00	CH ^	Remote control Button	B1		Remote control Button
01	CH v	Remote control Button	B0		Remote control Button
1E	MARK/ FAV/ CHAR/NUM	Remote control Button	BA		Remote control Button
40	^	Remote control Button	8F		Remote control Button
41	v	Remote control Button	8E		Remote control Button
07	<	Remote control Button	AB	GUIDE	Remote control Button
06	>	Remote control Button	39	SUBTITLE	Remote control Button
44	ENTER	Remote control Button	AA	INFO	Remote control Button
28	BACK	Remote control Button			
79	RATIO	Remote control Button			
DC	3D	Remote control Button			

APPENDIX

EXTERNAL CONTROL THROUGH RS-232C

The RS-232C port allows you connect the RS-232C input jack to an external control device (such as a computer or an A/V control system) to control the TV's functions externally.

- Note: RS-232C on this unit is intended to be used with third party RS-232C control hardware and software.

The instructions below are provided to help with programming software or to test functionality using telnet software.

i.e)

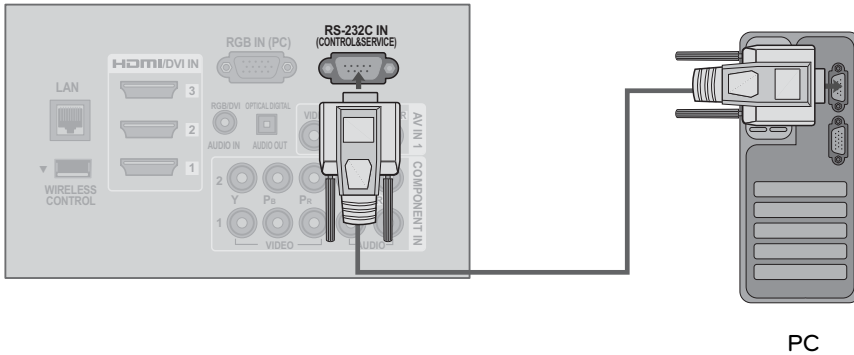

Type of Connector; D-Sub 9-Pin Male

Communication Parameters

No.	Pin Name
1	No connection
2	RXD (Receive data)
3	TXD (Transmit data)
4	DTR (DTE side ready)
5	GND
6	DSR (DCE side ready)
7	RTS (Ready to send)
8	CTS (Clear to send)
9	No Connection

- Baud rate : 9600 bps (UART)
- Data length : 8 bits
- Parity : None
- Stop bit : 1 bit
- Communication code : ASCII code
- Use a crossed (reverse) cable.

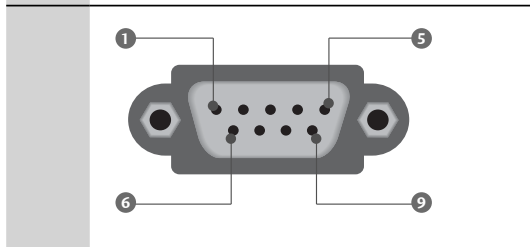

RS-232C Configurations

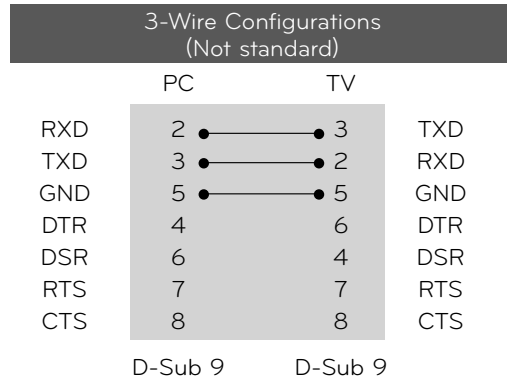
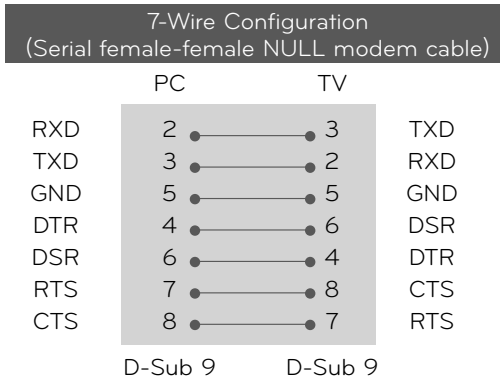

Set ID

Use this function to specify a TV ID number.
Refer to 'Real Data Mapping'.

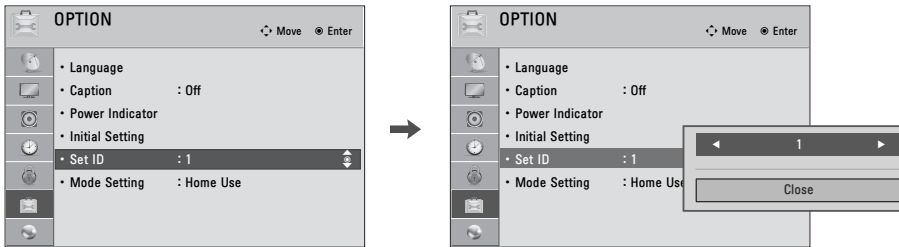

- 1 Select **OPTION**.
- 2 Select **Set ID**.
- 3 Choose the desired TV ID number.
The adjustment range of Set ID is 1~99.
- 4 Return to the previous menu.
- Return to TV viewing.

■ Real data mapping	
0	Step 0
⋮	
A	Step 10 (Set ID 10)
⋮	
F	Step 15 (Set ID 15)
10	Step 16 (Set ID 16)
⋮	
63	Step 99 (Set ID 99)
64	Step 100

APPENDIX

Command Reference List

	COMMAND1	COMMAND2	DATA (Hexadecimal)
01. Power	k	a	00 - 01
02. Input Select	x	b	▶ P.171
03. Aspect Ratio	k	c	▶ P.171
04. Screen Mute	k	d	00 - 01
05. Volume Mute	k	e	00 - 01
06. Volume Control	k	f	00 - 64
07. Contrast	k	g	00 - 64
08. Brightness	k	h	00 - 64
09. Color	k	i	00 - 64
10. Tint	k	j	00 - 64
11. Sharpness	k	k	00 - 64
12. OSD Select	k	l	00 - 01
13. Remote Control Lock Mode	k	m	00 - 01
14. Treble	k	r	00 - 64
15. Bass	k	s	00 - 64
16. Balance	k	t	00 - 64
17. Color Temperature	x	u	00 - 64
18. ISM Method	j	p	▶ P.172
19. Energy Saving	j	q	▶ P.172
20. Auto Configuration	j	u	▶ P.172
22. Channel Add/Del	m	b	00 - 01
23. Key	m	c	▶ P.173
24. Backlight	m	g	00 - 64

For LED LCD TV/LCD TV

For Plasma TV

	COMMAND1	COMMAND2	DATA00 (Hexadecimal)	DATA01 (Hexadecimal)
21. Channel Tuning	m	a	physical program high	major program low
			DATA02 (Hexadecimal)	DATA03 (Hexadecimal)
	major low	minor high	minor low	attribute

Transmission / Receiving Protocol

Transmission

[Command1][Command2][][Set ID][][Data][Cr]

[Command 1] : First command to control the set. (j, k, m or x)

[Command 2] : Second command to control the set.

[Set ID] : You can adjust the set ID to choose desired TV ID number in Setup menu. Adjustment range is 1-99. When selecting Set ID '0', every connected the TV is controlled. Set ID is indicated as decimal (1-99) on menu and as Hexa decimal (0x0 - 0x63) on transmission /receiving protocol.

[DATA] : To transmit the command data.

Transmit the 'FF' data to read status of command.

[Cr] : Carriage Return

ASCII code '0x0D'

[] : ASCII code 'space (0x20)'

* In this model, TV will not send the status during the standby mode.

OK Acknowledgement

[Command2][][Set ID][][OK][Data][x]

The TV transmits ACK (acknowledgement) based on this format when receiving normal data. At this time, if the data is data read mode, it indicates present status data. If the data is data write mode, it returns the data of the PC computer.

* In this model, TV will not send the status during the standby mode.

* Data Format

[Command 2] : Use as command.

[Set ID] : Use the small character, if set ID is 10, it will send the '0', 'a'.

[DATA] : Use the small character, if data is 0 x ab, it will send the 'a', 'b'.

[OK] : Use the large character.

Error Acknowledgement

[Command2][][Set ID][][NG][Data][x]

The TV transmits ACK (acknowledgement) based on this format when receiving abnormal data from non-viable functions or communication errors.

Data1: Illegal Code

Data2: Not supported function

Data3: Wait more time

* In this model, TV will not send the status during the standby mode.

* Data Format

[Command 2] : Use as command.

[Set ID] : Use the small character, if set ID is 10, it will send the '0', 'a'.

[DATA] : Use the small character, if data is 0 x ab, it will send the 'a', 'b'.

[NG] : Use the large character

01. Power (Command: k a)

To control Power On/Off of the TV.

Transmission [k][a][][Set ID][][Data][Cr]

Data 00: Power Off Data 01: Power On

Acknowledgement [a][][Set ID][][OK/NG][Data][x]

* In a like manner, if other functions transmit 'FF' data based on this format, Acknowledgement data feedback presents status about each function.

* Note: In this model, TV will send the Acknowledge after power on processing completion.

There might be a time delay between command and acknowledge.

02. Input Select (Command: x b)

To select input source for TV.

Transmission [x][b][][Set ID][][Data][Cr]

Data Structure

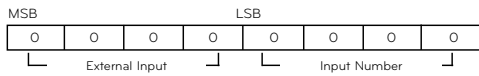

External Input				Data
0	0	0	0	DTV
0	0	0	1	Analog
0	0	1	0	AV
0	1	0	0	Component
0	1	1	0	RGB
0	1	1	1	HDMI
1	0	0	0	
1	0	0	1	
1	0	1	0	

Input Number				Data
0	0	0	0	Input1
0	0	0	1	Input2
0	0	1	0	Input3
0	0	1	1	Input4

* Detail : CATV(0001 0001)

Acknowledgement [b][][Set ID][][OK/NG][Data][x]

* Use the feature depending on your model.

03. Aspect Ratio (Command: k c)

To adjust the screen format.

Transmission [k][c][][Set ID][][Data][Cr]

Data 01: 4:3 Data 07: 14:9 (for ***-DA)

Data 02: 16:9 Data 09: Just scan

Data 04: Zoom Data 0B: Full Wide (for ***-DA)

Data 06: Original (for ***-DA)

Data 06: Set by program

Data 10 to 1F : Cinema Zom 1 to 16

Acknowledgement [c][][Set ID][][OK/NG][Data][x]

04. Screen Mute (Command: k d)

To select screen mute on/off.

Transmission [k][d][][Set ID][][Data][Cr]

Data 00: Screen mute off (Picture on), Video-out Mute off

Data 01: Screen mute on (Picture off)

Data 10: Video-out Mute on

Acknowledgement [d][][Set ID][][OK/NG][Data][x]

* In case of Video-out Mute on only, TV will display On Screen Display (OSD). But, in case of screen mute on, TV will not display On Screen Display (OSD).

05. Volume Mute (Command: k e)

To control volume mute on/off.

You can also adjust mute using the MUTE button on remote control.

Transmission [k][e][][Set ID][][Data][Cr]

Data 00: Volume mute on (Volume off)

Data 01: Volume mute off (Volume on)

Acknowledgement [e][][Set ID][][OK/NG][Data][x]

06. Volume Control (Command: k f)

To adjust volume.

You can also adjust volume with the volume buttons on remote control.

Transmission [k][f][][Set ID][][Data][Cr]

Data Min: 00 - Max: 64 (*transmit by Hexadecimal code)

*Refer to 'Real data mapping'.

Acknowledgement [f][][Set ID][][OK/NG][Data][x]

07. Contrast (Command: k g)

To adjust screen contrast.

You can also adjust contrast in the PICTURE menu.

Transmission [k][g][][Set ID][][Data][Cr]

Data Min: 00 - Max: 64 (*transmit by Hexadecimal code)

*Refer to 'Real data mapping'.

Acknowledgement [g][][Set ID][][OK/NG][Data][x]

08. Brightness (Command: k h)

To adjust screen brightness.

You can also adjust brightness in the PICTURE menu.

Transmission [k][h][][Set ID][][Data][Cr]

Data Min: 00 - Max: 64 (*transmit by Hexadecimal code)

*Refer to 'Real data mapping'.

Acknowledgement [h][][Set ID][][OK/NG][Data][x]

09. Color (Command: k i)

To adjust screen color.

You can also adjust color in the PICTURE menu.

Transmission [k][i][][Set ID][][Data][Cr]

Data Min: 00 - Max: 64 (*transmit by Hexadecimal code)

*Refer to 'Real data mapping'.

Acknowledgement [i][][Set ID][][OK/NG][Data][x]

APPENDIX

10. Tint (Command: k j)

To adjust screen tint.

You can also adjust tint in the PICTURE menu.

Transmission [k][j][][Set ID][][Data][Cr]

Data Red: 00 - Green: 64 (*transmit by Hexadecimal code)
*Refer to 'Real data mapping'.

Acknowledgement [j][][Set ID][][OK/NG][Data][x]

11. Sharpness (Command: k k)

To adjust screen sharpness.

You can also adjust sharpness in the Picture menu.

Transmission [k][k][][Set ID][][Data][Cr]

Data Min: 00 - Max: 64 (*transmit by Hexadecimal code)
*Refer to 'Real data mapping'.

Acknowledgement [k][][][Set ID][][OK/NG][Data][x]

12. OSD Select (Command: k l)

To select OSD (On Screen Display) on/off.

Transmission [k][l][][Set ID][][Data][Cr]

Data 00: OSD off Data 01: OSD on

Acknowledgement [l][][][Set ID][][OK/NG][Data][x]

13. Remote Control Lock Mode (Command: k m)

To lock the remote control and the front panel controls on the set.

Transmission [k][m][][Set ID][][Data][Cr]

Data 00: Lock off Data 01: Lock on

Acknowledgement [m][][][Set ID][][OK/NG][Data][x]

If you're not using the remote control and front panel controls on the TV, use this mode. When main power is on/off, remote control lock is released.

If Key Lock is on in the standby mode, TV will not turn on by POWER button of remote control and on the TV.

14. Treble (Command: k r)

To adjust treble.

You can also adjust treble in the Audio menu.

Transmission [k][r][][Set ID][][Data][Cr]

Data Min: 00 - Max: 64 (*transmit by Hexadecimal code)
*Refer to 'Real data mapping'.

Acknowledgement [r][][][Set ID][][OK/NG][Data][x]

15. Bass (Command: k s)

To adjust bass.

You can also adjust bass in the Audio menu.

Transmission [k][s][][Set ID][][Data][Cr]

Data Min: 00 - Max: 64 (*transmit by Hexadecimal code)
*Refer to 'Real data mapping'.

Acknowledgement [s][][][Set ID][][OK/NG][Data][x]

16. Balance (Command: k t)

To adjust balance.

You can also adjust balance in the Audio menu.

Transmission [k][t][][Set ID][][Data][Cr]

Data Min: 00 - Max: 64 (*transmit by Hexadecimal code)
*Refer to 'Real data mapping'.

Acknowledgement [t][][][Set ID][][OK/NG][Data][x]

17. Color Temperature (Command: x u)

To adjust color temperature.

You can also adjust color temperature in the Picture menu.

Transmission [x][u][][Set ID][][Data][Cr]

Data Min: 00 - Max: 64 (*transmit by Hexadecimal code)
*Refer to 'Real data mapping'.

Acknowledgement [u][][][Set ID][][OK/NG][Data][x]

18. ISM Method (Command: j p) (For Plasma TV)

To avoid having a fixed image remain on screen.

Transmission [j][p][][Set ID][][Data][Cr]

Data 02: Orbiter 04: White Wash
Data 08: Normal 20: Color Wash

Acknowledgement [p][][][Set ID][][OK/NG][Data][x]

19. Energy Saving (Command: j q)

To control the energy saving function.

Transmission [j][q][][Set ID][][Data][Cr]

Data 00: Off Data 01: Minimum
Data 02: Medium Data 03: Maximum
Data 04: Auto (depending on model)
Data 05: Screen off

Acknowledgement [q][][][Set ID][][OK/NG][Data][x]

20. Auto Configuration (Command: j u)

To adjust picture position and minimize image shaking automatically. Auto configuration only works in RGB-PC mode.

Transmission [j][u][][Set ID][][Data][Cr]

Data 01: To set

Acknowledgement [u][][][Set ID][][OK/NG][Data][x]

21. Channel Tuning (Command: m a)

To tune channel to following physical/major/minor number.

Transmission [m][a][][Set ID][][Data00][][Data01][][Data02][][Data03][][Data04][][Data05][Cr]

Data 00: Physical Channel Number(Transmit by Hexadecimal code)

NTSC air: 02~45, NTSC cable: 01, 0e~7d

Data 01 & 02: Major Channel Number(two part) or Channel Number(one part)

Data 01: High byte Data 02: Low byte

Two part channel number. Major number-Minor number
One part channel number.

In case of using one part channel number, minor channel does not need.

Data 03 & 04: Minor Channel Number

Not needed for NTSC.

Data 03 : High byte

Data 04 : Low byte

Data5:

7 Main/Sub Picture	6 Two/One Part Channel	5 Using Physical Channel	4 Reserved	3	2	1	0	Step
0 Main	0 Two	0 Use	x	0	0	0	0	NTSC Air
1 Sub	1 One	1 No Use	x	0	0	0	1	NTSC Cable

* Two/One part Channel: 6th bit

This bit is used in a cable-ready system.

* Two/One part Channel: 5th bit

If the channel band is NTSC air or NTSC cable, channel tuning can be done by only physical channel. In this case, using physical channel bit must be low(0).

Examples)

1. Analog channel: NTSC cable, channel number(35), main picture

Command: ma 00 23 xx xx xx xx 01

attribute(0x01): main picture, tow part(it's not mandatory), using physical channel, NTSC cable xx' data: don't care major and minor channel number in case analog channel tuning

Acknowledgement[a][][Set ID][][OK][Data00][Data01][Data02][Data03][Data04][Data05][x][a][][Set ID][][NG][Data00][x]

22. Channel Add/Del (Command: m b)

To add and delete the channels.

Transmission [m][b][][Set ID][][Data][Cr]

Data 00: Channel Delete Data 01: Channel Add

Acknowledgement [b][][Set ID][][OK/NG][Data][x]

23. Key (Command: m c)

To send IR remote control code.

Transmission [m][c][][Set ID][][Data][Cr]

See page 167.

Acknowledgement [c][][Set ID][][OK/NG][Data][x]

When TV is in the standby mode, TV will turn on by POWER button of remote control only.

24. Backlight (Command: m g) (For LED LCD TV, LCD TV)

To adjust screen backlight.

Transmission [m][g][][Set ID][][Data][Cr]

Data Min:00 ~ Max:64 (*transmit by Hexadecimal code)

*Refer to 'Real data mapping'.

Acknowledgement [g][][Set ID][][OK/NG][Data][x]

APPENDIX

For 32/42/47/55LE5500-DA, 42/47LX6500-DA, 42/47LE8500-DA, 32/42/47/55LD650-DA

21. Channel Tuning (Command: m a)

To tune channel to following physical number.

Transmission [m][a][][Set ID][][Data0][][Data1][][Data2][Cr]

Data00 : High channel data

Data01 : Low channel data

ex. No. 47 -> 00 2F (2FH)

No. 394 -> 01 8A (18AH),

DTV No. 0 -> Don't care

Data02 0x00 : Analog Main

0x10 : DTV Main

0x20 : Radio

0x80 : CATV Main

Channel data range

Analog air - Min: 02 ~ Max: 45 (2~69)

Analog cable - Min: 01 ~ Max: 7D(1~125)

Digital - Min: 01 ~ Max: 3E7(1~999)

Acknowledgement [a][][Set ID][][OK/NG][Data][x]

Data Min: 00 ~ Max: 7DH

OPEN SOURCE SOFTWARE NOTICE

The following GPL executables and LGPL, MPL libraries used in this product are subject to the GPL2.0/LGPL2.1/MPL1.1 License Agreements:

GPL EXECUTABLES:

Linux kernel 2.6, busybox, e2fsprogs, jfsutils, lzo, msdl-1.1, mtd-utils, ntpclient, procps

LGPL LIBRARIES:

Atk, cairo, directFB, ffmpeg, glib, GnuTLS, gtk+, iconv, libintl, libgcrypt, libgpg-error, libsoup, libusb, pango, uClibc, webkit

MPL LIBRARIES:

Nanox, spidermonkey

LG Electronics offers to provide source code to you on CD-ROM for a charge covering the cost of performing such distribution, such as the cost of media, shipping and handling upon e-mail request to LG Electronics : opensource@lge.com

This offer is valid for a period of three (3) years from the date of the distribution of this product by LG Electronics.

You can obtain a copy of the GPL, LGPL, MPL licenses on the CD-ROM provided with this product. Also you can obtain the translation of GPL, LGPL licenses from <http://www.gnu.org/licenses/old-licenses/gpl-2.0-translations.html>, <http://www.gnu.org/licenses/old-licenses/lgpl-2.1-translations.html>.

This product includes other open source software.

- ▶ boost C++: software developed by <http://www.boost.org> distributed under the Boost Software License, Version 1.0
- ▶ c-ares : copyright © 1998 by the Massachusetts Institute of Technology
- ▶ expat:
 - copyright © 1998, 1999, 2000 Thai Open Source Software Center Ltd and Clark Cooper
 - copyright © 2001, 2002, 2003, 2004, 2005, 2006 Expat maintainers.
- ▶ fontconfig: copyright © 2001, 2003 Keith Packard
- ▶ freetype: copyright © 2003 The FreeType Project (www.freetype.org).
- ▶ ICU: copyright © 1995-2008 International Business Machines Corporation and others.
- ▶ libcurl: copyright © 1996 - 2008, Daniel Stenberg.
- ▶ libjpeg: This software is based in part on the work of the Independent JPEG Group copyright © 1991 - 1998, Thomas G. Lane.
- ▶ libmng: copyright © 2000-2007 Gerard Juyn, Glenn Randers-Pehrson
- ▶ libpng: copyright © 1998-2008 Glenn Randers-Pehrson
- ▶ libupnp: copyright © 2000-2003 Intel Corporation
- ▶ libxml2 : copyright © 1998-2003 Daniel Veillard
- ▶ libxslt: copyright © 2001-2002 Daniel Veillard
- ▶ lua interpreter: copyright © 1994-2008 Lua.org, PUC-Rio
- ▶ md5: copyright © 1991-2, RSA Data Security, Inc
- ▶ openssl:
 - cryptographic software written by Eric Young.
 - software written by Tim Hudson.
 - software developed by the OpenSSL Project for use in the OpenSSL Toolkit. (<http://www.openssl.org>)
- ▶ pixman:
 - copyright © 1987, 1988, 1989, 1998 The Open Group
 - copyright © 1987, 1988, 1989 Digital Equipment Corporation
 - copyright © 1999, 2004, 2008 Keith Packard
 - copyright © 2000 SuSE, Inc.
 - copyright © 2000 Keith Packard, member of The XFree86 Project, Inc.
 - copyright © 2004, 2005, 2007, 2008 Red Hat, Inc.
 - copyright © 2004 Nicholas Miell
 - copyright © 2005 Lars Knoll & Zack Rusin, Trolltech
 - copyright © 2005 Trolltech AS
 - copyright © 2007 Luca Barbato
 - copyright © 2008 Aaron Plattner, NVIDIA Corporation
 - copyright © 2008 Rodrigo Kumpera
 - copyright © 2008 André Tupinambá
 - copyright © 2008 Mozilla Corporation
 - copyright © 2008 Frederic Plourde
- ▶ portmap: copyright © 1983,1991 The Regents of the University of California.
- ▶ tiff: copyright © 1987, 1993, 1994 The Regents of the University of California.
- ▶ tinxml: copyright © 2000-2006 Lee Thomason
- ▶ xysl:
 - copyright © 2006-2008 Christophe Devine
 - copyright © 2009 Paul Bakker
- ▶ zlib: copyright © 1995-2005 Jean-loup Gailly and Mark Adler

All rights reserved.

Permission is hereby granted, free of charge, to any person obtaining a copy of this software and associated documentation files (the "Software"), to deal in the Software without restriction, including without limitation the rights to use, copy, modify, merge, publish, distribute, sublicense, and/or sell copies of the Software, and to permit persons to whom the Software is furnished to do so, subject to the following conditions:

THE SOFTWARE IS PROVIDED "AS IS", WITHOUT WARRANTY OF ANY KIND, EXPRESS OR IMPLIED, INCLUDING BUT NOT LIMITED TO THE WARRANTIES OF MERCHANTABILITY, FITNESS FOR A PARTICULAR PURPOSE AND NONINFRINGEMENT. IN NO EVENT SHALL THE AUTHORS OR COPYRIGHT HOLDERS BE LIABLE FOR ANY CLAIM, DAMAGES OR OTHER LIABILITY, WHETHER IN AN ACTION OF CONTRACT, TORT OR OTHERWISE, ARISING FROM, OUT OF OR IN CONNECTION WITH THE SOFTWARE OR THE USE OR OTHER DEALINGS IN THE SOFTWARE.



The model and serial number of the TV is located on the back and one side of the TV. Record it below should you ever need service.

MODEL _____

SERIAL _____