



**LG**

Life's Good

# OWNER'S MANUAL WIRELESS MEDIA BOX

Please read this manual carefully before operating your set and retain it for future reference.

# CONTENTS

## PREPARATION

Accessories .....	3
Front panel controls .....	4
BACK PANEL INFORMATION .....	5
Side panel INFORMATION .....	5
Wireless Ready Dongle .....	6
Connecting to the TV.....	6
Attaching the Wireless Ready Dongle .....	7
Back Cover for Wire Arrangement .....	8
Connection of 12 V AC/DC Adapter.....	8
Optimal Installation Location of Wireless Media Box .....	9
Reception Problems due to Interference .....	9
Attaching the IR blaster.....	10
Optimal location of external device with IR Blaster installed.....	10

## EXTERNAL EQUIPMENT SETUP

Connecting with a Component cable .....	11
Connecting with an HDMI cable .....	12
Connecting with an HDMI to DVI cable .....	13
Connecting with RCA cable .....	14
Digital Audio Out Setup.....	15
Connecting with RGB.....	15
Supported Display Resolution.....	16

## WATCHING TV / PROGRAMME CONTROL

Turning on the Wireless Media box .....	17
Input list .....	18
IR Blaster Setup .....	18

## APPENDIX

IR Code List .....	19
RF Specifications .....	20
Frequency Table.....	21
Product Specifications.....	22
Troubleshooting.....	22
Open Source Software Notice .....	24

Indoor use only

This device only works with compatible Wireless Ready LG LCD, LED LCD, and Plasma TVs.

This product does not support 3D.

### Except for USA



Manufactured under license from Dolby Laboratories.  
Dolby and the double-D symbol are trademarks of  
Dolby Laboratories.

# PREPARATION

## ACCESSORIES

Ensure that the following accessories are included with your Wireless Media Box. If an accessory is missing, please contact the dealer where you purchased the set.

■ Image shown may differ slightly from your device.

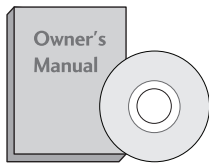

Owner's Manual



Power Cord

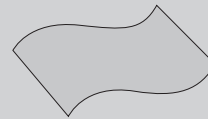

Polishing Cloth

\* Lightly wipe any stains or fingerprints on the surface of the Wireless Media Box with the polishing cloth.

Do not use excessive force. This may cause scratching or discolouration.

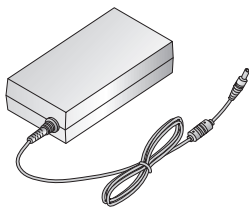

12 V AC/DC Adapter

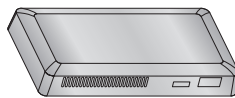

Wireless Ready Dongle



Velcro



Cable Holder

X 2EA



Cable Management Clip



HDMI Cable



20 Pin Cable  
(Power/Control)

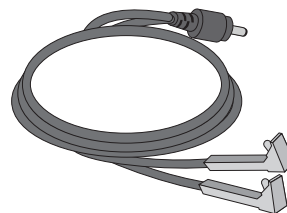

IR Blaster Cable

X 2EA

# PREPARATION

## FRONT PANEL CONTROLS

### ! NOTE

- ▶ This product is only for home use.
- ▶ Do not use this product in medical institutions or near medical devices. It may cause some medical devices to malfunction.
- ▶ Wireless device used to this instrument could be set up and used only to this instrument.
- ▶ When using the external device connected to the Wireless Media Box, some functions of the TV menu may not work.

- Image shown may differ slightly from your device.

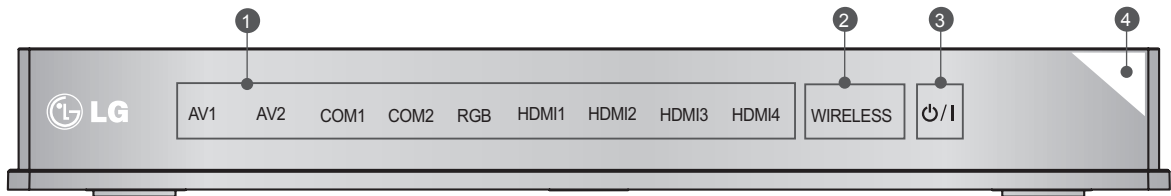

#### 1 Input Source Indicator & INPUT touch button

Select the input source by touching.

#### 2 Wireless Connection Indicator

It will flash when trying to connect to a wireless network and be turned on when connected.

#### 3 POWER touch button

Turn the Wireless Media Box on or off by touching.

If the  $\text{O/I}$  (Power) button of the Wireless Media Box is not turned on, the Wireless Media Box will not be turned on even when turn on the power of the TV. If the Wireless Media Box is not turned on even after turning the power of the TV on, check the  $\text{O/I}$  (Power) button of the Wireless Media Box.

#### 4 Power/Standby Indicator

Illuminates red in standby mode.

Illuminates white when the Wireless Media Box is switched on.

\* ID Label of Wireless Media Box is located at the bottom of Wireless Media Box.

# BACK PANEL INFORMATION

■ Image shown may differ slightly from your device.

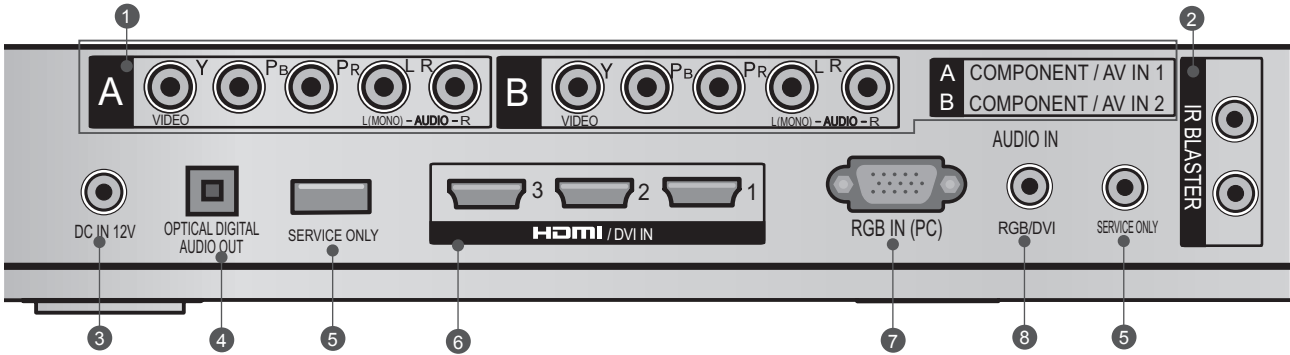

## 1 Component Input

Connect a component video/audio device to these jacks.

### Audio/Video Input(AV1/2)

Connect audio/video output from an external device to these jacks.

## 2 IR Blaster

Controls external equipment.

## 3 DC IN 12 V Power Cord Socket

This Wireless Media Box operates on 12 V DC power. Only use a power converter that the device was designed to use.

## 4 Optical Digital Audio Out

Optical digital audio output for use with amps.

Note: In standby mode, this port doesn't work.

## 5 SERVICE ONLY PORT

## 6 HDMI/DVI IN Input

Digital Connection. Supports HD video and Digital audio. Doesn't support 480i. Accepts DVI video using an adapter or HDMI to DVI cable (not included).

## 7 RGB IN (PC) Input

Analog PC Connection. Uses a D-sub 15 pin cable (VGA cable).

## 8 AUDIO IN (RGB/DVI) Input

Connect the audio from an external device.

# SIDE PANEL INFORMATION

■ Image shown may differ slightly from your device.

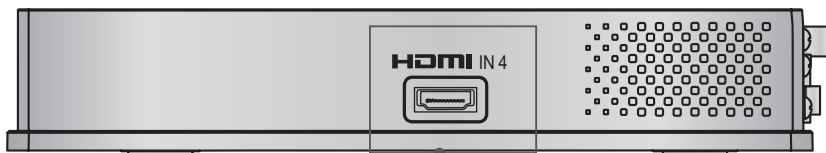

## HDMI IN 4

Digital Connection.

Supports HD video and Digital audio.

Doesn't support 480i and 576i.

# PREPARATION

## WIRELESS READY DONGLE

■ Image shown may differ slightly from your device.

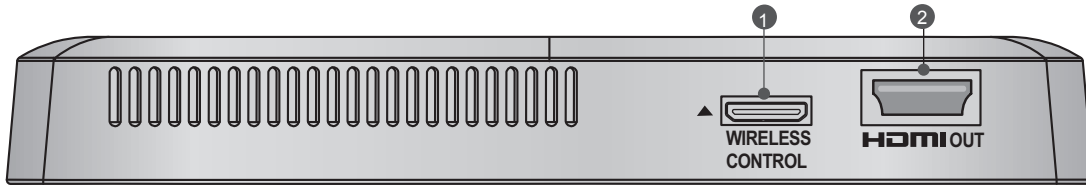

- ① **Wireless Control Port**  
This port is used to send and receive commands between the TV and the Wireless Media Box.
- ② **HDMI Out Port**  
This port sends the audio and video received from the Wireless Media Box to the TV.

## CONNECTING TO THE TV.

■ Image shown may differ slightly from your device.

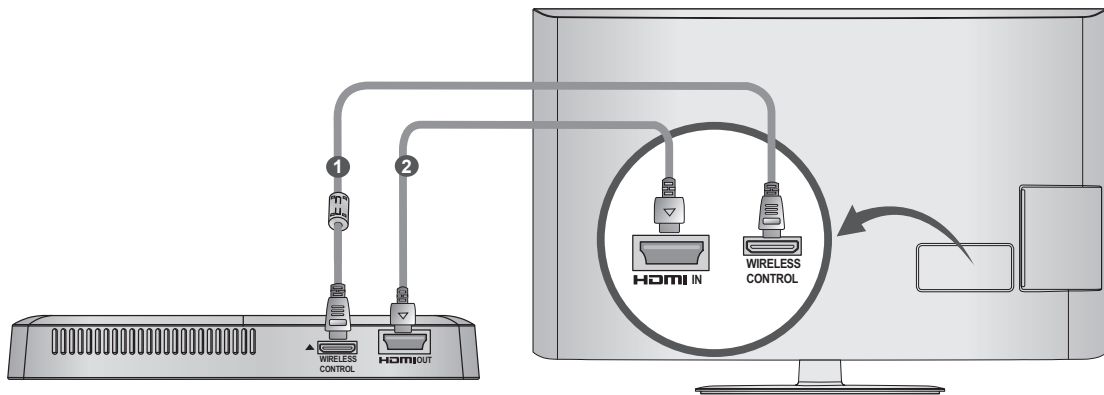

- ① Use the provided 20 pin cable (power/control) to connect to the wireless control port of the Wireless Ready Dongle and the wireless control port on the TV.
- ② Now connect the HDMI to both the TV and the Wireless Ready Dongle.

### ! NOTE

- ▶ Install the Wireless Ready Dongle with the power of the TV turned off.
- ▶ Use the wireless control jack and 20 pin cable only for connecting the Wireless Ready TV and Wireless Ready Dongle. When used for other purposes, it can cause an error or damage to the product.

# ATTACHING THE WIRELESS READY DONGLE

■ The Wireless Ready Dongle can be attached to the back of the TV with the included materials.

- 1 Remove the protective paper from the included Velcro pad and attach it to the TV as shown. It does not have to be in same position, but should be close to the TV's inputs. The TV will have a recommended location engraved on the TV.

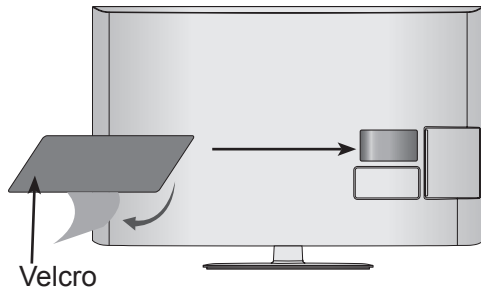

- 2 Now place the Wireless Ready Dongle onto the Velcro pad.

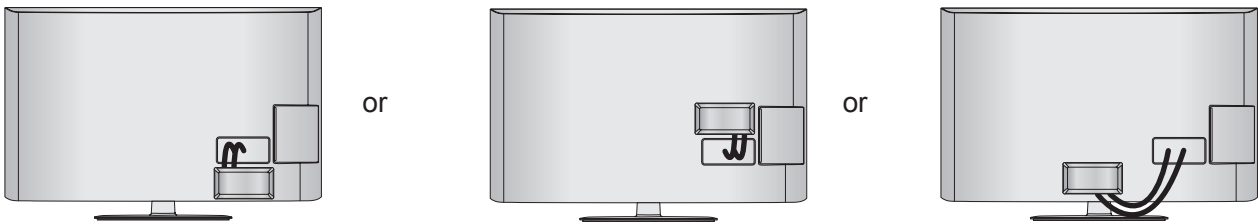

## NOTE

- ▶ The attaching location on the Wireless Ready Dongle can differ by model. Check the engraving on the back cover and attach the cable according to the engraving.
- ▶ Clean the part where the magic tape (Velcro) is attached using the supplied brush and attach the part by pressing the area evenly for 1 minute. After about 10 minutes attach the wireless dongle firmly.

### • Engraving

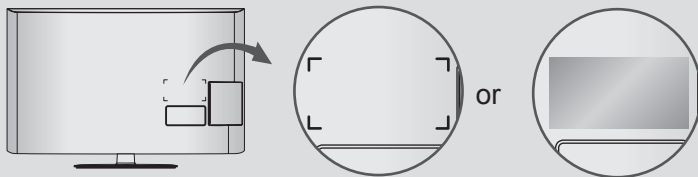

# PREPARATION

## BACK COVER FOR WIRE ARRANGEMENT

■ Image shown may differ slightly from your device.

- 1 Connect the cables as necessary.  
(Refer to the p.6 to 7)

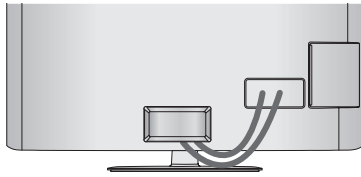

- 2 After connecting the cables, bundle the cables and install the **Cable Holder** as shown.

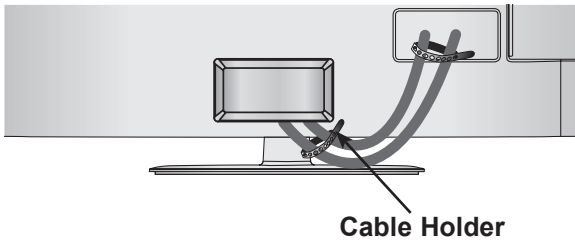

- 3 Now install the Cable Management Clip which will attach to the back of the TV.  
NOTE: The Cable Management Clip attachment location on the TV can differ by model.

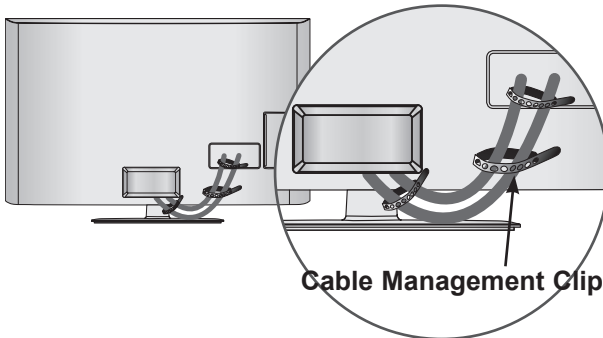

### NOTE

- ▶ Do not use the **Cable Management Clip** to lift the TV. If the TV is dropped, you may be injured or the TV may be damaged.

## CONNECTION OF 12 V AC/DC ADAPTER

■ Image shown may differ slightly from your device.

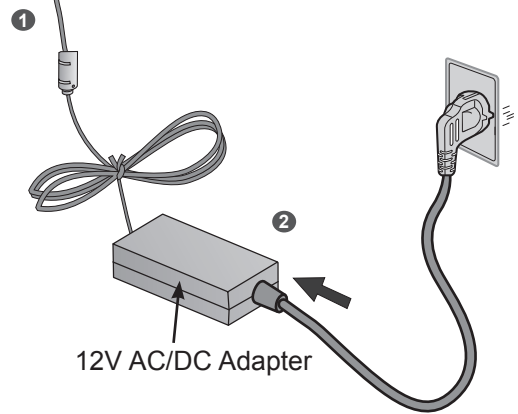
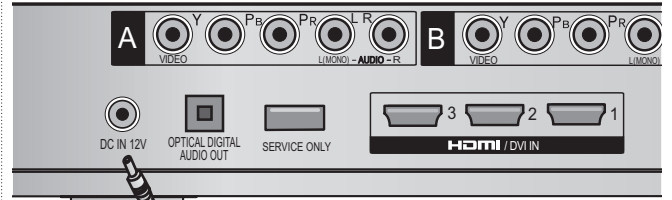

- 1 Connect the 12 V AC/DC adapter plug to the DC IN 12V input jack on the Wireless Media Box.
- 2 Connect the power cord to the 12 V AC/DC adapter first, then plug the power cord into the wall power outlet.

### CAUTION

- ▶ Please be sure to connect the Wireless Media Box to the AC/DC power adapter before connecting the power plug of the Wireless Media Box to a wall power outlet.



# OPTIMAL INSTALLATION LOCATION OF WIRELESS MEDIA BOX

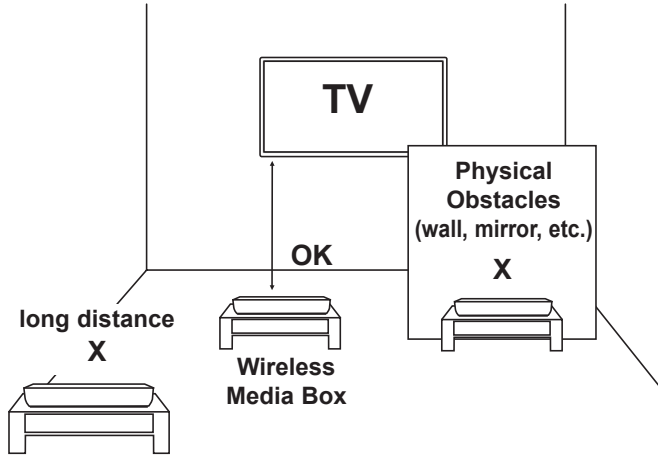

- The nearer the distance between Wireless Media Box and TV, the better the wireless function.
- We recommend that you place the Media Box and the TV in the same room.
- The more objects that are in between the Media Box and the TV, the more the reception strength decreases.
- If the heat from certain objects (e.g., a heater or a radiator) can reach and warm the Media Box, this may also cause transmission quality to suffer.

Wireless Signal

■ When you press the ENTER (or OK) button while viewing the external input of Wireless Media Box, the information of the current input and the strength of the wireless signal will be displayed on the bottom left side.

Poor Reception

Good Reception

Adjust the location and direction of the Wireless Media Box until you get good reception.

# RECEPTION PROBLEMS DUE TO INTERFERENCE

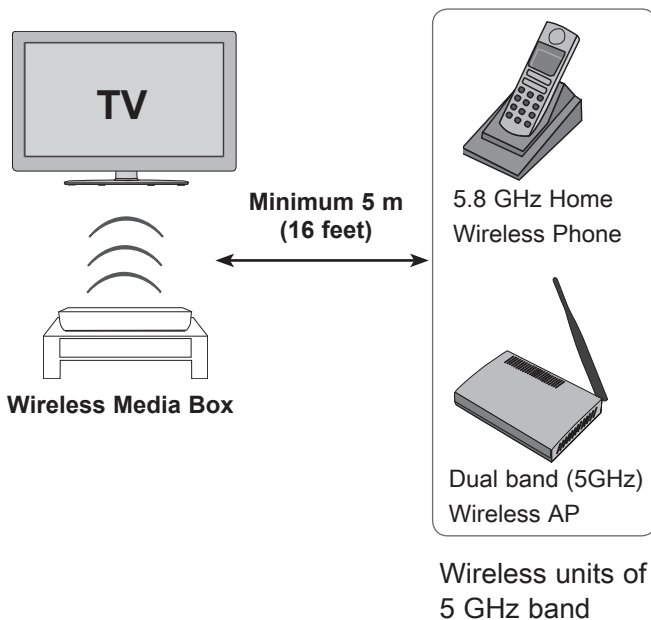

- Problems such as a connection delay, audio cut-off, and poor picture quality may occur due to interference if there are several wireless devices with a 5 GHz band (5.15 GHz to 5.85 GHz) operating in the same home or in close proximity to each other. If these problems occur, take the following actions:
  - Maintain a distance of at least 5 m (16 feet) between the TV and another device with a 5 GHz band.
  - Position the Media Box in a location closer to the TV.
  - Place the Media Box in a higher position. (a minimum of 1 m is recommended.)
  - Please set your wireless LAN to 2.4 GHz Band (channel 1 to 11).
    - Please refer the manual of your router for detail information.
    - If it is not possible to change the channel, please move the router away from the wireless ready dongle.

# PREPARATION

## ATTACHING THE IR BLASTER

■ The IR blaster allows the LG TV to control external equipment, like a cable box.

- 1 Connect the provided IR Blaster cable to the IR Blaster terminal on the Wireless Media Box.
- 2 After removing the protection paper from the IR Blaster cable, adhere it to the external equipment as shown.

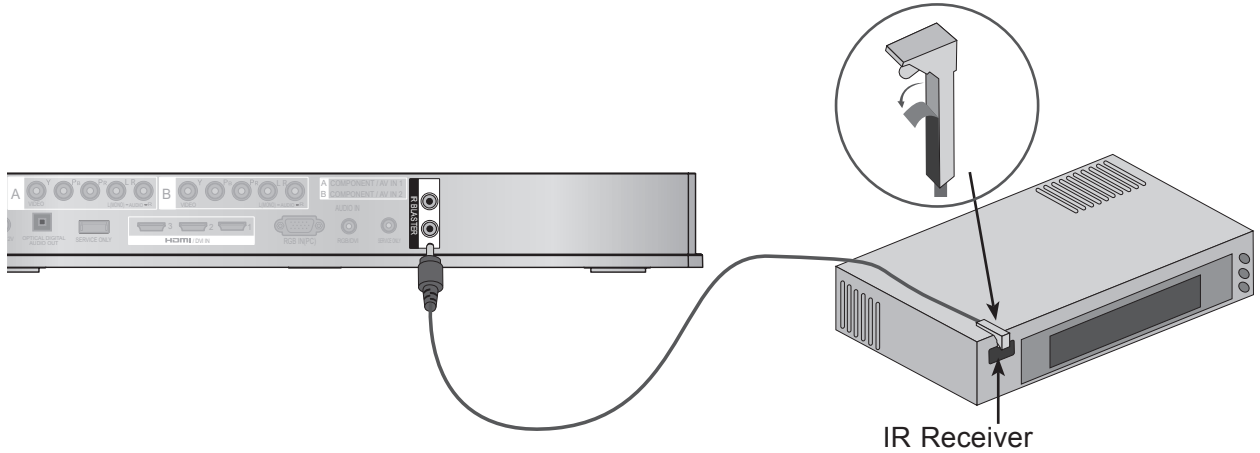

### NOTE

- ▶ When you attach the IR Blaster sensor near the remote control sensor of the external device, the signal can be detected more efficiently.

## OPTIMAL LOCATION OF EXTERNAL DEVICE WITH IR BLASTER INSTALLED

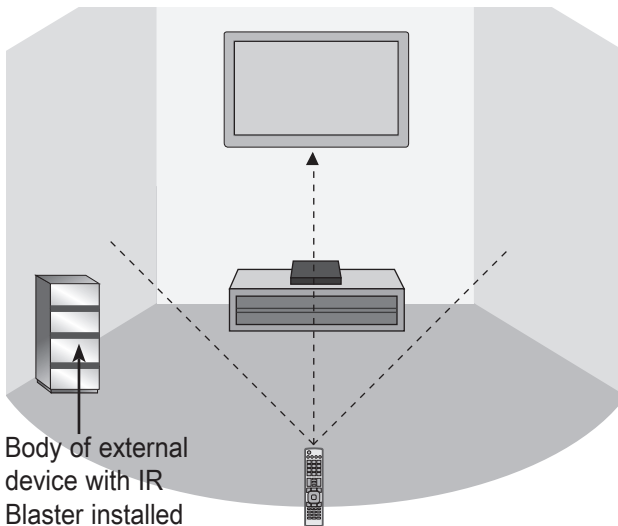

Install the external device with the IR Blaster installed at a location it is not affected by the signal from the remote controller to the TV. When the external device with the IR Blaster installed receives the signal from the remote controller simultaneously with the TV, it may not operate.

### NOTE

- ▶ For some external devices, the IR Blaster may not operate depending on the performance of the IR receiver.
- ▶ The operation may be delayed due to the sensitivity of the wireless signal.

# EXTERNAL EQUIPMENT SETUP

- To avoid damaging any equipment, never plug in any power cord until you have finished connecting all equipment.
- Image shown may differ slightly from your device.

## CONNECTING WITH A COMPONENT CABLE

- 1 Connect the video outputs (Y, P<sub>B</sub>, P<sub>R</sub>) of the external equipment (digital set-top box, DVD, etc.) to the **COMPONENT IN VIDEO** jacks labeled A or B on the Wireless Media Box.
- 2 Connect the audio output of the external equipment (digital set-top box, DVD, etc.) to the **COMPONENT IN AUDIO** jacks on the Wireless Media Box.
- 3 Turn on the external equipment.  
(Refer to the external equipment's manual for operating instructions.)
- 4 Select the Wireless **Component1** input source using the **INPUT** button on the remote control of TV.  
If connected to **COMPONENT IN2**, select Wireless **Component2** input source.  
Refer to the user manual of the connected TV for the format of component input.

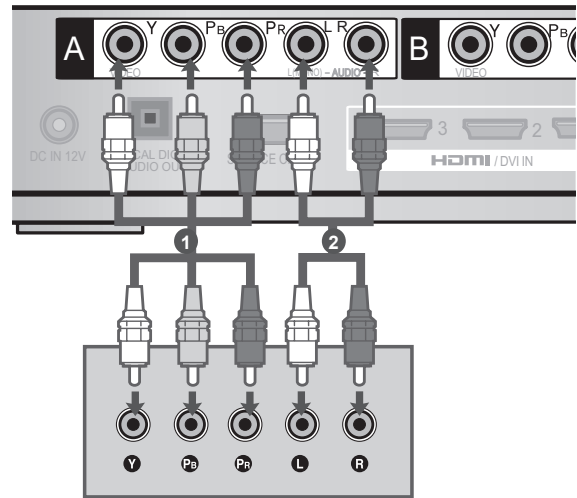

### Component Input ports

To achieve better picture quality, connect a DVD player to the component input ports as shown below.

Component ports on the Wireless Media Box	Y	P <sub>B</sub>	P <sub>R</sub>
Video output ports on DVD player	Y	P <sub>B</sub>	P <sub>R</sub>
	Y	B-Y	R-Y
	Y	Cb	Cr
	Y	Pb	Pr

# EXTERNAL EQUIPMENT SETUP

## CONNECTING WITH AN HDMI CABLE

- 1 Connect the HDMI output of the external equipment (digital set-top box, DVD, etc.) to **HDMI/DVI IN 1**, **HDMI/DVI IN 2**, **HDMI/DVI IN 3** or **HDMI IN 4** jack on the Wireless Media Box.
- 2 Turn on the external equipment.
- 3 Select **Wireless HDMI1**, **Wireless HDMI2**, **Wireless HDMI3** or **Wireless HDMI4** input source using the **INPUT** button on the remote control of TV.  
Refer to the user manual of the connected TV for the format of HDMI input.

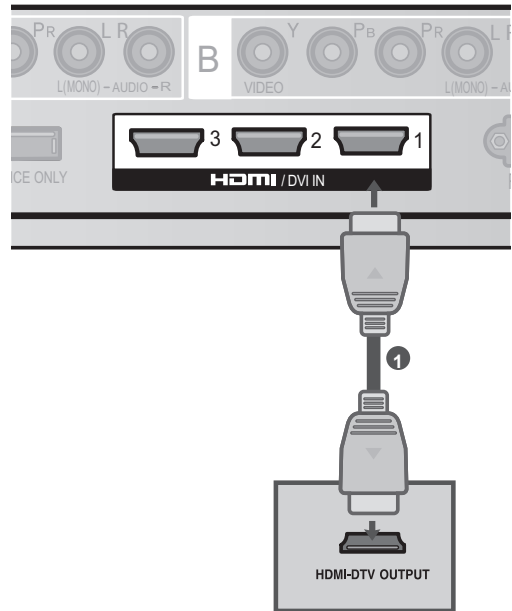

### ! NOTE

- ▶ The Wireless Media Box can receive video and audio signals simultaneously when using an HDMI cable.
- ▶ If the DVD does not support Auto HDMI, you must set the output resolution appropriately.
- ▶ Check that your HDMI cable is High Speed HDMI Cable. If the HDMI cables are not High Speed HDMI Cable, flickering or no screen display can result. Please use the High Speed HDMI Cable.

### ■ Supported HDMI Audio Format

	U.S.A	Other countries
PCM (2-channel)	O	O
Dolby Digital (5.1-channel)	X	O
DTS	X	X

## CONNECTING WITH AN HDMI TO DVI CABLE

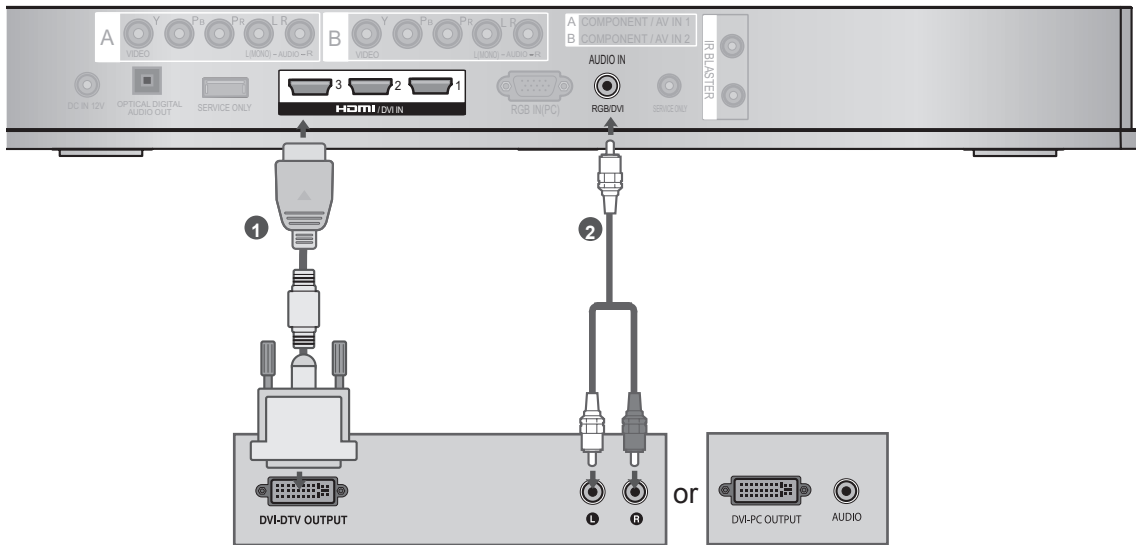

- 1 Connect the digital set-top box or the DVI output of the PC to **HDMI/DVI IN 1**, **HDMI/DVI IN 2** or **HDMI/DVI IN 3** jack on the Wireless Media Box.
- 2 Connect the audio output of the digital set-top box or the PC audio output to the **AUDIO IN (RGB/DVI)** jack on the Wireless Media Box.
- 3 Turn on the digital set-top box or the PC and the Wireless Media Box. (Refer to the digital set-top box or the PC manual for operating instructions.)
- 4 Select Wireless **HDMI1**, Wireless **HDMI2** or Wireless **HDMI3** input source using the **INPUT** button on the remote control of TV.

# EXTERNAL EQUIPMENT SETUP

## CONNECTING WITH RCA CABLE

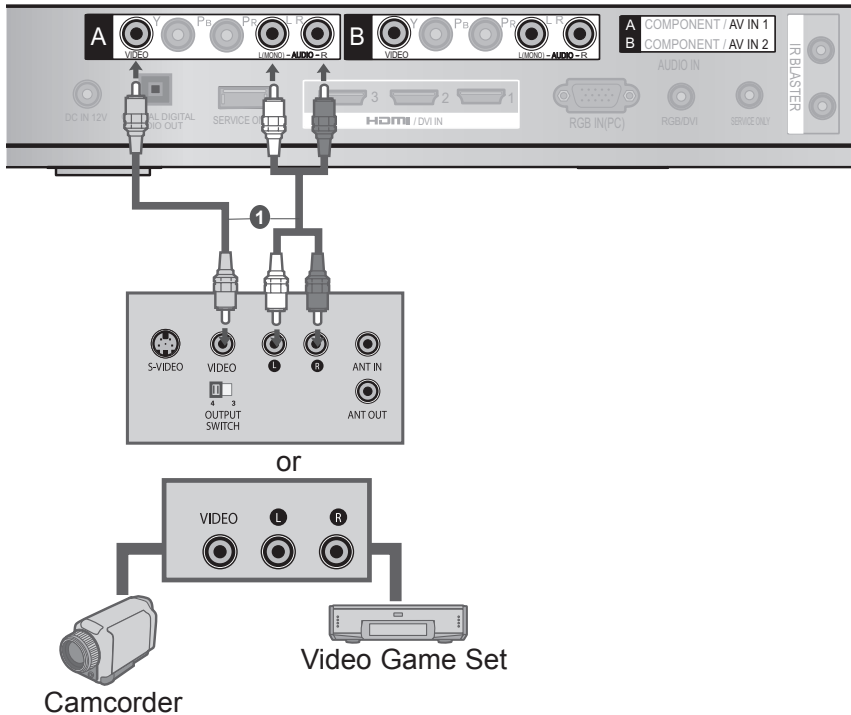

EXTERNAL EQUIPMENT SETUP

- 1 Connect the **AUDIO/VIDEO** jacks between Wireless Media Box and VCR or external equipment.
- 2 Insert a video tape into the VCR and press **PLAY** on the VCR. (Refer to the VCR owner's manual.)  
Or, Operate the corresponding external equipment.  
(Refer to external equipment operating guide.)
- 3 Select Wireless **AV1** input source using the **INPUT** button on the remote control of TV.  
If connected to **AV IN 2** input, select Wireless **AV2** input source.

### NOTE

- ▶ If you have a mono VCR, connect the audio cable from the VCR to the **AUDIO L/MONO** jack of the media box.

## DIGITAL AUDIO OUT SETUP

You can output the Wireless Media Box's audio signal to external audio equipment via the Optical Digital Audio Output port. This port uses a standard optical cable.

- 1 Connect one end of an optical cable to the **OPTICAL DIGITAL AUDIO OUT** port on the Wireless Media Box.
- 2 Connect the other end of the optical cable to the digital audio (Optical) input on the audio equipment.

### ⚠ CAUTION

- ▶ Do not look into the optical output port. Looking at the laser beam may damage your vision.

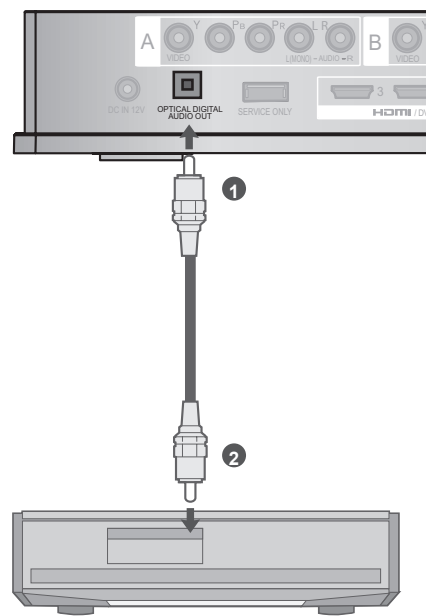

## CONNECTING WITH RGB

You can also connect devices using the RGB input. This connection uses a standard VGA cable (D-Sub 15 pin cable). This Wireless Media Box supports Plug and Play capability, meaning that the PC adjusts automatically to the Wireless Media Box's settings.

- 1 Connect the RGB output of the PC to the **RGB IN (PC)** jack on the Wireless Media Box.
- 2 Connect the PC audio output to the **AUDIO IN (RGB/DVI)** jack on the Wireless Media Box.
- 3 Turn on the PC and the Wireless Media Box.
- 4 Select Wireless **RGB** input source using the **INPUT** button on the remote control of TV.

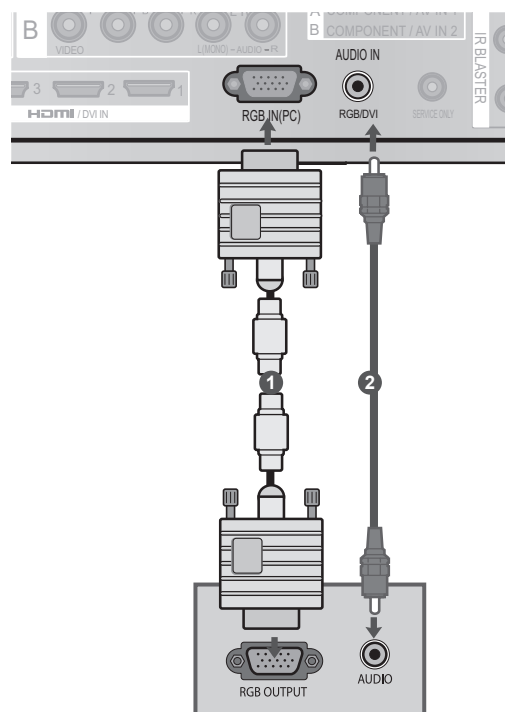

# EXTERNAL EQUIPMENT SETUP

## SUPPORTED DISPLAY RESOLUTION

RGB-PC, HDMI/DVI-PC mode

Resolution	Horizontal Frequency(kHz)	Vertical Frequency(Hz)
720x400	31.468	70.08
640x480	31.469	59.94
800x600	37.879	60.31
1024x768	48.363	60.00
1280x768	47.78	59.87
1360x768	47.72	59.80
1280x1024	63.981	60.02
1920x1080 (RGB-PC)	66.587	59.93
1920x1080 (HDMI-PC)	67.5	60.00

### NOTE

- ▶ There may be interference relating to resolution, vertical pattern, contrast or brightness in PC mode. Change the PC mode to another resolution or change the refresh rate to another rate or adjust the brightness and contrast on the menu until the picture is clear. If the refresh rate of the PC graphic card can not be changed, change the PC graphic card or consult the manufacturer of the PC graphic card.
- ▶ The synchronization input waveform for Horizontal and Vertical frequencies are separate.
- ▶ Connect the signal cable from the monitor output port of the PC to the RGB (PC) port of the Wireless Media Box or the signal cable from the HDMI output port of the PC to the HDMI IN (or HDMI/DVI IN) port on the Wireless Media Box.
- ▶ Connect the audio cable from the PC to the Audio input on the Wireless Media Box. (Audio cables are not included with the Wireless Media Box).
- ▶ DOS mode may not work depending on the video card if you use an HDMI to DVI cable.
- ▶ If you use too long an RGB-PC cable, there may be interference on the screen. We recommend using under 5m of cable. This provides the best picture quality.
- ▶ When an unsupported resolution or graphic card is used on the PC, it may cause some errors.



# WATCHING TV / PROGRAMME CONTROL

## TURNING ON THE WIRELESS MEDIA BOX

- 1 Firstly, connect the power cord correctly on the Wireless Media Box.  
At this stage, the Wireless Media Box switches to standby mode.  
When installing for the first time, the press the  / I (Power) button of the Wireless Media Box to turn on the power.)
- 2 Use the remote controller of the TV to turn on the power. The power of the Wireless Media Box will automatically be turned on. Point the remote controller toward the TV.
- 3 When the power of the TV is turned on, the picture will be displayed as follows by stage according to the wireless connecting procedure.





- If you turn on the power of the TV when the external input of the Wireless Media Box is selected, it will be displayed when the external input of the Wireless Media Box is trying to connect to the wireless network.
- This is the screen displayed when trying to connect wireless (external input) after connecting the Wireless Ready Dongle while the TV is turned off.
- The screen becomes dark briefly right before the connection process is complete.
- When the connection fails, check the power of the Wireless Media Box.



- Left icon is to distinguish the external input of TV and the wireless external input of Wireless Media Box.
- After the Wireless Ready Dongle is successfully installed, wireless external input will be shown additionally in the TV menu related to external input. (Input List, Input Label, Timer, Input Block and Picture Wizard)
- Operate the external input of Wireless Media Box using the remote controller of the TV.
- When an external device is connected to the Media Box, if the wireless connection is disconnected while the user is changing the settings for video, audio, and other options, the changed settings may not be applied completely. If this occurs, try to carry out the setup again when a wireless device is connected.



- When you press the ENTER (or OK) button while viewing the external input of Wireless Media Box, the information of the current input and the strength of the wireless signal will be displayed on the bottom left side. (When you press the BACK/EXIT button, the information will disappear.)

- If you press the  / I (Power) button of the Wireless Media Box manually to turn it off when both the TV and Wireless Media Box are turned on, you will not be able to turn on the power using the remote controller of the TV. At this time, press the  / I (Power) button of the Wireless Media Box to turn on the power.

# WATCHING TV / PROGRAMME CONTROL

## INPUT LIST

Only input signals which are connected to a TV or Wireless Media Box can be activated and selected.

- Image shown may differ from your TV.

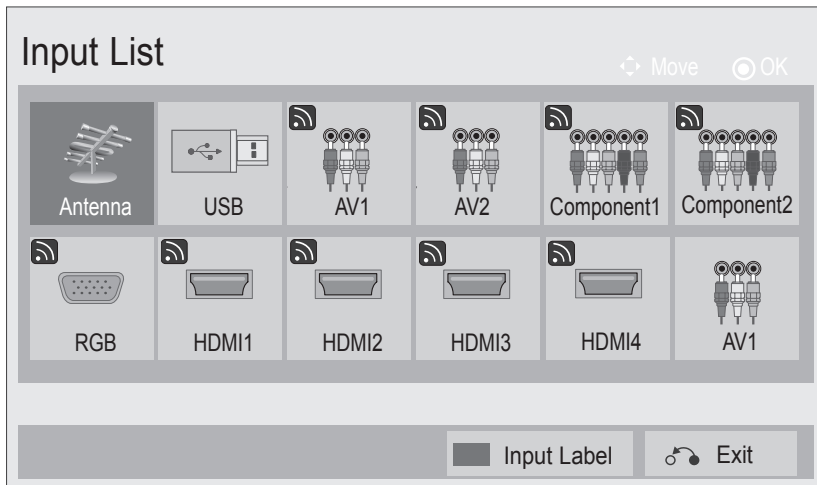

\* This is the screen when the Wireless Ready Dongle is connected to HDMI/DVI IN 1. HDMI terminal connected to Wireless Ready Dongle is not displayed on the list of external inputs.

- Select your desired Source.

When you change the input source, it can take up to 10 seconds depending on the wireless environment.

## IR BLASTER SETUP

You can control the external device (VCR, DVD player etc.) connected to the Media box from the TV using the infrared controller called IR-Blaster.

Set up the TV menu as shown below.

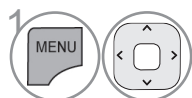

Select **OPTION**.

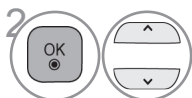

Select **IR Blaster**.

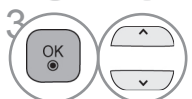

Select **On**.

or

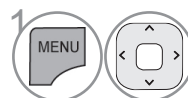

Select **OPTION**.

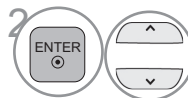

Select **IR Blaster**.



Select **On**.

- Press the **MENU/EXIT** button to return to normal TV viewing.
- Press the **BACK** button to move to the previous menu screen.

# APPENDIX

## IR CODE LIST

### DVD

BRAND	CODE
PHILIPS	RC6
SAMSUNG	LC7461
TOSHIBA	NEC
PANASONIC	AV162
LG	TC9012
DENON	LRC3715
PIONEER	NEC
HITACHI	NEC
GPX	SAA3004

### DVR-VCR

BRAND	CODE
TIVO S2	uPD6121
SAMSUNG	TC9012
TOSHIBA	NEC
PANASONIC	AV162
PHILIPS	SAA3010
HITACHI	NEC
LG	NEC
MITSUBISHI	JVC
HITACHI	M50110
GO VIDEO	SAA3004

### AUDIO

BRAND	CODE
DENON	LRC3715
YAMAHA	NEC
MARANTZ	SAA3010
INTEGRA, ONKYO	NEC
H/K	NEC
PIONEER	NEC
BOSE	NEC
LEXICON	uPD6121
ROTEL	uPD6121
SHERWOOD	uPD6121
XM	SAA3010
REALISTIC	TC9148
PARASOUND	TC9132P
INSIGNIA	SAA3004

### CBL-SAT

BRAND	CODE
S/A,PIONEER	D6108
MOTOROLA	MOTOROLA
DIRECTV	DIRECTV
MOXI	MOXI
VOOM	BU5962
SAMSUNG	uPD6121
LG	NEC
PIONEER	M50110

# APPENDIX

## RF SPECIFICATIONS

### Wireless Media Box

Items	U-NII-I	U-NII-II	U-NII-II extended	U-NII-III
Frequency range [GHz]	5.15 to 5.25	5.25 to 5.35	5.47 to 5.725	5.725 to 5.825
Transmission	OFDM	OFDM	OFDM	OFDM
RF Output Power (Average) [dBm]	16	16	16	16
Antenna Gain (Peak) [dBi]	3.47	2.93	3.42	3.24
Channel Table [MHz] (Center frequency)	Depends on the country region (Please see the Frequency Table)			
Channel units	2 to 11 Depends on the country region (Please see the Frequency Table)			
Maximum distance (Line of sight, No interference)	15 m Depends on the structure of building.			
Channel bandwidth	40MHz			

- Band channel used by the country could be different.

### Wireless Ready Dongle

Items	U-NII-I	U-NII-II	U-NII-II extended	U-NII-III
Frequency range [GHz]	5.15 to 5.25	5.25 to 5.35	5.47 to 5.725	5.725 to 5.825
Transmission	OFDM	OFDM	OFDM	OFDM
RF Output Power (Average) [dBm]	13	13	13	13
Antenna Gain (Peak) [dBi]	3.36	3.05	2.72	3.17
Channel Table [MHz] (Center frequency)	Depends on the country region (Please see the Frequency Table)			
Channel units	2 to 11 Depends on the country region (Please see the Frequency Table)			
Channel bandwidth	20MHz, 40MHz			

- For USA, FCC ID of RF modules inside Wireless Media box and Ready dongle

Model name: WMDA-119AN  
FCC ID: BEJ-119AN  
IC: 2703H-119AN

Model name: WMDA-118AN  
FCC ID: BEJ-118AN  
IC: 2703H-118AN

- The label sample on the Media box and Ready dongle

 LG AN-WL100W

MODEL NO./NO, MODELE : AN-WL100W

MEDIA NO.: S.....S



POWER : 12V --- 1.1A

MANUFACTURED : Month, 2010

FABRIQUE EN : Month, 2010

FCC ID : BEJANWL100W

LG Twin Towers, 20, Yoido-Dong,  
Youngdeungpo-Gu, Seoul, 150-721, Korea.

This device complies with part 15 of the FCC Rules. Operation is  
subject to the following two conditions: (1) this device may not  
cause harmful interference, and (2) this device must accept any  
interference received, including interference that may cause  
undesired operation.

This Class B digital apparatus complies with Canadian ICES-003.  
Cet appareil numérique de la classe B est conforme à la norme  
NMB-003 du Canada.

Standard Cable Compatible Television Receiving Apparatus - Appareil de  
réception de télévision câblé compatible standard, Canada  
BES-7 / NIMB-7

\* Contains FCCID: BEJ-119AN,  
IC: 2703H-119AN

 **US LISTED**

E236984 3YWO Video Product  
Factory ID: SE

MADE IN KOREA  
FABRIQUE EN COREE  
M262026607 

Contains FCCID : BEJ-118AN  
IC : 2703H-118AN

- The product automatically discontinues transmission in case of either absence of information to transmit or operational failure.

# FREQUENCY TABLE

	BWCH	#36	#40	#44	#48	#52	#56	#60	#64	#100	#104	#108	#112	#116	#120	#124	#128	#132	#136	#140	#149	#153	#157	#161	#165
Argentina / Brazil / Hong Kong / Jordan / Peru / South Africa / Thailand		5.15 GHz to 5.25 GHz				5.25 GHz to 5.35 GHz				5.47 GHz to 5.725 GHz										5.725 GHz to 5.850GHz					
	20 MHz	5180	5200	5220	5240	5260	5280	5300	5320	5500	5520	5540	5560	5580	5600	5620	5640	5660	5680			5745	5765	5785	5805
	40 MHz	5190		5230		5270		5310		5510		5550		5590		5630		5670				5755		5795	
CANADA / US		5.15 GHz to 5.25 GHz				5.25 GHz to 5.35 GHz				5.47 GHz to 5.725 GHz										5.725 GHz to 5.850GHz					
	20 MHz	5180	5200	5220	5240	5260	5280	5300	5320	5500	5520	5540	5560									5745	5765	5785	5805
	40 MHz	5190		5230		5270		5310		5510		5550										5755		5795	
Philippines / Saudi Arabia		5.15 GHz to 5.25 GHz				5.25 GHz to 5.35 GHz				5.47 GHz to 5.725 GHz										5.725 GHz to 5.850GHz					
	20 MHz	5180	5200	5220	5240	5260	5280	5300	5320	5500	5520	5540	5560	5580	5600	5620	5640	5660	5680						
	40 MHz	5190		5230		5270		5310		5510		5550		5590		5630		5670							
Chile / Egypt / Malaysia / Mexico India / Singapore / Columbia Honduras / Nicaragua / Venezuela		5.15 GHz to 5.25 GHz				5.25 GHz to 5.35 GHz				5.47 GHz to 5.725 GHz										5.725 GHz to 5.850GHz					
	20 MHz	5180	5200	5220	5240	5260	5280	5300	5320													5745	5765	5785	5805
	40 MHz	5190		5230		5270		5310														5755		5795	
Israel / Vietnam UAE / Kuwait / Bahrain / Oman / Yemen		5.15 GHz to 5.25 GHz				5.25 GHz to 5.35 GHz				5.47 GHz to 5.725 GHz										5.725 GHz to 5.850GHz					
	20 MHz	5180	5200	5220	5240	5260	5280	5300	5320																
	40 MHz	5190		5230		5270		5310																	
Taiwan		5.15 GHz to 5.25 GHz				5.25 GHz to 5.35 GHz				5.47 GHz to 5.725 GHz										5.725 GHz to 5.850GHz					
	20 MHz							5300	5320	5500	5520	5540	5560	5580	5600	5620	5640	5660	5680			5745	5765	5785	5805
	40 MHz							5310		5510		5550		5590		5630		5670				5755		5795	
Kenya / Uganda		5.15 GHz to 5.25 GHz				5.25 GHz to 5.35 GHz				5.47 GHz to 5.725 GHz										5.725 GHz to 5.850GHz					
	20 MHz	5180	5200	5220	5240					5500	5520	5540	5560									5745	5765	5785	5805
	40 MHz	5190		5230						5510		5550										5755		5795	
China / Qatar Australia / New Zealand / Iran / Pakistan		5.15 GHz to 5.25 GHz				5.25 GHz to 5.35 GHz				5.47 GHz to 5.725 GHz										5.725 GHz to 5.850GHz					
	20 MHz																					5745	5765	5785	5805
	40 MHz																					5755		5795	

- The user can not change or adjust the operating frequency and this product is set for the regional frequency table.

# APPENDIX

## PRODUCT SPECIFICATIONS

MODELS		Wireless Media Box (AN-WL100W)
Dimensions (Width x Height x Depth)		326.0 mm x 42.8 mm x 226.0 mm
Weight		1.5 kg
Power requirement		DC 12 V 1.1 A
Adapter		In : AC 100-240 V~ 50 / 60 Hz Out : DC 12 V 2.5A (Adapter model No. : PA-1031-1 ( LITE-ON) , EADP-30PB B (DELTA) )
MODELS		Wireless Ready Dongle
Dimensions (Width x Height x Depth)		148.0 mm x 23.0 mm x 78.0 mm
Weight		0.2 kg
Environment condition	Operating Temperature	0 °C to 40 °C
	Operating Humidity	Less than 80 %
	Storage Temperature	-20 °C to 60 °C
	Storage Humidity	Less than 85 %

- The specifications shown above may be changed without prior notice for quality improvement.

## TROUBLESHOOTING

The video function does not work.	
No picture & No sound	<ul style="list-style-type: none"> <li>■ Check whether the TV and the Wireless Media Box are turned on.</li> <li>■ Is the power cord inserted correctly into the adapter?</li> <li>■ Is the adapter plug inserted correctly into the Wireless Media Box?</li> </ul>
No or poor colour or poor picture	<ul style="list-style-type: none"> <li>■ Adjust Colour in menu option.</li> <li>■ Are the video cables installed properly?</li> <li>■ Activate any function to restore the brightness of the picture.</li> </ul>
Horizontal/vertical bars or picture shaking	<ul style="list-style-type: none"> <li>■ Check for local interference such as an electrical appliance or power tool.</li> </ul>
No picture when connecting HDMI	<ul style="list-style-type: none"> <li>■ Check that your HDMI cable is High Speed HDMI Cable. If the HDMI cables are not High Speed HDMI Cable, flickering or no screen display can result. Please use the High Speed HDMI Cable.</li> </ul>

**The audio function does not work.**

Picture OK & No sound	<ul style="list-style-type: none"> <li>■ Press the VOL +/- or (◀ +/-) button.</li> <li>■ Sound muted? Press MUTE button.</li> <li>■ Are the audio cables installed properly?</li> </ul>
No output from one of the speakers	<ul style="list-style-type: none"> <li>■ Adjust <b>Balance</b> in menu option.</li> </ul>
No sound when connecting HDMI	<ul style="list-style-type: none"> <li>■ Check HDMI cable is High Speed HDMI Cable.</li> </ul>

**There is a problem in PC mode. (Only PC mode applied)**

The signal is out of range (Invalid format)	<ul style="list-style-type: none"> <li>■ Adjust resolution, horizontal frequency, or vertical frequency.</li> <li>■ Check the input source.</li> </ul>
Vertical bar or stripe on background & Horizontal Noise & Incorrect position	<ul style="list-style-type: none"> <li>■ Use Auto configure or adjust clock, phase, or H/V position. (Option)</li> </ul>
Screen colour is unstable or single colour	<ul style="list-style-type: none"> <li>■ Check the signal cable.</li> <li>■ Reinstall the PC video card.</li> </ul>

**This is when there is an issue with the wireless connection.**

Connecting Wireless TV screen is not displayed.	<ul style="list-style-type: none"> <li>■ Check the connection of the 20 pin cable (Power/Control) between the Wireless Ready TV and Wireless Ready Dongle. (Refer to the p. 6)</li> <li>■ Set up the external input of TV to wireless input.</li> <li>■ Check the connection of the HDMI cable between the Wireless Ready TV and Wireless Ready Dongle. (Refer to the p. 6)</li> </ul>
"Connecting wireless" screen is displayed but the wireless input is not activated.	<ul style="list-style-type: none"> <li>■ Check whether the power of the Wireless Media Box is turned on. (Refer to the p. 17)</li> <li>■ Check whether an external device is connected to Wireless Media Box. Only the wireless input with the external device connected will be activated.</li> </ul>
It reconnects after wireless connection is established	<ul style="list-style-type: none"> <li>■ This happens when there is wireless interference from surrounding devices or when the wireless signal is weak. Check the installation range of the Wireless Media Box. (Refer to the p. 9)</li> </ul>
Screen is distorted after the wireless connection.	<ul style="list-style-type: none"> <li>■ This can happen when the wireless signal is weak. Check the installation range of the Wireless Media Box. (Refer to the p. 9)</li> </ul>
After wireless connection is established, horizontal line patterns are instantly shown on the screen.	<ul style="list-style-type: none"> <li>■ This can happen when there are wireless devices using 5 GHz Band. Keep products that interfere with wireless reception with Wireless Media Box at least 5m away. (Refer to the p. 9)</li> </ul>

# APPENDIX

## OPEN SOURCE SOFTWARE NOTICE

The following GPL executables and LGPL, MPL libraries used in this product are subject to the GPL2.0/LGPL2.1/MPL1.1 License Agreements:

### GPL EXECUTABLES:

Linux kernel 2.6, busybox, e2fsprogs, gdbserver, jfsutils, mtd-utils, procps, u-boot, udhcpc

### LGPL LIBRARIES:

Cairo, directFB, gconv, gettext, glib, glibc, iconv, pixman

### MPL LIBRARIES:

Nanox

LG Electronics offers to provide source code to you on CD-ROM for a charge covering the cost of performing such distribution, such as the cost of media, shipping and handling upon e-mail request to LG Electronics at: [opensource@lge.com](mailto:opensource@lge.com)

This offer is valid for a period of three (3) years from the date of the distribution of this product by LG Electronics.

You can obtain a copy of the GPL, LGPL, MPL licenses on the CD-ROM provided with this product.

Also you can obtain the translation of GPL, LGPL licenses from <http://www.gnu.org/licenses/old-licenses/gpl-2.0-translations.html>, <http://www.gnu.org/licenses/old-licenses/lgpl-2.1-translations.html>.

This product includes other open source software

- ▶ expat:
  - copyright © 1998, 1999, 2000 Thai Open Source Software Center Ltd and Clark Cooper
  - copyright © 2001, 2002, 2003, 2004, 2005, 2006 Expat maintainers.
- ▶ freetype: copyright © 2003 The FreeType Project ([www.freetype.org](http://www.freetype.org)).
- ▶ ICU: copyright © 1995-2008 International Business Machines Corporation and others.
- ▶ libcurl: copyright © 1996 - 2008, Daniel Stenberg.
- ▶ libjpeg: This software is based in part on the work of the Independent JPEG Group copyright © 1991 – 1998, Thomas G. Lane.
- ▶ libmng: copyright © 2000-2007 Gerard Juyn, Glenn Randers-Pehrson
- ▶ libpng: copyright © 1998-2008 Glenn Randers-Pehrson
- ▶ ncurses: copyright © 1998 Free Software Foundation, Inc.
- ▶ openssl:
  - cryptographic software written by Eric Young.
  - software written by Tim Hudson.
  - software developed by the OpenSSL Project for use in the OpenSSL Toolkit. (<http://www.openssl.org>)
- ▶ strace :
  - copyright © 1991, 1992 Paul Kranenburg.
- ▶ copyright © 1993 Branko Lankester.
  - copyright © 1993 Ulrich Pegelow.
  - copyright © 1995, 1996 Michael Elizabeth Chastain.
  - copyright © 1993, 1994, 1995, 1996 Rick Sladkey.
  - copyright © 1998-2003 Wichert Akkerman.
  - copyright © 2002-2008 Roland McGrath.
  - copyright © 2003-2008 Dmitry V. Levin.
  - copyright © 2007-2008 Jan Kratochvil.
- ▶ zlib: copyright © 1995-2005 Jean-loup Gailly and Mark Adler

All rights reserved.

Permission is hereby granted, free of charge, to any person obtaining a copy of this software and associated documentation files (the "Software"), to deal in the Software without restriction, including without limitation the rights to use, copy, modify, merge, publish, distribute, sublicense, and/or sell copies of the Software, and to permit persons to whom the Software is furnished to do so, subject to the following conditions:

THE SOFTWARE IS PROVIDED "AS IS", WITHOUT WARRANTY OF ANY KIND, EXPRESS OR IMPLIED, INCLUDING BUT NOT LIMITED TO THE WARRANTIES OF MERCHANTABILITY, FITNESS FOR A PARTICULAR PURPOSE AND NONINFRINGEMENT. IN NO EVENT SHALL THE AUTHORS OR COPYRIGHT HOLDERS BE LIABLE FOR ANY CLAIM, DAMAGES OR OTHER LIABILITY, WHETHER IN AN ACTION OF CONTRACT, TORT OR OTHERWISE, ARISING FROM, OUT OF OR IN CONNECTION WITH THE SOFTWARE OR THE USE OR OTHER DEALINGS IN THE SOFTWARE.





Record the model number and serial number of the TV.

Refer to the label on the back cover and quote this information to your dealer when requiring any service.

Model : \_\_\_\_\_

Serial No. : \_\_\_\_\_