



**LG**

Life's Good

# OWNER'S MANUAL LCD TV

Please read this manual carefully before operating your set and retain it for future reference.



HDMI, the HDMI logo and High-Definition Multimedia Interface are trademarks or registered trademarks of HDMI Licensing LLC.

# ACCESSORIES

Ensure that the following accessories are included with your TV. If an accessory is missing, please contact the dealer where you purchased the product.

■ Image shown may differ from your TV.

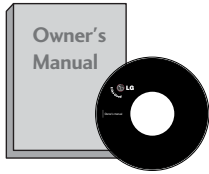

Owner's Manual

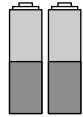

Batteries



Remote Control



Power Cord



**Polishing Cloth**  
Polishing cloth for use on the screen  
This feature is not available for all models.

\*Lightly wipe any stains or fingerprints on the surface of the TV with the polishing cloth.

Do not use excessive force. This may cause scratching or discolouration.

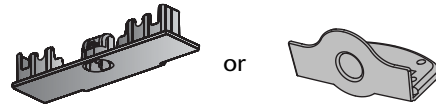

Protection Cover  
(Refer to p. 9)



x 4

**Bolts for stand assembly**  
(Refer to p.6)  
(Only 26/32LD310)



**1-Screw for stand fixing**  
(Refer to p. 8)  
(Only 26/32LD310)



**Cable Management Clip**  
(Refer to p. 7)  
(Only 19/22LD310)

## Wall Mounting Bracket (Separate purchase)

RW120

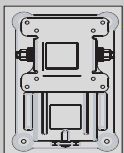

(19/22LD310)

RW230

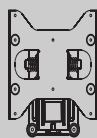

(26/32LD310)

AW-47LG30M

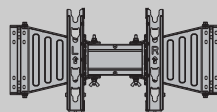

(32LD310)

# CONTENTS

## ACCESSORIES ..... 1

### PREPARATION

Front Panel Controls.....	4
Back Panel Information .....	5
Stand Installation.....	6
Back Cover for Wire Arrangement.....	7
Attaching the TV to a desk .....	8
Positioning your display.....	8
Swivel Stand .....	8
Not using the desk-type stand.....	9
Kensington Security System .....	10
Careful Installation Advice .....	10
Desktop Pedestal Installation .....	11
Wall Mount: Horizontal installation.....	11
Antenna Connection .....	12

### EXTERNAL EQUIPMENT SETUP

HD Receiver Setup .....	13
DVD Setup.....	15
VCR Setup .....	17
Other A/V Source Setup.....	18
External Stereo Setup .....	18

### WATCHING TV / PROGRAMME CONTROL

Remote Control Key Functions.....	20
Turning on the TV .....	22
Installation Guide .....	22
Programme Selection .....	22
Volume Adjustment.....	22
On Screen Menus Selection and Adjustment .....	23

Auto Programme Tuning.....	24
Manual Programme Tuning .....	25
Fine Tuning .....	26
Assigning a Station Name .....	27
Programme Edit .....	28
Favourite Programme .....	29
Selecting the Programme List .....	30
Key lock.....	31
Factory Reset .....	32

### PICTURE CONTROL

Picture Size (Aspect Ratio)Control .....	33
Preset Picture Settings	
- Picture Mode-Preset.....	34
Manual Picture Adjustment	
- Picture Mode-User option .....	35
Picture Improvement Technology.....	36
Picture Reset .....	38
Power Indicator.....	38
Screen Setup .....	39
- Manual Configure (Adjustment for screen Position) .	39
- Initializing (Reset to original factory settings) .....	40

**SOUND & LANGUAGE CONTROL**

Preset Sound Settings - Sound Mode .....	41
Sound Setting Adjustment - User Mode .....	42
Auto Volume Leveler .....	43
Balance .....	44
Audio Reset .....	45
I/II	
- Stereo/Dual Reception .....	46
- NICAM Reception .....	47
- Speaker Sound Output Selection .....	47
On-Screen Menu Language Selection .....	48

**TIME SETTING**

Clock Setup .....	49
Auto On/Off Timer Setting .....	50
Sleep Timer Setting .....	51

**TELETEXT**

Switch On/Off .....	52
SIMPLE Text .....	52
TOP Text .....	53
FASTEXT .....	53
Special Teletext Functions .....	54

**APPENDIX**

Troubleshooting .....	55
Maintenance .....	57
Product Specifications .....	58
IR Codes .....	59

# PREPARATION

## FRONT PANEL CONTROLS

- This is a simplified representation of the front panel. Image shown may differ from your TV.

### 19/22/26/32LD310

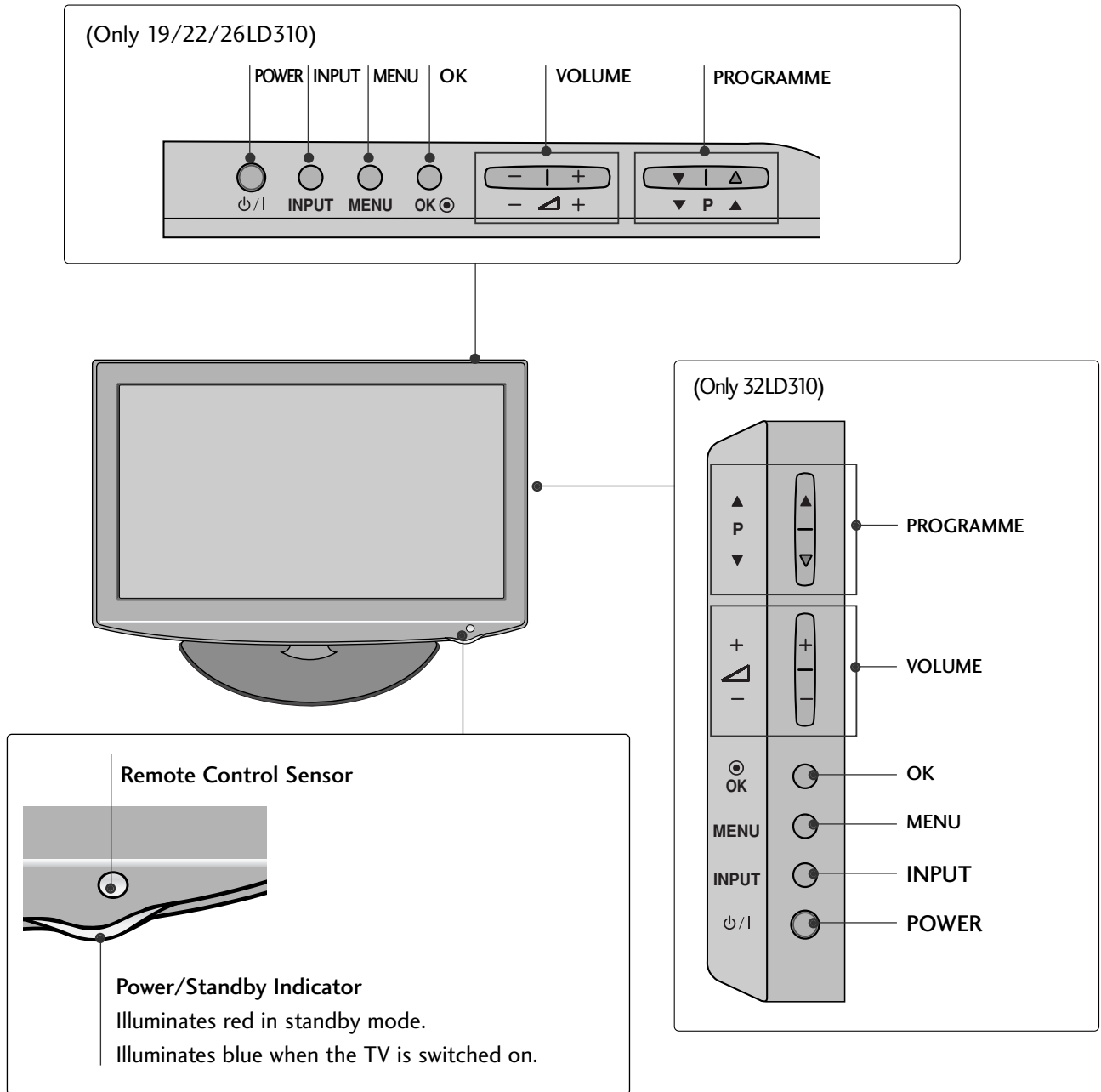

# BACK PANEL INFORMATION

■ Image shown may differ from your TV.

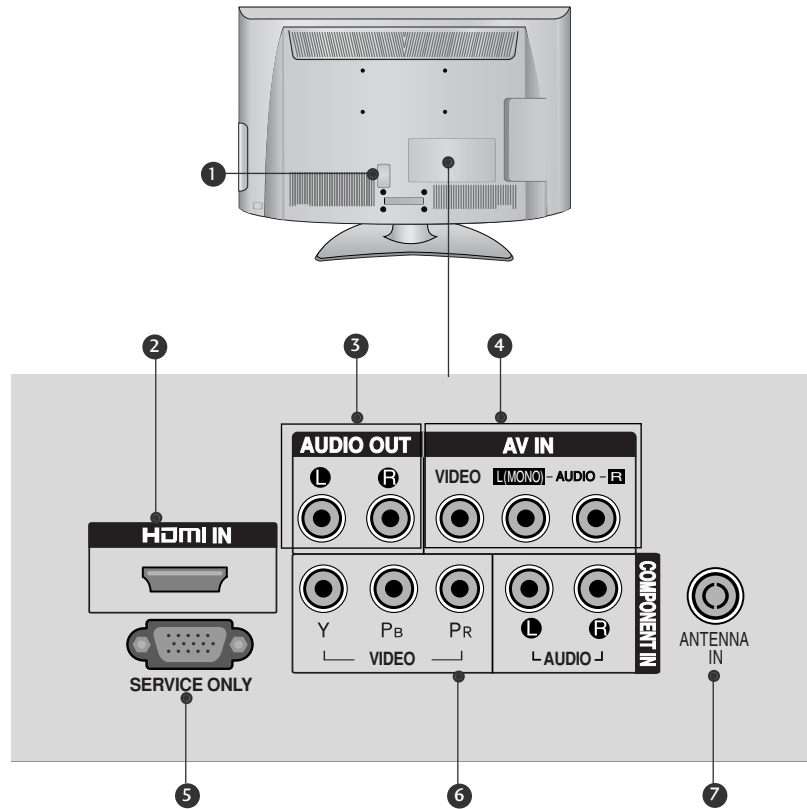

- 1 Power Cord Socket**  
 This TV operates on an AC power. The voltage is indicated on the Specifications page. Never attempt to operate the TV on DC power.
- 2 HDMI Input**  
 Connect a HDMI signal to HDMI IN.  
 This TV does not support DVI(VIDEO) signal using DVI to HDMI cable.
- 3 Audio Output**  
 Connect an external amplifier, or add a subwoofer to your surround sound system.
- 4 Audio/Video Input (AV IN)**  
 Connect audio/video output from an external device to these jacks.
- 5 SERVICE ONLY PORT**
- 6 Component Input**  
 Connect a component video/audio device to these jacks.
- 7 Antenna Input**  
 Connect RF antenna to this jack.

# PREPARATION

## STAND INSTALLATION

■ Image shown may differ from your TV

When assembling the desk type stand, check whether the bolt is fully tightened. (If not tightened fully, the product can tilt forward after the product installation.) If you tighten the bolt with excessive force, the bolt can deviate from abrasion of the tightening part of the bolt.

### Only 19/22LD310

- 1 Carefully place the TV screen side down on a cushioned surface to protect the screen from damage.

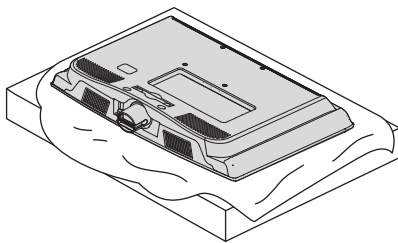

- 2 Assemble the TV as shown.

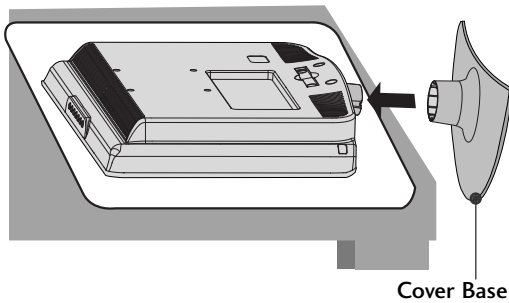

### Only 26/32LD310

- 1 Carefully place the TV screen side down on a cushioned surface to protect the screen from damage.

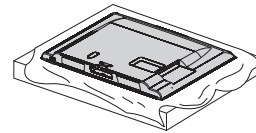

- 2 Assemble the TV as shown.

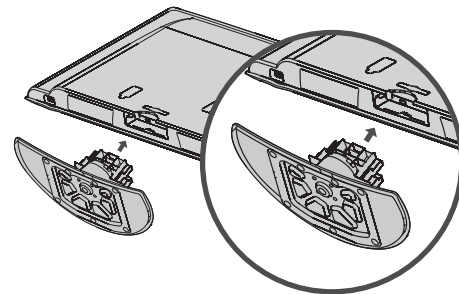

- 3 Fix the 4 bolts securely using the holes in the back of the TV.

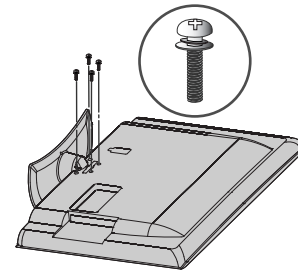



# BACK COVER FOR WIRE ARRANGEMENT

■ Image shown may differ from your TV.

## Only 19/22LD310

- 1 Connect the cables as necessary.  
To connect additional equipment, see the **External Equipment Setup** section of the manual.

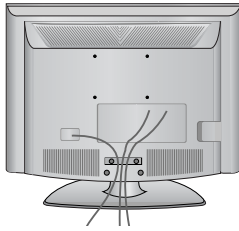

- 2 Install the **CABLE MANAGEMENT CLIP** as shown.

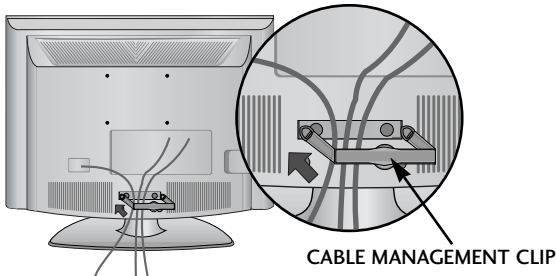

- 3 Fit the **CABLE MANAGEMENT CLIP** as shown.

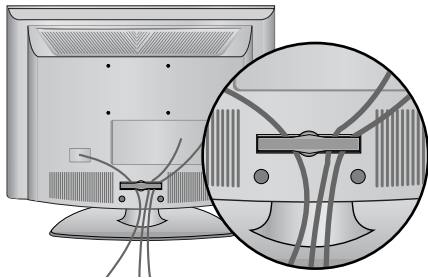

### How to remove the cable management clip (Only 19/22LD310)

Hold the **CABLE MANAGEMENT CLIP** with both hands and pull it backward.

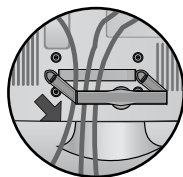

## Only 26/32LD310

- 1 Connect the cables as necessary.  
To connect additional equipment, see the **External Equipment Setup** section of the manual.

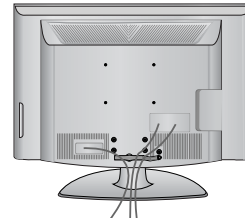

- 2 Open the **CABLE MANAGEMENT CLIP** as shown and manage the cables.

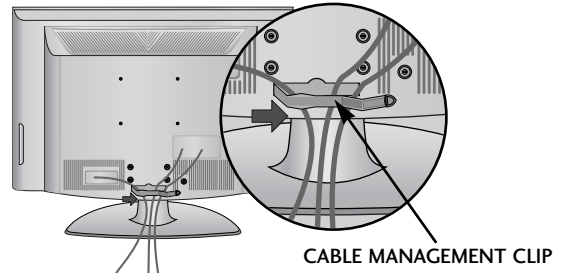

- 3 Fit the **CABLE MANAGEMENT CLIP** as shown.

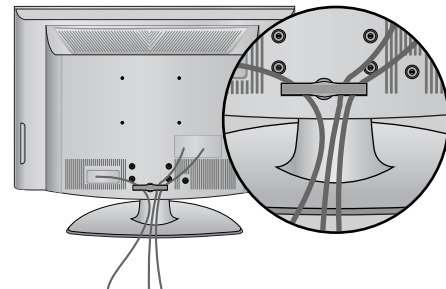

### NOTE

- ▶ Do not use the **CABLE MANAGEMENT CLIP** to lift the TV.
- If the TV is dropped, you may be injured or the TV may be damaged.

# PREPARATION

PREPARATION

## ATTACHING THE TV TO A DESK

(Only 26/32LD310)

- Image shown may differ from your TV.  
The TV must be attached to desk so it cannot be pulled in a forward/backward direction, potentially causing injury or damaging the product. Use only an attached screw.

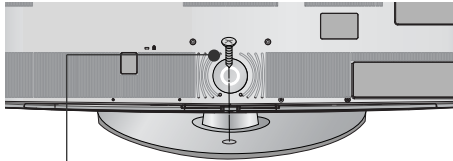

1-Screw  
(provided as parts of the product)

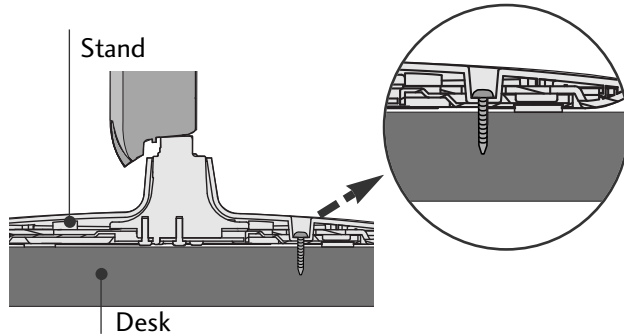

### ⚠ WARNING

- ▶ To prevent TV from falling over, the TV should be securely attached to the floor/wall per installation instructions. Tipping, shaking, or rocking the machine may cause injury.

## POSITIONING YOUR DISPLAY

(Only 19/22LD310)

- Image shown may differ from your TV.
- Adjust the position of the panel in various ways for maximum comfort.
- Tilt range

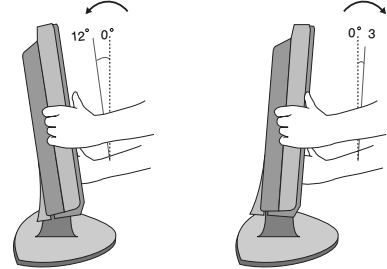

## SWIVEL STAND

(Only 26/32LD310)

- Image shown may differ from your TV.  
After installing the TV, you can adjust the TV set manually to the left or right direction by 20 degrees to suit your viewing position.

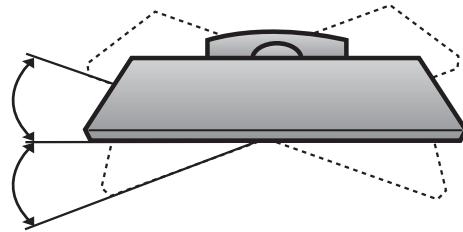

# NOT USING THE DESK-TYPE STAND

■ Image shown may differ from your TV.

When installing the wall-mounted unit, use the protection cover.

## Only 19/22LD310

- 1 Carefully place the TV screen side down on a cushioned surface to protect the screen from damage.

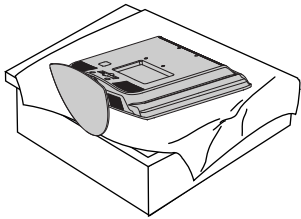

- 2 Loosen the bolts from the TV.

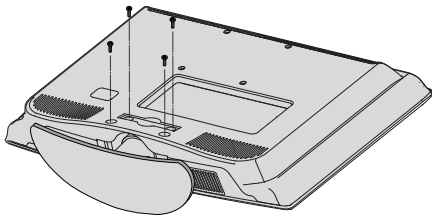

- 3 Detach the stand from the TV.

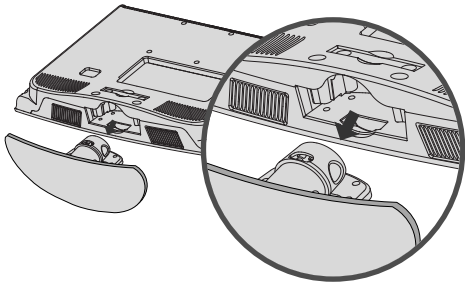

- 4 Insert the **Protection Cover** into the TV.

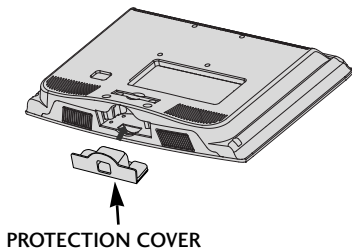

- 5 Fix the 4 bolts securely using the holes in the back of the TV.

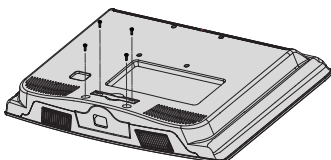

## Only 26/32LD310

- 1 Carefully place the TV screen side down on a cushioned surface to protect the screen from damage.

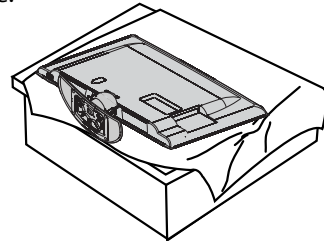

- 2 Loosen the bolts from the TV.

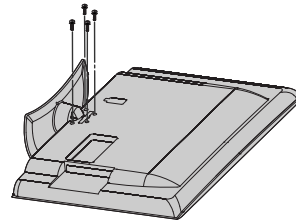

- 3 Detach the stand from the TV.

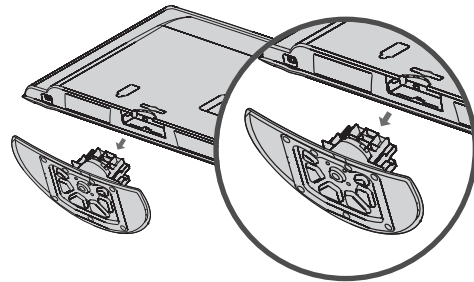

- 4 Insert the **PROTECTION COVER** into the TV until clicking sound.

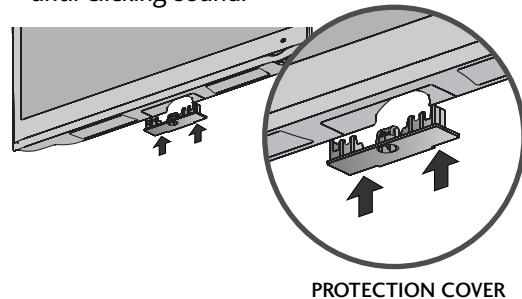

# PREPARATION

## KENSINGTON SECURITY SYSTEM

- This feature is not available for all models.
- Image shown may differ from your TV.

The TV is equipped with a Kensington Security System connector on the back panel. Connect the Kensington Security System cable as shown below. For the detailed installation and use of the Kensington Security System, refer to the user's guide provided with the Kensington Security System.

For further information, contact <http://www.kensington.com>, the internet homepage of the Kensington company. Kensington sells security systems for expensive electronic equipment such as notebook PCs and LCD projectors.

### NOTE

- The Kensington Security System is an optional accessory.

### NOTES

- If the TV feels cold to the touch, there may be a small "flicker" when it is turned on. This is normal, there is nothing wrong with TV.
- Some minute dot defects may be visible on the screen, appearing as tiny red, green, or blue spots. However, they have no adverse effect on the monitor's performance.
- Avoid touching the LCD screen or holding your finger(s) against it for long periods of time. Doing so may produce some temporary distortion effects on the screen.

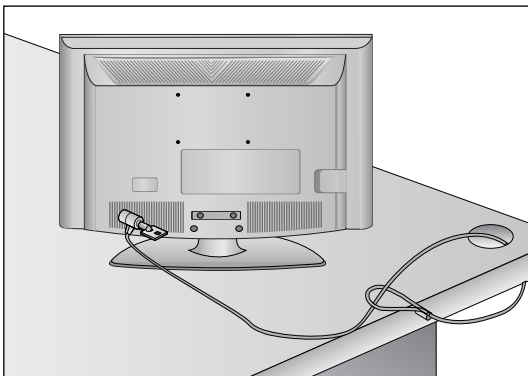

## CAREFUL INSTALLATION ADVICE

- You should purchase necessary components to fix the TV safely and secure to the wall on the market.
- Position the TV close to the wall to avoid the possibility of it falling when pushed.
- The instructions shown below are a safer way to set up the TV, by fixing it to the wall, avoiding the possibility of it falling forwards if pulled. This will prevent the TV from falling forward and causing injury. This will also prevent the TV from damage. Ensure that children do not climb or hang from the TV.

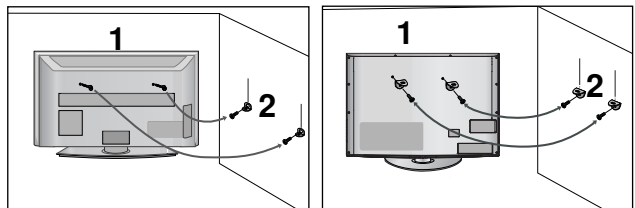

- 1 Use the eye-bolts or TV brackets/bolts to fix the product to the wall as shown in the picture. (If your TV has bolts in the eyebolts, loosen then bolts.)  
\* Insert the eye-bolts or TV brackets/bolts and tighten them securely in the upper holes.
- 2 Secure the wall brackets with the bolts on the wall. Match the height of the bracket that is mounted on the wall.

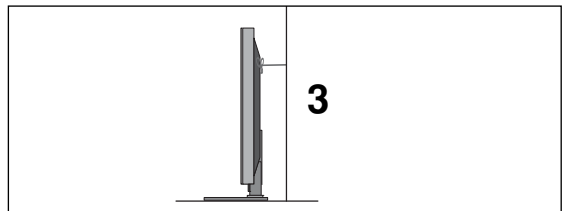

- 3 Use a sturdy rope to tie the product for alignment. It is safer to tie the rope so it becomes horizontal between the wall and the product.

### ! NOTE

- ▶ When moving the TV undo the cords first.
- ▶ Use a platform or cabinet strong and large enough to support the size and weight of the TV.
- ▶ To use the TV safely make sure that the height of the bracket on the wall and on the TV is the same.

- The TV can be installed in various ways such as on a wall, or on a desktop etc.
- The TV is designed to be mounted horizontally.

### EARTHING

Ensure that you connect the earth wire to prevent possible electric shock. If grounding methods are not possible, have a qualified electrician install a separate circuit breaker.

Do not try to earth the TV by connecting it to telephone wires, lightning rods or gas pipes.

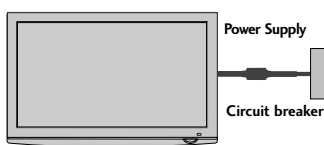

### DESKTOP PEDESTAL INSTALLATION

For adequate ventilation allow a clearance of 4" (10cm) all around the TV.

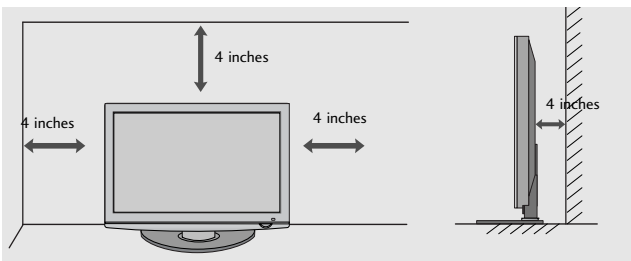

## WALL MOUNT: HORIZONTAL INSTALLATION

- We recommend the use of a LG Brand wall mounting bracket when mounting the TV to a wall.
- We recommend that you purchase a wall mounting bracket which supports VESA standard.
- LG recommends that wall mounting be performed by a qualified professional installer.

### NOTE

- ▶ Should Install wall mount on a solid wall perpendicular to the floor.
- ▶ Should use a special wall mount, if you want to install it to ceiling or slanted wall.
- ▶ The surface that wall mount is to be mounted on should be of sufficient strength to support the weight of TV set; e.g. concrete, natural rock, brick and hollow block.
- ▶ Installing screw type and length depends on the wall mount used. Further information, refer to the instructions included with the mount.
- ▶ LG is not liable for any accidents or damage to property or TV due to incorrect installation:
  - Where a non-compliant VESA wall mount is used.
  - Incorrect fastening of screws to surface which may cause TV to fall and cause personal injury.
  - Not following the recommended Installation method.

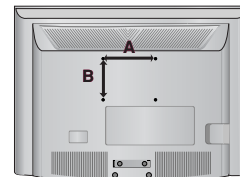
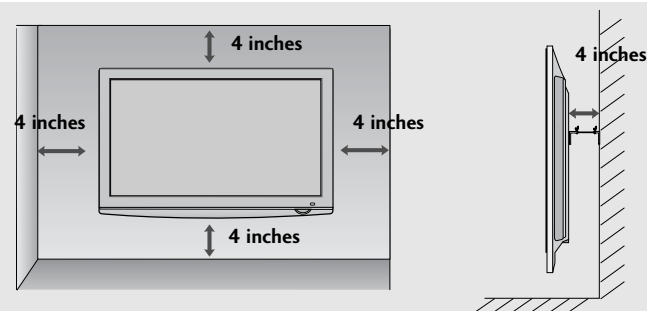

Model	VESA (A * B)	Standard Screw	Quantity
19/22LD310	100 * 100	M4	4
26/32LD310	200 * 100	M4	4

# PREPARATION

- To prevent damage do not connect to the mains outlet until all connections are made between the devices.

## ANTENNA CONNECTION

- For optimum picture quality, adjust antenna direction.
- An antenna cable and converter are not supplied.

PREPARATION

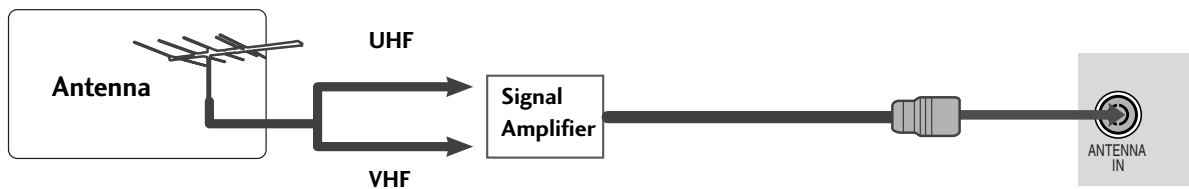
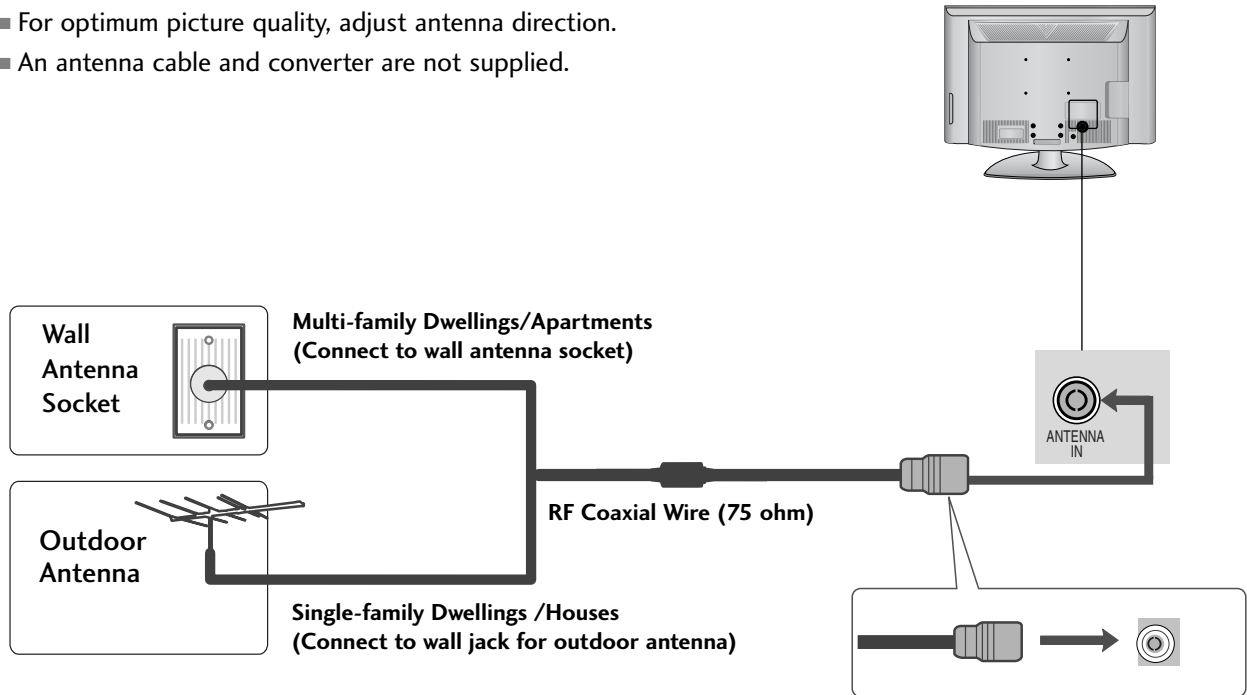

- In poor signal areas, to achieve better picture quality it may be necessary to install a signal amplifier to the antenna as shown above.
- If signal needs to be split for two TVs, use an antenna signal splitter for connection.

# EXTERNAL EQUIPMENT SETUP

- To avoid damaging any equipment, never plug in any power cords until you have finished connecting all equipment.
- Image shown may differ from your TV.

## HD RECEIVER SETUP

### Connecting with a component cable

- 1 Connect the video outputs (Y, Pb, Pr) of the digital set-top box to the **COMPONENT IN VIDEO** jacks on the TV.
- 2 Connect the audio output of the digital set-top box to the **COMPONENT IN AUDIO** jacks on the TV.
- 3 Turn on the digital set-top box.  
(Refer to the owner's manual for the digital set-top box.)
- 4 Select **Component** input source using the **INPUT** button on the remote control.

Signal	Component
480i/576i	O
480p/576p	O
720p	O
1080i/ 1080p	X

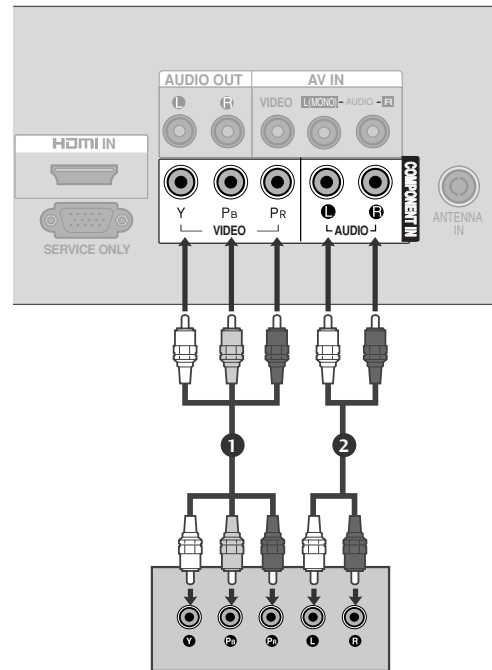

# EXTERNAL EQUIPMENT SETUP

## Connecting a set-top box with a HDMI cable

- 1 Connect the HDMI output of the digital set-top box to the **HDMI IN** jack on the TV.
- 2 Select **HDMI** input source using the **INPUT** button on the remote control.
- 3 Turn on the digital set-top box.  
(Refer to the owner's manual for the digital set-top box.)

### NOTE

- ▶ TV can receive the video and audio signal simultaneously with using a HDMI cable.
- ▶ If the digital set-top box supports Auto HDMI function, the output resolution of the source device will be automatically TV to 1280x720p.
- ▶ If the digital set-top box player does not support Auto HDMI, you need to TV the output resolution appropriately.  
To get the best picture quality, adjust the output resolution of the source device to 1280x720p .
- ▶ We recommend less than 10m for HDMI cable.

Signal	HDMI
480i/576i	X
480p/576p	O
720p	O
1080i/ 1080p	X

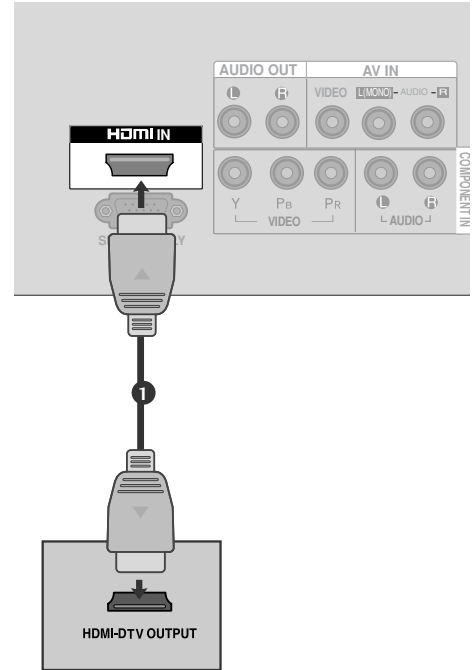



# DVD SETUP

## Connecting with a component cable

- 1 Connect the video outputs (Y, Pb, Pr) of the DVD to the **COMPONENT IN VIDEO** jacks on the TV.
- 2 Connect the audio outputs of the DVD to the **COMPONENT IN AUDIO** jacks on the TV.
- 3 Turn on the DVD player, insert a DVD.
- 4 Select **Component** input source using the **INPUT** button on the remote control.
- 5 Refer to the DVD player's manual for operating instructions.

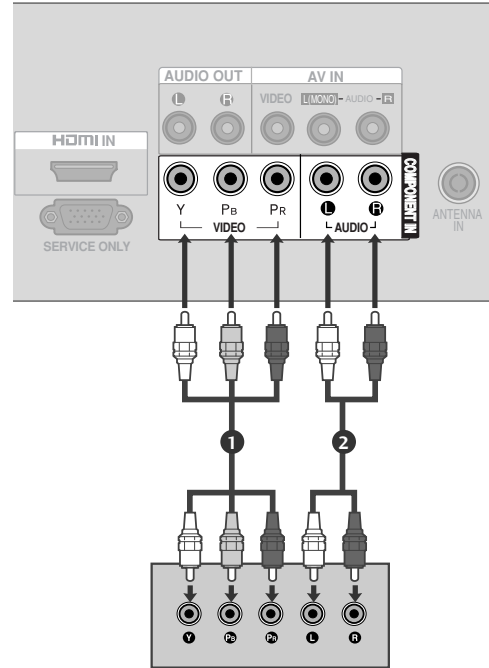

### Component Input ports

To achieve better picture quality, connect a DVD player to the component input ports as shown below.

Component ports on the TV	Y	P <sub>B</sub>	P <sub>R</sub>
Video output ports on DVD player	Y	P <sub>B</sub>	P <sub>R</sub>
	Y	B-Y	R-Y
	Y	Cb	Cr
	Y	Pb	Pr

# EXTERNAL EQUIPMENT SETUP

## Connecting with a HDMI cable

- 1 Connect the HDMI output of the DVD to the **HDMI IN** jack on the TV.
- 2 Select **HDMI** input source using the **INPUT** button on the remote control.
- 3 Refer to the DVD player's manual for operating instructions.

### ! NOTE

- ▶ The TV can receive video and audio signals simultaneously when using a HDMI cable.
  - ▶ If the DVD player supports Auto HDMI function, the output resolution of the source device will be automatically TV to 1280x720p.
  - ▶ If the DVD player does not support Auto HDMI, you must TV the output resolution appropriately.
- To get the best picture quality, adjust the output resolution of the source device to 1280x720p.
- ▶ We recommend less than 10m for HDMI cable.

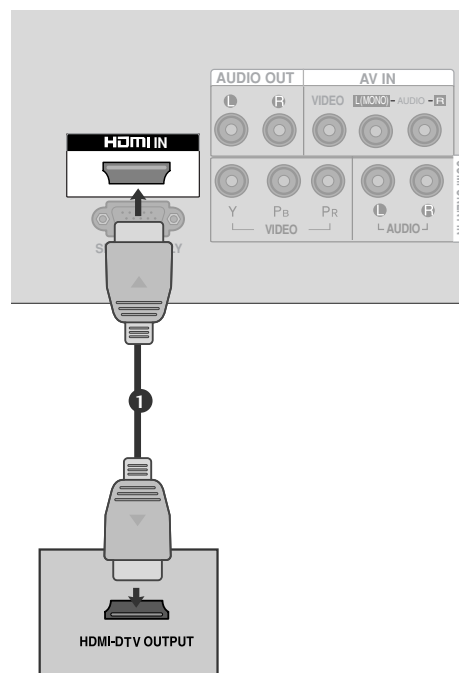

## VCR SETUP

- To avoid picture noise (interference), allow adequate distance between the VCR and TV.

### Connecting with a RF cable

- 1 Connect the **ANT OUT** socket of the VCR to the **ANTENNA IN** socket on the TV.
- 2 Connect the antenna cable to the **ANT IN** socket of the VCR.
- 3 Press the **PLAY** button on the VCR and match the appropriate programme between the TV and VCR for viewing.

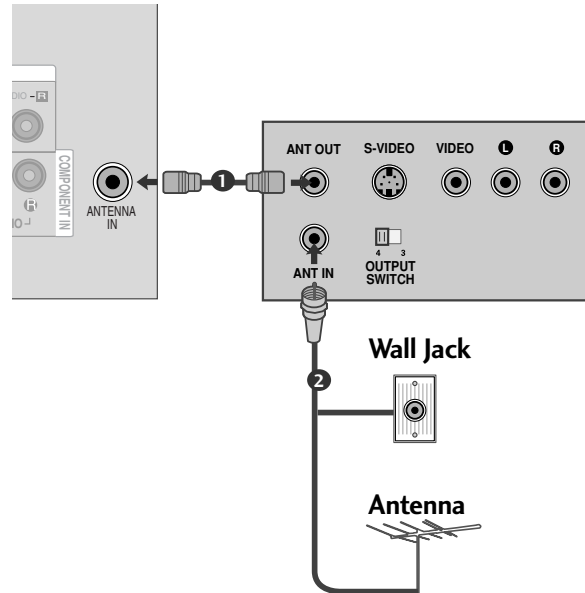

### Connecting with a RCA cable

- 1 Connect the **AUDIO/VIDEO** jacks between TV and VCR. Match the jack colours (Video = yellow, Audio Left = white, and Audio Right = red)
- 2 Insert a video tape into the VCR and press **PLAY** on the VCR. (Refer to the VCR owner's manual.)
- 3 Select **AV** input source using the **INPUT** button on the remote control.

#### NOTE

- ▶ If you have a mono VCR, connect the audio cable from the VCR to the **AUDIO L/MONO** jack of the TV.

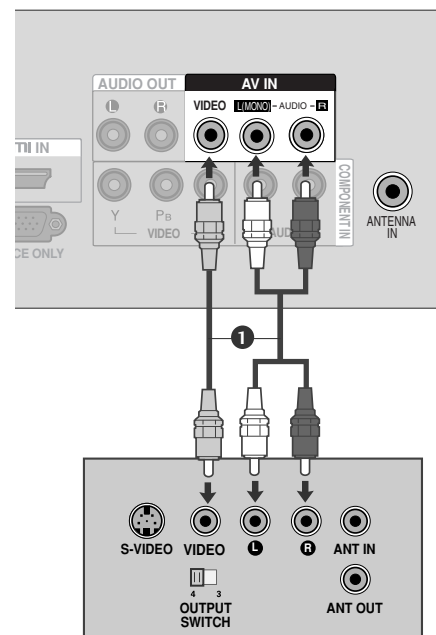

# EXTERNAL EQUIPMENT SETUP

## OTHER A/V SOURCE SETUP

- 1 Connect the **AUDIO/VIDEO** jacks between TV and external equipment. Match the jack colours. (Video = yellow, Audio Left = white, and Audio Right = red)
- 2 Select **AV** input source using the **INPUT** button on the remote control. If connected to **AV IN**, select **AV** input source.
- 3 Operate the corresponding external equipment. Refer to external equipment operating guide.

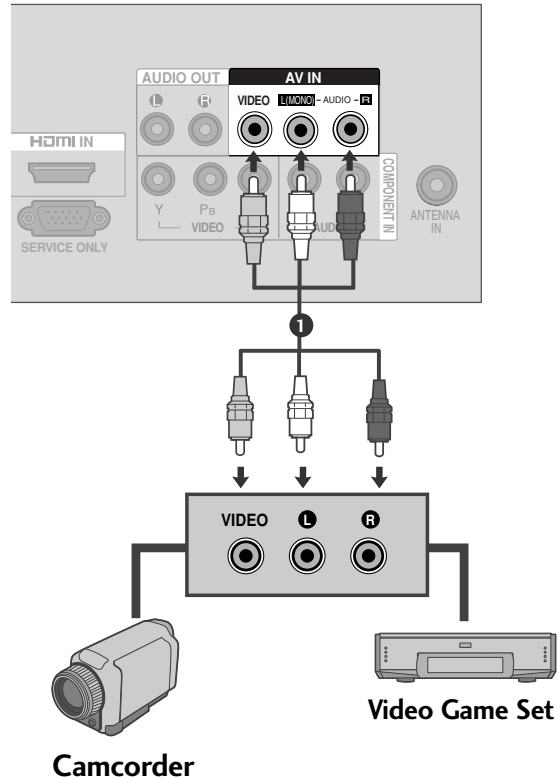

## EXTERNAL STEREO SETUP

Use to connected either an external amplifier, or add a sub-woofer to your surround sound system.

- 1 Connect the input jack of the stereo amplifier to the **AUDIO OUT** jacks on the TV.
- 2 Set up your speakers through your analog stereo amplifier, according to the instructions provided with the amplifier.

### ! NOTE

► This function works in following mode : TV, AV, Component, HDMI

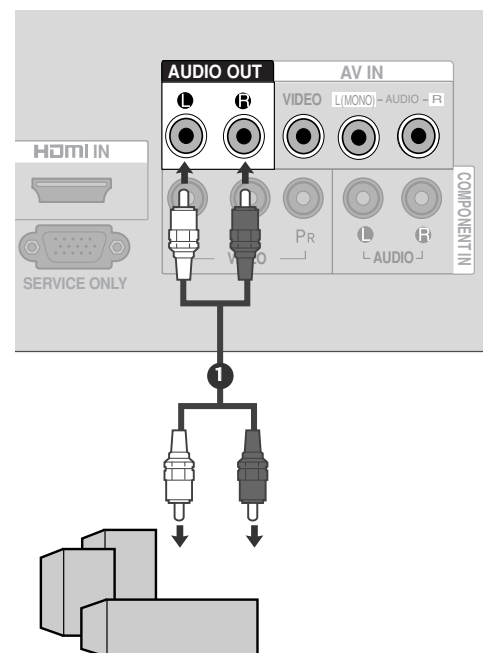

## Supported Display Resolution

### HDMI-DTV mode

Resolution	Horizontal Frequency(kHz)	Vertical Frequency(Hz)
720x480	31.47	59.94
	31.5	60.00
720x576	31.25	50.00
1280x720	44.96	59.94
	45	60.00
	37.50	50.00

### ! NOTE

- ▶ HDMI mode supports PCM audio format only.
- ▶ If the Audio setting is set to Dolby/DTS/Bitstream in some DVDP/STB, make sure to change the setting to PCM.
- ▶ If the resolution of external equipment is over 1280x720p, there will be no picture on the TV.

# WATCHING TV / PROGRAMME CONTROL

## REMOTE CONTROL KEY FUNCTIONS

When using the remote control, aim it at the remote control sensor on the TV.

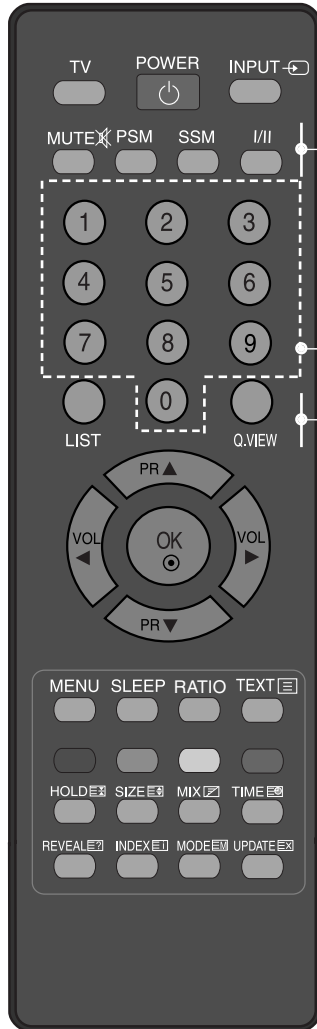

**POWER** Switches the set on from standby or off to standby.

**TV** Returns to the TV viewing from any mode.

**INPUT** If you press the button once, the input source OSD will appear on screen as shown. Press the ▲ / ▼ button and then OK button to select the desired input source.

**MUTE** Switches the sound on or off.

**PSM** Recalls your preferred picture setting.

**SSM** Recalls your preferred sound setting.

**I/II** Selects the sound output. (▶ p.46)

**0~9 number button** Selects a programme.

Selects numbered items in a menu.

**LIST** Displays the programme table.

**Q.VIEW** Returns to the previously viewed programme.

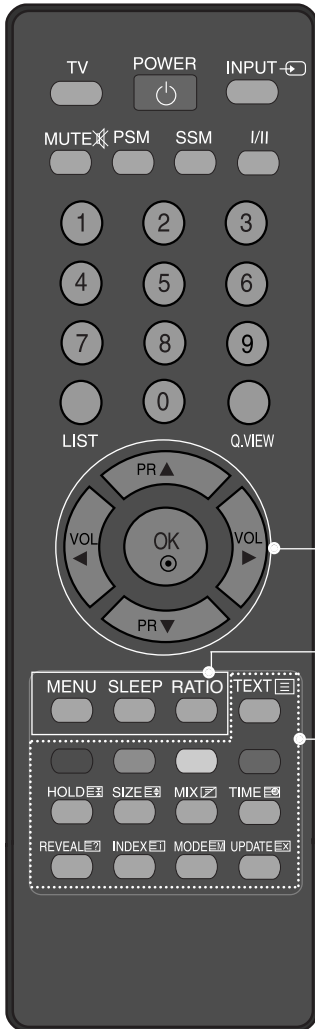

**THUMBSTICK** (Up/Down/Left/Right) Allows you to navigate the on-screen menus and adjust the system settings to your preference.  
Adjusts the volume.  
Selects a programme.

**OK** Accepts your selection or displays the current mode.

**MENU** Selects a menu. (▶ p.23)

**SLEEP** Sets the sleep timer.

**RATIO** Selects your desired picture format. (▶ p.33)

**Coloured buttons** These buttons are used for teletext (on **TELETEXT** models only) or **Programme edit**.

**TELETEXT BUTTONS** These buttons are used for teletext.  
For further details, see the 'Teletext' section. (▶ p.52)

## Installing Batteries

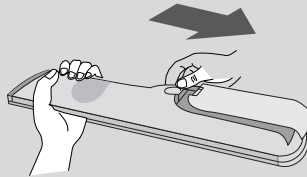

- Open the battery compartment cover on the back side and install the batteries matching correct polarity (+with +,-with -).
- Install two 1.5V AAA batteries. Don't mix old or used batteries with new ones.
- Close cover.

# WATCHING TV / PROGRAMME CONTROL

## TURNING ON THE TV

When your TV is turned on, you will be able to use its features.

---

- 1 Firstly, connect the power cord correctly.  
At this stage, the TV switches to standby mode.
    - In standby mode to turn TV on, press the  $\phi$ /I button on the TV or press the **POWER** buttons on the remote control and the TV will switch on.
- 

## Installation Guide

---

- 1 If the OSD (On Screen Display) is displayed on the screen after turning on the TV, you can adjust the **Language, Auto Tuning**.  
**Note:**
    - a. It will automatically disappear after approx. 40 seconds unless a button is pressed.
    - b. If you close without completing the initial setting, the **Installation Guide** menu can be displayed again.
- 

## PROGRAMME SELECTION

---

- 1 Press the  $\blacktriangle$  /  $\blacktriangledown$  or **NUMBER** buttons to select a programme number.
- 

## VOLUME ADJUSTMENT

---

- 1 Press the  $\blacktriangleleft$  /  $\blacktriangleright$  button to adjust the volume.  
.....
  - 2 If you wish to switch the sound off, press the **MUTE** button.  
.....
  - 3 You can cancel the Mute function by pressing the **MUTE**,  $\blacktriangleleft$  /  $\blacktriangleright$ , **SSM** or **I/II** button.
-



# ON SCREEN MENUS SELECTION AND ADJUSTMENT

Your TV's OSD (On Screen Display) may differ slightly from that shown in this manual.

- 1 Press the **MENU** button and then **▲ / ▼** button to display each menu.
- 2 Press the **▶** button and then **▲ / ▼** button to select a menu item.
- 3 Change the setting of an item in the sub or pull-down menu with **◀ / ▶** button.  
You can move to a higher level menu by pressing the **OK** button.

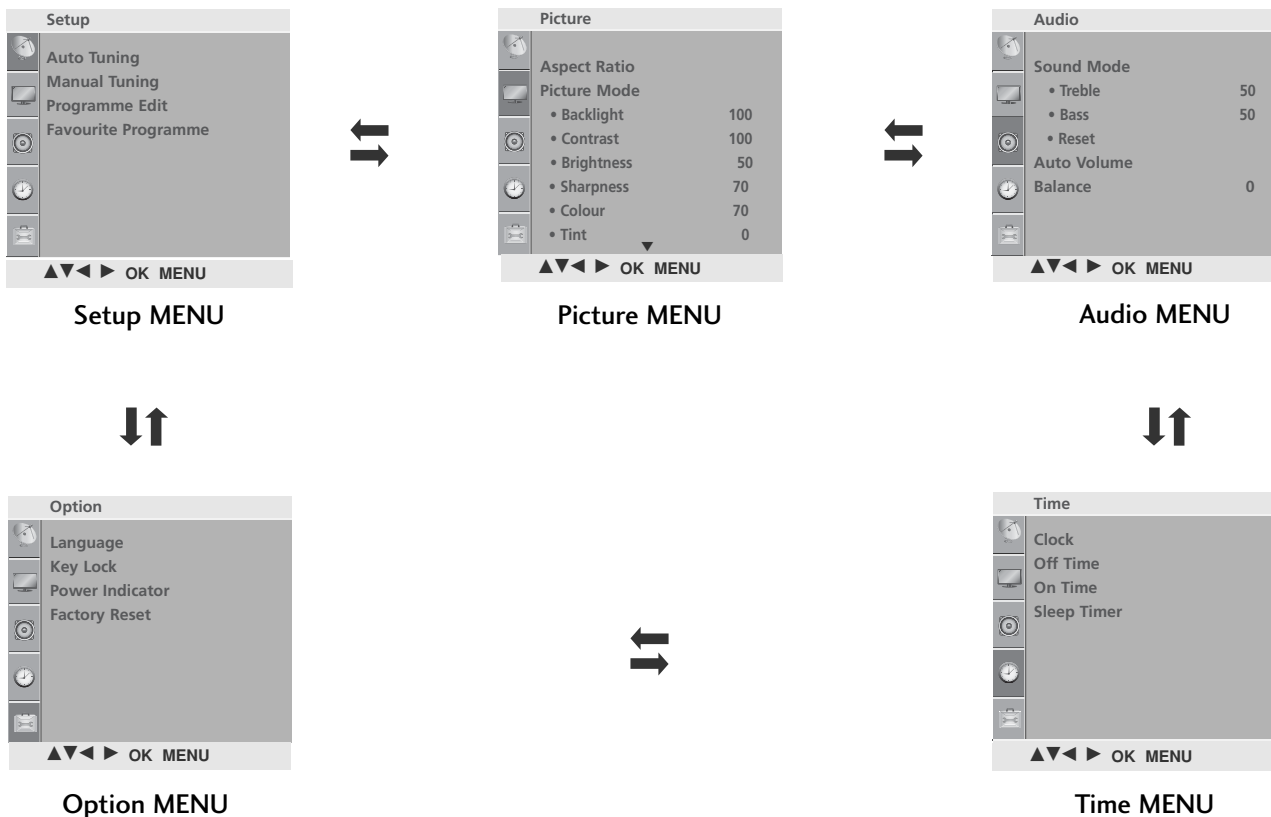

## ! NOTE

- a. The OSD (On Screen Display) function enables you to adjust the screen status conveniently since it provides graphical presentation.
- b. In this manual, the OSD (On Screen Display) may be different from your TV's because it is just example to help the TV operation.
- c. In the teletext mode, menus are not displayed.

# WATCHING TV / PROGRAMME CONTROL

## AUTO PROGRAMME TUNING

Up to 200 TV stations can be stored by programme numbers (0 to 199). Once you have preset the stations, you will be able to use the ▲ / ▼ or NUMBER buttons to scan the stations you have programmed.

Stations can be tuned using automatic or manual modes.

All stations which can be received are stored by this method. It is recommended that you use Auto tuning during installation of this TV.

**1** Press the **MENU** button and then ▲ / ▼ button to select the **Setup** menu.

**2** Press the ► button and then ▲ / ▼ button to select **Auto Tuning**.

**3** Press the ► button and then ▲ / ▼ button to select **System**.

**4** Press the ► button and then ▲ / ▼ button to select a TV system menu;  
BG: PAL B/G, SECAM B/G (Asia / NewZealand / M.East / Africa)  
I : PAL I/II (South Africa / Hong Kong)  
DK: PAL D/K, SECAM D/K (China / Africa / CIS)  
M : (Philippines)

**5** Press the ▲ / ▼ button to select **Storage From**.

**6** Press the ◀ / ▶ button or NUMBER buttons to select the initial programme number.

**7** Press the ▲ / ▼ button to select **Search**.

**8** Press the ► button to begin auto tuning.  
All receivable stations are stored.

To stop auto tuning, press the **MENU** button.

When auto tuning is complete, the Programme edit menu appears on the screen. See the Programme edit section to edit the stored programme.

**9** Press the **MENU** button to move to the previous menu screen.



**1**

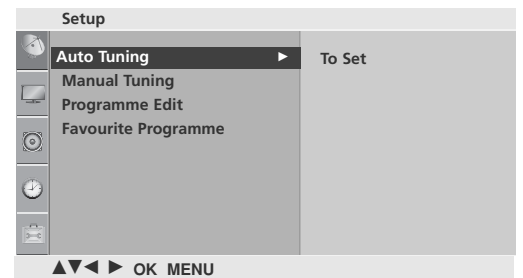

**2**

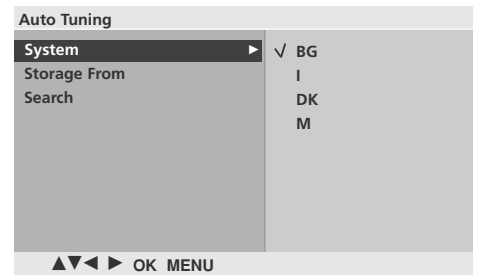

**3 4 5 6 7**

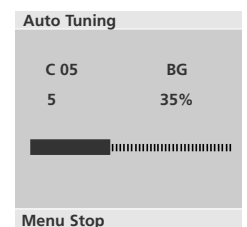

**8**

# MANUAL PROGRAMME TUNING

Manual Tuning lets you manually tune and arrange the stations in whatever order you desire.

- 1 Press the **MENU** button and then **▲ / ▼** button to select the **Setup** menu.
- 2 Press the **▶** button and then **▲ / ▼** button to select **Manual Tuning**.
- 3 Press the **▶** button and then **▲ / ▼** button to select **Storage**.
- 4 Press the **◀ / ▶** button or **NUMBER** buttons to select the desired programme number (0 to 199).
- 5 Press the **▲ / ▼** button to select **System**.
- 6 Press the **▶** button and then **▲ / ▼** button to select a TV system menu;  
 BG: PAL B/G, SECAM B/G (Asia / NewZealand / M.East / Africa)  
 I : PAL I/II (South Africa / Hong Kong)  
 DK: PAL D/K, SECAM D/K (China / Africa / CIS)  
 M : (Philippines)
- 7 Press the **▲ / ▼** button to select **Band**.
- 8 Press the **▶** button and then **▲ / ▼** button to select **V/UHF** or **Cable**.
- 9 Press the **▲ / ▼** button to select **Channel**.
- 10 Press the **▶** button and then You can select the desired programme number with the **◀ / ▶** button or **NUMBER** buttons. If possible, select the programme number directly with the number buttons.
- 11 Press the **▲ / ▼** button to select **Search**.
- 12 Press the **◀ / ▶** button to commence searching. If a station is found the search will stop.
- 13 Press the **OK** button to store it.
- 14 To store another station, repeat steps 3 to 13.
- 15 Press the **MENU** button to move to the previous menu screen.

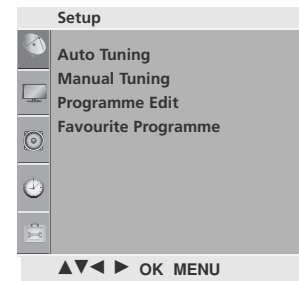

1

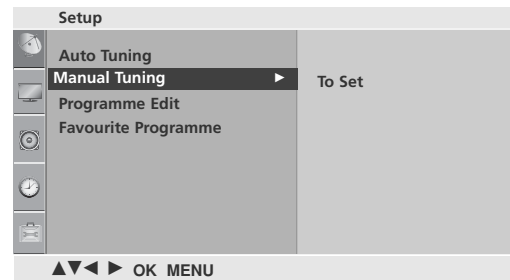

2



3 4 5 6 7  
8 9 10 11 12

# WATCHING TV / PROGRAMME CONTROL

## FINE TUNING

Normally fine tuning is only necessary if reception is poor.

- 1 Press the **MENU** button and then **▲ / ▼** button to select the **Setup** menu.



- 2 Press the **▶** button and then **▲ / ▼** button to select **Manual Tuning**.

- 3 Press the **▶** button and then **▲ / ▼** button to select **Fine**.

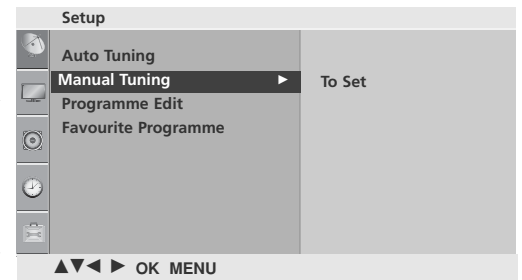

- 4 Press the **▶** button and then **◀ / ▶** button to fine tune for the best picture and sound.

- 5 Press the **OK** button to store it.

- 6 Press the **MENU** button to move to the previous menu screen.



3 4 5

## ASSIGNING A STATION NAME

You can assign a station name up to five characters to each programme number.

- 1 Press the **MENU** button and then **▲ / ▼** button to select the **Setup** menu.

---

- 2 Press the **▶** button and then **▲ / ▼** button to select **Manual Tuning**.

---

- 3 Press the **▶** button and then **▲ / ▼** button to select **Name**.

---

- 4 Press the **▶** button and then **▲ / ▼** button. You can use a blank, **+**, **-**, the number **0** to **9** and the alphabet **A** to **Z**.

---

- 5 Press the **◀ / ▶** button to select the position and make your choice of the second character, and so on.

---

- 6 Press the **OK** button to store it.

---

- 7 Press the **MENU** button to move to the previous menu screen.

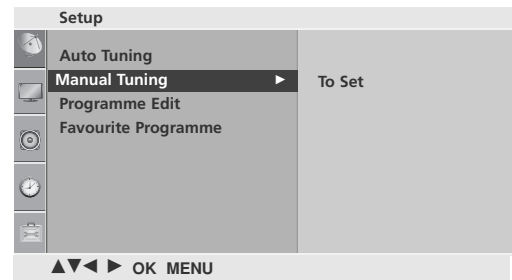

3 4 5 6

# WATCHING TV / PROGRAMME CONTROL

## PROGRAMME EDIT

This function enables you to delete or skip stored programmes. Also you can move some stations to other programme numbers.

1 Press the **MENU** button and then **▲ / ▼** button to select the **Setup** menu.

2 Press the **▶** button and then **▲ / ▼** button to select **Programme Edit**.

3 Press the **▶** button to display the Programme edit menu.

### ■ Deleting a programme

1. Select a programme to be deleted with the **▲ / ▼ / ◀ / ▶** button.

2. Press the **RED** button twice.

The selected programme is deleted, all the following programmes are shifted up one position.

### ■ Moving a programme

1. Select a programme to be moved with the **▲ / ▼ / ◀ / ▶** button.

2. Press the **Green** button.

3. Move the programme to the desired programme number with the **▲ / ▼ / ◀ / ▶** button.

4. Press the **Green** button again to release this function.

### ■ Skipping a programme number

1. Select a programme number to be skipped with the **▲ / ▼ / ◀ / ▶** button.

2. Press the **BLUE** button. The skipped programme turns to blue.

3. Press the **BLUE** button again to release the skipped programme.

When a programme number is skipped it means that you will be unable to select it using the **▲ / ▼** button during normal TV viewing. If you wish to select the skipped programme, directly enter the programme number with the **NUMBER** buttons or select it in the programme edit or table menu.

4 Press the **MENU** button to move to the previous menu screen.



1

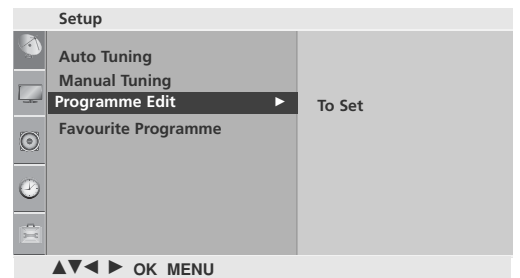

2

Programme Edit					
0	C	03	5	S	69
1	BLN	03	6	S	17
2	C	12	7	S	22
3	S	66	8	C	09
4	S	67	9	C	11

3

# FAVOURITE PROGRAMME

This function lets you select your favourite programmes directly.

Repeatedly press the **YELLOW** button to select stored favourite programmes.

- 1 Press the **MENU** button and then **▲ / ▼** button to select the **Setup** menu.
- 2 Press the **▶** button and then **▲ / ▼** button to select **Favourite Programme**.
- 3 Press the **▶** button.
- 4 Press the **▲ / ▼** button to select - - - - -.
- 5 Select a desired programme with the **◀ / ▶** button or **NUMBER** buttons.
- 6 To store another programme, repeat steps 4 to 5. You can store up to 8 programmes.
- 7 Press the **MENU** button to move to the previous menu screen.

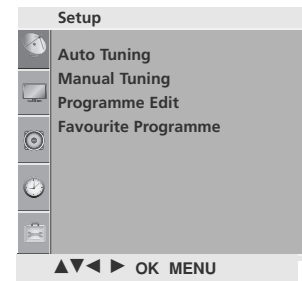

1

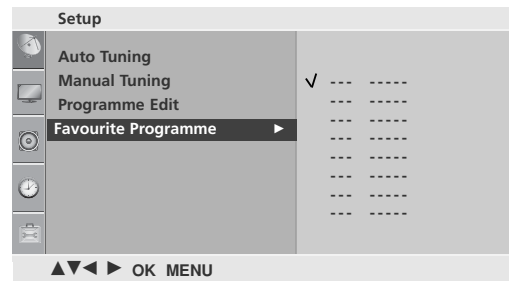

2 3 4 5

# WATCHING TV / PROGRAMME CONTROL

## SELECTING THE PROGRAMME LIST

You can check which programmes are stored in the memory by displaying the programme list.

### ■ Displaying programme list

Press the **LIST** button to display the **Programme List** menu.

The programme list appears on the screen.

One programme list contains ten programmes as shown.

### ! NOTE

- You may find some blue programmes. They have been set up to be skipped by auto programming or in the programme edit mode.
- Some programmes with the channel number shown in the programme list indicate there is no station name assigned.

### ■ Selecting a programme in the programme list

Select a programme with the **▲ / ▼ / ◀ / ▶** button.

Then press the **OK** button. The TV switches to the chosen programme number.

### ■ Paging through a programme list

There are 20 programme table pages in which contain 200 programmes. Pressing the **▲ / ▼ / ◀ / ▶** button repeatedly turns the pages.

Press the **LIST** button to return to normal TV viewing.

0	C 03	5	S 69
1	BLN 03	6	S 17
2	C 12	7	S 22
3	S 66	8	C 09
4	S 67	9	C 11

▲▼▶ OK



# KEY LOCK

The TV can be set so that the remote control is needed to control it.

This feature can be used to prevent unauthorized viewing.

This TV is programmed to remember which option it was last set to even if you turn the TV off.

- 1 Press the **MENU** button and then **▲ / ▼** button to select the **Option** menu.
- 2 Press the **▶** button and then **▲ / ▼** button to select **Key Lock**.
- 3 Press the **▶** button and then **▲ / ▼** button to select **On** or **Off**.
- 4 Press the **MENU** button to move to the previous menu screen.

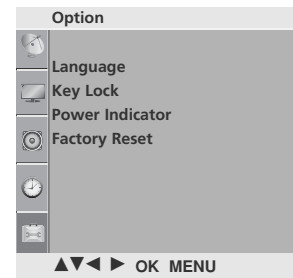

1

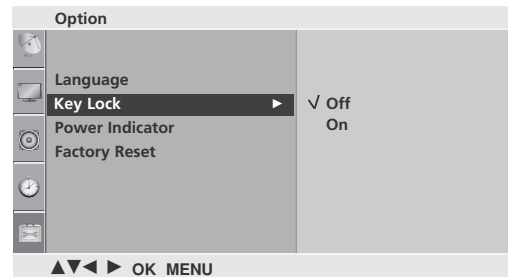

2 3

## ! NOTE

- ▶ In **Key Lock 'On'**, if the TV is turned off, press the **⏻ / I** button on the TV or **POWER** buttons on the remote control.
- ▶ With the **Key Lock On**, the display 'Key Lock On' appears on the screen if any button on the front panel is pressed while viewing the TV.

## FACTORY RESET

Use to quickly reset all the menu options to their original factory preset values.

This function deletes all TV programmes.

When the **Factory Reset** is completed, you must restart the **Installation Guide**.

- 1 Press the **MENU** button and then ▲ / ▼ button to select the **Option** menu.
- 2 Press the ► button and then ▲ / ▼ button to select **Factory Reset**.
- 3 Press the ► button and then ◀ / ▶ button to select **Yes** or **No**.
- 4 Press the **MENU** button to move to the previous menu screen.



1

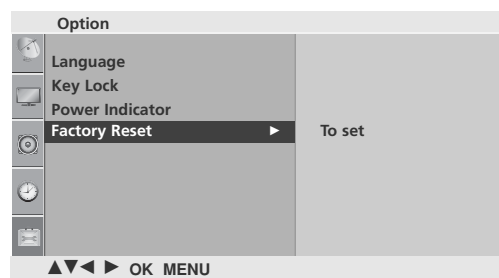

2

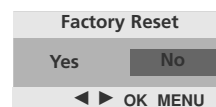

3

# PICTURE CONTROL

## PICTURE SIZE (ASPECT RATIO)CONTROL

You can watch the screen in various picture formats; **16:9**, **Original**, **4:3**, **14:9**, **Zoom1**, **Zoom2** and **Just Scan**.

If a fixed image is displayed on the screen for a long time, that fixed image may become imprinted on the screen and remain visible.

You can adjust the enlarge proportion using **▲ ▼** button.

This function works in the following signal.

**1** You can adjust **Aspect Ratio** in the **Picture** menu.

### • 16:9

The following selection will allow you to adjust the picture horizontally, in linear proportion, to fill the entire screen (useful for viewing 4:3 formatted DVDs).



### • Original

When your TV receives a wide screen signal it will automatically change to the picture format to be broadcast.



### • 4:3

The following selection will allow you to view a picture with an original 4:3 aspect ratio, black bars will appear on both the left and right of the screen.



### • 14:9

You can view a picture format of 14:9 or a general TV programme in the 14:9 mode. The 14:9 screen is viewed in the same way as in 4:3, but is magnified to the left and right.



### • Zoom1

The following selection will allow you to view the picture without any alteration, while filling the entire screen. However, the top and bottom of the picture will be cropped.

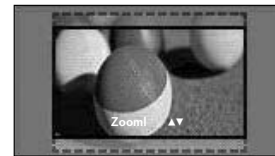

### • Zoom2

Choose Zoom 2 when you wish the picture to be altered, both horizontally extended and vertically cropped. The picture adopting a compromise between alteration and screen coverage.



### • Just Scan

Following Selection will lead to you view the picture of best quality without loss of original picture in high resolution image.

Note : If there is noise in original Picture, You can see the noise at the edge.



### ! NOTE

- ▶ You can only select 4:3, 16:9 (Wide) in Component, HDMI mode.
- ▶ In HDMI/Component (over 720p) mode, Just Scan is available.

# PICTURE CONTROL

## PRESET PICTURE SETTINGS

### Picture Mode-Preset

Picture Mode adjusts the TV for the best picture appearance. Select the preset value in the **Picture Mode** menu based on the programme category.

**Vivid**, **Standard** and **Cinema** are programmed for optimum picture reproduction at the factory and cannot be changed.

- 1 Press the **MENU** button and then **▲ / ▼** button to select the **Picture** menu.
- 2 Press the **▶** button and then **▲ / ▼** button to select **Picture Mode**.
- 3 Press the **▶** button and then **▲ / ▼** button to select **Vivid**, **Standard** or **Cinema**.
- 4 Press the **MENU** button to move to the previous menu screen.

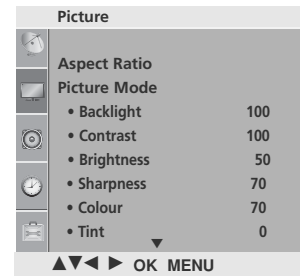

1

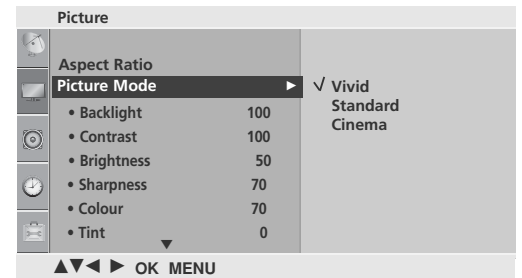

2 3

# MANUAL PICTURE ADJUSTMENT

## Picture Mode-User Option

- Backlight** To control the brightness of the screen, adjust the brightness of LCD panel.
- Contrast** Adjusts the difference between light and dark levels in the picture.
- Brightness** Increases or decreases the amount of white in the picture.
- Sharpness** Adjusts the level of crispness in the edges between the light and dark areas of the picture. The lower the level, the softer the image.
- Colour** Adjusts intensity of all colours.
- Tint** Adjusts the balance between red and green levels.

- 1 Press the **MENU** button and then **▲ / ▼** button to select the **Picture** menu.

---

- 2 Press the **▶** button and then **▲ / ▼** button to select **Picture Mode**.

---

- 3 Press the **▶** button and then **▲ / ▼** button to select **Vivid, Standard** or **Cinema**.

---

- 4 Press the **OK** button and then **▲ / ▼** button to select the desired picture option (**Backlight, Contrast, Brightness, Sharpness, Colour** and **Tint**).

---

- 5 Press the **◀ / ▶** button to make appropriate adjustments.

---

- 6 Press the **MENU** button to move to the previous menu screen.

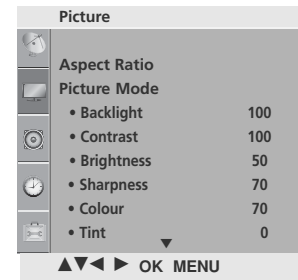

1

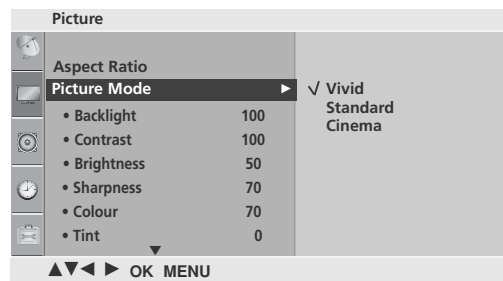

2 3

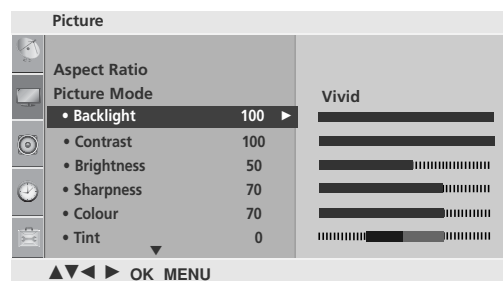

4 5



# PICTURE CONTROL

## PICTURE IMPROVEMENT TECHNOLOGY

You can calibrate the screen for each Picture Mode or set the video value according to the special video screen.

You can set the video value differently for each input.

To reset to the factory default screen after making adjustments to each video mode, execute the "Picture Reset" function for each Picture Mode.

1 Press the MENU button and then ▲ / ▼ button to select the **Picture** menu.

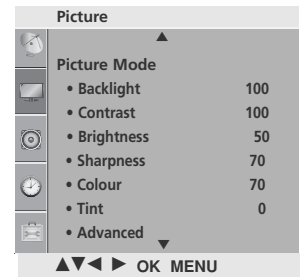

2 Press the ► button and then ▲ / ▼ button to select **Advanced**.

3 Press the ► button and then ▲ / ▼ button to select **Dynamic Contrast, Dynamic Colour, Noise Reduction, Black Level, Film Mode or Colour Temperature**.

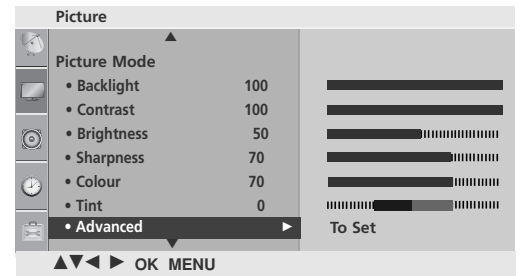

4 Press the MENU button to move to the previous menu screen.

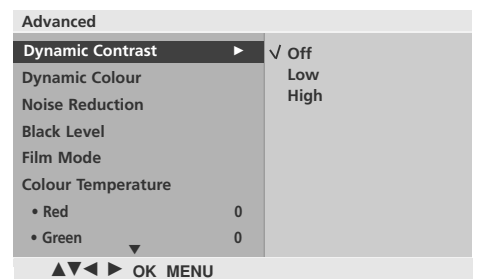

<p><b>Dynamic Contrast</b> (Off/Low/High)</p>	<ul style="list-style-type: none"> <li>▪ Adjusts the contrast to keep it at the best level according to the brightness of the screen. The picture is improved by making bright parts brighter and dark parts darker.</li> </ul>
<p><b>Dynamic Colour</b> (Off/Low/High)</p>	<ul style="list-style-type: none"> <li>▪ Adjusts screen colours so that they look livelier, richer and clearer. This feature enhances hue, saturation and luminance so that red, blue, green and white look more vivid.</li> </ul>
<p><b>Noise Reduction</b> (Off/Low/High)</p>	<ul style="list-style-type: none"> <li>▪ Reduces screen noise without compromising video quality.</li> </ul>
<p><b>Black Level</b> (Low/High)</p>	<ul style="list-style-type: none"> <li>• Low :The reflection of the screen gets darker.</li> <li>• High : The reflection of the screen gets brighter.</li> <li>▪ Set black level of the screen to proper level.</li> <li>▪ This function enables to select 'Low' or 'High' in the following mode: RF, AV, Component or HDMI.</li> </ul>
<p><b>Film Mode</b> (On/Off)</p>	<ul style="list-style-type: none"> <li>▪ Makes video clips recorded in film look more natural. This feature operates only in TV, AV and Component 480i/576i mode.</li> </ul>
<p><b>Colour Temperature</b> (Cool/Medium/Warm)</p>	<ul style="list-style-type: none"> <li>▪ Choose one of three automatic colour adjustments. Set to warm to enhance hotter colours such as red, or set to cool to see less intense colours with more blue.</li> <li>▪ You can control red, green, blue to adjust colour details.</li> </ul>

# PICTURE CONTROL

## PICTURE RESET

Settings of the selected picture modes return to the default factory settings.

- 1 Press the **MENU** button and then ▲ / ▼ button to select the **Picture** menu.
- 2 Press the ► button and then ▲ / ▼ button to select **Picture Reset**.
- 3 Press the ► button to initialize the adjusted value.
- 4 Press the **MENU** button to move to the previous menu screen.

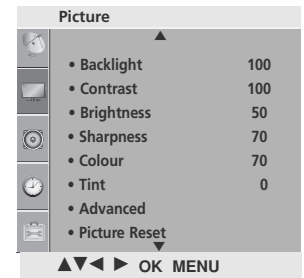

1

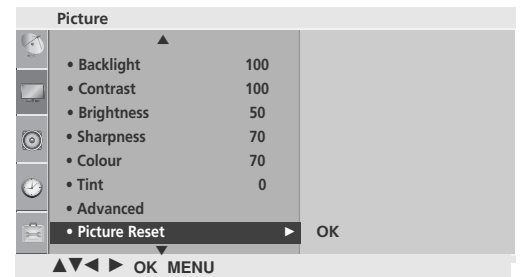

2 3

## POWER INDICATOR

It is function to control of IR LED(turn on/off).

- 1 Press the **MENU** button and then ▲ / ▼ button to select the **Option** menu.
- 2 Press the ► button and then ▲ / ▼ button to select **Power Indicator**.
- 3 Press the ► button and then ▲ / ▼ button to select either **Standby Light** or **Power Light**.
- 4 Press the ► button and then ▲ / ▼ button to select **On** or **Off**.
- 5 Press the **MENU** button to move to the previous menu screen.



1



2 3

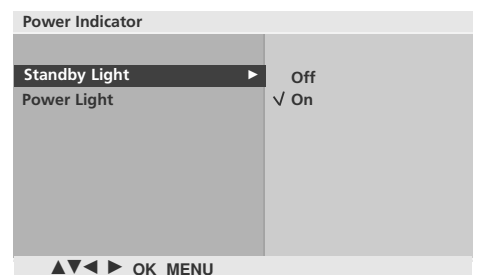

4



# SCREEN SETUP

## Manual Configure (Adjustment for screen Position)

If the picture is not clear and especially if characters are still trembling, adjust the picture phase manually.

This function works in the following mode when the signal exist : HDMI, Component

- 1 Press the **MENU** button and then use ▲ / ▼ button to select the **Picture** menu.
- 2 Press the ► button and then use ▲ / ▼ button to select **Screen**.
- 3 Press the ► button and then use ▲ / ▼ button to select **Manual Config..**
- 4 Press the ► button and then use ▲ / ▼ button to select **H-Position** or **V-Position**.  
(When the H-Position and V-Position be changed, Value may differ from the aspect ratio.)
- 5 Press the ◀ / ▶ button to make appropriate adjustments.
- 6 Press the **MENU** button to move to the previous menu screen.

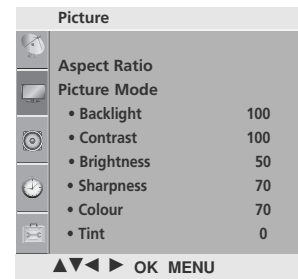

1

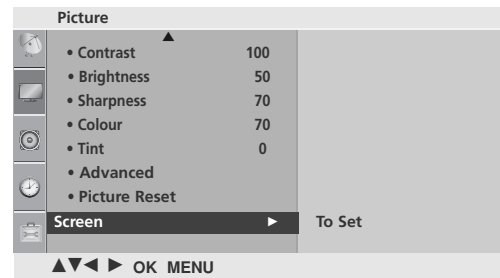

2



3 4 5

# PICTURE CONTROL

## Initializing (Reset to original factory settings)

This function operates in current mode.

To initialize the adjusted value

This function works in the following mode when the signal exist  
: HDMI, Component

1 Press the MENU button and then use ▲ / ▼ button to select the **Picture** menu.

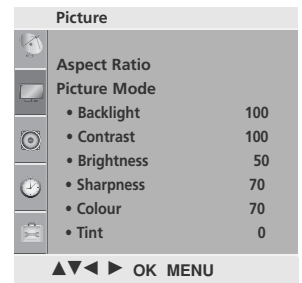

2 Press the ► button and then use ▲ / ▼ button to select **Screen**.

3 Press the ► button and then use ▲ / ▼ button to select **Reset**.

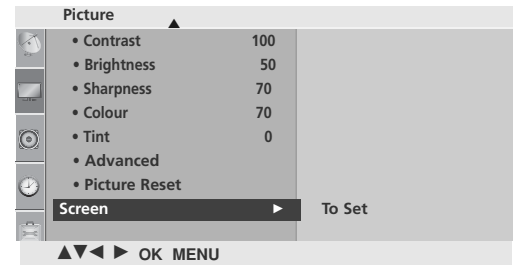

4 Press the ► button.

5 Press the MENU button to move to the previous menu screen.



# SOUND & LANGUAGE CONTROL

## PRESET SOUND SETTINGS-SOUND MODE

You can select your preferred sound setting; Standard, Music or Cinema.

Sound Mode lets you enjoy the best sound without any Special adjustment as the TV sets the appropriate sound options based on the programme content.

**Standard, Music and Cinema** are preset for optimum sound quality at the factory and are not adjustable.

---

**1** Press the **MENU** button and then **▲ / ▼** button to select the **Audio** menu.

---

**2** Press the **▶** button and then **▲ / ▼** button to select **Sound Mode**.

---

**3** Press the **▶** button and then **▲ / ▼** button to select **Standard, Music or Cinema**.

---

**4** Press the **MENU** button to move to the previous menu screen.

---

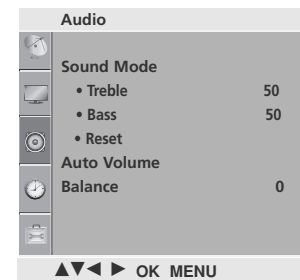

**1**

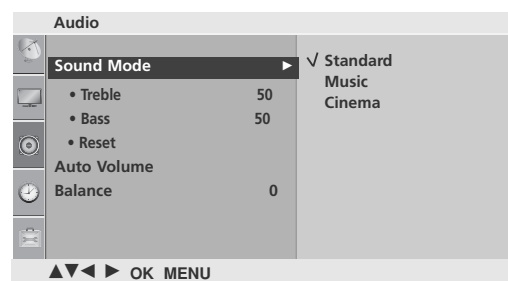

**2 3**

# SOUND SETTING ADJUSTMENT -USER MODE

1 Press the **MENU** button and then ▲ / ▼ button to select the **Audio** menu.

2 Press the ► button and then ▲ / ▼ button to select **Sound Mode**.

3 Press the ► button and then ▲ / ▼ button to select **Standard, Music or Cinema**.

4 Press the **OK** button and then ▲ / ▼ button to select **Treble** or **Bass**.

5 Press the ◀ / ▶ button to make appropriate adjustments.

6 Press the **MENU** button to move to the previous menu screen.

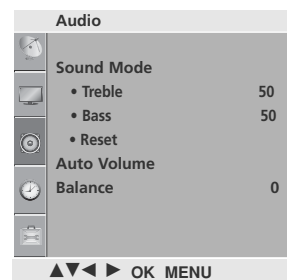

1

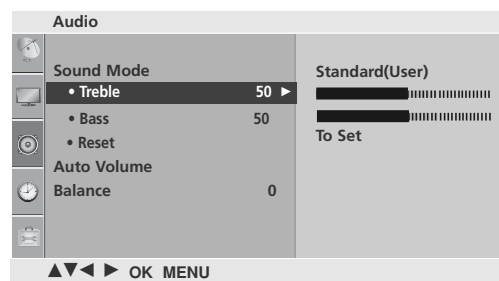

2 3 4 5

# AUTO VOLUME LEVELER

Auto Volume automatically remains on the same level of volume if you change programmes.

---

**1** Press the **MENU** button and then **▲ / ▼** button to select the **Audio** menu.

---

**2** Press the **▶** button and then **▲ / ▼** button to select **Auto Volume**.

---

**3** Press the **▶** button and then **▲ / ▼** button to select **On** or **Off**.

---

**4** Press the **MENU** button to move to the previous menu screen.

---

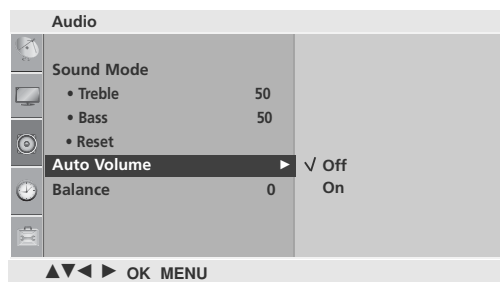
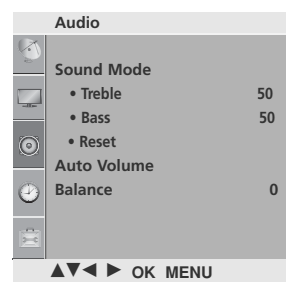

# SOUND & LANGUAGE CONTROL

## BALANCE

You can adjust the sound balance of the speakers to the preferred levels.

---

1 Press the **MENU** button and then ▲ / ▼ button to select the **Audio** menu.

---

2 Press the ► button and then ▲ / ▼ button to select **Balance**.

---

3 Press the ► button and then ◀ / ▶ button to make desired adjustment.

---

4 Press the **MENU** button to move to the previous menu screen.

---

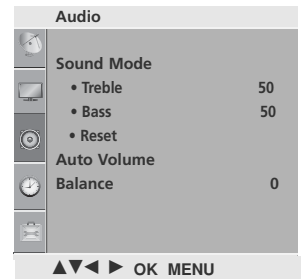

1

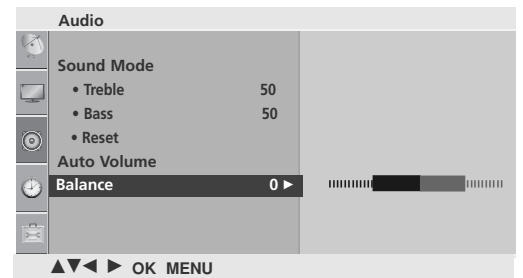

2 3

# AUDIO RESET

Settings of the selected Sound Mode return to the default factory settings.

---

1 Press the **MENU** button and then **▲ / ▼** button to select the **Audio** menu.

---

2 Press the **▶** button and then **▲ / ▼** button to select **Reset**.

---

3 Press the **▶** button and then **OK** button

---

4 Press the **MENU** button to move to the previous menu screen.

---

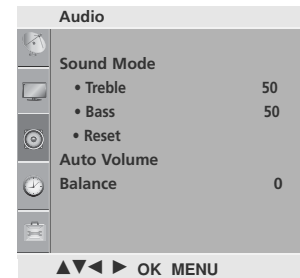

1

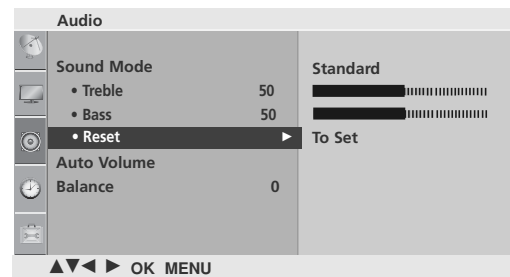

2 3

# SOUND & LANGUAGE CONTROL

I/II

## Stereo/Dual Reception

When a programme is selected, the sound information for the station appears with the programme number and station name.

1 Press the I/II button to select the **Multi Audio** menu.

Broadcast	On Screen Display
Mono	MONO
Stereo	STEREO
Dual	DUAL I, DUAL II, DUAL I+II

### ■ Mono sound selection

If the stereo signal is weak in stereo reception, you can switch to mono. In mono reception, the clarity of sound is improved. To switch back to stereo.

### ■ Language selection for dual language broadcast

If a programme can be received in two languages (dual language), you can switch to DUAL I, DUAL II or DUAL I+II.

DUAL I Sends the primary broadcast language to the loudspeakers.

DUAL II Sends the secondary broadcast language to the loudspeakers.

DUAL I+II Sends a separate language to each loudspeaker.



## NICAM Reception

If the TV is equipped with a receiver for NICAM reception, high quality NICAM (Near Instantaneous Companding Audio Multiplex) digital sound can be received.

Sound output can be selected according to the type of broadcast received.

- 
- 1 When **NICAM mono** is received, you can select **NICAM MONO** or **FM MONO**.
  - 2 When **NICAM stereo** is received, you can select **NICAM STEREO** or **FM MONO**.  
If the stereo signal is weak, switch to **FM MONO**.
  - 3 When **NICAM dual** is received, you can select **NICAM DUAL I**, **NICAM DUAL II** or **NICAM DUAL I+II** or **FM MONO**.
- 

## Speaker Sound Output Selection

In AV, Component and HDMI mode, you can select output sound for the left and right loudspeakers.

Select the sound output.

**L+R:** Audio signal from audio L input is sent to the left loudspeaker and audio signal from audio R input is sent to the right loudspeaker.

**L+L:** Audio signal from audio L input is sent to left and right loudspeakers.

**R+R:** Audio signal from audio R input is sent to left and right loudspeakers.

# SOUND & LANGUAGE CONTROL

## ON-SCREEN MENU LANGUAGE SELECTION

The menus can be shown on the screen in the selected language.

- 
- 1 Press the **MENU** button and then use ▲ / ▼ button to select the **Option** menu.

---

  - 2 Press the ► button and then use ▲ / ▼ button to select **Language**.

---

  - 3 Press the ► button and then use ▲ / ▼ / ◀ / ▶ button to select your desired language.

---

  - 4 Press the OK button

---

  - 5 Press the **MENU** button to move to the previous menu screen.

---

# TIME SETTING

## CLOCK SETUP

You must set the time correctly before using on/off time function.

If current time setting is erased by a power failure or the TV is unplugged, reset the clock.

- 1 Press the **MENU** button and then ▲ / ▼ button to select the **Time** menu.
- 2 Press the ► button and then ▲ / ▼ button to select **Clock**.
- 3 Press the ► button and then ▲ / ▼ button to set the hour.
- 4 Press the ► button and then ▲ / ▼ button to set the minute.
- 5 Press the **MENU** button to move to the previous menu screen.

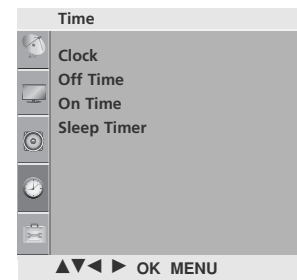

2 3 4

# TIME SETTING

## AUTO ON/OFF TIMER SETTING

The Off time function automatically switches the TV to standby at a preset time.

Two hours after the TV is switched on by the on time function it will automatically switch back to standby mode unless a button has been pressed.

Once the on time/off time is set, these functions operate daily at the preset time.

The Off time function overrides the On time function if both are set to the same time.

The TV must be in standby mode for the On time to work.

**1** Press the **MENU** button and then **▲ / ▼** button to select the **Time** menu.

**2** Press the **▶** button and then **▲ / ▼** button to select **On/Off Time**.

- To cancel **On/Off Time** function, select **Off**.

**3** Press the **▶** button and then **▲ / ▼** button to set the hour.

**4** Press the **▶** button and then **▲ / ▼** button to set the minutes.

**5** For **On Time** function only

- **PR**: Press the **▶** button and then **▲ / ▼** button to select the programme.
- **Vol.**: Press the **▶** button and then **▲ / ▼** button to adjust volume level at switch-on.

**6** Press the **MENU** button to move to the previous menu screen.

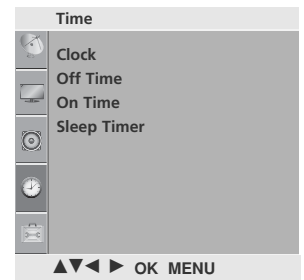

**1**



**2 3 4**



**2 3 4 5**

# SLEEP TIMER SETTING

You do not have to remember to switch the TV off before you go to sleep. The sleep timer automatically switches the TV to standby after the preset time has elapsed.

- 1 Press the **MENU** button and then **▲ / ▼** button to select the **Time** menu.
- 2 Press the **▶** button and then **▲ / ▼** button to select **Sleep Timer**.
- 3 Press the **▶** button and then **▲ / ▼** button to set the minute (**Off, 10, 20, 30, 60, 90, 120, 180** or **240**).
- 4 Press the **MENU** button to move to the previous menu screen.

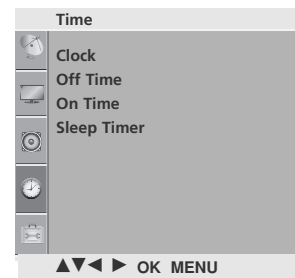

1



2 3 4

## ! NOTE

- ▶ When you switch the TV off, the TV releases the preset sleep time.

# TELETEXT

**This feature is not available in all countries.**

Teletext is a free service broadcast by most TV stations which gives up-to-the-minute information on news, weather, television programmes, share prices and many other topics.

The teletext decoder of this TV can support the SIMPLE, TOP and FASTEXT systems. SIMPLE (standard teletext) consists of a number of pages which are selected by directly entering the corresponding page number. TOP and FASTEXT are more modern methods allowing quick and easy selection of teletext information.

## SWITCH ON/OFF

Press the **TEXT** button to switch to teletext. The initial page or last page viewed appears on the screen.

Two page numbers, TV station name, date and time are displayed on the screen headline. The first page number indicates your selection, while the second shows the current page displayed.

Press the **TEXT** button to switch off teletext. The previous mode reappears.

## SIMPLE TEXT

### ■ Page selection

- 1 Enter the desired page number as a three digit number with the NUMBER buttons. If during selection you press a wrong number, you must complete the three digit number and then re-enter the correct page number.
- 2 The ▲ / ▼ button can be used to select the preceding or following page.

### Programming a colour button in LIST mode

If the TV is in SIMPLE text, TOP text or FASTEXT mode, press the  button to switch to LIST mode.

Four teletext page numbers of your choice can be colour coded and easily selected by pressing the corresponding coloured button on the remote control handset.

- 1 Press a coloured button.
- 2 Using the NUMBER buttons, select the page you wish to programme.
- 3 Press the **OK** button. The selected page is stored as the selected page number, blinking once to confirm this. From now on, you can select this page with the same coloured button.
- 4 The three other coloured buttons are programmed in this way.

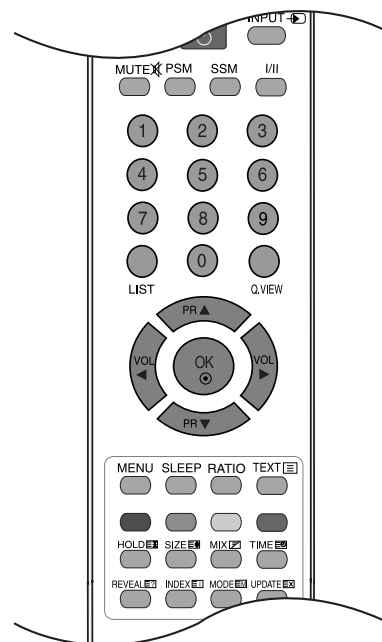

## TOP TEXT

The user guide displays four fields-red, green, yellow and blue at the bottom of the screen. The yellow field denotes the next group and the blue field indicates the next block.

### ■ Block / group / page selection

- ① With the blue button you can progress from block to block.
- ② Use the yellow button to proceed to the next group with automatic overflow to the next block.
- ③ With the green button you can proceed to the next existing page with automatic overflow to the next group.  
Alternatively the ▲ button can be used.
- ④ The red button return to the previous selection. Alternatively the ▼ button can be used.

### ■ Direct page selection

As with SIMPLE teletext mode, you can select a page by entering it as a three digit number using the NUMBER buttons in TOP mode.

## FASTEXT

The teletext pages are colour coded along the bottom of the screen and are selected by pressing the corresponding coloured button.

### ■ Page selection

- ① Press the  button to select the index page.
- ② You can select the pages which are colour coded along the bottom line with corresponding coloured buttons.
- ③ As with SIMPLE teletext mode, you can select a page by entering its three digit page number with the NUMBER buttons in FASTEXT mode.
- ④ The ▲ / ▼ button can be used to select the preceding or following page.

## SPECIAL TELETEXT FUNCTIONS



### ■ TIME

When viewing a TV programme, press this button to display the time at the top right hand corner of the screen. Press this button again to remove the display. In the teletext mode, press this button to select a sub page number. The sub page number is displayed at the bottom of the screen. To hold or change the sub page, press the RED/GREEN, ▲ / ▼ or NUMBER buttons.

Press again to exit this function.



### ■ SIZE

Selects double height text.

Press this button to enlarge the top half of the page.

Press this button again to enlarge the bottom half of the page.

Press this button again to return to the normal display.



### ■ UPDATE

Displays the TV picture on the screen while waiting for a new teletext page. The display will appear at the top left hand corner of the screen. When the updated page is available then display will change to the page number. Press this button again to view the updated teletext page.



### ■ REVEAL

Press this button to display concealed information, such as solutions to riddles or puzzles.

Press this button again to remove the information from the display.



### ■ INDEX

Select the each index page.



### ■ HOLD

Stops the automatic page change which will occur if a teletext page consists of 2 or more sub pages. The number of sub pages and the sub page displayed is, usually, shown on the screen below the time. When this button is pressed the stop symbol is displayed at the top left-hand corner of the screen and the automatic page change is inactive. To continue press this button again.



### ■ MIX

Displays the teletext pages superimposed on the TV picture.

To switch the TV picture off press this button again.



# APPENDIX

## TROUBLESHOOTING

### The TV does not operate properly

#### The remote control does not work

- Check to see if there is any object between the TV and the remote control causing an obstruction.
- Are batteries installed with correct polarity (+ to +, - to -)?
- Install new batteries.

#### Power is suddenly turned off

- Is the sleep timer set?
- Check the power control settings. Has the Power supply been interrupted.
- The TV goes into Standby mode automatically if no signal is received and no operation is performed for 15 minutes.

### The video function does not work.

#### No picture & No sound

- Check whether the TV is switched on.
- Try another channel. The problem may be with the broadcast.
- Is the power cord inserted correctly into the mains?
- Check your antenna direction and/or location.
- Test the mains outlet by plugging another TV into the same outlet.

#### Picture appears slowly after switching on

- This is normal, the image is muted during the TV startup process. Please contact your service center, if the picture has not appeared after five minutes.

#### No or poor colour or poor picture

- Adjust Colour in menu option.
- Allow a sufficient distance between the TV and the VCR.
- Try another channel. The problem may be with the broadcast.
- Are the video cables installed properly?
- Activate any function to restore the brightness of the picture.

#### Horizontal/vertical bars or picture shaking

- Check for local interference such as an electrical appliance or power tool.

#### Poor reception on some channels

- Station or cable channel experiencing problems, tune to another station.
- Station signal is weak, reposition the antenna to receive weaker stations.
- Check for sources of possible interference.

#### Lines or streaks in pictures

- Check antenna (Change the position of the antenna).

# APPENDIX

## The audio function does not work.

### Picture OK & No sound

- Press the **VOL** ◀ or ▶ (or - ▲ +) button.
- Sound muted? Press **MUTE** button.
- Try another channel. The problem may be with the broadcast.
- Are the audio cables installed properly?

### No output from one of the speakers

- Adjust Balance in menu option.

### Unusual sound from inside the TV

- A change in ambient humidity or temperature may result in an unusual noise when the TV is switched on or off and does not indicate a fault with the TV.

# MAINTENANCE

Early malfunctions can be prevented. Careful and regular cleaning can prolong the life of your new TV.  
Caution: Be sure to switch the power off and unplug the power cord before you begin any cleaning.

## Cleaning the Screen

- 1 A good way to keep the dust off your screen for a while is to wet a soft cloth in a mixture of lukewarm water and a little fabric softener or dish washing detergent. Wring the cloth until it's almost dry, and then use it to wipe the screen.
- 2 Ensure there is no excess water on the screen. Allow any water or dampness to evaporate before switching on.

## Cleaning the Cabinet

- To remove dirt or dust, wipe the cabinet with a soft, dry, lint-free cloth.
- Do not use a wet cloth.

## Extended Absence

### CAUTION

- ▶ If you expect to leave your TV dormant for prolonged periods (such as a holiday), unplug the power cord to protect against possible damage from lightning or power surges.

# APPENDIX

## PRODUCT SPECIFICATIONS

MODELS		19LD310	22LD310
		19LD310-TA 19LD310-LA	22LD310-TA 22LD310-LA
Dimensions (Width x Height x Depth)	with stand	462.4 x 353.0 x 171.0 mm 18.2 x 13.9 x 6.8 inches	533.4 x 397.0 x 171.0 mm 21.0 x 15.6 x 6.7 inches
	without stand	462.4 x 308.0 x 65.0 mm 18.2 x 12.2 x 2.6 inches	533.4 x 351.7 x 65.0 mm 21.0 x 13.8 x 2.6 inches
Weight	with stand	3.8 kg / 8.4 lbs	4.8 kg / 10.6 lbs
	without stand	3.6 kg / 8.0 lbs	4.6 kg / 10.1 lbs
Power requirement		AC100-240V~ 50/60Hz	AC100-240V~ 50/60Hz
MODELS		26LD310	32LD310
		26LD310-TA 26LD310-LA	32LD310-TA 32LD310-LA
Dimensions (Width x Height x Depth)	with stand	667.0 x 504.0 x 224.0 mm 26.3 x 19.8 x 8.8 inches	805.0 x 583.0 x 224.0 mm 31.7 x 23.0 x 8.8 inches
	without stand	667.0 x 446.2 x 80.0 mm 26.3 x 17.6 x 3.1 inches	805.0 x 528.0 x 79.9mm 31.7 x 20.8 x 3.1 inches
Weight	with stand	8.9 kg / 19.6 lbs	11.5 kg / 25.4 lbs
	without stand	7.8 kg / 17.2 lbs	10.4 kg / 23.0 lbs
Power requirement		AC100-240V~ 50/60Hz	AC100-240V~ 50/60Hz
Television System		PAL/SECAM B/G/D/K, PAL I/II, NTSC-M	
Programme Coverage		VHF: NZ1 ~E21, UHF: E21 ~ E69, CATV: S1 ~ S20, HYPER: S21 ~ S47	
External Antenna Impedance		75 Ω	
Environment condition	Operating Temperature	0 ~ 40°C / 32 ~ 104°F	
	Operating Humidity	Less than 80%	
	Storage Temperature	-20 ~ 60°C / -4 ~ 140°F	
	Storage Humidity	Less than 85%	

■ The specifications shown above may be changed without prior notice for quality improvement.

# IR CODES

Code (Hexa)	Function	Note	Code (Hexa)	Function	Note
0B	INPUT	R/C Button	09	MUTE	R/C Button
08	POWER	R/C Button (Power On/Off)	53	LIST	R/C Button
43	MENU	R/C Button	10 ~ 19	Number Key 0 ~ 9	R/C Button
44	OK	R/C Button	1A	Q.VIEW	R/C Button
72	RED	R/C Button	20	TEXT	R/C Button
71	GREEN	R/C Button	79	RATIO	R/C Button
63	YELLOW	R/C Button			
61	BLUE	R/C Button			
02	VOL ►	R/C Button			
03	VOL ◀	R/C Button			
00	PR ▲	R/C Button			
01	PR ▼	R/C Button			
4D	PSM	R/C Button			
52	SSM	R/C Button			
0A	I/II	R/C Button			
0E	SLEEP	R/C Button			
22	MODE	R/C Button			
24	MIX	R/C Button			
26	TIME	R/C Button			
2A	REVEAL	R/C Button			
62	UPDATE	R/C Button			
64	SIZE	R/C Button			
65	HOLD	R/C Button			
70	INDEX	R/C Button			
0F	TV	R/C Button			



Record the model number and serial number of the TV.

Refer to the label on the back cover and quote this information to your dealer when requiring any service.

Model : \_\_\_\_\_

Serial No. : \_\_\_\_\_