



LG

Life's Good

OWNER'S MANUAL LCD TV / LED LCD TV

Please read this manual carefully before operating your set and retain it for future reference.



HDMI, the HDMI logo and High-Definition Multimedia Interface are trademarks or registered trademarks of HDMI Licensing LLC.

Separate purchase

Wall Mounting Bracket

LSW100B or
LSW100BG

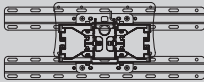

(22/26/32LD3**,
32LD4**, 32LD5**, 32LD6**,
22/26/32LE5***,
32LE7***, 22/26LE6***,
32LE4***, 26/32LE3***)

LSW200B or
LSW200BG

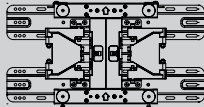

(37/42/47LD4**,
42/46LD5**, 37/42/47LD6**,
37/42/47LE5***, 37/42/47LE7***,
42/47LE8***, 42/47LE4***,
42/47LX6***)

LSW200BX or
LSW200BXG

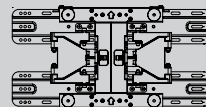

(47LX9***)

LSW400B or
LSW400BG or
DSW400B or
DSW400BG

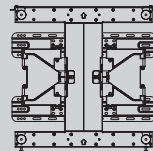

(52/60LD5**, 55LD6**,
55LE5***, 55LE7***,
55LE8***, 55LE4***,
55LX6***, 55LX9***)

Optional extras can be changed or modified for quality improvement without any notification. Contact your dealer for buying these items.

This device only works with compatible LG LED LCD TV or LCD TV.

Wireless Media Box
(AN-WL100W)



(Only 32/42/46/52/60LD5**,
32/37/42/47/55LD6**,
32/37/42/47/55LE53**,
32/37/42/47/55LE55**,
32/37/42/47/55LE7***, 42/47/55LE8***,
32/42LE45**, 42/47/55LX6***,
47/55LX9***, 32LE3***)

Wireless LAN for
Broadband/
DLNA Adaptor
(AN-WF100)



(Only 32/42/52LD56*,
32/37/42/47/55LD6**,
32/37/42/47/55LE55**,
32/37/42/47/55LE7***,
42/47/55LE8***, 42/47/55LX6***,
47/55LX9***)

CONTENTS

PREPARATION

Accessories	A-1
Front Panel Controls	A-4
Back Panel Information	A-10
Stand Installation	A-18
Woofer Installation :When Using the Wall Mount	A-23
Back Cover for Wire Arrangement	A-24
Attaching the TV to a Desk	A-25
Not Using the Desk-Type Stand	A-26
Swivel Stand	A-26
Positioning your Display	A-26
Connection of TV	A-27
Kensington Security System	A-27
Careful Installation Advice	A-28
Desktop Pedestal Installation	A-28
Wall Mount: Horizontal Installation	A-29
Remote Control Key Functions	A-30

EXTERNAL EQUIPMENT SETUP

Antenna Connection	1
Connecting with a Component Cable	2
Connecting with an HDMI Cable	3
Connecting with an HDMI to DVI Cable	4
Connecting with an RCA Cable	5
Connecting with an RF Cable	6
Headphone Setup	6
Digital Audio Out Setup	7
Connecting with a D-sub 15 Pin Cable	8
Usb Setup	8
External Equipment Wireless Connection	9
Supported Display Resolution	10
Screen Setup for PC mode	12
Network Setup	16

WATCHING TV / PROGRAMME CONTROL

Turning on the TV	26
Initializing Setup	26
Programme Selection	26
Volume Adjustment	26
Quick Menu	27
On Screen Menus Selection and Adjustment	28
Auto Programme Tuning	30
Manual Programme Tuning	31
Programme Edit	34

Software Update	38
Picture/Sound Test	42
Signal Test	43
Product/Service Information	44
Network Test	45
Simple Manual	46
Selecting the Programme List	47
Input List	49
Input Label	50
Data Service	51
SIMPLINK	52
AV Mode	55
Initializing(Reset to original factory settings)	56

NETCAST

Legal Notice	57
Netcast Menu	59
Movie Online	60
Weather info	62
Photo Album	63

TO USE THE BLUETOOTH

Bluetooth?	64
Setting the Bluetooth	65
Bluetooth headset	66
Remove the Bluetooth device	69
My Bluetooth Information	70
Receiving photos from external Bluetooth device	71
Listening to the Musics from external Bluetooth device	71

3D IMAGING

3D TECHNOLOGY	72
Viewing 3D Imaging	72
When using 3D Glasses	73
3D Imaging viewing range	73
Watching 3D Imaging	74

TO USE A USB DEVICE

When connecting a USB device	76
DLNA	78
Movie list	82
Photo list	93
Music list	100
DivX Registration Code	106
Deactivation	107

CONTENTS

GAME

Game.....	108
-----------	-----

EPG(ELECTRONIC PROGRAMME GUIDE)(IN DIGITAL MODE)

Switch on/off EPG.....	110
Select a programme.....	110
Button Function in NOW/NEXT Guide Mode .	110
Button Function in 8 Day Guide Mode	111
Button Function in Date Change Mode	111
Button Function in Extended Description Box	112
Button Function in Remind Setting Mode.....	112
Button Function in Schedule List Mode	112

MHEG (MULTIMEDIA AND HYPERMEDIA INFORMATION CODING EXPERT GROUP)(IN DIGITAL MODE)

Teletext within Digital Service	113
Teletext in Digital Service.....	113
Switch on MHEG	114
Select a Programme	114
Button Function in Listing Mode	115
Button Function in NOW/NEXT Mode	115

PICTURE CONTROL

Picture Size (Aspect Ratio) Control	116
Picture Wizard.....	118
Energy Saving.....	119
Preset Picture Settings	120
Manual Picture Adjustment	121
Picture Improvement Technology.....	123
Expert Picture Control.....	124
Picture Reset.....	127
Trumotion	128
LED Local Dimming	129
Power Indicator	130
Mode Setting	131
Demo Mode.....	132

SOUND & LANGUAGE CONTROL

Auto Volume Leveler.....	133
Clear Voice II.....	134
Preset Sound Settings-Sound Mode	135

Sound Setting Adjustment -User Mode	136
Infinite Sound	136
Balance	137
TV Speakers On/ Off Setup	138
DTV Audio Setting (in digital mode only).....	139
Selecting Digital Audio out	140
Audio Reset.....	141
I/II	
Stereo/Dual Reception (In Analogue Mode Only)	142
NICAM Reception (In Analogue Mode Only)..	143
Speaker Sound Output Selection	143
On-Screen Menu Language / Country Selection	144
Language Selection (In digital mode only)	145

TIME SETTING

Clock Setup.....	147
Auto on/off time setting	148
Sleep Timer setting	149

PARENTAL CONTROL / RATINGS

Set Password & Lock System.....	150
Block Programme.....	151
Parental Control (In Digital Mode only).....	152
External Input Blocking	153
Key Lock.....	154

TELETEXT

Switch on/off	155
SIMPLE Text.....	155
TOP Text.....	156
FASTEXT	156
Special Teletext Functions	157

APPENDIX

Troubleshooting.....	158
Maintenance.....	160
Product Specifications.....	161
IR Codes	175
External Control Device Setup.....	176
Open Source Software Notice	183

PREPARATION

ACCESSORIES

Ensure that the following accessories are included with your TV. If an accessory is missing, please contact the dealer where you purchased the TV.

■ Image shown may differ from your TV.

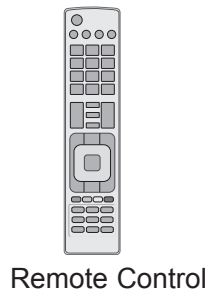
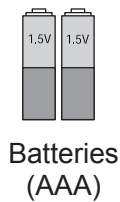
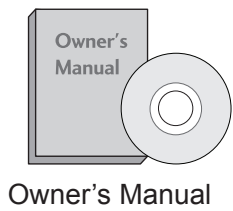

This item is not included for all models.

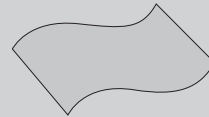

Polishing Cloth
Polishing cloth for use on the screen.

* Lightly wipe any stains or fingerprints on the surface of the TV with the polishing cloth.

Do not use excessive force. This may cause scratching or discolouration.

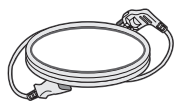

Power Cord

(Except for 32/37/42/47/55LE5***, 32/37/42/47/55LE7***, 42/47/55LE8***, 42/47/55LX6***, 47/55LX9***, 32/42/47/55LE4***, 32LE3***)



1-screw for stand fixing
(Refer to p. A-25)

(Only 26/32LD3**, 32/37/42LD4**, 32/42LD5**, 32/37/42LD6**, 32LE45**, 32/42/47/55LE46**, 32LE5***, 32LE7***, 32LE3***)

Only 22LD3**



Cable Tie
(Refer to p. A-24)

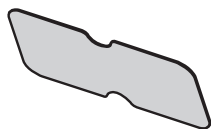

Protection Cover
(Refer to p. A-26)

Only 26/32LD3**



x 8
(M4 X 20)

Bolts for stand assembly
(Refer to p. A-18)

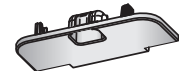



Protection Cover
(Refer to p. A-26)

PREPARATION

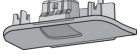



Only 32/37/42/47LD4**

 x 8
 (M4 X 20)
 Bolts for stand assembly (Refer to p. A-18)
  Protection Cover (Refer to p. A-26)







Only 32/42/46/52/60LD5**

 x 8
 (M4 X 20)
 Bolts for stand assembly (Refer to p. A-18)
  Protection Cover (Refer to p. A-26)
  (Only 32/42/52LD56*)
 Nero MediaHome 4 Essentials CD

Only 22/26LE53, 26LE3*****

 x 4
 (M4x14) Bolts for stand assembly (Refer to p. A-19)
  x 4
 (M4x20) (Only 26LE53**, 26LE3***)
 Bolts for stand assembly (Refer to p. A-19)
  Cable Holder (Refer to p. A-25)
  AC/DC Adaptor (Refer to p. A-27)
  4-Ring spacers (Only 26LE53**, 26LE3***)
 (Refer to p. A-27)

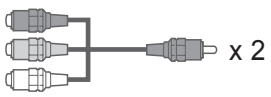
Only 32/37/42/47/55LE53, 32/42/47/55LE4***, 32LE3*****

 x 4
 (M4x22) (Only 32LE53**, 32LE45**, 32/42/47/55LE46**, 32LE3***)
 Bolts for stand assembly (Refer to p. A-19 or A-22)
  x 4
 (M4x24) (Only 37/42LE53**, 42LE45**)
  x 4
 (M4x26) (Only 47/55LE53**)
  x 4
 (M4x16)
  x 2
 Component gender cable, AV gender cable
  Cable Holder (Refer to p. A-25)

(Only 32/42/47/55LE46**)

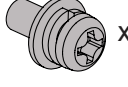
 x 2
 Woofer Pemnut (Refer to p. A-23)
  x 2
 Woofer Fixing Screw (Refer to p. A-23)

Only 32/37/42/47/55LD6**

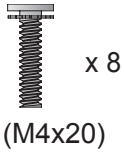

Bolts for stand assembly
(Refer to p. A-18)



Protection cover
(Refer to p. A-26)

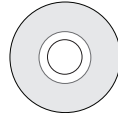

Nero MediaHome
4 Essentials CD

Only 32/37/42/47/55LE55**, 32/37/42/47/55LE7***, 42/47/55LE8***, 42/47/55LX6***, 47/55LX9***

(Only 32/37/42/47LE55**,
32/37/42/47LE7***,
42/47LX6***)

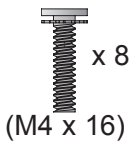

(M4 x 16)

(Only 42/47/55LE8***)



(M4 x 20)

(Only 55LE55**,
55LE7***, 55LX6***)

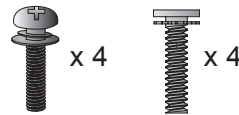

(M4 x 24) (M4 x 16)

(Only 47/55LX9***)

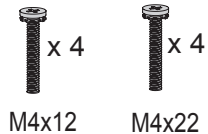

M4x12 M4x22

Bolts for stand assembly (Refer to p. A-20)

Bolts for stand assembly
(Refer to p. A-21)



cleansing cloths(mitt)
(Only 32/37/42/47/55LE7***)

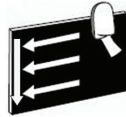

Slightly wipe stained spot on the exterior only with the cleansing cloths(mitt) for the product exterior if there is stain or fingerprint on surface of the exterior.

For cleaning front frame, please slowly wipe in one direction after spraying water 1~2 times on cleansing cloths. Please remove excessive moisture after cleaning. Excessive moisture may cause water stains on the frame.



Cable Holder
(Refer to p. A-25)

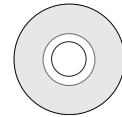

Nero MediaHome
4 Essentials CD

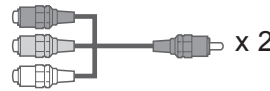

Component gender cable,
AV gender cable

(Only 42/47/55LX6***)



3D Glasses
(AG-S100)

(Only 47/55LX9***)

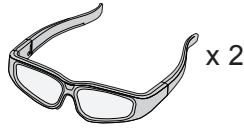

3D Glasses
(AG-S100)

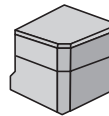

Stand Rear Cover

Only 22/26LE6***

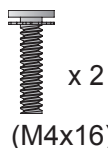

Bolts for stand assembly
(Refer to p. A-21)



Cable Tie
(Refer to p. A-24)



AC/DC Adaptor
(Refer to p. A-27)

PREPARATION

FRONT PANEL CONTROLS

NOTE

- ▶ TV can be placed in standby mode in order to reduce the power consumption. And TV should be switched off using the power switch on the TV if it will not be watched for some time, as this will reduce energy consumption.
- ▶ The energy consumed during use can be significantly reduced if the level of brightness of the picture is reduced, and this will reduce the overall running cost.

CAUTION

- ▶ Do not step on the glass stand or subject it to any impact. It may break, causing possible injury from fragments of glass, or the TV may fall.
- ▶ Do not drag the TV. The floor or the product may be damaged.

■ Image shown may differ from your TV.

Only 22/26/32LD3**

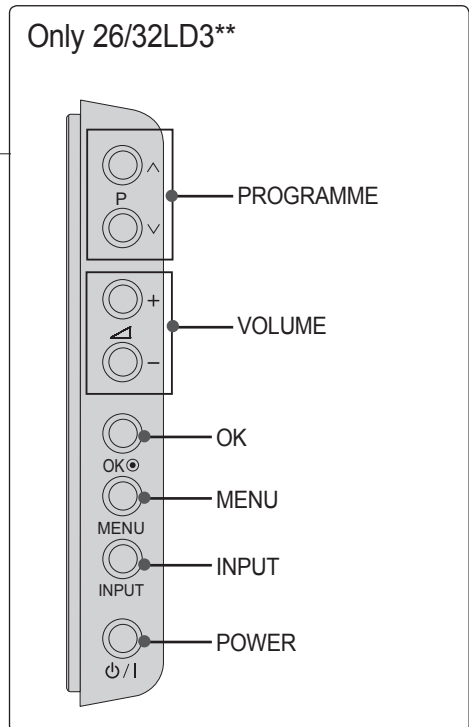
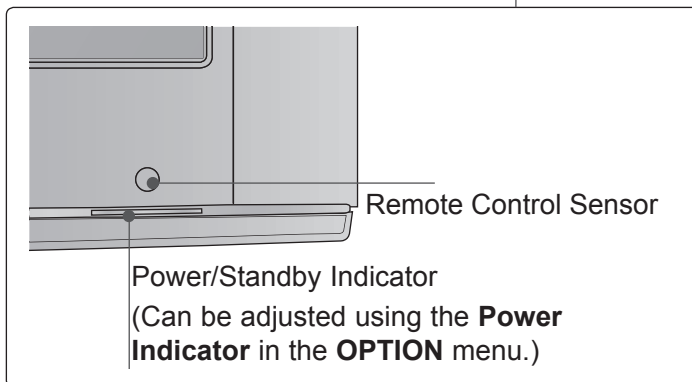
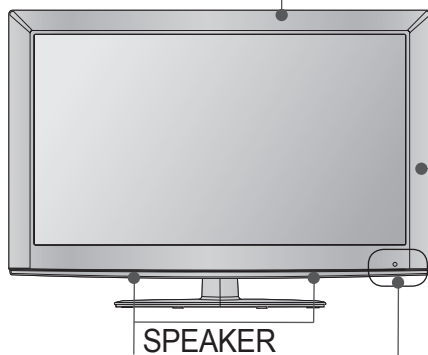
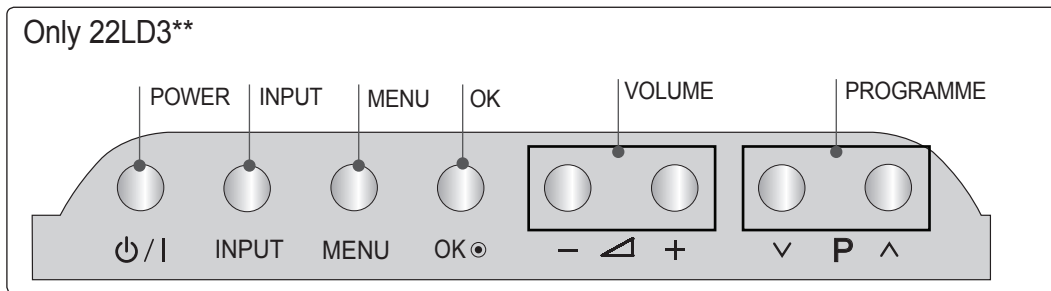

■ Image shown may differ from your TV.

Only 32/37/42/47LD4**

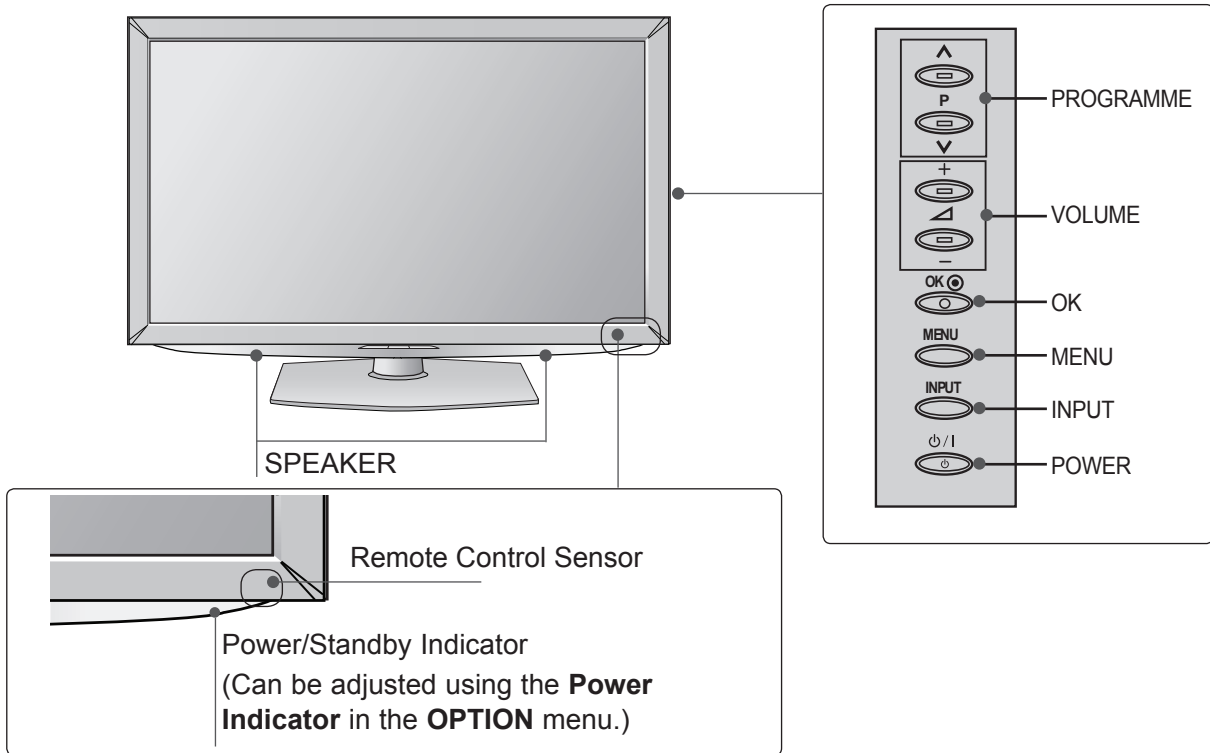

Only 32/42/46/52/60LD5**

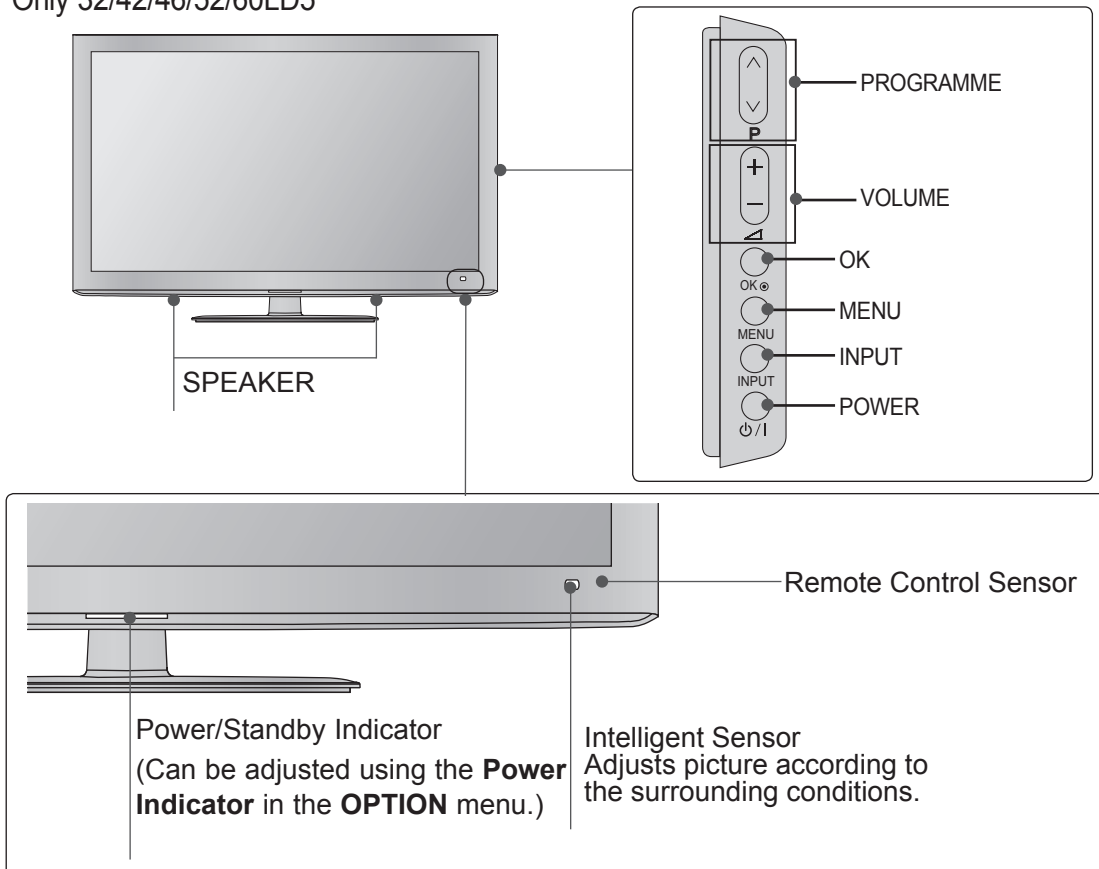

PREPARATION

■ Image shown may differ from your TV.

Only 32/37/42/47/55LD6**

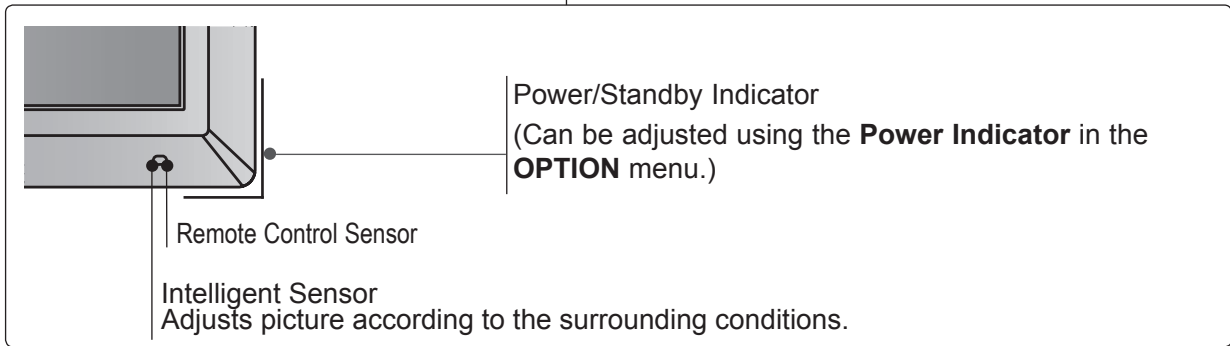
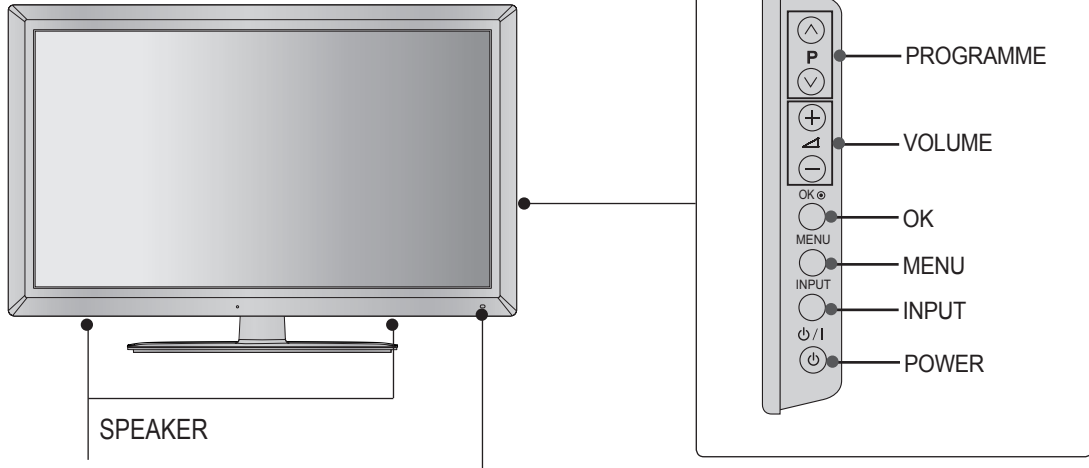

■ Image shown may differ from your TV.

Only 22/26LE53**, 26LE3***

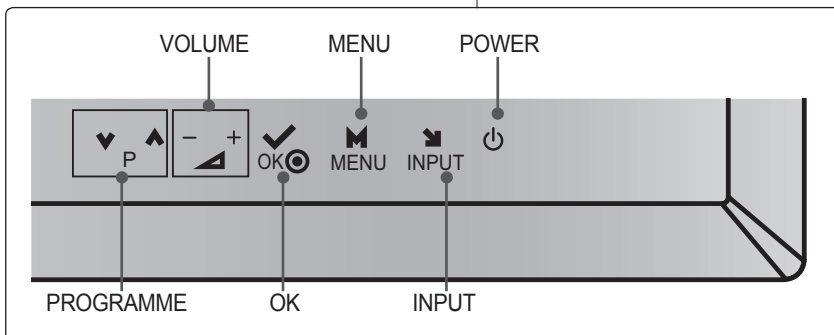
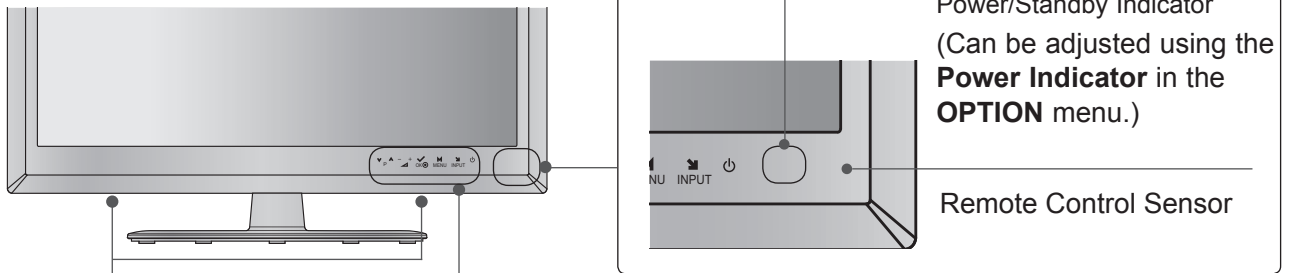

■ Image shown may differ from your TV.

Only 32/37/42/47/55LE5***, 32/37/42/47/55LE7***, 42/47/55LX6***, 32LE3***

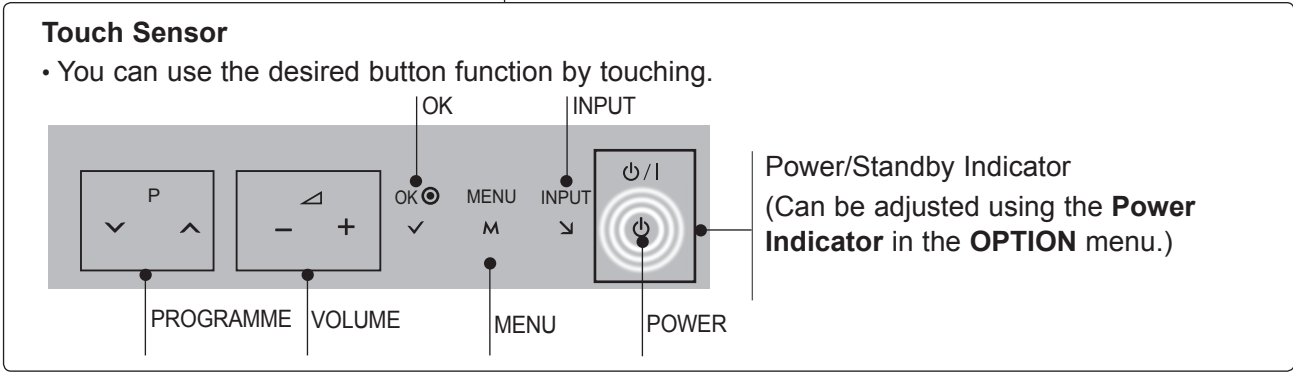
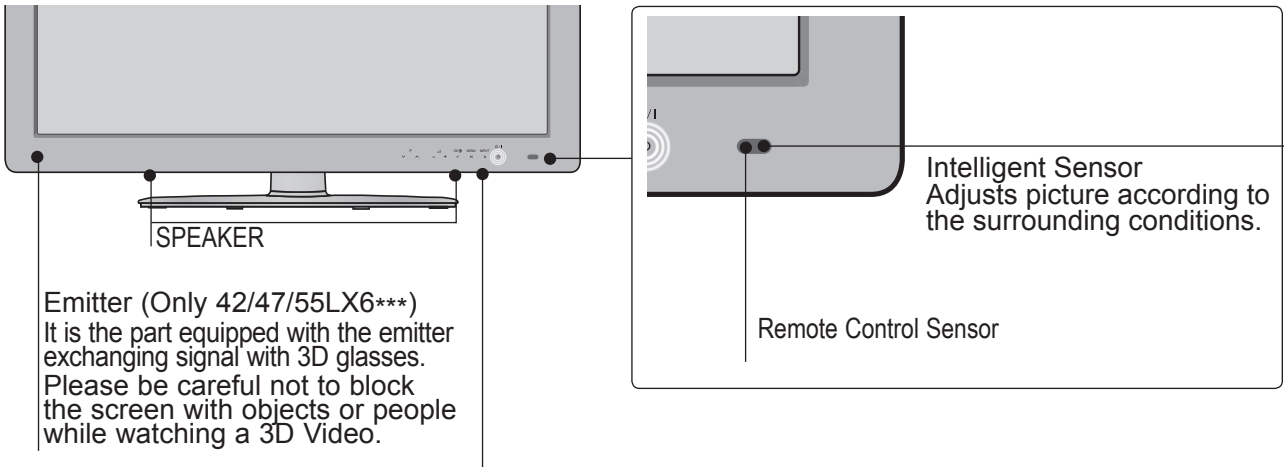

Only 22/26LE6***

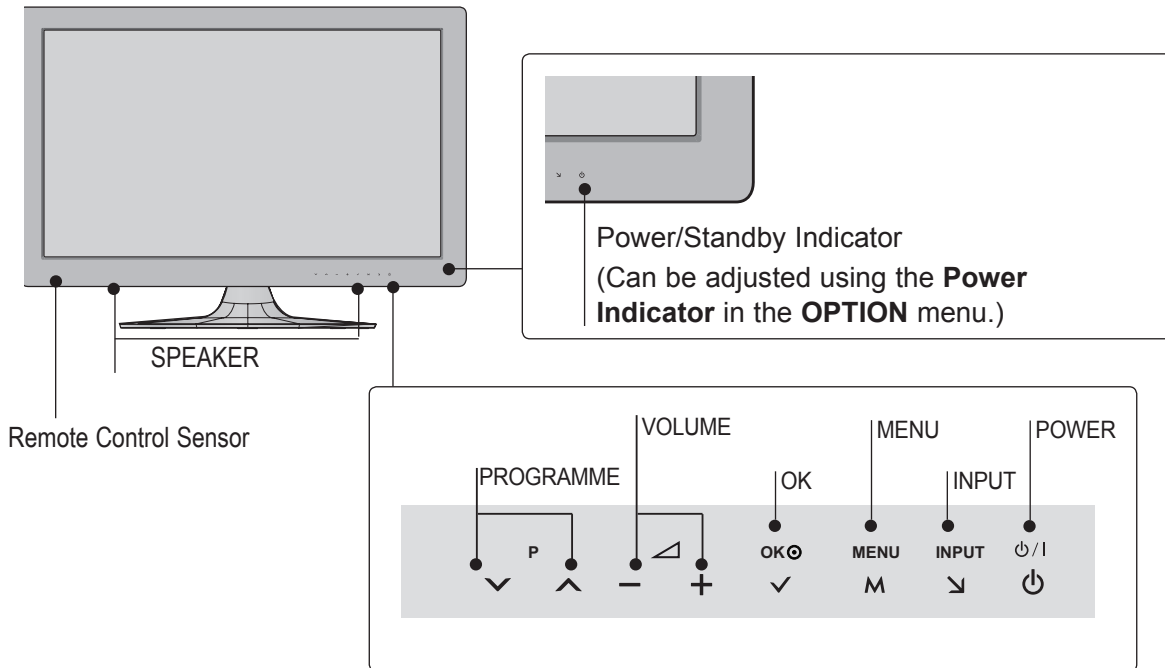

PREPARATION

■ Image shown may differ from your TV.

Only 42/47/55LE8***

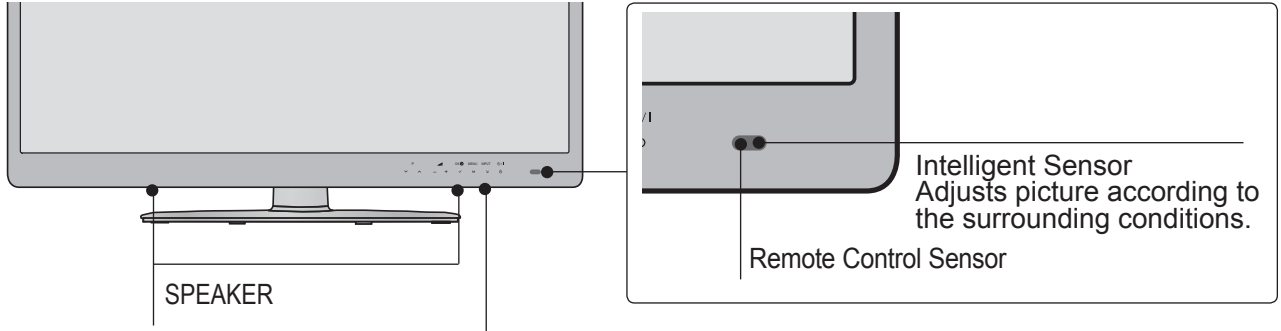

Touch Sensor

• You can use the desired button function by touching.

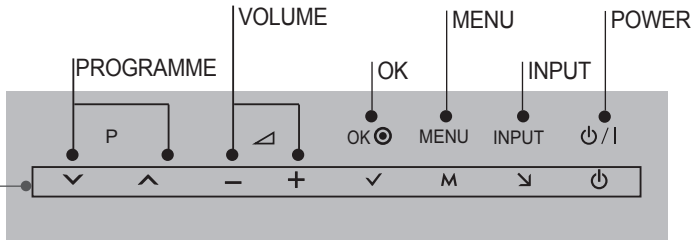

Power/Standby Indicator
(Can be adjusted using the **Power Indicator** in the **OPTION** menu.)

Only 32/42/47/55LE4***

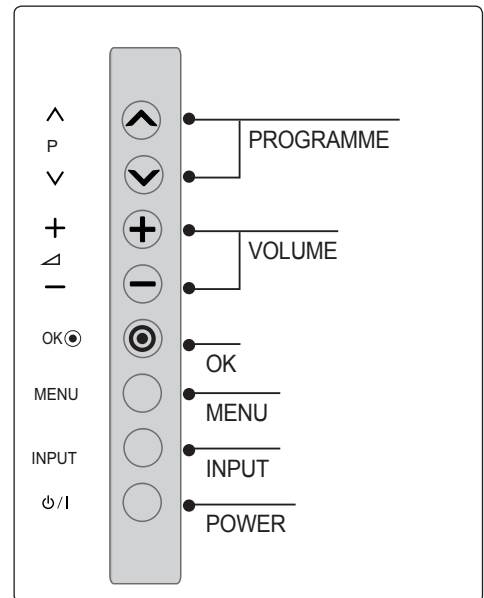
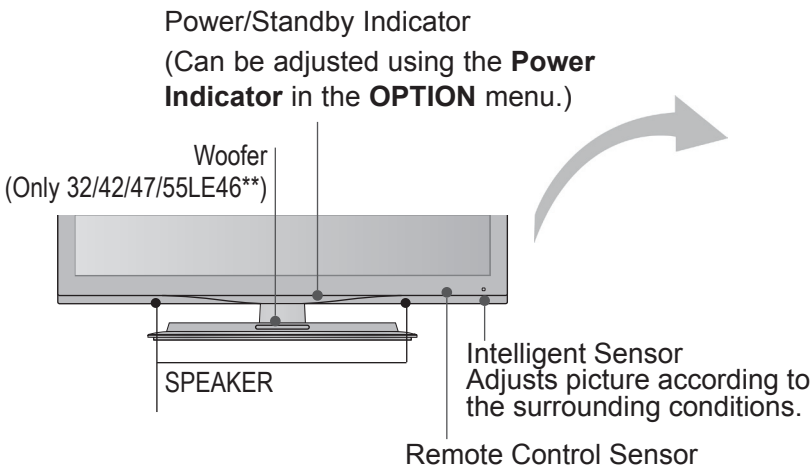

■ Image shown may differ from your TV.

Only 47/55LX9***

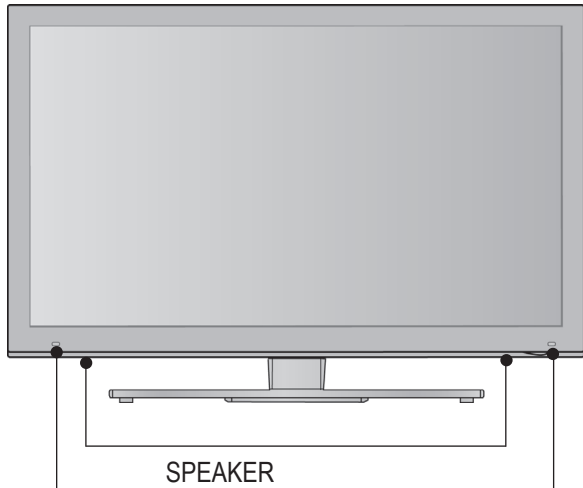

Emitter

It is the part equipped with the emitter exchanging signal with 3D glasses. Please be careful not to block the screen with objects or people while watching a 3D Video.

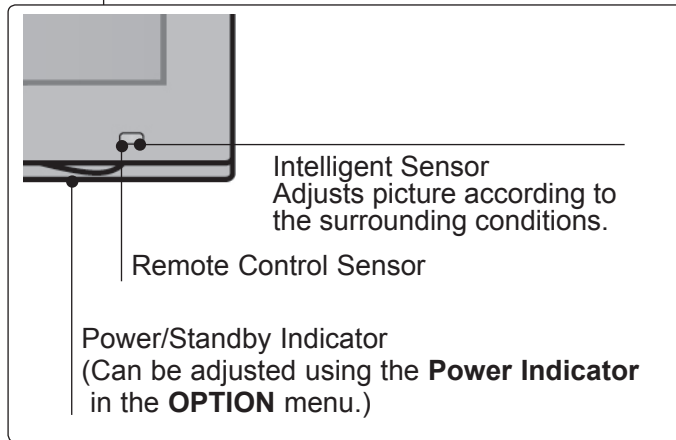
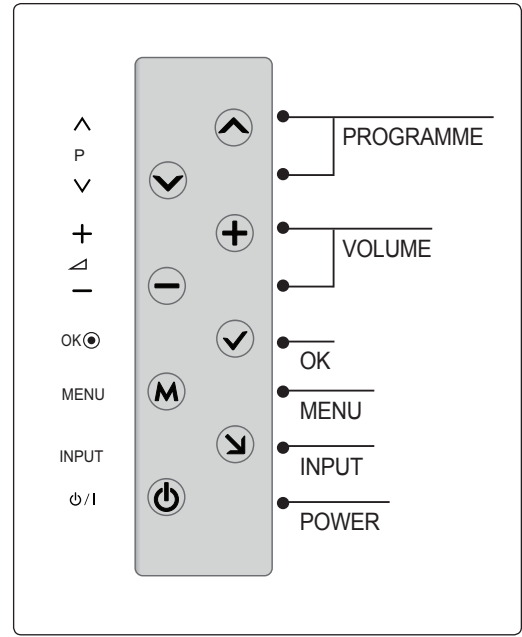

Intelligent Sensor
Adjusts picture according to the surrounding conditions.

Remote Control Sensor

Power/Standby Indicator
(Can be adjusted using the **Power Indicator** in the **OPTION** menu.)

PREPARATION

BACK PANEL INFORMATION

- Image shown may differ from your TV.

Only 22LD3**

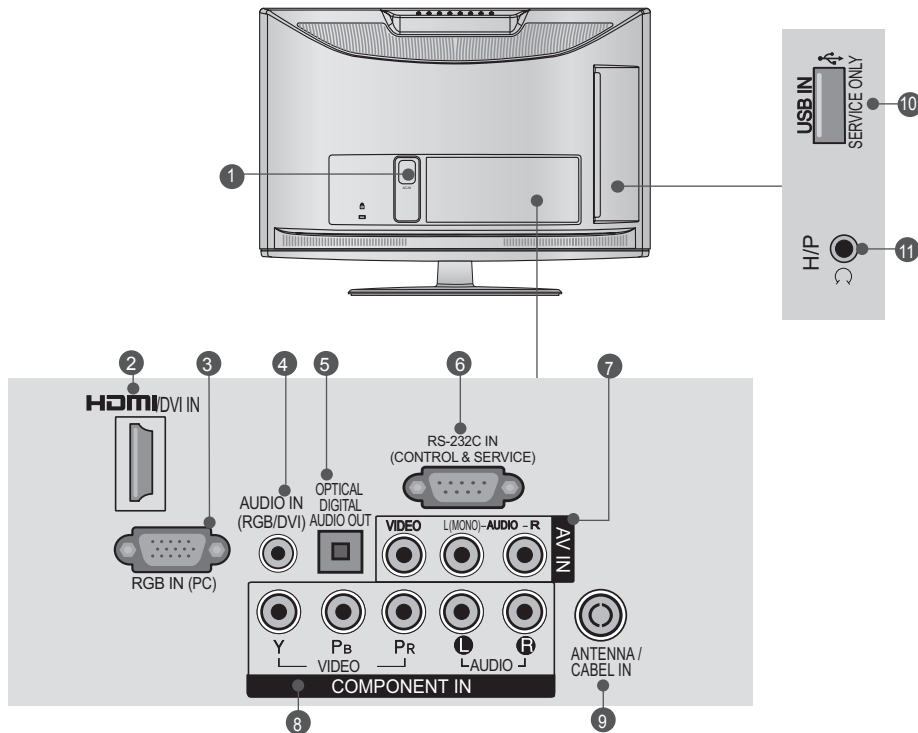

- 1 Power Cord Socket**
This TV operates on an AC power. The voltage is indicated on the Specifications page. (▶ p.161 to 173) Never attempt to operate the TV on DC power.
- 2 HDMI/DVI IN Input**
Connect an HDMI signal to HDMI IN. Or DVI (VIDEO) signal to HDMI/DVI port with DVI to HDMI cable.
- 3 RGB IN Input**
Connect the output from a PC.
- 4 RGB/DVI Audio Input**
Connect the audio from a PC or DTV.
- 5 OPTICAL DIGITAL AUDIO OUT**
Connect digital audio to various types of equipment.
Connect to a Digital Audio Component.
Use an Optical audio cable.
- 6 RS-232C IN (CONTROL & SERVICE) PORT**
Connect to the RS-232C port on a PC.
This port is used for Service or Hotel mode.
- 7 Audio/Video Input**
Connect audio/video output from an external device to these jacks.
- 8 Component Input**
Connect a component video/audio device to these jacks.
- 9 Antenna / Cable Input**
Connect antenna or cable to this jack.
- 10 SERVICE ONLY PORT**
- 11 Headphone Socket**
Plug the headphone into the headphone socket.

■ Image shown may differ from your TV.

Only 26/32LD3**

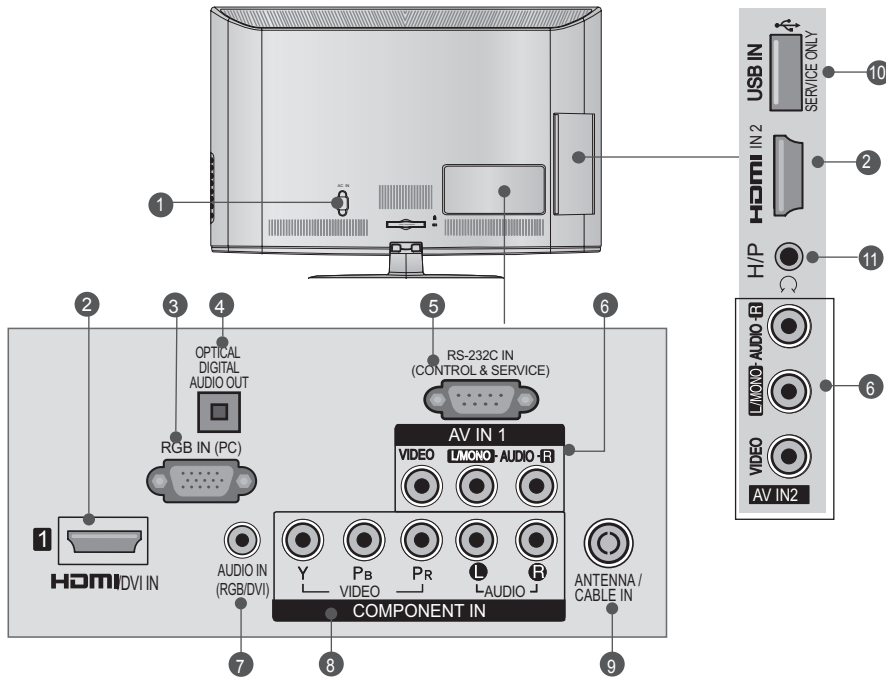

- 1 Power Cord Socket**
This TV operates on an AC power. The voltage is indicated on the Specifications page. (▶ p.161 to 173) Never attempt to operate the TV on DC power.
- 2 HDMI/DVI IN Input**
Connect an HDMI signal to HDMI IN. Or DVI (VIDEO) signal to HDMI/DVI port with DVI to HDMI cable.
- 3 RGB IN Input**
Connect the output from a PC.
- 4 OPTICAL DIGITAL AUDIO OUT**
Connect digital audio to various types of equipment.
Connect to a Digital Audio Component.
Use an Optical audio cable.
- 5 RS-232C IN (CONTROL & SERVICE) PORT**
Connect to the RS-232C port on a PC.
This port is used for Service or Hotel mode.
- 6 Audio/Video Input**
Connect audio/video output from an external device to these jacks.
- 7 RGB/DVI Audio Input**
Connect the audio from a PC or DTV.
- 8 Component Input**
Connect a component video/audio device to these jacks.
- 9 Antenna / Cable Input**
Connect antenna or cable to this jack.
- 10 SERVICE ONLY PORT**
- 11 Headphone Socket**
Plug the headphone into the headphone socket.

PREPARATION

- Image shown may differ from your TV.
Only 32/37/42/47LD4**

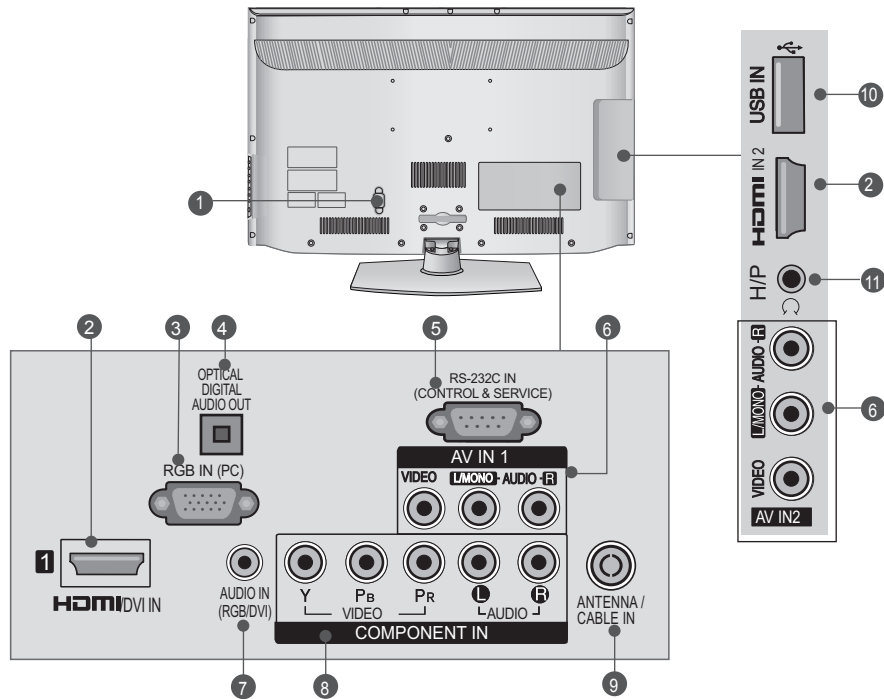

- 1 Power Cord Socket**
This TV operates on an AC power. The voltage is indicated on the Specifications page. (▶ p.161 to 173) Never attempt to operate the TV on DC power.
- 2 HDMI/DVI IN Input**
Connect an HDMI signal to HDMI IN. Or DVI (VIDEO) signal to HDMI/DVI port with DVI to HDMI cable.
- 3 RGB IN Input**
Connect the output from a PC.
- 4 OPTICAL DIGITAL AUDIO OUT**
Connect digital audio to various types of equipment.
Connect to a Digital Audio Component.
Use an Optical audio cable.
- 5 RS-232C IN (CONTROL & SERVICE) PORT**
Connect to the RS-232C port on a PC.
This port is used for Service or Hotel mode.
- 6 Audio/Video Input**
Connect audio/video output from an external device to these jacks.
- 7 RGB/DVI Audio Input**
Connect the audio from a PC or DTV.
- 8 Component Input**
Connect a component video/audio device to these jacks.
- 9 Antenna / Cable Input**
Connect antenna or cable to this jack.
- 10 USB Input**
Connect USB storage device to this jack.
- 11 Headphone Socket**
Plug the headphone into the headphone socket.

■ Image shown may differ from your TV.

Only 32/42/46/52/60LD55*

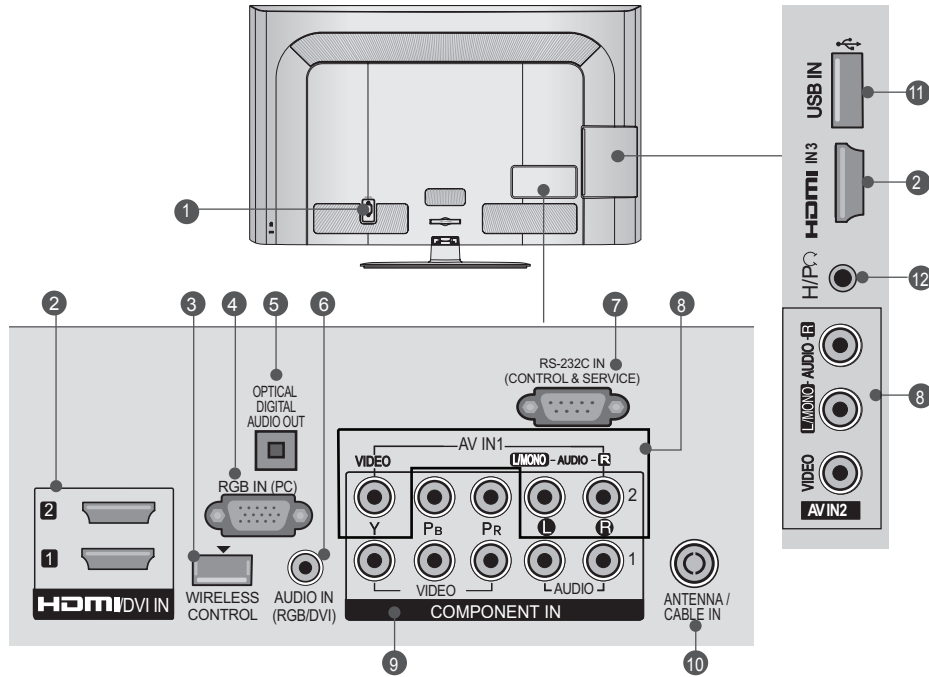

1 Power Cord Socket

This TV operates on an AC power. The voltage is indicated on the Specifications page. (▶ p.161 to 173) Never attempt to operate the TV on DC power.

2 HDMI/DVI IN Input

Connect an HDMI signal to HDMI IN. Or DVI (VIDEO) signal to HDMI/DVI port with DVI to HDMI cable.

3 WIRELESS Control

Connect the Wireless Dongle to the TV to control the external input devices connected to Media Box wirelessly.

4 RGB IN Input

Connect the output from a PC.

5 OPTICAL DIGITAL AUDIO OUT

Connect digital audio to various types of equipment.
Connect to a Digital Audio Component.
Use an Optical audio cable.

6 RGB/DVI Audio Input

Connect the audio from a PC or DTV.

7 RS-232C IN (CONTROL & SERVICE) PORT

Connect to the RS-232C port on a PC.
This port is used for Service or Hotel mode.

8 Audio/Video Input

Connect audio/video output from an external device to these jacks.

9 Component Input

Connect a component video/audio device to these jacks.

10 Antenna / Cable Input

Connect antenna or cable to this jack.

11 USB Input

Connect USB storage device to this jack.

12 Headphone Socket

Plug the headphone into the headphone socket.

PREPARATION

■ Image shown may differ from your TV.

Only 32/42/52LD56*, 32/37/42/47/55LD6**

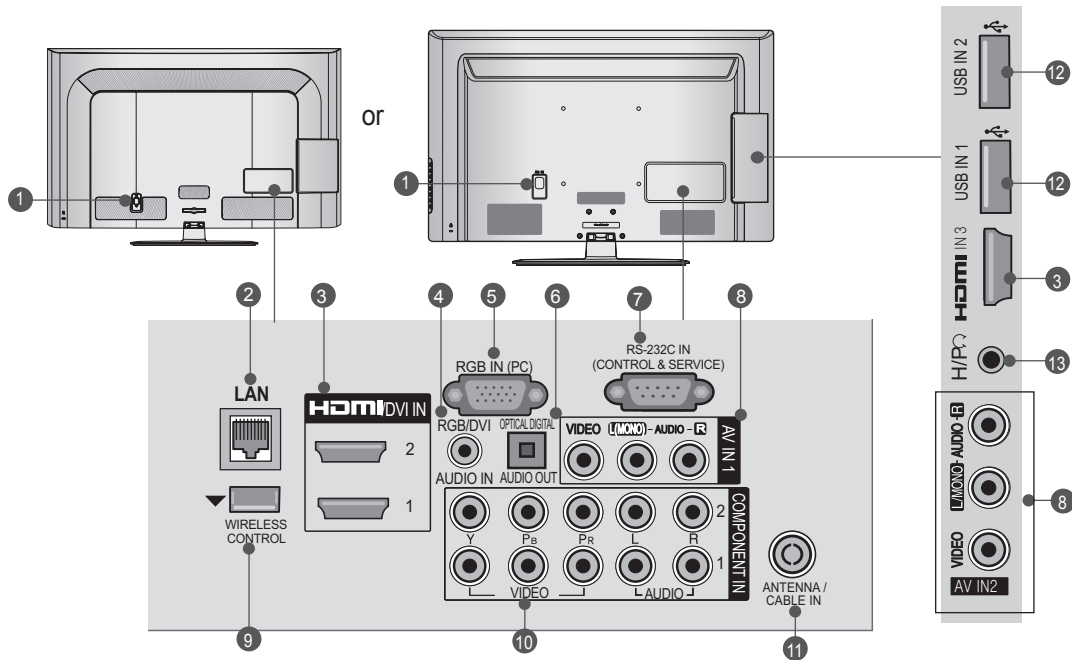

1 Power Cord Socket

This TV operates on an AC power. The voltage is indicated on the Specifications page. (▶ p.161 to 173) Never attempt to operate the TV on DC power.

2 LAN

Network connection for Weather info, Photo Album, Movie Online, etc.
Also used for video, photo and music files on a local network.

3 HDMI/DVI IN Input

Connect an HDMI signal to HDMI IN. Or DVI (VIDEO) signal to HDMI/DVI port with DVI to HDMI cable.

4 RGB/DVI Audio Input

Connect the audio from a PC or DTV.

5 RGB IN Input

Connect the output from a PC.

6 OPTICAL DIGITAL AUDIO OUT

Connect digital audio to various types of equipment.
Connect to a Digital Audio Component.
Use an Optical audio cable.

7 RS-232C IN (CONTROL & SERVICE) PORT

Connect to the RS-232C port on a PC.
This port is used for Service or Hotel mode.

8 Audio/Video Input

Connect audio/video output from an external device to these jacks.

9 WIRELESS Control

Connect the Wireless Dongle to the TV to control the external input devices connected to Media Box wirelessly.

10 Component Input

Connect a component video/audio device to these jacks.

11 Antenna / Cable Input

Connect antenna or cable to this jack.

12 USB Input

Connect USB storage device to this jack.

13 Headphone Socket

Plug the headphone into the headphone socket.

■ Image shown may differ from your TV.

Only 22/26LE53**, 22/26LE6***, 26LE3***

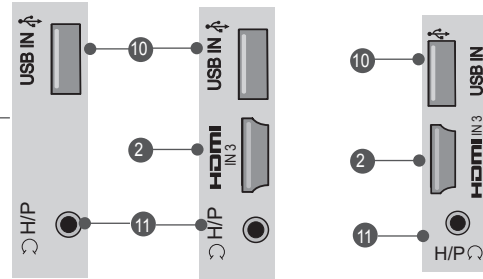
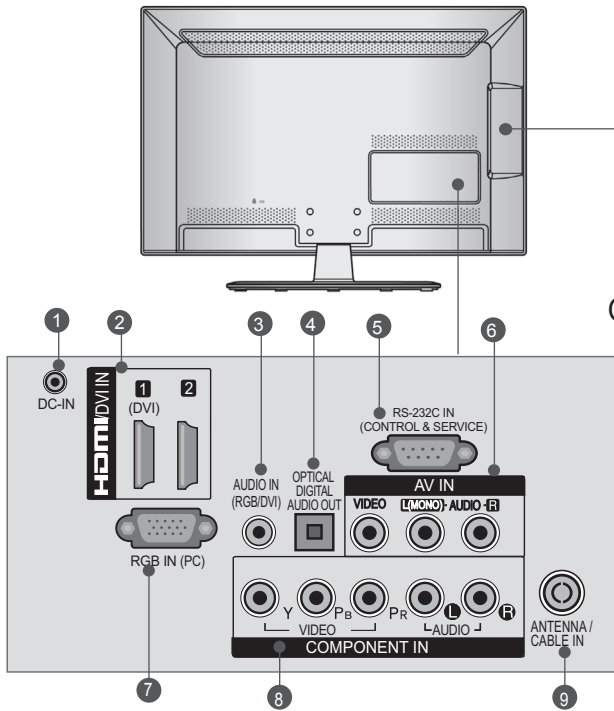

Only 22LE53**

Only 26LE53**, Only 22/26LE6***, 26LE3***

- 1 DC ADAPTER PORT**
Connect to the power cord socket.
- 2 HDMI/DVI IN Input**
Connect an HDMI signal to HDMI IN. Or DVI (VIDEO) signal to HDMI/DVI port with DVI to HDMI cable.
- 3 RGB/DVI Audio Input**
Connect the audio from a PC or DTV.
- 4 OPTICAL DIGITAL AUDIO OUT**
Connect digital audio to various types of equipment.
Connect to a Digital Audio Component. Use an Optical audio cable.
- 5 RS-232C IN (CONTROL & SERVICE) PORT**
Connect to the RS-232C port on a PC. This port is used for Service or Hotel mode.
- 6 Audio/Video Input**
Connect audio/video output from an external device to these jacks.
- 7 RGB IN Input**
Connect the output from a PC.
- 8 Component Input**
Connect a component video/audio device to these jacks.
- 9 Antenna / Cable Input**
Connect antenna or cable to this jack.
- 10 USB Input**
Connect USB storage device to this jack.
- 11 Headphone Socket**
Plug the headphone into the headphone socket.

PREPARATION

■ Image shown may differ from your TV.

Only 32/37/42/47/55LE53**, 32/42/47/55LE4***, 32LE3***

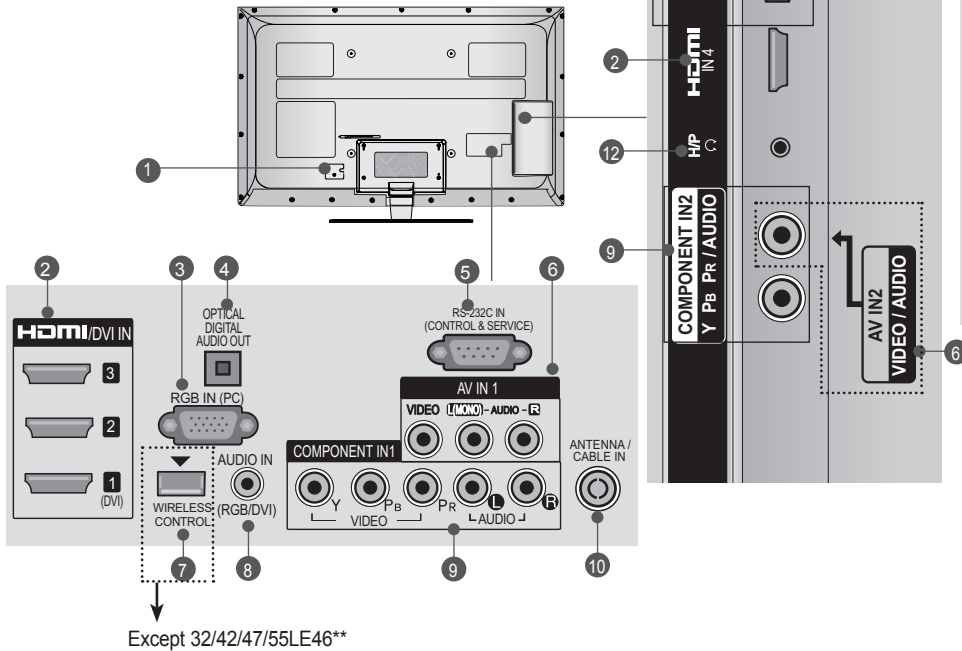

⚠ CAUTION

▶ Use a product with the following thickness for optimal connection to HDMI cable (only HDMI IN 4) / USB device.

*A ≤ 10 mm

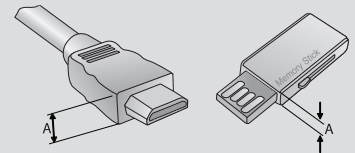

1 Power Cord Socket

This TV operates on an AC power. The voltage is indicated on the Specifications page. (▶ p.161 to 173) Never attempt to operate the TV on DC power.

2 HDMI/DVI IN Input

Connect an HDMI signal to HDMI IN. Or DVI (VIDEO) signal to HDMI/DVI port with DVI to HDMI cable.

3 RGB IN Input

Connect the output from a PC.

4 OPTICAL DIGITAL AUDIO OUT

Connect digital audio to various types of equipment.
Connect to a Digital Audio Component.
Use an Optical audio cable.

5 RS-232C IN (CONTROL & SERVICE) PORT

Connect to the RS-232C port on a PC.
This port is used for Service or Hotel mode.

6 Audio/Video Input

Connect audio/video output from an external device to these jacks.

7 WIRELESS Control

(Except 32/42/47/55LE46**)

Connect the Wireless Dongle to the TV to control the external input devices connected to Media Box wirelessly.

8 RGB/DVI Audio Input

Connect the audio from a PC or DTV.

9 Component Input

Connect a component video/audio device to these jacks.

10 Antenna / Cable Input

Connect antenna or cable to this jack.

11 USB Input

Connect USB storage device to this jack.

12 Headphone Socket

Plug the headphone into the headphone socket.

■ Image shown may differ from your TV.

Only 32/37/42/47/55LE55**, 32/37/42/47/55LE7***, 42/47/55LE8***,
42/47/55LX6***, 47/55LX9***

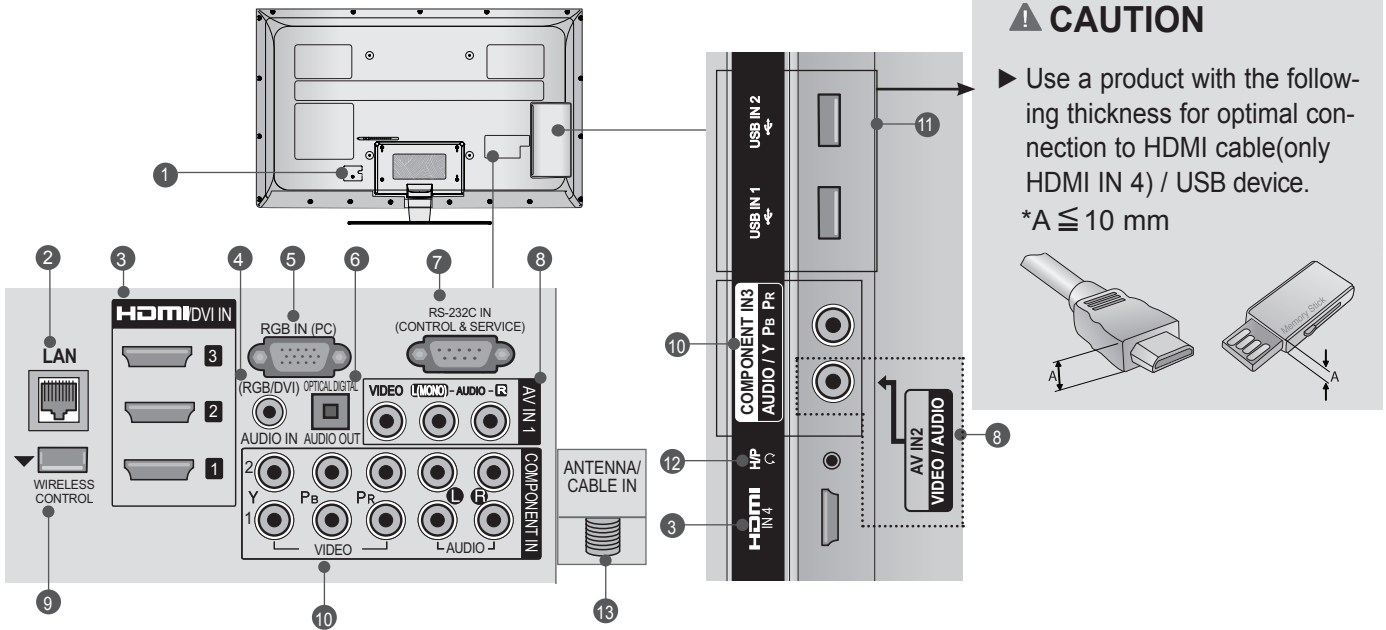

1 Power Cord Socket

This TV operates on an AC power. The voltage is indicated on the Specifications page. (▶ p.161 to 173) Never attempt to operate the TV on DC power.

2 LAN

Network connection for Weather info, Photo Album, Movie Online, etc.
Also used for video, photo and music files on a local network.

3 HDMI/DVI IN Input

Connect an HDMI signal to HDMI IN. Or DVI (VIDEO) signal to HDMI/DVI port with DVI to HDMI cable.

4 RGB/DVI Audio Input

Connect the audio from a PC or DTV.

5 RGB IN Input

Connect the output from a PC.

6 OPTICAL DIGITAL AUDIO OUT

Connect digital audio to various types of equipment.
Connect to a Digital Audio Component.
Use an Optical audio cable.

7 RS-232C IN (CONTROL & SERVICE) PORT

Connect to the RS-232C port on a PC.
This port is used for Service or Hotel mode.

8 Audio/Video Input

Connect audio/video output from an external device to these jacks.

9 WIRELESS Control

Connect the Wireless Dongle to the TV to control the external input devices connected to Media Box wirelessly.

10 Component Input

Connect a component video/audio device to these jacks.

11 USB Input

Connect USB storage device to this jack.

12 Headphone Socket

Plug the headphone into the headphone socket.

13 Antenna / Cable Input

Connect antenna or cable to this jack.

CAUTION

▶ Use a product with the following thickness for optimal connection to HDMI cable(only HDMI IN 4) / USB device.

*A ≤ 10 mm

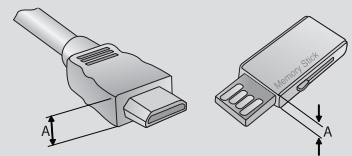

PREPARATION

STAND INSTALLATION

- Image shown may differ from your TV.

When assembling the desk type stand, check whether the bolt is fully tightened. (If not tightened fully, the product can tilt forward after the product installation.) If you tighten the bolt with excessive force, the bolt can deviate from abrasion of the tightening part of the bolt.

Only 22LD3**

- 1 Carefully place the TV screen side down on a cushioned surface to protect the screen from damage.

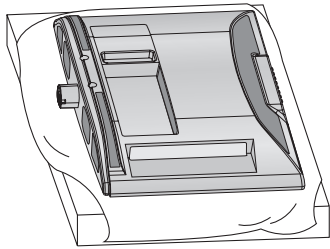

- 2 Assemble the TV as shown.

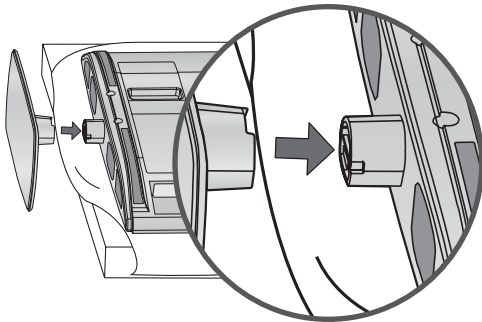

Only 26/32LD3**, 32/37/42/47LD4**,
32/42/46/52/60LD5**, 32/37/42/47/55LD6**

- 1 Carefully place the TV screen side down on a cushioned surface to protect the screen from damage.

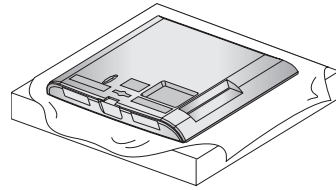

- 2 Assemble the parts of the **Stand Body** with the **Stand Base** of the TV.

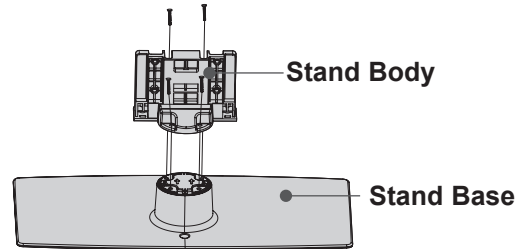

- 3 Assemble the TV as shown.

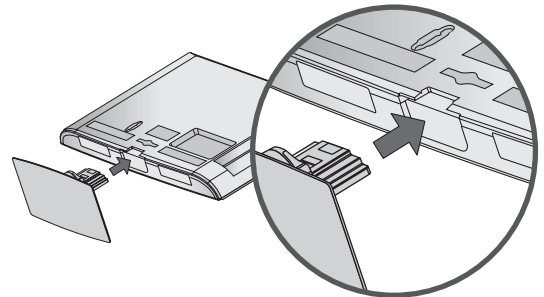

- 4 Fix the 4 bolts securely using the holes in the back of the TV.

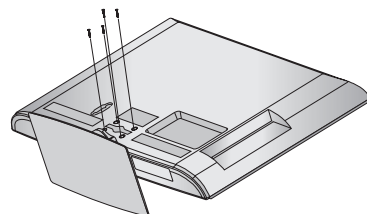

■ Image shown may differ from your TV.

Only 22LE53**

- 1 Carefully place the TV screen side down on a cushioned surface to protect the screen from damage.

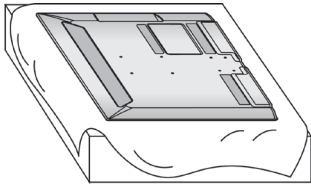

- 2 Assemble the parts of the **Stand Body** with the **Stand Base** of the TV.

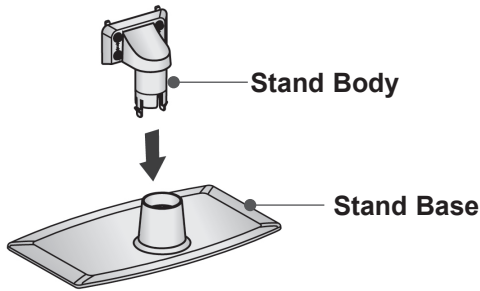

- 3 Assemble the TV as shown.

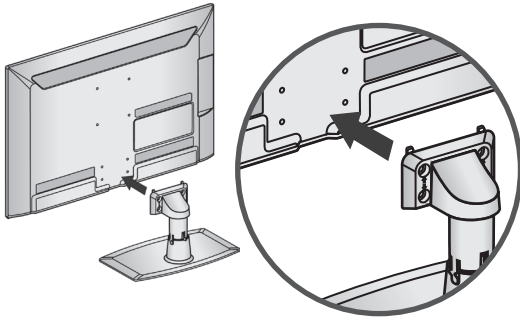

- 4 Fix the 4 bolts securely using the holes in the back of the TV.

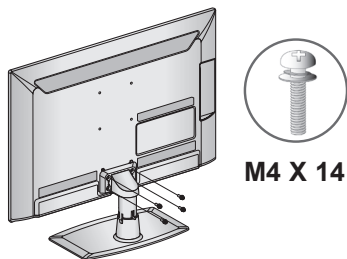

M4 X 14

Only 26/32/37/42/47/55LE53**, 26/32LE3***

- 1 Carefully place the TV screen side down on a cushioned surface to protect the screen from damage.

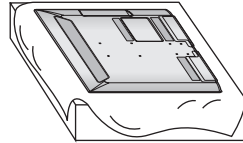

- 2 Assemble the parts of the **Stand Body** with the **Stand Base** of the TV.

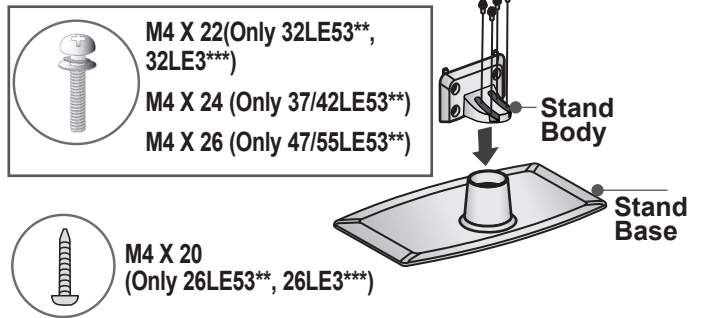

- 3 Assemble the TV as shown.

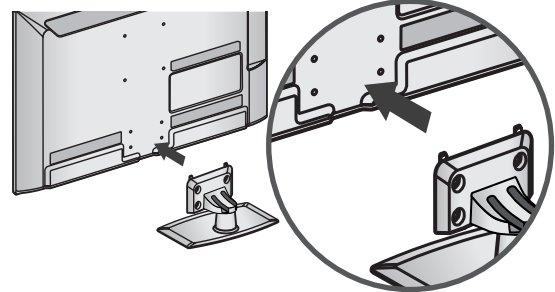

- 4 Assemble the parts of the **Stand Rear Cover** with the TV.

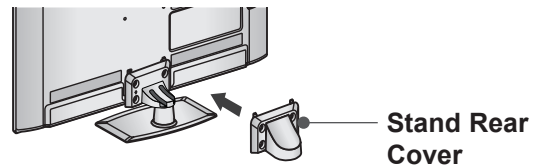

- 5 Fix the 4 bolts securely using the holes in the back of the TV.

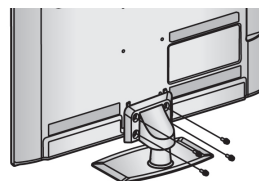

M4 X 14
(Only 26LE53**,
26LE3***)



M4 X 16 (Only
32/37/42/47/55LE53**,
32LE3***)

PREPARATION

■ Image shown may differ from your TV.

Only 32/37/42/47/55LE55**, 32/37/42/47/55LE7***, 42/47/55LE8***, 42/47/55LX6***

- 1 Carefully place the TV screen side down on a cushioned surface to protect the screen from damage.

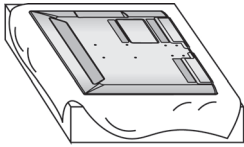

- 2 Assemble the parts of the **Stand Body** with the **Stand Base** of the TV.
At this time, tighten the screws that hold the **Stand Body** on.



(Only 32/37/42/47LE55**, 32/37/42/47LE7***, 42/47LX6***)



(Only 42/47/55LE8***)



(Only 55LE55**, 55LE7***, 55LX6***)

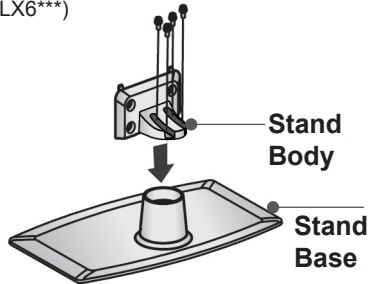

- 3 Assemble the TV as shown.

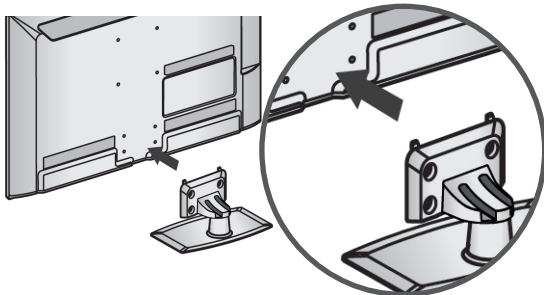

- 4 Assemble the parts of the **Stand Rear Cover** with the TV.

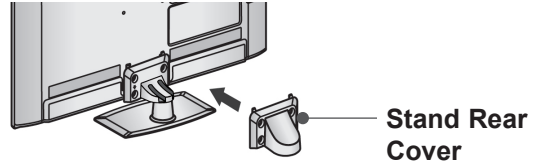

- 5 Fix the 4 bolts securely using the holes in the back of the TV.

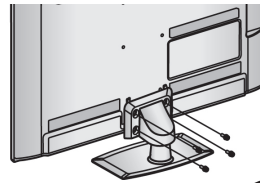

(Only 32/37/42/47/55LE55**, 32/37/42/47/55LE7***, 42/47/55LX6***)



(Only 42/47/55LE8***)

Only 47/55LX9***

- 1 Carefully place the TV screen side down on a cushioned surface to protect the screen from damage.

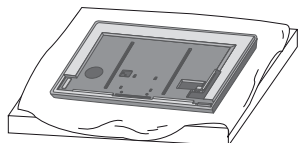

- 2 Assemble the parts of the **Stand Body** with the **Stand Base** of the TV.
At this time, tighten the screws that hold the **Stand Body** on.

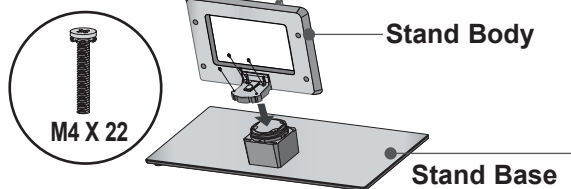

- 3 Fix the 4 bolts securely using the holes in the back of the TV.

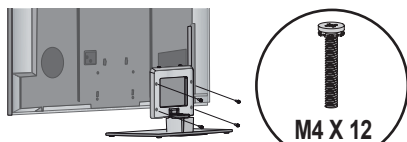

- 4 Assemble the parts of the **Stand Rear Cover** with the TV.

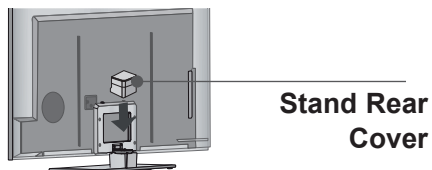

Only 22/26LE6***

- 1 Carefully place the TV screen side down on a cushioned surface to protect the screen from damage.

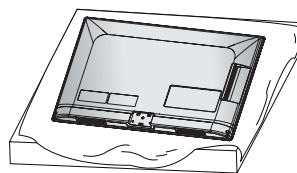

- 2 Assemble the TV as shown.

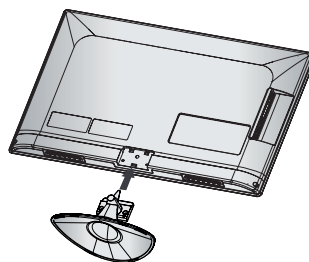

- 3 Fix the 2 screws securely using the holes in the back of the TV.

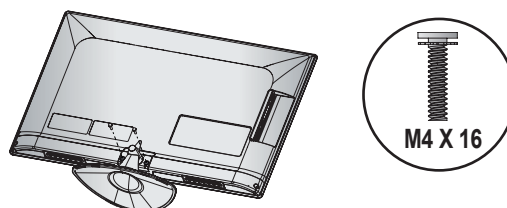

PREPARATION

■ Image shown may differ from your TV.

Only 32/42/47/55LE4***

- 1 Carefully place the TV screen side down on a cushioned surface to protect the screen from damage.

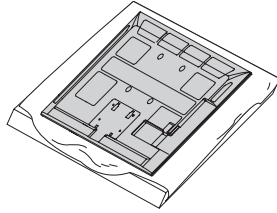

- 2 Assemble the parts of the **Stand Body** with the **Stand Base** of the TV.
At this time, tighten the screws that hold the **Stand Body** on.

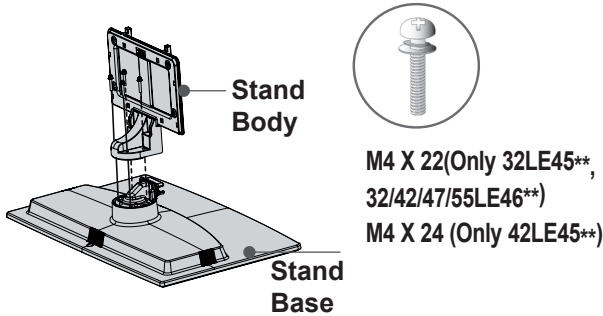

- 3 Assemble the TV as shown.

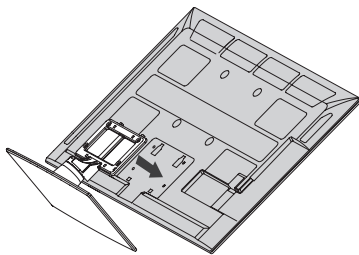

- 4 Assemble the parts of the **Stand Rear Cover** with the TV.

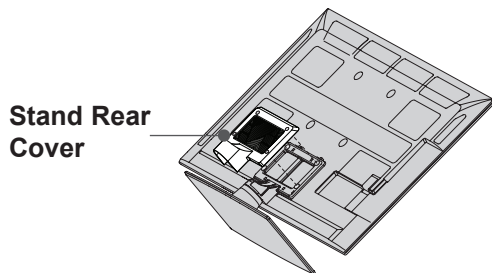

- 5 Fix the 4 bolts securely using the holes in the back of the TV.

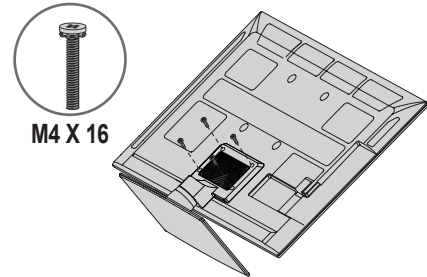

WOOFER INSTALLATION :WHEN USING THE WALL MOUNT

Only 32/42/47/55LE46**

- 1 Carefully place the TV screen side down on a cushioned surface to protect the screen from damage.

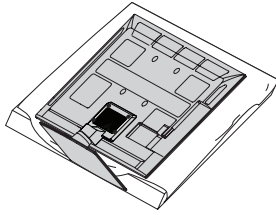

- 2 Remove the screws from the TV.

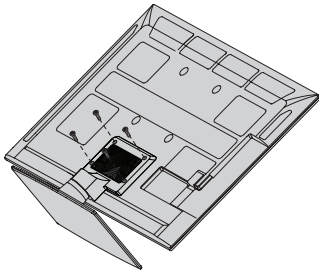

- 3 Detach the **Stand Rear Cover and Stand** from TV.

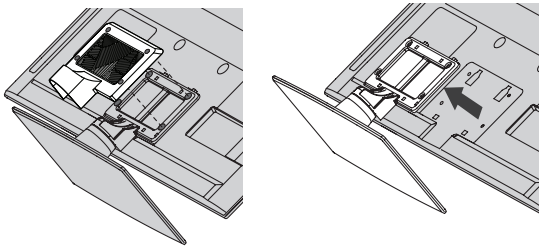

- 4 Detach the **Woofers** from the stand.

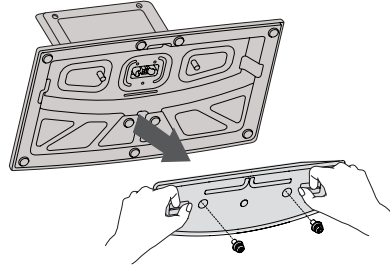

- 5 Assemble the **Woofers** with the TV.
Turn the PEM nut for the woofer using a flathead driver and install the 2 screws as shown.

When installing the woofer in the TV, make sure that the power cord is not twisted, bent or pinched.

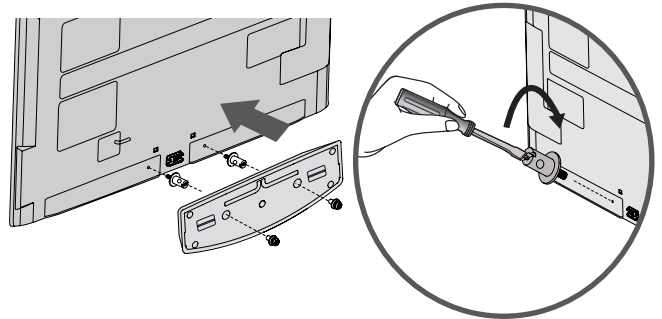

PREPARATION

BACK COVER FOR WIRE ARRANGEMENT

■ Image shown may differ from your TV.

Only 22LD3**, 22/26LE6***

After connecting the cables as necessary, install **Cable Tie** as shown and bundle the cables.

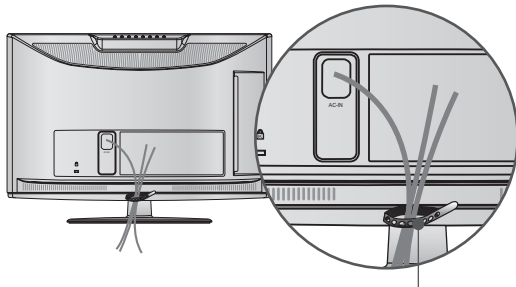

Cable Tie

Only 26/32LD3**, 32/37/42/47LD4**,
32/37/42/47/55LD6**, 32/42/46/52/60LD5**

- 1 Connect the cables as necessary.
To connect additional equipment, see the **External equipment setup** section.

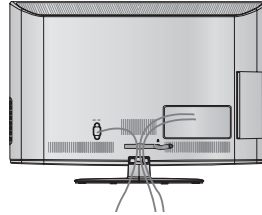

- 2 Open the **Cable Management Clip** as shown and manage the cables.

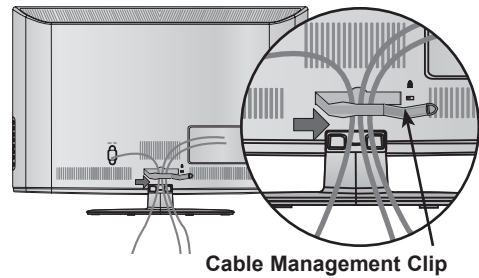

Cable Management Clip

- 3 Fit the **Cable management clip** as shown.

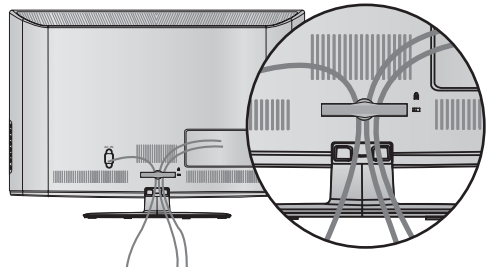

NOTE

- ▶ Do not use the **CABLE MANAGEMENT CLIP** to lift the TV.
- If the TV is dropped, you may be injured or the TV may be damaged.

■ Image shown may differ from your TV.

Only 22/26LE5***, 26LE3***

After connecting the cables as necessary, install **Cable Holder** as shown and bundle the cables.

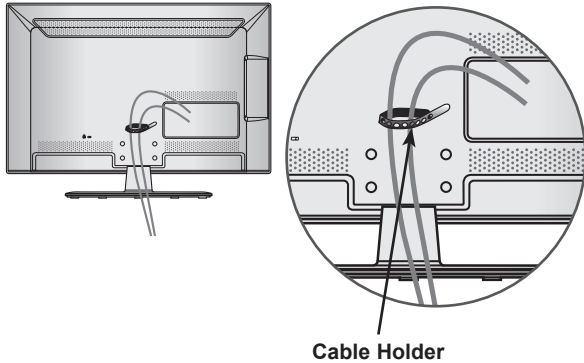

Only 32/37/42/47/55LE5***, 32/37/42/47/55LE7***, 42/47/55LE8***, 42/47/55LX6***, 47/55LX9***, 32/42/47/55LE4***, 32LE3***

- 1 Secure the power cord with the **Cable Holder** on the TV back cover. It will help prevent the power cable from being removed by accident.

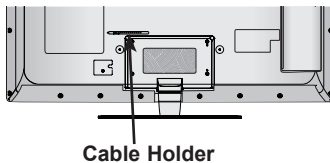

- 2 After connecting the cables as necessary, install **Cable Holder** as shown and bundle the cables.

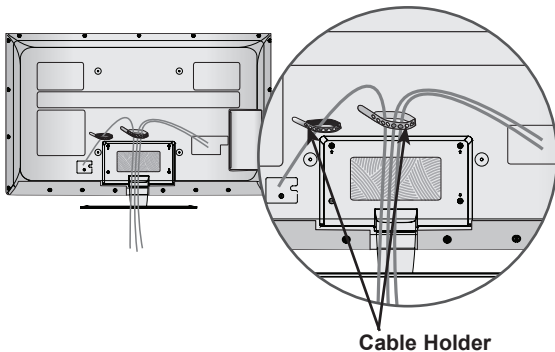

ATTACHING THE TV TO A DESK

(Only 26/32LD3**, 32/37/42LD4**, 32/42LD5**, 32/37/42LD6**, 32LE45**, 32/42/47/55LE46**, 32LE5***, 32LE7***, 32LE3***)

- Image shown may differ from your TV. The TV must be attached to desk so it cannot be pulled in a forward/backward direction, potentially causing injury or damaging the product. Use only an attached screw.

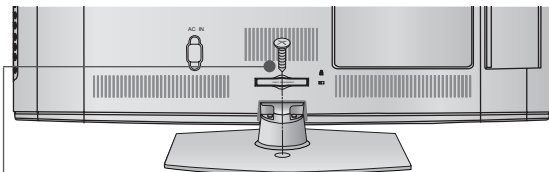

1-Screw (provided as parts of the product)

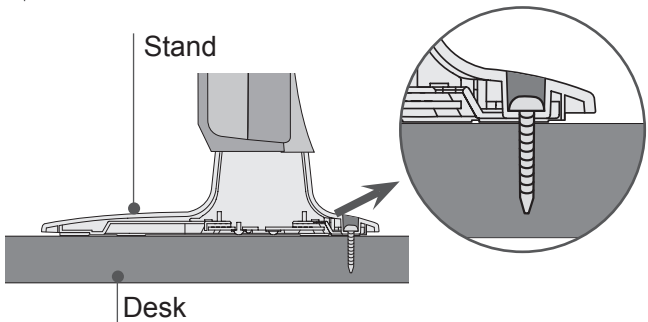

! WARNING

- ▶ To prevent TV from falling over, the TV should be securely attached to the floor/wall per installation instructions. Tipping, shaking, or rocking the machine may cause injury.

PREPARATION

NOT USING THE DESK-TYPE STAND

■ Image shown may differ from your TV.
When installing the wall-mounted unit, use the protection cover.

Only 22LD3**

- 1 Carefully place the TV screen side down on a cushioned surface to protect the screen from damage.

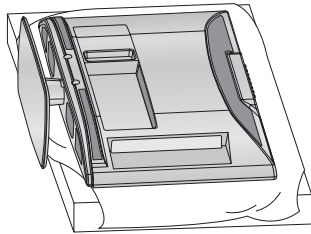

- 2 Loosen the bolts from TV.

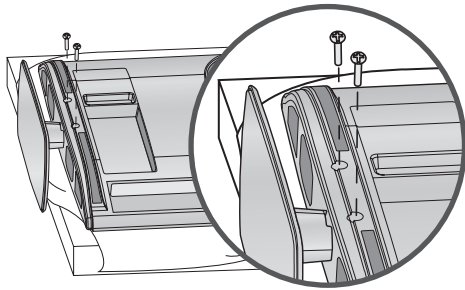

- 3 Detach the **Stand** from TV.

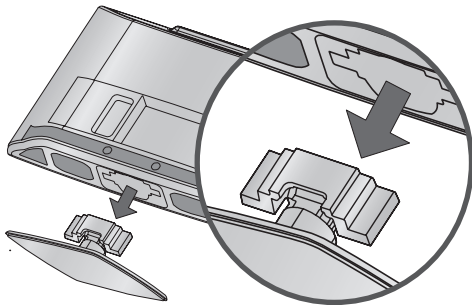

- 4 After removing the protection paper from the protection cover, adhere it to the TV as shown.

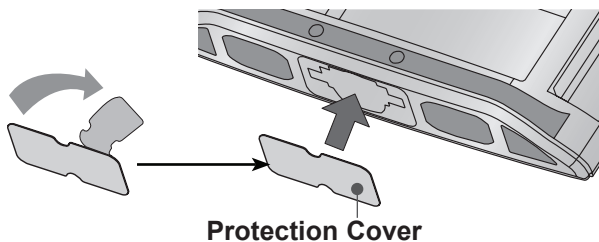

Only 26/32LD3**, 32/37/42/47LD4**,
32/42/46/52/60LD5**, 32/37/42/47/55LD6**

Insert the **Protection cover** into the TV until clicking sound.

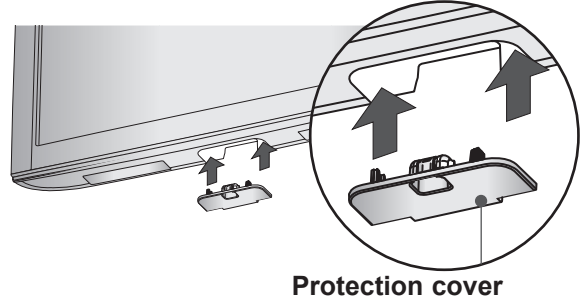

SWIVEL STAND

(Except for 22LD3**, 22/26LE6***)

■ Image shown may differ from your TV.
After installing the TV, you can adjust the TV set manually to the left or right direction by 20 degrees to suit your viewing position.

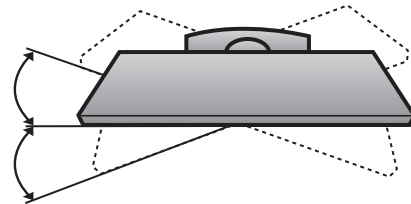

POSITIONING YOUR DISPLAY

(Only 22LD3**)

■ Image shown may differ from your TV.
Adjust the position of the panel in various ways for maximum comfort.

- Tilt range

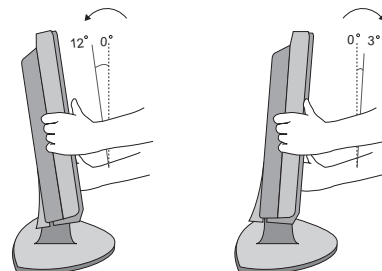

CONNECTION OF TV

(Only 22/26LE5***, 22/26LE6***, 26LE3***)

- Image shown may differ from your TV.

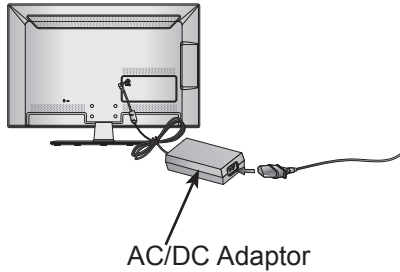

- 1 Connect the antenna cable to the antenna input port on the TV.
- 2 Connect the AC/DC adapter plug to the power input jack on the TV.
- 3 Connect the power cord to the AC/DC adapter first, then plug the power cord into the wall power outlet.

⚠ CAUTION

- ▶ Please be sure to connect the TV to the DC power adapter before connecting the TV's power plug to a wall power outlet.

< Only 26LE5***, 26LE3*** >

- Image shown may differ from your TV.

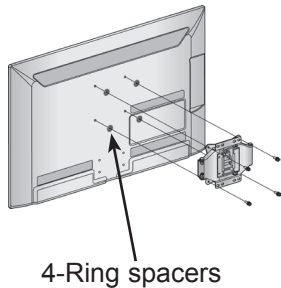

Place the ring spacers on the set before installing the wall mounting bracket so that the inclination of the backside of the set can be adjusted perpendicularly.

KENSINGTON SECURITY SYSTEM

- This feature is not available for all models.
- Image shown may differ from your TV.

The TV is equipped with a Kensington Security System connector on the back panel. Connect the Kensington Security System cable as shown below.

For the detailed installation and use of the Kensington Security System, refer to the user's guide provided with the Kensington Security System.

For further information, contact <http://www.kensington.com>, the internet homepage of the Kensington

company. Kensington sells security systems for expensive electronic equipment such as notebook PCs and LCD projectors.

! NOTE

- ▶ The Kensington Security System is an optional accessory.
- ▶ If the TV feels cold to the touch, there may be a small "flicker" when it is turned on.
- ▶ Some minute dot defects may be visible on the screen, appearing as tiny red, green, or blue spots. However, they have no adverse effect on the monitor's performance.
- ▶ Avoid touching the LCD screen or holding your finger(s) against it for long periods of time. Doing so may produce some temporary distortion effects on the screen.

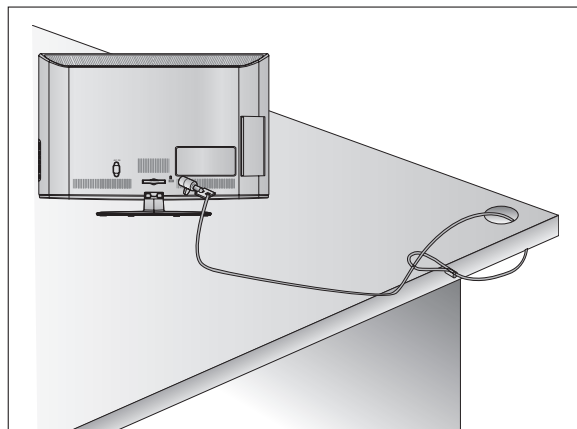

PREPARATION

CAREFUL INSTALLATION ADVICE

- You should purchase necessary components to fix the TV safely and secure to the wall on the market.
- Position the TV close to the wall to avoid the possibility of it falling when pushed.
- The instructions shown below are a safer way to set up the TV, by fixing it to the wall, avoiding the possibility of it falling forwards if pulled. This will prevent the TV from falling forward and causing injury. This will also prevent the TV from damage. Ensure that children do not climb or hang from the TV.

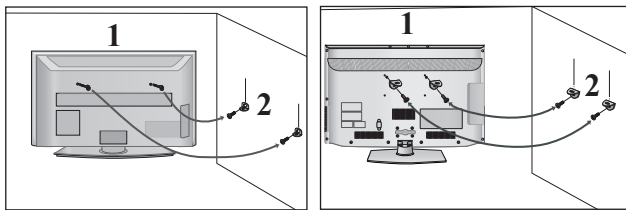

- 1 Use the eye-bolts or TV brackets/bolts to fix the product to the wall as shown in the picture. (If your TV has bolts in the eye-bolts, loosen them bolts.)
* Insert the eye-bolts or TV brackets/bolts and tighten them securely in the upper holes.

- 2 Secure the wall brackets with the bolts on the wall. Match the height of the bracket that is mounted on the wall.

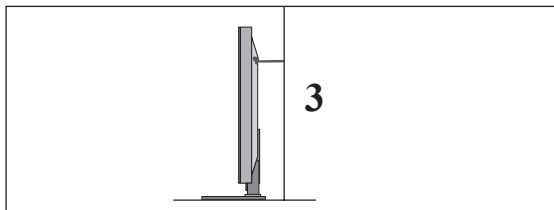

- 3 Use a sturdy rope to tie the product for alignment. It is safer to tie the rope so it becomes horizontal between the wall and the product.

NOTE

- ▶ When moving the TV undo the cords first.
- ▶ Use a platform or cabinet strong and large enough to support the size and weight of the TV.
- ▶ To use the TV safely make sure that the height of the bracket on the wall and on the TV is the same.

- The TV can be installed in various ways such as on a wall, or on a desktop etc.
- The TV is designed to be mounted horizontally.

EARTHING

Ensure that you connect the earth wire to prevent possible electric shock. If grounding methods are not possible, have a qualified electrician install a separate circuit breaker.

Do not try to earth the TV by connecting it to telephone wires, lightning rods or gas pipes.

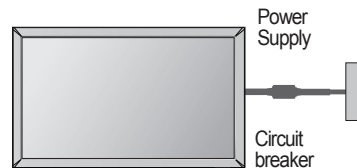

DESKTOP PEDESTAL INSTALLATION

For adequate ventilation allow a clearance of 10 cm all around the TV.

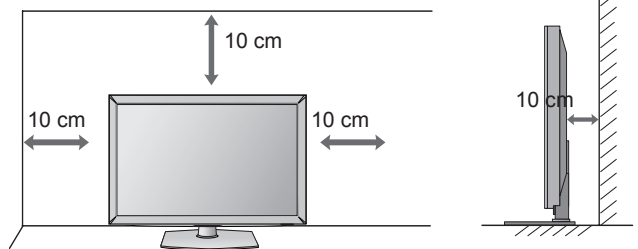

WALL MOUNT: HORIZONTAL INSTALLATION

- We recommend the use of a LG Brand wall mounting bracket when mounting the TV to a wall.
- We recommend that you purchase a wall mounting bracket which supports VESA standard.
- LG recommends that wall mounting be performed by a qualified professional installer.

NOTE

- ▶ Should Install wall mount on a solid wall perpendicular to the floor.
- ▶ Should use a special wall mount, if you want to install it to ceiling or slanted wall.
- ▶ The surface that wall mount is to be mounted on should be of sufficient strength to support the weight of TV set; e.g. concrete, natural rock, brick and hollow block.
- ▶ Installing screw type and length depends on the wall mount used. Further information, refer to the instructions included with the mount.
- ▶ LG is not liable for any accidents or damage to property or TV due to incorrect installation:
 - Where a non-compliant VESA wall mount is used.
 - Incorrect fastening of screws to surface which may cause TV to fall and cause personal injury.
 - Not following the recommended Installation method.

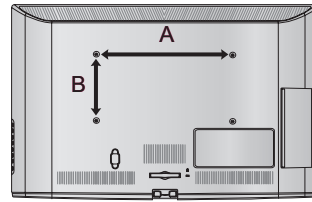

Model	VESA (A * B)	Standard Screw	Quantity
22LD3**, 22/26LE5***, 22/26LE6***, 26LE3***	100 * 100	M4	4
26/32LD3**, 32LD4**, 32LD5**, 32LD6**, 32LE5**, 32LE7**, 32LE4**, 32LE3**	200 * 100	M4	4
37/42/47LD4**, 42/46LD5**, 37/42/47LD6**, 37/42/47LE5***, 37/42/47LE7***, 42/47LE8**, 42/47LX6**, 47LX9**, 42/47LE4**	200 * 200	M6	4
52/60LD5**, 55LD6**, 55LE5**, 55LE7**, 55LE8**, 55LX6**, 55LX9**, 55LE4**	400 * 400	M6	4

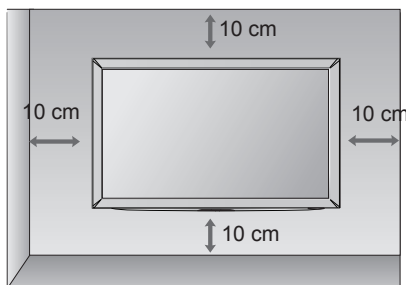

< Only 32/42/47/55LE46** >

- Image shown may differ from your TV.

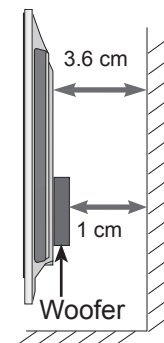

The clearance from the wall is 3.6 cm for this product.

PREPARATION

REMOTE CONTROL KEY FUNCTIONS

22/26/32LD3**, 32/37/42/47LD4**, 32/42/46/52/60LD5*, 22/26/32/37/42/47/55LE53**, 22/26LE6***, 32/42/47/55LE46**(Except for India), 32/42LE45**, 26/32LE3***

When using the remote control, aim it at the remote control sensor on the TV.
In Analogue TV and some countries, some remote control keys may not work.

■ Image shown may differ from your TV.



- ⏻ (POWER)** Switches the TV on from standby or off to standby.
 - ENERGY SAVING** Adjust the Energy Saving mode of the TV.(▶ p.119)
 - AV MODE** It helps you select and set images and sounds when connecting AV devices.(▶ p.55)
 - INPUT** External input mode rotate in regular sequence.(▶ p.49)
 - TV/RAD** Selects Radio, TV and DTV channel.
-
- 0~9 number button** Selects a programme.
Selects numbered items in a menu.
 - LIST** Displays the programme table. (▶ p.47)
 - Q.VIEW** Returns to the previously viewed programme.
-
- MENU** Selects a menu.
Clears all on-screen displays and returns to TV viewing from any menu.(▶ p.28)
 - GUIDE** Shows programme guide. (▶ p.109)
 - Q. MENU** Select the desired quick menu source. (▶ p.27)
 - THUMBSTICK (Up/Down/Left/Right)** Allows you to navigate the on-screen menus and adjust the system settings to your preference.
 - OK** Accepts your selection or displays the current mode.
 - BACK** Allows the user to move return one step in an interactive application or other user interaction function.
 - INFO ⓘ** Shows the present screen information.
 - EXIT** Clears all on-screen displays and returns to TV viewing from any menu.
-
- Coloured buttons** These buttons are used for teletext (on **TELETEXT** models only), **Programme edit**.
-
- 1 TELETEXT BUTTONS** These buttons are used for teletext. For further details, see the 'Teletext' section.(▶ p.155)
 - SUBTITLE** Recalls your preferred subtitle in digital mode.



VOLUME UP /DOWN Adjusts the volume.

MARK Select the input to apply the Picture Wizard settings.
Mark and un-Mark programmes in the USB menu.

FAV Displays the selected favourite programme.

RATIO Selects your desired Aspect Ratio of picture. (▶ p.116)

MUTE Switches the sound on or off.

Programme UP/DOWN Selects a programme.

PAGE UP/ DOWN Move from one full set of screen information to the next one.

SIMPLINK / MY MEDIA Menu control buttons Controls SIMPLINK or MY MEDIA menu.

SIMPLINK See a list of AV devices connected to TV. When you toggle this button, the Simplink menu appears at the screen.(▶ p.52)

AD Switches the Audio Description On or Off. (Except for 22/26/32LD3**, 32/37/42/47LD4**, 22/26LE53**, 22/26LE6***, 26LE3***)

Installing Batteries

- Open the battery compartment cover on the back and install the batteries matching correct polarity (+with +,-with -).
- Install two 1.5 V AAA batteries. Do not mix old or used batteries with new ones.
- Close cover.
- To remove the batteries, perform the installation actions in reverse.

PREPARATION

REMOTE CONTROL KEY FUNCTIONS

32/42/47LE46**(Only India)

When using the remote control, aim it at the remote control sensor on the TV.
In Analogue TV and some countries, some remote control keys may not work.

- Image shown may differ from your TV.

PREPARATION

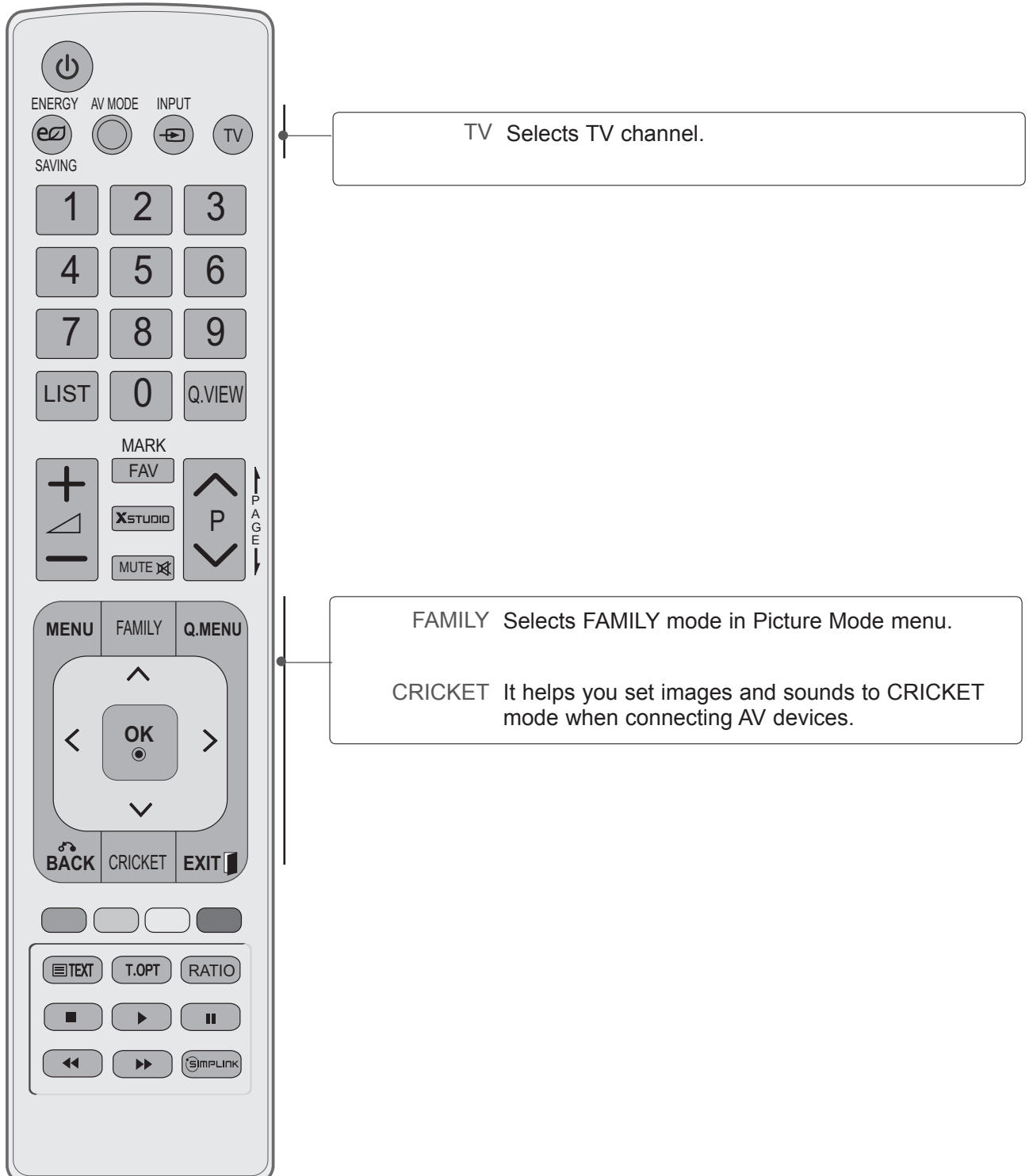

REMOTE CONTROL KEY FUNCTIONS

32/42/52LD56*, 32/37/42/47/55LD6**, 32/37/42/47/55LE55**, 32/37/42/47/55LE7***, 42/47/55LE8***

When using the remote control, aim it at the remote control sensor on the TV.
In Analogue TV and some countries, some remote control keys may not work.

■ Image shown may differ from your TV.

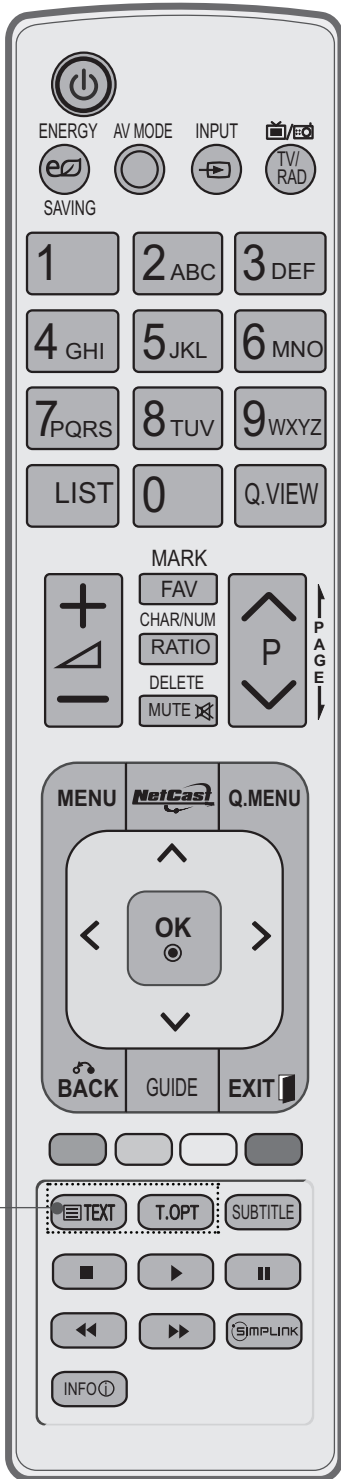

⏻ (POWER) Switches the TV on from standby or off to standby.

ENERGY SAVING Adjust the Energy Saving mode of the TV.(▶ p.119)

AV MODE It helps you select and set images and sounds when connecting AV devices.(▶ p.55)

INPUT External input mode rotate in regular sequence.(▶ p.49)

TV/RAD Selects Radio, TV and DTV channel.

0~9 number button Selects a programme.
Selects numbered items in a menu.

LIST Displays the programme table. (▶ p.47)

Q.VIEW Returns to the previously viewed programme.

MENU Selects a menu.
Clears all on-screen displays and returns to TV viewing from any menu.(▶ p.28)

NETCAST Select the desired NetCast menu source. (▶ p.57)
(Weather info, Photo Album, Movie Online and etc.) NetCast menu source can differ by country.

Q. MENU Select the desired quick menu source. (▶ p.27)

THUMBSTICK (Up/Down/Left/Right) Allows you to navigate the on-screen menus and adjust the system settings to your preference.

OK Accepts your selection or displays the current mode.

BACK Allows the user to move return one step in an interactive application or other user interaction function.

GUIDE Shows programme guide. (▶ p.109)

EXIT Clears all on-screen displays and returns to TV viewing from any menu.

Coloured buttons These buttons are used for teletext (on **TELETEXT** models only), **Programme edit**.

1 TELETEXT BUTTONS These buttons are used for teletext.
For further details, see the 'Teletext' section.(▶ p.155)

SUBTITLE Recalls your preferred subtitle in digital mode.

PREPARATION

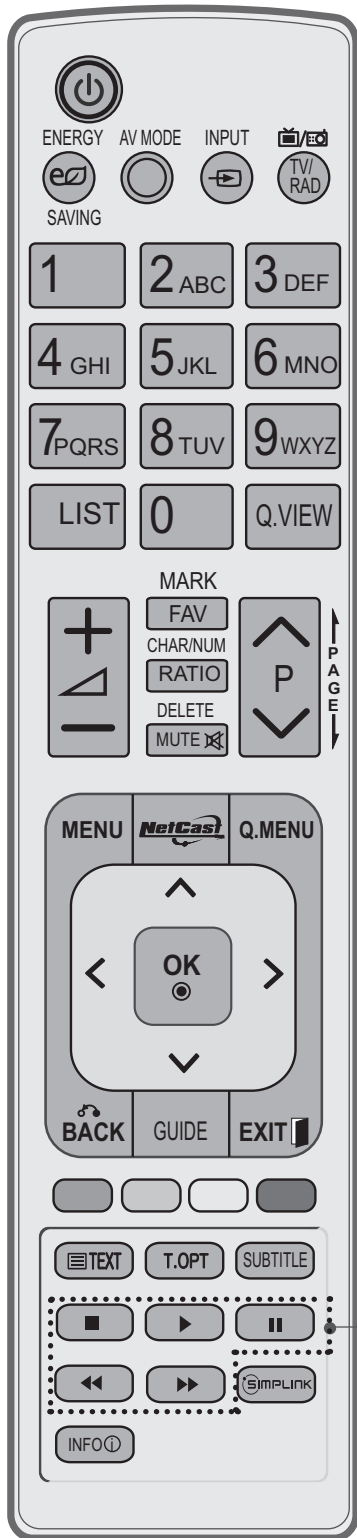

VOLUME UP /DOWN Adjusts the volume.

MARK Select the input to apply the Picture Wizard settings.
Mark and un-Mark programmes in the USB menu.

FAV Displays the selected favourite programme.

CHAR/NUM Shifts the Character or Number for NetCast menu.

RATIO Selects your desired Aspect Ratio of picture.
(▶ p.116)

MUTE Switches the sound on or off.

DELETE Deletes the entered character when entering the character on the screen keyboard.

Programme UP/DOWN Selects a programme.

PAGE UP/ DOWN Move from one full set of screen information to the next one.

SIMPLINK / MY MEDIA Menu control buttons Controls SIMPLINK or MY MEDIA menu.

SIMPLINK See a list of AV devices connected to TV. When you toggle this button, the Simplink menu appears at the screen.(▶ p.52)

INFO ⓘ Shows the present screen information.

Installing Batteries

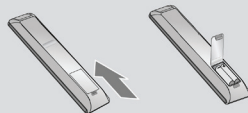

- Open the battery compartment cover on the back and install the batteries matching correct polarity (+with +,-with -).
- Install two 1.5 V AAA batteries. Do not mix old or used batteries with new ones.
- Close cover.
- To remove the batteries, perform the installation actions in reverse.

REMOTE CONTROL KEY FUNCTIONS

42/47/55LX6***, 47/55LX9***

When using the remote control, aim it at the remote control sensor on the TV.
In Analogue TV and some countries, some remote control keys may not work.

■ Image shown may differ from your TV.

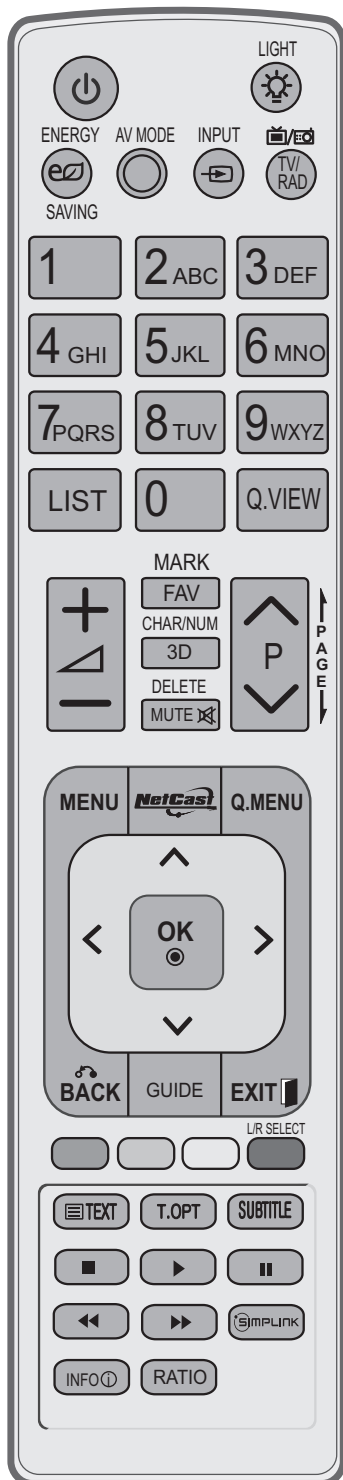

⏻ (POWER) Switches the TV on from standby or off to standby.

LIGHT You can turn the light of the remote control button on or off. (Only 47/55LX9***)

ENERGY SAVING Adjust the Energy Saving mode of the TV. (▶ p.119)

AV MODE It helps you select and set images and sounds when connecting AV devices. (▶ p.55)

INPUT External input mode rotate in regular sequence. (▶ p.49)

TV/RAD Selects Radio, TV and DTV channel.

0~9 number button Selects a programme.
Selects numbered items in a menu.

LIST Displays the programme table. (▶ p.47)

Q.VIEW Returns to the previously viewed programme.

MENU Selects a menu.
Clears all on-screen displays and returns to TV viewing from any menu. (▶ p.28)

NETCAST Select the desired NetCast menu source. (▶ p.57)
(Weather info, Photo Album, Movie Online and etc.) NetCast menu source can differ by country.

Q. MENU Select the desired quick menu source. (▶ p.27)

THUMBSTICK (Up/Down/Left/Right) Allows you to navigate the on-screen menus and adjust the system settings to your preference.

OK Accepts your selection or displays the current mode.

BACK Allows the user to move return one step in an interactive application or other user interaction function.

GUIDE Shows programme guide. (▶ p.109)

EXIT Clears all on-screen displays and returns to TV viewing from any menu.

Coloured buttons These buttons are used for teletext (on **TELETEXT** models only), **Programme edit**.

L/R SELECT Use this to view the 3D video. (▶ p.72)

PREPARATION

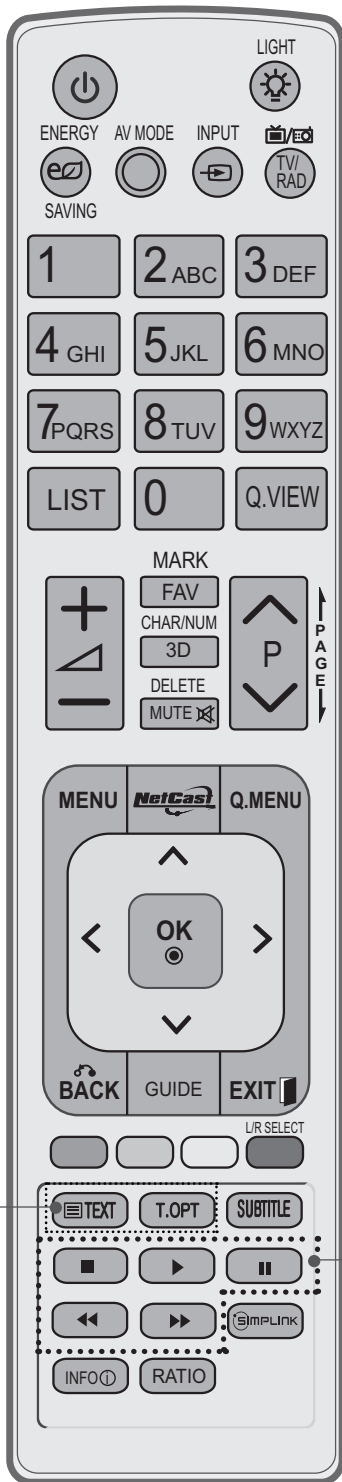

VOLUME UP /DOWN Adjusts the volume.

MARK Select the input to apply the Picture Wizard settings.
Check and un-check programmes in the USB menu.

FAV Displays the selected favourite programme.

CHAR/NUM Shifts the Character or Number for NetCast menu.

3D Use this to view the 3D video. (▶ p.72)

DELETE Deletes the entered character when entering the character on the screen keyboard.

MUTE Switches the sound on or off.

Programme UP/DOWN Selects a programme.

PAGE UP/ DOWN Move from one full set of screen information to the next one.

1 TELETEXT BUTTONS These buttons are used for teletext. For further details, see the 'Teletext' section.(▶ p.155)

SUBTITLE Recalls your preferred subtitle in digital mode.

SIMPLINK / MY MEDIA Menu control buttons Controls SIMPLINK or MY MEDIA menu.

SIMPLINK See a list of AV devices connected to TV. When you toggle this button, the Simplink menu appears at the screen.(▶ p.52)

INFO Shows the present screen information.

RATIO Selects your desired Aspect Ratio of picture. (▶ p.116)

Installing Batteries

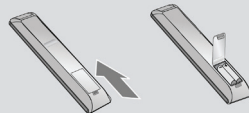

- Open the battery compartment cover on the back and install the batteries matching correct polarity (+with +,-with -).
- Install two 1.5 V AAA batteries. Do not mix old or used batteries with new ones.
- Close cover.
- To remove the batteries, perform the installation actions in reverse.

EXTERNAL EQUIPMENT SETUP

- To prevent damage do not connect to the mains outlet until all connections are made between the devices.

ANTENNA CONNECTION

- For optimum picture quality, adjust antenna direction.
- An antenna cable and converter are not supplied.

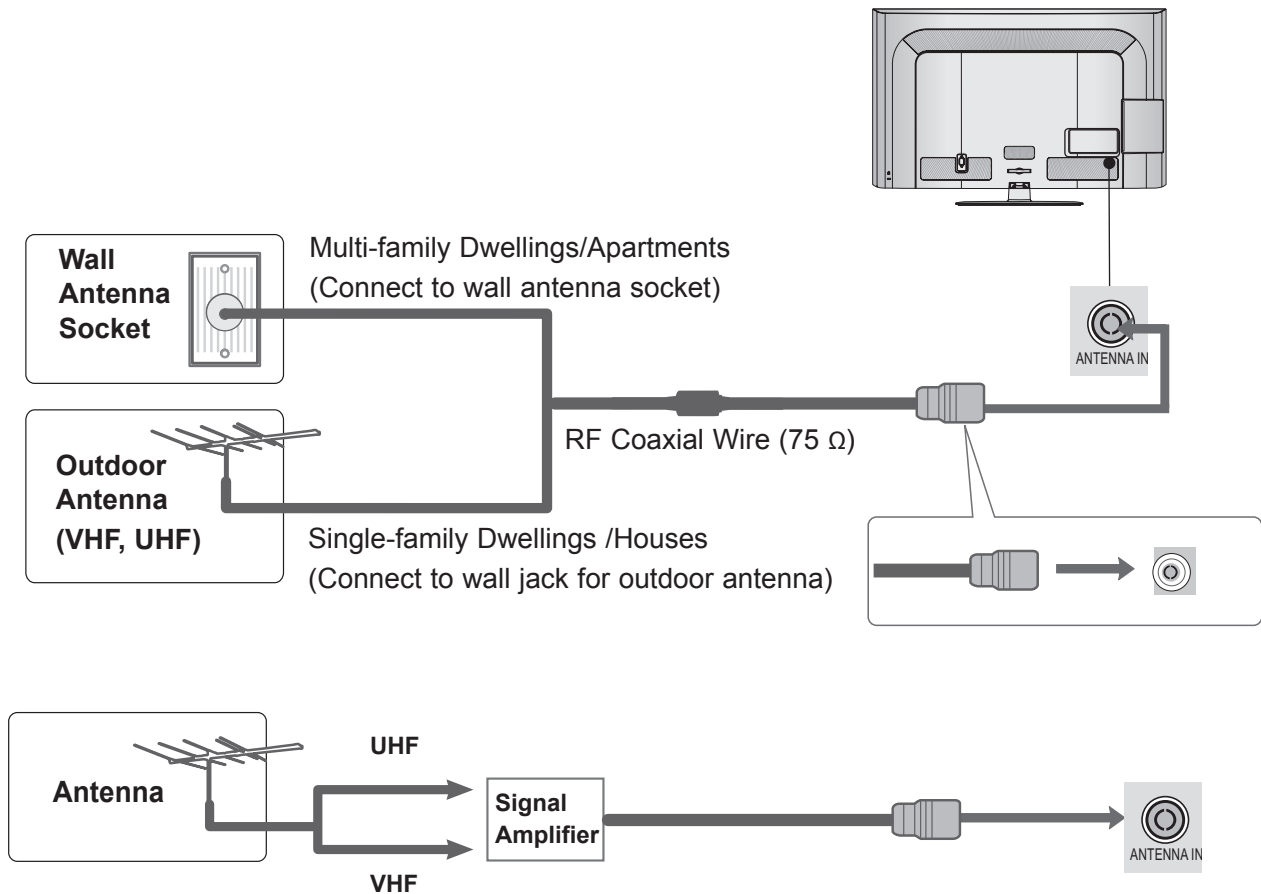

- In poor signal areas, to achieve better picture quality it may be necessary to install a signal amplifier to the antenna as shown above.
- If signal needs to be split for two TVs, use an antenna signal splitter for connection.

EXTERNAL EQUIPMENT SETUP

- To avoid damaging any equipment, never plug in any power cord until you have finished connecting all equipment.
- This section on **EXTERNAL EQUIPMENT SETUP** mainly uses diagrams for the 32/42/46/52/60LD55* models.
- Image shown may differ from your TV.

CONNECTING WITH A COMPONENT CABLE

- This TV can receive Digital RF/Cable signals without an external digital set-top box. However, if you do receive Digital signals from a digital set-top box or other digital external device, refer to the diagram as shown below.

- 1 Connect the video outputs (Y, P_B, P_R) of the external equipment (digital set-top box, DVD, etc.) to the **COMPONENT IN VIDEO** jacks on the TV.
- 2 Connect the audio output of the external equipment (digital set-top box, DVD, etc.) to the **COMPONENT IN AUDIO** jacks on the TV.
- 3 Turn on the external equipment.
(Refer to the external equipment's manual for operating instructions.)
- 4 Select the **Component1** input source using the **INPUT** button on the remote control.
If connected to **COMPONENT IN2** or **COMPONENT IN3**, select **Component2** or **Component3** input source.

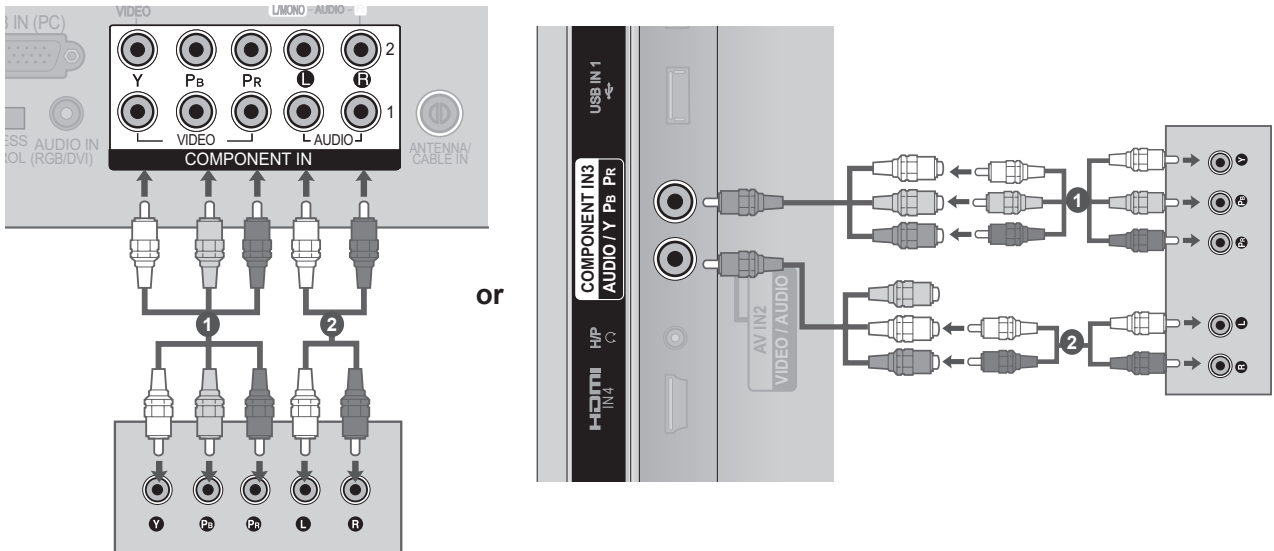

Component Input ports

To achieve better picture quality, connect a DVD player to the component input ports as shown below.

Component ports on the TV	Y	P _B	P _R
Video output ports on DVD player	Y	P _B	P _R
	Y	B-Y	R-Y
	Y	Cb	Cr
	Y	Pb	Pr

- ▶ HDMI Audio Supported format : Dolby Digital, PCM
DTS Audio format is not supported.

Signal	Component	HDMI
480i/576i	○	X
480p/576p	○	○
720p/1080i	○	○
1080p	○ (50 Hz / 60 Hz only)	○ (24 Hz / 30 Hz / 50 Hz / 60 Hz)

CONNECTING WITH AN HDMI CABLE

- 1 Connect the HDMI output of the external equipment (digital set-top box, DVD, etc.) to **HDMI/DVI IN 1**, **HDMI/DVI IN 2**(Except for 22LD3**), **HDMI IN 3**(Except for 22/26/32LD3**, 32/37/42/47LD4**, 22LE5***) or **HDMI IN 4** (Only 32/37/42/47/55LE5***, 32/37/42/47/55LE7***, 42/47/55LE8***, 42/47/55LX6***, 47/55LX9***, 32/42/47/55LE4***, 32LE3***) jack on the TV.
- 2 Turn on the external equipment.
(Refer to the external equipment's manual for operating instructions.)
- 3 Select **HDMI1**, **HDMI2**(Except for 22LD3**), **HDMI3**(Except for 22/26/32LD3**, 32/37/42/47LD4**, 22LE5***) or **HDMI4** (Only 32/37/42/47/55LE5***, 32/37/42/47/55LE7***, 42/47/55LE8***, 42/47/55LX6***, 47/55LX9***, 32/42/47/55LE4***, 32LE3***) input source using the **INPUT** button on the remote control.

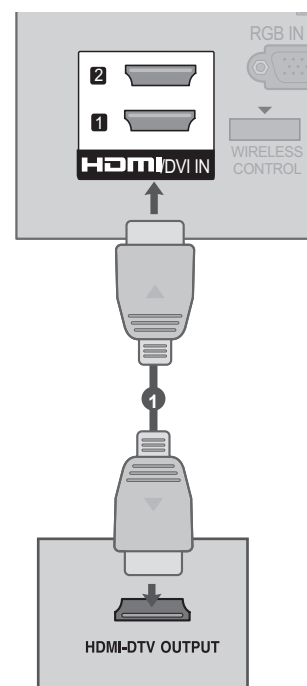

! NOTE

- ▶ The TV can receive video and audio signals simultaneously when using an HDMI cable.
- ▶ If the DVD does not support Auto HDMI, you must set the output resolution appropriately.
- ▶ Check that your HDMI cable is High Speed HDMI Cable. If the HDMI cables are not High Speed HDMI Cable, flickering or no screen display can result. Please use the High Speed HDMI Cable.
- ▶ The TV set can process audio format of PCM or Dolby Digital, when connect the external equipment using an HDMI cable.

EXTERNAL EQUIPMENT SETUP

CONNECTING WITH AN HDMI TO DVI CABLE

- 1 Connect the digital set-top box or the DVI output of the PC to **HDMI/DVI IN 1**, **HDMI/DVI IN 2** (Except for 22/26/32LD3**, 32/37/42/47LD4**), **HDMI/DVI IN 3** (Only 32/37/42/47/55LE5***, 32/37/42/47/55LE7***, 42/47/55LE8***, 42/47/55LX6***, 47/55LX9***, 32/42/47/55LE4***, 32LE3***) jack on the TV.
- 2 Connect the audio output of the digital set-top box or the PC audio output to the **AUDIO IN (RGB/DVI)** jack on the TV.
- 3 Turn on the digital set-top box or the PC and the TV.
(Refer to the digital set-top box or the PC manual for operating instructions.)
- 4 Select **HDMI1**, **HDMI2** (Except for 22/26/32LD3**, 32/37/42/47LD4**), **HDMI3** (Only 32/37/42/47/55LE5***, 32/37/42/47/55LE7***, 42/47/55LE8***, 42/47/55LX6***, 47/55LX9***, 32/42/47/55LE4***, 32LE3***) input source using the **INPUT** button on the remote control.

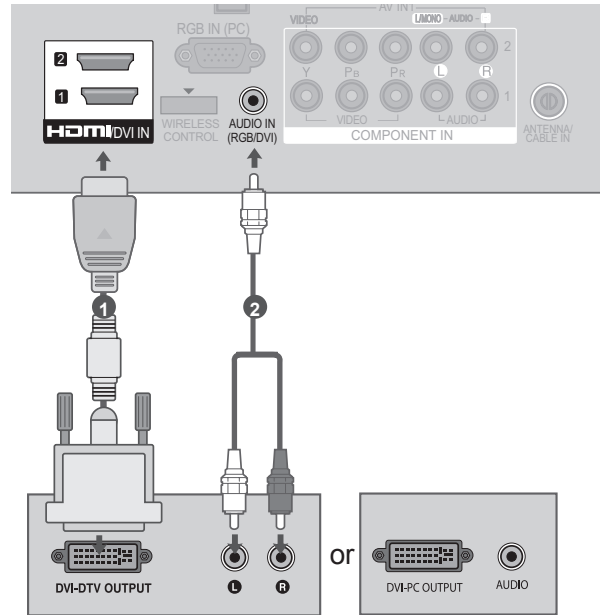

CONNECTING WITH AN RCA CABLE

- 1 Connect the **AUDIO/VIDEO** jacks between TV and VCR or external equipment.
- 2 Insert a video tape into the VCR and press **PLAY** on the VCR. (Refer to the VCR owner's manual.)
Or, Operate the corresponding external equipment.
(Refer to external equipment operating guide.)
- 3 Select **AV1** input source using the **INPUT** button on the remote control.
If connected to **AV2** input, select **AV2** input source.

NOTE

▶ If you have a mono VCR, connect the audio cable from the VCR to the **AUDIO L/MONO** jack of the TV.

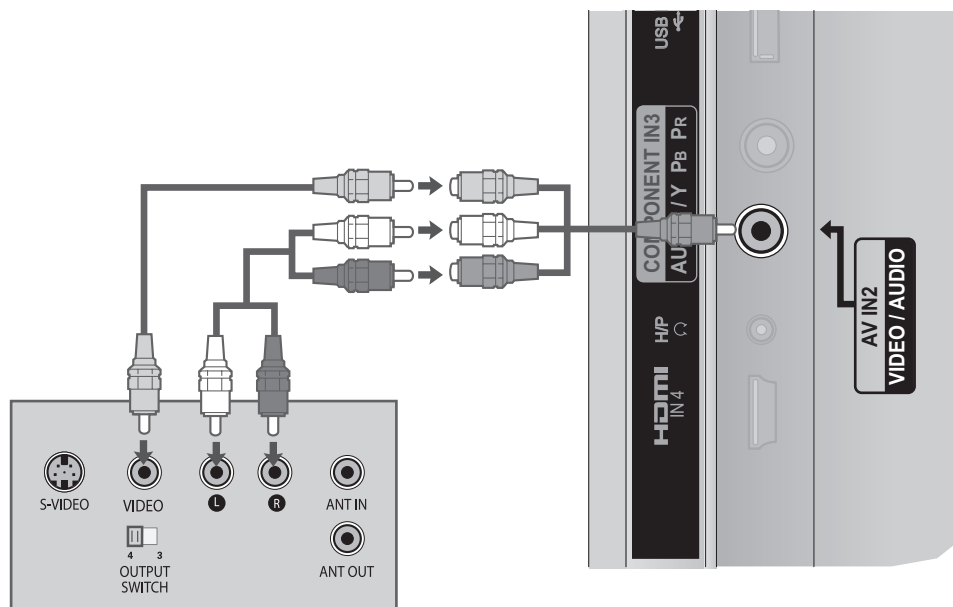
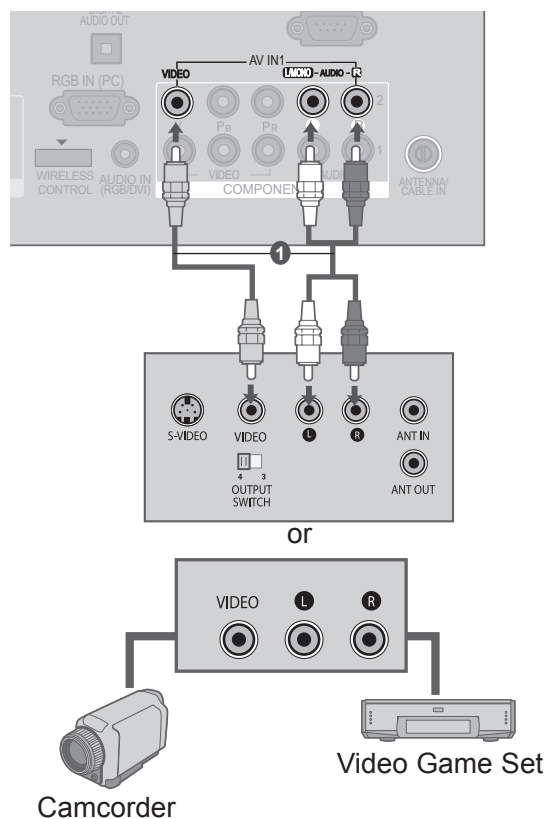

EXTERNAL EQUIPMENT SETUP

CONNECTING WITH AN RF CABLE

- To avoid picture noise (interference), allow adequate distance between the VCR and TV.

- 1 Connect the **ANT OUT** socket of the VCR to the **ANTENNA / CABLE IN** socket on the TV.
- 2 Connect the antenna cable to the **ANT IN** socket of the VCR.
- 3 Press the **PLAY** button on the VCR and match the appropriate channel between the TV and VCR for viewing.

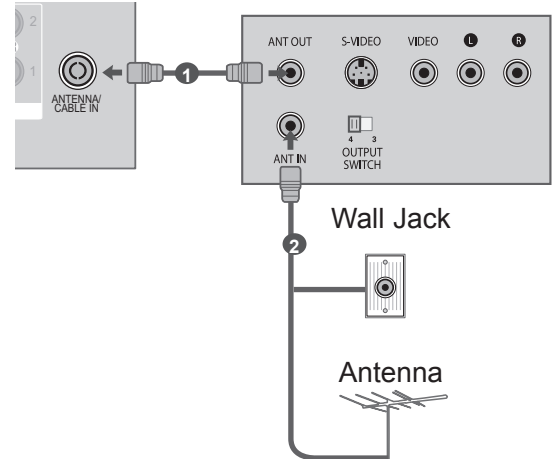

HEADPHONE SETUP

You can listen the sound through the headphone.

- 1 Plug the headphone into the headphone socket.
- 2 To adjust the headphone volume, press the \triangle + or - button. If you press the MUTE button, the sound from the headphone is switched off.

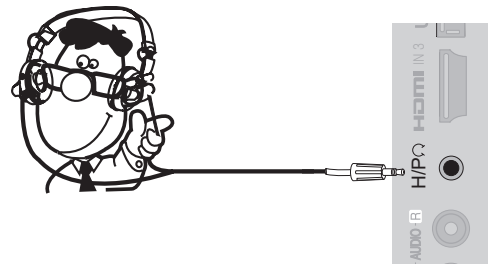

! NOTE

- ▶ AUDIO menu items are disabled when connecting a headphone. (Except for 32/37/42/47LD460C)
- ▶ When changing AV MODE with a headphone connected, the change is applied to video but not to audio. (Except for 32/37/42/47LD460C)
- ▶ Optical Digital Audio Out is not available when connecting a headphone. (Except for 32/37/42/47LD460C)
- ▶ Headphone impedance: 16 Ω
- ▶ Max audio output of headphone: 10 mW to 15 mW

DIGITAL AUDIO OUT SETUP

Sending the TV's audio signal to external audio equipment via the Digital Audio Output (Optical) port. If you want to enjoy digital broadcasting through 5.1-channel speakers, connect the OPTICAL DIGITAL AUDIO OUT terminal on the back of TV to a Home Theater (or amp).

- 1 Connect one end of an optical cable to the TV Digital Audio (Optical) Output port.
- 2 Connect the other end of the optical cable to the digital audio (Optical) input on the audio equipment.
- 3 Set the "TV Speaker option - Off" in the AUDIO menu. (▶ p.138). Refer to the external audio equipment instruction manual for operation.

⚠ CAUTION

- ▶ Do not look into the optical output port. Looking at the laser beam may damage your vision.

! NOTE

- ▶ When connecting with external audio equipments, such as amplifiers or speakers, please turn the TV speakers off.

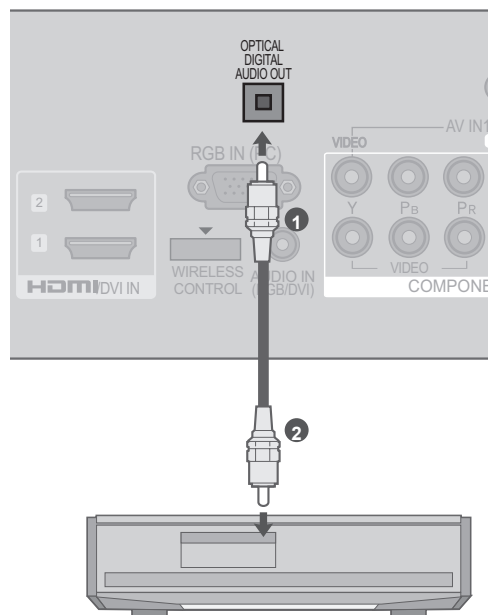

EXTERNAL EQUIPMENT SETUP

CONNECTING WITH A D-SUB 15 PIN CABLE

This TV provides Plug and Play capability, meaning that the PC adjusts automatically to the TV's settings.

- 1 Connect the RGB output of the PC to the **RGB IN (PC)** jack on the TV.
- 2 Connect the PC audio output to the **AUDIO IN (RGB/DVI)** jack on the TV.
- 3 Turn on the PC and the TV
- 4 Select **RGB** input source using the **INPUT** button on the remote control.

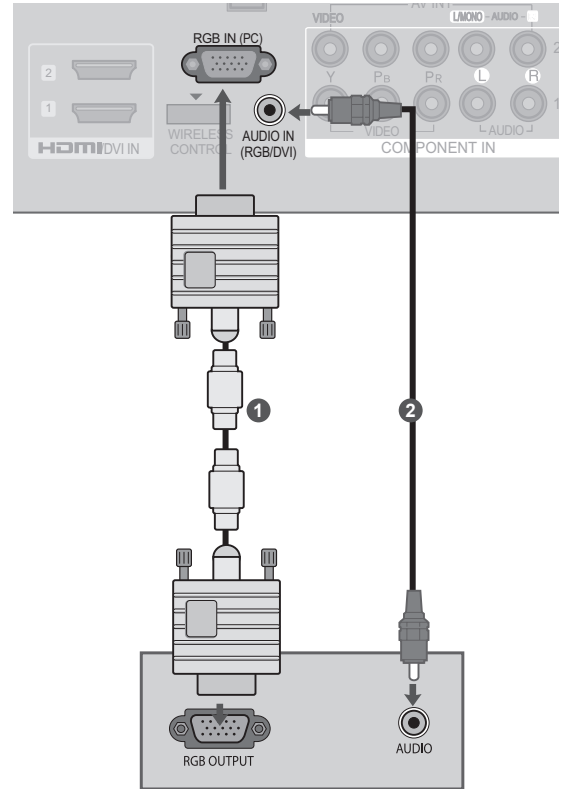

USB SETUP

(Except for 22/26/32LD3**)

- 1 Connect the USB device to the **USB IN 1** or **USB IN 2** jack on the TV.
- 2 After connecting the **USB IN 1** or **USB IN 2** jack, you use the **USB** function. (▶ p. 76)

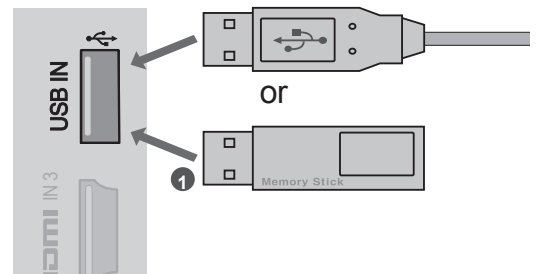

EXTERNAL EQUIPMENT WIRELESS CONNECTION

(Only 32/42/46/52/60LD5**, 32/37/42/47/55LD6**, 32/37/42/47/55LE53**, 32/37/42/47/55LE55**, 32/37/42/47/55LE7***, 42/47/55LE8***, 32/42LE45**, 42/47/55LX6***, 47/55LX9***, 32LE3***)

LG TVs with a Wireless Control port support the LG Wireless Media Box, which is sold separately. When you connect the Wireless Ready Dongle (included with the Wireless Media Box) to the TV, external devices can be connected to the LG Wireless Media Box and video and audio will be sent to the TV wirelessly.

After the wireless is connected, press the INPUT button to view the wireless input screen.

Refer to the Wireless Media Box manual for operating instructions.

LG Wireless Media Box

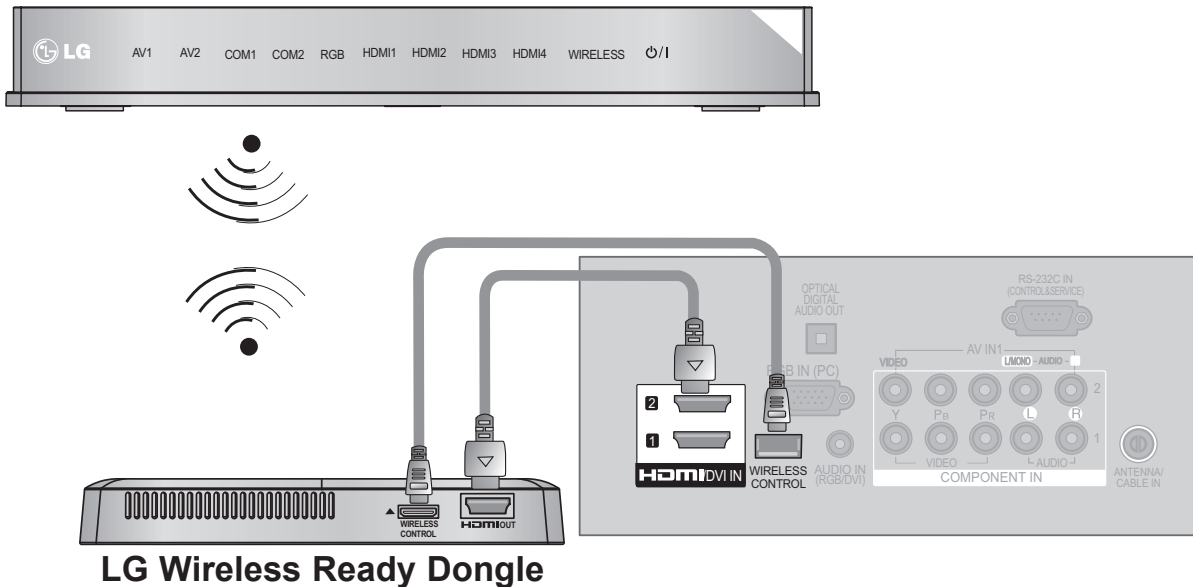

LG Wireless Ready Dongle

- 1 Connect the **WIRELESS CONTROL** jack of the **Wireless Ready Dongle** to the **WIRELESS CONTROL** jack on the TV.
- 2 Connect **HDMI OUT** jack of the Wireless Ready Dongle to the **HDMI/DVI IN 1**, **HDMI/DVI IN 2**, **HDMI IN 3** or **HDMI IN 4** (Only 32/37/42/47/55LE5***, 32/37/42/47/55LE7***, 42/47/55LE8***, 42/47/55LX6***, 47/55LX9***, 32/42LE45**, 32LE3***) jack on the TV.

NOTE

- ▶ **WIRELESS CONTROL** : Wireless Ready Dongle power supply and control usage.
- ▶ **HDMI** : Video/Audio signal is connected in Wireless Ready Dongle.
- ▶ When you connect to the Wireless Media Box (Separately sold product), you can watch the external device connected to the Wireless Media Box through wireless connection.
- ▶ In wireless external output, Real Cinema and Digital Noise Reduction functions are not supported.

EXTERNAL EQUIPMENT SETUP

SUPPORTED DISPLAY RESOLUTION

RGB-PC, HDMI-PC mode

Resolution	Horizontal Frequency(kHz)	Vertical Frequency(Hz)
720x400	31.468	70.08
640x480	31.469	59.94
800x600	37.879	60.31
1024x768	48.363	60.00
1280x768	47.78	59.87
1360x768	47.72	59.80
1280x1024	63.981	60.02
1920x1080 (RGB-PC)	66.587	59.93
1920x1080 (HDMI-PC)	67.5	60.00

(Except for 22/26/32LD3**, 22/26/32LE53**, 26/32LE3***)

HDMI-DTV mode

Resolution	Horizontal Frequency(kHz)	Vertical Frequency(Hz)
720x480	31.469	59.94
	31.5	60
720x576	31.25	50
	37.5	50
1280x720	44.96	59.94
	45	60
1920x1080	33.72	59.94
	33.75	60
	28.125	50
	26.97	23.97
	27	24
	33.716	29.976
	33.75	30.00
	56.25	50
	67.43	59.94
	67.5	60

! NOTE

- ▶ Avoid keeping a fixed image on the set's screen for prolonged periods of time. The fixed image may become permanently imprinted on the screen; use a screen saver when possible.
- ▶ There may be interference relating to resolution, vertical pattern, contrast or brightness in PC mode. Change the PC mode to another resolution or change the refresh rate to another rate or adjust the brightness and contrast on the menu until the picture is clear. If the refresh rate of the PC graphic card can not be changed, change the PC graphic card or consult the manufacturer of the PC graphic card.
- ▶ The synchronization input waveform for Horizontal and Vertical frequencies are separate.
- ▶ We recommend using 1920x1080, 60 Hz(Except for 22/26/32LD3**, 22/26/32LE53**, 26/32LE3***), 1360x768, 60 Hz(Only 22/26/32LD3**, 22/26/32LE53**, 26/32LE3***) for the PC mode, this should provide the best picture quality.
- ▶ Connect the signal cable from the monitor output port of the PC to the RGB (PC) port of the TV or the signal cable from the HDMI output port of the PC to the HDMI IN (or HDMI/DVI IN) port on the TV.
- ▶ Connect the audio cable from the PC to the Audio input on the TV. (Audio cables are not included with the TV).
- ▶ If using a sound card, adjust PC sound as required.
- ▶ If the graphic card on the PC does not output analogue and digital RGB simultaneously, connect only one of either RGB or HDMI IN (or HDMI/DVI IN) to display the PC output on the TV.
- ▶ If the graphic card on the PC does output analogue and digital RGB simultaneously, set the TV to either RGB or HDMI; (the other mode is set to Plug and Play automatically by the TV.)
- ▶ DOS mode may not work depending on the video card if you use an HDMI to DVI cable.
- ▶ If you use too long an RGB-PC cable, there may be interference on the screen. We recommend using under 5m of cable. This provides the best picture quality.

EXTERNAL EQUIPMENT SETUP







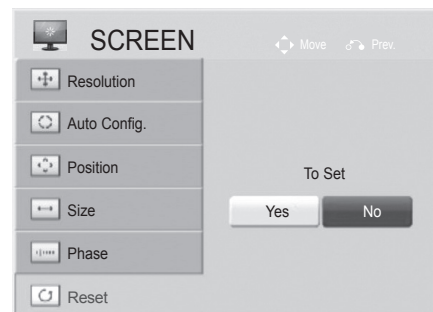
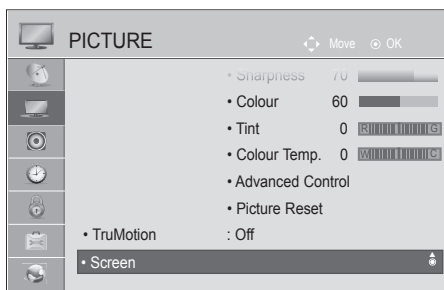

SCREEN SETUP FOR PC MODE

Screen Reset

Returns Position, Size and Phase to the factory default settings.

This function works in the following mode : RGB[PC].



-   Select **PICTURE**.
-   Select **Screen**.
-   Select **Reset**.
-   Select **Yes**.
-  Run **Reset**.

- Press the **MENU/EXIT** button to return to normal TV viewing.
- Press the **BACK** button to move to the previous menu screen.



Auto Configure (RGB [PC] mode only)

Automatically adjusts the picture position and minimizes image instability. After adjustment, if the image is still not correct, your TV is functioning properly but needs further adjustment.

Auto configure

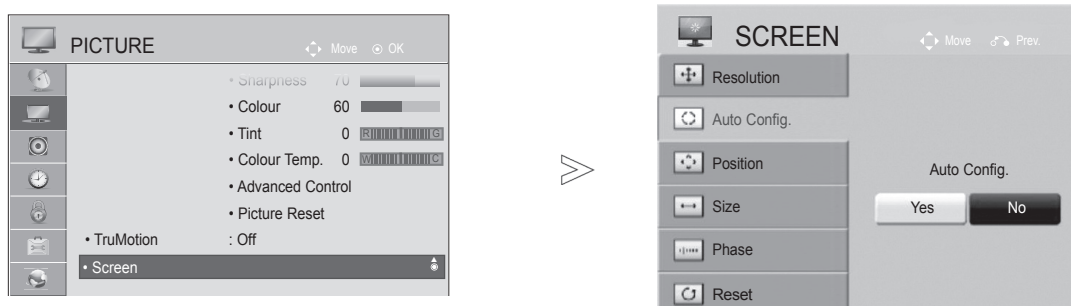
This function is for automatic adjustment of the screen position, size, and phase. The displayed image will be unstable for a few seconds while the auto configuration is in progress.



- 1   Select **PICTURE**.
- 2   Select **Screen**.
- 3   Select **Auto Config..**
- 4   Select **Yes**.
- 5  Run **Auto Config..**

- If the position of the image is still not correct, try Auto adjustment again.
- If picture needs to be adjusted again after Auto adjustment in RGB (PC), you can adjust the **Position**, **Size** or **Phase**.

- Press the **MENU/EXIT** button to return to normal TV viewing.
- Press the **BACK** button to move to the previous menu screen.







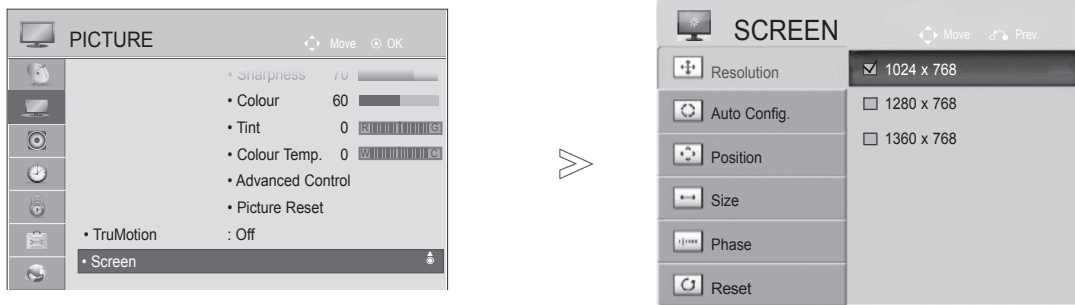

EXTERNAL EQUIPMENT SETUP

Selecting Resolution

To view a normal picture, match the resolution of RGB mode and selection of PC mode.

This function works in the following mode: RGB[PC]



- 1   Select **PICTURE**.
- 2   Select **Screen**.
- 3   Select **Resolution**.
- 4   Select the desired resolution.
- 5 









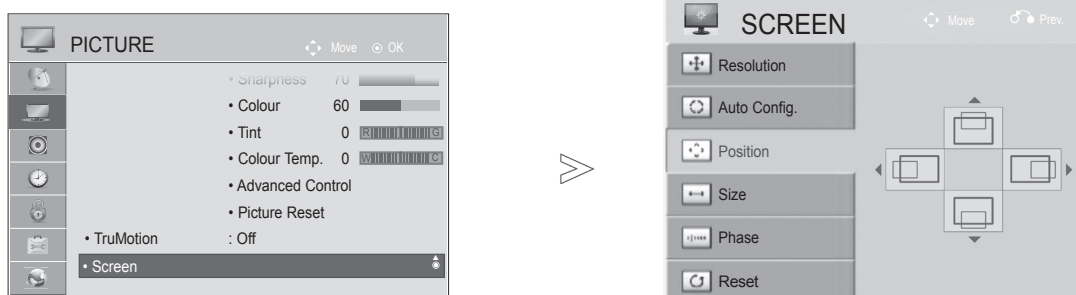

- Press the **MENU/EXIT** button to return to normal TV viewing.
- Press the **BACK** button to move to the previous menu screen.

Adjustment for screen Position, Size, Phase

If the picture is not clear after auto adjustment and especially if characters are still trembling, adjust the picture position manually.

This function works in the following mode : RGB[PC].



- 1   Select **PICTURE**.
- 2   Select **Screen**.
- 3   Select **Position, Size** or **Phase**.
- 4    Make appropriate adjustments.
- 5 

- Press the **MENU/EXIT** button to return to normal TV viewing.
- Press the **BACK** button to move to the previous menu screen.

EXTERNAL EQUIPMENT SETUP

This feature is not available in all countries.

NETWORK SETUP

(Only 32/42/52LD56*, 32/37/42/47/55LD6**, 32/37/42/47/55LE55**, 32/37/42/47/55LE7***, 42/47/55LE8***, 42/47/55LX6***, 47/55LX9***)

Wired Network Connection

This TV can be connected to a local area network (LAN) via the LAN port. After making the physical connection, the TV needs to be set up for network communication.

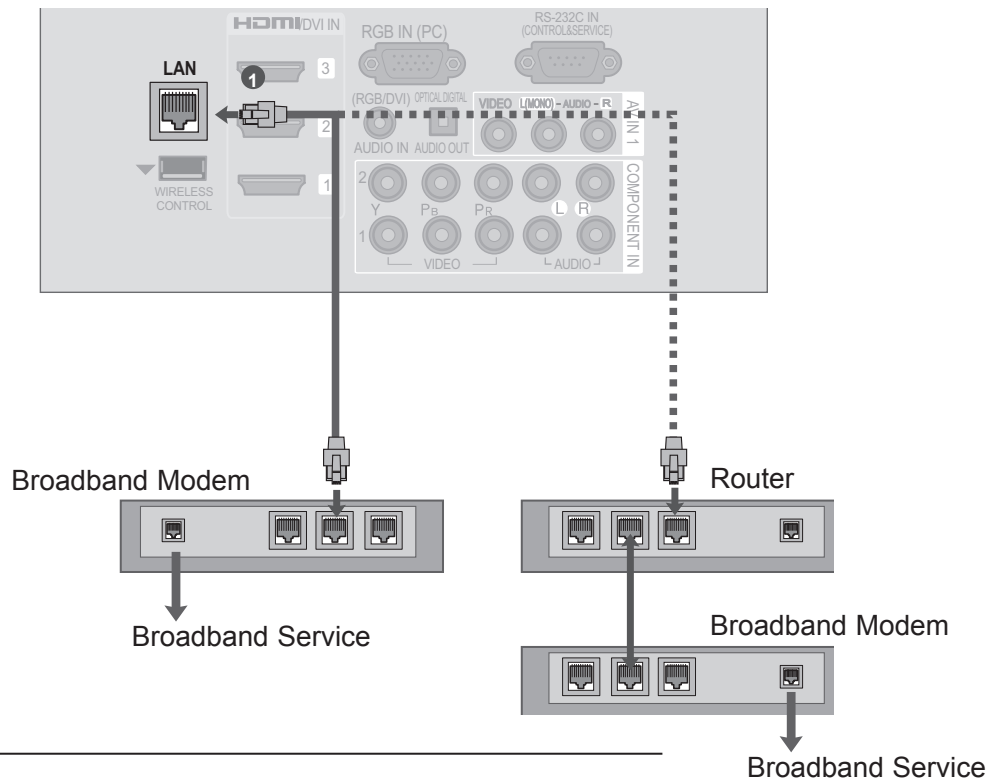

- 1 Connect the LAN port of the Modem or Router to the LAN port on the TV.
- 2 Select "**Network Setting**" in the **NETWORK** menu.
- 3 After connecting the **LAN** port, use the **NetCast** menu. For more information about NETCAST setup and troubleshooting, visit <http://lgknowledgebase.com>. Search for **NetCast**.

⚠ CAUTION

- ▶ Do not connect a modular phone cable to the LAN port.
- ▶ Since there are various connection methods, please follow the specifications of your telecommunication carrier or internet service provider.

Wired Network Setup

If wired and wireless networks are both available, wired is the preferred method.

After making a physical connection, a small number of home networks may require the TV network settings to be adjusted.

For detail information, contact your internet provider or router manual.

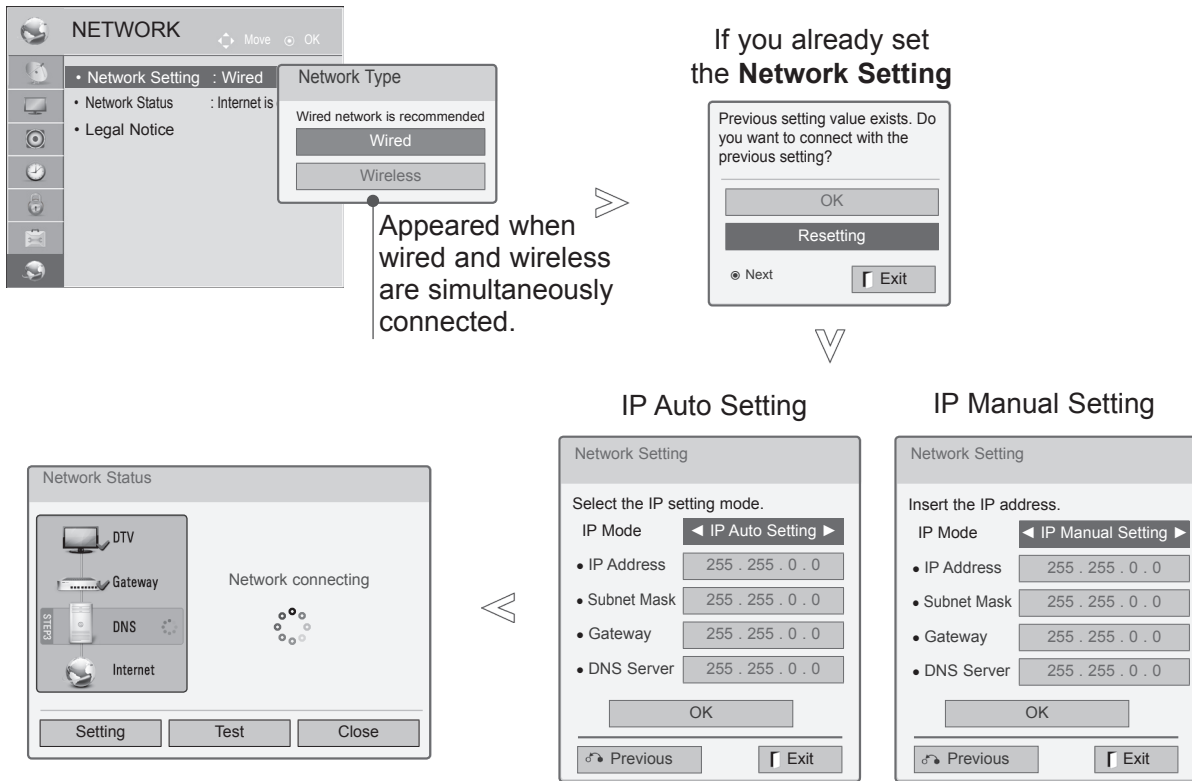

1. Select **NETWORK**.
2. Select **Network Setting**.
3. Select **Wired**.
4. If you already set Network Setting: Select **Resetting**. The new connection settings resets the current network settings.
5. Select **IP Auto Setting** or **IP Manual Setting**.
- When Selecting **IP Manual Setting**:
IP addresses will need to be input manually.
6. Select **OK**.

EXTERNAL EQUIPMENT SETUP

- This feature requires an always-on broadband internet connection.
- You do not need to connect to a PC to use this function.
- If **Network Setting** is not working, check your network conditions. Check the LAN cable and make sure your router has DHCP turned on if you wish to use the Auto Setting.
- If the **Network Setting** is not completed, network may not operate normally.
- **IP Auto Setting**: Select it if there is a DHCP server on the local area network (LAN) via wired connection, the TV will automatically be allocated an IP address. If you're using a broadband router or broadband modem that has a DHCP (Dynamic Host Configuration Protocol) server function. The IP address will automatically be determined.
- **IP Manual Setting**: Select it if there is no DHCP server on the network and you want to set the IP address manually.

! NOTE

- ▶ For more information about NetCast setup and troubleshooting, visit <http://lgknowledgebase.com>. Search for NetCast.
- ▶ Use a standard LAN cable with this TV. Cat5 or better with a RJ45 connector.
- ▶ Many network connection problems during set up can often be fixed by re-setting the router or modem. After connecting the player to the home network, quickly power off and/or disconnect the power cable of the home network router or cable modem. Then power on and/or connect the power cable again.
- ▶ Depending on the internet service provider (ISP), the number of devices that can receive internet service may be limited by the applicable terms of service. For details, contact your ISP.
- ▶ LG is not responsible for any malfunction of the TV and/or the internet connection feature due to communication errors/malfunctions associated with your broadband internet connection, or other connected equipment.
- ▶ LG is not responsible for problems within your internet connection.
- ▶ Some content available through the network connection may not be compatible with the TV. If you have questions about such content, please contact the producer of the content.
- ▶ You may experience undesired results if the network connection speed does not meet the requirements of the content being accessed.
- ▶ Some internet connection operations may not be possible due to certain restrictions set by the Internet service provider (ISP) supplying your broadband Internet connection.
- ▶ Any fees charged by an ISP including, without limitation, connection charges are your responsibility.
- ▶ A 10 Base-T or 100 Base-TX LAN port is required for connection to this TV. If your internet service does not allow for such a connection, you will not be able to connect the TV.
- ▶ A DSL modem is required to use DSL service and a cable modem is required to use cable modem service. Depending on the access method of and subscriber agreement with your ISP, you may not be able to use the internet connection feature contained in this TV or you may be limited to the number of devices you can connect at the same time. (If your ISP limits sub-scription to one device, this TV may not be allowed to connect when a PC is already connected.)
- ▶ The use of a "Router" may not be allowed or its usage may be limited depending on the policies and restrictions of your ISP. For details, contact your ISP directly.
- ▶ The wireless network operates at 2.4 GHz radio frequencies that are also used by other household devices such as cordless telephone, Bluetooth® devices, microwave oven, and can be affected by interference from them. It can be interrupted by the device using 5 Ghz radio frequencies. It is same device with LG wireless media box, cordless telephone, other Wi-Fi device.
- ▶ It may decrease the service speed using Wireless network by surrounding wireless condition.
- ▶ Turn off all unused network equipment in your local home network. Some devices may generate network traffic.
- ▶ In some instances, placing the access point or wireless router higher up away from the floor may improve the reception.
- ▶ The reception quality over wireless depends on many factors such as type of the access point, distance between the TV and access point, and the location of the TV.
- ▶ When connecting internet through the wired/wireless sharing machine, it may interrupt the connection because of the use limitation and confirmation of service company.
- ▶ To connect wireless AP, an AP that supports the wireless connection is necessary, and the wireless connection function of the AP needs to be activated. Please enquire to the AP supplier for the possibility of AP wireless connections.
- ▶ Please verify the security settings of AP SSID for wireless AP connection, and enquire to the AP supplier for the AP SSID security settings.
- ▶ The TV can become slower or malfunction with wrong settings of network equipments (wired/wireless router, hub, etc). Please install correctly by referring to the manual of the equipment, and set the network.
- ▶ When AP is set to include 802.11 n, and if Encryption is designated as WEP(64/128bit) or WPA(TKIP/AES), the connection may not be possible. There may be different connection methods according to the AP manufacturers.

EXTERNAL EQUIPMENT SETUP

Wireless Network Connection

The LG Wireless LAN for Broadband/DLNA Adaptor, allows the TV to connect to a wireless lan network.

The network configuration and connection method may vary depending on the equipment in use and the network environment. Refer to the setup instructions supplied with your access point or wireless router for detailed connection steps and network settings.

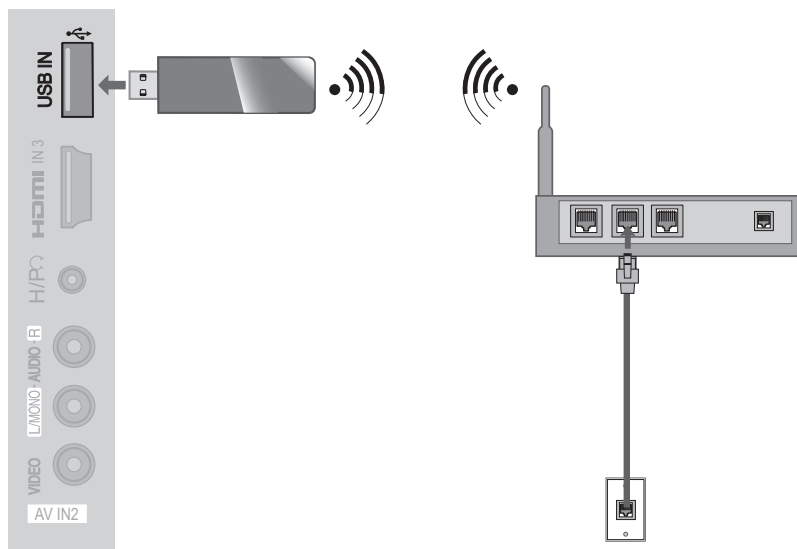

- 1 Connect the “LG **Wireless LAN for Broadband/DLNA Adaptor**” to the **USB IN 1** or **USB IN 2** jack on the TV.
- 2 Select “**Network Setting**” in the **NETWORK** menu.
After connecting, you can use the **NetCast** menu.

! NOTE

- ▶ For enjoying pictures, music, or video stored in the PC using the router, the use of wired port in the router is recommended.
- ▶ When the wireless port of the router is used, there may be restrictions for some functions.

Wireless Network Setup

Setting up the AP (Access Point) or the wireless router is required before connecting the TV to the network.

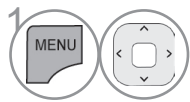
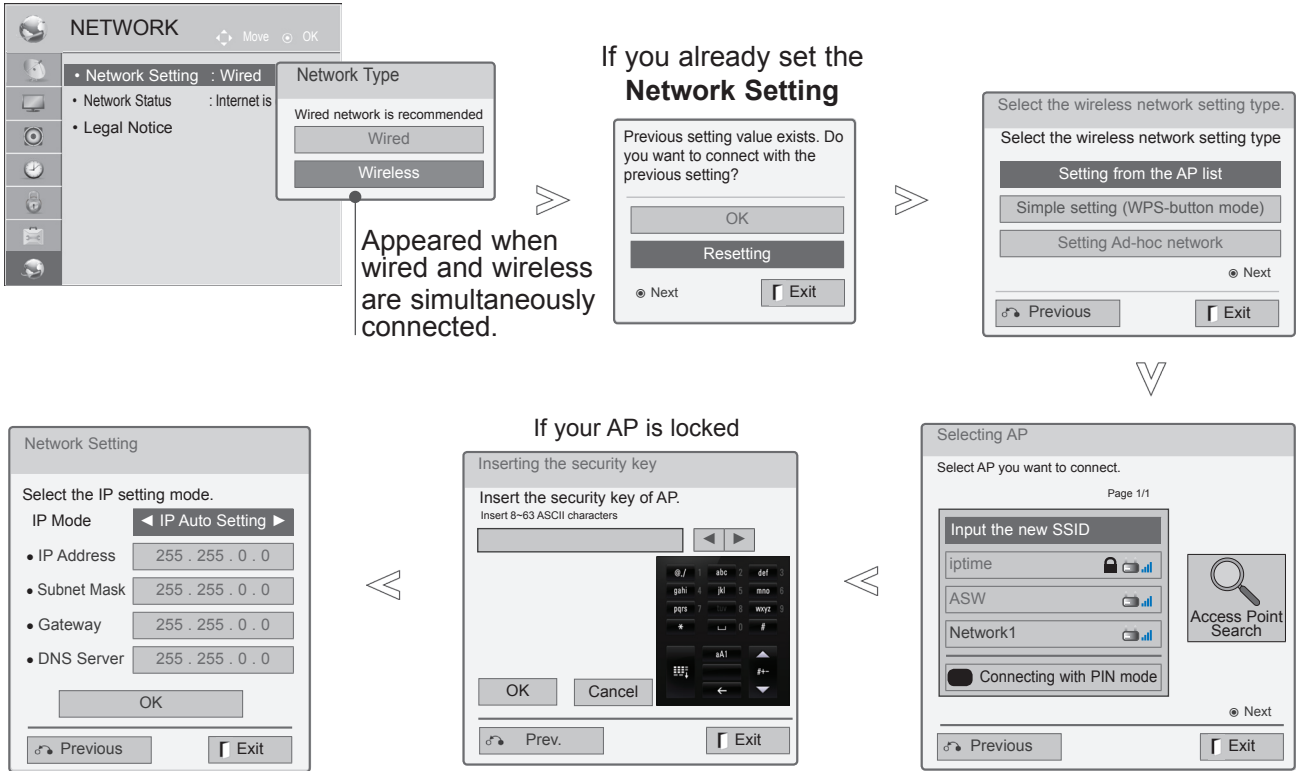

1 Select **NETWORK**.

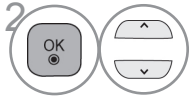

2 Select **Network Setting**.

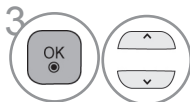

3 Select **Wireless**.

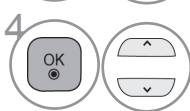

4 If you already set Network Setting:
Select **Resetting**.
The new connection settings resets the current network settings.

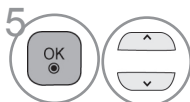

5 Select **Setting from the AP list**.



6 Scan the all available AP (Access Point) or wireless routers within range and display them as a list.

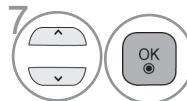

7 Select an AP (Access Point) or wireless router on the list.
(If your AP is locked, insert the security key of AP).

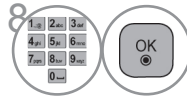

8 Input the security key of AP.

9 Repeat step 4-5 on P.17.

EXTERNAL EQUIPMENT SETUP

When a security code is already set

PIN (Personal Identification Number)

If you want to connect the AP (Access Point) or router with PIN, use this feature.

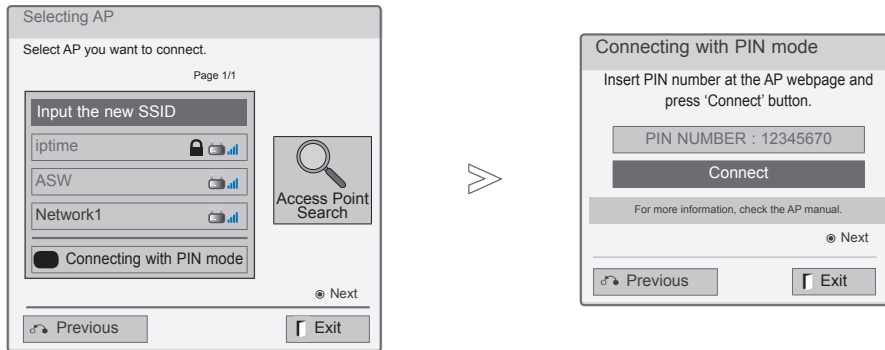

1 Repeat step 1-6 on P.21.

2 **RED** Connect the access point with **PIN** mode.

3 You can see the Network ID and Security Key on your TV screen.
Enter the PIN number to your device.

4 **OK** Select **Connect**.

5 Repeat step 4-5 on P.17.

■ PIN number is the unique 8 digit number of the dongle.

WPS (Wi-Fi Protected Setup)

If your access point or wireless router that supports PIN or WPS(Wi-Fi Protected Setup), it's available to use your access point or wireless router within 120 counts. You do not need to know the access point name (SSID: Service Set Identifier) and security code of your access point or wireless router.

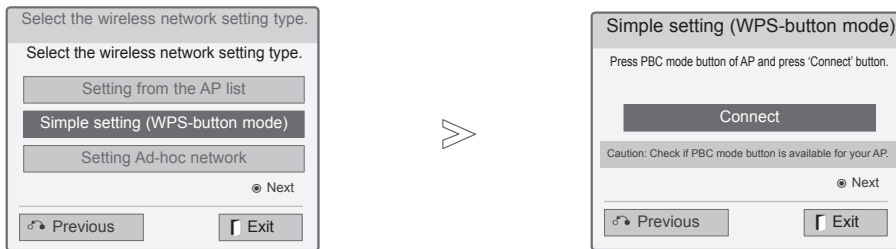

1 Repeat step 1-4 on P.21.

2   Select **Simple setting (WPS-button mode)**.

3  Select **Connect**.

4 Repeat step 4-5 on P.17.

EXTERNAL EQUIPMENT SETUP

Ad-hoc Mode

This is the method of communicating directly with the machine to communicate without AP.
This is the same as connecting two PCs with a cross cable.

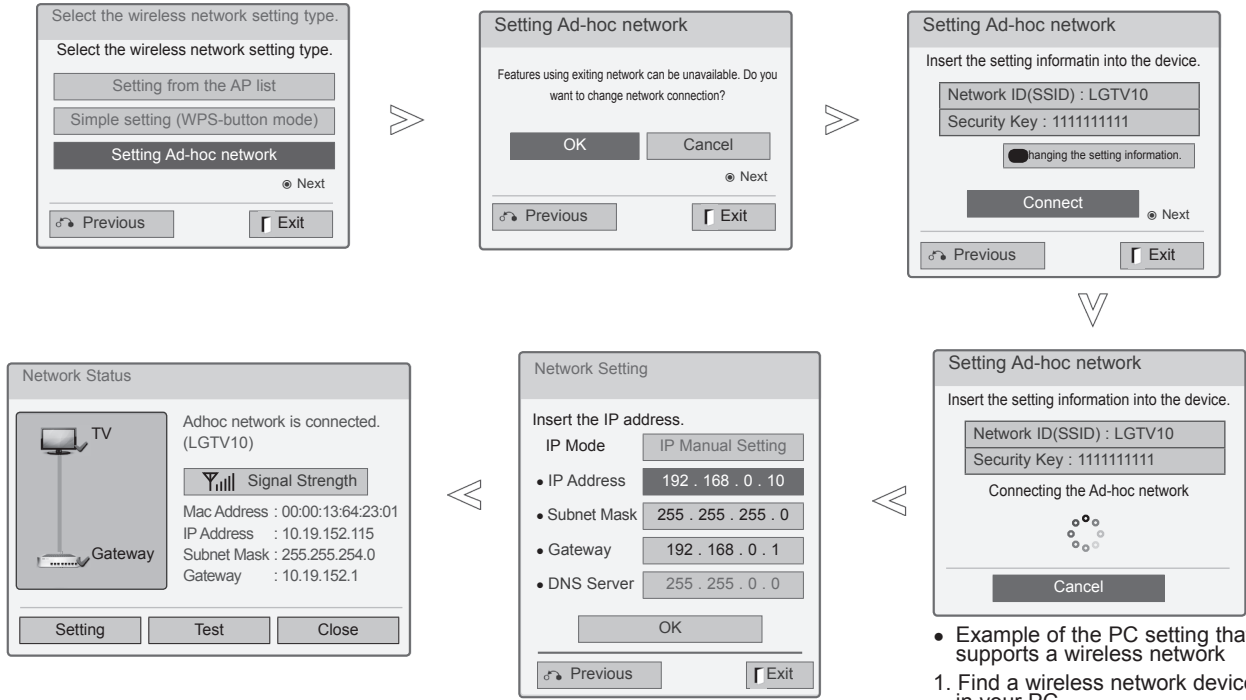

- **PC Setting**
Internet Protocol(TCP/IP) of PC needs to be set manually.
IP address, Subnet Mask, and default Gateway can be set with your own discretion.
i.e) IP address: 192.168.0.1 / Subnet Mask: 255.255.255.0 / default Gateway: 192.168.0.10
- **TV Setting**
Verify IP address and gateway of PC.
Input Gateway address of PC to IP Address, and IP Address of PC to Gateway, and select **OK**.
i.e) IP address: 192.168.0.10 / Subnet Mask: 255.255.255.0 / default Gateway: 192.168.0.1





- Example of the PC setting that supports a wireless network
1. Find a wireless network device in your PC.
 2. Select LGTV10 that appears in the list. (Select the same name as the network ID that appears on your TV screen.)
 3. Type 1111111111 in the Inserting the security key dialog. (Type the security key that appears on your TV screen.)

1 Repeat step 1-3 on P.21.

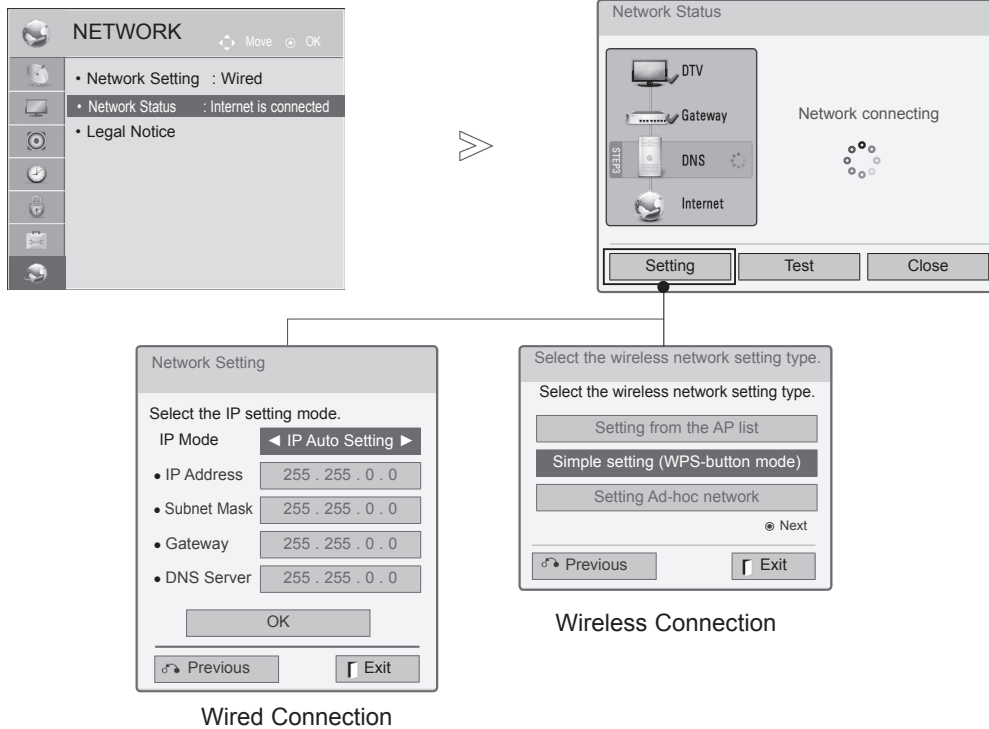
- 2 Select **Setting Ad-hoc network**.
- 3 Select **OK**.
- 4 Select **Connect** to connect Ad-hoc network. You can see the Network ID and Security Key on your TV screen. Enter this Network ID and Security Key to your device. If a network may not operate, change the setting information using the RED button.
- 5 Insert the IP address.
- 6 Network setting is completed. Select **Close**.

Network Status



- 1   Select **NETWORK**.
- 2   Select **Network Status**.
- 3  Check the network status.

- **Setting**: Return to the network setting menu or wireless network setting type menu.
- **Test**: Test the current network status after setting the network.
- **Close**: Return to the previous menu.

WATCHING TV / PROGRAMME CONTROL

TURNING ON THE TV

When your TV is turned on, you will be able to use its features.

- 1 Firstly, connect the power cord correctly.
At this stage, the TV switches to standby mode.
- 2 In standby mode to turn TV on, press the \odot / I, **INPUT** or **P** ^ \vee button on the TV or press the **POWER**, **INPUT**, **P** ^ \vee or **NUMBER** button on the remote control and the TV will switch on.

INITIALIZING SETUP

- 1 If the OSD (On Screen Display) is displayed on the screen after turning on the TV, you can adjust the **Language**(Except for Australia, New Zealand, Singapore, South Africa), **Mode Setting**, **Power Indicator**(Only LED LCD TV models - When you select **Home Use** from **Mode Setting**), **Country** (Only Australia, New Zealand), **Time Zone**(Only Australia), **Auto Tuning**.

Note:

- a.If you close without completing the initial setting, the Initial Setting menu can be displayed again.
- b.Press the **BACK** button to change the current OSD to the previous OSD.
- c.For those countries without confirmed DTV broadcasting standards, some DTV features might not work, depending on the DTV broadcasting environment.(Only DTV)
- d."Home Use" mode is the optimal setting for home environments, and is the TV's default mode.
- e."Store Demo" mode is the optimal setting for store environments. If a user modifies image quality data, "Store Demo" mode initializes the product to the image quality set by us after a certain period of time.
- f. The mode (Home Use, Store Demo) can be changed by executing Mode Setting in the **OPTION** menu.

PROGRAMME SELECTION

- 1 Press the **P** ^ \vee or **NUMBER** buttons to select a programme number.

VOLUME ADJUSTMENT





- 1 Press the \triangle + or - button to adjust the volume.
- 2 If you wish to switch the sound off, press the **MUTE** button.





You can cancel this function by pressing the **MUTE**, \triangle + , - or **AV Mode** button.

QUICK MENU





Your TV's OSD (On Screen Display) may differ slightly from that shown in this manual.

Q.Menu (Quick Menu) is a menu of features which users might use frequently.

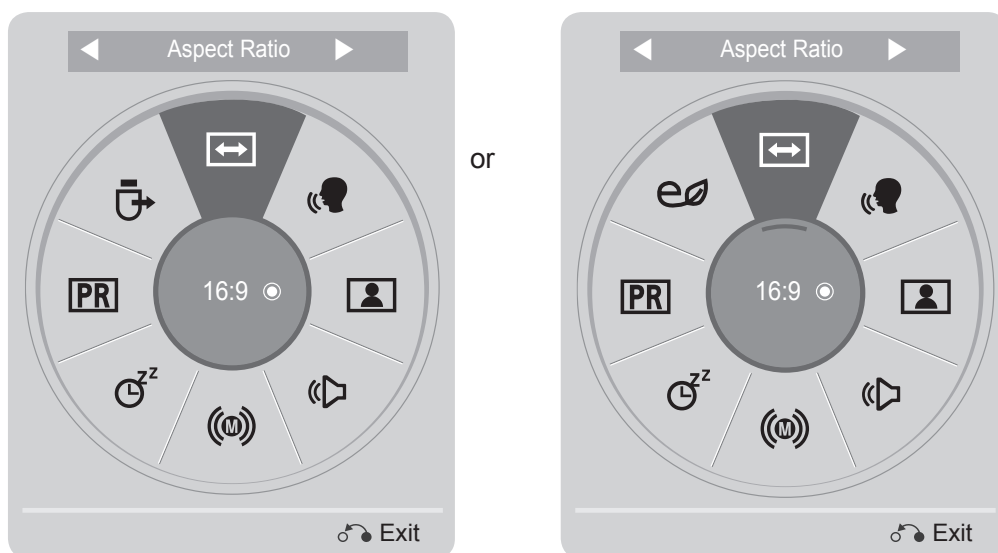
-  **Aspect Ratio**: Selects your desired picture format.
For Zoom Setting, select 14:9, Zoom and Cinema Zoom in Ratio Menu. After completing Zoom Setting, the display goes back to Q.Menu.
-  **Clear Voice II** : By differentiating the human sound range from others, it helps users listen to human voices better.
-  **Picture Mode** : Selects your desired Picture Mode.
-  **Sound Mode** : It is a feature to automatically set the sound combination which it deems the best for the images being watched. Selects your desired Sound Mode.

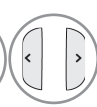
-  **Audio or Audio Language** : Selects the sound output.
-  **Sleep Timer** : Sets the sleep timer.
-  **Skip Off/On** : Selects the Skip Off/On.
-  **USB Device** : Selects "Eject" in order to eject USB device. (Except for 22/26/32LD3**)
-  **Energy Saving** : Selects your desired Energy Saving mode. (Only for 22/26/32LD3**)







- 1   Display each menu.
- 2  Select your desired Source.
- 3  

- Press the **Q.MENU/EXIT** button to return to normal TV viewing.
- Press the **BACK** button to move to the previous menu screen.

WATCHING TV / PROGRAMME CONTROL

ON SCREEN MENUS SELECTION AND ADJUSTMENT

Your TV's OSD (On Screen Display) may differ slightly from that shown in this manual.

- 1   Display each menu.
- 2   Select a menu item.
- 3  Move to the pop up menu.

- Press the **RED** button, you can check the **Customer Support** menu.
- Press the **GREEN** button, you can check the **Simple Manual** menu.
- Press the **MENU/EXIT** button to return to normal TV viewing.
- Press the **BACK** button to move to the previous menu screen.

! NOTE

- ▶ It is possible to use **Country** menu in Australia and New Zealand only.
- ▶ It is possible to use **Hard of Hearing, Parental Guidance** menu in DTV only.

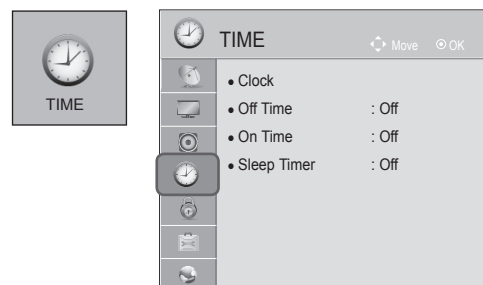
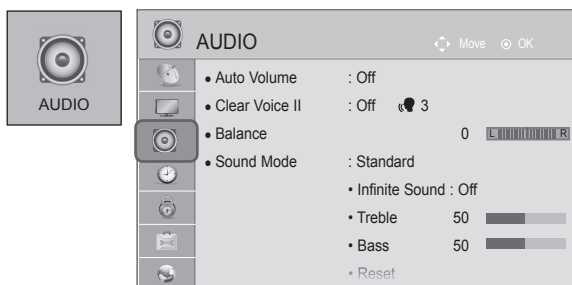
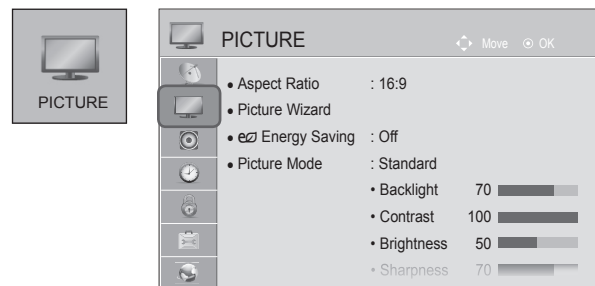
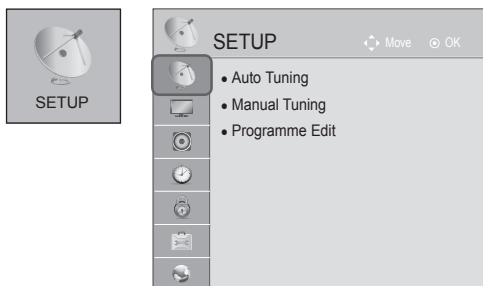

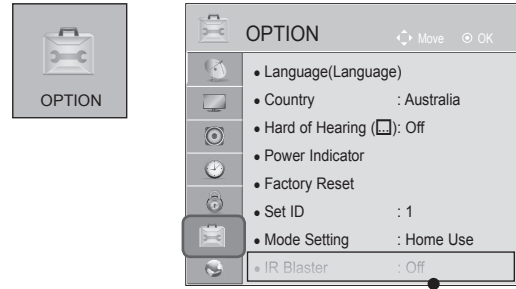
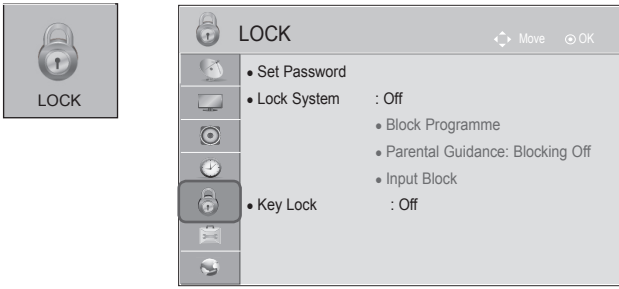

• For further information, refer to the optional **“Wireless Media Box & Wireless Dongle”** manual for operating instructions.
 (Only 32/42/46/52/60LD5**, 32/37/42/47/55LD6**, 32/37/42/47/55LE53**, 32/37/42/47/55LE55**, 32/37/42/47/55LE7***, 42/47/55LE8***, 32/42LE45**, 42/47/55LX6***, 47/55LX9***, 32LE3***)

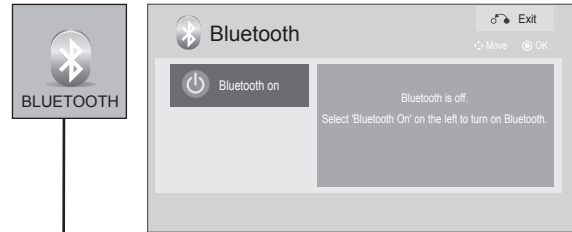
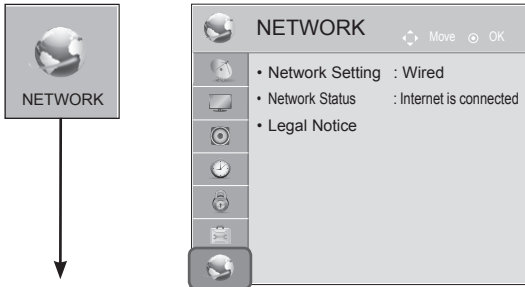

(Only 32/42/52LD56*, 32/37/42/47/55LD6**, 32/37/42/47/55LE55**, 32/37/42/47/55LE7***, 42/47/55LE8***, 42/47/55LX6***, 47/55LX9***)

(Only 32/37/42/47/55LE55**, 32/37/42/47/55LE7***, 42/47/55LE8***, 42/47/55LX6***)



(Except for 22/26/32LD3**)

(Only 32/42/52LD56*, 32/37/42/47/55LD6**, 32/37/42/47/55LE55**, 32/37/42/47/55LE7***, 42/47/55LE8***, 42/47/55LX6***, 47/55LX9***)

■ Image shown may differ from your TV.

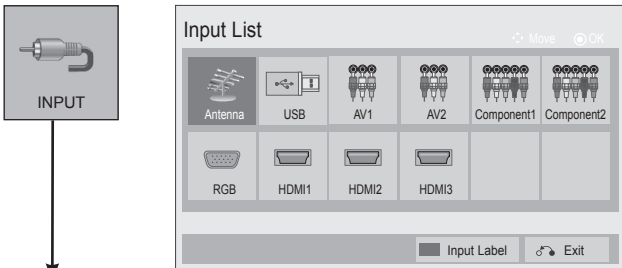

(Except for 22/26/32LD3**)

WATCHING TV / PROGRAMME CONTROL

AUTO PROGRAMME TUNING





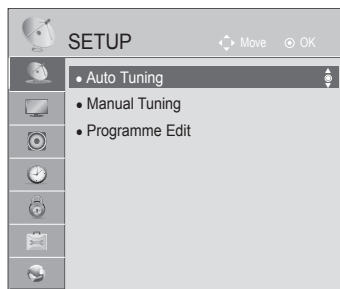

Use this to automatically find and store all available programmes.

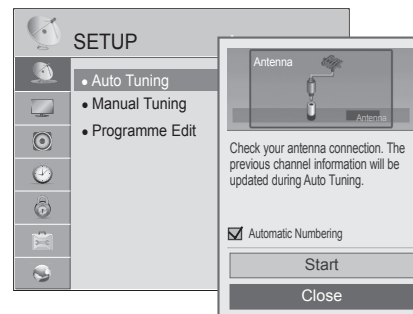
When you start auto programming, all previously stored service information will be deleted.



■ Image shown may differ from your TV.

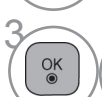

- 1   Select **SETUP**.
- 2   Select **Auto Tuning**.
- 3   Select **Start**.
- 4  Run **Auto tuning**.









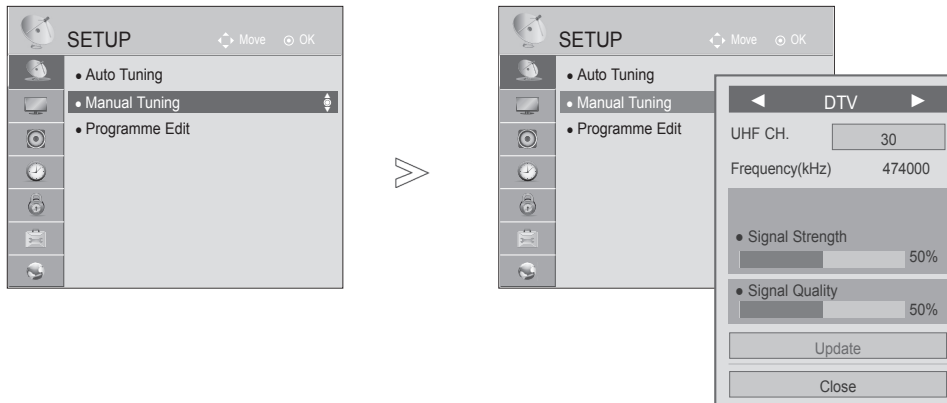

- Use **NUMBER** buttons to input a 4-digit password in **Lock System 'On'**.
- If you wish to keep on auto tuning select **Start** using the **^ v** button. Then, press the **OK** button. Otherwise select **Close**.
- **Automatic Numbering**: Decide whether to use the programme numbers as sent by broadcasting stations for tuning. (Only DTV)

- Press the **MENU/EXIT** button to return to normal TV viewing.
- Press the **BACK** button to move to the previous menu screen.

MANUAL PROGRAMME TUNING (IN DIGITAL MODE)(ONLY DTV)

Manual Tuning lets you manually add a programme to your programme list.



- 1   Select **SETUP**.
- 2   Select **Manual Tuning**.
- 3   Select **DTV**.
- 4   Select the desired channel number.
- 5   Update.

• Use **NUMBER** buttons to input a 4-digit password in **Lock System 'On'**.

- Press the **MENU/EXIT** button to return to normal TV viewing.
- Press the **BACK** button to move to the previous menu screen.

WATCHING TV / PROGRAMME CONTROL

MANUAL PROGRAMME TUNING

(IN ANALOGUE MODE)

Manual Tuning lets you manually tune and arrange the stations in whatever order you desire.

■ Image shown may differ from your TV.

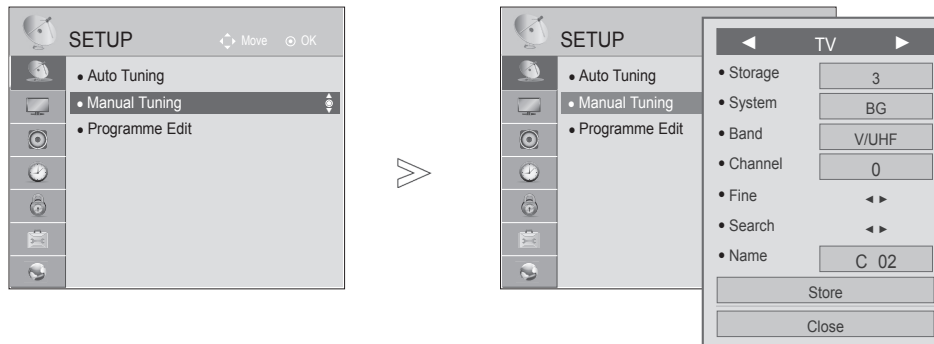

1. Select **SETUP**.
2. Select **Manual Tuning**.
3. Select **TV**. (Only DTV)
4. or Select the desired channel Storage.
5. Select a TV system. (Except for Australia)
6. Select **V/UHF** or **Cable**.
7. or Select the desired channel number.
8. Commence searching.
9. Select **Store**.

- Press the **MENU/EXIT** button to return to normal TV viewing.
- Press the **BACK** button to move to the previous menu screen.



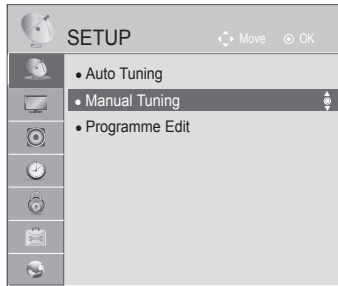



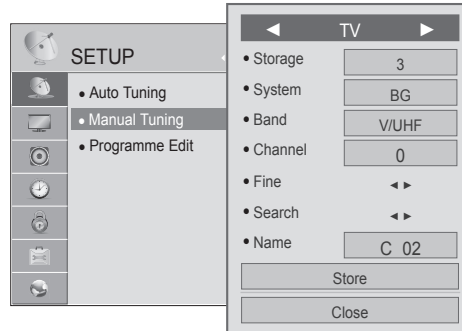

- Use **NUMBER** buttons to input a 4-digit password in **Lock System 'On'**.
- **BG** : PAL B/G (New Zealand / South Africa / Singapore / Indonesia / Israel / Malaysia / Vietnam / Asia)
- **DK** : PAL D/K (New Zealand / South Africa / Singapore / Indonesia / Israel / Malaysia / Vietnam / Asia)
- **I** : PAL I/II (New Zealand / South Africa / Singapore / Indonesia / Israel / Malaysia / Vietnam / Asia)
- **B/B** : Australia
- **M** : NTSC-M (South Africa / Indonesia / Israel / Malaysia / Vietnam / Asia)
- To store another channel, repeat steps 4 to 9.







(IN ANALOGUE MODE)

■ Image shown may differ from your TV.

**■ Assigning a station name**











You can assign a station name with five characters to each programme number.

- 1   Select **SETUP**.
- 2   Select **Manual Tuning**.
- 3   Select **TV**. (Only DTV)
- 4   Select **Name**.

- 5   Select the position and make your choice of the second character, and so on. You can use the alphabet **A** to **Z**, the number **0** to **9**, **+**/**-**, and blank.
- 6   Select **Close**.
- 7   Select **Store**.

■ Fine Tuning

Normally fine tuning is only necessary if reception is poor.

- 1   Select **SETUP**.
- 2   Select **Manual Tuning**.
- 3   Select **TV**. (Only DTV)
- 4  Select **Fine**.
- 5  Fine tune for the best picture and sound.
- 6   Select **Store**.

- Press the **MENU/EXIT** button to return to normal TV viewing.
- Press the **BACK** button to move to the previous menu screen.

WATCHING TV / PROGRAMME CONTROL

PROGRAMME EDIT

When a programme number is skipped, it means that you will be unable to select it using P ∨ ^ button during TV viewing.

If you wish to select the skipped programme, directly enter the programme number with the NUMBER buttons or select it in the Programme edit menu.

This function enables you to skip the stored programmes.

You can change the programme number using “Move”function, if “Automatic Numbering” is unchecked when you start Auto Tuning.(Only DTV)

■ Image shown may differ from your TV.

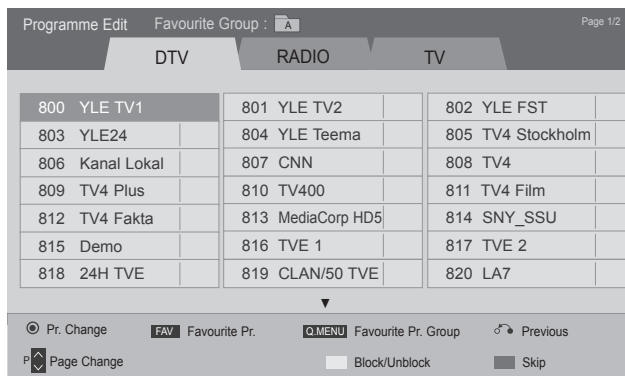
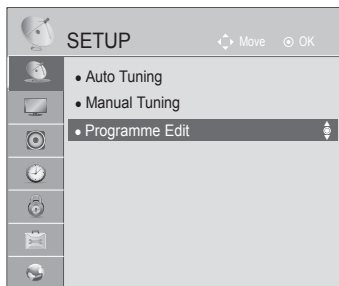

-   Select **SETUP**.
-   Select **Programme Edit**.
-  Enter the **Programme Edit**.
-   Select a programme to be stored or skipped.

- Press the **MENU/EXIT** button to return to normal TV viewing.
- Press the **BACK** button to move to the previous menu screen.

IN DTV/RADIO MODE (Only DTV)

■ Locking a programme number



1 Select a programme number to be locked.



2 Lock up the programme.



3 Release.

- It can be registered as Lock programme even when Lock System is turned Off.

■ Skipping a programme number



1 Select a programme number to be skipped.



2 Turn the programme number to blue.



3 Release.

- When programmes are to be skipped, the skipped programme shows in blue and these programmes will not be selected by the **P** ^ v buttons during TV viewing.
- If you wish to select a skipped programme, directly enter the programme number with the NUMBER buttons or select it in the programme edit or EPG.

WATCHING TV / PROGRAMME CONTROL

IN TV MODE

This function enables you to delete or skip the stored programmes.
You can also move some channels and use other programme numbers.

■ Deleting a programme

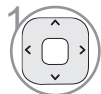

1 Select a programme number to be deleted.

• The selected programme is deleted, all the following programmes are shifted up one.



2 **RED** Turn the programme number to red.

■ Moving a programme

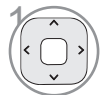

1 Select a programme number to be moved.



3 **GREEN** Release.



2 **GREEN** Turn the programme number to green.

■ Locking a programme number

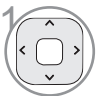

1 Select a programme number to be locked.

• It can be registered as Lock programme even when Lock System is turned Off.



2 **YELLOW** Lock up the programme.



3 **YELLOW** Release.

■ Skipping a programme number

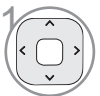

1 Select a programme number to be skipped.

• When a programme number is skipped it means that you will be unable to select it using the **P** ^ v button during normal TV viewing.



2 **BLUE** Turn the programme number to blue.



• If you wish to select a skipped programme, directly enter the programme number with the **NUMBER** buttons or select it in the programme edit.





3 **BLUE** Release.

■ Selecting favourite programme

Favorite programmes is a convenient feature that lets you quickly scan up to programmes of your choice without having to wait for the TV to scan through all the in-between programmes.

-  Select your desired programme.
-  Add corresponding programme to Favourite list of current Favourite group.
-  Release.

■ Selecting favourite programme group

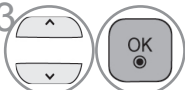
-  Select your desired programme.
-  Display a pop-up window where Favourite group can be changed.
-  Select a Favourite group.

WATCHING TV / PROGRAMME CONTROL

SOFTWARE UPDATE

(Except for 32/42/52LD56*, 32/37/42/47/55LD6**, 32/37/42/47/55LE55**, 32/37/42/47/55LE7***, 42/47/55LE8***, 42/47/55LX6***, 47/55LX9***)

You can update the TV with the latest software to enhance the product operation and/or add new features.

■ Image shown may differ from your TV.

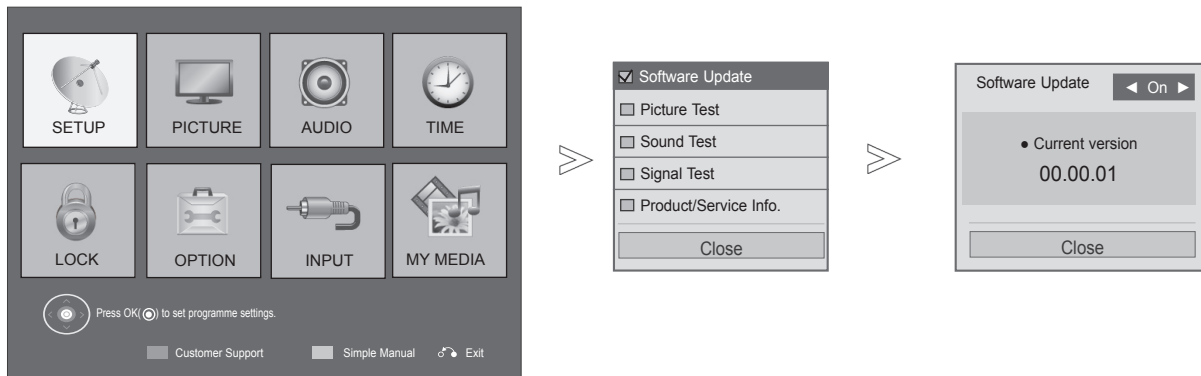

1 **RED** Select **Customer Support**.

2 Select **Software Update**.

3 Select **On** or **Off**.
• If you select **On**, a user confirm message box will be displayed to notify that new software is found.

4 Save.

- Press the **MENU/EXIT** button to return to normal TV viewing.
- Press the **BACK** button to move to the previous menu screen.

■ When setting “Software Update”

Occasionally, a transmission of updated digital software information will result in the following menu on the TV screen.

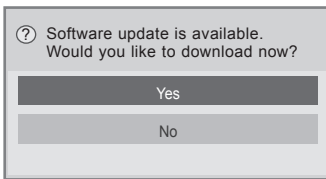

Simple Update : for current update stream

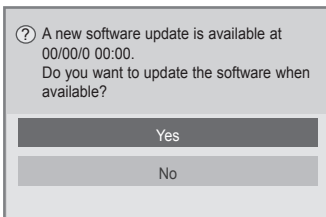

Schedule Update : for scheduled update stream
When the Software Update menu is "Off", the message to change it to "On" appears.

Download starts when "Yes" is selected. At this time, progressing pop-up window does not display.

Download progress status can be checked from Software Update menu.

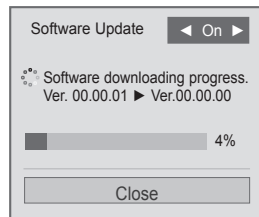

A window as display below appears when download completes.

TV is restarted when "Yes" button is pressed.

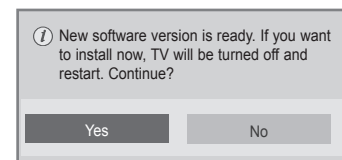

- During Progress of a Software Update, please note the following:
 - Power to the TV must not be interrupted.
 - After Software Update, you can confirm the updated software version in Software Update menu.
 - It may take hours to download the software, so make sure that the power stays on during the download.
- <Simple Update, Schedule Update>
 - The antenna must not be disconnected.
 - The software is downloaded only in Standby mode or in MUX with Software Update Service, and stops when the power cord is unplugged or when viewing MUX without Software Update Service.
 - When you return to Standby mode or MUX with Software Update Service, the software download will resume from where it stopped.

WATCHING TV / PROGRAMME CONTROL

SOFTWARE UPDATE

(Only 32/42/52LD56*, 32/37/42/47/55LD6**, 32/37/42/47/55LE55**, 32/37/42/47/55LE7***, 42/47/55LE8***, 42/47/55LX6***, 47/55LX9***)

You can update the TV with the latest software to enhance the product operation and/or add new features. You can update the software by connecting the TV directly to the software update server.

The Software Update function may not work properly depending on your internet environment. In this case, you can obtain the latest software from the authorized LG Electronics Service Center then update your TV.

■ Image shown may differ from your TV.

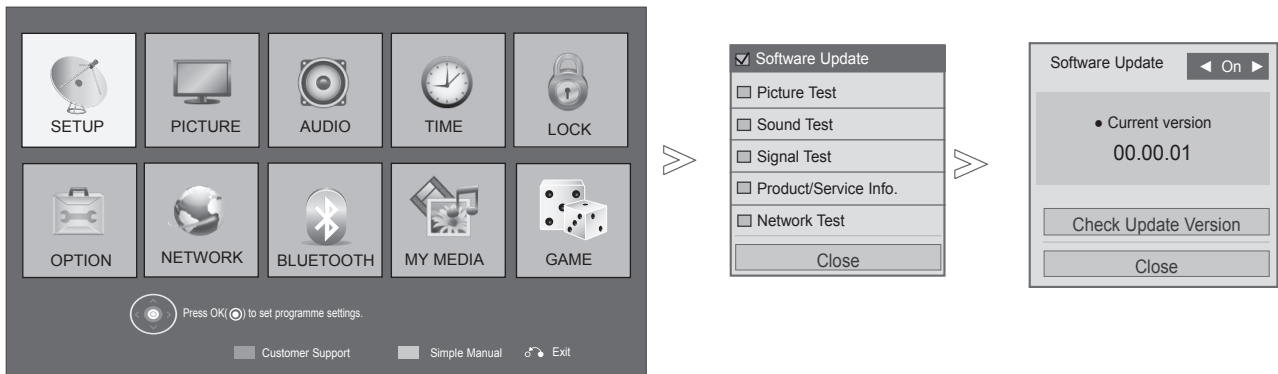

1 **RED** Select **Customer Support**.

2 Select **Software Update**.

3 Select **On** or **Off**.
• If you select **On**, a user confirm message box will be displayed to notify that new software is found.

4 Save.

• Use the **Check Update Version** to update the latest software on the Network server manually.

- Press the **MENU/EXIT** button to return to normal TV viewing.
- Press the **BACK** button to move to the previous menu screen.

■ When setting “Software Update”

Occasionally, a transmission of updated digital software information will result in the following menu on the TV screen.

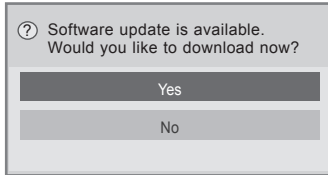

Simple Update : for current update stream

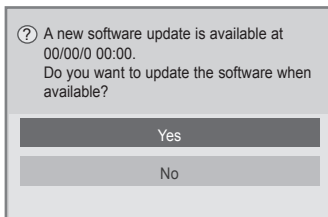

Schedule Update : for scheduled update stream

When the Software Update menu is "Off", the message to change it to "On" appears.

When new Software is available when connected to Internet, the following message will be displayed.

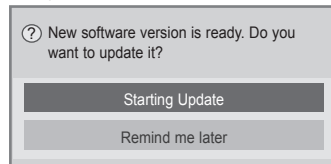

Download starts when "Yes" is selected.

Download progress status can be checked from Software Update menu.

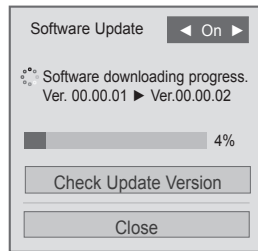

TV is restarted when download is completed.

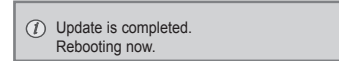

- During Progress of a Software Update, please note the following:

- Power to the TV must not be interrupted.
- After Software Update, you can confirm the updated software version in Software Update menu.
- It may take hours to download the software, so make sure that the power stays on during the download.

<Simple Update, Schedule Update>

- The antenna must not be disconnected.
- The software is downloaded only in Standby mode or in MUX with Software Update Service, and stops when the power cord is unplugged or when viewing MUX without Software Update Service.
- When you return to Standby mode or MUX with Software Update Service, the software download will resume from where it stopped.

<Network Update>

- You cannot open NetCast while the software is being updated.
- Do not release the Network connection during Update.
- When there is a new software update when you open NetCast, you will not be able to use NetCast without updating the software.

WATCHING TV / PROGRAMME CONTROL

PICTURE/SOUND TEST

This function is a customer support function that can execute picture and sound tests.

■ Image shown may differ from your TV.

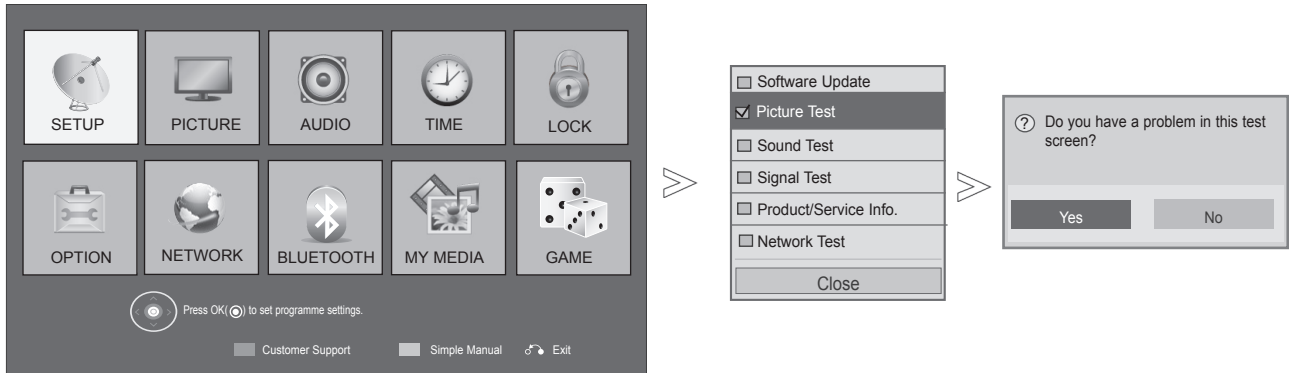

- 1 **RED** Select **Customer Support**.
- 2 Select **Picture Test** or **Sound Test**.
- 3 Select **Yes** or **No**.

- Press the **MENU/EXIT** button to return to normal TV viewing.
- Press the **BACK** button to move to the previous menu screen.

SIGNAL TEST (Only DTV)

This function enables you to view information on the Manufacturer, Model/Type and Software Version.

This displays the information and signal strength of the tuned *MUX.

This displays the signal information and service name of the selected MUX.

(*MUX: A higher directory of channels in digital broadcasting (a single MUX contains multiple channels.))

■ Image shown may differ from your TV.

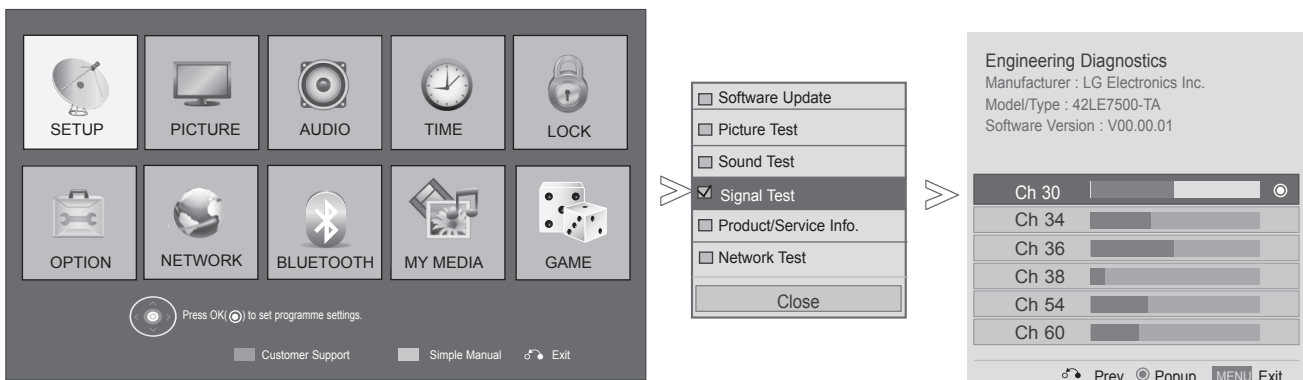

- 1 **RED** Select **Customer Support**.
- 2 Select **Signal Test**.
- 3 Display Manufacturer, Model/Type and Software Version.
- 4 Display the information of Channel.

- Press the **MENU/EXIT** button to return to normal TV viewing.
- Press the **BACK** button to move to the previous menu screen.



WATCHING TV / PROGRAMME CONTROL

PRODUCT/SERVICE INFORMATION

This function is a customer support function that can see product/service information and customer service center information.

- Image shown may differ from your TV.



- 1  **RED** Select **Customer Support**.
- 2  Select **Product/Service Info..**
- 3  Display Model/Type, Software version, Serial Number, Used time, Customer service center and Homepage.

- Press the **MENU/EXIT** button to return to normal TV viewing.
- Press the **BACK** button to move to the previous menu screen.

NETWORK TEST

(Only 32/42/52LD56*, 32/37/42/47/55LD6**, 32/37/42/47/55LE55**, 32/37/42/47/55LE7***, 42/47/55LE8***, 42/47/55LX6***, 47/55LX9***)

Check the network status.

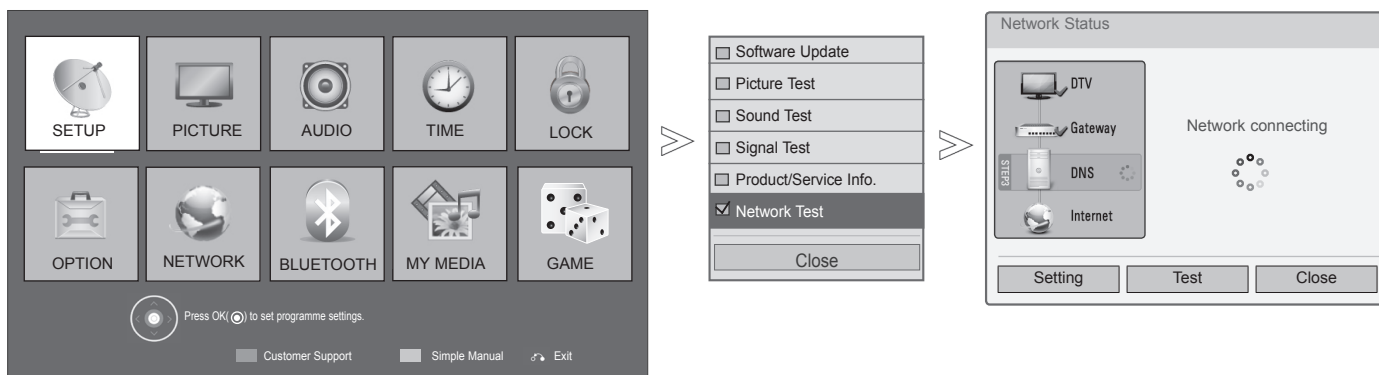

- 1 **RED** Select **Customer Support**.
- 2 Select **Network Test**.
- 3 Check the network status.

- Press the **MENU/EXIT** button to return to normal TV viewing.
- Press the **BACK** button to move to the previous menu screen.

WATCHING TV / PROGRAMME CONTROL

SIMPLE MANUAL

You can easily and effectively access the TV information by viewing a simple manual on the TV. During the Simple Manual operation, audio will be muted.



■ Image shown may differ from your TV.

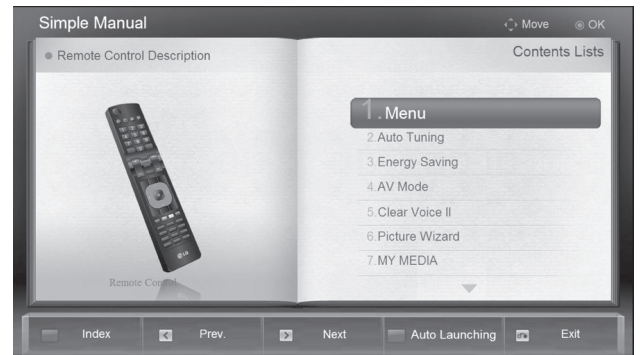

1 **GREEN** Select **Simple Manual**.

2 Select the part of the manual you want to see.

- **RED** : Go to the **Index** page.
- **BLUE** : Play the **Simple Manual** automatically or manually.

• Press the **EXIT** button to return to normal TV viewing.

SELECTING THE PROGRAMME LIST

You can check which programmes are stored in the memory by displaying the programme list.

Mini Glossary

 Displayed when the Locked Programme.



■ Displaying programme LIST

1  Display the **Programme List**.

- You may find some blue programmes. These have been set up to be skipped by auto programming or in the programme edit mode.
- Some programmes with the channel number shown in the programme LIST indicate there is no station name assigned.

 Turn the programme edit.

■ Selecting a programme in the programme list

1  Select a programme.

2  Switch to the chosen programme number.

 The mode will be switched between TV, DTV, and Radio from the programme you are currently watching.(Only DTV)

WATCHING TV / PROGRAMME CONTROL

■ Paging through a programme list



1 Turn the pages.



2 Return to normal TV viewing.

■ Displaying the favourite programme list



1 Display the Favourite Programme List.

BLUE

Turn the programme edit.

YELLOW

Current channel is registered/
cancelled as preferred channel on
currently selected Group.



Favourite group is changed.

INPUT LIST

By using **TV/RAD** button, you can move from External Input to RF Input and to the last watched programme in DTV/RADIO/TV mode.(Only DTV)

■ Image shown may differ from your TV.

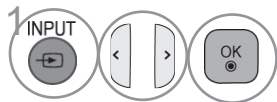
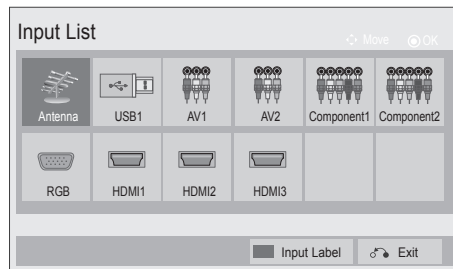

Select the input source.

- **Antenna** : Select it when watching the TV. (Only DTV : Select it when watching the DTV/TV/RADIO.)
- **USB** : Select it when using USB depends on connector.
- **AV** : Select it when watching the VCR or external equipment.
- **Component** : Select it when using the DVD or the Digital set-top box depends on connector.
- **RGB** :Select it when using PC depends on connector.
- **HDMI** : Select it when using DVD, PC or Digital set-top box depend on connector.



WATCHING TV / PROGRAMME CONTROL

INPUT LABEL

Selects a label for each input source.

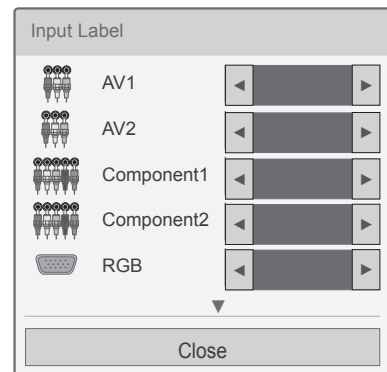
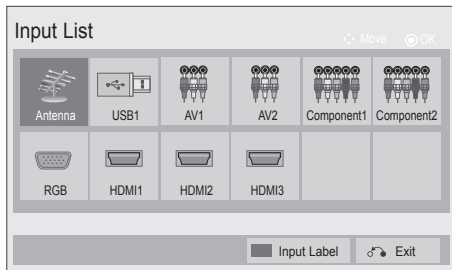
■ Image shown may differ from your TV.



-  **BLUE** Select **Input Label**.
-  Select the source.
-  Select the label.

- Press the **MENU/EXIT** button to return to normal TV viewing.
- Press the **BACK** button to move to the previous menu screen.





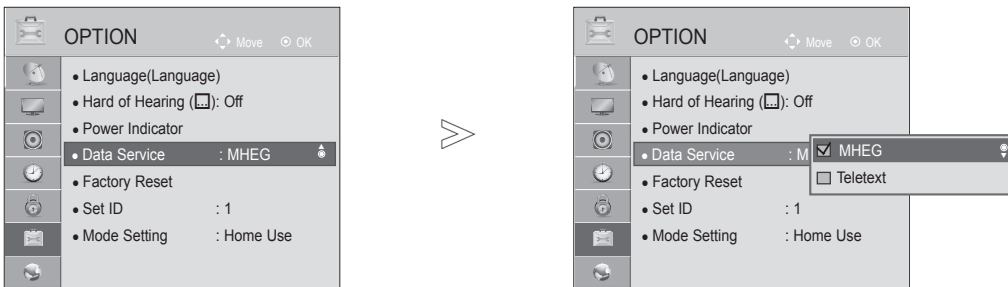

DATA SERVICE

(This menu is enabled only in South Africa, Malaysia.)

This function allow users to choose between **MHEG(Digital Teletext)** and **Teletext** if both exist at the same time.

If only one of them exists, either **MHEG** or **Teletext** is enabled regardless of which option you select-ed.



-   Select **OPTION**.
-   Select **Data Service**.
-   Select **MHEG** or **Teletext**.
-  Save.

- Press the **MENU/EXIT** button to return to normal TV viewing.
- Press the **BACK** button to move to the previous menu screen.

WATCHING TV / PROGRAMME CONTROL

SIMPLINK



This function operates only with devices with the SIMPLINK logo.
Please check the SIMPLINK logo.

This TV might not function properly when using it with other products with HDMI-CEC function.
This allows you to control and play other AV devices connected to the display through HDMI cable without additional cables and settings.

If you do not want to use SIMPLINK function, select “**Off**”.

In wireless external output, SIMPLINK function is not supported.



- 1  Display the **SIMPLINK**.
- 2  Select **On** or **Off**.
- 3  Save.

- Press the **MENU/EXIT** button to return to normal TV viewing.
- Press the **BACK** button to move to the previous menu screen.

Connecting to Home Theater with the SIMPLINK logo.

- 1 Connect the **HDMI/DVI IN 1**, **HDMI/DVI IN 2**(Except for 22LD3**, 32/37/42/47LD4**, 22LE5***) or **HDMI IN 3**(Except for 22/26/32LD3**, 32/37/42/47LD4**, 22LE5***) or **HDMI IN 4** (Only 32/37/42/47/55LE5***, 32/37/42/47/55LE7***, 42/47/55LE8***, 42/47/55LX6***, 47/55LX9***, 32/42/47/55LE4***, 32LE3***) terminal on the back of the TV and the HDMI output terminal of the Home Theater using HDMI cables.
- 2 Connect the Digital Audio output terminal on the back of the TV and the Digital Audio input terminal of the Home Theater using optical cables.
- 3 Select Home Theater in the Speaker menu by pushing the **SIMPLINK** button.

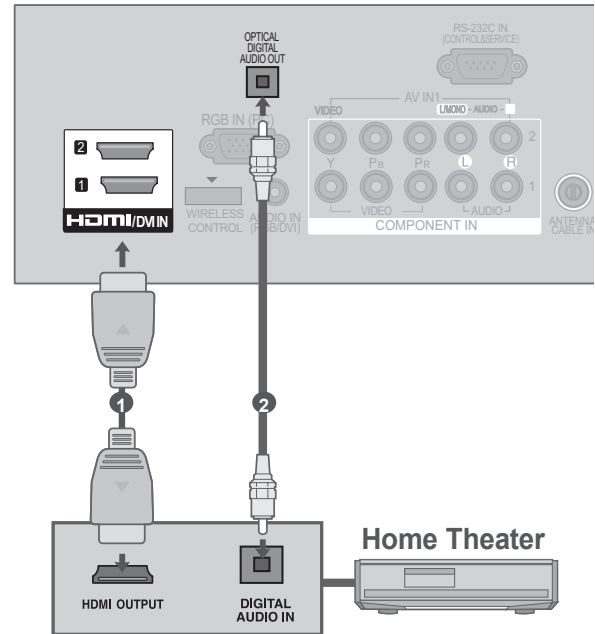

- ▶ When you select or operate a media device with home theater function, the speaker automatically switches to home theater speaker (HT speaker).

NOTE

- ▶ Connect the HDMI/DVI IN or HDMI IN terminal of the TV to the terminal (HDMI terminal) of the SIMPLINK device with the HDMI cable.
- ▶ When you switch the Input source using the INPUT button on the remote control, you can stop the operation of a device controlled by SIMPLINK.

WATCHING TV / PROGRAMME CONTROL

SIMPLINK Functions

Disc playback

Control connected AV devices by pressing the ^ v < >, OK, ►, ■, II, ◀◀ and ►► buttons.

Direct Play

After connecting AV devices to the TV, you can directly control the devices and play media without additional settings.

Select AV device

Enables you to select one of the AV devices connected to the TV and operate it.

Power off all devices

When you switch off the TV, all connected devices are turned off.

Switch audio-out

Offers an easy way to switch audio-out.

Sync Power on

When the equipment with Simplink function connected HDMI terminal starts to play, The TV will change automatically to turn on mode.

* A device, which is connected to the TV through an HDMI cable but does not support SIMPLINK, does not provide this function.

Note: To operate SIMPLINK, an High Speed HDMI Cable with *CEC function should be used. (*CEC: Consumer Electronics Control).

SIMPLINK Menu

Press the ^ v < > button and then OK button to select the desired SIMPLINK source.

- 1 TV viewing** : Switch to the previous TV programme regardless of the current mode.
- 2 DISC playback** : Select and play connected discs.
When multiple discs are available, the device type of discs are conveniently displayed at the bottom of the screen.
- 3 VCR playback** : Play and control the connected VCR.
- 4 HDD Recordings playback** : Play and control recordings stored in HDD.
- 5 Audio Out to Home theater/Audio Out to TV**: Select Home theater or TV speaker for Audio Out.

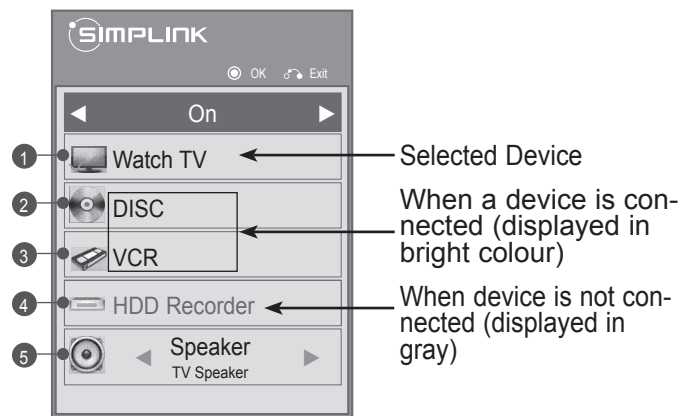

AV MODE

You can select the optimal images and sounds when connecting AV devices to external input.

- Off** Disables the AV MODE.
- Cinema** Optimizes video and audio for watching movies.
- Sport/Cricket** Optimizes video and audio for watching sports events.
- Game** Optimizes video and audio for playing games.

■ Image shown may differ from your TV.

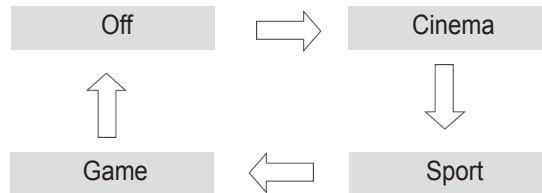

Press the **AV MODE** button repeatedly to select the desired source.



- If you select **Cinema** in AV mode, **Cinema** will be selected both for **Picture Mode** and **Sound Mode** in **PICTURE** menu and **AUDIO** menu respectively.
- If you select “**Off**” in AV mode, the picture and image which you initially set will be selected.
- When playing a video game using PlayStation or Xbox, it is recommended to use the **Game** mode.
- When in **Game** mode, functions related to picture quality will be optimized for playing games.

WATCHING TV / PROGRAMME CONTROL

INITIALIZING(RESET TO ORIGINAL FACTORY SETTINGS)

This function initializes all settings.





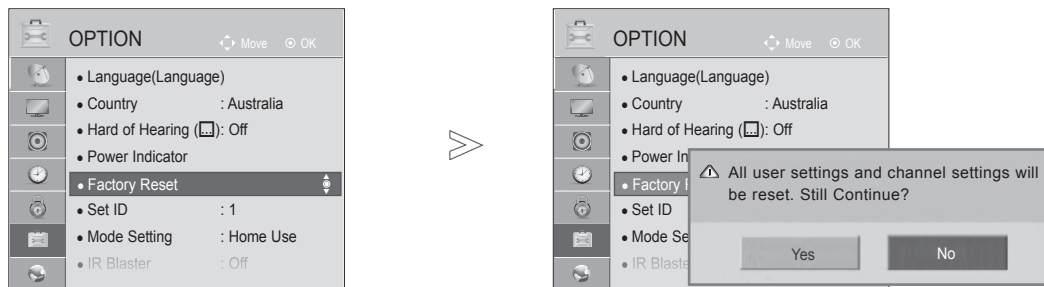

But the settings of **Day** and **Night** of the **Picture Mode** cannot be initialized.

It is useful to initialize the product or when you move to other city or country.

When the Factory Reset is completed, you must restart the Initializing setup.

When the **Lock System** menu is "On", the message to enter the password appears.



- 1   Select **OPTION**.
- 2   Select **Factory Reset**.
- 3   Select **Yes**.
- 4  Start Factory Reset.

• In **Lock System "On"**, if you forget your password, press '0', '3', '2', '5' on the remote control handset.

- Press the **MENU/EXIT** button to return to normal TV viewing.
- Press the **BACK** button to move to the previous menu screen.





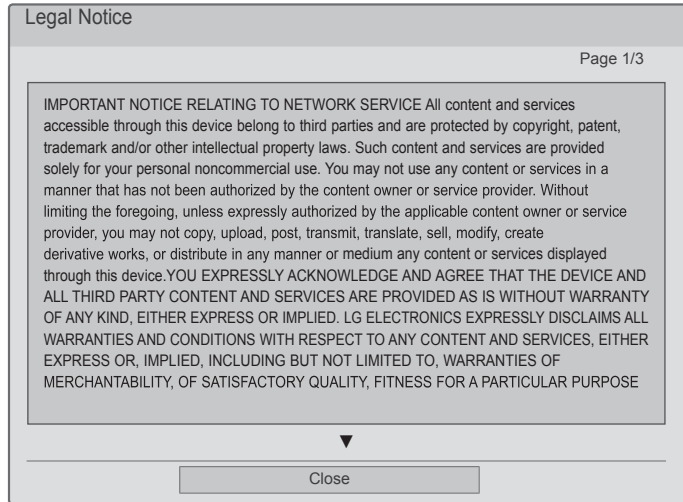

NETCAST

This feature is not available in all countries.

(Only 32/42/52LD56*, 32/37/42/47/55LD6**, 32/37/42/47/55LE55**, 32/37/42/47/55LE7***, 42/47/55LE8***, 42/47/55LX6***, 47/55LX9***)

LEGAL NOTICE



- 1   Select **NETWORK**.
- 2   Select **Legal Notice**.
- 3   Check Legal notice.

- Press the **MENU/EXIT** button to return to normal TV viewing.

IMPORTANT NOTICE RELATING TO NETWORK SERVICES

All content and services accessible through this device belong to third parties and are protected by copyright, patent, trademark and/or other intellectual property laws. Such content and services are provided solely for your personal noncommercial use. You may not use any content or services in a manner that has not been authorized by the content owner or service provider. Without limiting the foregoing, unless expressly authorized by the applicable content owner or service provider, you may not copy, upload, post, transmit, translate, sell, modify, create derivative works, or distribute in any manner or medium any content or services displayed through this device.

YOU EXPRESSLY ACKNOWLEDGE AND AGREE THAT THE DEVICE AND ALL THIRD PARTY CONTENT AND SERVICES ARE PROVIDED "AS IS" WITHOUT WARRANTY OF ANY KIND, EITHER EXPRESS OR IMPLIED. LG ELECTRONICS EXPRESSLY DISCLAIMS ALL WARRANTIES AND CONDITIONS WITH RESPECT TO ANY CONTENT AND SERVICES, EITHER EXPRESS OR IMPLIED, INCLUDING BUT NOT LIMITED TO, WARRANTIES OF MERCHANTABILITY, OF SATISFACTORY QUALITY, FITNESS FOR A PARTICULAR PURPOSE, AND NON-INFRINGEMENT OF THIRD PARTY RIGHTS. LG DOES NOT GUARANTEE THE ACCURACY, VALIDITY, TIMELINESS, LEGALITY, OR COMPLETENESS OF ANY CONTENT OR SERVICE MADE AVAILABLE THROUGH THIS DEVICE AND DOES NOT WARRANT THAT THE DEVICE OR SERVICES WILL MEET YOUR REQUIREMENTS, OR THAT OPERATION OF THE DEVICE OR SERVICES WILL BE UNINTERRUPTED OR ERROR-FREE. UNDER NO CIRCUMSTANCES, INCLUDING NEGLIGENCE, SHALL LG BE LIABLE, WHETHER IN CONTRACT OR TORT, FOR ANY DIRECT, INDIRECT, INCIDENTAL, SPECIAL OR CONSEQUENTIAL DAMAGES, OR ANY OTHER DAMAGES ARISING OUT OF, ANY INFORMATION CONTAINED IN, OR ANY CONTENT OR SERVICE ACCESSED BY YOU OR ANY THIRD PARTY, EVEN IF ADVISED OF THE POSSIBILITY OF SUCH DAMAGES.

Third party services may be changed, suspended, removed, terminated or interrupted, or access may be disabled at any time, without notice, and LG makes no representation or warranty that any content or service will remain available for any period of time. Content and services are transmitted by third parties by means of networks and transmission facilities over which LG has no control. LG may impose limits on the use of or access to certain services or content, in any case and without notice or liability. LG expressly disclaims any responsibility or liability for any change, interruption, disabling, removal of or suspension of any content or service made available through this device.

LG is neither responsible nor liable for customer service related to the content and services. Any question or request for service relating to the content or services should be made directly to the respective content and service providers.

NETCAST MENU

These services are provided by separate Content Provider.

Content can be changed or deleted depending on Content Provider.

All content furnished by the service provider are subject to change at any time including, but not limited to the removal of content. Should you have any inquiry or problem related to the content, you may refer to the service provider's website for the most up-to-date information. Please note that LGE is not responsible for any content provided by the service provider or any changes concerning such content.

Please visit the content providers web site for specific information on their services. (But, some content manual maybe not provide depending on Content Provider).

NetCast menu source can differ by country.

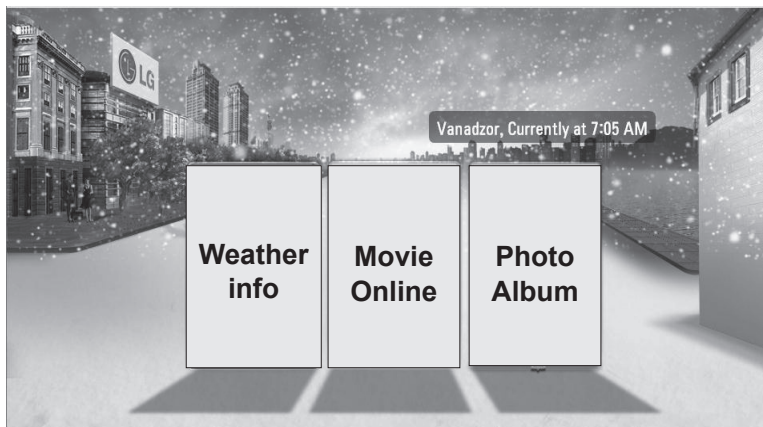

1   Select **NETCAST** menu option.

2  Enjoy the **Weather info**, **Photo Album** or **Movie Online**.

NOTE

- ▶ The videos list searched from the TV may different with the list searched from a web browser on PC.
- ▶ The settings of this TV do not affect the Movie Online's playback quality.
- ▶ The playback videos may be paused, stopped or buffering occurring often depending on your broadband speed.

We recommend a minimum connection speed of 1.5 Mbps. For the best playback condition, a connection speed of 4.0 Mbps is required. Sometimes your broadband speed varies based on your ISP's network conditions. Contact your ISP if you have problems maintaining a fast connection that is reliable, or if you want to increase your connection speed. Many ISPs offer a variety of broadband speed options.

- ▶ To view the owner's manual that provided by the Content Provider, visit our website at <http://www.lg.com>.
- ▶ For service that requires log in, join the applicable service on the website using the PC and log in through the TV to enjoy various additional functionalities.
- ▶ When you set the city you want with Setup by pressing the red button, the background of NetCast will be set to the weather of the selected city.

- Press the **RED** button to select Weather of area.
- Press the **EXIT** button to return to normal TV viewing.

NETCAST

Movie Online

Movie Online is a video sharing website where users can upload, view, and share video clips.

Movie Online Screen Components

- 1 Movie Online menu
- 2 Videos list



RED

Set the option menu.



Return to NetCast menu.



Return to TV viewing.







NOTE

- ▶ When you press the Q.menu button while the Movie Online video is playing in full mode, you can set the video options.

Movie Online Service menu

- **Home:** You can watch the popular video in real time.
- **Featured:** The featured videos list will be displayed.
- **Popular:** The best rated videos list from Movie Online server will be displayed.
- **Most Viewed:** The most viewed videos list will be displayed.
- **Search:** The keypad/keyboard menu will be displayed.
- **History:** The videos list that you previously played will be displayed. Maximum of 20 videos can be stored.
- **Favorites:** In sign-in status, this menu will be displayed the videos list that is arranged in the Movie Online server with your account (Some videos may not appear on the **Favorites** list, even if the videos are arranged in the server).
- **Sign in (Sign Out):** Displays the keypad/keyboard menu to sign in or returns to the sign-out status.

Using the remote control

	Stops the video and displays related videos list.
	Pause the video while it is playing.
	Play the selected video.
	Skip the playback forward or backward.
	Set the option menu.
	Return to NetCast menu.
	Return to TV viewing.

NETCAST





WEATHER INFO

Weather info is the programme to view the weather of the city the user wants.

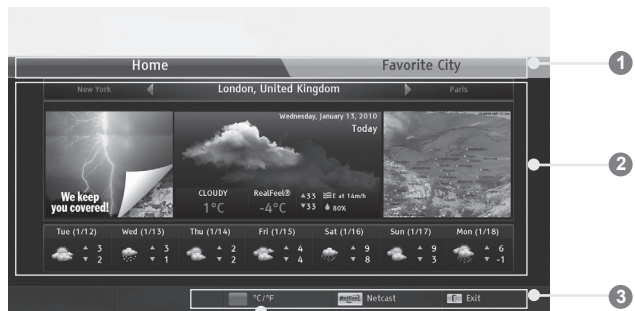
Weather info Screen Components

- 1 Weather info menu
- 2 Weather list by city
- 3 Corresponding buttons on the remote control



-  **RED** Change between Celsius and Fahrenheit.
-  Move the focus to the menu you want.
-  Select the focused menu.
-  Return to NetCast menu.
-  Return to TV viewing.

Weather info Service menu

- **Home:** The weather of selected city is displayed.
- **Favorite City:** Frequently checked cities can be registered to check the weather.

! NOTE

- ▶ By default, New York, London and Paris are registered and the user can add/delete cities from **Favorite City**.
- ▶ LG is not responsible for the accuracy of the weather forecast.
- ▶ Applicable weather information can differ from the actual weather depending on the information provided by Weather info.

PHOTO ALBUM

Photo Album is an application that appreciates digital image files.

Photo Album Screen Components

- 1 Photo Album menu
- 2 Photos list
- 3 Corresponding buttons on the remote control

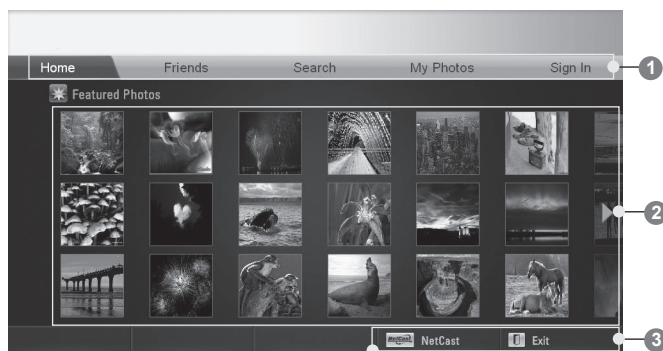

Select the desired photo.



The selected photo file is displayed.



Return to NetCast menu.



Return to TV viewing.

Photo Album Service menu

- **Home:** The featured photos list will be displayed.
- **Friends:** You can register users with the pictures you want as friends. You can add up to 10 friends.
- **Search:** The keypad/keyboard menu will be displayed.
- **My Photos:** You can view the pictures uploaded to the Web. This function can only be used when you sign in.
- **Sign in (Sign Out):** Displays the keypad/keyboard menu to sign in or returns to the sign-out status.

TO USE THE BLUETOOTH

(Only 32/37/42/47/55LE55**, 32/37/42/47/55LE7***, 42/47/55LE8***, 42/47/55LX6***)

BLUETOOTH?

Bluetooth is a short distance networking technology using 2.4 GHz frequency to connect various types of information devices such as computers, cell phones and PDAs, as well as digital appliances through wireless connection, without having to connect any cable, to enable data exchange.

With the Bluetooth communication function, you can connect the Bluetooth enabled wireless headset or receive images(only JPEG), listen to music from the Bluetooth enabled cell phone using this TV.

- Communication Spec.: Bluetooth Specification Version 2.0 + EDR (Enhanced Data Rate)
- Output: Bluetooth Specification Power Class 2
- Maximum Communication Range: Line of open sight approx. 10 m (30 ft)
- Frequency Band: 2.4 GHz band (2.4 GHz to 2.4835 GHz)
- Bluetooth Module: RBFS-B721A (LG Electronics)
- Compatible Bluetooth Profile : GAVDP(Generic Audio/Video Distribution Profile)
 - A2DP(Advanced Audio Distribution Profile)
 - OPP(Object Push Profile)
 - BIP(Basic Imaging Profile)
 - FTP(File Transfer Profile)

CE0700

Precautions when using the Bluetooth

- ▶ Use within 7 m (-45° to 45°) range.
- ▶ If you use the device out of the range or within the range with obstacles, it can result in communication error.
- ▶ Communication error can occur depending on the surrounding devices.
- ▶ Products using the same frequency of 2.4 GHz (Wireless LAN, microwave oven etc.), can cause communication error by using the same frequency bandwidth.
- ▶ The device search time differs depending on the number of Bluetooth devices and the operating situation.
- ▶ The probability of search increases with less number of devices.
- ▶ Electromagnetic wave can be interfered with applicable wireless devices.
- ▶ Because applicable wireless devices have the possibility of electromagnetic wave interference, they cannot provide services related to human life.
- ▶ You can only connect one Bluetooth device at a time.
- ▶ You cannot receive photos(only JPEG) or listen to music from other Bluetooth devices while using the Bluetooth headset.
- ▶ For details of Bluetooth, refer to the user manual of the Bluetooth device.
- ▶ Operation is subject to the following two conditions : (1) This device may not cause harmful interference, and (2) this device must accept any interference received, including interference that may cause undesired operation of the device.
- ▶ Bluetooth can be used about 30 seconds after the power is turned on.
- ▶ Depending on the transmission processing method and performance of the headset used, the audio can be instantly disconnected.

QDID(Qualified Design Identity) : B015199

SETTING THE BLUETOOTH



If you want to listen to the broadcasted sound using the Bluetooth headset or receive the jpeg images from an external device and view them on the TV, listen to music from cell phone(Bluetooth device), you can use the wireless communication without having to connect any cables.

You can use the BLUETOOTH menu by selecting “**Bluetooth on**”.

If you do not want to use the Bluetooth function, select “**Bluetooth off**”.

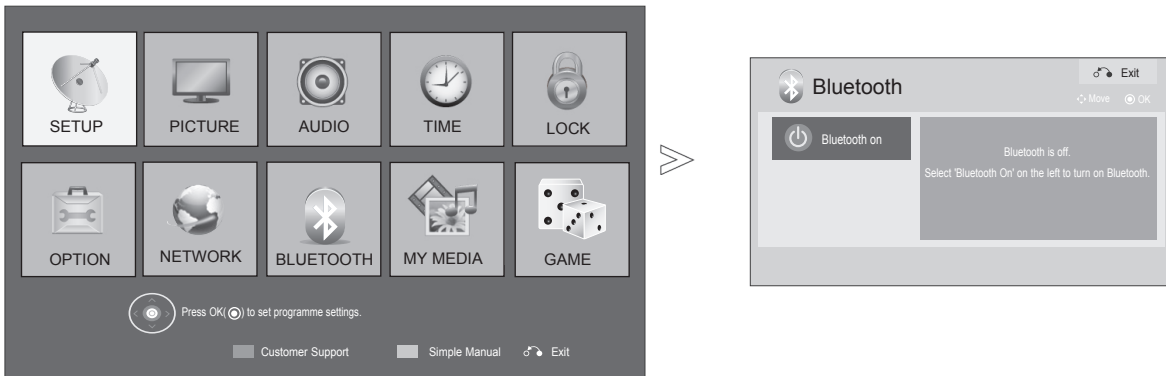
If it is connected to the external Bluetooth device, you can select “**Bluetooth off**” after disconnecting the device.

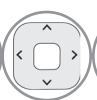

- 1    Select **BLUETOOTH**.
- 2  Select **Bluetooth on**.

- Press the **EXIT** button to return to normal TV viewing.
- Press the **BACK** button to move to the previous menu screen.

TO USE A BLUETOOTH

BLUETOOTH HEADSET

When you select the Bluetooth headset, you can listen to the TV sound in the Bluetooth headset through wireless communication.

You must pair it with any new Bluetooth device before the first use. For details, refer to the user manual of the applicable device.

A maximum of 12 devices can be paired.

When the unit is searching for the Bluetooth headset, other buttons except for the “Stop” (OK button) do not work.







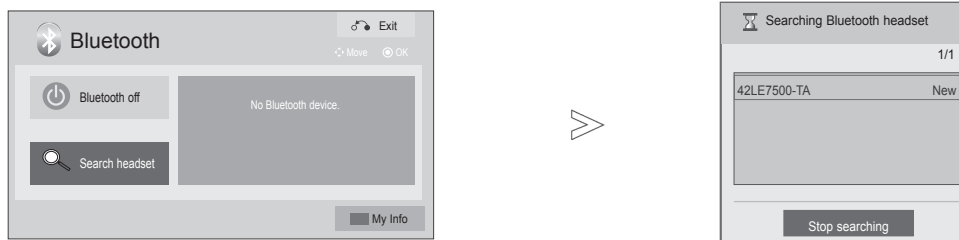

Connecting a new Bluetooth headset

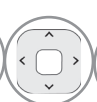
You can only search for the new Bluetooth headset only in the **Disconnected** condition.

When you run the search, it will show you the list of all Bluetooth headsets responding.

After new Bluetooth device is searched, the PIN number is validated to connect the device. For details, refer to the user manual of the applicable device.



-    Select **BLUETOOTH**.
-   Select **Search headset**.
-   Select the desired Bluetooth headset.
-  Select the desired Bluetooth headset PIN number. Refer to the user manual of the applicable device for the PIN number.
-  Connect the Bluetooth headset.

- Press the **EXIT** button to return to normal TV viewing.
- Press the **BACK** button to move to the previous menu screen.

Connecting to Bluetooth headset already registered

Bluetooth headsets are listed in the order most recently used with the headset currently in use listed at the top.

When connecting to the Bluetooth device already registered, you can select and connect directly without any PIN validation.



1 Select **BLUETOOTH**.

2 Select the desired Bluetooth headset.

3 Connect the Bluetooth headset.

- Press the **EXIT** button to return to normal TV viewing.
- Press the **BACK** button to move to the previous menu screen.

- After connecting/using the Bluetooth headset, the headset setting will be the **Disconnected** condition automatically when you turn off the power of the TV and then turn on.
- After connecting the Bluetooth headset, the TV speaker is switched to Mute condition and the sound will only be generated from the headset.

Disconnecting the Bluetooth headset during use

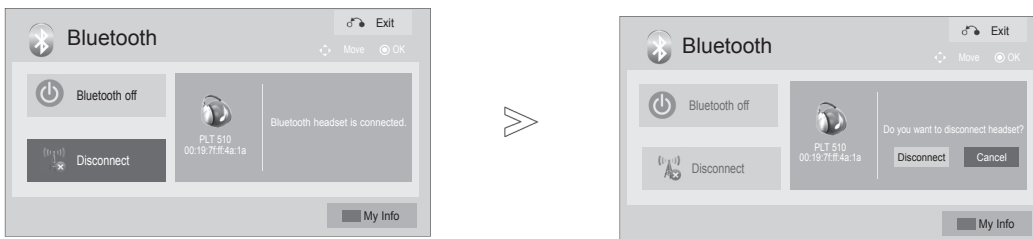

1 Select **BLUETOOTH**.

2 Select **Disconnect**.

3 Select **Disconnect**.

4 Disconnect the Bluetooth headset.

- Press the **EXIT** button to return to normal TV viewing.
- Press the **BACK** button to move to the previous menu screen.

TO USE A BLUETOOTH

When requesting to connect to TV from the Bluetooth headset

When the Bluetooth menu is "On" and there is a connection request from the headset, this message is displayed.

Not all headsets support this feature. (Refer to the user manual of the applicable Bluetooth headset.)

Some headset types may make an attempt at connection when they are turned off/on even though they are not included in the Registered Device list.

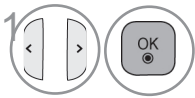
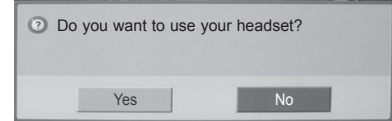

Select **Yes** or **No**.

! NOTE







- ▶ LG recommends the following headset models.
 - Plantronics VOYAGER-855 / SONY HBH-DS970, HBH-DS980 / Motorola S605There might be an audio delay, depending on the buffer memory size of the headset.
- ▶ The stereo headset officially certified to be Bluetooth compatible can be searched and connected.
- ▶ The stereo headset that supports the A2DP function among the Bluetooth devices can be connected.
- ▶ If the surrounding environment of the TV is as follows, the device may not be searched or connected properly.
 - If there is strong electromagnetic wave.
 - If there are many Bluetooth devices.
 - If the headset is turned off, not in place or has an error.
 - Because products such as microwave oven, wireless LAN, plasma light, gas range etc., use the same frequency range, it can cause communication error.
- ▶ Only one Bluetooth headset can be connected at once.
- ▶ Connection that is lost due to the TV being turned off etc. will not be automatically recovered. Try connecting the applicable device again.
- ▶ Some operations can be slower while operating the headset.
- ▶ Even if you choose simplink Home Theater after using the headset during Simplink operation, the unit will not automatically switch to Home Theater speakers.
- ▶ When the headset connection continuously fails, pair the device one more time.
- ▶ When a Bluetooth headset is in use, the Volume +/- and Mute keys do not work, and the Audio menu returns to the default value and is disabled.
- ▶ With Bluetooth set to On, if any registered devices are turned on, the TV will switch to Bluetooth mode automatically even though you are watching in another input mode. In this case, set Bluetooth to Off.

REMOVE THE BLUETOOTH DEVICE

When 12 devices are registered, you cannot register any more devices, and the external device will no longer be able to pair up with the TV. In this case, you should delete one (disconnect first if a device is connected to the TV) and then you can register another device.

"Remove device" will be available when selecting the device that is not connected to the TV.



- 1    Select **BLUETOOTH**.
- 2  Select **Remove device**.
- 3  Select **Delete**.
- 4  Remove the Bluetooth device.

- Press the **EXIT** button to return to normal TV viewing.
- Press the **BACK** button to move to the previous menu screen.

TO USE A BLUETOOTH

MY BLUETOOTH INFORMATION

This function provides the My Bluetooth Information to the user.
"Edit" will be available when TV is not connected with any device.

You can edit the Setup TV PIN or Setup TV name.
You can check the TV address.

To accept connection from an external Bluetooth device or to connect to an external Bluetooth device, the PIN needs to be entered.

For details on how to set the PIN of the external Bluetooth device, refer to the user manual of the applicable device.

The TV PIN is composed of numbers of up to 16 digits.
The TV PIN must have more than 1 digit.

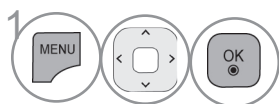
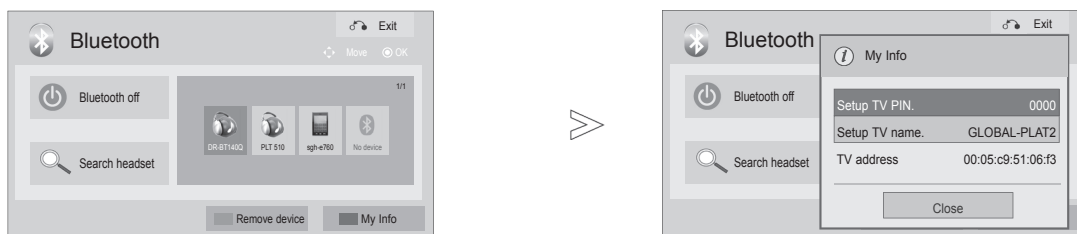

Select **BLUETOOTH**.

• Press the **DELETE** button to delete digits one by one.



Select **My Info**.



Select **Setup TV PIN** or **Setup TV name**.

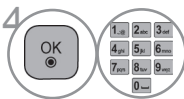

You can use an the alphabet **A** to **Z**, the number **0** to **9**, **+/-**, and blank.



Save.

- Press the **EXIT** button to return to normal TV viewing.
- Press the **BACK** button to move to the previous menu screen.

RECEIVING PHOTOS FROM EXTERNAL BLUETOOTH DEVICE

For details on how to send photos(only JPEG) from the external Bluetooth device to TV, refer to the user manual of the applicable device.

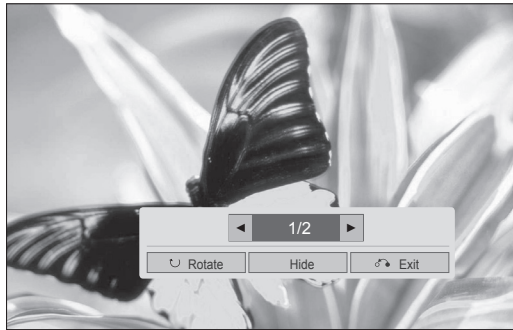
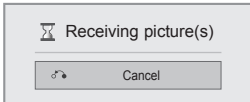

- When you select **Hide** with the $\wedge \vee < >$ button, the OSD will disappear. And when you press the **OK** button again, it will appear again.



Select the desired photos.

: Rotate photos.

- Rotates the photo 90° clockwise upon **OK** button on .

- The maximum accumulated size of the image(s) that can be received is 10MBytes.
- You cannot receive the image(s) while using the Bluetooth headset.
- You cannot receive the image(s) while listening to music from Bluetooth device.
- When the external Bluetooth device is currently sending the photo, press the **BACK** button to stop receiving the photo. All photos already received will be deleted as a result.
- With some Bluetooth devices, you may not be able to transmit an image (JPEG) file to the TV set.

LISTENING TO THE MUSICS FROM EXTERNAL BLUETOOTH DEVICE

For details on how to listen to the musics from the external Bluetooth device to TV, refer to the user manual of the applicable device.

You should use the Bluetooth device supporting A2DP(as external device).

- With some Bluetooth devices, you may not be able to listen to music via the TV speaker system.
- With some Bluetooth device, the sound can be slow or discontinued from time to time.

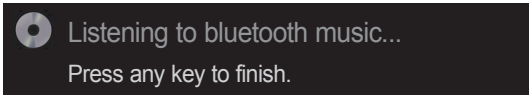

- Press the $\triangleleft +$ or - button to adjust the volume.
- If you wish to switch the sound off, press the MUTE button.
- Press the **BACK** button to return to normal TV viewing.

! NOTE

- ▶ You cannot listen to music while using the Bluetooth headset.
- ▶ You cannot listen to music while receiving image(s).

3D IMAGING

(Only 42/47/55LX6***, 47/55LX9***)

3D TECHNOLOGY

This TV can display in 3D via 3D broadcasting or when the TV is connected to a compatible device, such as a Blu-ray 3D Player. You need such a device to watch the TV in 3D. The 3D TV displays two separate pictures formatted for each eye. The viewer needs to wear 3D glasses in order to see these images in 3D format.

Viewing 3D Imaging

⚠ WARNING

- ▶ When viewing 3D images, it is important to watch the TV from an effective viewing angle and within the appropriate distance. The appropriate angle is 120°(when the viewing distance is 2m (6.5 ft)) and distance is 2m – 7m (6.5ft – 22.9ft). If you exceed this viewing angle or distance, you may not be able to view the 3D imaging. Further 3D images may not be displayed if they are viewed whilst you are lying down.
- ▶ If you watch the 3D images too closely or for a long period of time, it may harm your eyesight. If you feel any sort of eyestrain stop viewing the 3D images remove the 3D glasses and rest.
- ▶ Watching the TV or playing video games that incorporate 3D images with the 3D glasses for a long period of time can cause drowsiness, headaches or fatigue to you and/or your eyes. If you experience any of these symptoms stop viewing the 3D TV remove the 3D glasses and rest.
- ▶ Pregnant woman, seniors, persons with heart problems or persons who experience frequent drowsiness should refrain from watching 3D TV.
- ▶ Do not use the 3D imaging or 3D glasses whilst walking or moving around. Using the 3D imaging and glasses while moving around may result in injuries due to running into objects, tripping and/or falling.
- ▶ Some 3D imaging may cause you to duck or dodge the image displayed in the video. Therefore, it is best if you do not watch 3D TV near fragile objects or near any objects that can be knocked over easily.
- ▶ Please prevent children under the age of 5 from watching 3D TV. It may affect their vision development.

- ▶ **Warning for photosensitization seizure:**
Some viewers may experience a seizure or epilepsy when exposed to certain factors, including flashing lights or image as in TV or video games. If you or anybody from your family has a history of

epilepsy or seizure, please consult with your doctor before watching 3D TV.

If you experience any dizziness or light headedness, visual transition or altered vision, visual or facial instability, such as eye or muscle twitching, unconscious action, convulsion, loss of conscience, confusion or disorientation, loss of directional sense, cramps, or nausea immediately stop watching the 3D imaging and consult a doctor. Parents should monitor their children, including teenagers, for these symptoms as they may be more sensitive to the effects of watching 3D TV.

Risk of photosensitization seizure can be reduced with the following actions.

- Take frequent breaks from watching 3D TV.
- For those who have vision that is different in each eye, they should watch the TV after taking vision correction measures.
- Watch the TV so that your eyes are on the same level as the 3D screen and refrain from sitting too closely to the TV
- Do not watch the 3D imaging when tired or sick, and avoid watching the 3D imaging for a long period of time.
- Do not wear the 3D glasses for any other purpose than viewing 3D imaging on a 3D TV.
- Some viewers may feel disoriented after watching 3D TV. Therefore, after you watch 3D TV, take a moment to regain awareness of your situation before moving.

❗ NOTE

- ▶ To watch the TV in 3D, you must put on your 3D glasses. For best results, you should wear LG Brand 3D glasses. The 3D imaging may not display properly when using another brand of 3D glasses. Please see the 3D glasses manual for instructions on how to use the 3D glasses.
- ▶ After powering on the TV, a few seconds may be needed for your TV to calibrate.
- ▶ It may take a moment for you to see the 3D imaging if you look away from the TV and then revert your eyes back to the 3D program.
- ▶ The TV may flicker slightly if the 3D imaging is displayed under 3 wavelength lamp fluorescent light (50 Hz - 60 Hz) or magnetic fluorescent lamp (50 Hz - 60 Hz). In such instances, it is recommended to turn the lights off.
- ▶ If there is an obstacle between the TV and the 3D glasses, the 3D imaging may not display properly.
- ▶ Do not use the TV in close proximity to other electronic equipment and IR equipment.
- ▶ In Analog TV, 3D Imaging does not work.

WHEN USING 3D GLASSES

- ▶ 3D glasses are sold separately. Refer to the 3D glasses manual for operating instructions.
- ▶ Do not use the 3D glasses to replace your corrective glasses, sunglasses or protective goggles.
- ▶ Do not store the 3D glasses in hot or cold locations.
- ▶ Do not drop objects onto the 3D glasses. Do not drop or bend the glasses.
- ▶ Since the lenses of the 3D glasses are easily scratched, make sure to clean only with a soft cloth. Shake off any dust before using the cloth since the glasses are easily scratched.

3D IMAGING VIEWING RANGE

TV size, viewing angle & other circumstances may change the viewing distance and the angle of view.

Viewing Distance	2 m - 7 m
Viewing Angle	120 ° (When the viewing distance is 2 m)

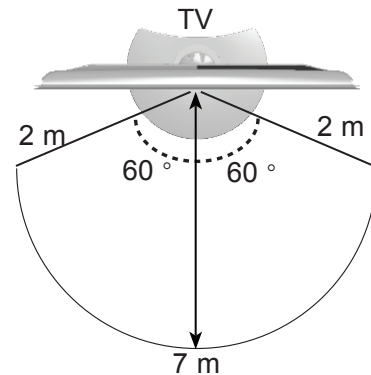

3D IMAGING

WATCHING 3D IMAGING

1 Play the video produced in 3D.

Refer to the following for the supported imaging.

	Signal	Resolution	Horizontal Frequency (kHz)	Vertical Frequency (Hz)	Playable 3D video format
HDMI Input	720p	1280x720	45	60	Top & Bottom, Side by Side
			89.9/90	59.94/60	HDMI (V. 1.4 with 3D) Frame Packing
			37.5	50	Top & Bottom, Side by Side
			75		HDMI (V. 1.4 with 3D) Frame Packing
	1080i	1920X1080	33.75	60	Top & Bottom, Side by Side
			28.125	50	
	1080p	1920X1080	67.50	60	Top & Bottom, Side by Side, Checker Board, Single Frame Sequential
			56.250	50	Top & Bottom, Side by Side
			27	24	Top & Bottom, Side by Side, Checker Board
			53.95/54	23.98/24	HDMI (V. 1.4 with 3D) Frame Packing
33.75			30	Top & Bottom, Side by Side, Checker Board	
USB Input	1080p	1920X1080	33.75	30	Top & Bottom, Side by Side, Checker Board, MPO(Photo)
Signal					Playable 3D video format
DTV	720p, 1080i				Top & Bottom, Side by Side

3D IMAGING

For 3D video feed that is input in the HDMI (V. 1.4 with 3D) Frame Packing format, it is automatically switched to 3D.

Media contents and a player need to support HDMI (V. 1.4 with 3D) Frame Packing to play in 3D.

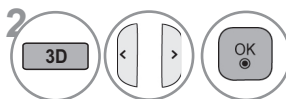

Video, which is input as HDMI (V. 1.4 with 3D) Frame Packing format, is switched into the 3D screen automatically.

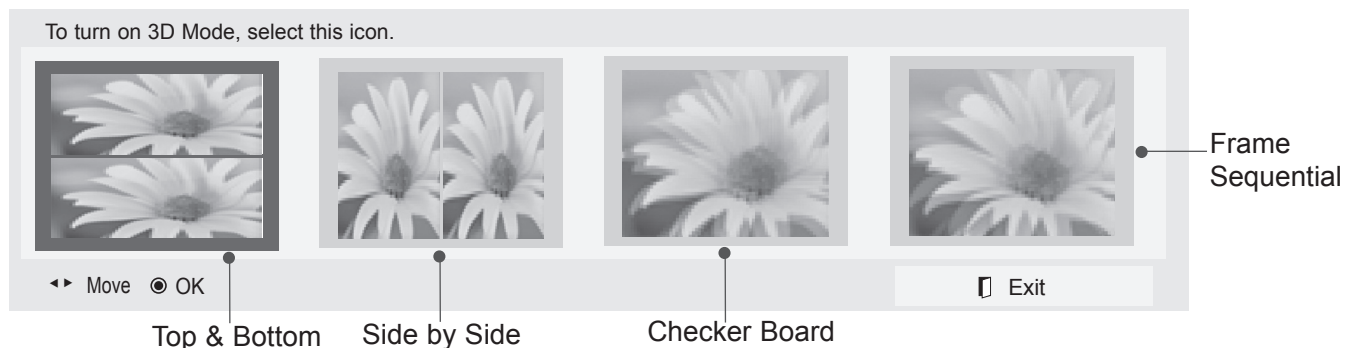
2  After selecting the shape as shown in the screen on TV, wear the 3D glasses.



3   or  Select **Setting Left/Right**.



4   Select **Left/Right** or **Right/Left**.
Select the screen with 3D video with better visibility.

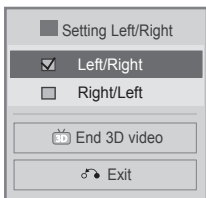

• Press the **3D** button to return to normal TV viewing.

NOTE

- ▶ If you select 3D mode, "Power indicator" is turned off automatically.
- ▶ While watching 3D imaging, you cannot adjust video/audio settings using the menu.
- ▶ Some menus may not work while watching the TV in 3D.
- ▶ You can only choose "Standard → Cinema → Game" with the **AV MODE** button on remote control. **AV Mode** is set as **Standard** while playing in 3D.
- ▶ If used 3D effect on the 2D source, 3D may not work.
- ▶ The 3D imaging mode is disabled automatically when switching DTV channels.
- ▶ The screen may not be displayed properly if you view 2D DTV images in 3D imaging mode.
- ▶ 3D effect can be seen when 3D Mode is selected appropriately for the 3D input signal supplied to the TV.
- ▶ Energy Saving is disabled while playing in 3D.
- ▶ For MPO files (3D camera files), the 3D imaging mode is enabled automatically.
- ▶ If you'd like to play the BGM using *.mpo file(3D camera file), In advance, the contents path for BGM should be set on full-sized photo view screen which isn't *.mpo file(3D camera file).
- ▶ Picture mode is set as Standard, Energy Saving Off if entering to 3D mode.

NOTES FOR VIEWING 3D IMAGE WITH 3D BROADCASTING (* In Analog TV, 3D Imaging does not work.)

When switching the 2D image display to the 3D image display with the 3D button on the remote control, the overlapped image may be displayed.

- Disable the 3D imaging mode with the 3D button.
- The 3D imaging mode is disabled automatically if you change the channel.

If the screen is divided into left/right or top/bottom when you change the channel



- This channel supports the 3D imaging mode. Select the 3D imaging type displayed on the screen by pressing the 3D button on the remote control.

If your eyes are sore or the screen looks blurry while viewing 3D images

- Press the L/R SELECT button on the remote control and select L/R or R/L, which you find better for viewing 3D images.

TO USE A USB DEVICE

WHEN CONNECTING A USB DEVICE

It is not possible to use MY MEDIA menu in 22/26/32LD3** models.

It is possible to use DLNA function in 32/42/52LD56*, 32/37/42/47/55LD6**, 32/37/42/47/55LE55**, 32/37/42/47/55LE7***, 42/47/55LE8***, 42/47/55LX6***, 47/55LX9*** models.

When you connect a USB device, this pop up menu is displayed, automatically.

“POP UP MENU” will not be displayed while the OSD including Menu, EPG or Schedule list is activated or while the Bluetooth Headset is connected.

When the Pop Up menu appears, you can select Music List, Photo List or Movie List in the MY MEDIA menu.

In USB device, you can not add a new folder or delete the existing folder.

After choosing the desired type of media, choose a device to open files from. The options are: USB device or DLNA.

- 1 Connect the USB device to the **USB IN 1** or **USB IN 2** jack on the TV.

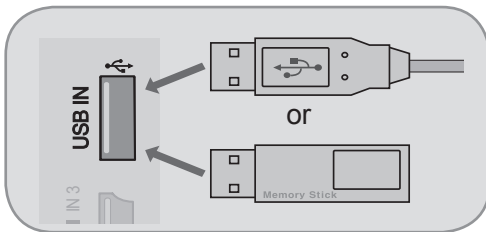

- Only photo(JPEG, MPO(Only 42/47/55LX6***, 47/55LX9***)), music (MP3) and movie(DAT, MPG, MPEG, VOB, AVI, DIVX, MP4, MKV, TS, TRP, TP, ASF, WMV) are supported.

- 2 Select **Movie List**, **Photo List** or **Music List**.

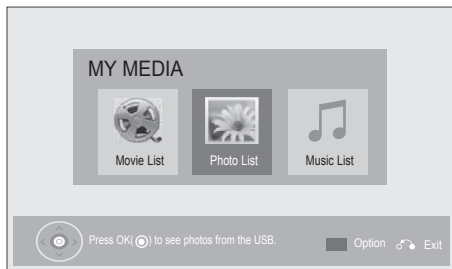

When removing the USB device

Select the **USB Device** menu before removing the USB device.

- 1 Select **USB Device**.
- 2 Select **Eject**.

- 3
- 4 Select the desired device.
- 5 **BLUE** Search other network device.

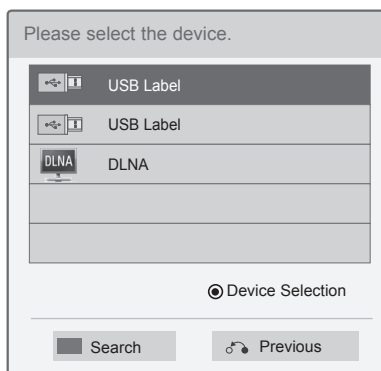

(Only 32/42/52LD56*, 32/37/42/47/55LD6**, 32/37/42/47/55LE55**, 32/37/42/47/55LE7***, 42/47/55LE8***, 42/47/55LX6***, 47/55LX9***)

- Press the **BACK** button to move to the previous menu screen.

Precautions when using the USB device

- ▶ Only a USB storage device is recognizable.
- ▶ If the USB storage device is connected through a USB hub, the device is not recognizable.
- ▶ A USB storage device using an automatic recognition programme may not be recognized.
- ▶ A USB storage device which uses its own driver may not be recognized.
- ▶ The recognition speed of a USB storage device may depend on each device.
- ▶ Please do not turn off the TV or unplug the USB device when the connected USB storage device is working. When such device is suddenly separated or unplugged, the stored files or the USB storage device may be damaged.
- ▶ Please do not connect the USB storage device which was artificially maneuvered on the PC. The device may cause the product to malfunction or fail to be played. Never forget to use only a USB storage device which has normal music files, image files or movie files.
- ▶ Please use only a USB storage device which was formatted as a FAT32 file system, NTFS file system provided with the Windows operating system. In case of a storage device formatted as a different utility programme which is not supported by Windows, it may not be recognized.
- ▶ Please connect power to a USB storage device(over 0.5 A) which requires an external power supply. If not, the device may not be recognized.
- ▶ Please connect a USB storage device with the cable offered by the device maker.
- ▶ Some USB storage devices may not be supported or operated smoothly.
- ▶ File alignment method of USB storage device is similar to Window XP and filename can recognize up to 100 English characters.
- ▶ Be sure to back up important files since data stored in a USB memory device may be damaged. We will not be responsible for any data loss.
- ▶ If the USB HDD does not have an external power source, the USB device may not be detected. So be sure to connect the external power source. - Please use a power adaptor for an external power source. We do not guarantee an USB cable for an external power source.
- ▶ If your USB memory device has multiple partitions, or if you use a USB multi-card reader, you can use up to 4 partitions or USB memory devices.
- ▶ If a USB memory device is connected to a USB multi-card reader, its volume data may not be detected.
- ▶ If the USB memory device does not work properly, disconnect and reconnect it.
- ▶ How fast a USB memory device is detected differs from device to device.
- ▶ If the USB is connected in Standby Mode, specific hard disk will automatically be loaded when the TV is turned on.
- ▶ The recommended capacity is 1 TB or less for a USB external hard disk and 32 GB or less for USB memory.
- ▶ Any device with more than the recommended capacity may not work properly.
- ▶ If a USB external hard disk with a "Energy Saving" function does not work, turn the hard disk off and on again to make it work properly.
- ▶ USB storage devices below USB 2.0 are supported as well. But they may not work properly in the movie list.
- ▶ Maximum of 999 folders or files can be recognized under one folder.
- ▶ The file arrangement of the USB storage device is similar to that of Windows XP and supports up to 100 alphabetical characters.
- ▶ If there are a lot of folders or files all within one folder, the device may not be able to access these properly.

TO USE A USB DEVICE

DLNA

About DLNA

This TV can display and play many types of movie, photo and music files from your DLNA server and has been certified by DLNA for photos.

The Digital Living Network Alliance (DLNA) is a cross-industry organization of consumer electronics, computing industry and mobile device companies. Digital Living provides consumers with easy sharing of digital media through a wired or wireless network in the home.

The DLNA certification logo makes it easy to find products that comply with the DLNA Interoperability Guidelines. This unit complies with DLNA Interoperability Guidelines v1.5. When a PC running DLNA server software or other DLNA compatible device is connected to this TV, some setting changes of software or other devices may be required. Please refer to the operating instructions for the software or device for more information.

Please refer to pages 79 ~ 107 for additional information on supported file types and other instructions.

! NOTE

- ▶ The supplied Nero MediaHome 4 Essentials CD-ROM is a customized software edition only for sharing files and folders to this TV.
- ▶ The supplied Nero MediaHome 4 Essentials software does not support following functions: Transcoding, Remote UI, TV control, Internet services and Apple iTunes
- ▶ This manual explains operations with the English version of Nero MediaHome 4 Essentials as examples. Follow the explanation referring to the actual operations of your language version.
- ▶ If there are a lot of folders or files all within one folder, the device may not be able to access these properly.
- ▶ For the DLNA option, use the Nero MediaHome programme that is provided with the TV. However, we cannot guarantee that third party programmes will work perfectly.
- ▶ You can select a channel while viewing the small preview channel list on your TV screen.
- ▶ Check your network settings when the DLNA option does not work properly.
- ▶ If there is an abnormal operation or an error occurs in Nero Media Home, the DLNA option may not work properly. In this case, exit Nero Media Home and restart the programme. You can download the latest version of Nero Media Home by clicking the question mark at the bottom-left of the programme.
- ▶ When the network is unstable, the device may be slower or may need to load during playback.
- ▶ When playing a video in DLNA mode, the Multi Audio and Closed Caption features are not supported.
- ▶ When selecting Full Screen in DLNA mode, the ratio of the outputted screen may differ from the original.
- ▶ When more than one TV is connected to a single server in DLNA mode, a file may not play properly, depending on the server performance.
- ▶ If the play time information is not provided by the server, it is displayed as "--:--:--."
- ▶ When using Movie List, DRM /*.tp /*.trp files in the DLNA server cannot be played.
- ▶ DLNA operation may not work properly according to the AP manufacturers.

Installing Nero MediaHome 4 Essentials

Nero MediaHome 4 Essentials is easy to use DLNA server software for Windows.

Requirement PC system before you install Nero MediaHome 4 Essentials

- Windows® XP (Service Pack 2 or higher), Windows Vista® (no Service Pack required), Windows® XP Media Center Edition 2005 (Service Pack 2 or higher), Windows Server® 2003
- Windows Vista® 64-bit edition (application runs in 32-bit mode)
- Hard drive space: 200 MB hard drive space for a typical installation of Nero MediaHome stand-alone
- 1.2 GHz Intel® Pentium® III or AMD Sempron™ 2200+ processors
- Memory: 256 MB RAM
- Graphics card with at least 32 MB video memory, minimum resolution of 800 x 600 pixels, and 16-bit color settings
- Windows® Internet Explorer® 6.0 or higher
- DirectX® 9.0c revision 30 (August 2006) or higher
- Network environment: 100 Mb Ethernet, WLAN (IEEE 802.11 b/g/n) (IEEE 802.11 n: Except for Russia)

- 1 Start up your computer, and insert the Nero MediaHome 4 Essentials CD-ROM into your computer's CD-ROM drive.
An installation wizard will walk you through the quick and uncomplicated installation process.
- 2 Close all Microsoft Windows programmes and exit any anti-virus software that may be running.
- 3 Insert the Nero MediaHome 4 Essentials CD-ROM into your computer's CD-ROM drive.
- 4 Click **Nero MediaHome 4 Essentials**. The installation is prepared and the installation wizard appears.
- 5 Click the **Next** button to display the serial number input screen.
Click **Next** to go to the next step.
- 6 If you accept all conditions, click **I accept the License Conditions** check box and click **Next**.
Installation is not possible without this agreement.
- 7 Click **Typical** and click **Next**. The installation process is started.
- 8 If you want to take part in the anonymous collection of data, select the check box and click the **Next** button.
- 9 Click the **Exit** button to complete the installation.

TO USE A USB DEVICE

Sharing files and folders

After installing Nero MediaHome, you must add folders you wish to share.

- 1 Double-click the **Nero MediaHome 4 Essentials** icon on the desktop.
- 2 Click **Network** icon on the left and define your network name in the **Network name** field. The Network name you enter will be recognized by your TV.
- 3 Click **Shares** icon on the left.
- 4 Click **Local Folders** tab on the **Shared** screen.
- 5 Click **Add** icon to open the **Browse Folder** window.
- 6 Select the folder containing the files you want to share. The selected folder is added to the list of shared folders.
- 7 Click **Start Server** icon to start the server.

! NOTE

- ▶ If the shared folders or files are not displayed on the TV, click the folder on the **Local Folders** tab and click **Rescan Folder** at the **More** button.
- ▶ Visit www.nero.com for more information and software tools.

Playing back shared contents

You can display and play movie, photo and music content stored on your computer or other DLNA media servers.

- 1 Start the server on your computer or other device that connected on your home network.



Select **MY MEDIA**.

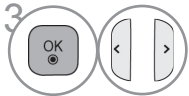

Select **Movie List**, **Photo List** or **Music List**.

Select the DLNA.

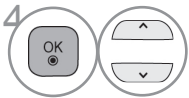

Depending on the media server, this TV may need to get the permission from the server.

If you want to re-scan available media server, press blue colour button.

! NOTE

- ▶ To play the file on the media server, the TV and the media server must be connected to the same access point.
- ▶ Because the compatibility and available playback functions on the **MY MEDIA** menu are tested on the bundle DLNA server (Nero MediaHome 4 Essentials) environment, file requirements and playback functions on the **MY MEDIA** may differ depending on media servers.
- ▶ The file requirements on this page are not always compatible. There may have some restrictions by file features and media server's ability.
- ▶ Even the files that are not supported can be displayed in photo thumbnail or music thumbnail.
- ▶ Movie thumbnail is not supported in DLNA Movie.
- ▶ If there is an unplayable music file in the **MY MEDIA** menu, the TV will skip the file and play next file.
- ▶ The file information indicated on the screen may not always correct for music and movie files in **MY MEDIA** menu
- ▶ This TV only supports movie subtitle files supplied by Nero MediaHome 4.
- ▶ The subtitle file name and movie file name have to be the same and located at the same folder.
- ▶ If subtitle files have been added after a directory has been indexed already, the user has to remove and re-add the folder to the list of shares.
- ▶ The playback and operating quality of the **MY MEDIA** function may be affected by your home network condition.
- ▶ The files from removable media such as USB drive, DVD-drive etc. on your media server may not share properly.
- ▶ When playing the Media through DLNA connection, it does not support the DivX file play which is protected by DRM.
- ▶ Up to 200 folders in one folder and 999 including folders and files can be recognized.
- ▶ If there are a lot of folders or files all within one folder, the device may not be able to access these properly.

TO USE A USB DEVICE

MOVIE LIST

You can play movie files on a USB storage device.

The movie list is activated once USB is detected. It is used when playing movie files on TV.

Displays the movies in the USB folder and supports Play.

Allows playback of all movies in the folder and user desired files.

It is a movie list that displays folder information and movie file.

The On Screen Display may be different from your TV. Images are an example to assist with the TV operation.

Movie(*.mpg/*.mpeg/*.dat/*.ts/*.trp/*.tp/*.vob/*.mp4/*.mov/*.mkv/*.divx/*.avi/*.asf/*.wmv/*.flv/*.avi(motion-jpeg)/*.mp4(motion-jpeg)/*.mkv(motion-jpeg))supporting file
Video format : DivX3.11, DivX4.12, DivX5.x, DivX6, Xvid1.00, Xvid1.01, Xvid1.02, Xvid1.03, Xvid1.10 beta-1/beta-2, Mpeg-1, Mpeg-2, Mpeg-4, H.264/AVC, VC1, JPEG, Sorenson H.263
Audio format : Dolby Digital, AAC, Mpeg, MP3, LPCM, HEAAC, ADPCM, WMA
Bit rate : within 32 kbps to 320 kbps(MP3)
External Subtitle format : *.smi/*.srt/*.sub(MicroDVD,Subviewer1.0/2.0)/*.ass/*.ssa/*.txt(TMPlayer)/*.psb(PowerDivX)
Internal Subtitle format : only, XSUB (It is the subtitle format used in DivX6 files)

- Some user-created subtitles may not work properly.
- Some special characters are not supported in subtitles.
- HTML tags are not supported in subtitles.
- Subtitles in languages other than the supported languages are not available.
- Changing font and colour in subtitles is not supported.
- Subtitles in languages other than one specified are not supported.
- Video files with subtitle files of 1 MB or larger may not be played properly.
- The screen may suffer temporary interruptions (image stoppage, faster playback, etc.) when the audio language is changed.
- A damaged movie file may not be played correctly, or some player functions may not be usable.
- Movie files produced with some encoders may not be played correctly.
- If the video and audio structure of recorded file is not interleaved, either video or audio is outputted.
- HD videos with a maximum of 1920x1080@25/30P or 1280x720@50/60P are supported, depending on the frame.
- Videos with resolutions higher than 1920x1080@25/30P or 1280x720@50/60P may not work properly depending on the frame.
- Movie files other than the specified types and formats may not work properly.
- **Max bitrate of playable movie file is 20 Mbps.** (only, Motion JPEG : 10 Mbps (Except for 32/42/52LD56*, 32/37/42/47/55LD6**, 32/37/42/47/55LE55**, 32/37/42/47/55LE7***, 42/47/55LE8***, 42/47/55LX6***, 47/55LX9***))
- We do not guarantee smooth playback of profiles encoded level 4.1 or higher in H.264/AVC.
- DTS Audio codec is not supported.
- A movie file more than 30 GB in file size is not supported for playback.
- A DivX movie file and its subtitle file must be located in the same folder.
- A video file name and its subtitle file name must be identical for it to be displayed.
- Playing a video via a USB connection that doesn't support high speed may not work properly.
- The movie file encoded by the GMC (Global Motion Compensation) and Qpel (Quarterpel Motion Estimation) is not supported.
- When you are watching the movie by Movie List function, you can adjust an image by **Energy Saving** and **AV Mode** key on the remote control. User setup for each image mode does not operate.
- Trick Mode does not support other functions than ►► if video files do not have index information.
- When playing video file using network, the Trick mode is limited to 2-times speed.
- Video file names that contain special characters may not be playable.

Supported DivX file

(Only 32/42/52LD56*, 32/37/42/47/55LD6**, 32/37/42/47/55LE55**, 32/37/42/47/55LE7***, 42/47/55LE8***, 42/47/55LX6***, 47/55LX9***)

File Extensions	A/V	Codec	Profile/Level Support	Explanation
.asf .wmv	Video	VC-1 Advanced Profile	Advanced Profile@Level 3 (e.g. 720p60, 1080i60, 1080p30)	Only streams compliant to SMPTE 421M VC-1 standard are supported.
		VC-1 Simple and Main Profiles	Simple Profile@Medium Level (e.g. CIF, QVGA) Main Profile@High Level (e.g. 1080p30)	
	Audio	WMA Standard		
		WMA 9 Professional		
.divx .avi	Video	DivX3.11	Advanced Simple Profile (e.g. 720p/1080i)	Global motion compensation or quarterpel motion estimation does not supported. Streams using this syntax are not supported.
		DivX4 DivX5 DivX6		
XViD	Main Profile@ Level 4.1 High Profile@ Level 4.1 (e.g. 720p60, 1080i60, 1080p30)			
H.264 / AVC				
	Audio	MPEG-1Layer I, II MPEG-1 Layer III(MP3) Dolby Digital		
.mp4 .m4v	Video	H.264 / AVC	Main Profile@ Level 4.1 High Profile@ Level 4.1 (e.g. 720p60, 1080i60, 1080p30)	Global motion compensation or quarterpel motion estimation does not supported. Streams using this syntax are not supported.
		MPEG-4 Part 2	Advanced Simple Profile (e.g. 720p/1080i)	
	Audio	AAC	AAC-LC and HE-AAC	
.mkv	Video	H.264 / AVC	Main Profile@ Level 4.1 High Profile@ Level 4.1 (e.g. 720p60, 1080i60, 1080p30)	Most of the MKV content available is encoded by the open source x264 codec.
	Audio	AAC Dolby Digital	AAC-LC and HE-AAC	
.ts .trp .tp	Video	H.264 / AVC	Main Profile@ Level 4.1 High Profile@ Level 4.1 (e.g. 720p60, 1080i60, 1080p30)	Only streams compliant to SMPTE 421M VC-1 standard are supported.
		MPEG-2	Main Profile@High Level(e.g. 720p60, 1080i60)	
VC-1	Simple Profile@Medium Level (e.g. CIF, QVGA) Main Profile@High Level (e.g. 1080p30) Advanced Profile@Level3 (e.g. 720p60, 1080i60, 1080p30)			
	Audio	MPEG-1Layer I, II MPEG-1 Layer III(MP3) Dolby Digital		
		AAC	AAC-LC and HE-AAC	
.vob	Video	MPEG-1	Main Profile@High Level (e.g. 720p60, 1080i60)	
		MPEG-2		
	Audio	Dolby Digital MPEG-1Layer I, II DVD-LPCM		
.mpg	Video	MPEG-1	Main Profile@High Level (e.g. 720p60, 1080i60)	Only streams compliant configured properly for TS, PS or ES
	Audio	MPEG-1Layer I, II		

TO USE A USB DEVICE



Supported DivX file





(Except for 32/42/52LD56*, 32/37/42/47/55LD6**, 32/37/42/47/55LE55**, 32/37/42/47/55LE7***, 42/47/55LE8***, 42/47/55LX6***, 47/55LX9***)

File Extension name	Video Decoder	Audio Codec	Max Resolution
mpg, mpeg	MPEG1, 2	MP2, MP3, Dolby Digital, LPCM	1920x1080@30p (only, Motion JPEG 640x480@30p)
dat	MPEG1	MP2	
ts, trp, tp	MPEG2, H.264/AVC, VC1	MP2, MP3, Dolby Digital, AAC, HE-AAC	
vob	MPEG1, 2	MP2, MP3, Dolby Digital, LPCM	
mp4, mov	MPEG4, DivX 3.11, DivX 4.12, DivX 5.x, DivX 6, Xvid 1.00, Xvid 1.01, Xvid 1.02, Xvid 1.03, Xvid 1.10-beta1/2, H.264/AVC	AAC, HE-AAC, MP3	
mkv	H.264/AVC, MPEG-1,2,4	MP2, MP3, Dolby Digital, AAC HE-AAC, LPCM	
divx, avi	MPEG2, MPEG4, DivX 3.11, DivX 4.DivX 5, DivX 6, Xvid 1.00, Xvid 1.01, Xvid 1.02, Xvid 1.03, Xvid 1.10-beta1/2b H.264/AVC	MP2, MP3, Dolby Digital, LPCM, ADPCM, AAC, HE-AAC	
Motion JPEG (avi, mp4, mkv)	JPEG	LPCM, ADPCM	
asf, wmv	VC1	WMA	
flv	Sorenson H.263, H264	MP3, AAC	

Screen Components

You can also adjust **USB** in the **INPUT** menu.

1   Select **MY MEDIA**.

2     Select **Movie List**.

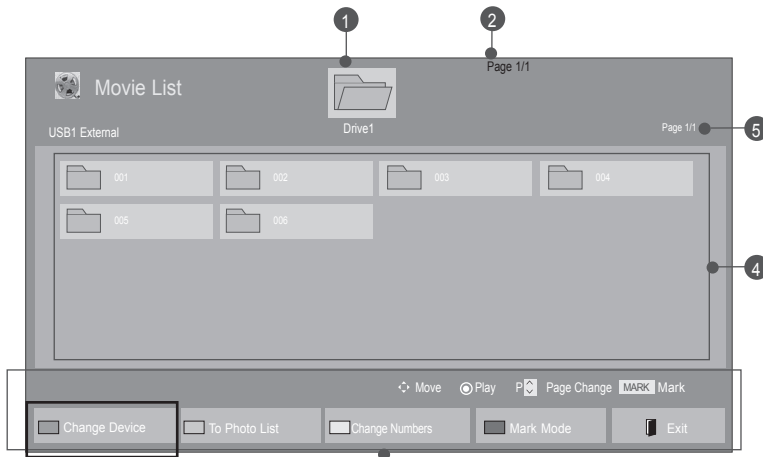



- 1 Moves to upper level folder
- 2 Current page/Total pages
- 3 Corresponding buttons on the remote control
- 4 Contents under the folder focused on 1
- 5 Current page/ total pages of contents under the folder focused on 1

Only 32/42/52LD56*, 32/37/42/47/55LD6**,
 32/37/42/47/55LE55**, 32/37/42/47/55LE7***,
 42/47/55LE8***, 42/47/55LX6***, 47/55LX9***

TO USE A USB DEVICE

- Some files may be displayed the preview image by icon only.

- Non-supported files are displayed the preview image by icon only.



- Abnormal files are displayed in the form of bitmap.





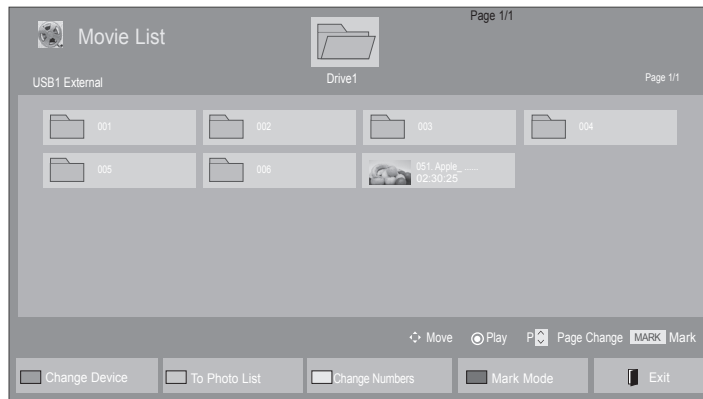

TO USE A USB DEVICE

Movie Selection







■ When playing movie files



- 1  Select the target folder or drive.
- 2   Select the desired movie title.
- 3  Movie files are played.







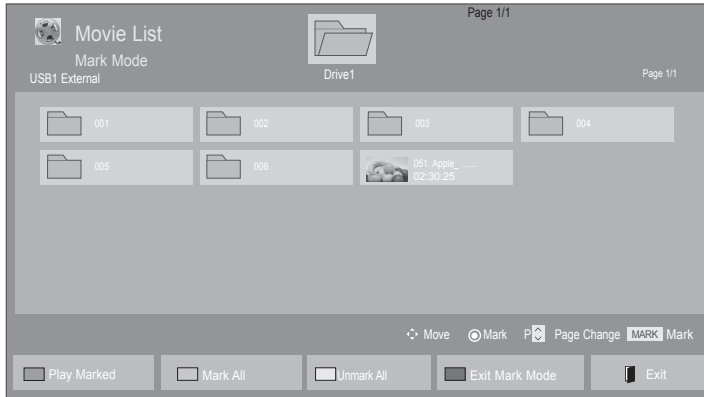

• Use the **P** ^ v button to navigation in the movie page.

Using the remote control

	Change device. (Only 32/42/52LD56*, 32/37/42/47/55LD6**, 32/37/42/47/55LE55**, 32/37/42/47/55LE7***, 42/47/55LE8***, 42/47/55LX6***, 47/55LX9***)
	Repeatedly, press the GREEN button to converted to Photo List->Music List .
	A method to view in 5 large thumbnail or simple list.
	Convert to Mark Mode .
	Return to normal TV viewing.
	Press the PLAY (▶) button to return to normal playback.

■ When selected movie files are played







-  Select the target folder or drive.
-   Select the desired movie title.
-  or  Convert to **Mark Mode**.
-   Mark desired Movie file.
-  Marked movie file is played.

- When one or more movie files are marked, the marked movies will be played in sequence.

TO USE A USB DEVICE

Using the remote control

	Play the selected movie file. Once a movie file finishes playing, the next selected one will be played automatically.
	Mark all movie files on the screen.
	Deselect all marked movie files.
	Exit the Mark Mode .
	Return to normal TV viewing.

! NOTE



- ▶ If you select “Yes” from OSD when playing the same file after the movie file has been stopped, it will restart where it stopped previously.
- ▶ If continuous series files exist within the folder, the next file will automatically be played. But, this excludes cases when the **Repeat** function of Movie List Option is turned “**On**” (Refer to p. 91) or when set as Marked Play.
- ▶ In the case where files are not validated, a message will appear regarding invalid file.

Using the Movie List function, play

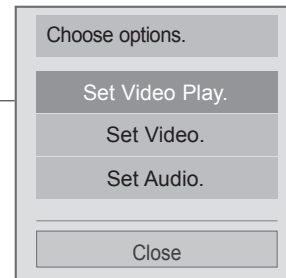

■ Image shown may differ from your TV.









- 1  or  Show the **Option** menu.
- 2  Select **Set Video Play.**, **Set Video.** or **Set Audio.** or **Set 3D video**(Only 42/47/55LX6***, 47/55LX9***).

! NOTE

- ▶ Option values changed in **Movie List** does not affect **Photo List** and **Music List**.
- ▶ Option value changed in **Photo List** and **Music List** are changed likewise in **Photo List** and **Music List** excluding **Movie List**.
- ▶ When replaying the video file after stopping, you can play from where it stopped previously.



TO USE A USB DEVICE

Using the remote control

■	Stop the playing movie file.
▶	Press the PLAY(▶) button to return to normal playback.
	<p>During playback, press the Pause() button.</p> <ul style="list-style-type: none"> ■ Still screen is displayed. ■ If no buttons are pressed on the remote control for 10 minutes after pausing, the TV returns to the playback state. ■ Press the Pause() button and then use the FF(▶▶) button for slow motion.
◀◀ / ▶▶	<p>When playing,</p> <p>repeatedly, press the REW(◀◀) button to speed up ◀◀(x2) -> ◀◀◀(x4) -> ◀◀◀◀(x8) -> ◀◀◀◀◀(x16) -> ◀◀◀◀◀◀(x32) .</p> <p>repeatedly, press the FF(▶▶) button to speed up ▶▶(x2)-> ▶▶▶(x4) -> ▶▶▶▶(x8) ->▶▶▶▶▶(x16) -> ▶▶▶▶▶▶(x32).</p> <ul style="list-style-type: none"> ■ Pressing these buttons repeatedly increases the fast forward/reverse speed.
 OR 	Show the Option menu.
	<p>Hide the menu on the full-sized screen.</p> <ul style="list-style-type: none"> ■ To see the menu again on the full-sized screen, press OK button to display.
	Return to normal TV viewing.
◀ >	<ul style="list-style-type: none"> ■ When using the < or > button during playback a cursor indicating the position can be viewed on the screen.
	Press the ENERGY SAVING button repeatedly to change the brightness of your screen.(Refer to p. 119)
	Press the AV MODE button repeatedly to select the desired source.(Refer to p. 55)

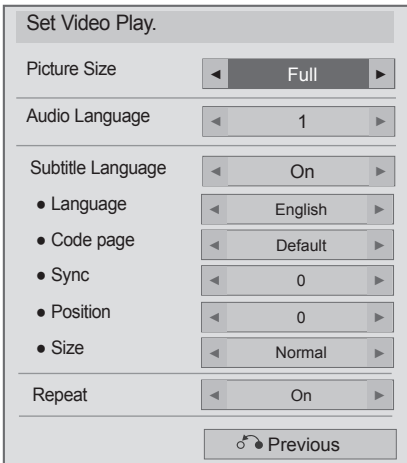
■ **When you select the Set Video Play,**



- 1   **Select Picture Size, Audio Language, Subtitle Language or Repeat.**
- 2  **Make appropriate adjustments.**

Subtitle Language	Support Language
Latin1	English, French, Spanish, Portuguese, Malaysia, Indonesia
Cyrillic	Russian
Thai	Thai
Hebrew	Hebrew
Arabic	Arab, Parsi, Krudish
Unicode(UTF-16)	Vietnamese language

- ▶ **Picture Size** : Selects your desired picture format during movie play.
- ▶ **Audio Language** : Changes the Language Group of the audio during movie play. Files with a single audio track cannot be selected.
- ▶ **Subtitle Language** : Turn on/off the subtitle.
- ▶ **Language** : Activated for SMI subtitle and can select the language within the subtitle.
- ▶ **Code page** : Can select the font for subtitle. When set to default, same font as general menu will be used.
- ▶ **Sync** : Adjusts the time synchronisation of the subtitle from -10 secs to +10 secs by steps of 0.5 secs during movie play.
- ▶ **Position** : Changes the position of the subtitle either up or down during movie play.
- ▶ **Size** : Selects your desired Subtitle size during movie play.
- ▶ **Repeat** : Turn on/off repeat function of movie playback. When turned on, the file within the folder will be played back repeatedly. Even when the repeated playback is turned off, it can run the playback if the file name is similar to the previous file.

NOTE

- ▶ Only 10,000 of sync blocks can be supported within the subtitle file.
- ▶ When playing a video, you can adjust the Picture Size by pressing the **RATIO** button.

TO USE A USB DEVICE

■ When you select the Set Video,

■ Image shown may differ from your TV.

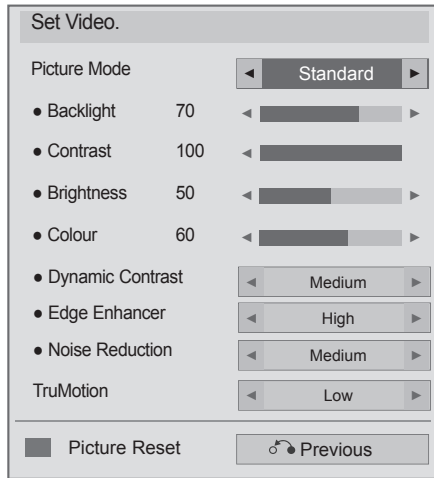



1   Select **Picture Mode** or **TruMotion**.

2  Make appropriate adjustments. (Refer to p. 120 to 129)

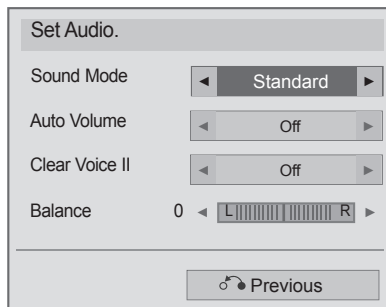
■ When you select the Set Audio,



1   Select **Sound Mode, Auto Volume, Clear Voice II** or **Balance**.

2  Make appropriate adjustments. (Refer to p. 133 to 137)

■ When you select the Set 3D video, (Only 42/47/55LX6***, 47/55LX9***)



For more information, see the 3D Imaging section in the Owner's Manual.

PHOTO LIST

You can view photo files on USB storage device.

The On Screen Display may be different from your TV. Images are an example to assist with the TV operation. When you are watching the photo by the Photo List function, you can not change the picture mode.

PHOTO(*.JPEG) supporting file

Baseline : 64 x 64 to 15360 x 8640

Progressive : 64 x 64 to 1920 x 1440

- You can play JPEG files only.
- Non-supported files are displayed in the form of predefined icon.
- An error message occurs for corrupted files or file formats that cannot be played.
- Corrupted image files may not be displayed properly.
- It may take some time to view high-resolution images in full screen.

Only 42/47/55LX6***, 47/55LX9***

	File Extensions	Item	Profile
2D	jpeg jpg jpe	supproted file format	SOF0: baseline SOF1: Extend Sequential SOF2: Progressive
		photo size	Min: 64 x 64 Max - Normal Type: 15360 (W) x 8640 (H) Progressive Type: 1920 (W) x 1440 (H)
3D	mpo	supproted file format	mpo
		photo size	4:3 size: 3,648 x 2,736 2,592 x 1,944 2,048 x 1,536 3:2 size: 3,648 x 2,432

Screen Components

You can also adjust **USB** in the **INPUT** menu.

1

Select **MY MEDIA**.

2

Select **Photo List**.

1 Moves to upper level folder

2 Current page/Total pages

3 Corresponding buttons on the remote control

4 Contents under the folder focused on 1

5 Current page/ total pages of contents under the folder focused on 1





Only 32/42/52LD56*, 32/37/42/47/55LD6**,
32/37/42/47/55LE55**, 32/37/42/47/55LE7***,
42/47/55LE8***, 42/47/55LX6***, 47/55LX9***

TO USE A USB DEVICE

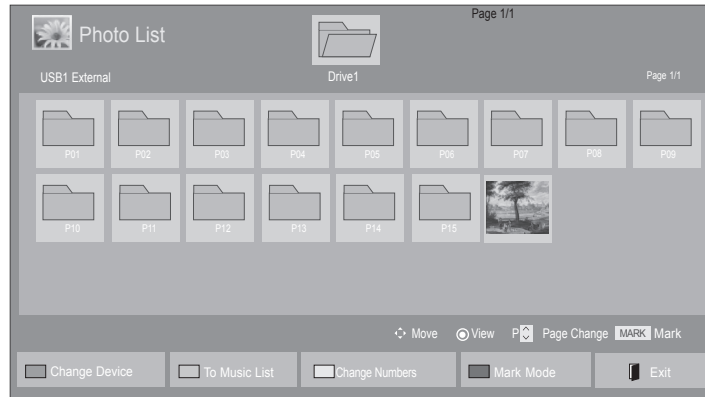
Photo Selection





■ When playing photo files



- 1  Select the target folder or drive.
- 2   Select the desired photos.
- 3  Photo files are displayed.

• Use the **P** ^ v button to navigation in the photo page.

Using the remote control

	Change device. (Only 32/42/52LD56*, 32/37/42/47/55LD6**, 32/37/42/47/55LE55**, 32/37/42/47/55LE7***, 42/47/55LE8***, 42/47/55LX6***, 47/55LX9***)
	Repeatedly, press the GREEN button to converted to Music List->Movie List .
	A method to view in 5 large thumbnail or simple list.
	Convert to Mark Mode .
	Return to normal TV viewing.

■ When selected photo files are displayed

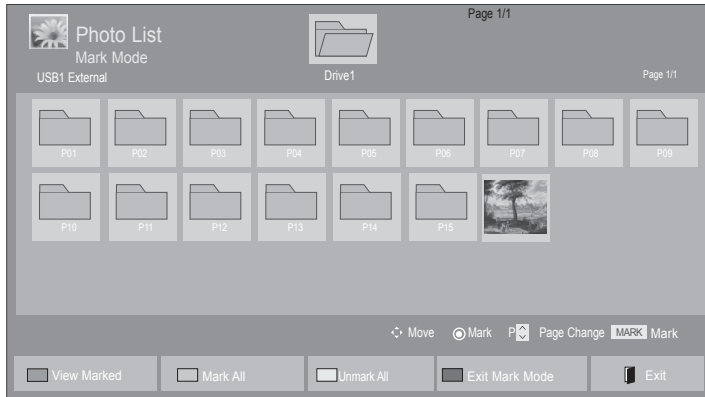

- 1 Select the target folder or drive.
- 2 Select the desired photos.
- 3 or Convert to **Mark Mode**.
- 4 Mark desired photo file.
- 5 Marked photo file is displayed.

• When one or more photos are marked, you can view each marked photo or a slide show of the marked photos. If no photos are marked, you can view every individual photo in the folder or a slide show of all photos in the folder.

Using the remote control

	Display the selected photo file.
	Mark all photo files on the screen.
	Deselect all marked photo files.
	Exit the Mark Mode .
	Return to normal TV viewing.

TO USE A USB DEVICE

How to view photo

Detailed operations are available on full-sized photo view screen.

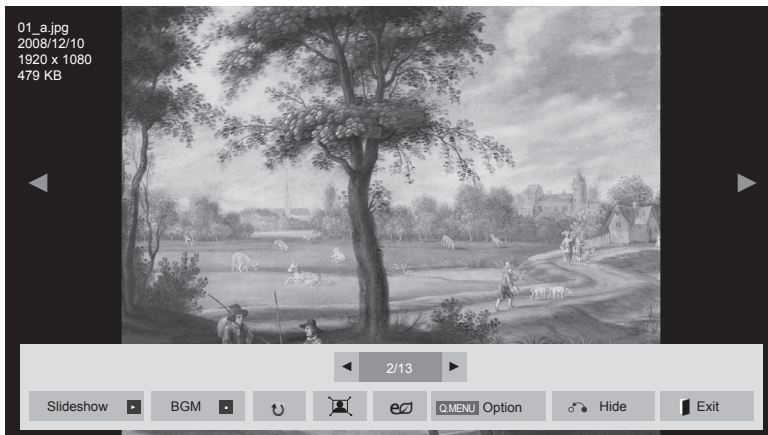
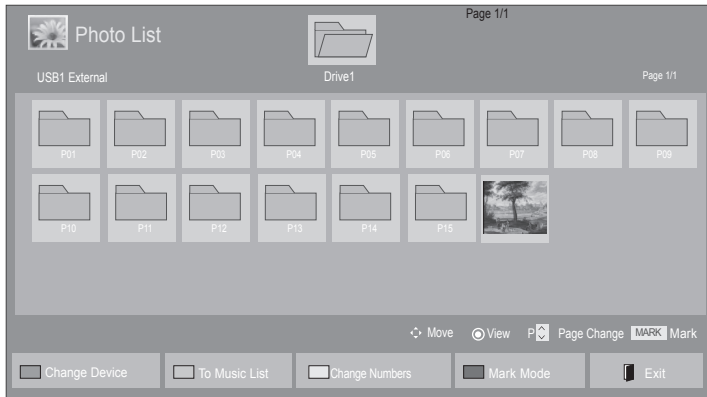

The aspect ratio of a photo may change the size of the photo displayed on the screen in full size. Press the **EXIT** button to move to the previous menu screen.



→ (Only 32/42/52LD56*, 32/37/42/47/55LD6**, 32/37/42/47/55LE55**, 32/37/42/47/55LE7***, 42/47/55LE8***, 42/47/55LX6***, 47/55LX9***)

or

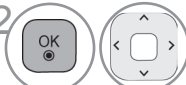

→ (Except for 32/42/52LD56*, 32/37/42/47/55LD6**, 32/37/42/47/55LE55**, 32/37/42/47/55LE7***, 42/47/55LE8***, 42/47/55LX6***, 47/55LX9***)

TO USE A USB DEVICE

- 1  Select the target folder or drive.
- 2  Select the desired photos.
- 3  The selected photo is displayed in full size.

• Use the **P** ^ v button to navigation in the photo page.

- Press the **EXIT** button to go back to Photo List.
- Press the **BACK** button to make Help OSD disappear.

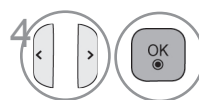

Select the **Slideshow**, **BGM**, **⤵ (Rotate)**, **🖼️/📐 (or 🔍)**, **⏻**, **Option**, **Hide** or **Exit**.

- Use < > button to select the previous or next photo.
- Use < > button to select and control the menu on the full-sized screen.

- ▶ **Slideshow** : When no picture is selected, all photos in the current folder are displayed during slide show. If some photos are selected, those photos are displayed in a slide show.
 - Set the time interval of the slide show in **Option**.
- ▶ **BGM** (Background Music) : Listen to music while viewing photos in full size.
 - Set the BGM device and album in Options before using this function.
 - You can adjust **Option** by **Q.MENU** or **MENU** button on the remote control.
- ▶ **⤵ (Rotate)** : Rotate photos.
 - Rotates the photo 90°, 180°, 270°, 360° clockwise.
 - It can not be rotate when the width of a picture is bigger than supported height.
- ▶ **🔍 (ZOOM IN)**: View the photo by zoom in 2, 4 times.
- ▶ **🖼️/📐** : View the photo in full mode or original mode.
- ▶ **⏻** : Press the **ENERGY SAVING** button repeatedly to change the brightness of your screen.(Refer to p. 119)
- ▶ **Option** : Set values for **Slide Speed** and **BGM**.
 - Use ^ v < > button and **OK** button to set values. Press **OK** to save the settings.
 - You cannot change **BGM** while BGM is playing.
 - You can only select the MP3 folder saved on the device that currently displays the photo.
- ▶ **Hide** : Hide the menu on the full-sized screen.
 - To see the menu again on the full-sized screen, press **OK** button to display.

Press the **EXIT** button to go back to **Photo List**.



TO USE A USB DEVICE

Using the Photo List function

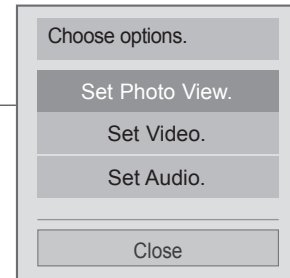

■ Image shown may differ from your TV.



1  or  Show the **Option** menu.

2  Select **Set Photo View.**, **Set Video.** or **Set Audio.** or **Set 3D video**(Only 42/47/55LX6***, 47/55LX9***).

NOTE

- ▶ Option values changed in **Movie List** does not affect **Photo List** and **Music List**.
- ▶ Option value changed in **Photo List** and **Music List** are changed likewise in **Photo List** and **Music List** excluding **Movie List**.

■ When you select the **Set Photo View**,

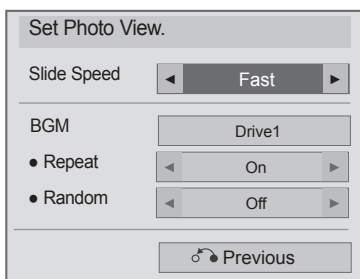

1   Select **Slide Speed** or **BGM**.

2  Make appropriate adjustments.

■ **When you select the Set video,**

■ Image shown may differ from your TV.

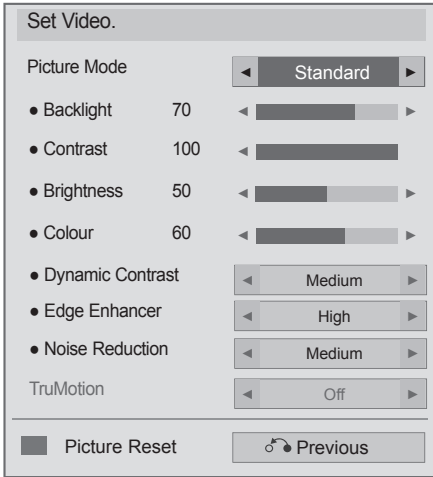



1   Select **Picture Mode** or **TruMotion**.

2  Make appropriate adjustments. (Refer to p. 120 to 129)

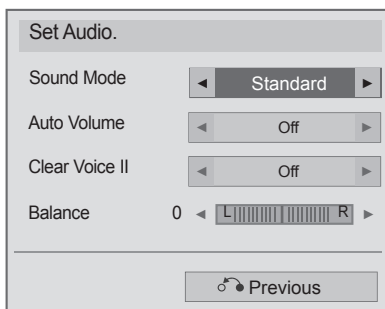
■ **When you select the Set Audio,**



1   Select **Sound Mode, Auto Volume, Clear Voice II** or **Balance**.

2  Make appropriate adjustments. (Refer to p. 133 to 137)

■ **When you select the Set 3D video,**
(Only 42/47/55LX6***, 47/55LX9***)



For more information, see the 3D Imaging section in the Owner's Manual.

TO USE A USB DEVICE

MUSIC LIST

You can play music files on USB storage device.

Purchased music files(*.MP3) may contain copyright restrictions. Playback of these files may not be supported by this model.

Music file on your USB device can be played by this unit.

The On Screen Display may be different from your TV. Images are an example to assist with the TV operation.

MUSIC (*.MP3) supporting file

Bit rate 32 to 320

- Sampling rate MPEG1 Layer3 : 32 kHz, 44.1 kHz, 48 kHz
- Sampling rate MPEG2 Layer3 : 16 kHz, 22.05 kHz, 24 kHz
- Sampling rate MPEG2.5 Layer3 : 8 kHz, 11.025 kHz, 12 kHz

Except 32/42/52LD56*, 32/37/42/47/55LD6**,
32/37/42/47/55LE55**, 32/37/42/47/55LE7***,
42/47/55LE8***, 42/47/55LX6***, 47/55LX9***

Screen Components

You can also adjust **USB** in the **INPUT** menu.

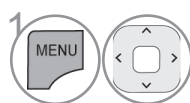

Select **MY MEDIA**.

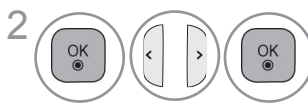

Select **Music List**.

1 Preview: If any album jacket for the file(Album Art Image) exists, this jacket is displayed.

2 Moves to upper level folder

3 Current page/Total pages

4 Corresponding buttons on the remote control

5 Contents under the folder focused on 2

6 Current page/ total pages of contents under the folder focused on 2

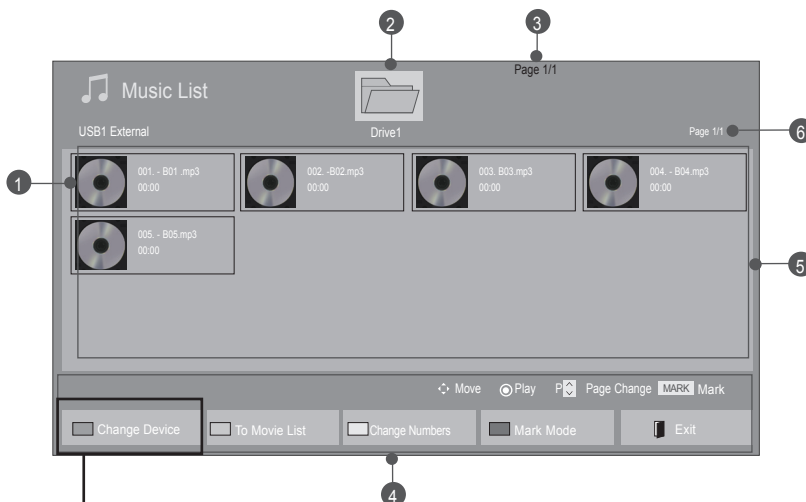



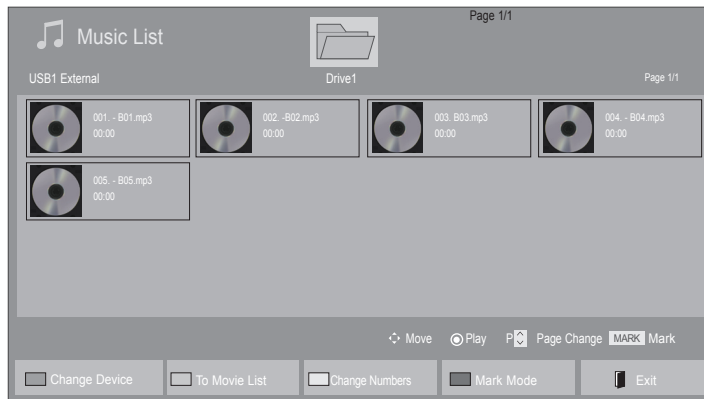

Only 32/42/52LD56*, 32/37/42/47/55LD6**,
32/37/42/47/55LE55**, 32/37/42/47/55LE7***,
42/47/55LE8***, 42/47/55LX6***, 47/55LX9***

Music Selection







■ When playing music files

- 1  Select the target folder or drive.
- 2   Select the desired music title.
- 3  Music files are played.

• Use the **P** ^ v button to navigate up/down in the music page.







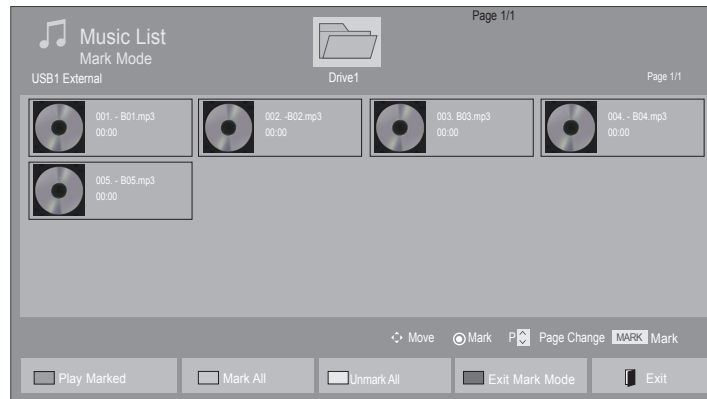

Using the remote control

	Change device. (Only 32/42/52LD56*, 32/37/42/47/55LD6**, 32/37/42/47/55LE55**, 32/37/42/47/55LE7***, 42/47/55LE8***, 42/47/55LX6***, 47/55LX9***)
	Repeatedly, press the GREEN button to converted to Movie List->Photo List .
	A method to view in 5 large thumbnail or simple list.
	Convert to Mark Mode .
	Return to normal TV viewing.

TO USE A USB DEVICE





■ When selected music files are played



- 1  Select the target folder or drive.
- 2   Select the desired music title.
- 3  or  Convert to **Mark Mode**.
- 4   Mark desired music file.
- 5  Marked music file is played.



- When one or more music files are marked, the marked music title will be played in sequence. For example, if you want to listen to only one music repeatedly, just mark the music only and play it. If no music is marked, all the music in the folder will be played in sequence.
- If you want to activate Random playback, you must set **Option->Set audio play.->Random to On**.

Using the remote control

	Play the selected music file.
	Mark all music files on the screen.
	Deselect all marked music files.
	Exit the Mark Mode .
	Return to normal TV viewing.

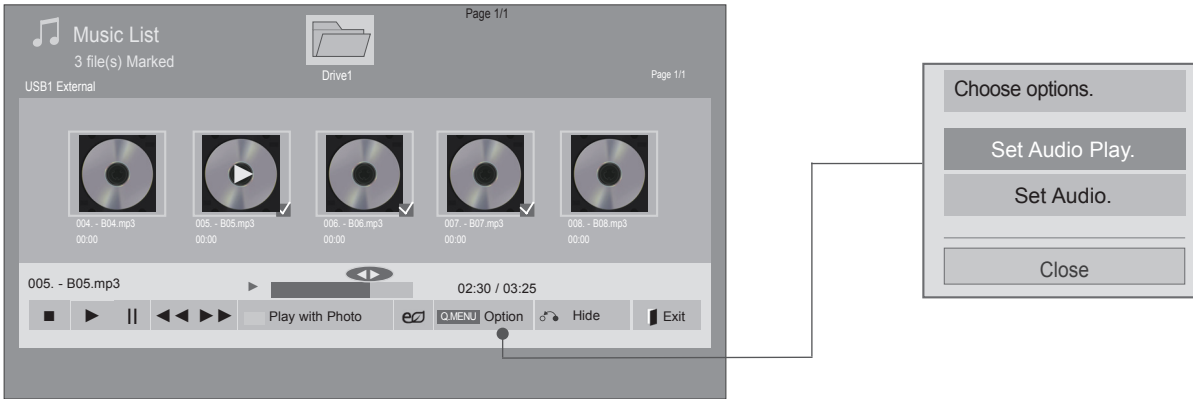
Using the Music List function, play



1  or  Show the **Option** menu.











2  Select **Set Audio Play.** or **Set Audio.**

NOTE

- ▶ Option values changed in Movie List does not affect Photo List and Music List.
- ▶ Option value changed in Photo List and Music List are changed likewise in Photo List and Music List excluding Movie List.
- ▶ You can listen to the music only within the device currently played.

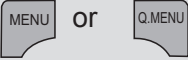
TO USE A USB DEVICE



Using the remote control

	Stop the playing music file.
	Press the PLAY(▶) button to return to normal playback.
	When you press the Pause(II) button while playing the file, the playback will be paused. When you press the Pause(II) button again while the playback is paused, it will resume the playback.
	When playing, When you press the REW(◀◀) button, the previous music file will be played. When you press the FF(▶▶) button, the next music file will be played.
	Start playing the selected music files and then move to the Photo List .
	Press the ENERGY SAVING button repeatedly to change the brightness of your screen.(Refer to p. 119) Only Off/Screen Off operates from the Movie List, Photo List, Music List.
	Show the Option menu.
	<ul style="list-style-type: none"> ■ When you press the Back button while the music is playing, the music player currently playing will be hidden and only the music list will be displayed.
	<ul style="list-style-type: none"> ■ When you press the Exit button while the Music player is displayed, only the music will be stopped and the player will not return to normal TV viewing. ■ When you press the Exit button while the music is stopped or while the music player is hidden, the player will return to normal TV viewing.
	<ul style="list-style-type: none"> ■ When using the < or > button during playback a cursor indicating the position can be played.

TO USE A USB DEVICE

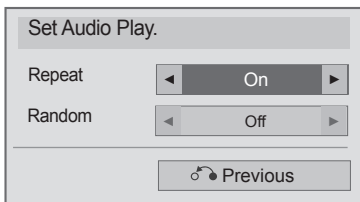

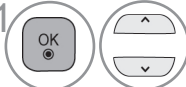
■ When you select the Set Audio Play,

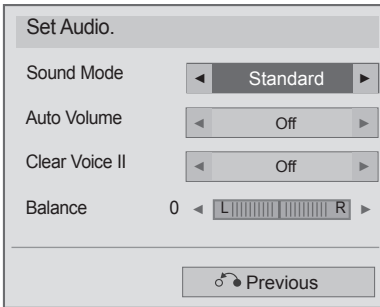

-  Select **Repeat** or **Random**.
-  Make appropriate adjustments.

■ When you select the Set Audio,



- 1   Select **Sound Mode, Auto Volume, Clear Voice II** or **Balance**.
- 2  Make appropriate adjustments. (Refer to p. 133 to 137)

- If you don't press any button for a while during the playing, the play information box (as shown in the below) will float as a screen saver.
- The 'Screen Saver'?
Screen saver is to prevent screen pixel damage due to a fixed image remaining on the screen for a extended period of time.

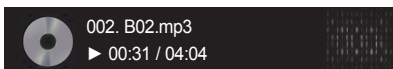

! NOTE

- ▶ A damaged or corrupted music file does not play but displays 00:00 in playtime.
- ▶ A music file downloaded from a paid service with copyright protection does not start but displays inappropriate information in playtime.
- ▶ If you press OK, ■ buttons, screen saver is stopped.
- ▶ The PLAY(▶), Pause(II), ■, ▶▶, ◀◀ buttons on the remote control are also available in this mode.
- ▶ You can use the ▶▶ button to select the next music file and the ◀◀ button to select the previous music file.

TO USE A USB DEVICE

DIVX REGISTRATION CODE

Confirm the DivX registration code number of the TV. Using the registration number, movies can be rented or purchased at www.divx.com/vod.

With a DivX registration code from other TV, playback of rented or purchased DivX file is not allowed. (Only DivX files matched with the registration code of the purchased TV are playable.)

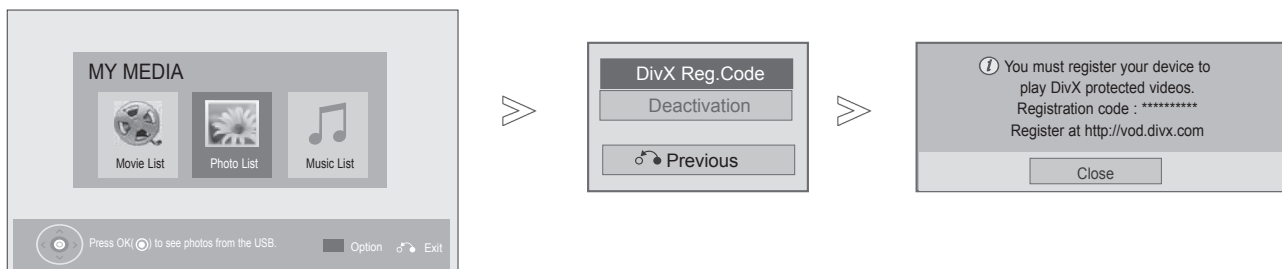

1 Select **MY MEDIA**.

2 Select **DivX Reg. Code**.

3 Display DivX Reg. Code. • Press the **MENU/EXIT** button to return to normal TV viewing.



ABOUT DIVX VIDEO: DivX® is a digital video format created by DivX, Inc. This is an official DivX Certified device that plays DivX video. Visit www.divx.com for more information and software tools to convert your files into DivX video.

ABOUT DIVX VIDEO-ON-DEMAND: This DivX Certified® device must be registered in order to play DivX Video-on-Demand (VOD) content. To generate the registration code, locate the DivX VOD section in the device setup menu. Go to vod.divx.com with this code to complete the registration process and learn more about DivX VOD.

“DivX Certified® to play DivX® video up to HD 1080p, including premium content”

“DivX®, DivX Certified® and associated logos are registered trademarks of DivX, Inc. and are used under license.”

“Pat. 7,295,673; 7,460,668; 7,515,710; 7,519,274”

! NOTE

► Movie files are supported as follows

Resolution : under 1920x1080 WxH pixels

Frame rate : under 30 frames/sec(1920x1080), under 60 frames/sec(under 1280x720)







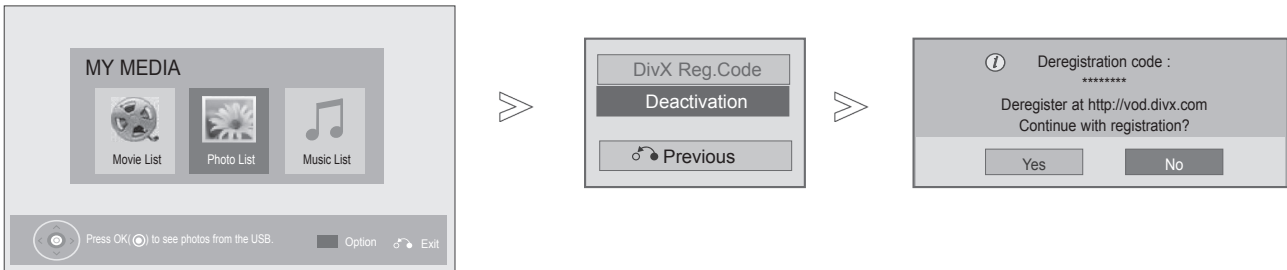

► Video Codec : MPEG 1, MPEG 2, MPEG 4, H.264/AVC, DivX 3.11, DivX 4.12, DivX 5.x, DivX 6, Xvid 1.00, Xvid 1.01, Xvid 1.02, Xvid 1.03, Xvid 1.10-beta1, Xvid 1.10-beta2, JPEG, VC1, Sorenson H.263/H.264

► The DRM/* .tp /* .trp file in DLNA server is not played when Movie List is in operation.

DEACTIVATION

The purpose of deactivation is to allow deactivation of devices for users who have activated all the available devices through the web_server and are blocked from activating more devices. DivX VOD allowed the consumer to activate up to 6 devices under one account, but to replace or deactivate any of those devices, the consumer had to contact DivX Support and request deletion. Now with this added feature, consumers will be able to deactivate the device themselves and hence better manage their DivX VOD devices.



- 1   Select **MY MEDIA**.
- 2    Select **Deactivation**.
- 3   Select **Yes**.
- 4  Display **Deactivation**.

- Press the **MENU/EXIT** button to return to normal TV viewing.
- Press the **BACK** button to move to the previous menu screen.





GAME

GAME

(Only 32/42/52LD56*, 32/37/42/47/55LD6**, 32/37/42/47/55LE55**, 32/37/42/47/55LE7***, 42/47/55LE8***, 42/47/55LX6***, 47/55LX9***)

Allows you to enjoy the games installed on the TV.



-   Select **GAME**.
-   Select the desired game.
-  Enter the selected game mode.

- Press the **EXIT** button to return to normal TV viewing.

EPG(ELECTRONIC PROGRAMME GUIDE) (IN DIGITAL MODE)

(Except New Zealand)

This system has an Electronic Programme Guide (EPG) to help your navigation through all the possible viewing options.

The EPG supplies information such as programme listings, start and end times for all available services. In addition, detailed information about the programme is often available in the EPG (the availability and amount of these programme details will vary, depending on the particular broadcaster).

This function can be used only when the EPG information is broadcast by broadcasting companies. You must set the Clock in the **Time** menu, before using EPG function.

The EPG displays the programme details for 8 days.

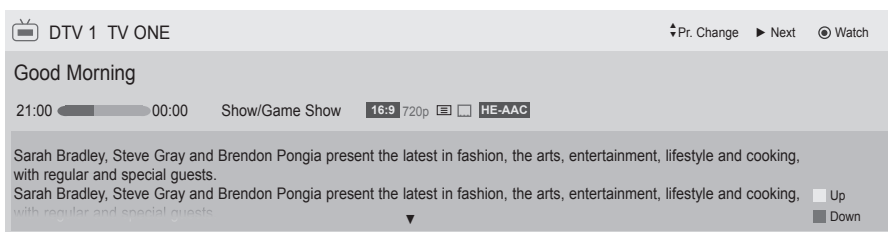

INFO Shows current programme information

	Displayed with a TV or DTV Programme.		Displayed with a Teletext Programme.
	Displayed with a Radio Programme.		Displayed with a Subtitle Programme.
	Displayed with a MHEG Programme.		Displayed with a Scramble Programme.
	Displayed with a HE-AAC Programme.		Displayed with a Dolby Digital Programme.
	Aspect ratio of broadcasting programme.		Displayed with a Dolby Digital PLUS Programme.
	Aspect ratio of broadcasting programme.		576i/p, 720p, 1080i/p : Resolution of broadcasting programme

Shows next programme information.

Shows other programme information.

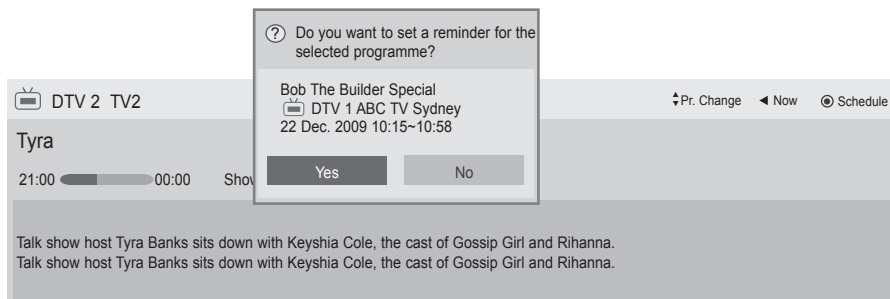

A pop-up window for remind settings appear.

Select Timer Remind setting mode.

EPG(ELECTRONIC PROGRAMME GUIDE)(IN DIGITAL MODE)

SWITCH ON/OFF EPG

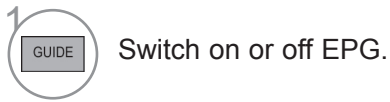



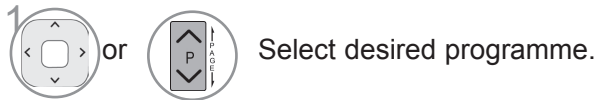



SELECT A PROGRAMME

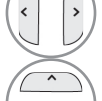
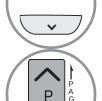

BUTTON FUNCTION IN NOW/NEXT GUIDE MODE

You can view a programme being broadcasted and one scheduled to follow.





-  **RED** Change EPG mode.
-  **YELLOW** Enter Manual Timer mode.
-  **BLUE** Enter Schedule List mode.
-  When 'Now' is selected, it is moved to selected programme and EPG disappears
-  When 'Next' is selected, a reservation pop-up window appears.
-  Select NOW or NEXT Programme.
-  Select the Broadcast Programme.
-  Page Up/Down.

Programme Guide

That '70s show 25 Nov. 2008 09:45~10:15

ALL	NOW	NEXT
DTV 1 YLE TV1	That '70s show	Keno
DTV 2 YLE TV2	Your World Today	World Business
DTV 4 TV..	Legenen om Den....	Fantomen
DTV 5 YLE FST	Naturtimmen	Kritiskt
DTV 6 CNN	Lyssna	ABC
DTV 8 YLE24	Glamour	Tänään otsikoissa

FAV Favourite INFO Information Watch/Schedule TV/RAD RADIO
Mode Manual Timer Schedule List

-  or  or  Switch off EPG.
-  Select DTV or RADIO Programme.
-  Detail information on or off.

BUTTON FUNCTION IN 8 DAY GUIDE MODE

RED Change EPG mode.

GREEN Enter Date setting mode.

YELLOW Enter Manual Timer mode.

BLUE Enter Schedule List mode.

When 'Currently broadcasting programme' is selected, it is moved to selected programme and EPG disappears

When 'Future broadcasting programme' is selected, a reservation pop-up window appears.

Select Programme.

Select the Broadcast Programme.

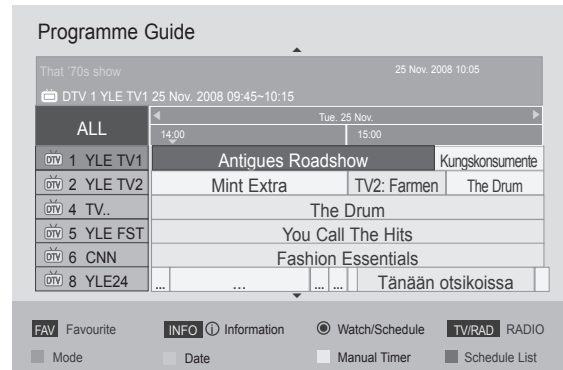

Page Up/Down.

Switch off EPG.

Select DTV or RADIO Programme.

Detail information on or off.

BUTTON FUNCTION IN DATE CHANGE MODE

Switch off Date setting mode.

Change to the selected date.

Select a date.

Switch off EPG.

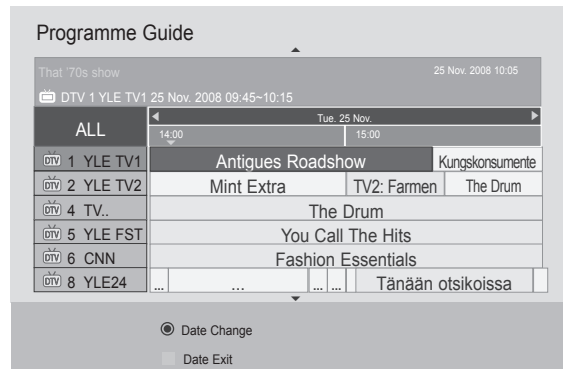

MHEG (MULTIMEDIA AND HYPERMEDIA INFORMATION CODING EXPERT GROUP)(IN DIGITAL MODE)

(Only South Africa, Malaysia)

The TV gives you access to digital teletext which is greatly improved in various aspects such as text, graphics etc.

This digital teletext can access special digital teletext services and specific services which broadcast digital teletext.

TELETEXT WITHIN DIGITAL SERVICE

- 1 Press the numeric or **P** ^ v button to select a digital service which broadcasts digital teletext.
- 2 Follow the indications on digital teletext and move onto the next step by pressing **TEXT**, **OK**, ^ v < >, **RED**, **GREEN**, **YELLOW**, **BLUE** or **NUMBER** buttons and etc..
- 3 To change digital teletext service, select a different service by the numeric or **P** ^ v button.



TELETEXT IN DIGITAL SERVICE

- 1 Press the numeric or **P** ^ v button to select a certain service which broadcasts digital teletext.
- 2 Press the **TEXT** or coloured button to switch on teletext.
- 3 Follow the indications on digital teletext and move onto the next step by pressing **OK**, ^ v < >, **RED**, **GREEN**, **YELLOW**, **BLUE** or **NUMBER** buttons and so on.
- 4 Press the **TEXT** or colour button to switch off digital teletext and return to TV viewing.

Some services may allow you to access text services by pressing the **RED** button.



MHEG (MULTIMEDIA AND HYPERMEDIA INFORMATION CODING EXPERT GROUP)(IN DIGITAL MODE)

(Only New Zealand)

This feature is enabled only in New Zealand.

- In New Zealand, pressing the Guide key will display MHEG EPG provided by New Zealand on the screen.

This system has an MHEG(Multimedia and hypermedia information coding expert group) to help your navigation through all the possible viewing options.

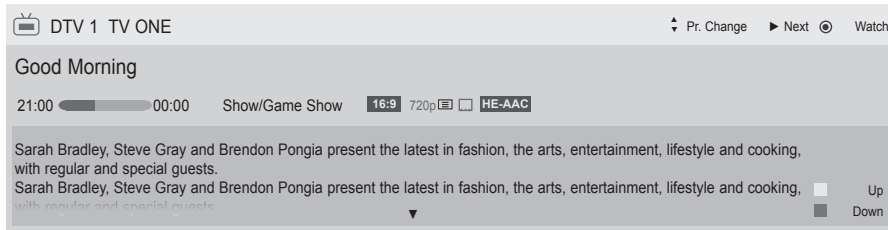

INFO Shows current programme information

Displayed with a TV or DTV Programme.	Displayed with a Teletext Programme.
Displayed with a Radio Programme.	Displayed with a Subtitle Programme.
Displayed with a MHEG Programme.	Displayed with a Scramble Programme.
Displayed with a HE-AAC Programme.	Displayed with a Dolby Digital Programme.
Aspect ratio of broadcasting programme.	Displayed with a Dolby Digital PLUS Programme.
Aspect ratio of broadcasting programme.	576i/p, 720p, 1080i/p : Resolution of broadcasting programme









SWITCH ON MHEG

- Switch on the MHEG.

SELECT A PROGRAMME

- Preview the Broadcast Programme Information.
- change to desired channel.
- The MHEG will disappear after moving to a selected channel.





BUTTON FUNCTION IN LISTING MODE

-  Select the Broadcast Programme Information.
-  Select Channel.
-  Change to Next Week or Prev Day.
-  Change to Next Day or Today.
-  The MHEG will disappear after moving to a selected channel.
-  Change to Now/Next mode.
-  Switch off MHEG.
-  Detail information on or off.



BUTTON FUNCTION IN NOW/NEXT MODE

You can view a channel being broadcasted and one scheduled to follow.

-  Select desired channel.
-  The MHEG will disappear after moving to a selected channel.
-  Change to Listing mode.
-  Switch off MHEG.
-  Detail information on or off.



PICTURE CONTROL

PICTURE SIZE (ASPECT RATIO) CONTROL

You can watch the screen in various picture formats; 16:9, Just Scan, Original, Full Wide, 4:3, 14:9, Zoom and Cinema Zoom.

If a fixed image is displayed on the screen for a long time, that fixed image may become imprinted on the screen and remain visible.

You can adjust the enlarge proportion using ^ v button.

This function works in the following signal.

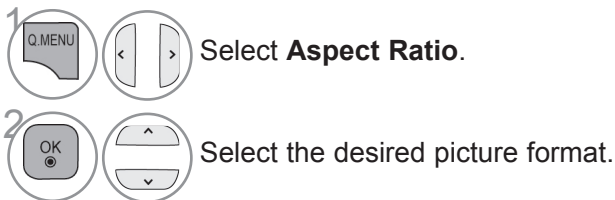

- You can also adjust **Aspect Ratio** in the **PICTURE** menu.
- For Zoom Setting, select **14:9, Zoom** and **Cinema Zoom** in Ratio Menu. After completing Zoom Setting, the display goes back to Q.Menu.

• 16:9

The following selection will allow you to adjust the picture horizontally, in linear proportion, to fill the entire screen (useful for viewing 4:3 formatted DVDs).



• Just Scan

Following Selection will lead to you view the picture of best quality without loss of original picture in high resolution image.

Note : If there is noise in original Picture, You can see the noise at the edge.

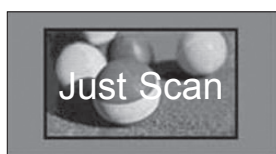

• Original

When your TV receives a wide screen signal it will automatically change to the picture format broadcast.

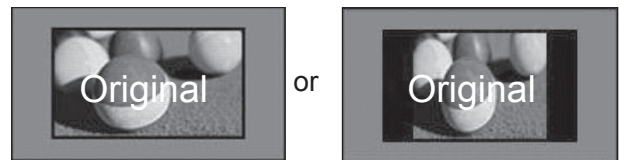

• Full Wide (Only DTV)

When TV receives the wide screen signal, it will lead you to adjust the picture horizontally or vertically, in a linear proportion, to fill the entire screen fully.

4:3 and 14:9 video is supported in full screen without any video distortion through DTV input.

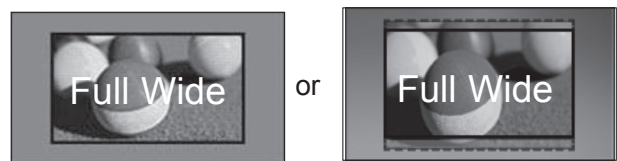

• **4:3**

The following selection will allow you to view a picture with an original 4:3 aspect ratio.



• **14:9**

You can view a picture format of 14:9 or a general TV programme in the 14:9 mode. The 14:9 screen is viewed in the same way as in 4:3, but is moved to the top and down.

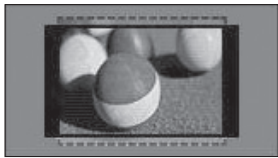

• **Zoom**

The following selection will allow you to view the picture without any alteration, while filling the entire screen. However, the top and bottom of the picture will be cropped.

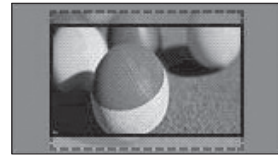

• **Cinema Zoom**

Choose Cinema Zoom when you want to enlarge the picture in correct proportion.

Note: When enlarging or reducing the picture, the image may become distorted.

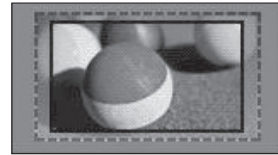

◀ or ▶ button: Adjust enlarge proportion of Cinema Zoom. The adjustment range is 1 to 16.
▼ or ▲ button: Move the screen.

! **NOTE**

- ▶ You can only select **4:3**, **16:9** (Wide), **14:9**, **Zoom/Cinema Zoom** in Component mode.
- ▶ You can only select **4:3**, Original, **16:9** (Wide), **14:9**, **Zoom/Cinema Zoom** in HDMI mode.
- ▶ You can only select **4:3**, **16:9** (Wide) in RGB-PC, HDMI-PC mode only.
- ▶ In DTV/HDMI/Component (over 720p) mode, **Just Scan** is available.
- ▶ In DTV (over 576p) mode, **Just Scan** is available in Australia only.

PICTURE CONTROL

PICTURE WIZARD

This feature lets you adjust the picture quality of the original image.

Use this to calibrate the screen quality by adjusting the Black and White Level etc. General users can calibrate the screen quality by easily following each stage.

When you adjust the image to Low, Recommended or High, you can see the changed result as an example.

In RGB-PC/HDMI-PC/DVI-PC mode, the changed Colour, Tint and H/V Sharpness values are not applied.

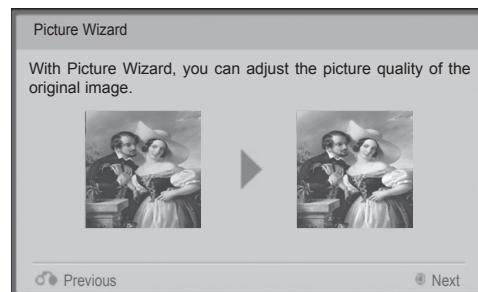
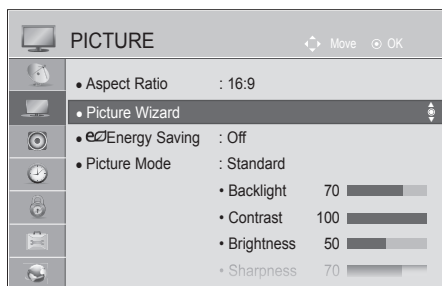

1 Select **PICTURE**.

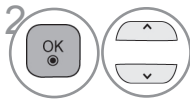

2 Select **Picture Wizard**.

Adjust **Standard**(Black Level, White Level, Tint, Colour, Horizontal Sharpness, Vertical Sharpness, Backlight) or **Preferred**(Black Level, White Level, Tint, Colour, Sharpness, Dynamic Contrast, Colour Temperature, Backlight).

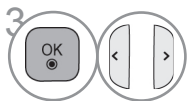

3 Select input source to apply the settings.

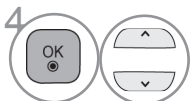

- If you stop the setting before the final stage, the changes will not be applied
- The adjustment value is saved to **Expert1**.
- Once the Picture Wizard sets the image quality, the Energy Saving is changed into Off.
- If the picture quality setting of **Expert1** is changed, use the **Picture Reset** before entering the **Picture Wizard** to reset the picture quality setting.
- **Standard** : mode to set standard picture quality.
- **Preferred** : mode to set user preferred picture quality rather than standard picture.

- Press the **MENU/EXIT** button to return to normal TV viewing.
- Press the **BACK** button to move to the previous menu screen.

e ENERGY SAVING

It reduces the TV's power consumption.





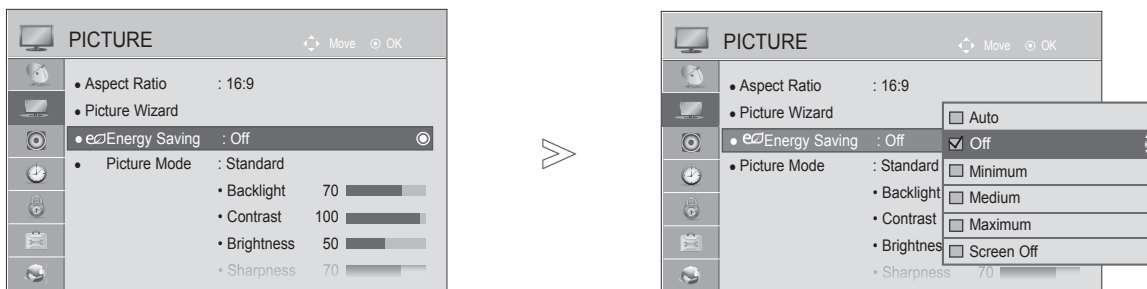

The default factory setting is adjusted to the comfortable level to be viewed at home.

You can change the brightness of your screen by adjusting the **Energy Saving level** or by setting the **Picture Mode**.

When adjusting Energy Saving in MHEG mode, the Energy Saving setting is applied after MHEG is finished.

Selecting '**Screen Off**' while tuned to a radio station channel will reduce power consumption.



- 1   Select **PICTURE**.
- 2   Select **e Energy Saving**.
- 3   Select **Auto**(Except 22/26/32LD3**, 32/37/42/47LD4**, 19/22/26LE5***, 22/26LE6***, 26LE3***), **Off**, **Minimum**, **Medium**, **Maximum** or **Screen Off**.

- Press the **MENU/EXIT** button to return to normal TV viewing.
- Press the **BACK** button to move to the previous menu screen.

- When you select Screen Off, the screen will be turned off in 3 seconds and Screen Off will start.
- If you adjust “**Energy Saving-Auto**(Except 22/26/32LD3**, 32/37/42/47LD4**, 19/22/26LE5***, 22/26LE6***, 26LE3***), **Maximum**”, **Backlight** feature will not work.
- You can also adjust this feature by selecting **Energy Saving** button on the remote control.
- When selecting Auto, Backlight is automatically adjusted through intelligent sensor according to the surrounding condition when intelligent sensor is in the TV.

PICTURE CONTROL

PRESET PICTURE SETTINGS

Picture Mode-Preset

Vivid/Family	Strengthen the contrast, brightness, colour and sharpness for vivid picture.
Standard	The most general screen display status.
Cinema	Optimizes video for watching movies.
Sport/Cricket	Optimizes video for watching sports events.
Game	Optimizes video for playing games.

■ Image shown may differ from your TV.

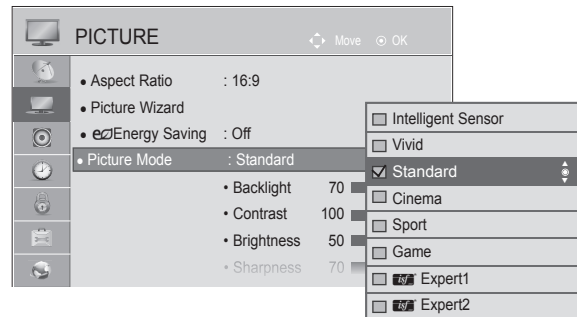
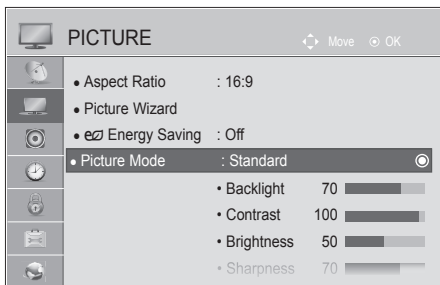

1 Select **PICTURE**.

2 Select **Picture Mode**.

3 Select **Intelligent Sensor**(Except 22/26/32LD3**, 32/37/42/47LD4**, 22/26LE5***, 22/26LE6***, 26LE3***), **Vivid/Family**, **Standard**, **Cinema**, **Sport/Cricket** or **Game**.

- Press the **MENU/EXIT** button to return to normal TV viewing.
- Press the **BACK** button to move to the previous menu screen.

- **Picture Mode** adjusts the TV for the best picture appearance. Select the preset value in the **Picture Mode** menu based on the programme category.
- When the Intelligent sensor function is on, the most suitable picture is automatically adjusted according to the surrounding conditions.
- You can also adjust **Picture Mode** in the **Q. Menu**.
- **Intelligent Sensor** : Adjusts picture according to the surrounding conditions.

MANUAL PICTURE ADJUSTMENT

Picture Mode-User option

Backlight

To control the brightness of the screen, adjust the brightness of LCD panel.
Adjusting the backlight when setting the brightness of the set is recommended.

Contrast

Adjusts the signal level between black and white in the picture. You may use Contrast when the bright part of the picture is saturated.

Brightness

Adjusts the base level of the signal in the picture.

Sharpness

Adjusts the level of crispness in the edges between the light and dark areas of the picture.
The lower the level, the softer the image.

Colour

Adjusts intensity of all colours.

Tint

Adjusts the balance between red and green levels.

Colour Temp.

Adjust to left direction to make a picture reddish or adjust to right direction to make a picture bluish.

It is not available to use this function in “**Intelligent Sensor**”.

■ Image shown may differ from your TV.

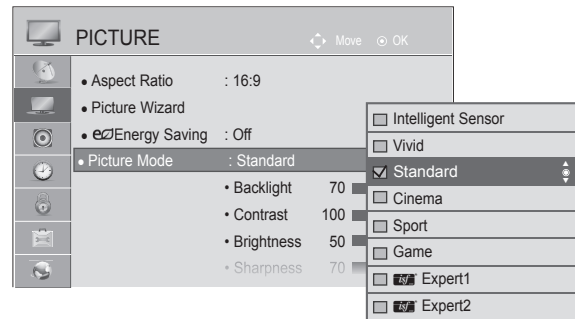
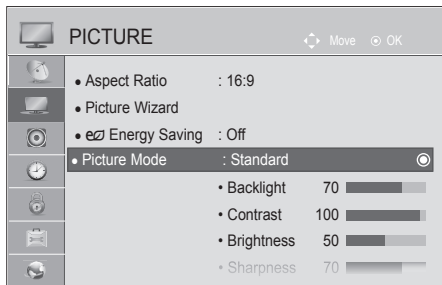

- 1   Select **PICTURE**.
- 2   Select **Picture Mode**.
- 3   Select **Vivid/Family, Standard, Cinema, Sport/Cricket or Game**.
- 4   Select **Backlight, Contrast, Brightness, Sharpness, Colour, Tint or Colour Temp..**
- 5   Make appropriate adjustments.

- Press the **MENU/EXIT** button to return to normal TV viewing.
- Press the **BACK** button to move to the previous menu screen.

PICTURE CONTROL

- **Benefits of using Backlight**

- The electricity consumption is reduced by up to 60 %.
- The black brightness is reduced. (As the black has greater depth, you can enjoy a better quality definition.)
- You can adjust brightness with maintaining original signal resolution.

! NOTE

- ▶ You cannot adjust colour, sharpness and tint in the RGB-PC/HDMI-PC mode.
- ▶ When the **Expert 1/2** is selected, you can select **Backlight, Contrast, Brightness, H Sharpness, V Sharpness, Colour** or **Tint**.

PICTURE IMPROVEMENT TECHNOLOGY







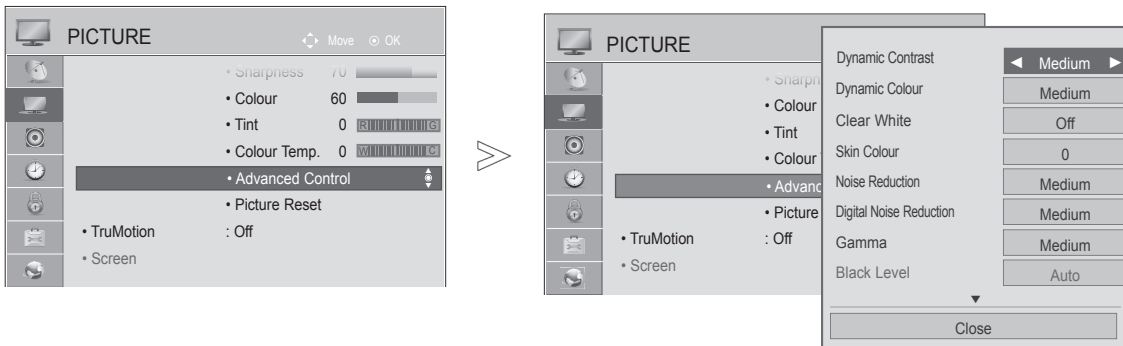

You can calibrate the screen for each Picture Mode or set the video value according to the special video screen.

You can set the video value differently for each input.

To reset to the factory default screen after making adjustments to each video mode, execute the "Picture Reset" function for each Picture Mode.

■ Image shown may differ from your TV.



- 1   Select **PICTURE**.
- 2   Select **Advanced Control**.
- 3   Select your desired Source.:
Dynamic Contrast, Dynamic Colour, Clear White, Skin Colour, Noise Reduction, Digital Noise Reduction, Gamma, Black Level, Eye Care, Real Cinema, Colour Gamut or xvYCC. (Refer to p. 125 to 126)
- 4   Make appropriate adjustments.

- Press the **MENU/EXIT** button to return to normal TV viewing.
- Press the **BACK** button to move to the previous menu screen.

PICTURE CONTROL









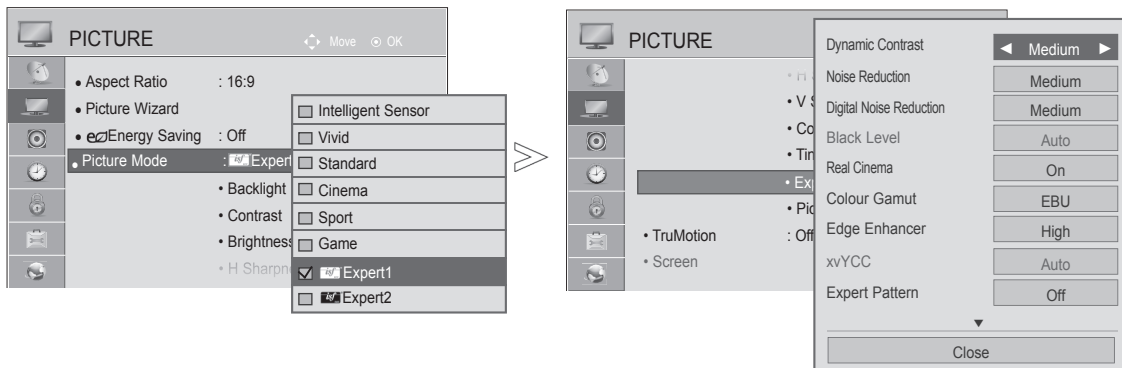



EXPERT PICTURE CONTROL

By segmenting categories, **Expert1** and **Expert2** provide more categories which users can set as they see fit, offering the optimal picture quality for users.

This may also be used to help a professional optimize the TV performance using specific videos.

■ Image shown may differ from your TV.



- 1   Select **PICTURE**.
- 2   Select **Picture Mode**.
- 3   Select  **Expert1** or  **Expert2**.
- 4   Select **Expert Control**.
- 5   Select your desired Source.
- 6  Make appropriate adjustments.

- Press the **MENU/EXIT** button to return to normal TV viewing.
- Press the **BACK** button to move to the previous menu screen.

*This feature is not available for all models.

Dynamic Contrast (Off/Low/Medium/High)	<ul style="list-style-type: none"> Adjusts the contrast to keep it at the best level according to the brightness of the screen. The picture is improved by making bright parts brighter and dark parts darker.
Dynamic Colour (Off/Low/High)	<ul style="list-style-type: none"> Adjusts screen colours so that they look livelier, richer and clearer. This feature enhances hue, saturation and luminance so that red, blue, green and white look more vivid.
Skin Colour (-5 to 5)	<ul style="list-style-type: none"> Adjusts skin colour of the picture so that user can set his favourite skin colour.
Noise Reduction (Off/Low/Medium/High/ Auto(In Analogue Mode Only))	<ul style="list-style-type: none"> Reduces screen noise without compromising video quality.
Digital Noise Reduction (Off/Low/Medium/High)	<ul style="list-style-type: none"> Reduces noise regarding MPEG compressed video.
Gamma (Advanced Control: Low/Medium/High Expert Control: 1.9/2.2/2.4)	<ul style="list-style-type: none"> You can adjust brightness of dark area and middle gray level area of the picture. <ul style="list-style-type: none"> Low/1.9 : Makes dark and middle gray level area of the picture brighter. Medium/2.2 : Expresses original picture levels. High/2.4: Makes dark and middle gray level area of the picture darker.
Black Level (Low/High/Auto)	<ul style="list-style-type: none"> Low : The picture of the screen gets darker. High : The picture of the screen gets brighter. Auto : Sets black level of the screen to High or Low automatically according to the input signal level. This function enables to select 'Low' or 'High' in the following mode: AV(NTSC-M), HDMI or Component. Otherwise, 'Black level' is set to 'Auto'.
Clear White (Off/Low/High)	<ul style="list-style-type: none"> Makes the white area of the screen brighter and clearer.
Eye Care (Low/High/Off)	<p>*This feature is not available for all models.</p> <ul style="list-style-type: none"> Adjusts the brightness of the screen automatically to the best level for eyes when the screen is too bright. This feature is disable in “Picture Mode-Vivid/Family, Cinema, Expert1, Expert2, Intelligent Sensor”.
Real Cinema/ Film Mode (On/Off)	<ul style="list-style-type: none"> You can watch a cinema-like video by eliminating judder effect. Uses this function when you watch film-originated movie contents. This function can work when TruMotion is off.





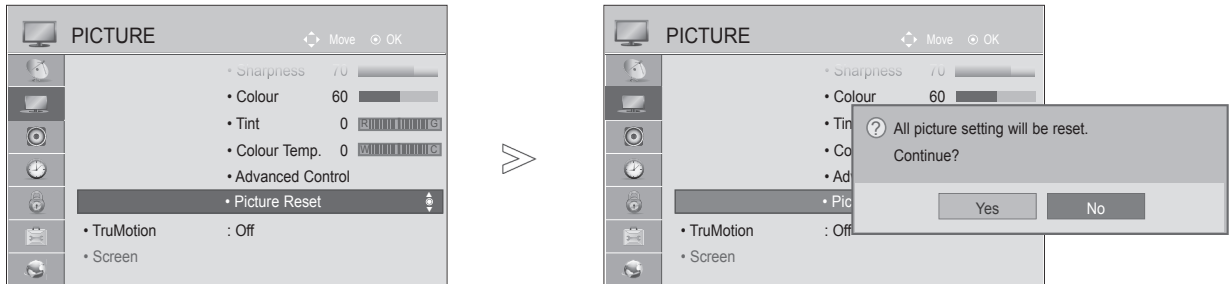

PICTURE CONTROL

Colour Gamut (Advanced Control) (Wide/Standard)	<ul style="list-style-type: none"> • Standard : Mode to use original colour area regardless of the display characteristics. • Wide: Mode to use maximum colour area of the TV display.
Colour Gamut (Expert Control: EBU/ SMPTE/BT709/Wide/ Standard)	<ul style="list-style-type: none"> • Standard : Mode to use original colour area regardless of the display characteristics. • Wide : Mode to use maximum colour area of the TV display. • EBU : Mode to display EBU colour area. • SMPTE : Mode to display SMPTE colour area. • BT709 : Mode to display BT709 colour area.
Edge Enhancer (Off/Low/High)	<ul style="list-style-type: none"> ■ Makes the edge of the picture clearer and distinctive. ■ This function can use in "Picture Mode-Expert."
xvYCC (Auto/off/on)	<p>*This feature is not available for all models.</p> <ul style="list-style-type: none"> ■ This is the function to express richer colour. ■ This function is enabled in "Picture mode - Cinema, Expert" when xvYCC signal is inputted through HDMI
Expert Pattern (Off/Pattern1/Pattern2)	<ul style="list-style-type: none"> ■ This is the pattern necessary for checking the picture of Digital TV. ■ This function is enabled in "Picture Mode - Expert" when you watch DTV.
Colour Filter (Off/Red/Green/Blue)	<ul style="list-style-type: none"> ■ This is the function to filter the specific colours of the video. <p>You can use the RGB filter to set colour saturation and hue accurately.</p>
Colour Temperature (Medium/Warm/Cool)	<p>This is the function to adjust the overall colour of the screen to the feeling you want.</p> <p>a. • Method : 2 Points</p> <ul style="list-style-type: none"> • Pattern: Inner, Outer • Red/Green/Blue Contrast, Red/Green/Blue Brightness: <p>The adjustment range is -50 to +50.</p> <p>b. • Method : 10 point IRE</p> <ul style="list-style-type: none"> • Pattern: Inner / Outer • IRE (Institute of Radio Engineers) is the unit to display the size of the video signal and can be set among 10, 20, 30 to 100. You can adjust Red, Green or Blue according to each setting. • Luminance: This function displays calculated luminance value for 2.2 gamma. You can input luminance value you want at 100 IRE, than the target luminance value for 2.2 gamma is displayed at every 10 steps from 10 IRE to 90 IRE. • Red/Green/Blue: The adjustment range is -50 to +50.
Colour Management System	<ul style="list-style-type: none"> ■ As the tool used by the experts to make adjustments by using the test patterns, this does not affect other colours but can be used to selectively adjust the 6 colour areas (Red/Green/Blue/Cyan/Magenta/Yellow). Colour difference may not be distinctive even when you make the adjustments for the general video. ■ Adjusts Red/Green/Blue/Yellow/Cyan/Magenta. • Red/Green/Blue/Yellow/Cyan, Magenta Colour : The adjustment range is -30 to +30. • Red/Green/Blue/Yellow/Cyan/Magenta Tint : The adjustment range is -30 to +30. ■ This feature is disable in RGB-PC and HDMI (PC) mode.

PICTURE RESET

Settings of the selected picture modes return to the default factory settings.



- 1   Select **PICTURE**.
- 2   Select **Picture Reset**.
- 3   Select **Yes**.
- 4  Initialize the adjusted value.

- Press the **MENU/EXIT** button to return to normal TV viewing.
- Press the **BACK** button to move to the previous menu screen.

PICTURE CONTROL

TRUMOTION

*This feature is not available for all models.

It is used for the best picture quality without any motion blur or judder when you enter a quick image or Film Source.

High : Provides smoother picture movement.

Low : Provides smooth picture movement. Use this setting for standard use.

Off : Turn off TruMotion Operation.

User : User can adjust **Judder** and **Blur** level in TruMotion Operation, separately.

- **Judder** : Adjusts noise of the screen.





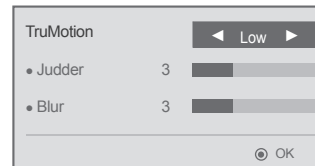
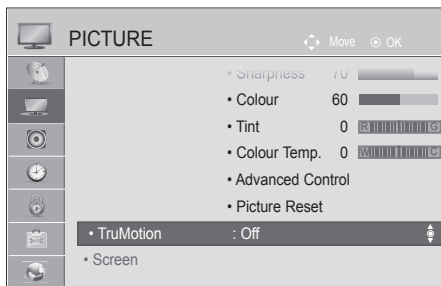

- **Blur** : Adjusts after-image of the screen.

This feature is disable in RGB-PC, HDMI-PC and MY MEDIA-Photo List mode.

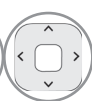
If you enable "TruMotion", noise may appear on the screen.

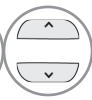
If this occurs, set "TruMotion" to "Off".

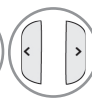

-   Select **PICTURE**.
-   Select **TruMotion**.
-   Select **Low, High, User** or **Off**.
-  Make appropriate adjustments.





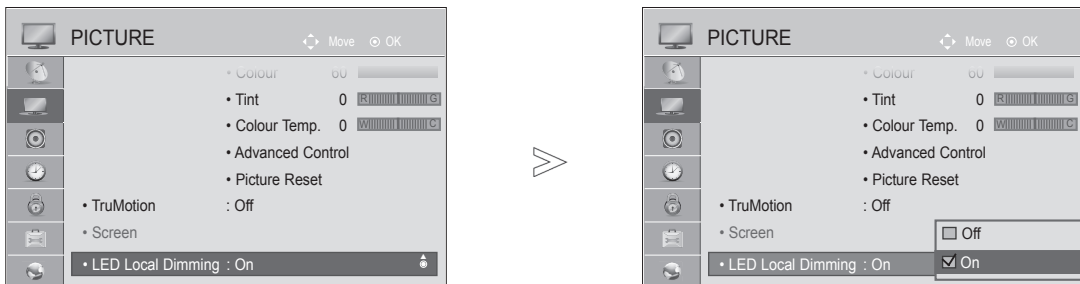

- Press the **MENU/EXIT** button to return to normal TV viewing.
- Press the **BACK** button to move to the previous menu screen.

LED LOCAL DIMMING

(Only 42/47/55LE55**, 42/47/55LE7***, 42/47/55LE8***, 42/47/55LX6***, 47/55LX9***)

After analyzing the signal of the input video by areas of the screen, it adjusts the backlight to improve the contrast ratio.



- 1   Select **PICTURE**.
- 2   Select **LED Local Dimming**.
- 3   Select **On** or **Off**.

- Press the **MENU/EXIT** button to return to normal TV viewing.
- Press the **BACK** button to move to the previous menu screen.

PICTURE CONTROL

POWER INDICATOR

Adjust the power/standby indicator light on the front of the TV.

Standby Light





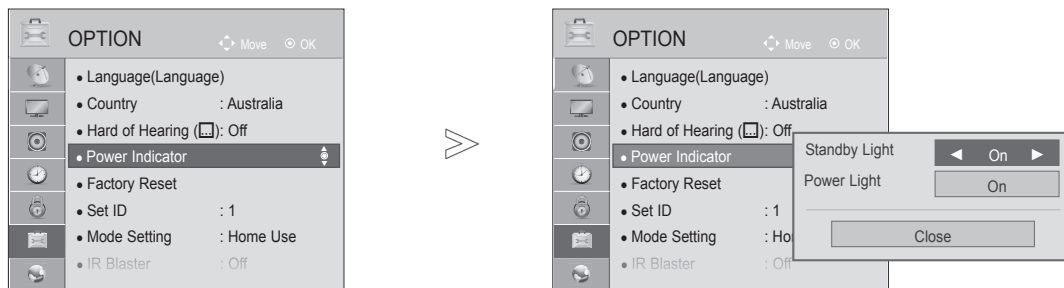

Determines whether to set the indicator light on the front of the TV to **On** or **Off** in standby mode.

Power Light

Determines whether to set the indicator light on the front of the TV to **On** or **Off** when the power turns on.

If you select 3D mode, **Power indicator** is turned off automatically.









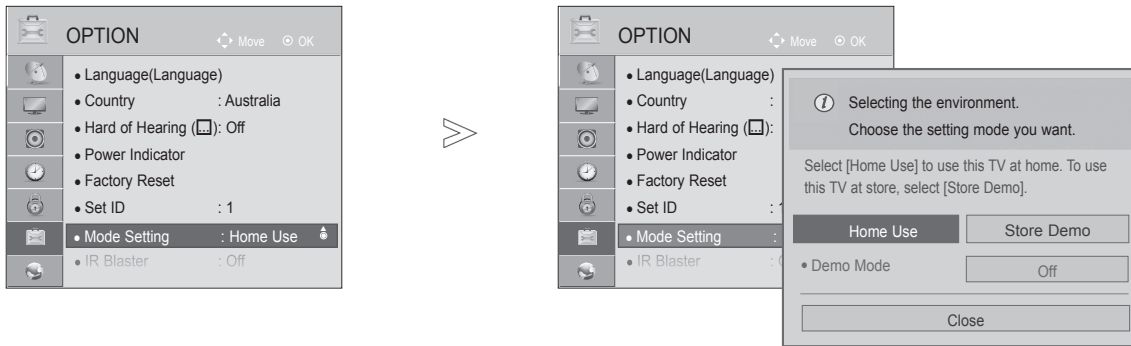

- 1   Select **OPTION**.
- 2   Select **Power Indicator**.
- 3   Select **Standby Light** or **Power Light**.
- 4  Select your desired Source.

- Press the **MENU/EXIT** button to return to normal TV viewing.
- Press the **BACK** button to move to the previous menu screen.

MODE SETTING

We recommend setting the TV to “**Home Use**” mode for the best picture in your home environment. “**Store Demo**” mode is an optimal setting for displaying at stores.



-   Select **OPTION**.
-   Select **Mode Setting**.
-   Select **Store Demo** or **Home Use**.
-  Save.

- Press the **MENU/EXIT** button to return to normal TV viewing.
- Press the **BACK** button to move to the previous menu screen.

PICTURE CONTROL

DEMO MODE









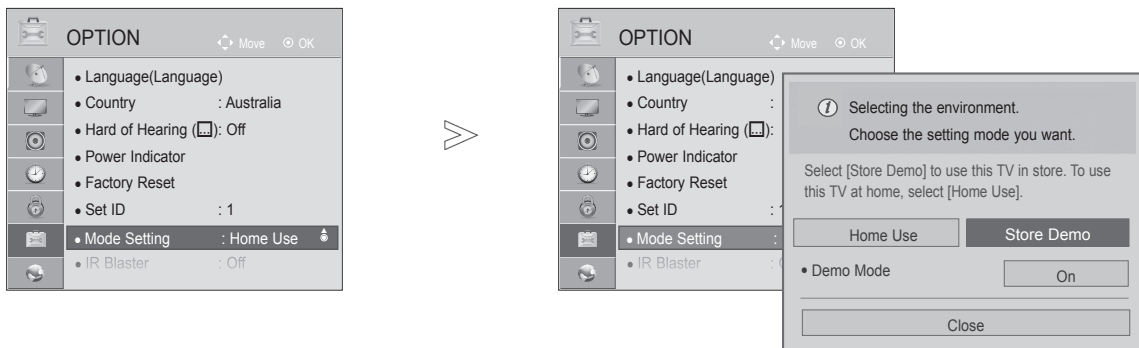

It is not possible to use **Demo Mode** in **Home Use** mode.

In **Store Demo**, **Demo Mode** is automatically set to **On**.

Once **Demo Mode** is set to **Off** in **Store Demo**, **Demo Mode** does not run and only the screen is reset.

The screen is reset automatically after 5 minutes in **Demo Mode**.



-   Select **OPTION**.
-   Select **Mode Setting**.
-   Select **Store Demo**.
-   Select **On**.
-  Move to the previous menu screen.
If you want to stop the demo, press any button. (except for MUTE,  + , - button)

- Press the **MENU/EXIT** button to return to normal TV viewing.
- Press the **BACK** button to move to the previous menu screen.

SOUND & LANGUAGE CONTROL





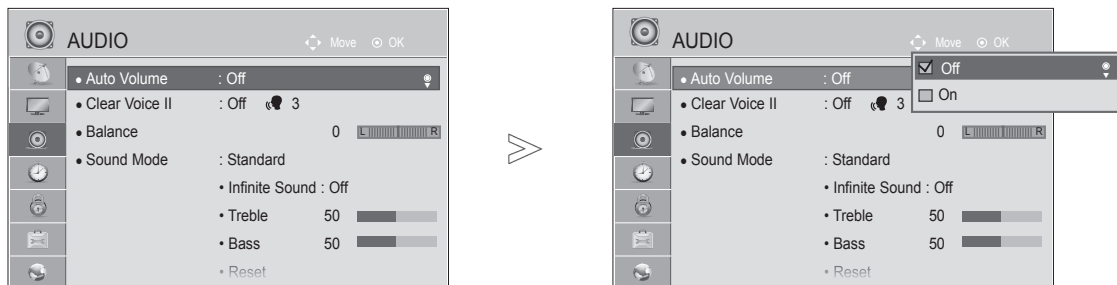

AUTO VOLUME LEVELER

Auto Volume automatically remains on the same level of volume if you change programmes.

Because each broadcasting station has its own signal conditions, volume adjustment may be needed every time the channel is changed. This feature allows users to enjoy stable volume levels by making automatic adjustments for each programme.

If sound quality or volume is not at the level you want, it is recommended to use a separate home theater system or amp to cope with different user environments.



- 1   Select **AUDIO**.
- 2   Select **Auto Volume**.
- 3   Select **On** or **Off**.

- Press the **MENU/EXIT** button to return to normal TV viewing.
- Press the **BACK** button to move to the previous menu screen.

SOUND & LANGUAGE CONTROL

CLEAR VOICE II

By differentiating the human sound range from others, it helps users listen to human voices better.

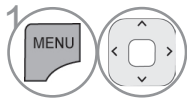
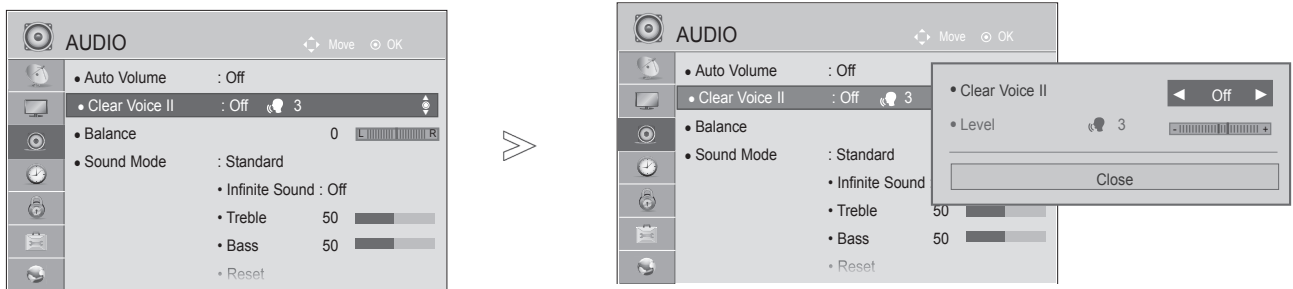

Select **AUDIO**.

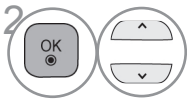

Select **Clear Voice II**.

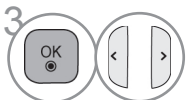

Select **On** or **Off**.

- If you select “On” for **Clear Voice II**, **Infinite Sound** feature will not work.
- Select levels from ‘-6’ to ‘+6’.

Adjustment for Clear Voice Level With selecting On



Select **Level**.



Make desired adjustment.

- Press the **MENU/EXIT** button to return to normal TV viewing.
- Press the **BACK** button to move to the previous menu screen.

PRESET SOUND SETTINGS-SOUND MODE

You can select your preferred sound setting; Standard, Music, Cinema, Sport/Cricket or Game and you can also adjust the Treble, Bass.

Sound Mode lets you enjoy the best sound without any Special adjustment as the TV sets the appropriate sound options based on the programme content.

Standard, Music, Cinema, Sport/Cricket and Game are preset for optimum sound quality at the factory.

- Standard** Offers standard-quality sound.
- Music** Optimizes sound for listening to music.
- Cinema** Optimizes sound for watching movies.
- Sport/Cricket** Optimizes sound for watching sports events.
- Game** Optimizes sound for playing games.

■ Image shown may differ from your TV.

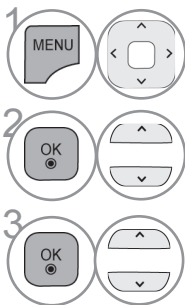
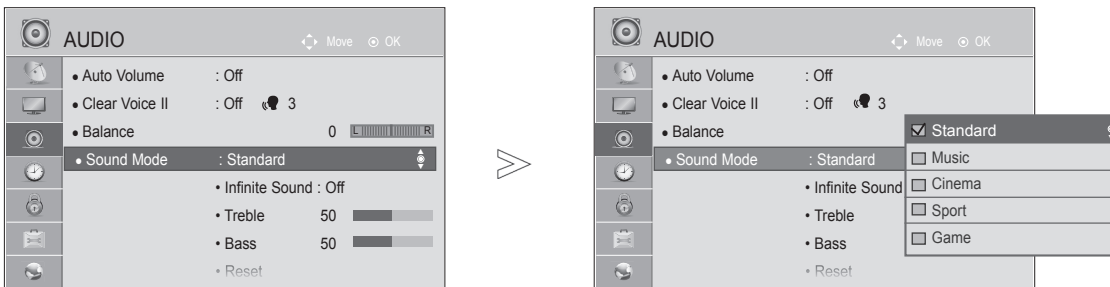

Select **AUDIO**.

Select **Sound Mode**.

Select **Standard, Music, Cinema, Sport/Cricket** or **Game**.

• You can also adjust **Sound Mode** in the **Q. Menu**.









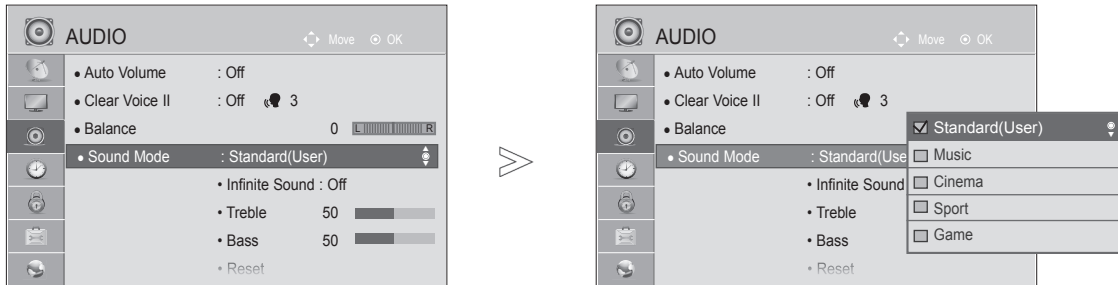

- Press the **MENU/EXIT** button to return to normal TV viewing.
- Press the **BACK** button to move to the previous menu screen.

SOUND & LANGUAGE CONTROL

SOUND SETTING ADJUSTMENT -USER MODE

■ Image shown may differ from your TV.







- 1   Select **AUDIO**.
- 2   Select **Sound Mode**.
- 3   Select **Standard, Music, Cinema, Sport/Cricket or Game**.
- 4   Select **Treble or Bass**.
- 5   Set the desired sound level.

- Press the **MENU/EXIT** button to return to normal TV viewing.
- Press the **BACK** button to move to the previous menu screen.

INFINITE SOUND

Select this option to sound realistic.

- 1   Select **AUDIO**.
- 2   Select **Infinite Sound**.
- 3   Select **On or Off**.





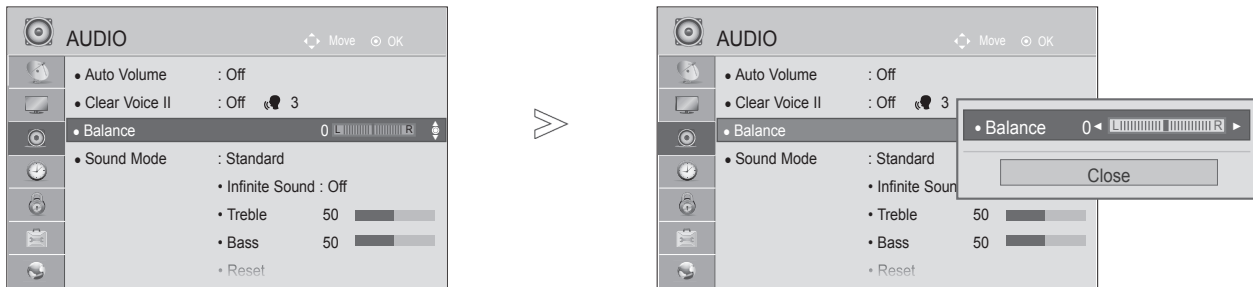

Infinite Sound : Infinite Sound is a patented LG proprietary sound processing technology that strives immersive 5.1 surround sound impression with front two loudspeakers.

- Press the **MENU/EXIT** button to return to normal TV viewing.
- Press the **BACK** button to move to the previous menu screen.

BALANCE

You can adjust the sound balance of the speakers to preferred levels.



- 1   Select **AUDIO**.
- 2   Select **Balance**.
- 3   Make desired adjustment.

- Press the **MENU/EXIT** button to return to normal TV viewing.
- Press the **BACK** button to move to the previous menu screen.

SOUND & LANGUAGE CONTROL





TV SPEAKERS ON/ OFF SETUP

You can adjust the TV internal speaker status.

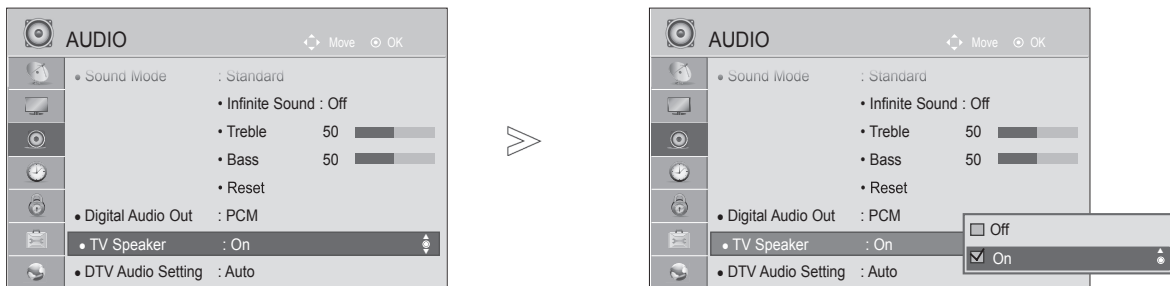
In **AV**, **COMPONENT**, **RGB** and **HDMI** with HDMI to DVI cable, the TV speaker can be operational even when there is no video signal.

If you wish to use an external Hi-Fi system, turn off the TV's internal speakers.

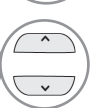

- 1   Select **AUDIO**.
- 2   Select **TV Speaker**.
- 3   Select **On** or **Off**.

- Press the **MENU/EXIT** button to return to normal TV viewing.
- Press the **BACK** button to move to the previous menu screen.





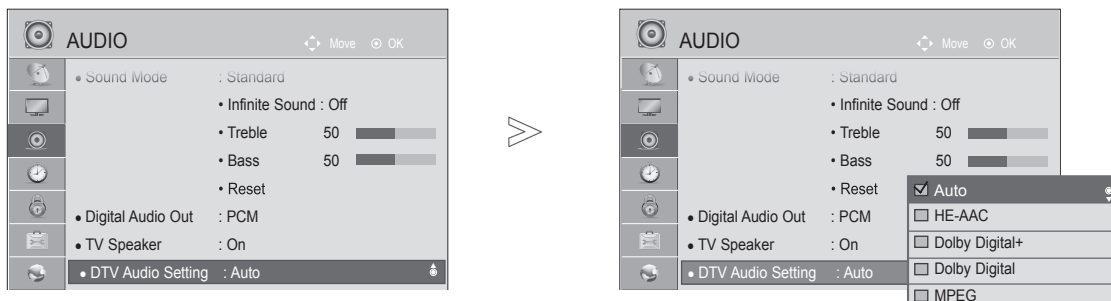

NOTE

- ▶ When the TV speaker is turned off while the Simplink home theater is operating, the sound output automatically switches to the Home theater speaker, but when the TV speaker is turned on, the sound output the TV speaker.
- ▶ Some menus in **AUDIO** are disabled when TV Speaker is set to Off.

DTV AUDIO SETTING (IN DIGITAL MODE ONLY) (Only DTV)

When different audio types exist in an input signal, this function allows you to select the audio type you want.



- 1   Select **AUDIO**.
- 2   Select **DTV Audio Setting**.
- 3   Select **Auto, HE-AAC, Dolby Digital +, Dolby Digital** or **MPEG**.

- Press the **MENU/EXIT** button to return to normal TV viewing.
- Press the **BACK** button to move to the previous menu screen.

- **Auto**: Automatically outputs in the order **HE-AAC > Dolby Digital+ > Dolby Digital > MPEG**.
- **HE-AAC, Dolby Digital +, Dolby Digital, MPEG**: Allows users to select the audio type they want.
ex) If **MPEG** is selected, **MPEG** is always outputted.
If **MPEG** is not supported, another audio type is set in that order.
- Refer to p. 145 to 146 (Audio Language Selection)

SOUND & LANGUAGE CONTROL

SELECTING DIGITAL AUDIO OUT

It is possible to use in DTV, HDMI, DivX mode.

This function allows you to select your preferred Digital Audio Output.

When Dolby Digital is available, selecting Auto in the Digital Audio Out menu will set SPDIF(Sony Philips Digital InterFace) output to Dolby Digital.

If Auto is selected in the digital audio out menu when Dolby Digital is not available, SPDIF output will be PCM(Pulse-code modulation).

Even if both Dolby Digital and Audio language have been set in a channel which broadcast Dolby Digital Audio, only Dolby Digital will be played.

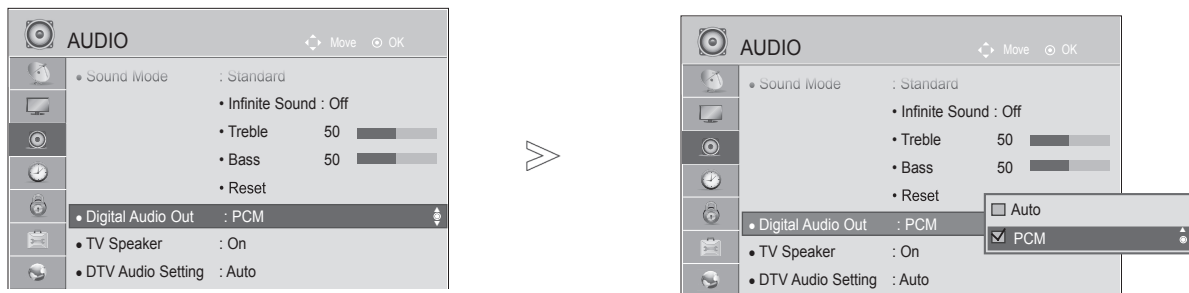

- 1 Select **AUDIO**.
- 2 Select **Digital Audio Out**.
- 3 Select **Auto** or **PCM**.





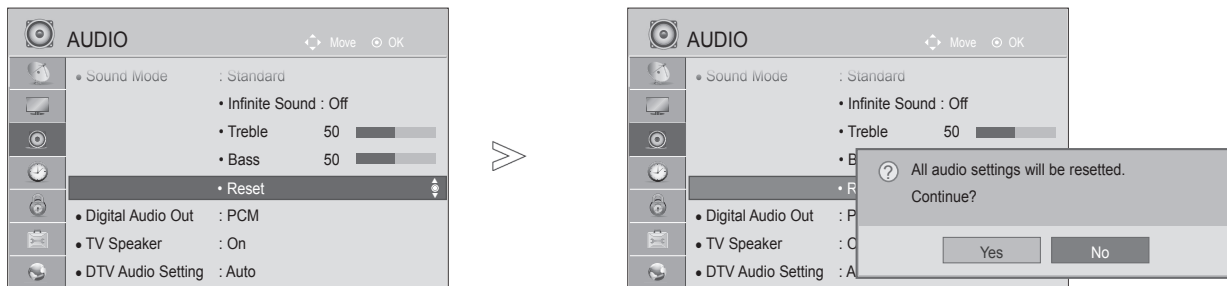

Item	Audio Input	Digital Audio output
Auto(Speaker On)	MPEG Dolby Digital Dolby Digital Plus HE-AAC	PCM Dolby Digital Dolby Digital PCM
Auto(Speaker Off)	MPEG Dolby Digital Dolby Digital Plus HE-AAC	PCM Dolby Digital Dolby Digital Dolby Digital
PCM	All	PCM

- Press the **MENU/EXIT** button to return to normal TV viewing.
- Press the **BACK** button to move to the previous menu screen.

AUDIO RESET

Settings of the selected Sound Mode return to the default factory settings.



- 1   Select **AUDIO**.
- 2   Select **Reset**.
- 3   Select **Yes**.
- 4  Initialize the adjusted value.



- Press the **MENU/EXIT** button to return to normal TV viewing.
- Press the **BACK** button to move to the previous menu screen.

SOUND & LANGUAGE CONTROL

I/II

STEREO/DUAL RECEPTION (IN ANALOGUE MODE ONLY)

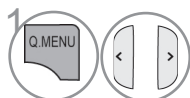
When a programme is selected, the sound information for the station appears with the programme number and station name.

-  Select **Audio** or **Audio Language**.
-  Select the sound output.

Broadcast	On Screen Display
Mono	MONO
Stereo	STEREO
Dual (Except for Singapore, New Zealand and Indonesia)	DUAL I, DUAL II, DUAL I+II (Except for Singapore, New Zealand and Indonesia)
NICAM (Only Singapore, New Zealand and Indonesia)	NICAM (Only Singapore, New Zealand and Indonesia)

■ Mono sound selection

If the stereo signal is weak in stereo reception, you can switch to mono. In mono reception, the clarity of sound is improved.

■ Language selection for dual language broadcast (Except for Singapore, New Zealand and Indonesia)

If a programme can be received in two languages (dual language), you can switch to DUAL I, DUAL II or DUAL I+II.

DUAL I Sends the primary broadcast language to the loudspeakers.

DUAL II Sends the secondary broadcast language to the loudspeakers.

DUAL I+II Sends a separate language to each loudspeaker.

NICAM RECEPTION (IN ANALOGUE MODE ONLY)

(Except for Singapore, New Zealand and Indonesia)

If the TV is equipped with a receiver for NICAM reception, high quality NICAM (Near Instantaneous Companding Audio Multiplex) digital sound can be received.

Sound output can be selected according to the type of broadcast received.

-
- 1 When **NICAM mono** is received, you can select **NICAM MONO** or **FM MONO**.

 - 2 When **NICAM stereo** is received, you can select **NICAM STEREO** or **FM MONO**.
If the stereo signal is weak, switch to **FM MONO**.

 - 3 When **NICAM dual** is received, you can select **NICAM DUAL I**, **NICAM DUAL II** or **NICAM DUAL I+II** or **FM MONO**.
-

SPEAKER SOUND OUTPUT SELECTION

In AV, Component, RGB and HDMI mode, you can select output sound for the left and right loudspeakers.

Select the sound output.

L+R: Audio signal from audio L input is sent to the left loudspeaker and audio signal from audio R input is sent to the right loudspeaker.

L+L: Audio signal from audio L input is sent to left and right loudspeakers.

R+R: Audio signal from audio R input is sent to left and right loudspeakers.



SOUND & LANGUAGE CONTROL

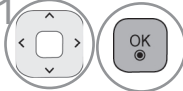
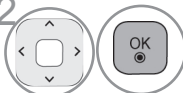

ON-SCREEN MENU LANGUAGE / COUNTRY SELECTION

The installation guide menu appears on the TV screen when it is switched on for the first time.

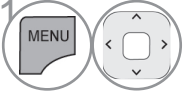
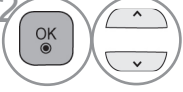
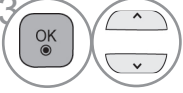
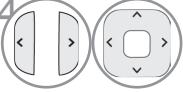
-  Select your desired language. (Except for Australia, New Zealand, Singapore and South Africa.)
-  Select your country. (Only Australia & New Zealand)

* If you want to change Language/ Country selection

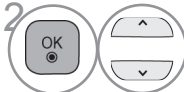
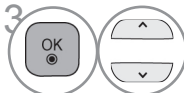
-  Select **OPTION**.
-  Select **Language(Language)**.
-  Select **Menu Language**. (Except for Australia, New Zealand, Singapore and South Africa.)
-  Select your desired language.
-  Save.

-  Select **OPTION**.
-  Select **Country(Only Australia & New Zealand)**.
-  Select your country.
-  Save.

- Press the **MENU/EXIT** button to return to normal TV viewing.
- Press the **BACK** button to move to the previous menu screen.

NOTE

- ▶ If you do not finish the set-up **Installation Guide** by pressing **BACK** or if you time out on the OSD (On Screen Display) the installation menu will continuously appear until the set up is completed whenever the TV is switched on.
- ▶ If you select the wrong local country, teletext may not appear correctly on the screen and some problems may occur during teletext operation.
- ▶ DTV mode control buttons may not function based on country broadcasting circumstances. (Only DTV)
- ▶ In country that Digital broadcasting regulation isn't fixed, some DTV function may not work depending on digital broadcasting circumstances. (Only DTV)

LANGUAGE SELECTION (IN DIGITAL MODE ONLY)

(Only DTV)

The Audio function allows selection of a preferred language.

If audio data in a selected language is not broadcast, the default language audio will be played.

Use the Subtitle function when two or more subtitle languages are broadcast. If subtitle data in a selected language is not broadcast, the default language subtitle will be displayed.

When the languages you selected as the primary for Audio Language and Subtitle Language and Text Language are not supported, you can select language in secondary category (Only New Zealand).

In Digital mode, use the Text language function when two or more Text languages are broadcast. If tele-text data in a selected language is not broadcast, the default Text language will be displayed.

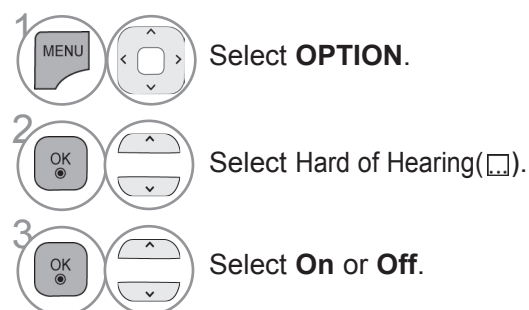
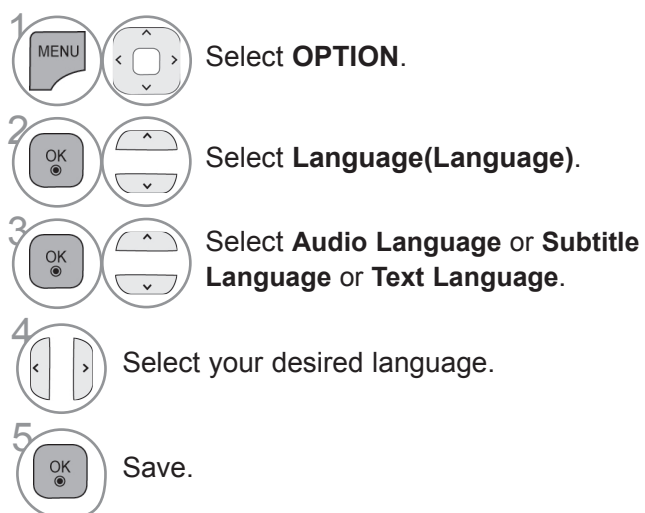

! NOTE

- ▶ It is only available to use Hard of Hearing on some TV stations in New Zealand.

- Press the **BACK** button to move to the previous menu screen.

SOUND & LANGUAGE CONTROL

< Audio Language Selection >

- ▶ When two or more audio languages are broadcast, you can select the audio language.

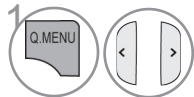

Select **Audio** or **Audio Language**.

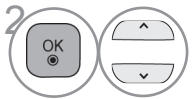

Select an audio language.

< Subtitle Language Selection >

- ▶ When two or more subtitle languages are broadcast, you can select the subtitle language with the **SUBTITLE** button on the remote control.
- ▶ Press the ^ v button to select a subtitle language.



- The audio/subtitles can be displayed in a simpler form with 1 to 3 characters broadcast by the service provider.
- When you select supplementary Audio (Audio for "Visual/Hearing Impaired") the TV may output a part of the Main audio.

Audio Language OSD Information

Display	Status
N.A	Not Available
MPEG	MPEG Audio
DD	Dolby Digital Audio
VI	Audio for "Visual Impaired"
ABC	Audio for "Hearing Impaired"
DD+	Dolby Digital Plus Audio
HE-AAC	HE-AAC Audio

Subtitle Language OSD Information

Display	Status
N.A	Not Available
TXT	Teletext Subtitle
ABC	Subtitle for "Hard of Hearing"

Analogue TV	 Manufactured under license from Dolby Laboratories. "Dolby" and the double-D symbol are trademarks of Dolby Laboratories.	
Digital TV	Except 32/42/52LD56*, 32/37/42/47/55LD6**, 32/37/42/47/55LE55**, 32/37/42/47/55LE7***, 42/47/55LE8***, 42/47/55LX6***, 47/55LX9***	Only 32/42/52LD56*, 32/37/42/47/55LD6**, 32/37/42/47/55LE55**, 32/37/42/47/55LE7***, 42/47/55LE8***, 42/47/55LX6***, 47/55LX9***
	 Manufactured under license from Dolby Laboratories. "Dolby" and the double-D symbol are trademarks of Dolby Laboratories.	 Manufactured under license from Dolby Laboratories. Dolby and the double-D symbol are trademarks of Dolby Laboratories.
	<ul style="list-style-type: none"> • There is a possibility that when HDMI mode, some DVD players do not make SPDIF sound. At that time, set the output of the digital audio of the DVD player to PCM. (In HDMI, Dolby Digital Plus is not supported). 	<ul style="list-style-type: none"> • There is a possibility that when HDMI mode, some DVD players do not make SPDIF sound. At that time, set the output of the digital audio of the DVD player to PCM. (In HDMI, Dolby Digital Plus is not supported).

TIME SETTING

CLOCK SETUP

The clock is set automatically when receiving a digital signal in **Auto** mode. You can set the clock manually in **Manual** mode.

You must set the time correctly before using on/off timer function.

< Only Australia >

When you select a Time Zone city, the TV time is set by the time offset information based on Time Zone and GMT (Greenwich Mean Time) which is received with the broadcast signal and the time is set automatically by a digital signal.

<Only Indonesia, Israel>





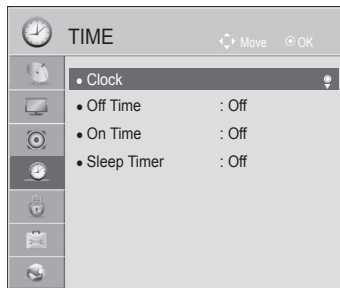



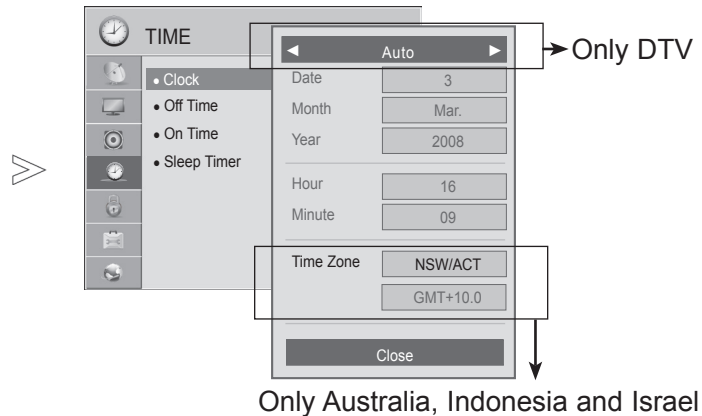

GMT (Greenwich Mean Time) which is received with the broadcast signal and the time is set automatically by a digital signal.

Time Zone is activated only in **Auto** Mode.



■ Image shown may differ from your TV.



-   Select **TIME**.
-   Select **Clock**.
-   Select **Auto** or **Manual**. (Only DTV)
-   Select either the year, month, date, time or Time Zone(Only Australia, Indonesia and Israel) option.
-   Set the year, month, date, time or Time Zone (Only Australia, Indonesia and Israel) option.

- Press the **MENU/EXIT** button to return to normal TV viewing.
- Press the **BACK** button to move to the previous menu screen.

TIME SETTING

AUTO ON/OFF TIME SETTING

The Off time function automatically switches the TV to standby at a preset time.

Two hours after the TV is switched on by the on time function it will automatically switch back to standby mode unless a button has been pressed. (Except for 32/37/42/47LD460C, 32/37/42/47/55LE750C, 32/37/42/47/55LE530C)

The Off time function overrides the On time function if both are set to the same time.

The TV must be in standby mode for the On time to work.

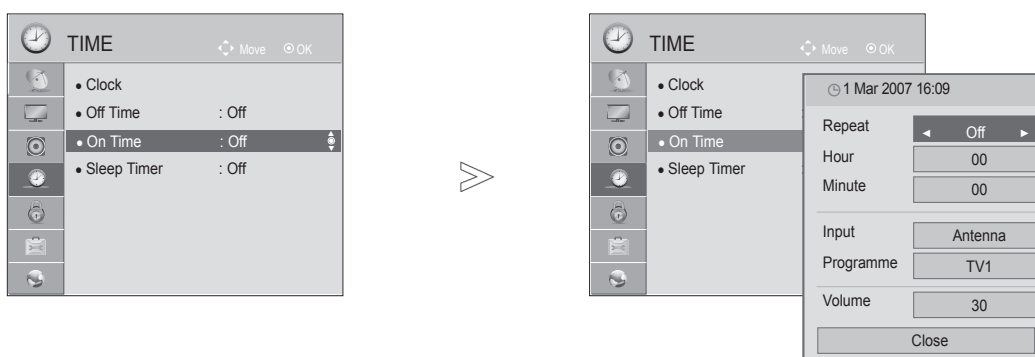

- 1 Select **TIME**.
- 2 Select **Off Time** or **On Time**.
- 3 Select **Repeat**.
- 4 Select **Off, Once, Daily, Mon. ~ Fri., Mon. ~ Sat., Sat. ~ Sun. or Sun..**
- 5 Set the hour.
- 6 Set the minutes.

- To cancel **On/Off Time** function, select **Off**.
- For On Time function only

- 1 Select **Input**.
- 2 Select the input source.
- 3 Set the programme.
- 4 Adjust volume level at switch-on.

- Press the **MENU/EXIT** button to return to normal TV viewing.
- Press the **BACK** button to move to the previous menu screen.

SLEEP TIMER SETTING

You do not have to remember to switch the TV off before you go to sleep.

The sleep timer automatically switches the TV to standby after the preset time has elapsed.

1   Select **Sleep Timer**.

2   Select **Off, 10, 20, 30, 60, 90, 120, 180 or 240 min.**

- When you switch the TV off, the preset sleep timer is cancelled.
- You can also adjust **Sleep Timer** in the **TIME** menu.









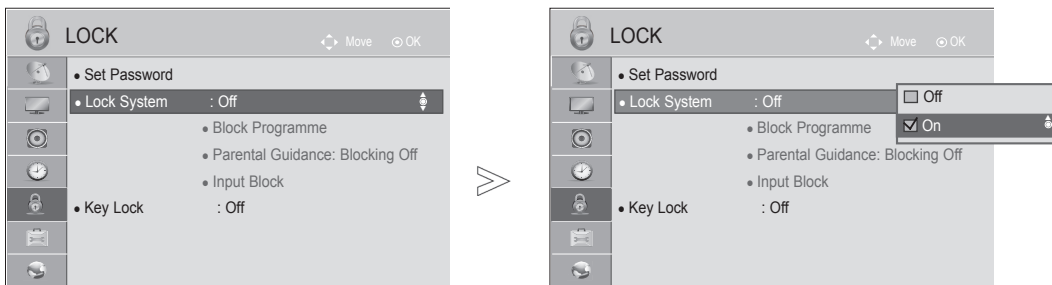

PARENTAL CONTROL / RATINGS

SET PASSWORD & LOCK SYSTEM

Enter the password, press '0', '0', '0', '0' on the remote control handset.

If a channel is locked, enter the password to unlock it temporarily.



-   Select **LOCK**.
-   Select **Lock System**.
-   Select **On**.
-    Set the password.
-  Input a 4-digit password.
Be sure to remember this number!
Re-enter new password for confirm.

• If you forget your password, press '0', '3', '2', '5' on the remote control handset.

- Press the **MENU/EXIT** button to return to normal TV viewing.
- Press the **BACK** button to move to the previous menu screen.

BLOCK PROGRAMME







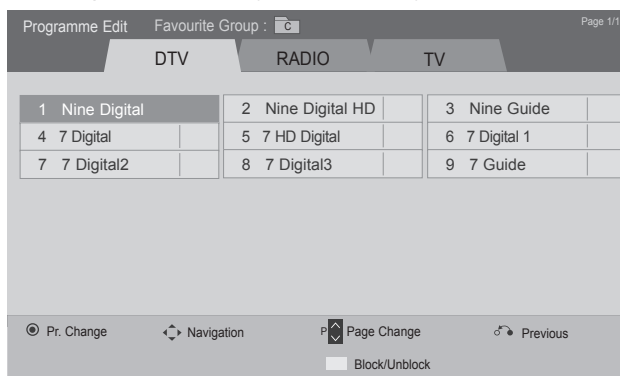
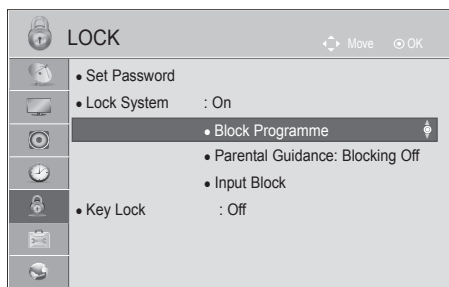

Blocks any programme that you do not want to watch or that you do not want your children to watch.

It is available to use this function in **Lock System "On"**.

Enter a password to watch a blocked programme.

■ Image shown may differ from your TV.



- 1   Select **LOCK**.
- 2   Select **Lock System**.
- 3   Select **Block Programme**.
- 4  Enter the **Block Programme**.
- 5   Select a programme to be locked.

- Press the **MENU/EXIT** button to return to normal TV viewing.
- Press the **BACK** button to move to the previous menu screen.

PARENTAL CONTROL / RATINGS

PARENTAL CONTROL (IN DIGITAL MODE ONLY) (Only DTV)

This function operates according to information from the broadcasting station. Therefore if the signal has incorrect information, this function does not operate.

A password is required to gain access to this menu.





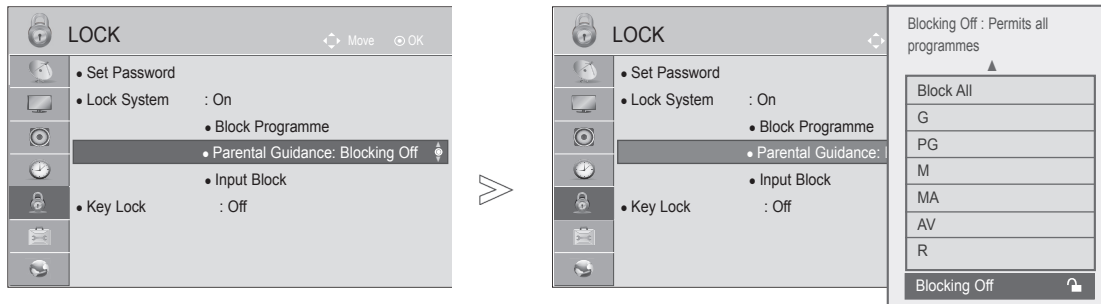

This set is programmed to remember which option it was last set to even if you switch the set off.

Prevents children from watching certain adult's TV programmes, according to the ratings limit set. Enter a password to watch a blocked programme.

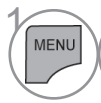
Rating differs by country.

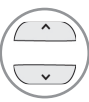
■ Image shown may differ from your TV.



-   Select **LOCK**.
-   Select **Lock System**.
-   Select **Parental Guidance**.
-   Make appropriate adjustments.









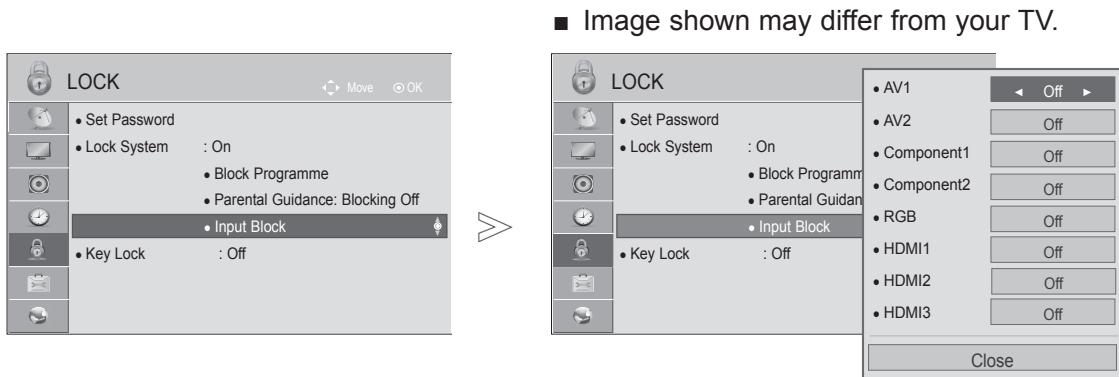

- Press the **MENU/EXIT** button to return to normal TV viewing.
- Press the **BACK** button to move to the previous menu screen.

EXTERNAL INPUT BLOCKING

Enables you to block an input.

It is available to use this function in **Lock System "On"**.



- 1   Select **LOCK**.
- 2   Select **Lock System**.
- 3   Select **Input Block**.
- 4   Select input source.
- 5   Select **On** or **Off**.

- Press the **MENU/EXIT** button to return to normal TV viewing.
- Press the **BACK** button to move to the previous menu screen.

PARENTAL CONTROL / RATINGS



KEY LOCK

This feature can be used to prevent unauthorized viewing by locking out the front panel controls, so that it can only be used with the remote control.

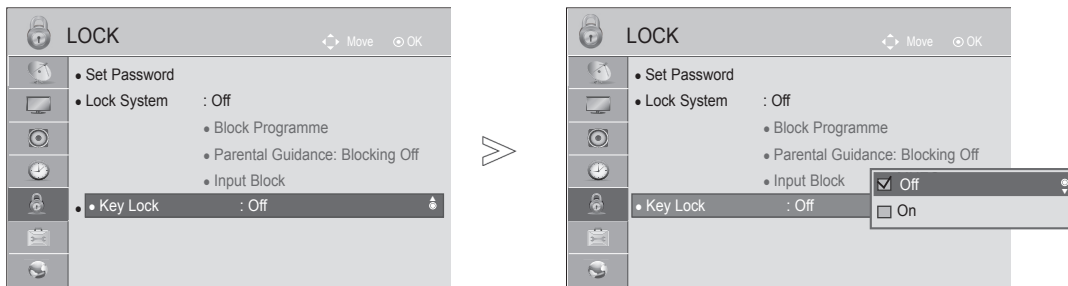
This TV is programmed to remember which option it was last set to even if you turn the TV off.



- 1   Select **LOCK**.
- 2   Select **Key Lock**.
- 3   Select **On** or **Off**.

- In **Key Lock 'On'**, if the TV is turned off, press the  / I, INPUT, P ^ v button on the TV or POWER INPUT, P ^ v or NUMBER buttons on the remote control then the set will be turned on.
- With the **Key Lock On**, the display ' **Key Lock On**' appears on the screen if any button on the front panel is pressed while viewing the TV.
- When another OSD is displayed, ' **Key Lock On**' will not operate.

- Press the **MENU/EXIT** button to return to normal TV viewing.
- Press the **BACK** button to move to the previous menu screen.

TELETEXT

This feature is not available in all countries.

Teletext is a free service broadcast by most TV stations which gives up-to-the-minute information on news, weather, television programmes, share prices and many other topics.

The teletext decoder of this TV can support the SIMPLE, TOP and FASTEXT systems. SIMPLE (standard teletext) consists of a number of pages which are selected by directly entering the corresponding page number. TOP and FASTEXT are more modern methods allowing quick and easy selection of teletext information.

SWITCH ON/OFF

Press the **TEXT** button to switch to teletext. The initial page or last page viewed appears on the screen.

Two page numbers, TV station name, date and time are displayed on the screen headline. The first page number indicates your selection, while the second shows the current page displayed.

Press the **TEXT** button to switch off teletext. The previous mode reappears.

SIMPLE TEXT

■ Page selection

- 1 Enter the desired page number as a three digit number with the NUMBER buttons. If during selection you press a wrong number, you must complete the three digit number and then re-enter the correct page number.
- 2 The P ^ v button can be used to select the preceding or following page.

TELETEXT

TOP TEXT

The user guide displays four fields-red, green, yellow and blue at the bottom of the screen. The yellow field denotes the next group and the blue field indicates the next block.

■ Block / group / page selection

- ① With the blue button you can progress from block to block.
- ② Use the yellow button to proceed to the next group with automatic overflow to the next block.
- ③ With the green button you can proceed to the next existing page with automatic overflow to the next group.
- ④ Alternatively the P ^ button can be used.
The red button returns to the previous selection. Alternatively the P v button can be used.

■ Direct page selection

As with SIMPLE teletext mode, you can select a page by entering it as a three digit number using the NUMBER buttons in TOP mode.

FASTEXT

The teletext pages are colour coded along the bottom of the screen and are selected by pressing the corresponding coloured button.

■ Page selection

- ① Press the **T.OPT** button and then use ^ v button to select Ξi menu. Display the index page.
- ② You can select the pages which are colour coded along the bottom line with corresponding coloured buttons.
- ③ AS with SIMPLE teletext mode, you can select a page by entering its three digit page number with the NUMBER buttons in FASTEXT mode.
- ④ The P ^ v button can be used to select the preceding or following page.

SPECIAL TELETEXT FUNCTIONS

Press the **T. OPT** button and then use $\wedge \vee$ button to select the **Text Option** menu.



■ Index

Select the each index page.



■ Time

When viewing a TV programme, select this menu to display the time at the top right hand corner of the screen.

In the teletext mode, press this button to select a sub page number. The sub page number is displayed at the bottom of the screen. To hold or change the sub page, press the RED/GREEN, < > or NUMBER buttons.

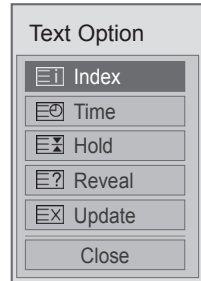

■ Hold

Stops the automatic page change which will occur if a teletext page consists of 2 or more sub pages. The number of sub pages and the sub page displayed is, usually, shown on the screen below the time. When this menu is selected the stop symbol is displayed at the top left-hand corner of the screen and the automatic page change is inactive.



■ Reveal

Select this menu to display concealed information, such as solutions to riddles or puzzles.



■ Update

Displays the TV picture on the screen while waiting for a new teletext page. The display will appear at the top left hand corner of the screen. When the updated page is available then display will change to the page number. Select this menu again to view the updated teletext page.

APPENDIX

TROUBLESHOOTING

The TV does not operate properly.	
The remote control does not work	<ul style="list-style-type: none"> ■ Check to see if there is any object between the TV and the remote control causing an obstruction. Ensure you are pointing the remote control directly at the TV. ■ Ensure that the batteries are installed with correct polarity (+ to +, - to -). ■ Install new batteries.
Power is suddenly turned off	<ul style="list-style-type: none"> ■ Is the sleep timer set? ■ Check the power control settings. Has the Power supply been interrupted. ■ If the TV is switched on and there is no input signal, it will switch off automatically after 15 minutes.(Except for 32/37/42/47LD460C, 32/37/42/47/55LE750C, 32/37/42/47/55LE530C)

The video function does not work.	
No picture & No sound	<ul style="list-style-type: none"> ■ Check whether the TV is switched on. ■ Try another channel. The problem may be with the broadcast. ■ Is the power cord inserted correctly into the mains? ■ Check your antenna direction and/or location. ■ Test the mains outlet by plugging another TV into the same outlet.
Picture appears slowly after switching on	<ul style="list-style-type: none"> ■ This is normal, the image is muted during the TV startup process. Please contact your service centre, if the picture has not appeared after five minutes.
No or poor colour or poor picture	<ul style="list-style-type: none"> ■ Adjust Colour in menu option. ■ Allow a sufficient distance between the TV and the VCR. ■ Try another channel. The problem may be with the broadcast. ■ Are the video cables installed properly? ■ Activate any function to restore the brightness of the picture.
Horizontal/vertical bars or picture shaking	<ul style="list-style-type: none"> ■ Check for local interference such as an electrical appliance or power tool.
Poor reception on some channels	<ul style="list-style-type: none"> ■ Station or cable channel experiencing problems, tune to another station. ■ Station signal is weak, reposition the antenna to receive weaker stations. ■ Check for sources of possible interference.
Lines or streaks in pictures	<ul style="list-style-type: none"> ■ Check antenna (Change the position of the antenna).
No picture when connecting HDMI	<ul style="list-style-type: none"> ■ Check that your HDMI cable is High Speed HDMI Cable. If the HDMI cables are not High Speed HDMI Cable, flickering or no screen display can result. Please use the High Speed HDMI Cable.

The audio function does not work.

Picture OK & No sound	<ul style="list-style-type: none">■ Press the \triangleleft + or - button.■ Sound muted? Press MUTE button.■ Try another channel. The problem may be with the broadcast.■ Are the audio cables installed properly?
No output from one of the speakers	<ul style="list-style-type: none">■ Adjust Balance in menu option.
Unusual sound from inside the TV	<ul style="list-style-type: none">■ A change in ambient humidity or temperature may result in an unusual noise when the TV is switched on or off and does not indicate a fault with the TV.
No sound when connecting HDMI or USB	<ul style="list-style-type: none">■ Check HDMI cable is High Speed HDMI Cable.■ Check USB cable over version 2.0. <p style="text-align: right;">*This feature is not available for all models.</p>

There is a problem in PC mode. (Only PC mode applied)

The signal is out of range (Invalid format)	<ul style="list-style-type: none">■ Adjust resolution, horizontal frequency, or vertical frequency.■ Check the input source.
Vertical bar or stripe on background & Horizontal Noise & Incorrect position	<ul style="list-style-type: none">■ Use Auto configure or adjust clock, phase, or H/V position. (Option)
Screen colour is unstable or single colour	<ul style="list-style-type: none">■ Check the signal cable.■ Reinstall the PC video card.

There is a problem with PICTURE settings.

When the user changes the picture settings, the TV automatically converts back to the initial settings after a certain period of time.	<ul style="list-style-type: none">■ It means that the TV is currently set to Store Demo mode. To switch to Home use mode you should do the followings: From the TV Menu, choose OPTION -> Choose Mode Setting -> Choose Home use. Now, you have completed switching to the Home use mode.
--	---

APPENDIX

MAINTENANCE

Early malfunctions can be prevented. Careful and regular cleaning can prolong the life of your new TV.

Caution: Be sure to switch the power off and unplug the power cord before you begin any cleaning.

Cleaning the Screen

- 1 A good way to keep the dust off your screen for a while is to wet a soft cloth in a mixture of luke-warm water and a little fabric softener or dish washing detergent. Wring the cloth until it is almost dry, and then use it to wipe the screen.
- 2 Ensure there is no excess water on the screen. Allow any water or dampness to evaporate before switching on.

Cleaning the Cabinet

- To remove dirt or dust, wipe the cabinet with a soft, dry, lint-free cloth.
- Do not to use a wet cloth.

Extended Absence

⚠ CAUTION

- ▶ If you expect to leave your TV dormant for prolonged periods (such as a holiday), unplug the power cord to protect against possible damage from lightning or power surges.

PRODUCT SPECIFICATIONS

MODELS		22LD3**	
		22LD350-TA	
Dimensions (Width x Height x Depth)	with stand	526.0 mm x 377.0 mm x 165 mm	
	without stand	526.0 mm x 331.0 mm x 65 mm	
Weight	with stand	4.3 kg	
	without stand	4.0 kg	
Power requirement		AC 100-240 V~ 50 / 60 Hz	
MODELS		26LD3**	32LD3**
		26LD350-TA	32LD350-TA
Dimensions (Width x Height x Depth)	with stand	663.0 mm x 484.0 mm x 207 mm	800.0 mm x 565.0 mm x 207 mm
	without stand	663.0 mm x 423.0 mm x 79.9 mm	800.0 mm x 509.0 mm x 73.8 mm
Weight	with stand	7.3 kg	9.2 kg
	without stand	6.2 kg	8.2 kg
Power requirement		AC 100-240 V~ 50 / 60 Hz	AC 100-240 V~ 50 / 60 Hz
Environment condition	Operating Temperature	0 °C to 40 °C	
	Operating Humidity	Less than 80 %	
	Storage Temperature	-20 °C to 60 °C	
	Storage Humidity	Less than 85 %	

- The specifications shown above may be changed without prior notice for quality improvement.

APPENDIX

MODELS		32LD4**		37LD4**
		32LD460-TA 32LD461C-TA 32LD461F-TB 32LD460C-TA	32LD450-TA	37LD460-TA 37LD461C-TA 37LD461F-TB 37LD460C-TA
Dimensions (Width x Height x Depth)	with stand	799.0 mm x 555.0 mm x 207.0 mm	799.0 mm x 555.0 mm x 207.0 mm	916.0 mm x 625.0 mm x 261.0 mm
	without stand	799.0 mm x 516 mm x 73.5 mm	799.0 mm x 506.0 mm x 73.5 mm	916.0 mm x 584 mm x 77.4 mm
Weight	with stand	9.6 kg	9.1 kg	12.9 kg
	without stand	8.6 kg	8.1 kg	11.2 kg
Power requirement		AC 100-240 V~ 50 / 60 Hz	AC 100-240 V~ 50 / 60 Hz	AC 100-240 V~ 50 / 60 Hz
MODELS		42LD4**		47LD4**
		42LD460-TA 42LD461C-TA 42LD461F-TB 42LD460C-TA	42LD450-TA	47LD460-TA 47LD461C-TA 47LD461F-TB 47LD460C-TA
Dimensions (Width x Height x Depth)	with stand	1023.0 mm x 685.0 mm x 261.0 mm	1023.0 mm x 685.0 mm x 261.0 mm	1136.0 mm x 757.0 mm x 270.0 mm
	without stand	1023.0 mm x 644 mm x 76.6 mm	1023.0 mm x 635.0 mm x 76.6 mm	1136.0 mm x 706 mm x 76.5 mm
Weight	with stand	15.4 kg	15.1 kg	19.6 kg
	without stand	13.7 kg	13.5 kg	17.6 kg
Power requirement		AC 100-240 V~ 50 / 60 Hz	AC 100-240 V~ 50 / 60 Hz	AC 100-240 V~ 50 / 60 Hz
Environment condition	Operating Temperature	0 °C to 40 °C		
	Operating Humidity	Less than 80 %		
	Storage Temperature	-20 °C to 60 °C		
	Storage Humidity	Less than 85 %		
Supported movie files		Refer to p.82 to 84		

- The specifications shown above may be changed without prior notice for quality improvement.

MODELS		32LD5**	42LD5**	
		32LD550-TA 32LD560-TA	42LD550-TA 42LD560-TA	
Dimensions (Width x Height x Depth)	with stand	800.0 mm x 563.0 mm x 207.0 mm	1024.0 mm x 695.0 mm x 261.0 mm	
	without stand	800.0 mm x 503.0 mm x 74.7 mm	1024.0 mm x 632.0 mm x 78.7 mm	
Weight	with stand	9.7 kg	15.4 kg	
	without stand	8.7 kg	13.8 kg	
Power requirement		AC 100-240 V~ 50 / 60 Hz	AC 100-240 V~ 50 / 60 Hz	
MODELS		46LD5**	52LD5**	60LD5**
		46LD550-TA	52LD550-TA 52LD560-TA	60LD550-TA
Dimensions (Width x Height x Depth)	with stand	1115.0 mm x 752.0 mm x 270.0 mm	1266.0 mm x 851.0 mm x 330.0 mm	1441 mm x 963.0 mm x 345.0 mm
	without stand	1115.0 mm x 680.0 mm x 77.0 mm	1266.0 mm x 775.0 mm x 96.4 mm	1441 mm x 877.0 mm x 109.0 mm
Weight	with stand	18.6 kg	26.9 kg	40.0 kg
	without stand	16.6 kg	23.6 kg	35.7 kg
Power requirement		AC 100-240 V~ 50 / 60 Hz	AC 100-240 V~ 50 / 60 Hz	AC 100-240 V~ 50 / 60 Hz
Environment condition	Operating Temperature	0 °C to 40 °C		
	Operating Humidity	Less than 80 %		
	Storage Temperature	-20 °C to 60 °C		
	Storage Humidity	Less than 85 %		
Supported movie files		Refer to p.82 to 84		

- The specifications shown above may be changed without prior notice for quality improvement.

APPENDIX

MODELS		32LD6**	37LD6**	
		32LD650-TA	37LD650-TA	
Dimensions (Width x Height x Depth)	with stand	797.0 mm x 555.0 mm x 207.0 mm	916.0 mm x 625.0 mm x 261.0 mm	
	without stand	797.0 mm x 495.0 mm x 73.8 mm	916.0 mm x 560.0 mm x 77.7 mm	
Weight	with stand	9.8 kg	12.8 kg	
	without stand	8.7 kg	11.2 kg	
Power requirement		AC 100-240 V~ 50 / 60 Hz		AC 100-240 V~ 50 / 60 Hz
MODELS		42LD6**	47LD6**	55LD6**
		42LD650-TA	47LD650-TA	55LD650-TA
Dimensions (Width x Height x Depth)	with stand	1024.0 mm x 685.0 mm x 261.0 mm	1137.0 mm x 758.0 mm x 270.0 mm	1329.0 mm x 872.0 mm x 330.0 mm
	without stand	1024.0 mm x 621.0 mm x 76.8 mm	1137.0 mm x 685.0 mm x 76.8 mm	1329.0 mm x 796.0 mm x 96.5 mm
Weight	with stand	15.5 kg	20.3 kg	33.0 kg
	without stand	13.9 kg	18.3 kg	29.8 kg
Power requirement		AC 100-240 V~ 50 / 60 Hz	AC 100-240 V~ 50 / 60 Hz	AC 100-240 V~ 50 / 60 Hz
Environment condition	Operating Temperature	0 °C to 40 °		
	Operating Humidity	Less than 80 %		
	Storage Temperature	-20 °C to 60 °C		
	Storage Humidity	Less than 85 %		
Supported movie files		Refer to p.82 to 84		

- The specifications shown above may be changed without prior notice for quality improvement.

MODELS		32LE4***	42LE4***
		32LE4600-TA	42LE4600-TA
Dimensions (Width x Height x Depth)	with stand	786 mm x 562 mm x 272 mm	1018 mm x 696 mm x 318 mm
	without stand	786 mm x 500 mm x 39.9 mm	1018 mm x 627 mm x 29.8 mm
Weight	with stand	14.5 kg	21.9 kg
	without stand	10.6 kg	17.2 kg
Power requirement		AC 100-240 V~ 50 / 60 Hz	AC 100-240 V~ 50 / 60 Hz
MODELS		47LE4***	55LE4***
		47LE4600-TA	55LE4600-TA
Dimensions (Width x Height x Depth)	with stand	1128 mm x 759 mm x 318 mm	1311 mm x 866 mm x 330 mm
	without stand	1128 mm x 693 mm x 29.8 mm	1311 mm x 798 mm x 31.4 mm
Weight	with stand	24.9 kg	36.6 kg
	without stand	20.3 kg	30.3 kg
Power requirement		AC 100-240 V~ 50 / 60 Hz	AC 100-240 V~ 50 / 60 Hz
Environment condition	Operating Temperature	0 °C to 40 °C	
	Operating Humidity	Less than 80 %	
	Storage Temperature	-20 °C to 60 °C	
	Storage Humidity	Less than 85 %	
Supported movie files		Refer to p.82 to 84	

- The specifications shown above may be changed without prior notice for quality improvement.

APPENDIX

MODELS		22LE5***	26LE5*** / 26LE3***
		22LE5300-TA 22LE5310-TC	26LE5300-TA 26LE5310-TC 26LE3300-TA
Dimensions (Width x Height x Depth)	with stand	542.9 mm x 407.1 mm x 155.4 mm	652.0 mm x 480.8 mm x 191.4 mm
	without stand	542.9 mm x 357.6 mm x 34.4 mm	652.0 mm x 420.3 mm x 34.4 mm
Weight	with stand	4.2 kg	6.1 kg
	without stand	3.9 kg	5.1 kg
Power requirement		DC 24 V, 1.7 A AC-DC adaptor : 24 V $\overline{\text{---}}$, 3.42 A / AC 100-240 V~ 50 / 60 Hz	DC 24 V, 1.8 A AC-DC adaptor : 24 V $\overline{\text{---}}$, 3.42 A / AC 100-240 V~ 50 / 60 Hz
MODELS		32LE5***	32LE3***
		32LE5300-TA 32LE5310-TC 32LE530C-TA	32LE3300-TA
Dimensions (Width x Height x Depth)	with stand	784.6 mm x 558.1 mm x 221.0 mm	771.8 mm x 552.3 mm x 221.0 mm
	without stand	784.6 mm x 499.5 mm x 39.9 mm	771.8 mm x 489.3 mm x 39.9 mm
Weight	with stand	12.4 kg	12.4 kg
	without stand	10.5 kg	10.5 kg
Power requirement		AC 100-240 V~ 50 / 60 Hz	AC 100-240 V~ 50 / 60 Hz
Environment condition	Operating Temperature	0 °C to 40 °C	
	Operating Humidity	Less than 80 %	
	Storage Temperature	-20 °C to 60 °C	
	Storage Humidity	Less than 85 %	
Supported movie files		Refer to p.82 to 84	

- The specifications shown above may be changed without prior notice for quality improvement.



MODELS		37LE5***	42LE5***
		37LE5300-TA 37LE5310-TC 37LE530C-TA	42LE5300-TA 42LE5310-TC 42LE530C-TA
Dimensions (Width x Height x Depth)	with stand	905 mm x 630 mm x 270mm	1016.0 mm x 692.0 mm x 270.0 mm
	without stand	905 mm x 568 mm x 39.9 mm	1016.0 mm x 630.0 mm x 29.3 mm
Weight	with stand	15.3 kg	19.2 kg
	without stand	12.8 kg	16.7 kg
Power requirement		AC 100-240 V~ 50 / 60 Hz	AC 100-240 V~ 50 / 60 Hz
MODELS		47LE5***	55LE5***
		47LE5300-TA 47LE5310-TC 47LE530C-TA	55LE5300-TA 55LE5310-TC 55LE530C-TA
Dimensions (Width x Height x Depth)	with stand	1126.6 mm x 757.9 mm x 284.4 mm	1306.0 mm x 867.0 mm x 328.0 mm
	without stand	1126.6 mm x 692.0 mm x 29.3 mm	1306.0 mm x 797.0 mm x 30.7 mm
Weight	with stand	22.6 kg	34.0 kg
	without stand	19.6 kg	28.8 kg
Power requirement		AC 100-240 V~ 50 / 60 Hz	AC 100-240 V~ 50 / 60 Hz
Environment condition	Operating Temperature	0 °C to 40 °C	
	Operating Humidity	Less than 80 %	
	Storage Temperature	-20 °C to 60 °C	
	Storage Humidity	Less than 85 %	
Supported movie files		Refer to p.82 to 84	

- The specifications shown above may be changed without prior notice for quality improvement.

APPENDIX

MODELS		32LE5***	37LE5***
		32LE5500-TA 32LE5510-TB 32LE551C-TA	37LE5500-TA 37LE5510-TB 37LE551C-TA
Dimensions (Width x Height x Depth)	with stand	784.6 mm x 558.1 mm x 221.0 mm	905 mm x 630 mm x 270mm
	without stand	784.6 mm x 499.5 mm x 39.9 mm	905 mm x 568 mm x 39.9 mm
Weight	with stand	12.7 kg	15.6 kg
	without stand	10.5 kg	12.8 kg
Power requirement		AC 100-240 V~ 50 / 60Hz	AC 100-240 V~ 50 / 60Hz
MODELS		42LE5***	47LE5***
		42LE5500-TA 42LE5510-TB 42LE551C-TA	47LE5500-TA 47LE5510-TB 47LE551C-TA
Dimensions (Width x Height x Depth)	with stand	1016.0 mm x 692.0 mm x 270.0 mm	1126.6 mm x 757.9 mm x 284.4 mm
	without stand	1016.0 mm x 630.0 mm x 29.3 mm	1126.6 mm x 692.0 mm x 29.3 mm
Weight	with stand	19.5 kg	22.9 kg
	without stand	16.7 kg	19.6 kg
Power requirement		AC 100-240 V~ 50 / 60Hz	AC 100-240 V~ 50 / 60Hz
Environment condition	Operating Temperature	0 °C to 40 °C	
	Operating Humidity	Less than 80 %	
	Storage Temperature	-20 °C to 60 °C	
	Storage Humidity	Less than 85 %	
Supported movie files		Refer to p.82 to 84	

- The specifications shown above may be changed without prior notice for quality improvement.

MODELS		55LE5***	
		55LE5500-TA 55LE5510-TB 55LE551C-TA	
Dimensions (Width x Height x Depth)	with stand	1306.0 mm x 867.0 mm x 328.0 mm	
	without stand	1306.0 mm x 797.0 mm x 30.7 mm	
Weight	with stand	34.5 kg	
	without stand	28.8 kg	
Power requirement		AC 100-240 V~ 50 / 60 Hz	
MODELS		22LE6***	26LE6***
		22LE6500-TA	26LE6500-TA
Dimensions (Width x Height x Depth)	with stand	533.0 mm x 400.0 mm x 187.0 mm	650.0 mm x 469.0 mm x 187.0 mm
	without stand	533.0 mm x 349.0 mm x 39.9 mm	650.0 mm x 418.0 mm x 39.9 mm
Weight	with stand	3.4 kg	4.9 kg
	without stand	3.1 kg	4.6 kg
Power requirement		DC 24 V, 1.7 A AC-DC adaptor : 24 V  , 3.42 A / AC 100-240 V~ 50 / 60 Hz	DC 24 V, 2.1 A AC-DC adaptor : 24 V  , 3.42 A / AC 100-240 V~ 50 / 60 Hz
Environment condition	Operating Temperature	0 °C to 40 °C	
	Operating Humidity	Less than 80 %	
	Storage Temperature	-20 °C to 60 °C	
	Storage Humidity	Less than 85 %	
Supported movie files		Refer to p.82 to 84	

- The specifications shown above may be changed without prior notice for quality improvement.

APPENDIX

MODELS		32LE7***	37LE7***	
		32LE7500-TA 32LE750C-TA	37LE7500-TA 37LE750C-TA	
Dimensions (Width x Height x Depth)	with stand	786.4 mm x 557.6 mm x 221.0 mm	907.4 mm x 629.3 mm x 269.8 mm	
	without stand	786.4 mm x 500.4 mm x 39.9 mm	907.4 mm x 569.0 mm x 39.9 mm	
Weight	with stand	13.9 kg	17.5 kg	
	without stand	11.7 kg	14.7 kg	
Power requirement		AC 100-240 V~ 50 / 60Hz	AC 100-240 V~ 50 / 60Hz	
MODELS		42LE7***	47LE7***	55LE7***
		42LE7500-TA 42LE750C-TA	47LE7500-TA 47LE750C-TA	55LE7500-TA 55LE750C-TA
Dimensions (Width x Height x Depth)	with stand	1018.2 mm x 693.5 mm x 269.8 mm	1128.6 mm x 758.9 mm x 284.4 mm	1306.0 mm x 869 mm x 328.0 mm
	without stand	1018.2 mm x 630.7 mm x 29.3 mm	1128.6 mm x 693.3 mm x 29.8 mm	1306.0 mm x 797.4 mm x 31.2 mm
Weight	with stand	21.9 kg	26.2 kg	39.1 kg
	without stand	19.1 kg	23.0 kg	33.5 kg
Power requirement		AC 100-240 V~ 50 / 60Hz	AC 100-240 V~ 50 / 60Hz	AC 100-240 V~ 50 / 60Hz
Environment condition	Operating Temperature	0 °C to 40 °C		
	Operating Humidity	Less than 80 %		
	Storage Temperature	-20 °C to 60 °C		
	Storage Humidity	Less than 85 %		
Supported movie files		Refer to p.82 to 84		

- The specifications shown above may be changed without prior notice for quality improvement.

MODELS		42LE8***	47LE8***
		42LE8500-TA	47LE8500-TA
Dimensions (Width x Height x Depth)	with stand	1013.3 mm x 705.8 mm x 235.5 mm	1122.6 mm x 769.3 mm x 275.0 mm
	without stand	1013.3 mm x 645.8 mm x 34.5 mm	1122.6 mm x 707.3 mm x 34.5 mm
Weight	with stand	27.2 kg	31.6 kg
	without stand	23.1 kg	27.0 kg
Power requirement		AC 100-240 V~ 50 / 60Hz	AC 100-240 V~ 50 / 60Hz
MODELS		55LE8***	55LE8500-TA
		55LE8500-TA	
Dimensions (Width x Height x Depth)	with stand	1292.6 mm x 875.4 mm x 311.9 mm	
	without stand	1292.6 mm x 802.9 mm x 34.5 mm	
Weight	with stand	43.8 kg	
	without stand	35.8 kg	
Power requirement		AC 100-240 V~ 50 / 60Hz	
Environment condition	Operating Temperature	0 °C to 40 °C	
	Operating Humidity	Less than 80 %	
	Storage Temperature	-20 °C to 60 °C	
	Storage Humidity	Less than 85 %	
Supported movie files		Refer to p.82 to 84	

- The specifications shown above may be changed without prior notice for quality improvement.

APPENDIX

MODELS		32LE4***	42LE4***
		32LE4500-TA	42LE4500-TA
Dimensions (Width x Height x Depth)	with stand	786.0 mm x 559.0 mm x 221.0 mm	1018.0 mm x 692.0 mm x 270.0 mm
	without stand	786.0 mm x 500.0 mm x 39.9 mm	1018.0 mm x 627.0 mm x 29.8 mm
Weight	with stand	12.4 kg	19.7 kg
	without stand	10.6 kg	17.2 kg
Power requirement		AC 100-240 V~ 50 / 60Hz	AC 100-240 V~ 50 / 60Hz
Environment condition	Operating Temperature	0 °C to 40 °C	
	Operating Humidity	Less than 80 %	
	Storage Temperature	-20 °C to 60 °C	
	Storage Humidity	Less than 85 %	
Supported movie files		Refer to p.82 to 84	

- The specifications shown above may be changed without prior notice for quality improvement.

MODELS		47LX9***	55LX9***	
		47LX9500-TA	55LX9500-TA	
Dimensions (Width x Height x Depth)	with stand	1085.9 mm x 710.6 mm x 255.0 mm	1255.8 mm x 805.0 mm x 255.0 mm	
	without stand	1085.9 mm x 654.2 mm x 31.6 mm	1255.8 mm x 749.6 mm x 31.6 mm	
Weight	with stand	26.7 kg	32.7 kg	
	without stand	22.1 kg	28.1 kg	
Power requirement		AC 100-240 V~ 50 / 60 Hz	AC 100-240 V~ 50 / 60 Hz	
MODELS		42LX6***	47LX6***	55LX6***
		42LX6500-TD	47LX6500-TD	55LX6500-TD
Dimensions (Width x Height x Depth)	with stand	1016.0 mm x 692.0 mm x 270.0 mm	1126.6 mm x 757.9 mm x 284.4 mm	1306.0 mm x 867.0 mm x 328.0 mm
	without stand	1016.0 mm x 630.0 mm x 29.3 mm	1126.6 mm x 692.0 mm x 29.3 mm	1306.0 mm x 797.0 mm x 30.7 mm
Weight	with stand	19.5 kg	22.9 kg	34.5 kg
	without stand	16.7 kg	19.6 kg	28.8 kg
Power requirement		AC 100-240 V~ 50 / 60 Hz	AC 100-240 V~ 50 / 60 Hz	AC 100-240 V~ 50 / 60 Hz
Environment condition	Operating Temperature	0 °C to 40 °C		
	Operating Humidity	Less than 80 %		
	Storage Temperature	-20 °C to 60 °C		
	Storage Humidity	Less than 85 %		
Supported movie files		Refer to p.82 to 84		

- The specifications shown above may be changed without prior notice for quality improvement.

APPENDIX

		Digital TV	Analogue TV
New Zealand, Singapore	Television System	DVB-T	PAL/SECAM-B/G/D/K, PAL-I
	Program Coverage	UHF 21 to 69	BG : VHF/UHF 1 to 69, CATV 01 to 47 I : VHF/UHF 1 to 69, CATV 01 to 47 DK : VHF/UHF 1 to 69, CATV 01 to 47
Australia	Television System	DVB-T	PAL B/B
	Program Coverage	VHF 06 to 12, UHF 27 to 69	B/B : VHF/UHF 0 to 75, CATV : 2 to 44
Indonesia, Israel	Television System	DVB-T	PAL/SECAM-B/G/D/K, PAL-I, NTSC-M
	Program Coverage	UHF 21 to 69	BG : VHF/UHF 1 to 69, CATV 01 to 47 I : VHF/UHF 1 to 69, CATV 01 to 47 DK : VHF/UHF 1 to 69, CATV 01 to 47 M : VHF/UHF 2 to 78, CATV 01 to 71
South Africa	Television System	DVB-T	PAL/SECAM-B/G/D/K, PAL-I, NTSC-M
	Program Coverage	VHF 4 to 11, 13 UHF 21 to 68	BG : VHF/UHF 1 to 69, CATV 01 to 47 I : VHF/UHF 1 to 69, CATV 01 to 47 DK : VHF/UHF 1 to 69, CATV 01 to 47 M : VHF/UHF 2 to 78, CATV 01 to 71
Veitnam, Malaysia	Television System	DVB-T	PAL/SECAM-B/G/D/K, PAL-I, NTSC-M
	Program Coverage	VHF 6 to 12, UHF 21 to 69	BG : VHF/UHF 1 to 69, CATV 01 to 47 I : VHF/UHF 1 to 69, CATV 01 to 47 DK : VHF/UHF 1 to 69, CATV 01 to 47 M : VHF/UHF 2 to 78, CATV 01 to 71
Iran	Television System	DVB-T	PAL/SECAM-B/G/D/K, PAL-I, NTSC-M
	Program Coverage	VHF 5 to 12, UHF 21 to 69	BG : VHF/UHF 1 to 69, CATV 01 to 47 I : VHF/UHF 1 to 69, CATV 01 to 47 DK : VHF/UHF 1 to 69, CATV 01 to 47 M : VHF/UHF 2 to 78, CATV 01 to 71
Analogue model	Television System	-	PAL/SECAM-B/G/D/K, PAL-I, NTSC-M
	Program Coverage	-	BG : VHF/UHF 1 to 69, CATV 01 to 47 I : VHF/UHF 1 to 69, CATV 01 to 47 DK : VHF/UHF 1 to 69, CATV 01 to 47 M : VHF/UHF 2 to 78, CATV 01 to 71
	External Antenna Impedance	75 Ω	75 Ω

- The specifications shown above may be changed without prior notice for quality improvement.

IR CODES

This feature is not available for all models.

Code (Hexa)	Function	Note
95	Energy Saving	R/C BUTTON
08	POWER	R/C BUTTON(POWER ON/OFF)
0B	INPUT	R/C BUTTON
79	RATIO	R/C BUTTON
F0	TV/RAD	R/C BUTTON
45	Q.MENU	R/C BUTTON
43	MENU	R/C BUTTON
AB	GUIDE	R/C BUTTON
40	Up (^)	R/C BUTTON
41	Down (v)	R/C BUTTON
07	Left (<)	R/C BUTTON
06	Right (>)	R/C BUTTON
44	OK(●)	R/C BUTTON
28	BACK	R/C BUTTON
5B	EXIT	R/C BUTTON
AA	INFO ⓘ	R/C BUTTON
30	AV MODE	R/C BUTTON
02	△+	R/C BUTTON
03	△-	R/C BUTTON
1E	FAV/MARK/CHAR/NUM	R/C BUTTON
09	MUTE/DELETE	R/C BUTTON
00	P ^ / PAGE ^	R/C BUTTON
01	P v /PAGE v	R/C BUTTON
10~19	Number Key 0~9	R/C BUTTON
53	LIST	R/C BUTTON
1A	Q.VIEW	R/C BUTTON
72	RED Key	R/C BUTTON
71	GREEN Key	R/C BUTTON
63	YELLOW Key	R/C BUTTON
61	BLUE Key/(L/R SELECT)	R/C BUTTON
20	TEXT	R/C BUTTON
21	T.OPT(T.Option)	R/C BUTTON
39	SUBTITLE	R/C BUTTON
7E	SIMPLINK	R/C BUTTON
91	AD	R/C BUTTON
0F	TV	R/C BUTTON
7C	X-STUDIO	R/C BUTTON
59	NetCast	R/C BUTTON
B1	■	R/C BUTTON
B0	▶	R/C BUTTON
BA		R/C BUTTON
8F	◀◀	R/C BUTTON
8E	▶▶	R/C BUTTON
DC	3D	R/C BUTTON
2E	FAMILY	R/C BUTTON
3A	CRICKET	R/C BUTTON

APPENDIX

EXTERNAL CONTROL DEVICE SETUP

RS-232C Setup

Connect the RS-232C (serial port) input jack to an external control device (such as a computer or an A/V control system) to control the product's functions externally.

Connect the serial port of the control device to the RS-232C jack on the product back panel.

Note: RS-232C connection cables are not supplied with the product.

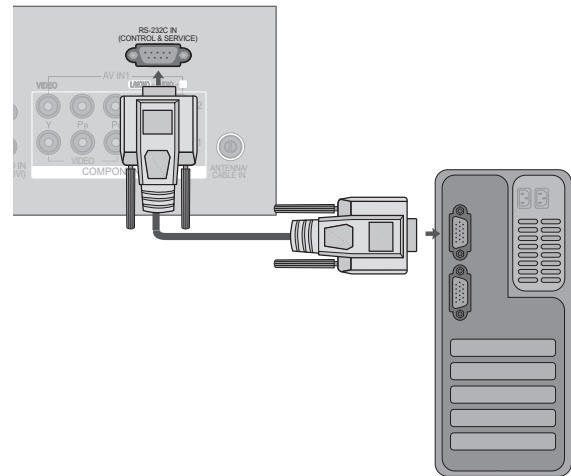

Type of Connector; D-Sub 9-Pin Male

No.	Pin Name
1	No connection
2	RXD (Receive data)
3	TXD (Transmit data)
4	DTR (DTE side ready)
5	GND
6	DSR (DCE side ready)
7	RTS (Ready to send)
8	CTS (Clear to send)
9	No Connection

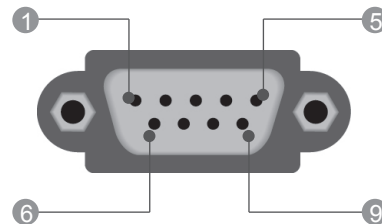

RS-232C Configurations

7-Wire Configurations (Standard RS-232C cable)

	PC	TV	
RXD	2 ● — ● 3	TXD	
TXD	3 ● — ● 2	RXD	
GND	5 ● — ● 5	GND	
DTR	4 ● — ● 6	DSR	
DSR	6 ● — ● 4	DTR	
RTS	7 ● — ● 8	CTS	
CTS	8 ● — ● 7	RTS	
	D-Sub 9	D-Sub 9	

3-Wire Configurations (Not standard)

	PC	TV	
RXD	2 ● — ● 3	TXD	
TXD	3 ● — ● 2	RXD	
GND	5 ● — ● 5	GND	
DTR	4	6	DTR
DSR	6	4	DSR
RTS	7	7	RTS
CTS	8	8	CTS
	D-Sub 9	D-Sub 9	

Set ID

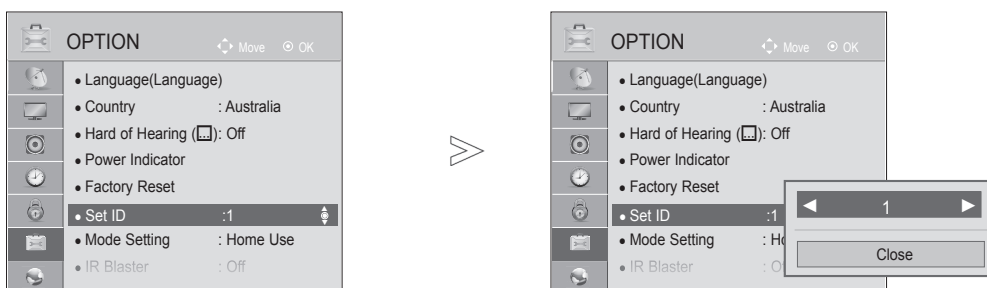

Use this function to specify a set ID number.

Refer to 'Real Data Mapping'. ► p.182



1   Select **OPTION**.

2   Select **Set ID**.

3   Adjust **Set ID** to choose the desired TV ID number.
The adjustment range of SET ID is 1 to 99.

- Press the **BACK** button to move to the previous menu screen.

APPENDIX

Communication Parameters

- Baud rate : 9600 bps (UART)
- Data length : 8 bits
- Parity : None
- Stop bit : 1 bit
- Communication code : ASCII code
- Use a crossed (reverse) cable.

Command Reference List

	COMMAND 1	COMMAND 2	DATA (Hexadecimal)
01. Power	k	a	00 to 01
02. Aspect Ratio	k	c	Refer to p. 179
03. Screen Mute	k	d	Refer to p. 179
04. Volume Mute	k	e	00 to 01
05. Volume Control	k	f	00 to 64
06. Contrast	k	g	00 to 64
07. Brightness	k	h	00 to 64
08. Colour	k	i	00 to 64
09. Tint	k	j	00 to 64
10. Sharpness	k	k	00 to 64
11. OSD Select	k	l	00 to 01
12. Remote control lock mode	k	m	00 to 01
13. Treble	k	r	00 to 64
14. Bass	k	s	00 to 64
15. Balance	k	t	00 to 64
16. Colour Temperature	x	u	00 to 64
17. Energy Saving	j	q	00 to 05
18. Auto Configuration	j	u	01
19. Tune Command	m	a	Refer to p. 181
20. Programme Add/Skip	m	b	00 to 01
21. Key	m	c	Key Code
22. Control Back Light	m	g	00 to 64
23. Input select (Main)	x	b	Refer to p. 182

* Note : During USB operations such as DivX or EMF, all commands except Power(ka) and Key(mc) are not executed and treated as NG.

Transmission / Receiving Protocol

Transmission

[Command1][Command2][][Set ID][][Data][Cr]

- * [Command 1] : First command to control the TV.
(j, k, m or x)
- * [Command 2] : Second command to control the TV.
- * [Set ID] : You can adjust the set ID to choose desired monitor ID number in option menu. Adjustment range is 1 to 99. When selecting Set ID '0', every connected set is controlled. Set ID is indicated as decimal (1 to 99) on menu and as Hexa decimal (0x1 to 0x63) on transmission/receiving protocol.
- * [DATA] : To transmit command data. Transmit 'FF' data to read status of command.
- * [Cr] : Carriage Return
ASCII code '0x0D'
- * [] : ASCII code 'space (0x20)'

OK Acknowledgement

[Command2][][Set ID][][OK][Data][x]

- * The set transmits ACK (acknowledgement) based on this format when receiving normal data. At this time, if the data is data read mode, it indicates present status data. If the data is data write mode, it returns the data of the PC computer.

Error Acknowledgement

[Command2][][Set ID][][NG][Data][x]

- * The set transmits ACK (acknowledgement) based on this format when receiving abnormal data from non-viable functions or communication errors.

Data 00: Illegal Code

01. Power (Command: k a)

- ▶ To control Power On/Off of the set.

Transmission

[k][a][][Set ID][][Data][Cr]

Data 00 : Power Off 01 : Power On

Ack

[a][][Set ID][][OK/NG][Data][x]

- ▶ To show Power On/Off.

Transmission

[k][a][][Set ID][][FF][Cr]

Ack

[a][][Set ID][][OK/NG][Data][x]

- * Similarly, if other functions transmit '0xFF' data based on this format, Acknowledgement data feed back presents status about each function.
- * OK Ack., Error Ack. and other message may display on the screen when TV is power On.

02. Aspect Ratio (Command: k c) (Main Picture Size)

- ▶ To adjust the screen format. (Main picture format)
You can also adjust the screen format using the **Aspect Ratio** in the Q.MENU. or PICTURE menu.

Transmission

[k][c][][Set ID][][Data][Cr]

Data 01 : Normal screen (4:3) 07 : 14:9
02 : Wide screen (16:9) 09 : Just Scan
04 : Zoom 0B : Full Wide
06 : Original 10 to 1F : Cinema Zoom 1 to 16

Ack

[c][][Set ID][][OK/NG][Data][x]

- * Using the PC input, you select either 16:9 or 4:3 screen aspect ratio.
- * In DTV/HDMI (1080i 50 Hz / 60 Hz, 720p 50Hz / 60 Hz, 1080p 24 Hz / 30 Hz / 50 Hz / 60 Hz), Component(720p, 1080i, 1080p 50 Hz / 60 Hz) mode, Just Scan is available.
- * **Full Wide** is supported only for DTV mode.

03. Screen Mute (Command: k d)

- ▶ To select screen mute on/off.

Transmission

[k][d][][Set ID][][Data][Cr]

Data 00 : Screen mute off (Picture on)
Video mute off
01 : Screen mute on (Picture off)
10 : Video mute on

Ack

[d][][Set ID][][OK/NG][Data][x]

- * In case of video mute on only, TV will display On Screen Display(OSD). But, in case of Screen mute on, TV will not display OSD.

04. Volume Mute (Command: k e)

- ▶ To control volume mute on/off.
You can also adjust mute using the MUTE button on remote control.

Transmission

[k][e][][Set ID][][Data][Cr]

Data 00 : Volume mute on (Volume off)
01 : Volume mute off (Volume on)

Ack

[e][][Set ID][][OK/NG][Data][x]

05. Volume Control (Command: k f)

- ▶ To adjust volume.
You can also adjust volume with the VOLUME buttons on remote control.

Transmission

[k][f][][Set ID][][Data][Cr]

Data Min : 00 to Max : 64
* Refer to 'Real data mapping 1'. See page 182.

Ack

[f][][Set ID][][OK/NG][Data][x]

06. Contrast (Command: k g)

- ▶ To adjust screen contrast.
You can also adjust contrast in the PICTURE menu.

Transmission

[k][g][][Set ID][][Data][Cr]

Data Min : 00 to Max : 64
* Refer to 'Real data mapping 1'. See page 182.

Ack

[g][][Set ID][][OK/NG][Data][x]

07. Brightness (Command: k h)

- ▶ To adjust screen brightness.
You can also adjust brightness in the PICTURE menu.

Transmission

[k][h][][Set ID][][Data][Cr]

Data Min : 00 to Max : 64
* Refer to 'Real data mapping 1'. See page 182.

Ack

[h][][Set ID][][OK/NG][Data][x]

08. Colour (Command: k i)

- ▶ To adjust the screen colour.
You can also adjust colour in the PICTURE menu.

Transmission

[k][i][][Set ID][][Data][Cr]

Data Min : 00 to Max : 64
* Refer to 'Real data mapping 1'. See page 182.

Ack

[i][][Set ID][][OK/NG][Data][x]

APPENDIX

09. Tint (Command: k j)

- ▶ To adjust the screen tint.
You can also adjust tint in the PICTURE menu.

Transmission

[k][j][][Set ID][][Data][Cr]

Data Red : 00 to Green : 64

* Refer to 'Real data mapping 1'. See page 182.

Ack

[j][][Set ID][][OK/NG][Data][x]

10. Sharpness (Command: k k)

- ▶ To adjust the screen sharpness.
You can also adjust sharpness in the PICTURE menu.

Transmission

[k][k][][Set ID][][Data][Cr]

Data Min : 00 to Max : 64

* Refer to 'Real data mapping 1'. See page 182.

Ack

[k][][Set ID][][OK/NG][Data][x]

11. OSD Select (Command: k l)

- ▶ To select OSD (On Screen Display) on/off when controlling remotely.

Transmission

[k][l][][Set ID][][Data][Cr]

Data 00 : OSD off 01 : OSD on

Ack

[l][][Set ID][][OK/NG][Data][x]

12. Remote control lock mode (Command: k m)

- ▶ To lock the front panel controls on the monitor and remote control.

Transmission

[k][m][][Set ID][][Data][Cr]

Data 00 : Lock off 01 : Lock on

Ack

[m][][Set ID][][OK/NG][Data][x]

- * If you are not using the remote control, use this mode.
When main power is on/off, external control lock is released.

- * In the standby mode, if key lock is on, TV will not turn on by power on key of IR & Local Key.

13. Treble (Command: k r)

- ▶ To adjust treble.
You can also adjust treble in the AUDIO menu.

Transmission

[k][r][][Set ID][][Data][Cr]

Data Min : 00 to Max : 64

* Refer to 'Real data mapping 1'. See page 182.

Ack

[r][][Set ID][][OK/NG][Data][x]

14. Bass (Command: k s)

- ▶ To adjust bass.
You can also adjust bass in the AUDIO menu.

Transmission

[k][s][][Set ID][][Data][Cr]

Data Min : 00 to Max : 64

* Refer to 'Real data mapping 1'. See page 182.

Ack

[s][][Set ID][][OK/NG][Data][x]

15. Balance (Command: k t)

- ▶ To adjust balance.
You can also adjust balance in the AUDIO menu.

Transmission

[k][t][][Set ID][][Data][Cr]

Data Min : 00 to Max : 64

* Refer to 'Real data mapping 1'. See page 182.

Ack

[t][][Set ID][][OK/NG][Data][x]

16. Colour Temperature (Command: x u)

- ▶ To adjust colour temperature. You can also adjust Colour Temperature in the PICTURE menu.

Transmission

[x][u][][Set ID][][Data][Cr]

Data Min : 00 to Max : 64

* Refer to 'Real data mapping 1'. See page 182.

Ack

[u][][Set ID][][OK/NG][Data][x]

17. Energy Saving (Command: j q)

- ▶ To reduce the power consumption of the TV. You can also adjust Energy Saving in PICTURE menu.

Transmission

[j][q][] [Set ID][] [Data][Cr]

Power Saving Function					Level				Description
7	6	5	4		3	2	1	0	
0	0	0	0	Low Power	0	0	0	0	Off
0	0	0	0	Low Power	0	0	0	1	Minimum
0	0	0	0	Low Power	0	0	1	0	Medium
0	0	0	0	Low Power	0	0	1	1	Maximum
0	0	0	0	Low Power	0	1	0	0	Auto
0	0	0	0	Low Power	0	1	0	1	Screen Off

Except 22/26/32LD3**, 32/37/42/47LD4**,
19/22/26LE5***, 22/26LE6***, 26LE3***

Ack

[q][] [Set ID][] [OK/NG][Data][x]

18. Auto Configure(Command: j u)

- ▶ To adjust picture position and minimize image shaking automatically. It works only in RGB (PC) mode.

Transmission

[j][u][] [Set ID][] [Data][Cr]

Data 01: To set

Ack

[u][] [Set ID][] [OK/NG][Data][x]

19. Tune Command (Command: m a)

- ▶ Select channel to following physical number.

Transmission

[m][a][] [Set ID][] [Data0][] [Data1][] [Data2][Cr]

Data00 : High channel data

Data01 : Low channel data

ex. No. 47 -> 00 2F (2FH)

No. 394 -> 01 8A (18AH),

DTV No. 0 -> Don't care

Data02 : 0x00 : Analogue Main

0x10 : DTV Main

0x20 : Radio

Channel data range

Analogue - Min: 00 to Max: 63 (0 to 99)

Digital - Min: 00 to Max: 3E7 (0 to 999)

Ack

[a][] [Set ID][] [OK/NG][Data][x]

Data Min: 00 to Max: 7DH

20. Programme Add/Skip(Command: m b)

- ▶ To set skip status for the current Programme.

Transmission

[m][b][] [Set ID][] [Data][Cr]

Data 00 : Skip 01 : Add

Ack

[b][] [Set ID][] [OK/NG][Data][x]

APPENDIX

21. Key(Command: m c)

► To send IR remote key code.

Transmission

[m][c][][Set ID][][Data][Cr]

Data Key code - Refer to page 175.

Ack

[c][][Set ID][][OK/NG][Data][x]

22. Control Back Light (Command: m g)

► To Control the back light.

Transmission

[m][g][][Set ID][][Data][Cr]

Data : data Min: 00 to Max: 64

Ack

[g][][Set ID][][OK/NG][Data][x]

* Real data mapping 1

00 : Step 0
 :
 A : Step 10 (Set ID 10)
 :
 F : Step 15 (Set ID 15)
 10 : Step 16 (Set ID 16)
 :
 64 : Step 100
 :
 6E : Step 110
 :
 73 : Step 115
 74 : Step 116
 :
 CF : Step 199
 :
 FE : Step 254
 FF : Step 255

23. Input select (Command: x b) (Main Picture Input)

► To select input source for main picture.

Transmission

[x][b][][Set ID][][Data][Cr]

Data Structure

MSB LSB

0	0	0	0	0	0	0	0
└ External Input ┘				└ Input Number ┘			

External Input				Data
0	0	0	0	DTV
0	0	0	1	Analogue
0	0	1	0	AV
0	1	0	0	Component
0	1	1	0	RGB
0	1	1	1	HDMI
1	0	0	0	
1	0	0	1	
1	0	1	0	

Input Number				Data
0	0	0	0	Input1
0	0	0	1	Input2
0	0	1	0	Input3
0	0	1	1	Input4

Ack

[b][][Set ID][][OK/NG][Data][x]

OPEN SOURCE SOFTWARE NOTICE

(Except 32/42/52LD56*, 32/37/42/47/55LD6**, 32/37/42/47/55LE55**, 32/37/42/47/55LE7***, 42/47/55LE8***, 42/47/55LX6***, 47/55LX9***)

The following GPL executables and LGPL, MPL libraries used in this product are subject to the GPL2.0/LGPL2.1/MPL1.1 License Agreements:

GPL EXECUTABLES:

- Linux kernel 2.6, busybox, e2fsprogs, gdbserver, jfsutils, mtd-utils, procps, u-boot, udhpcp

LGPL LIBRARIES:

- cairo, directFB, gettext, glib, glibc, iconv, pixman

MPL LIBRARIES:

- Nanox

LG Electronics offers to provide source code to you on CD-ROM for a charge covering the cost of performing such distribution, such as the cost of media, shipping and handling upon e-mail request to LG Electronics at: opensource@lge.com

This offer is valid for a period of three (3) years from the date of the distribution of this product by LG Electronics.

You can obtain a copy of the GPL, LGPL and MPL licenses on the CD-ROM provided with this product. Also you can obtain the translation of GPL, LGPL licenses from <http://www.gnu.org/licenses/old-licenses/gpl-2.0-translations.html>, <http://www.gnu.org/licenses/old-licenses/lgpl-2.1-translations.html>.

This product includes

- expat:
 - copyright © 1998, 1999, 2000 Thai Open Source Software Center Ltd and Clark Cooper
 - copyright © 2001, 2002, 2003, 2004, 2005, 2006 Expat maintainers.
- freetype: copyright © 2003 The FreeType Project (www.freetype.org).
- ICU: copyright © 1995-2008 International Business Machines Corporation and others
- libcurl: copyright © 1996 - 2008, Daniel Stenberg.
- libjpeg: This software is based in part on the work of the Independent JPEG Group copyright © 1991 – 1998, Thomas G. Lane.
- libmng: copyright © 2000-2007 Gerard Juyn, Glenn Randers-Pehrson
- libpng: copyright © 1998-2008 Glenn Randers-Pehrson
- md5: copyright © 1991-2, RSA Data Security, Inc
- md5 checksum : copyright © 1999, 2000, 2002 Aladdin Enterprises
- ncurses: copyright © 1998 Free Software Foundation, Inc.
- openssl:
 - cryptographic software written by Eric Young.
 - software written by Tim Hudson.
 - software developed by the OpenSSL Project for use in the OpenSSL Toolkit. (<http://www.openssl.org>)
- strace :
 - copyright © 1991, 1992 Paul Kranenburg.
 - copyright © 1993 Branko Lankester.
 - copyright © 1993 Ulrich Pegelow.
 - copyright © 1995, 1996 Michael Elizabeth Chastain.

APPENDIX

- copyright © 1993, 1994, 1995, 1996 Rick Sladkey.
- copyright © 1998-2003 Wichert Akkerman.
- copyright © 2002-2008 Roland McGrath.
- copyright © 2003-2008 Dmitry V. Levin.
- copyright © 2007-2008 Jan Kratochvil.
- tinysql: copyright © 2000-2006 Lee Thomason
- xyssl: Copyright (C) 2009 Paul Bakker
- zlib: copyright © 1995-2005 Jean-loup Gailly and Mark Adler

All rights reserved.

Permission is hereby granted, free of charge, to any person obtaining a copy of this software and associated documentation files (the "Software"), to deal in the Software without restriction, including without limitation the rights to use, copy, modify, merge, publish, distribute, sublicense, and/or sell copies of the Software, and to permit persons to whom the Software is furnished to do so, subject to the following conditions:

THE SOFTWARE IS PROVIDED "AS IS", WITHOUT WARRANTY OF ANY KIND, EXPRESS OR IMPLIED, INCLUDING BUT NOT LIMITED TO THE WARRANTIES OF MERCHANTABILITY, FITNESS FOR A PARTICULAR PURPOSE AND NONINFRINGEMENT. IN NO EVENT SHALL THE AUTHORS OR COPYRIGHT HOLDERS BE LIABLE FOR ANY CLAIM, DAMAGES OR OTHER LIABILITY, WHETHER IN AN ACTION OF CONTRACT, TORT OR OTHERWISE, ARISING FROM, OUT OF OR IN CONNECTION WITH THE SOFTWARE OR THE USE OR OTHER DEALINGS IN THE SOFTWARE.

(Only 32/42/52LD56*, 32/37/42/47/55LD6**, 32/37/42/47/55LE55**, 32/37/42/47/55LE7***, 42/47/55LE8***, 42/47/55LX6***, 47/55LX9***)

The following GPL executables and LGPL, MPL libraries used in this product are subject to the GPL2.0/LGPL2.1/MPL1.1 License Agreements:

GPL EXECUTABLES:

Linux kernel 2.6, busybox, e2fsprogs, jfsutils, lzo, msdl-1.1, mtd-utils, ntpclient, procps

LGPL LIBRARIES:

Atk, cairo, directFB, ffmpeg, glib, GnuTLS, gtk+, iconv, libintl, libgcrypt, libgpg-error, libsoup, libusb, pango, uClibc, webkit

MPL LIBRARIES:

Nanox, spidermonkey

LG Electronics offers to provide source code to you on CD-ROM for a charge covering the cost of performing such distribution, such as the cost of media, shipping and handling upon e-mail request to LG Electronics : opensource@lge.com

This offer is valid for a period of three (3) years from the date of the distribution of this product by LG Electronics.

You can obtain a copy of the GPL, LGPL, MPL licenses on the CD-ROM provided with this product.

Also you can obtain the translation of GPL, LGPL licenses from <http://www.gnu.org/licenses/old-licenses/gpl-2.0-translations.html>, <http://www.gnu.org/licenses/old-licenses/lgpl-2.1-translations.html>.

This product includes other open source software.

- boost C++: software developed by <http://www.boost.org> distributed under the Boost Software License, Version 1.0
- c-ares : copyright © 1998 by the Massachusetts Institute of Technology
- expat:
 - copyright © 1998, 1999, 2000 Thai Open Source Software Center Ltd and Clark Cooper
 - copyright © 2001-2007 Expat maintainers.
- fontconfig: copyright © 2001, 2003 Keith Packard
- freetype: copyright © 2003 The FreeType Project (www.freetype.org).
- ICU: copyright © 1995-2008 International Business Machines Corporation and others.
- libcurl: copyright © 1996 - 2008, Daniel Stenberg.
- libjpeg: This software is based in part on the work of the Independent JPEG Group copyright © 1991 – 1998, Thomas G. Lane.
- libmng: copyright © 2000-2007 Gerard Juyn, Glenn Randers-Pehrson
- libpng: copyright © 1998-2008 Glenn Randers-Pehrson
- libupnp: copyright © 2000-2003 Intel Corporation
- libxml2 : copyright © 1998-2003 Daniel Veillard
- libxslt: copyright © 2001-2002 Daniel Veillard
- lua interpreter: copyright © 1994–2008 Lua.org, PUC-Rio
- md5: copyright © 1991-2, RSA Data Security, Inc
- openSSL:
 - cryptographic software written by Eric Young.

APPENDIX

- software written by Tim Hudson.
- software developed by the OpenSSL Project for use in the OpenSSL Toolkit. (<http://www.openssl.org>)
 - pixman:
 - copyright © 1987, 1988, 1989, 1998 The Open Group
 - copyright © 1987, 1988, 1989 Digital Equipment Corporation
 - copyright © 1999, 2004, 2008 Keith Packard
 - copyright © 2000 SuSE, Inc.
 - copyright © 2000 Keith Packard, member of The XFree86 Project, Inc.
 - copyright © 2004, 2005, 2007, 2008 Red Hat, Inc.
 - copyright © 2004 Nicholas Miell
 - copyright © 2005 Lars Knoll & Zack Rusin, Trolltech
 - copyright © 2005 Trolltech AS
 - copyright © 2007 Luca Barbato
 - copyright © 2008 Aaron Plattner, NVIDIA Corporation
 - copyright © 2008 Rodrigo Kumpera
 - copyright © 2008 André Tupinambá
 - copyright © 2008 Mozilla Corporation
 - copyright © 2008 Frederic Plourde
 - portmap: copyright © 1983,1991 The Regents of the University of California.
 - tiff: copyright © 1987, 1993, 1994 The Regents of the University of California.
 - tinyxml: copyright © 2000-2006 Lee Thomason
 - xysst:
 - copyright © 2006-2008 Christophe Devine
 - copyright © 2009 Paul Bakker
 - zlib: copyright © 1995-2005 Jean-loup Gailly and Mark Adler

All rights reserved.

Permission is hereby granted, free of charge, to any person obtaining a copy of this software and associated documentation files (the "Software"), to deal in the Software without restriction, including without limitation the rights to use, copy, modify, merge, publish, distribute, sublicense, and/or sell copies of the Software, and to permit persons to whom the Software is furnished to do so, subject to the following conditions:

THE SOFTWARE IS PROVIDED "AS IS", WITHOUT WARRANTY OF ANY KIND, EXPRESS OR IMPLIED, INCLUDING BUT NOT LIMITED TO THE WARRANTIES OF MERCHANTABILITY, FITNESS FOR A PARTICULAR PURPOSE AND NONINFRINGEMENT. IN NO EVENT SHALL THE AUTHORS OR COPYRIGHT HOLDERS BE LIABLE FOR ANY CLAIM, DAMAGES OR OTHER LIABILITY, WHETHER IN AN ACTION OF CONTRACT, TORT OR OTHERWISE, ARISING FROM, OUT OF OR IN CONNECTION WITH THE SOFTWARE OR THE USE OR OTHER DEALINGS IN THE SOFTWARE.

OPEN SOURCE LICENSE

GNU GENERAL PUBLIC LICENSE

Version 2, June 1991

Copyright (C) 1989, 1991 Free Software Foundation, Inc., 51 Franklin Street, Fifth Floor, Boston, MA 02110-1301 USA
Everyone is permitted to copy and distribute verbatim copies of this license document, but changing it is not allowed.

Preamble

The licenses for most software are designed to take away your freedom to share and change it. By contrast, the GNU General Public License is intended to guarantee your freedom to share and change free software--to make sure the software is free for all its users. This General Public License applies to most of the Free Software Foundation's software and to any other program whose authors commit to using it. (Some other Free Software Foundation software is covered by the GNU Lesser General Public License instead.) You can apply it to your programs, too.

When we speak of free software, we are referring to freedom, not price. Our General Public Licenses are designed to make sure that you have the freedom to distribute copies of free software (and charge for this service if you wish), that you receive source code or can get it if you want it, that you can change the software or use pieces of it in new free programs; and that you know you can do these things.

To protect your rights, we need to make restrictions that forbid anyone to deny you these rights or to ask you to surrender the rights. These restrictions translate to certain responsibilities for you if you distribute copies of the software, or if you modify it.

For example, if you distribute copies of such a program, whether gratis or for a fee, you must give the recipients all the rights that you have. You must make sure that they, too, receive or can get the source code. And you must show them these terms so they know their rights.

We protect your rights with two steps: (1) copyright the software, and (2) offer you this license which gives you legal permission to copy, distribute and/or modify the software.

Also, for each author's protection and ours, we want to make certain that everyone understands that there is no warranty for this free software. If the software is modified by someone else and passed on, we want its recipients to know that what they have is not the original, so that any problems introduced by others will not reflect on the original authors' reputations.

Finally, any free program is threatened constantly by software patents. We wish to avoid the danger that redistributors of a free program will individually obtain patent licenses, in effect making the program proprietary. To prevent this, we have made it clear that any patent must be licensed for everyone's free use or not licensed at all.

The precise terms and conditions for copying, distribution and modification follow.

GNU GENERAL PUBLIC LICENSE TERMS AND CONDITIONS FOR COPYING, DISTRIBUTION AND MODIFICATION

0. This License applies to any program or other work which contains a notice placed by the copyright holder saying it may be distributed under the terms of this General Public License. The "Program", below, refers to any such program or work, and a "work based on the Program" means either the Program or any derivative work under copyright law: that is to say, a work containing the Program or a portion of it, either verbatim or with modifications and/or translated into another language. (Hereinafter, translation is included without limitation in the term "modification".) Each licensee is addressed as "you".

Activities other than copying, distribution and modification are not covered by this License; they are outside its scope. The act of running the Program is not restricted, and the output from the Program is covered only if its contents constitute a work based on the Program (independent of having been made by running the Program). Whether that is true depends on what the Program does.

APPENDIX

1. You may copy and distribute verbatim copies of the Program's source code as you receive it, in any medium, provided that you conspicuously and appropriately publish on each copy an appropriate copyright notice and disclaimer of warranty; keep intact all the notices that refer to this License and to the absence of any warranty; and give any other recipients of the Program a copy of this License along with the Program.

You may charge a fee for the physical act of transferring a copy, and you may at your option offer warranty protection in exchange for a fee.

2. You may modify your copy or copies of the Program or any portion of it, thus forming a work based on the Program, and copy and distribute such modifications or work under the terms of Section 1 above, provided that you also meet all of these conditions:

- a) You must cause the modified files to carry prominent notices stating that you changed the files and the date of any change.
- b) You must cause any work that you distribute or publish, that in whole or in part contains or is derived from the Program or any part thereof, to be licensed as a whole at no charge to all third parties under the terms of this License.
- c) If the modified program normally reads commands interactively when run, you must cause it, when started running for such interactive use in the most ordinary way, to print or display an announcement including an appropriate copyright notice and a notice that there is no warranty (or else, saying that you provide a warranty) and that users may redistribute the program under these conditions, and telling the user how to view a copy of this License. (Exception: if the Program itself is interactive but does not normally print such an announcement, your work based on the Program is not required to print an announcement.)

These requirements apply to the modified work as a whole. If identifiable sections of that work are not derived from the Program, and can be reasonably considered independent and separate works in themselves, then this License, and its terms, do not apply to those sections when you distribute them as separate works. But when you distribute the same sections as part of a whole which is a work based on the Program, the distribution of the whole must be on the terms of this License, whose permissions for other licensees extend to the entire whole, and thus to each and every part regardless of who wrote it.

Thus, it is not the intent of this section to claim rights or contest your rights to work written entirely by you; rather, the intent is to exercise the right to control the distribution of derivative or collective works based on the Program.

In addition, mere aggregation of another work not based on the Program with the Program (or with a work based on the Program) on a volume of a storage or distribution medium does not bring the other work under the scope of this License.

3. You may copy and distribute the Program (or a work based on it, under Section 2) in object code or executable form under the terms of Sections 1 and 2 above provided that you also do one of the following:

- a) Accompany it with the complete corresponding machine-readable source code, which must be distributed under the terms of Sections 1 and 2 above on a medium customarily used for software interchange; or,
- b) Accompany it with a written offer, valid for at least three years, to give any third party, for a charge no more than your cost of physically performing source distribution, a complete machine-readable copy of the corresponding source code, to be distributed under the terms of Sections 1 and 2 above on a medium customarily used for software interchange; or,
- c) Accompany it with the information you received as to the offer to distribute corresponding source code. (This alternative is allowed only for noncommercial distribution and only if you received the program in object code or executable form with such an offer, in accord with Subsection b above.)

The source code for a work means the preferred form of the work for making modifications to it. For an executable work, complete source code means all the source code for all modules it contains, plus any associated interface definition files, plus the scripts used to control compilation and installation of the executable. However, as a special exception, the source code distributed need not include anything that is normally distributed (in either source or binary form) with the major components (compiler, kernel, and so on) of the operating system on which the executable runs, unless that component itself accompanies the executable.

If distribution of executable or object code is made by offering access to copy from a designated place, then offering equivalent access to copy the source code from the same place counts as distribution of the source code, even though third parties are not compelled to copy the source along with the object code.

4. You may not copy, modify, sublicense, or distribute the Program except as expressly provided under this License. Any attempt otherwise to copy, modify, sublicense or distribute the Program is void, and will automatically terminate your rights under this License. However, parties who have received copies, or rights, from you under this License will not have their licenses terminated so long as such parties remain in full compliance.

5. You are not required to accept this License, since you have not signed it. However, nothing else grants you permission to modify or distribute the Program or its derivative works. These actions are prohibited by law if you do not accept this License. Therefore, by modifying or distributing the Program (or any work based on the Program), you indicate your acceptance of this License to do so, and all its terms and conditions for copying, distributing or modifying the Program or works based on it.

6. Each time you redistribute the Program (or any work based on the Program), the recipient automatically receives a license from the original licensor to copy, distribute or modify the Program subject to these terms and conditions. You may not impose any further restrictions on the recipients' exercise of the rights granted herein. You are not responsible for enforcing compliance by third parties to this License.

7. If, as a consequence of a court judgment or allegation of patent infringement or for any other reason (not limited to patent issues), conditions are imposed on you (whether by court order, agreement or otherwise) that contradict the conditions of this License, they do not excuse you from the conditions of this License. If you cannot distribute so as to satisfy simultaneously your obligations under this License and any other pertinent obligations, then as a consequence you may not distribute the Program at all. For example, if a patent license would not permit royalty-free redistribution of the Program by all those who receive copies directly or indirectly through you, then the only way you could satisfy both it and this License would be to refrain entirely from distribution of the Program.

If any portion of this section is held invalid or unenforceable under any particular circumstance, the balance of the section is intended to apply and the section as a whole is intended to apply in other circumstances.

It is not the purpose of this section to induce you to infringe any patents or other property right claims or to contest validity of any such claims; this section has the sole purpose of protecting the integrity of the free software distribution system, which is implemented by public license practices. Many people have made generous contributions to the wide range of software distributed through that system in reliance on consistent application of that system; it is up to the author/donor to decide if he or she is willing to distribute software through any other system and a licensee cannot impose that choice.

This section is intended to make thoroughly clear what is believed to be a consequence of the rest of this License.

8. If the distribution and/or use of the Program is restricted in certain countries either by patents or by copyrighted interfaces, the original copyright holder who places the Program under this License may add an explicit geographical distribution limitation excluding those countries, so that distribution is permitted only in or among countries not thus excluded. In such case, this License incorporates the limitation as if written in the body of this License.

9. The Free Software Foundation may publish revised and/or new versions of the General Public License from time to time. Such new versions will be similar in spirit to the present version, but may differ in detail to address new problems or concerns.

Each version is given a distinguishing version number. If the Program specifies a version number of this License which applies to it and "any later version", you have the option of following the terms and conditions either of that version or of any later version published by the Free Software Foundation. If the Program does not specify a version number of this License, you may choose any version ever published by the Free Software Foundation.

10. If you wish to incorporate parts of the Program into other free programs whose distribution conditions are different, write to the author to ask for permission. For software which is copyrighted by the Free Software Foundation, write to the Free Software Foundation; we sometimes make exceptions for this. Our decision will be guided by the two goals of preserving the free status of all derivatives of our free software and of promoting the sharing and reuse of software generally.

APPENDIX

NO WARRANTY

11. BECAUSE THE PROGRAM IS LICENSED FREE OF CHARGE, THERE IS NO WARRANTY FOR THE PROGRAM, TO THE EXTENT PERMITTED BY APPLICABLE LAW. EXCEPT WHEN OTHERWISE STATED IN WRITING THE COPYRIGHT HOLDERS AND/OR OTHER PARTIES PROVIDE THE PROGRAM "AS IS" WITHOUT WARRANTY OF ANY KIND, EITHER EXPRESSED OR IMPLIED, INCLUDING, BUT NOT LIMITED TO, THE IMPLIED WARRANTIES OF MERCHANTABILITY AND FITNESS FOR A PARTICULAR PURPOSE. THE ENTIRE RISK AS TO THE QUALITY AND PERFORMANCE OF THE PROGRAM IS WITH YOU. SHOULD THE PROGRAM PROVE DEFECTIVE, YOU ASSUME THE COST OF ALL NECESSARY SERVICING, REPAIR OR CORRECTION.

12. IN NO EVENT UNLESS REQUIRED BY APPLICABLE LAW OR AGREED TO IN WRITING WILL ANY COPYRIGHT HOLDER, OR ANY OTHER PARTY WHO MAY MODIFY AND/OR REDISTRIBUTE THE PROGRAM AS PERMITTED ABOVE, BE LIABLE TO YOU FOR DAMAGES, INCLUDING ANY GENERAL, SPECIAL, INCIDENTAL OR CONSEQUENTIAL DAMAGES ARISING OUT OF THE USE OR INABILITY TO USE THE PROGRAM (INCLUDING BUT NOT LIMITED TO LOSS OF DATA OR DATA BEING RENDERED INACCURATE OR LOSSES SUSTAINED BY YOU OR THIRD PARTIES OR A FAILURE OF THE PROGRAM TO OPERATE WITH ANY OTHER PROGRAMS), EVEN IF SUCH HOLDER OR OTHER PARTY HAS BEEN ADVISED OF THE POSSIBILITY OF SUCH DAMAGES.

END OF TERMS AND CONDITIONS

How to Apply These Terms to Your New Programs

If you develop a new program, and you want it to be of the greatest possible use to the public, the best way to achieve this is to make it free software which everyone can redistribute and change under these terms.

To do so, attach the following notices to the program. It is safest to attach them to the start of each source file to most effectively convey the exclusion of warranty; and each file should have at least the "copyright" line and a pointer to where the full notice is found.

```
<one line to give the program's name and a brief idea of what it does.>  
Copyright (C) <year> <name of author>
```

This program is free software; you can redistribute it and/or modify it under the terms of the GNU General Public License as published by the Free Software Foundation; either version 2 of the License, or (at your option) any later version.

This program is distributed in the hope that it will be useful, but WITHOUT ANY WARRANTY; without even the implied warranty of MERCHANTABILITY or FITNESS FOR A PARTICULAR PURPOSE. See the GNU General Public License for more details.

You should have received a copy of the GNU General Public License along with this program; if not, write to the Free Software Foundation, Inc., 51 Franklin Street, Fifth Floor, Boston, MA 02110-1301 USA.

Also add information on how to contact you by electronic and paper mail.

If the program is interactive, make it output a short notice like this when it starts in an interactive mode:

```
Gnomovision version 69, Copyright (C) year name of author  
Gnomovision comes with ABSOLUTELY NO WARRANTY;  
for details type `show w'. This is free software, and you are welcome to redistribute it under certain conditions;  
type `show c' for details.
```

The hypothetical commands `show w' and `show c' should show the appropriate parts of the General Public License. Of course, the commands you use may be called something other than `show w' and `show c'; they could even be mouse-clicks or menu items--whatever suits your program.

You should also get your employer (if you work as a programmer) or your school, if any, to sign a "copyright disclaimer" for the program, if necessary. Here is a sample; alter the names:

```
Yoyodyne, Inc., hereby disclaims all copyright interest in the program `Gnomovision' (which makes passes at compilers) written by James Hacker.
```

```
<signature of Ty Coon>, 1 April 1989  
Ty Coon, President of Vice
```

This General Public License does not permit incorporating your program into proprietary programs. If your program is a subroutine library, you may consider it more useful to permit linking proprietary applications with the library. If this is what you want to do, use the GNU Lesser General Public License instead of this License.

GNU LESSER GENERAL PUBLIC LICENSE

Version 2.1, February 1999

Copyright (C) 1991, 1999 Free Software Foundation, Inc. 51 Franklin Street, Fifth Floor, Boston, MA 02110-1301 USA Everyone is permitted to copy and distribute verbatim copies of this license document, but changing it is not allowed.

[This is the first released version of the Lesser GPL. It also counts as the successor of the GNU Library Public License, version 2, hence the version number 2.1.]

Preamble

The licenses for most software are designed to take away your freedom to share and change it. By contrast, the GNU General Public Licenses are intended to guarantee your freedom to share and change free software--to make sure the software is free for all its users.

This license, the Lesser General Public License, applies to some specially designated software packages--typically libraries--of the Free Software Foundation and other authors who decide to use it. You can use it too, but we suggest you first think carefully about whether this license or the ordinary General Public License is the better strategy to use in any particular case, based on the explanations below.

When we speak of free software, we are referring to freedom of use, not price. Our General Public Licenses are designed to make sure that you have the freedom to distribute copies of free software (and charge for this service if you wish); that you receive source code or can get it if you want it; that you can change the software and use pieces of it in new free programs; and that you are informed that you can do these things.

To protect your rights, we need to make restrictions that forbid distributors to deny you these rights or to ask you to surrender these rights. These restrictions translate to certain responsibilities for you if you distribute copies of the library or if you modify it.

For example, if you distribute copies of the library, whether gratis or for a fee, you must give the recipients all the rights that we gave you. You must make sure that they, too, receive or can get the source code. If you link other code with the library, you must provide complete object files to the recipients, so that they can relink them with the library after making changes to the library and recompiling it. And you must show them these terms so they know their rights.

We protect your rights with a two-step method: (1) we copyright the library, and (2) we offer you this license, which gives you legal permission to copy, distribute and/or modify the library.

To protect each distributor, we want to make it very clear that there is no warranty for the free library. Also, if the library is modified by someone else and passed on, the recipients should know that what they have is not the original version, so that the original author's reputation will not be affected by problems that might be introduced by others.

Finally, software patents pose a constant threat to the existence of any free program. We wish to make sure that a company cannot effectively restrict the users of a free program by obtaining a restrictive license from a patent holder. Therefore, we insist that any patent license obtained for a version of the library must be consistent with the full freedom of use specified in this license.

Most GNU software, including some libraries, is covered by the ordinary GNU General Public License. This license, the GNU Lesser General Public License, applies to certain designated libraries, and is quite different from the ordinary General Public License. We use this license for certain libraries in order to permit linking those libraries into non-free programs.

When a program is linked with a library, whether statically or using a shared library, the combination of the two is legally speaking a combined work, a derivative of the original library. The ordinary General Public License therefore permits such linking only if the entire combination fits its criteria of freedom. The Lesser General Public License permits more lax criteria for linking other code with the library.

We call this license the "Lesser" General Public License because it does Less to protect the user's freedom than the ordinary General Public License. It also provides other free software developers Less of an advantage over competing non-free programs. These disadvantages are the reason we use the ordinary General Public License for many libraries. However, the Lesser license provides advantages in certain special circumstances.

For example, on rare occasions, there may be a special need to encourage the widest possible use of a certain library, so that it becomes a de-facto standard. To achieve this, non-free programs must be allowed to use the library. A more frequent case is that a free library does the same job as widely used non-free libraries. In this case, there is little to gain by limiting the free library to free software only, so we use the Lesser General Public License.

In other cases, permission to use a particular library in non-free programs enables a greater number of people to use a large body of free software. For example, permission to use the GNU C Library in non-free programs enables many more people to use the whole GNU operating system, as well as its variant, the GNU/Linux operating system.

APPENDIX

Although the Lesser General Public License is Less protective of the users' freedom, it does ensure that the user of a program that is linked with the Library has the freedom and the wherewithal to run that program using a modified version of the Library.

The precise terms and conditions for copying, distribution and modification follow. Pay close attention to the difference between a "work based on the library" and a "work that uses the library". The former contains code derived from the library, whereas the latter must be combined with the library in order to run.

GNU LESSER GENERAL PUBLIC LICENSE TERMS AND CONDITIONS FOR COPYING, DISTRIBUTION AND MODIFICATION

0. This License Agreement applies to any software library or other program which contains a notice placed by the copyright holder or other authorized party saying it may be distributed under the terms of this Lesser General Public License (also called "this License"). Each licensee is addressed as "you".

A "library" means a collection of software functions and/or data prepared so as to be conveniently linked with application programs (which use some of those functions and data) to form executables.

The "Library", below, refers to any such software library or work which has been distributed under these terms. A "work based on the Library" means either the Library or any derivative work under copyright law: that is to say, a work containing the Library or a portion of it, either verbatim or with modifications and/or translated straightforwardly into another language. (Hereinafter, translation is included without limitation in the term "modification".)

"Source code" for a work means the preferred form of the work for making modifications to it. For a library, complete source code means all the source code for all modules it contains, plus any associated interface definition files, plus the scripts used to control compilation and installation of the library.

Activities other than copying, distribution and modification are not covered by this License; they are outside its scope. The act of running a program using the Library is not restricted, and output from such a program is covered only if its contents constitute a work based on the Library (independent of the use of the Library in a tool for writing it). Whether that is true depends on what the Library does and what the program that uses the Library does.

1. You may copy and distribute verbatim copies of the Library's complete source code as you receive it, in any medium, provided that you conspicuously and appropriately publish on each copy an appropriate copyright notice and disclaimer of warranty; keep intact all the notices that refer to this License and to the absence of any warranty; and distribute a copy of this License along with the Library.

You may charge a fee for the physical act of transferring a copy, and you may at your option offer warranty protection in exchange for a fee.

2. You may modify your copy or copies of the Library or any portion of it, thus forming a work based on the Library, and copy and distribute such modifications or work under the terms of Section 1 above, provided that you also meet all of these conditions:

- a) The modified work must itself be a software library.
- b) You must cause the files modified to carry prominent notices stating that you changed the files and the date of any change.
- c) You must cause the whole of the work to be licensed at no charge to all third parties under the terms of this License.
- d) If a facility in the modified Library refers to a function or a table of data to be supplied by an application program that uses the facility, other than as an argument passed when the facility is invoked, then you must make a good faith effort to ensure that, in the event an application does not supply such function or table, the facility still operates, and performs whatever part of its purpose remains meaningful.

(For example, a function in a library to compute square roots has a purpose that is entirely well-defined independent of the application. Therefore, Subsection 2d requires that any application-supplied function or table used by this function must be optional: if the application does not supply it, the square root function must still compute square roots.)

These requirements apply to the modified work as a whole. If identifiable sections of that work are not derived from the Library, and can be reasonably considered independent and separate works in themselves, then this License, and its terms, do not apply to those sections when you distribute them as separate works. But when you distribute the same sections as part of a whole which is a work based on the Library, the distribution of the whole must be on the terms of this License, whose permissions for other licensees extend to the entire whole, and thus to each and every part regardless of who wrote it.

Thus, it is not the intent of this section to claim rights or contest your rights to work written entirely by you; rather, the intent is to exercise the right to control the distribution of derivative or collective works based on the Library.

In addition, mere aggregation of another work not based on the Library with the Library (or with a work based on the Library) on a volume of a storage or distribution medium does not bring the other work under the scope of this License.

3. You may opt to apply the terms of the ordinary GNU General Public License instead of this License to a given copy of the Library. To do this, you must alter all the notices that refer to this License, so that they refer to the ordinary GNU General Public License, version 2, instead of to this License. (If a newer version than version 2 of the ordinary GNU General Public License has appeared, then you can specify that version instead if you wish.) Do not make any other change in these notices.

Once this change is made in a given copy, it is irreversible for that copy, so the ordinary GNU General Public License applies to all subsequent copies and derivative works made from that copy.

This option is useful when you wish to copy part of the code of the Library into a program that is not a library.

4. You may copy and distribute the Library (or a portion or derivative of it, under Section 2) in object code or executable form under the terms of Sections 1 and 2 above provided that you accompany it with the complete corresponding machine-readable source code, which must be distributed under the terms of Sections 1 and 2 above on a medium customarily used for software interchange.

If distribution of object code is made by offering access to copy from a designated place, then offering equivalent access to copy the source code from the same place satisfies the requirement to distribute the source code, even though third parties are not compelled to copy the source along with the object code.

5. A program that contains no derivative of any portion of the Library, but is designed to work with the Library by being compiled or linked with it, is called a "work that uses the Library". Such a work, in isolation, is not a derivative work of the Library, and therefore falls outside the scope of this License.

However, linking a "work that uses the Library" with the Library creates an executable that is a derivative of the Library (because it contains portions of the Library), rather than a "work that uses the library". The executable is therefore covered by this License. Section 6 states terms for distribution of such executables.

When a "work that uses the Library" uses material from a header file that is part of the Library, the object code for the work may be a derivative work of the Library even though the source code is not. Whether this is true is especially significant if the work can be linked without the Library, or if the work is itself a library. The threshold for this to be true is not precisely defined by law.

If such an object file uses only numerical parameters, data structure layouts and accessors, and small macros and small inline functions (ten lines or less in length), then the use of the object file is unrestricted, regardless of whether it is legally a derivative work. (Executables containing this object code plus portions of the Library will still fall under Section 6.)

Otherwise, if the work is a derivative of the Library, you may distribute the object code for the work under the terms of Section 6. Any executables containing that work also fall under Section 6, whether or not they are linked directly with the Library itself.

6. As an exception to the Sections above, you may also combine or link a "work that uses the Library" with the Library to produce a work containing portions of the Library, and distribute that work under terms of your choice, provided that the terms permit modification of the work for the customer's own use and reverse engineering for debugging such modifications.

You must give prominent notice with each copy of the work that the Library is used in it and that the Library and its use are covered by this License. You must supply a copy of this License. If the work during execution displays copyright notices, you must include the copyright notice for the Library among them, as well as a reference directing the user to the copy of this License. Also, you must do one of these things:

a) Accompany the work with the complete corresponding machine-readable source code for the Library including whatever changes were used in the work (which must be distributed under Sections 1 and 2 above); and, if the work is an executable linked with the Library, with the complete machine-readable "work that uses the Library", as object code and/or source code, so that the user can modify the Library and then relink to produce a modified executable containing the modified Library. (It is understood that the user who changes the contents of definitions files in the Library will not necessarily be able to recompile the application to use the modified definitions.)

b) Use a suitable shared library mechanism for linking with the Library. A suitable mechanism is one that (1) uses at run time a copy of the library already present on the user's computer system, rather than copying library functions into the executable, and (2) will operate properly with a modified version of the library, if the user installs one, as long as the modified version is interface-compatible with the version that the work was made with.

APPENDIX

- c) Accompany the work with a written offer, valid for at least three years, to give the same user the materials specified in Subsection 6a, above, for a charge no more than the cost of performing this distribution.
- d) If distribution of the work is made by offering access to copy from a designated place, offer equivalent access to copy the above specified materials from the same place.
- e) Verify that the user has already received a copy of these materials or that you have already sent this user a copy.

For an executable, the required form of the "work that uses the Library" must include any data and utility programs needed for reproducing the executable from it. However, as a special exception, the materials to be distributed need not include anything that is normally distributed (in either source or binary form) with the major components (compiler, kernel, and so on) of the operating system on which the executable runs, unless that component itself accompanies the executable.

It may happen that this requirement contradicts the license restrictions of other proprietary libraries that do not normally accompany the operating system. Such a contradiction means you cannot use both them and the Library together in an executable that you distribute.

7. You may place library facilities that are a work based on the Library side-by-side in a single library together with other library facilities not covered by this License, and distribute such a combined library, provided that the separate distribution of the work based on the Library and of the other library facilities is otherwise permitted, and provided that you do these two things:

- a) Accompany the combined library with a copy of the same work based on the Library, uncombined with any other library facilities. This must be distributed under the terms of the Sections above.
- b) Give prominent notice with the combined library of the fact that part of it is a work based on the Library, and explaining where to find the accompanying uncombined form of the same work.

8. You may not copy, modify, sublicense, link with, or distribute the Library except as expressly provided under this License. Any attempt otherwise to copy, modify, sublicense, link with, or distribute the Library is void, and will automatically terminate your rights under this License. However, parties who have received copies, or rights, from you under this License will not have their licenses terminated so long as such parties remain in full compliance.

9. You are not required to accept this License, since you have not signed it. However, nothing else grants you permission to modify or distribute the Library or its derivative works. These actions are prohibited by law if you do not accept this License. Therefore, by modifying or distributing the Library (or any work based on the Library), you indicate your acceptance of this License to do so, and all its terms and conditions for copying, distributing or modifying the Library or works based on it.

10. Each time you redistribute the Library (or any work based on the Library), the recipient automatically receives a license from the original licensor to copy, distribute, link with or modify the Library subject to these terms and conditions. You may not impose any further restrictions on the recipients' exercise of the rights granted herein. You are not responsible for enforcing compliance by third parties with this License.

11. If, as a consequence of a court judgment or allegation of patent infringement or for any other reason (not limited to patent issues), conditions are imposed on you (whether by court order, agreement or otherwise) that contradict the conditions of this License, they do not excuse you from the conditions of this License. If you cannot distribute so as to satisfy simultaneously your obligations under this License and any other pertinent obligations, then as a consequence you may not distribute the Library at all. For example, if a patent license would not permit royalty-free redistribution of the Library by all those who receive copies directly or indirectly through you, then the only way you could satisfy both it and this License would be to refrain entirely from distribution of the Library.

If any portion of this section is held invalid or unenforceable under any particular circumstance, the balance of the section is intended to apply, and the section as a whole is intended to apply in other circumstances.

It is not the purpose of this section to induce you to infringe any patents or other property right claims or to contest validity of any such claims; this section has the sole purpose of protecting the integrity of the free software distribution system which is implemented by public license practices. Many people have made generous contributions to the wide range of software distributed through that system in reliance on consistent application of that system; it is up to the author/donor to decide if he or she is willing to distribute software through any other system and a licensee cannot impose that choice.

This section is intended to make thoroughly clear what is believed to be a consequence of the rest of this License.

12. If the distribution and/or use of the Library is restricted in certain countries either by patents or by copyrighted interfaces, the original copyright holder who places the Library under this License may add an explicit geographical distribution limitation excluding those countries, so that distribution is permitted only in or among countries not thus excluded. In such case, this License incorporates the limitation as if written in the body of this License.

13. The Free Software Foundation may publish revised and/or new versions of the Lesser General Public License from time to time. Such new versions will be similar in spirit to the present version, but may differ in detail to address new problems or concerns.

Each version is given a distinguishing version number. If the Library specifies a version number of this License which applies to it and "any later version", you have the option of following the terms and conditions either of that version or of any later version published by the Free Software Foundation. If the Library does not specify a license version number, you may choose any version ever published by the Free Software Foundation.

14. If you wish to incorporate parts of the Library into other free programs whose distribution conditions are incompatible with these, write to the author to ask for permission. For software which is copyrighted by the Free Software Foundation, write to the Free Software Foundation; we sometimes make exceptions for this. Our decision will be guided by the two goals of preserving the free status of all derivatives of our free software and of promoting the sharing and reuse of software generally.

NO WARRANTY

15. BECAUSE THE LIBRARY IS LICENSED FREE OF CHARGE, THERE IS NO WARRANTY FOR THE LIBRARY, TO THE EXTENT PERMITTED BY APPLICABLE LAW. EXCEPT WHEN OTHERWISE STATED IN WRITING THE COPYRIGHT HOLDERS AND/OR OTHER PARTIES PROVIDE THE LIBRARY "AS IS" WITHOUT WARRANTY OF ANY KIND, EITHER EXPRESSED OR IMPLIED, INCLUDING, BUT NOT LIMITED TO, THE IMPLIED WARRANTIES OF MERCHANTABILITY AND FITNESS FOR A PARTICULAR PURPOSE. THE ENTIRE RISK AS TO THE QUALITY AND PERFORMANCE OF THE LIBRARY IS WITH YOU. SHOULD THE LIBRARY PROVE DEFECTIVE, YOU ASSUME THE COST OF ALL NECESSARY SERVICING, REPAIR OR CORRECTION.

16. IN NO EVENT UNLESS REQUIRED BY APPLICABLE LAW OR AGREED TO IN WRITING WILL ANY COPYRIGHT HOLDER, OR ANY OTHER PARTY WHO MAY MODIFY AND/OR REDISTRIBUTE THE LIBRARY AS PERMITTED ABOVE, BE LIABLE TO YOU FOR DAMAGES, INCLUDING ANY GENERAL, SPECIAL, INCIDENTAL OR CONSEQUENTIAL DAMAGES ARISING OUT OF THE USE OR INABILITY TO USE THE LIBRARY (INCLUDING BUT NOT LIMITED TO LOSS OF DATA OR DATA BEING RENDERED INACCURATE OR LOSSES SUSTAINED BY YOU OR THIRD PARTIES OR A FAILURE OF THE LIBRARY TO OPERATE WITH ANY OTHER SOFTWARE), EVEN IF SUCH HOLDER OR OTHER PARTY HAS BEEN ADVISED OF THE POSSIBILITY OF SUCH DAMAGES.

END OF TERMS AND CONDITIONS

How to Apply These Terms to Your New Libraries

If you develop a new library, and you want it to be of the greatest possible use to the public, we recommend making it free software that everyone can redistribute and change. You can do so by permitting redistribution under these terms (or, alternatively, under the terms of the ordinary General Public License).

To apply these terms, attach the following notices to the library. It is safest to attach them to the start of each source file to most effectively convey the exclusion of warranty; and each file should have at least the "copyright" line and a pointer to where the full notice is found.

```
<one line to give the library's name and a brief idea of what it does.>  
Copyright (C) <year> <name of author>
```

This library is free software; you can redistribute it and/or modify it under the terms of the GNU Lesser General Public License as published by the Free Software Foundation; either version 2.1 of the License, or (at your option) any later version.

This library is distributed in the hope that it will be useful, but WITHOUT ANY WARRANTY; without even the implied warranty of MERCHANTABILITY or FITNESS FOR A PARTICULAR PURPOSE. See the GNU Lesser General Public License for more details.

You should have received a copy of the GNU Lesser General Public License along with this library; if not, write to the Free Software Foundation, Inc., 51 Franklin Street, Fifth Floor, Boston, MA 02110-1301 USA

Also add information on how to contact you by electronic and paper mail.

You should also get your employer (if you work as a programmer) or your school, if any, to sign a "copyright disclaimer" for the library, if necessary. Here is a sample; alter the names:

Yoyodyne, Inc., hereby disclaims all copyright interest in the library `Frob' (a library for tweaking knobs) written by James Random Hacker.

```
<signature of Ty Coon>, 1 April 1990  
Ty Coon, President of Vice
```

APPENDIX

MOZILLA PUBLIC LICENSE

Version 1.1

1. Definitions.

1.0.1. "Commercial Use" means distribution or otherwise making the Covered Code available to a third party.

1.1. "Contributor" means each entity that creates or contributes to the creation of Modifications.

1.2. "Contributor Version" means the combination of the Original Code, prior Modifications used by a Contributor, and the Modifications made by that particular Contributor.

1.3. "Covered Code" means the Original Code or Modifications or the combination of the Original Code and Modifications, in each case including portions thereof.

1.4. "Electronic Distribution Mechanism" means a mechanism generally accepted in the software development community for the electronic transfer of data.

1.5. "Executable" means Covered Code in any form other than Source Code.

1.6. "Initial Developer" means the individual or entity identified as the Initial Developer in the Source Code notice required by Exhibit A.

1.7. "Larger Work" means a work which combines Covered Code or portions thereof with code not governed by the terms of this License.

1.8. "License" means this document.

1.8.1. "Licensable" means having the right to grant, to the maximum extent possible, whether at the time of the initial grant or subsequently acquired, any and all of the rights conveyed herein.

1.9. "Modifications" means any addition to or deletion from the substance or structure of either the Original Code or any previous Modifications. When Covered Code is released as a series of files, a Modification is:

A. Any addition to or deletion from the contents of a file containing Original Code or previous Modifications.

B. Any new file that contains any part of the Original Code or previous Modifications.

1.10. "Original Code" means Source Code of computer software code which is described in the Source Code notice required by Exhibit A as Original Code, and which, at the time of its release under this License is not already Covered Code governed by this License.

1.10.1. "Patent Claims" means any patent claim(s), now owned or hereafter acquired, including without limitation, method, process, and apparatus claims, in any patent Licensable by grantor.

1.11. "Source Code" means the preferred form of the Covered Code for making modifications to it, including all modules it contains, plus any associated interface definition files, scripts used to control compilation and installation of an Executable, or source code differential comparisons against either the Original Code or another well known, available Covered Code of the Contributor's choice. The Source Code can be in a compressed or archival form, provided the appropriate decompression or de-archiving software is widely available for no charge.

1.12. "You" (or "Your") means an individual or a legal entity exercising rights under, and complying with all of the terms of, this License or a future version of this License issued under Section 6.1.

For legal entities, "You" includes any entity which controls, is controlled by, or is under common control with You. For purposes of this definition, "control" means (a) the power, direct or indirect, to cause the direction or management of such entity, whether by contract or otherwise, or (b) ownership of more than fifty percent (50%) of the outstanding shares or beneficial ownership of such entity.

2. Source Code License.

2.1. The Initial Developer Grant.

The Initial Developer hereby grants You a world-wide, royalty-free, non-exclusive license, subject to third party intellectual property claims:

(a) under intellectual property rights (other than patent or trademark) Licensable by Initial Developer to use, reproduce, modify, display, perform, sublicense and distribute the Original Code (or portions thereof) with or without Modifications, and/or as part of a Larger Work; and

(b) under Patents Claims infringed by the making, using or selling of Original Code, to make, have made, use, practice, sell, and offer for sale, and/or otherwise dispose of the Original Code (or portions thereof).

(c) the licenses granted in this Section 2.1(a) and (b) are effective on the date Initial Developer first distributes Original Code under the terms of this License.

(d) Notwithstanding Section 2.1(b) above, no patent license is granted: 1) for code that You delete from the Original Code; 2) separate from the Original Code; or 3) for infringements caused by: i) the modification of the Original Code or ii) the combination of the Original Code with other software or devices.

2.2. Contributor Grant.

Subject to third party intellectual property claims, each Contributor hereby grants You a world-wide, royalty-free, non-exclusive license

(a) under intellectual property rights (other than patent or trademark) Licensable by Contributor, to use, reproduce, modify, display, perform, sublicense and distribute the Modifications created by such Contributor (or portions thereof) either on an unmodified basis, with other Modifications, as Covered Code and/or as part of a Larger Work; and

(b) under Patent Claims infringed by the making, using, or selling of Modifications made by that Contributor either alone and/or in combination with its Contributor Version (or portions of such combination), to make, use, sell, offer for sale, have made, and/or otherwise dispose of: 1) Modifications made by that Contributor (or portions thereof); and 2) the combination of Modifications made by that Contributor with its Contributor Version (or portions of such combination).

(c) the licenses granted in Sections 2.2(a) and 2.2(b) are effective on the date Contributor first makes Commercial Use of the Covered Code.

(d) Notwithstanding Section 2.2(b) above, no patent license is granted: 1) for any code that Contributor has deleted from the Contributor Version; 2) separate from the Contributor Version; 3) for infringements caused by: i) third party modifications of Contributor Version or ii) the combination of Modifications made by that Contributor with other software (except as part of the Contributor Version) or other devices; or 4) under Patent Claims infringed by Covered Code in the absence of Modifications made by that Contributor.

3. Distribution Obligations.

3.1. Application of License.

The Modifications which You create or to which You contribute are governed by the terms of this License, including without limitation Section 2.2. The Source Code version of Covered Code may be distributed only under the terms of this License or a future version of this License released under Section 6.1, and You must include a copy of this License with every copy of the Source Code You distribute. You may not offer or impose any terms on any Source Code version that alters or restricts the applicable version of this License or the recipients' rights hereunder. However, You may include an additional document offering the additional rights described in Section 3.5.

3.2. Availability of Source Code.

Any Modification which You create or to which You contribute must be made available in Source Code form under the terms of this License either on the same media as an Executable version or via an accepted Electronic Distribution Mechanism to anyone to whom you made an Executable version available; and if made available via Electronic Distribution Mechanism, must remain available for at least twelve (12) months after the date it initially became available, or at least six (6) months after a subsequent version of that particular Modification has been made available to such recipients. You are responsible for ensuring that the Source Code version remains available even if the Electronic Distribution Mechanism is maintained by a third party.

3.3. Description of Modifications.

You must cause all Covered Code to which You contribute to contain a file documenting the changes You made to create that Covered Code and the date of any change. You must include a prominent statement that the Modification is derived, directly or indirectly, from Original Code provided by the Initial Developer and including the name of the Initial Developer in (a) the Source Code, and (b) in any notice in an Executable version or related documentation in which You describe the origin or ownership of the Covered Code.

3.4. Intellectual Property Matters

(a) Third Party Claims.

If Contributor has knowledge that a license under a third party's intellectual property rights is required to exercise the rights granted by such Contributor under Sections 2.1 or 2.2, Contributor must include a text file with the Source Code distribution titled "LEGAL" which describes the claim and the party making the claim in sufficient detail that a recipient will know whom to contact. If Contributor obtains such knowledge after the Modification is made available as described in Section 3.2, Contributor shall promptly modify the LEGAL file in all copies Contributor makes available thereafter and shall take other steps (such as notifying appropriate mailing lists or newsgroups) reasonably calculated to inform those who received the Covered Code that new knowledge has been obtained.

APPENDIX

(b) Contributor APIs.

If Contributor's Modifications include an application programming interface and Contributor has knowledge of patent licenses which are reasonably necessary to implement that API, Contributor must also include this information in the LEGAL file.

(c) Representations.

Contributor represents that, except as disclosed pursuant to Section 3.4(a) above, Contributor believes that Contributor's Modifications are Contributor's original creation(s) and/or Contributor has sufficient rights to grant the rights conveyed by this License.

3.5. Required Notices.

You must duplicate the notice in Exhibit A in each file of the Source Code. If it is not possible to put such notice in a particular Source Code file due to its structure, then You must include such notice in a location (such as a relevant directory) where a user would be likely to look for such a notice. If You created one or more Modification(s) You may add your name as a Contributor to the notice described in Exhibit A. You must also duplicate this License in any documentation for the Source Code where You describe recipients' rights or ownership rights relating to Covered Code. You may choose to offer, and to charge a fee for, warranty, support, indemnity or liability obligations to one or more recipients of Covered Code. However, You may do so only on Your own behalf, and not on behalf of the Initial

Developer or any Contributor. You must make it absolutely clear than any such warranty, support, indemnity or liability obligation is offered by You alone, and You hereby agree to indemnify the Initial Developer and every Contributor for any liability incurred by the Initial Developer or such Contributor as a result of warranty, support, indemnity or liability terms You offer.

3.6. Distribution of Executable Versions.

You may distribute Covered Code in Executable form only if the requirements of Section 3.1-3.5 have been met for that Covered Code, and if You include a notice stating that the Source Code version of the Covered Code is available under the terms of this License, including a description of how and where You have fulfilled the obligations of Section 3.2. The notice must be conspicuously included in any notice in an Executable version, related documentation or collateral in which You describe recipients' rights relating to the Covered Code. You may distribute the Executable version of Covered Code or ownership rights under a license of Your choice, which may contain terms different from this License, provided that You are in compliance with the terms of this License and that the license for the Executable version does not attempt to limit or alter the recipient's rights in the Source Code version from the rights set forth in this

License. If You distribute the Executable version under a different license You must make it absolutely clear that any terms which differ from this License are offered by You alone, not by the Initial Developer or any Contributor. You hereby agree to indemnify the Initial Developer and every Contributor for any liability incurred by the Initial Developer or such Contributor as a result of any such terms You offer.

3.7. Larger Works.

You may create a Larger Work by combining Covered Code with other code not governed by the terms of this License and distribute the Larger Work as a single product. In such a case, You must make sure the requirements of this License are fulfilled for the Covered Code.

4. Inability to Comply Due to Statute or Regulation.

If it is impossible for You to comply with any of the terms of this License with respect to some or all of the Covered Code due to statute, judicial order, or regulation then You must: (a) comply with the terms of this License to the maximum extent possible; and (b) describe the limitations and the code they affect. Such description must be included in the LEGAL file described in Section 3.4 and must be included with all distributions of the Source Code. Except to the

extent prohibited by statute or regulation, such description must be sufficiently detailed for a recipient of ordinary skill to be able to understand it.

5. Application of this License.

This License applies to code to which the Initial Developer has attached the notice in Exhibit A and to related Covered Code.

6. Versions of the License.

6.1. New Versions.

Netscape Communications Corporation ("Netscape") may publish revised and/or new versions of the License from time to time. Each version will be given a distinguishing version number.

6.2. Effect of New Versions.

Once Covered Code has been published under a particular version of the License, You may always continue to use it under the terms of that version. You may also choose to use such Covered Code under the terms of any subsequent version of the License published by Netscape. No one other than Netscape has the right to modify the terms applicable to Covered Code created under this License.

6.3. Derivative Works.

If You create or use a modified version of this License (which you may only do in order to apply it to code which is not already Covered Code governed by this License), You must (a) rename Your license so that the phrases "Mozilla", "MOZILLAPL", "MOZPL", "Netscape", "MPL", "NPL" or any confusingly similar phrase do not appear in your license (except to note that your license differs from this License) and (b) otherwise make it clear that Your version of the license contains terms which differ from the Mozilla Public License and Netscape Public License. (Filling in the name of the Initial Developer, Original Code or Contributor in the notice described in Exhibit A shall not of themselves be deemed to be modifications of this License.)

7. DISCLAIMER OF WARRANTY.

COVERED CODE IS PROVIDED UNDER THIS LICENSE ON AN "AS IS" BASIS, WITHOUT WARRANTY OF ANY KIND, EITHER EXPRESSED OR IMPLIED, INCLUDING, WITHOUT LIMITATION, WARRANTIES THAT THE COVERED CODE IS FREE OF DEFECTS, MERCHANTABLE, FIT FOR A PARTICULAR PURPOSE OR NON-INFRINGEMENT. THE ENTIRE RISK AS TO THE QUALITY AND PERFORMANCE OF THE COVERED CODE IS WITH YOU. SHOULD ANY COVERED CODE PROVE DEFECTIVE IN ANY RESPECT, YOU (NOT THE INITIAL DEVELOPER OR ANY OTHER CONTRIBUTOR) ASSUME THE COST OF ANY NECESSARY SERVICING, REPAIR OR CORRECTION. THIS DISCLAIMER OF WARRANTY CONSTITUTES AN ESSENTIAL PART OF THIS LICENSE. NO USE OF ANY COVERED CODE IS AUTHORIZED HEREUNDER EXCEPT UNDER THIS DISCLAIMER.

8. TERMINATION.

8.1. This License and the rights granted hereunder will terminate automatically if You fail to comply with terms herein and fail to cure such breach within 30 days of becoming aware of the breach. All sublicenses to the Covered Code which are properly granted shall survive any termination of this License. Provisions which, by their nature, must remain in effect beyond the termination of this License shall survive.

8.2. If You initiate litigation by asserting a patent infringement claim (excluding declaratory judgment actions) against Initial Developer or a Contributor (the Initial Developer or Contributor against whom You file such action is referred to as "Participant") alleging that:

(a) such Participant's Contributor Version directly or indirectly infringes any patent, then any and all rights granted by such Participant to You under Sections 2.1 and/or 2.2 of this License shall, upon 60 days notice from Participant terminate prospectively, unless if within 60 days after receipt of notice You either: (i) agree in writing to pay Participant a mutually agreeable reasonable royalty for Your past and future use of Modifications made by such Participant, or (ii) withdraw Your litigation claim with respect to the Contributor Version against such Participant. If within 60 days of notice, a reasonable royalty and payment arrangement are not mutually agreed upon in writing by the parties or the litigation claim is not withdrawn, the rights granted by Participant to You under Sections 2.1 and/or 2.2 automatically terminate at the expiration of the 60 day notice period specified above.

(b) any software, hardware, or device, other than such Participant's Contributor Version, directly or indirectly infringes any patent, then any rights granted to You by such Participant under Sections 2.1(b) and 2.2(b) are revoked effective as of the date You first made, used, sold, distributed, or had made, Modifications made by that Participant.

8.3. If You assert a patent infringement claim against Participant alleging that such Participant's Contributor Version directly or indirectly infringes any patent where such claim is resolved (such as by license or settlement) prior to the initiation of patent infringement litigation, then the reasonable value of the licenses granted by such Participant under Sections 2.1 or 2.2 shall be taken into account in determining the amount or value of any payment or license.

8.4. In the event of termination under Sections 8.1 or 8.2 above, all end user license agreements (excluding distributors and resellers) which have been validly granted by You or any distributor hereunder prior to termination shall survive termination.

9. LIMITATION OF LIABILITY.

UNDER NO CIRCUMSTANCES AND UNDER NO LEGAL THEORY, WHETHER TORT (INCLUDING NEGLIGENCE), CONTRACT, OR OTHERWISE, SHALL YOU, THE INITIAL DEVELOPER, ANY OTHER CONTRIBUTOR, OR ANY DISTRIBUTOR OF COVERED CODE, OR ANY SUPPLIER OF ANY OF SUCH PARTIES, BE LIABLE TO ANY PERSON FOR ANY INDIRECT, SPECIAL, INCIDENTAL, OR CONSEQUENTIAL DAMAGES OF ANY CHARACTER INCLUDING, WITHOUT LIMITATION, DAMAGES FOR LOSS OF GOODWILL, WORK STOPPAGE, COMPUTER FAILURE OR MALFUNCTION, OR ANY AND ALL OTHER COMMERCIAL DAMAGES OR LOSSES, EVEN IF SUCH PARTY SHALL HAVE BEEN INFORMED OF THE POSSIBILITY OF SUCH DAMAGES. THIS LIMITATION OF LIABILITY SHALL NOT APPLY TO LIABILITY FOR DEATH OR PERSONAL INJURY RESULTING FROM SUCH PARTY'S NEGLIGENCE TO THE EXTENT APPLICABLE LAW PROHIBITS SUCH LIMITATION. SOME JURISDICTIONS DO NOT ALLOW THE EXCLUSION OR LIMITATION OF INCIDENTAL OR CONSEQUENTIAL DAMAGES, SO THIS EXCLUSION AND LIMITATION MAY NOT APPLY TO YOU.

APPENDIX

10. U.S. GOVERNMENT END USERS.

The Covered Code is a "commercial item," as that term is defined in 48 C.F.R. 2.101 (Oct. 1995), consisting of "commercial computer software" and "commercial computer software documentation," as such terms are used in 48 C.F.R. 12.212 (Sept. 1995). Consistent with 48 C.F.R. 12.212 and 48 C.F.R. 227.7202-1 through 227.7202-4 (June 1995), all U.S. Government End Users acquire Covered Code with only those rights set forth herein.

11. MISCELLANEOUS.

This License represents the complete agreement concerning subject matter hereof. If any provision of this License is held to be unenforceable, such provision shall be reformed only to the extent necessary to make it enforceable. This License shall be governed by California law provisions (except to the extent applicable law, if any, provides otherwise), excluding its conflict-of-law provisions. With respect to disputes in which at least one party is a citizen of, or an entity chartered or registered to do business in the United States of America, any litigation relating to this License shall be subject to the jurisdiction of the Federal Courts of the Northern District of California, with venue lying in Santa Clara County, California, with the losing party responsible for costs, including without limitation, court costs and reasonable attorneys' fees and expenses. The application of the United Nations Convention on Contracts for the International Sale of Goods is expressly excluded. Any law or regulation which provides that the language of a contract shall be construed against the drafter shall not apply to this License.

12. RESPONSIBILITY FOR CLAIMS.

As between Initial Developer and the Contributors, each party is responsible for claims and damages arising, directly or indirectly, out of its utilization of rights under this License and You agree to work with Initial Developer and Contributors to distribute such responsibility on an equitable basis. Nothing herein is intended or shall be deemed to constitute any admission of liability.

13. MULTIPLE-LICENSED CODE.

Initial Developer may designate portions of the Covered Code as "Multiple-Licensed". "Multiple-Licensed" means that the Initial Developer permits you to utilize portions of the Covered Code under Your choice of the NPL or the alternative licenses, if any, specified by the Initial Developer in the file described in Exhibit A.

EXHIBIT A -Mozilla Public License.

``The contents of this file are subject to the Mozilla Public License Version 1.1 (the "License"); you may not use this file except in compliance with the License. You may obtain a copy of the License at <http://www.mozilla.org/MPL/>

Software distributed under the License is distributed on an "AS IS" basis, WITHOUT WARRANTY OF ANY KIND, either express or implied. See the License for the specific language governing rights and limitations under the License.

The Original Code is _____.

The Initial Developer of the Original Code is _____.

Portions created by _____ are Copyright (C) _____
_____. All Rights Reserved.

Contributor(s): _____.

Alternatively, the contents of this file may be used under the terms of the _____ license (the "[] License"), in which case the provisions of [] License are applicable instead of those above. If you wish to allow use of your version of this file only under the terms of the [] License and not to allow others to use your version of this file under the MPL, indicate your decision by deleting the provisions above and replace them with the notice and other provisions required by the [] License. If you do not delete the provisions above, a recipient may use your version of this file under either the MPL or the [] License."

[NOTE: The text of this Exhibit A may differ slightly from the text of the notices in the Source Code files of the Original Code. You should use the text of this Exhibit A rather than the text found in the Original Code Source Code for Your Modifications.]



Record the model number and serial number of the TV.

Refer to the label on the back cover and quote this information to your dealer when requiring any service.

Model : _____

Serial No. : _____

(Only DTV)



**Digital Video
Broadcasting**

Trade Mark of the DVB Digital Video
Broadcasting Project (1991 to 1996)